

ASM HANDBOOK

VOLUME

3

*Alloy Phase
Diagrams*



Alloy Phase Diagrams was published in 1992 as Volume 3 of the *ASM Handbook*. The Volume was prepared under the direction of the ASM International Alloy Phase Diagram and the Handbook Committees.

Foreword

Phase diagrams, thermodynamic data in graphical form, are one of the basic tools of the metallurgist, materials scientist, and materials engineer. They can be used for alloy design, selection of hot-working and fabricating parameters, prediction of performance, guidance in selection of hot-working and fabricating parameters, prediction of performance, guidance in selection of heat-treating process parameters, solving performance problems, including failure analysis, and for many other purposes.

The formation of The American Society of Steel Treating, the forerunner of ASM International, was based on better understanding of heat-treating technology; this understanding was, of course, rooted in part in the proper utilization of phase diagrams. Experimental tools such as metallography were used in those early days, both to determine phase diagrams and to link the heat-treating process with the desired microstructure.

In 1978 ASM International joined with the National Bureau of Standards (now the National Institute of Standards of Technology, or NIST) in an effort to improve the reliability of phase diagrams by evaluating the existing data on a system-by-system basis. ASM raised \$4 million from industry and government sources and NIST provided a similar amount of financial and in-kind support for this historic undertaking. An international effort was mounted simultaneously with similar objectives. As a result, all of the important binary systems have been evaluated, and international partners have evaluated more than 2000 ternary systems.

ASM actively participates in the Alloy Phase Diagram International Commission (APDIC), which comprises cooperative national or regional committees in 13 countries. APDIC was formed "to set overall objectives, determine priorities for alloy systems to be assessed, coordinate the assessment programs of APDIC members and associate members, establish scope and quality standards for assessment programs in other countries, and assist in the timely dissemination of the resultant phase diagram data."

The complete results of the international effort are recorded in various periodical and reference publications. However, we have continued to hear from ASM members that a summary version consisting primarily of phase diagrams should be published as an ASM Handbook for the practicing engineer. While such a Handbook could not contain all the diagrams and data, careful selection would ensure the inclusion of the most important systems, with references to other more complete sources. The present Handbook is the result of our attempts to meet these criteria and the stated need.

No reference book of this nature could be published without the contributions of literally hundreds of technical and staff workers. On behalf of ASM International, we extend our sincere thanks and appreciation to the category editors, contributors, reviewers, and staff who worked in this international effort. Thanks are also due to the ASM Alloy Phase Diagram and Handbook Committees for their guidance and support of the project.

- Edward H. Kottcamp, Jr.
President
ASM International
- Edward L. Langer
Managing Director
ASM International

Preface

Alloy phase diagrams have long been used successfully by the scientific, engineering, and industrial communities as "road maps" to solve a variety of practical problems. It is, thus, not surprising that such diagrams have always been an important part of ASM Handbooks. The previous ASM compilation of commercially important diagrams appeared in Volume 8 of the 8th Edition of *Metals Handbook*.

Shortly after publication of the earlier volume in 1973, recognition of the universal importance of alloy phase diagrams led to the formation of several national phase diagram programs, as well as the International Programme for Alloy Phase Diagrams to act as the coordinating body for these activities. In the U. S., the national program has been spearheaded jointly by ASM International and the National Institute of Standards and Technology.

To meet the pressing need for diagrams, the national programs and the entire International Programme had two main goals: to increase the availability of phase diagrams and to ensure that the diagrams made available were of the highest possible quality. The specific tasks that were undertaken to accomplish these goals included assembling *all* existing data related to alloy phase diagrams, critically evaluating these data, using the data to construct the most up-to-date and accurate diagrams possible, and making the resulting diagrams readily available for use.

With the publication of the three-volume set of *Binary Alloy Phase Diagrams*, Second Edition, by ASM in 1991, the binary alloy portion of this monumental task is virtually complete. In addition, the first-ever truly comprehensive collection of ternary diagrams, the multivolume *Handbook of Ternary Alloy Phase Diagrams*, is scheduled for publication by ASM in 1994. Information from these two extensive and current diagram sources have been used as the basis of this updated engineering reference book, which reproduces the diagrams of the most commercially important systems (1046 binaries plus 80 ternaries) in a single, convenient volume. These alloy systems are represented by more than 1100 binary diagrams and 313 ternary diagrams, all plotted in weight percent as the primary scale.

The binary diagrams reproduced in this Handbook were selected from the 2965 systems covered in *Binary Alloy Phase Diagrams*, with updated diagrams from literature published since January 1991. Included with the binary diagrams is a complete index of all known alloy phase diagrams from *all* sources, listing where each can be found should a problem arise concerning a binary system not covered in this Handbook. Although many of the diagrams listed in this index (and a few of those reproduced in this volume) have not been evaluated under the Programme, they were selected to represent the best available. Updated binary diagrams from the phase diagram update section of the *Journal of Phase Equilibria* and abstracts of new full-length evaluation from the *Journal of Phase Equilibria* and the Monograph Series on Alloy Phase Diagrams are available from ASM International on a continuing basis through the Binary Alloy Phase Diagrams Updating Service.

The ternary diagrams reproduced here were selected from more than 12,000 diagrams being assembled for the ternary handbook. Where available, diagrams from recently published evaluated compilations were selected. The remainder were selected to represent the best available.

To aid in the full and effective use of these diagrams to solve practical problems, we have included an Introduction to Alloy Phase Diagrams, which contains sections on the theory and use of phase diagrams, and an Appendix listing the relevant properties of the elements and their crystal structures.

While the work of developing additional data, expanding alloy system coverage, and refining existing diagrams must and will continue, the quality checks built into the programme ensure that the diagrams reproduced here are as accurate and reliable as possible. Credit for this belongs to the conscientious work of all the experts involved in the worldwide Programme, especially Prof. Thaddeus B. Massalski and Dr. Alan A. Prince, who coordinated the evaluation efforts during the period of greatest activity.

The Editors

General Information

Officers and Trustees of ASM International

Officers

- **LAMET** UFRGS
- **Edward H. Kottcamp, Jr.** President and Trustee SPS Technologies
- **John G. Simon** Vice President and Trustee General Motors Corporation
- **William P. Koster** Immediate Past President Metcut Research Associates, Inc.
- **Edward L. Langer** Secretary and Managing Director ASM International

- **Leo G. Thompson** Treasurer Lindberg Corporation

Trustees

- **William H. Erickson** Canada Centre for Minerals & Energy
- **Norman A. Gjostein** Ford Motor Company
- **Nicholas C. Jessen, Jr.** Martin Marietta Energy Systems, Inc.
- **E. George Kendall** Northrop Aircraft
- **George Krauss** Colorado School of Mines
- **Gernant E. Maurer** Special Metals Corporation
- **Alton D. Romig, Jr.** Sandia National Laboratories
- **Lyle H. Schwartz** National Institute of Standards & Technology (NIST)
- **Merle L. Thorpe** Hobart Tafa Technologies, Inc.

Members of the ASM Alloy Phase Diagram Committee (1991-1992)

- **Michael R. Notis** (Chairman 1991-; Member 1988-) Lehigh University
- **James Brown** (1990-) Ontario Hydro
- **Cathleen M. Cotell** (1991-) Naval Research Labs
- **Charles E. Ells** (1991-) Atomic Energy of Canada, Ltd.
- **Gretchen Kalonji** (1991-) University of Washington
- **Marc H. LaBranche** (1991-) DuPont
- **Vincent C. Marcotte** (1987-) IBM East Fishkill Facility
- **T.B. Massalski** (1987-) Carnegie-Mellon University
- **Sailesh M. Merchant** (1990-) AT&T Bell Labs
- **John E. Morral** (1990-) University of Connecticut
- **Charles A. Parker** (1987-) Allied Signal Research & Technology
- **Alan Prince** (1987-) Consultant
- **Gaylord D. Smith** (1987-) Inco Alloys International Inc.
- **Michael S. Zedalis** (1991-) Allied Signal, Inc.

Members of the ASM Handbook Committee (1992-1993)

- **Roger J. Austin** (Chairman 1992-; Member 1984-) Hydro-Lift
- **David V. Neff** (Vice-Chairman 1992-; Member 1986-) Metallurgical System
- **Ted Anderson** (1991-) Texas A&M University
- **Bruce Bardes** (1992-) GE Aircraft Engines
- **Robert J. Barnhurst** (1988-) Noranda Technology Centre
- **Toni Brugger** (1992-) Phoenix Pipe & Tube Co.
- **Stephen J. Burden** (1989-) GTE Valenite
- **Craig V. Darragh** (1989-) The Timken Company
- **Russell J. Diefendorf** (1990-) Clemson University
- **Aicha Elshabini-Riad** (1990-) Virginia Polytechnic & State University
- **Gregory A. Fett** (1992-) Dana Corporation
- **Michelle M. Gauthier** Raytheon Company
- **Toni Grobstein** (1990-) NASA Lewis Research Center
- **Susan Housh** (1990-) Dow Chemical U.S.A.
- **Dennis D. Huffman** (1982-) The Timken Company
- **S. Jim Ibarra** (1991-) Amoco Research Center
- **J. Ernesto Indacochea** (1987-) University of Illinois at Chicago
- **Peter W. Lee** (1990-) The Timken Company
- **William L. Mankins** (1989-) Inco Alloys International, Inc.

- **Richard E. Robertson** (1990-) University of Michigan
- **Jogender Singh** (1992-) NASA
- **Jeremy C. St. Pierre** (1990-) Hayes Heat Treating Corporation
- **Ephraim Suhir** (1990-) AT&T Bell Laboratories
- **Kenneth B. Tator** (1991-) KTA-Tator, Inc.
- **Malcolm Thomas** (1992-) General Motors Corp.
- **William B. Young** (1991-) Dana Corporation

Staff

ASM International staff who contributed to the development of the Volume included Hugh Baker, Editor; Hiroaki Okamoto, Senior Technical Editor; Scott D. Henry, Manager of Handbook Development; Grace M. Davidson, Manager, Production Systems; Mary Anne Fleming, Manager, APD Publications; Linda Kacprzak, Manager of Production; Heather F. Lampman, Editorial/Production Assistant; William W. Scott, Jr., Technical Director; Robert C. Uhl, Director of Reference Publications. Editorial Assistance was provided by Nikki D. Wheaton and Kathleen Mills. Production Assistance was provided by Donna Sue Plickert, Steve Starr, Karen Skiba, Patricia Eland, and Jeff Fenstermaker.

Conversion to Electronic Files

ASM Handbook, Volume 3, *Alloy Phase Diagrams* was converted to electronic files in 1998. The conversion was based on the First Printing (1992). No substantive changes were made to the content of the Volume, but some minor corrections and clarifications were made as needed.

ASM International staff who contributed to the conversion of the Volume included Sally Fahrenholz-Mann, Bonnie Sanders, Marlene Seuffert, Scott Henry, and Robert Braddock. The electronic version was prepared under the direction of William W. Scott, Jr., Technical Director, and Michael J. DeHaemer, Managing Director.

Copyright Information (for Print Volume)

Copyright © 1992 by ASM International

All rights reserved

No part of this book may be reproduced, stored in a retrieval system, or transmitted, in any form or by any means, electronic, mechanical, photocopying, recording, or otherwise, without the written permission of the copyright owner.

ASM Handbook is a collective effort involving thousands of technical specialists. It brings together in one book a wealth of information from world-wide sources to help scientists, engineers, and technicians solve current and long-range problems.

Great care is taken in the compilation and production of this Volume, but it should be made clear that NO WARRANTIES, EXPRESS OR IMPLIED, INCLUDING, WITHOUT LIMITATION, WARRANTIES OF MERCHANTABILITY OR FITNESS FOR A PARTICULAR PURPOSE, ARE GIVEN IN CONNECTION WITH THIS PUBLICATION. Although this information is believed to be accurate by ASM, ASM cannot guarantee that favorable results will be obtained from the use of this publication alone. This publication is intended for use by persons having technical skill, at their sole discretion and risk. Since the conditions of product or material use are outside of ASM's control, ASM assumes no liability or obligation in connection with any use of this information. No claim of any kind, whether as to products or information in this publication, and whether or not based on negligence, shall be greater in amount than the purchase price of this product or publication in respect of which damages are claimed. THE REMEDY HEREBY PROVIDED SHALL BE THE EXCLUSIVE AND SOLE REMEDY OR BUYER, AND IN NO EVENT SHALL EITHER PARTY BE LIABLE FOR SPECIAL, INDIRECT OR CONSEQUENTIAL DAMAGES WHETHER OR NOT CAUSED BY OR RESULTING FROM THE NEGLIGENCE OF SUCH PARTY. As with any material, evaluation of the material under end-use conditions prior to specification is essential. Therefore, specific testing under actual conditions is recommended.

Nothing contained in this book shall be construed as a grant of any right of manufacture, sale, use, or reproduction, in connection with any method, process, apparatus, product, composition, or system, whether or not covered by letters

patent, copyright, or trademark, and nothing contained in this book shall be construed as a defense against any alleged infringement of letters patent, copyright, or trademark, or as a defense against liability for such infringement.

Comments, criticisms, and suggestions are invited, and should be forwarded to ASM International.

Library of Congress Cataloging-in-Publication Data (for Print Volume)

ASM handbook.

(Revised for vol. 3)

Vols. 1-2 have title: Metals handbook. Includes biographical references and indexes. Contents: v. 1. Properties and selection--irons, steels, and high-performance alloys--v. 2. Properties and selection--nonferrous alloys and special-purpose--v. 3. Alloy phase diagrams

1. Metals--Handbooks, manuals, etc.

I. ASM International. Handbook Committee

II. Metals handbook.

TA459.M43 1990 620.1'6 90-115

ISBN: 0-87170-377-7 (v.1) 0-87170-381-5 (v.3)

SAN: 204-7586

Printed in the United States of America

Introduction to Alloy Phase Diagrams

Hugh Baker, Editor

Introduction

ALLOY PHASE DIAGRAMS are useful to metallurgists, materials engineers, and materials scientists in four major areas: (1) development of new alloys for specific applications, (2) fabrication of these alloys into useful configurations, (3) design and control of heat treatment procedures for specific alloys that will produce the required mechanical, physical, and chemical properties, and (4) solving problems that arise with specific alloys in their performance in commercial applications, thus improving product predictability. In all these areas, the use of phase diagrams allows research, development, and production to be done more efficiently and cost effectively.

In the area of alloy development, phase diagrams have proved invaluable for tailoring existing alloys to avoid overdesign in current applications, designing improved alloys for existing and new applications, designing special alloys for special applications, and developing alternative alloys or alloys with substitute alloying elements to replace those containing scarce, expensive, hazardous, or "critical" alloying elements. Application of alloy phase diagrams in processing includes their use to select proper parameters for working ingots, blooms, and billets, finding causes and cures for microporosity and cracks in castings and welds, controlling solution heat treating to prevent damage caused by incipient melting, and developing new processing technology.

In the area of performance, phase diagrams give an indication of which phases are thermodynamically stable in an alloy and can be expected to be present over a long time when the part is subjected to a particular temperature (e.g., in an automotive exhaust system). Phase diagrams also are consulted when attacking service problems such as pitting and intergranular corrosion, hydrogen damage, and hot corrosion.

In a majority of the more widely used commercial alloys, the allowable composition range encompasses only a small portion of the relevant phase diagram. The nonequilibrium conditions that are usually encountered in practice, however, necessitate the knowledge of a much greater portion of the diagram. Therefore, a thorough understanding of alloy phase diagrams in general and their practical use will prove to be of great help to a metallurgist expected to solve problems in any of the areas mentioned above.

Common Terms

Before the subject of alloy phase diagrams is discussed in detail, several of the commonly used terms will be discussed.

Phases. All materials exist in gaseous liquid, or solid form (usually referred to as a *phase*), depending on the conditions of state. *State variables* include composition, temperature, pressure, magnetic field, electrostatic field, gravitational field, and so on. The term "phase" refers to that region of space occupied by a physically homogeneous material. However, there are two uses of the term: the strict sense normally used by physical scientists and the somewhat looser sense normally used by materials engineers.

In the strictest sense, homogeneous means that the physical properties throughout the region of space occupied by the phase are absolutely identical, and any change in condition of state, no matter how small, will result in a different phase. For example, a sample of solid metal with an apparently homogeneous appearance is not truly a single-phase material, because the pressure condition varies in the sample due to its own weight in the gravitational field.

In a phase diagram, however, each single-phase field (phase fields are discussed in a following section) is usually given a single label, and engineers often find it convenient to use this label to refer to all the materials lying within the field, regardless of how much the physical properties of the materials continuously change from one part of the field to another. This means that in engineering practice, the distinction between the terms "phase" and "phase field" is seldom made, and all materials having the same phase name are referred to as the same phase.

Equilibrium. There are three types of equilibria: stable, metastable, and unstable. These three conditions are illustrated in a mechanical sense in Fig. 1. Stable equilibrium exists when the object is in its lowest energy condition; metastable equilibrium exists when additional energy must be introduced before the object can reach true stability; unstable equilibrium exists when no additional energy is needed before reaching metastability or stability. Although true stable equilibrium conditions seldom exist in metal objects, the study of equilibrium systems is extremely valuable, because it constitutes a limiting condition from which actual conditions can be estimated.

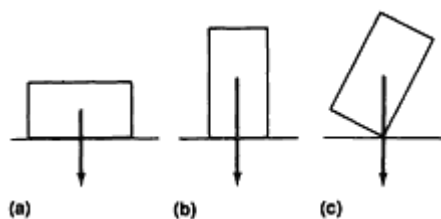

Fig. 1 Mechanical equilibria: (a) Stable. (b) Metastable. (c) Unstable

Polymorphism. The structure of solid elements and compounds under stable equilibrium conditions is crystalline, and the crystal structure of each is unique. Some elements and compounds, however, are *polymorphic* (multishaped); that is, their structure transforms from one crystal structure to another with changes in temperature and pressure, each unique structure constituting a distinctively separate phase. The term *allotropy* (existing in another form) is usually used to describe polymorphic changes in chemical elements. Crystal structure of metals and alloys is discussed in a later section of this Introduction; the allotropic transformations of the elements are listed in the Appendix to this Volume.

Metastable Phases. Under some conditions, metastable crystal structures can form instead of stable structures. Rapid freezing is a common method of producing metastable structures, but some (such as Fe_3C , or "cementite") are produced at moderately slow cooling rates. With extremely rapid freezing, even thermodynamically unstable structures (such as amorphous metal "glasses") can be produced.

Systems. A physical *system* consists of a substance (or a group of substances) that is isolated from its surroundings, a concept used to facilitate study of the effects of conditions of state. "Isolated" means that there is no interchange of mass between the substance and its surroundings. The substances in alloy systems, for example, might be two metals, such as copper and zinc; a metal and a nonmetal, such as iron and carbon; a metal and an intermetallic compound, such as iron and cementite; or several metals, such as aluminum, magnesium, and manganese. These substances constitute the *components* comprising the system and should not be confused with the various phases found within the system. A system, however, also can consist of a single component, such as an element or compound.

Phase Diagrams. In order to record and visualize the results of studying the effects of state variables on a system, diagrams were devised to show the relationships between the various phases that appear within the system under equilibrium conditions. As such, the diagrams are variously called *constitutional diagrams*, *equilibrium diagrams*, or *phase diagrams*. A single-component phase diagram can be simply a one- or two-dimensional plot showing the phase changes in the substance as temperature and/or pressure change. Most diagrams, however, are two- or three-dimensional plots describing the phase relationships in systems made up of two or more components, and these usually contain fields (areas) consisting of mixed-phase fields, as well as single-phase fields. The plotting schemes in common use are described in greater detail in subsequent sections of this Introduction.

System Components. Phase diagrams and the systems they describe are often classified and named for the number (in Latin) of components in the system:

Number of components	Name of system or diagram
One	Unary
Two	Binary
Three	Ternary
Four	Quaternary
Five	Quinary
Six	Sexinary
Seven	Septenary
Eight	Octanary
Nine	Nonary
Ten	Decinary

Phase Rule. The *phase rule*, first announced by J. William Gibbs in 1876, related the physical state of a mixture to the number of constituents in the system and to its conditions. It was also Gibbs who first called each homogeneous region in a system by the term "phase." When pressure and temperature are the state variables, the rule can be written as follows:

$$f = c - p + 2$$

where f is the number of independent variables (called *degrees of freedom*), c is the number of components, and p is the number of stable phases in the system.

Unary Diagrams

Invariant Equilibrium. According to the phase rule, three phases can exist in stable equilibrium only at a single point on a unary diagram ($f = 1 - 3 + 2 = 0$). This limitation is illustrated as point O in the hypothetical unary pressure-temperature (PT) diagram shown in Fig. 2. In this diagram, the three states (or phases)--solid, liquid, and gas--are represented by the three correspondingly labeled fields. Stable equilibrium between any two phases occurs along their mutual boundary, and *invariant equilibrium* among all three phases occurs at the so-called *triple point*, O , where the three boundaries intersect. This point also is called an *invariant point* because, at that location on the diagram, all externally controllable factors are fixed (no degrees of freedom). At this point, all three states (phases) are in equilibrium, but any changes in pressure and/or temperature will cause one or two of the states (phases) to disappear.

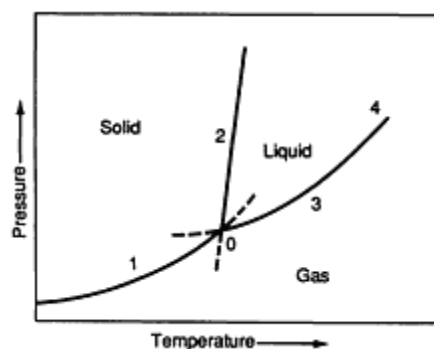

Fig. 2 Schematic pressure-temperature phase diagram

Univariant Equilibrium The phase rule says that stable equilibrium between two phases in a unary system allows one degree of freedom ($f = 1 - 2 + 2$). This condition, called *univariant equilibrium* or *monovariant equilibrium*, is illustrated as line 1, 2, and 3 separating the single-phase fields in Fig. 2. Either pressure or temperature may be freely selected, but not both. Once a pressure is selected, there is only one temperature that will satisfy equilibrium conditions, and conversely. The three curves that issue from the triple point are called *triple curves*: line 1, representing the reaction between the solid and the gas phases, is the *sublimation curve*; line 2 is the *melting curve*; and line 3 is the *vaporization curve*. The vaporization curve ends at point 4, called a *critical point*, where the physical distinction between the liquid and gas phase disappears.

Bivariant Equilibrium. If both the pressure and temperature in a unary system are freely and arbitrarily selected, the situation corresponds to having two degrees of freedom, and the phase rule says that only one phase can exist in stable equilibrium ($p = 1 - 2 + 2$). This situation is called *bivariant equilibrium*.

Binary Diagrams

If the system being considered comprises two components, a composition axis must be added to the PT plot, requiring construction of a three-dimensional graph. Most metallurgical problems, however, are concerned only with a fixed pressure of one atmosphere, and the graph reduces to a two-dimensional plot of temperature and composition (TX diagram).

The Gibbs phase rule applies to all states of matter (solid, liquid, and gaseous), but when the effect of pressure is constant, the rule reduces to:

$$f = c - p + 1$$

The stable equilibria for binary systems are summarized as follows:

Number of components	Number of phases	Degrees of freedom	Equilibrium
2	3	0	Invariant
2	2	1	Univariant
2	1	2	Bivariant

Miscible Solids. Many systems are comprised of components having the same crystal structure, and the components of some of these systems are completely miscible (completely soluble in each other) in the solid form, thus forming a *continuous solid solution*. When this occurs in a binary system, the phase diagram usually has the general appearance of that shown in Fig. 3. The diagram consists of two single-phase fields separated by a two-phase field. The boundary between the liquid field and the two-phase field in Fig. 3 is called the *liquidus*; that between the two-phase field and the solid field is the *solidus*. In general, a liquidus is the locus of points in a phase diagram representing the temperatures at which alloys of the various compositing of the system begin to freeze on cooling or finish melting on heating; a solidus is the locus of points representing the temperatures at which the various alloys finish freezing on cooling or begin melting on heating. The phases in equilibrium across the two-phase field in Fig. 3 (the liquid and solid solutions) are called *conjugate phases*.

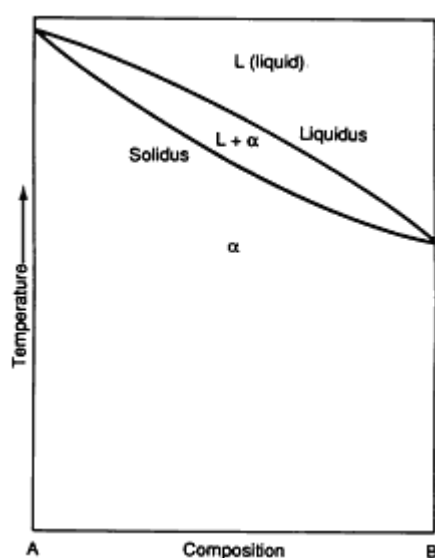

Fig. 3 Schematic binary phase diagram showing miscibility in both the liquid and solid states

If the solidus and liquids meet tangentially at some point, a maximum or minimum is produced in the two-phase field, splitting it into two portions as shown in Fig. 4. It also is possible to have a gap in miscibility in a single-phase field; this is shown in Fig. 5. Point T_c , above which phases α_1 and α_2 become indistinguishable, is a critical point similar to point 4 in Fig. 2. Lines $a-T_c$ and $b-T_c$, called *solvus* lines, indicate the limits of solubility of component B in A and A in B, respectively. The configurations of these and all other phase diagrams depend on the thermodynamics of the system, as discussed later in this Introduction.

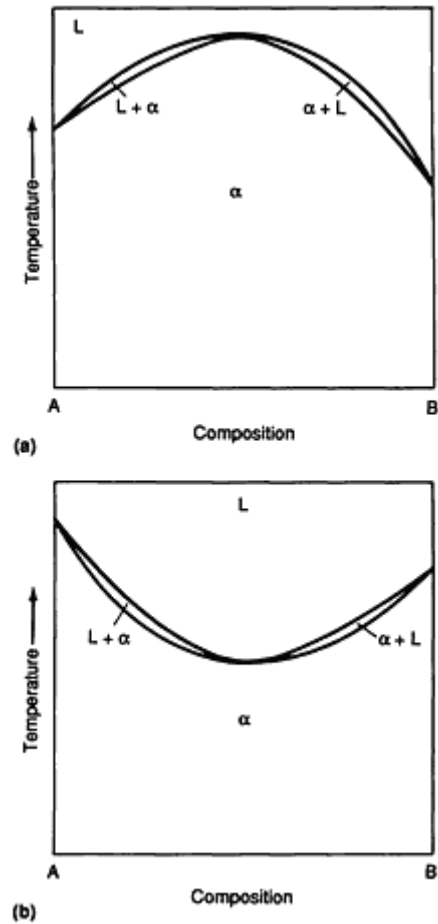

Fig. 4 Schematic binary phase diagrams with solid-state miscibility where the liquidus shows a maximum (a) and a minimum (b)

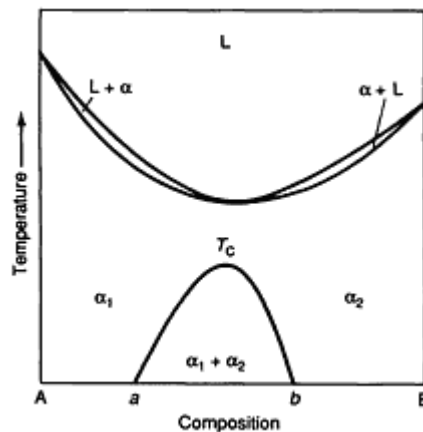

Fig. 5 Schematic binary phase diagram with a minimum in the liquidus and a miscibility gap in the solid state

Eutectic Reactions. If the two-phase field in the solid region of Fig. 5 is expanded so that it touches the solidus at some point, as shown in Fig. 6(a), complete miscibility of the components is lost. Instead of a single solid phase, the diagram now shows two separate solid *terminal phases*, which are in three-phase equilibrium with the liquid at point *P*, an invariant point that occurred by coincidence. (Three-phase equilibrium is discussed in the following section.) Then, if this two-phase field in the solid region is even further widened so that the solvus lines no longer touch at the invariant point, the diagram passes through a series of configurations, finally taking on the more familiar shape shown in Fig. 6(b). The three-phase reaction that takes place at the invariant point *E*, where a liquid phases, freezes into a mixture of two solid phases, is called a *eutectic reaction* (from the Greek word for "easily melted"). The alloy that corresponds to the eutectic composition is called a *eutectic alloy*. An alloy having a composition to the left of the eutectic point is called a *hypoeutectic alloy* (from the Greek word for "less than"); an alloy to the right is a *hypereutectic alloy* (meaning "greater than").

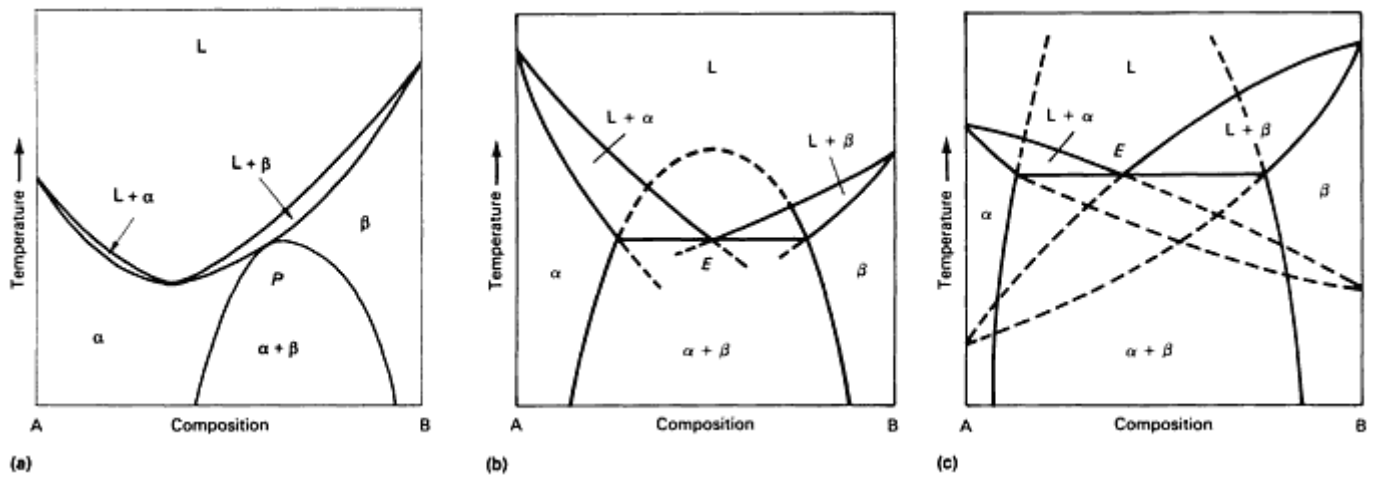

Fig. 6 Schematic binary phase diagrams with invariant points. (a) Hypothetical diagram of the type shown in Fig. 5, except that the miscibility gap in the solid touches the solidus curve at invariant point *P*; an actual diagram of this type probably does not exist. (b) and (c) Typical eutectic diagrams for components having the same crystal structure (b) and components having different crystal structures (c); the eutectic (invariant) points are labeled *E*. The dashed lines in (b) and (c) are metastable extensions of the stable-equilibria lines.

In the eutectic system described above, the two components of the system have the same crystal structure. This, and other factors, allows complete miscibility between them. Eutectic systems, however, also can be formed by two components having different crystal structures. When this occurs, the liquidus and solidus curves (and their extensions into the two-phase field) for each of the terminal phases (see Fig. 6c) resemble those for the situation of complete miscibility between system components shown in Fig. 3.

Three-Phase Equilibrium. Reactions involving three conjugate phases are not limited to the eutectic reaction. For example, upon cooling, a single solid phase can change into a mixture of two new solid phases or, conversely, two solid phases can react to form a single new phase. These and the other various types of invariant reactions observed in binary systems are listed in Table 1 and illustrated in Fig. 7 and 8.

Table 1 Invariant reactions

Type	Reaction
Eutectic (involves liquid and solid)	$L_1 \rightarrow L_1 \vee S$ Monotectic
	$S_1 \rightarrow L \vee S_2$ Eutectic
	$L \rightarrow S_1 \vee S_2$ Catatetic (Metatetic)
Eutectoid (involves solid only)	$S_1 \rightarrow S_1 \vee S_2$ Monotectoid
	$S_1 \rightarrow S_1 \vee S_2$ Eutectoid
Peritectic (involves liquid and solid)	$L_1 \rightarrow L_2 \wedge S$ Syntectic
	$L \rightarrow L_2 \wedge S_1$ Peritectic
Peritectoid (involves solid only)	$S_1 \rightarrow S_2 \wedge S_2$ Peritectoid

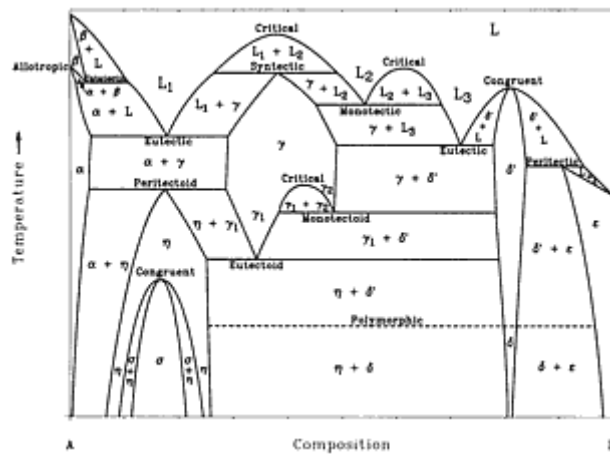

Fig. 7 Hypothetical binary phase diagram showing intermediate phases formed by various invariant reactions and a polymorphic transformation

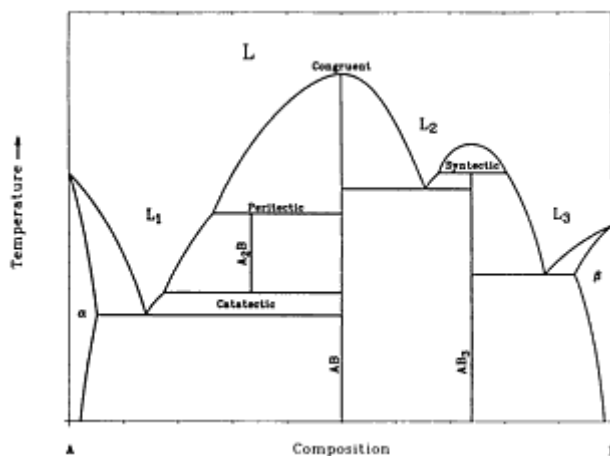

Fig. 8 Hypothetical binary phase diagram showing three intermetallic line compounds and four melting reactions

Intermediate Phases. In addition to the three solid terminal-phase fields, α , β , and ϵ , the diagram in Fig. 7 displays five other solid-phase fields, γ , δ , δ' , η , and σ , at intermediate compositions. Such phases are called *intermediate phases*. Many intermediate phases, such as those illustrated in Fig. 7, have fairly wide ranges of homogeneity. However, many others have very limited or no significant homogeneity range.

When an intermediate phase of limited (or no) homogeneity range is located at or near a specific ratio of component elements that reflects the normal positioning of the component atoms in the crystal structure of the phase, it is often called a compound (or *line compound*). When the components of the system are metallic, such an intermediate phase is often called an *intermetallic compound*. (Intermetallic compounds should not be confused with chemical compounds, where the type of bonding is different from that in crystals and where the ratio has chemical significance.) Three intermetallic compounds (with four types of melting reactions) are shown in Fig. 8.

In the hypothetical diagram shown in Fig. 8, an alloy of composition AB will freeze and melt isothermally, without the liquid or solid phases undergoing changes in composition; such a phase change is called *congruent*. All other reactions are *incongruent*; that is, two phases are formed from one phase on melting. Congruent and incongruent phase changes, however, are not limited to line compounds: the terminal component B (pure phase ϵ) and the highest-melting composition of intermediate phase δ' in Fig. 7, for example, freeze and melt congruently, while δ' and ϵ freeze and melt incongruently at other compositions.

Metastable Equilibrium. In Fig. 6(c), dashed lines indicate the portions of the liquidus and solidus lines that disappear into the two-phase solid region. These dashed lines represent valuable information, as they indicate conditions that would exist under metastable equilibrium, such as might theoretically occur during extremely rapid cooling. Metastable extensions of some stable-equilibria lines also appear in Fig. 2 and 6(b).

Ternary Diagrams

When a third component is added to a binary system, illustrating equilibrium conditions in two dimensions becomes more complicated. One option is to add a third composition dimension to the base, forming a solid diagram having binary diagrams as its vertical sides. This can be represented as a modified isometric projection, such as shown in Fig. 9. Here, boundaries of single-phase fields (liquidus, solidus, and solvus lines in the binary diagrams) become surfaces; single- and two-phase areas become volumes; three-phase lines become volumes; and four-phase points, while not shown in Fig. 9, can exist as an invariant plane. The composition of a binary eutectic liquid, which is a point in a two-component system, becomes a line in a ternary diagram, as shown in Fig. 9.

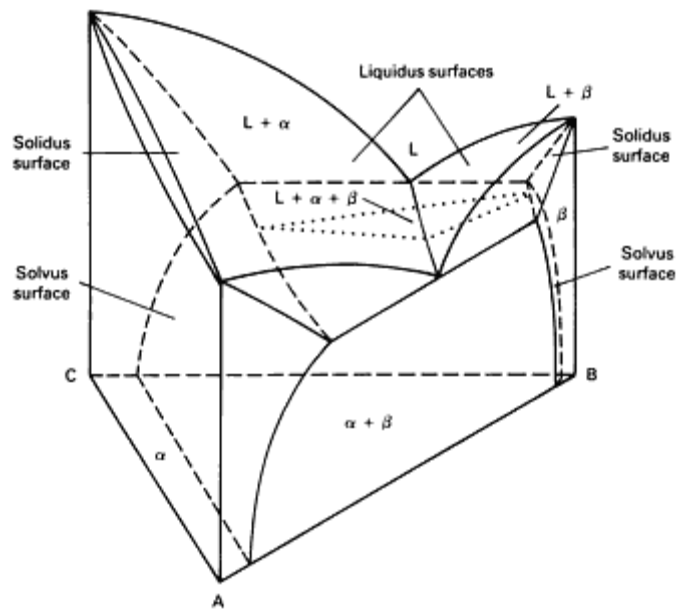

Fig. 9 Ternary phase diagram showing three-phase equilibrium. Source: 56Rhi 3

Although three-dimensional projections can be helpful in understanding the relationship in a diagram, reading values from them is difficult. Therefore, ternary systems are often represented by views of the binary diagrams that comprise the faces and two-dimensional projections of the liquidus and solidus surfaces, along with a series of two-dimensional horizontal sections (*isotherms*) and vertical sections (*isopleths*) through the solid diagram.

Vertical sections are often taken through one corner (one component) and a congruently melting binary compound that appears on the opposite face; when such a plot can be read like any other true binary diagram, it is called a *quasibinary* section. One possibility is illustrated by line 1-2 in the isothermal section shown in Fig. 10. A vertical section between a congruently melting binary compound on one face and one on a different face might also form a quasibinary section (see line 2-3).

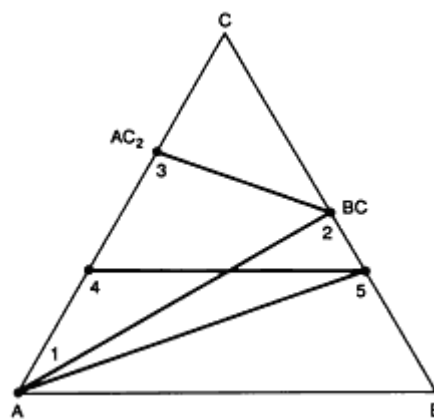

Fig. 10 Isothermal section of a ternary diagram with phase boundaries deleted for simplification.

All other vertical sections are not true binary diagrams, and the term *pseudobinary* is applied to them. A common pseudobinary section is one where the percentage of one of the components is held constant (the section is parallel to one of the faces), as shown by line 4-5 in Fig. 10. Another is one where the ratio of two constituents is held constant and the amount of the third is varied from 0 to 100% (line 1-5).

Isothermal Sections. Composition values in the triangular isothermal sections are read from a triangular grid consisting of three sets of lines parallel to the faces and placed at regular composition intervals (see Fig. 11). Normally, the point of the triangle is placed at the top of the illustration, component A is placed at the bottom left, B at the bottom right, and C at the top. The amount of component A is normally indicated from point C to point A, the amount of component B from point A to point B, and the amount of component C from point B to point C. This scale arrangement is often modified when only a corner area of the diagram is shown.

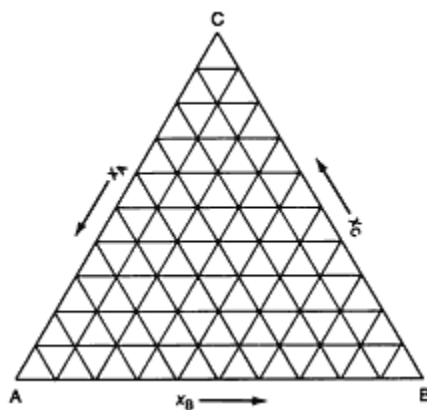

Fig. 11 Triangular composition grid for isothermal section; x is the composition of each constituent in mole fraction or percent.

Projected Views. Liquidus, solids, and solvus surfaces by their nature are not isothermal. Therefore, equal-temperature (isothermal) contour lines are often added to the projected views of these surfaces to indicate their shape (see Fig. 12). In addition to (or instead of) contour lines, views often show lines indicating the temperature troughs (also called "valleys" or "grooves") formed at the intersections of two surfaces. Arrowheads are often added to these lines to indicate the direction of decreasing temperature in the trough.

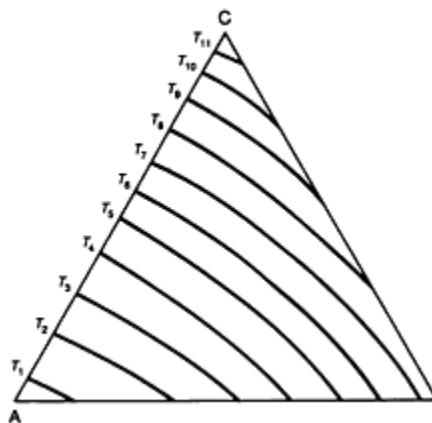

Fig. 12 Liquidus projection of a ternary phase diagram showing isothermal contour lines. Source: Adapted from 56Rhi 3

Reference cited in this section

3. **56Rhi:** F.N. Rhines, *Phase Diagrams in Metallurgy: Their Development and Application*, McGraw-Hill, 1956. *This out-of-print book is a basic text designed for undergraduate students in metallurgy.*

Thermodynamic Principles

The reactions between components, the phases formed in a system, and the shape of the resulting phase diagram can be explained and understood through knowledge of the principles, laws, and terms of thermodynamic, and how they apply to the system.

Internal Energy. The sum of the kinetic energy (energy of motion) and potential energy (stored energy) of a system is called its *internal energy*, E . Internal energy is characterized solely by the state of the system.

Closed System. A thermodynamic system that undergoes no interchange of mass (material) with its surroundings is called a *closed system*. A closed system, however, can interchange energy with its surroundings.

First Law. The *First Law of Thermodynamics*, as stated by Julius von Mayer, James Joule, and Hermann von Helmholtz in the 1840s, states that *energy can be neither created nor destroyed*. Therefore, it is called the *Law of Conservation of Energy*. This law means that the total energy of an isolated system remains constant throughout any operations that are carried out on it; that is, for any quantity of energy in one form that disappears from the system, an equal quantity of another form (or other forms) will appear.

For example, consider a closed gaseous system to which a quantity of heat energy δQ , is added and a quantity of work, δW , is extracted. The First Law describes the change in internal energy, dE , of the system as follows:

$$dE = \delta Q - \delta W$$

In the vast majority of industrial processes and material applications, the only work done by or on a system is limited to pressure/volume terms. Any energy contributions from electric, magnetic, or gravitational fields are neglected, except for electrowinning and electrorefining processes such as those used in the production of copper, aluminum, magnesium, the alkaline metals, and the alkaline earths. With the neglect of field effects, the work done by a system can be measured by summing the changes in volume, dV , times each pressure causing a change. Therefore, when field effects are neglected, the First Law can be written:

$$dE = \delta Q - PdV$$

Enthalpy. Thermal energy changes under constant pressure (again neglecting any field effects) are most conveniently expressed in terms of the *enthalpy*, H , of a system. Enthalpy, also called *heat content*, is defined by:

$$H = E + PV$$

Enthalpy, like internal energy, is a function of the state of the system, as is the product PV .

Heat Capacity. The *heat capacity*, C , of a substance is the amount of heat required to raise its temperature one degree; that is:

$$C = \frac{\delta Q}{\delta T}$$

However, if the substance is kept at constant volume ($dV = 0$):

$$\delta Q = dE$$

and

$$C_v = \left(\frac{\delta Q}{\delta T} \right)_v = \left(\frac{dE}{dT} \right)_v$$

If, instead, the substance is kept at constant pressure (as in many metallurgical systems),

$$C_p = \left(\frac{dE}{dT} + \frac{PdV}{dT} \right)_p$$

$$C_p = \left[\frac{d(E + PV)}{dT} \right]_p$$

and

$$C_p = \left(\frac{dH}{dT} \right)_p$$

Second Law. While the First Law establishes the relationship between the heat absorbed and the work performed by a system, it places no restriction on the source of the heat or its flow direction. This restriction, however, is set by the *Second Law of Thermodynamics*, which was advanced by Rudolf Clausius and William Thomson (Lord Kelvin). The Second Law states that *the spontaneous flow of heat always is from the higher temperature body to the lower temperature body*. In other words, *all naturally occurring processes tend to take place spontaneously in the direction that will lead to equilibrium*.

Entropy. The Second Law is not conveniently stated in terms of *entropy*, S , another property of state possessed by all systems. Entropy represents the energy (per degree of absolute temperature, T) in a system that is not available for work. In terms of entropy, the Second Law states that *all natural processes tend to occur only with an increase in entropy, and the direction of the process always is such as to lead to an increase in entropy*. For processes taking place in a system in equilibrium with its surroundings, the change in entropy is defined as follows:

$$dS \equiv \frac{\delta Q}{T} \equiv \frac{dE + PdV}{T}$$

Third Law. A principle advanced by Theodore Richards, Walter Nernst, Max Planck, and others, often called *Third Law of Thermodynamics*, states that *the entropy of all chemically homogeneous materials can be taken as zero at absolute zero temperature (0 K)*. This principle allows calculation of the absolute values of entropy of pure substances solely from heat capacity.

Gibbs Energy. Because both S and V are difficult to control experimentally, an additional term, *Gibbs energy*, G , is introduced, whereby:

$$G \equiv E + PV - TS \equiv H - TS$$

and

$$dG = dE + PdV + VdP - TdS - SdT$$

However,

$$dE = TdS - PdV$$

Therefore,

$$dG = VdP - SdT$$

Here, the change in Gibbs energy of a system undergoing a process is expressed in terms of two independent variables, pressure and absolute temperature, which are readily controlled experimentally. If the process is carried out under conditions of constant pressure and temperature, the change in Gibbs energy of a system at equilibrium with its surroundings (a reversible process) is zero. For a spontaneous (irreversible) process, the change in Gibbs energy is less than zero (negative); that is, the Gibbs energy decreases during the process, and it reaches a minimum at equilibrium.

Features of Phase Diagrams

The areas (fields) in a phase diagram, and the position and shapes of the points, lines, surfaces, and intersections in it, are controlled by thermodynamic principles and the thermodynamic properties of all of the phases that constitute the system.

Phase-field Rule. The *phase-field rule* specifies that at constant temperature and pressure, the number of phases in adjacent fields in a multi-component diagram must differ by one.

Theorem of Le Châtelier. The *theorem of Henri Le Châtelier*, which is based on thermodynamic principles, states that *if a system in equilibrium is subjected to a constraint by which the equilibrium is altered, a reaction occurs that opposes the constraint, i.e., a reaction that partially nullifies the alteration*. The effect of this theorem on lines in a phase diagram can be seen in Fig. 2. The slopes of the sublimation line (1) and the vaporization line (3) show that the system reacts to increasing pressure by making the denser phases (solid and liquid) more stable at higher pressure. The slope of the melting line (2) indicates that this hypothetical substance contracts on freezing. (Note that the boundary between liquid water and ordinary ice, which expands on freezing, slopes toward the pressure axis.)

Clausius-Clapeyron Equation. The theorem of Le Châtelier was quantified by Benoit Clapeyron and Rudolf Clausius to give the following equation:

$$\frac{dP}{dT} = \frac{\Delta H}{T\Delta V}$$

where dP/dT is the slope of the univariant lines in a PT diagram such as those shown in Fig. 2, ΔV is the difference in molar volume of the two phases in the reaction, and ΔH is the difference in molar enthalpy of the two phases (the heat of the reaction).

Solutions. The shapes of liquidus, solidus, and solvus curves (or surfaces) in a phase diagram are determined by the Gibbs energies of the relevant phases. In this instance, the Gibbs energy must include not only the energy of the constituent components, but also the energy of mixing of these components in the phase.

Consider, for example, the situation of complete miscibility shown in Fig. 3. The two phases, liquid and solid α , are in stable equilibrium in the two-phase field between the liquidus and solidus lines. The Gibbs energies at various temperatures are calculated as a function of composition for ideal liquid solutions and for ideal solid solutions of the two components, A and B. The result is a series of plots similar to those shown in Fig. 13(a) to (e).

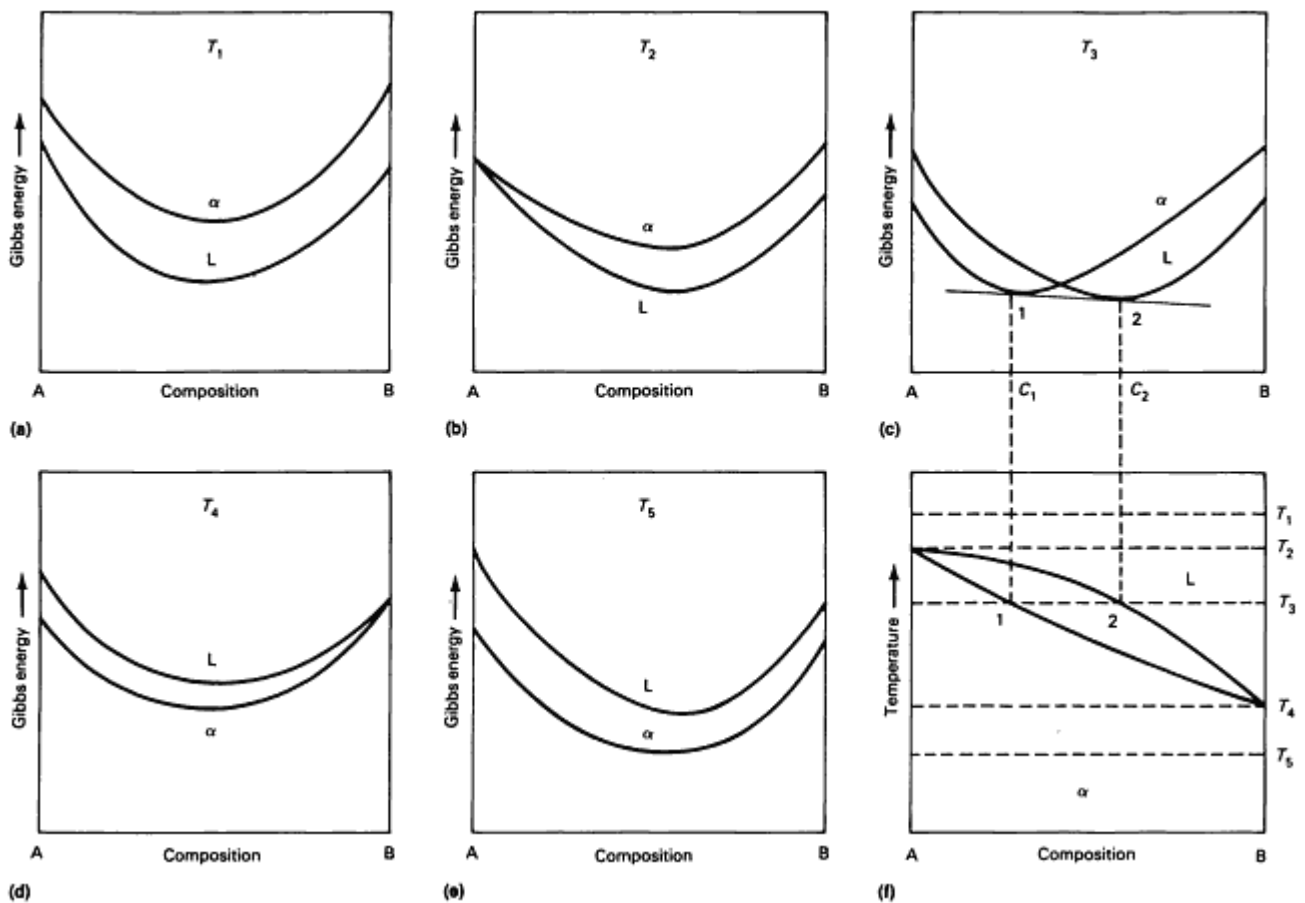

Fig. 13 Use of Gibbs energy curves to construct a binary phase diagram that shows miscibility in both the liquid and solid states. Source: Adapted from 66Pri 4

At temperature T_1 , the liquid solution has the lower Gibbs energy and, therefore, is the more stable phase. At T_2 , the melting temperature of A, the liquid and solid are equally stable only at a composition of pure A. At temperature T_3 , between the melting temperatures of A and B, the Gibbs energy curves cross. Temperature T_4 is the melting temperature of B, while T_5 is below it.

Construction of the two-phase liquid-plus-solid field of the phase diagram in Fig. 13(f) is as follows. According to thermodynamic principles, the compositions of the two phases in equilibrium with each other at temperature T_3 can be determined by constructing a straight line that is tangential to both curves in Fig. 13(c). The points of tangency, 1 and 2, are then transferred to the phase diagram as points on the solidus and liquidus, respectively. This is repeated at sufficient temperatures to determine the curves accurately.

If, at some temperature, the Gibbs energy curves for the liquid and the solid tangentially touch at some point, the resulting phase diagram will be similar to those shown in Fig. 4(a) and (b), where a maximum or minimum appears in the liquidus and solidus curves.

Mixtures. The two-phase field in Fig. 13(f) consists of a mixture of liquid and solid phases. As stated above, the compositions of the two phases in equilibrium at temperature T_3 are C_1 and C_2 . The horizontal isothermal line connecting points 1 and 2, where these compositions intersect temperature T_3 , is called a *tie line*. Similar tie lines connect the coexisting phases throughout all two-phase fields (areas) in binary and (volumes) in ternary systems, while *tie triangles* connect the coexisting phases throughout all three-phases regions (volumes) in ternary systems.

Eutectic phase diagrams, a feature of which is a field where there is a mixture of two solid phases, also can be constructed from Gibbs energy curves. Consider the temperatures indicated on the phase diagram in Fig. 14(f) and the Gibbs energy curves for these temperatures (Fig. 14a-e). When the points of tangency on the energy curves are transferred to the

diagram, the typical shape of a eutectic system results. The mixture of solid α and β that forms upon cooling through the eutectic point k has a special microstructure, as discussed later.

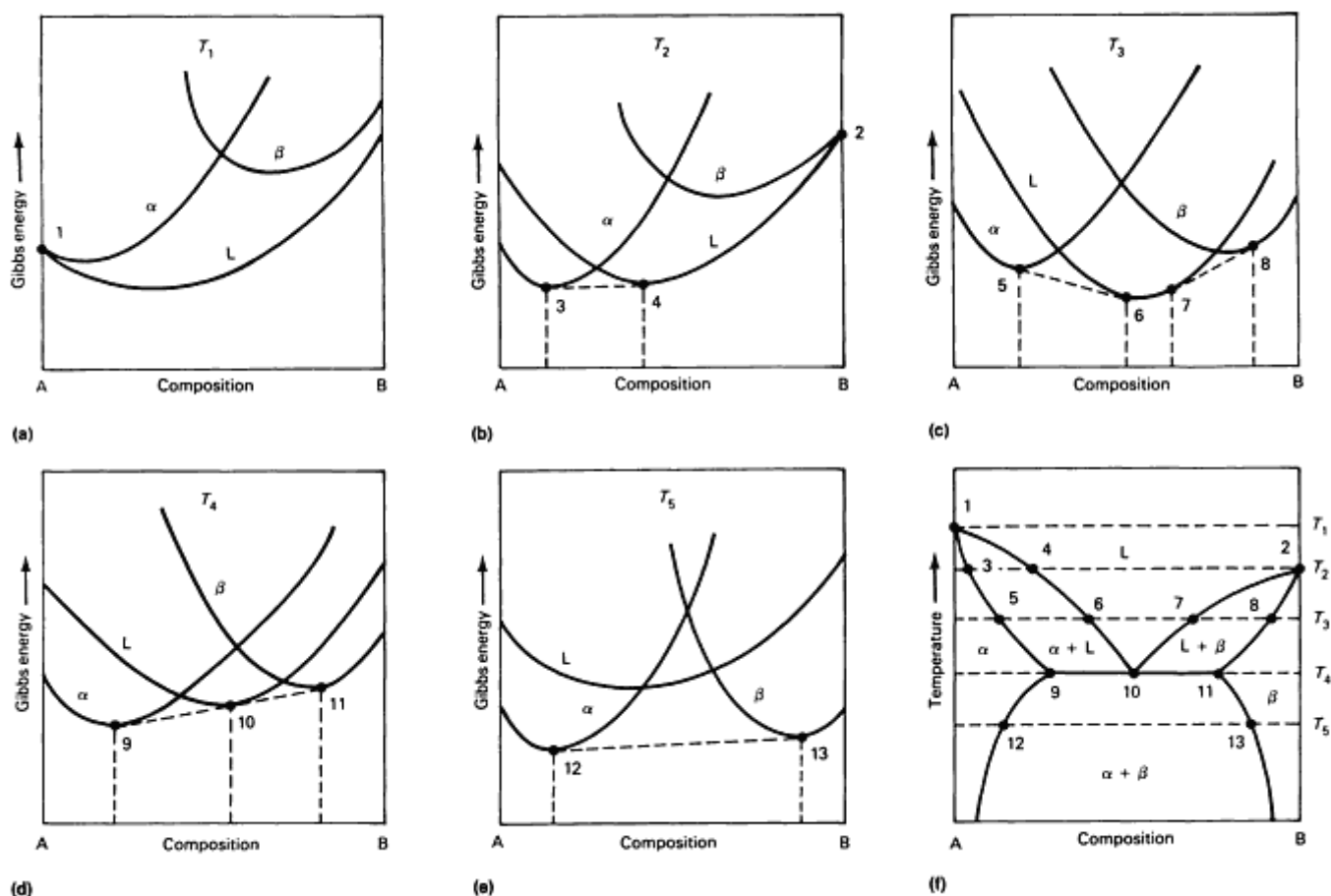

Fig. 14 Use of Gibbs energy curves to construct a binary phase diagram of the eutectic type. Source: Adapted from 68Gor 5

Binary phase diagrams that have three-phase reactions other than the eutectic reaction, as well as diagrams with multiple three-phase reactions, also can be constructed from appropriate Gibbs energy curves. Likewise, Gibbs energy surfaces and tangential planes can be used to construct ternary phase diagrams.

Curves and Intersections. Thermodynamic principles also limit the shape of the various boundary curves (or surfaces) and their intersections. For example, see the PT diagram shown in Fig. 2. The Clausius-Clapeyron equation requires that at the intersection of the triple curves in such a diagram, the angle between adjacent curves should never exceed 180° or, alternatively, the extension of each triple curve between two phases must lie within the field of third phase.

The angle at which the boundaries of two-phase fields meet also is limited by thermodynamics. That is, the angle must be such that the extension of each beyond the point of intersection projects into a two-phase field, rather than a one-phase field. An example of correct intersections can be seen in Fig. 6(b), where both the solidus and solvus lines are concave. However, the curvature of both boundaries need not be concave; Fig. 15 shows two equally acceptable (but unlikely) intersections where convex and concave lines are mixed.

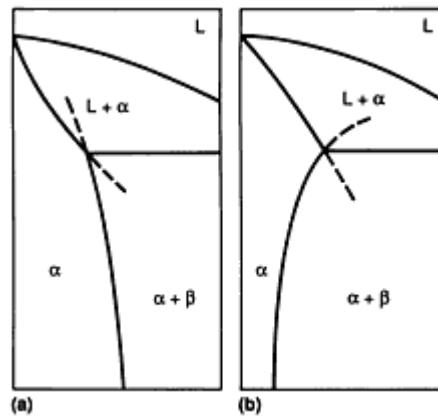

Fig. 15 Examples of acceptable intersection angles for boundaries of two-phase fields. Source: 56Rhi 3

Congruent Transformations. The *congruent point* on a phase diagram is where different phases of the same composition are equilibrium. The *Gibbs-Konovalov Rule* for congruent points, which was developed by Dmitry Konovalov from a thermodynamic expression given by J. Willard Gibbs, states that the slope of phase boundaries at congruent transformations must be zero (horizontal). Examples of correct slope at the maximum and minimum points on liquidus and solidus curves can be seen in Fig. 4. Often, the inner curve on a diagram such as that shown in Fig. 4 is erroneously drawn with a sharp inflection (see Fig. 16).

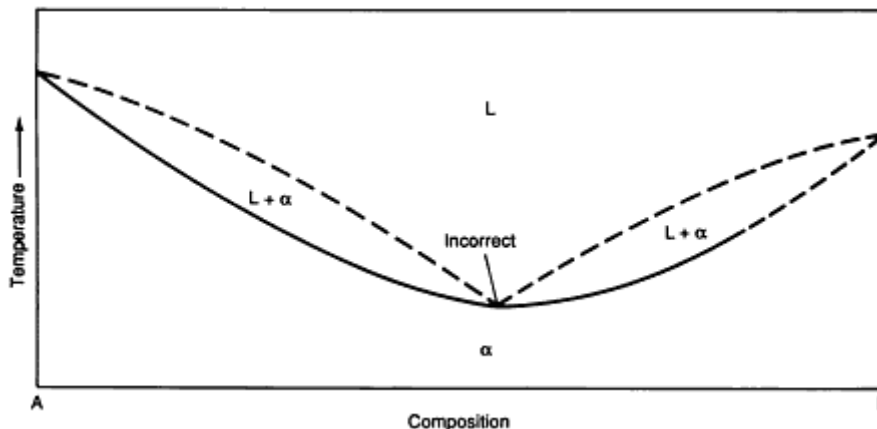

Fig. 16 An Example of a binary phase diagram with a minimum in the liquidus that violates the Gibbs-Konovalov Rule. Source: 81Goo 9

A similar common construction error is found in the diagrams of systems containing congruently melting compounds (such as the line compounds shown in Fig. 17) but having little or no association of the component atoms in the melt (as with most metallic systems). This type of error is especially common in partial diagrams, where one or more system components is a compound instead of an element. (The slope of liquids and solidus curves, however, must *not* be zero when they terminate at an, element, or at a compound having complete association in the melt.)

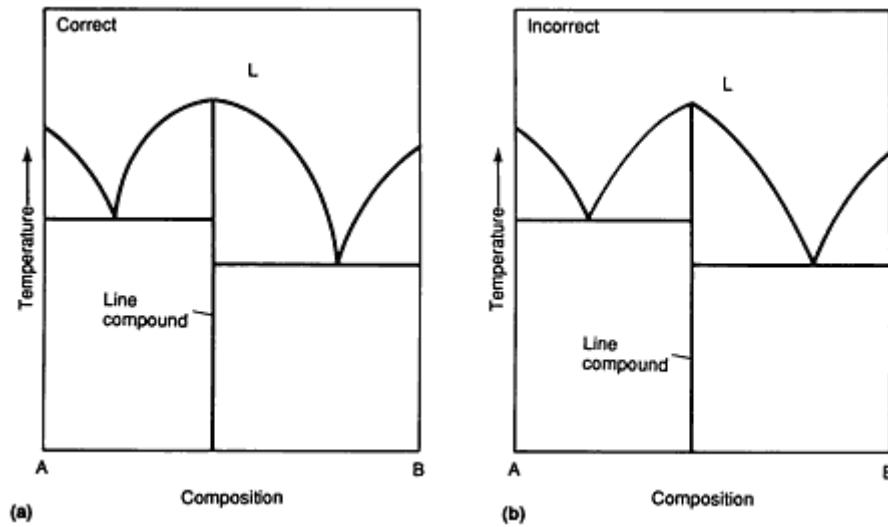

Fig. 17 Schematic diagrams of binary systems containing congruent-melting compounds but having no association of the component atoms in the melt common. The diagram in (a) is consistent with the Gibbs-Konvalov Rule, whereas that in (b) violates the rule. Source: 81Goo 9

Common Construction Errors. Hiroaki Okamoto and Thaddeus Massalski have prepared the hypothetical binary shown in Fig. 18, which exhibits many typical errors of construction (marked as points 1 to 23). The explanation for each error is given in the accompanying text; one possible error-free version of the same diagram is shown in Fig. 19.

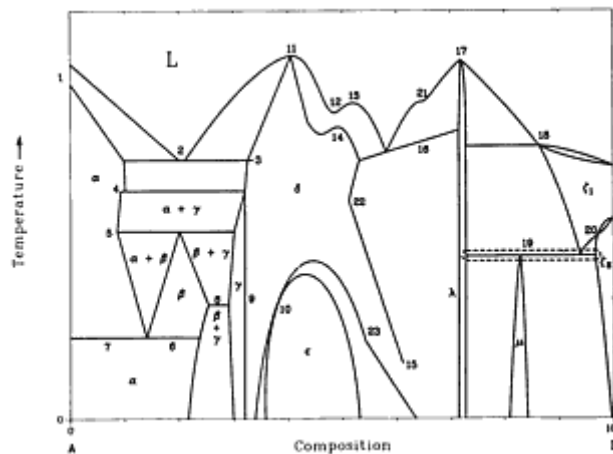

Fig. 18 Hypothetical binary phase diagram showing many typical errors of construction. See the accompanying text for discussion of the errors at points 1 to 23. Source: 91OKa1 18

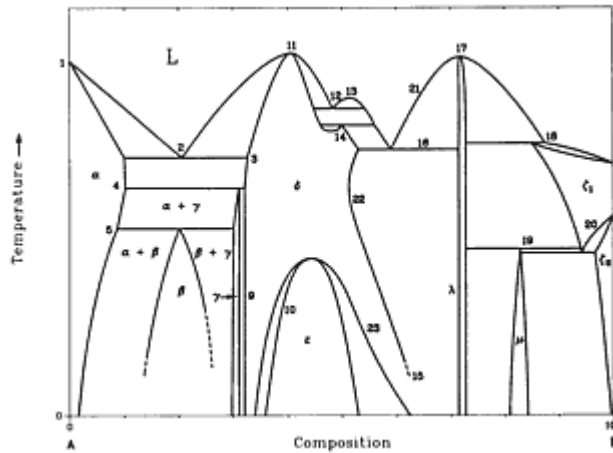

Fig. 19 Error-free version of the phase diagram shown in Fig. 18. Source: 910ka1 18

Typical phase-rule violations in Fig. 18 include:

1. A two-phase field cannot be extended to become part of a pure-element side of a phase diagram at zero solute. In example 1, the liquidus and the solidus must meet at the melting point of the pure element.
2. Two liquidus curves must meet at one composition at a eutectic temperature.
3. A tie line must terminate at a phase boundary.
4. Two solvus boundaries (or two liquidus, or two solidus, or a solidus and a solvus) of the same phase must meet (i.e., intersect) at one composition at an invariant temperature. (There should not be two solubility values for a phase boundary at one temperature.)
5. A phase boundary must extrapolate into a two-phase field after crossing an invariant point. The validity of this feature, and similar features related to invariant temperatures, is easily demonstrated by constructing hypothetical free-energy diagrams slightly below and slightly above the invariant temperature and by observing the relative positions of the relevant tangent points to the free energy curves. After intersection, such boundaries can also be extrapolated into metas-table regions of the phase diagram. Such extrapolations are sometimes indicated by dashed or dotted lines.
6. Two single-phase fields (α and β) should not be in contact along a horizontal line. (An invariant-temperature line separates two-phase fields in contacts.)
7. A single-phase field (α in this instance) should not be apportioned into subdivisions by a single line. Having created a horizontal (invariant) line at 6 (which is an error), there may be a temptation to extend this line into a single-phase field, α , creating an additional error.
8. In a binary system, an invariant-temperature line should involve equilibrium among three phases.
9. There should be a two-phase field between two single-phase fields (Two single phases cannot touch except at a point. However, second-order and higher-order transformations may be exceptions to this rule.)
10. When two phase boundaries touch at a point, they should touch at an extremity of temperature.
11. A touching liquidus and solidus (or any two touching boundaries) must have a horizontal common tangent at the congruent point. In this instance, the solidus at the melting point is too "sharp" and appears to be discontinuous.
12. A local minimum point in the lower part of a single-phase field (in this instance, the liquid) cannot be drawn without additional boundary in contact with it. (In this instance, a horizontal monotectic line is most likely missing.)
13. A local maximum point in the lower part of a single-phase field cannot be drawn without a monotectic, monotectoid, systectic, and sintectoid reaction occurring below it at a lower temperature. Alternatively, a solidus curve must be drawn to touch the liquidus at point 13.
14. A local maximum point in the upper part of a single-phase field cannot be drawn without the phase boundary touching a reversed monotectic, or a monotectoid, horizontal reaction line coinciding with the

temperature of the maximum. When a 14 type of error is introduced, a minimum may be created on either side (or on one side) of 14. This introduces an additional error, which is the opposite of 13, but equivalent to 13 in kind.

15. A phase boundary cannot terminate within a phase field. (Termination due to lack of data is, of course, often shown in phase diagrams, but this is recognized to be artificial.
16. The temperature of an invariant reaction in a binary system must be constant. (The reaction line must be horizontal.)
17. The liquidus should not have a discontinuous sharp peak at the melting point of a compound. (This rule is not applicable if the liquid retains the molecular state of the compound, i.e., in the situation of an ideal association.)
18. The compositions of all three phases at an invariant reaction must be different.
19. A four-phase equilibrium is not allowed in a binary system.
20. Two separate phase boundaries that create a two-phase field between two phases in equilibrium should not cross each other.
21. Two inflection points are located too closely to each other.
22. An abrupt reversal of the boundary direction (more abrupt than a typical smooth "retro-grade"). This particular change can occur only if there is an accompanying abrupt change in the temperature dependence of the thermodynamic properties of either of the two phases involved (in this instance, δ or λ in relation to the boundary). The boundary turn at 22 is very unlikely to be explained by a realistic change in the composition dependence of the Gibbs energy functions.
23. An abrupt change in the slope of a single-phase boundary. This particular change can occur only by an abrupt change in the composition dependence of the thermodynamic properties of the single phase involved (in this instance, the δ phase). It cannot be explained by any possible abrupt change in the temperature dependence of the Gibbs energy function of the phase. (If the temperature dependence were involved, there would also be a change in the boundary of the ϵ phase.)

Problems Connected With Phase-Boundary Curvatures Although phase rules are not violated, there are additional unusual situations (21, 22, and 23) that have also been included in Fig. 18. In each instance, a more subtle thermodynamic problem may exist related to these situations. Examples are discussed where several thermodynamically unlikely diagrams are considered. The problems with each of these situations involve an indicated rapid change of slope of a phase boundary. If such situations are to be associated with realistic thermodynamics, the temperature (or the composition) dependence of the thermodynamic functions of the phase (or phases) involved would be expected to show corresponding abrupt and unrealistic variations in the phase diagram regions where such abrupt phase boundary changes are proposed, without any clear reason for them. Even the onset of ferromagnetism in a phase does not normally cause an abrupt change of slope of the related phase boundaries. The unusual changes of slope considered here are shown in points 21-23.

Higher-Order Transitions. The transitions considered in this Introduction up to this point have been limited to the common thermodynamic types called *first-order transitions*--that is, changes involving distinct phases having different lattice parameters, enthalpies, entropies, densities, and so on. Transitions not involving discontinuities in composition, enthalpy, entropy, or molar volume are called *higher-order transitions* and occur less frequently. The change in the magnetic quality of iron from ferromagnetic to paramagnetic as the temperature is raised above 771 °C (1420 °F) is an example of a second-order transition: no phase change is involved and the Gibbs phase rule does not come into play in the transition. Another example of a higher-order transition is the continuous change from a random arrangement of the various kinds of atoms in a multicomponent crystal structure (a *disordered structure*) to an arrangement where there is some degree of *crystal ordering* of the atoms (an *ordered structure*, or *superlattice*), or the reverse reaction.

References cited in this section

3. **56Rhi:** F.N. Rhines, *Phase Diagrams in Metallurgy: Their Development and Application*, McGraw-Hill, 1956. *This out-of-print book is a basic text designed for undergraduate students in metallurgy.*
4. **66Pri:** A. Prince, *Alloy Phase Equilibria*, Elsevier, 1966. *This out-of-print book covers the thermodynamic approach to binary, ternary, and quaternary phase diagrams.*
5. **68Gor:** P. Gordon, *Principles of Phase Diagrams in Materials Systems*, McGraw-Hill 1968; reprinted by

Robert E. Krieger Publishing, 1983. *Covers the thermodynamic basis of phase diagrams; the presentation is aimed at materials engineers and scientists.*

9. **81Goo:** D.A. Goodman, J.W. Cahn, and L.H. Bennett, The Centennial of the Gibbs-Konovlov Rule for Congruent Points, *Bull. Alloy Phase Diagrams*, Vol 2 (No. 1), 1981, p 29-34. *Presents the theoretical basis for the rule and its application to phase diagram evaluation.*
18. **91Oka1:** H. Okamoto and T.B. Massalski, Thermodynamically Improbable Phase Diagrams, *J. Phase Equilibria*, Vol 12 (No. 2), 1991, p 148-168. *Presents examples of phase-rule violations and problems with phase-boundary curvatures; also discusses unusual diagrams.*

Crystal Structure

A *crystal* is a solid consisting of atoms or molecules arranged in a pattern that is repetitive in three dimensions. The arrangement of the atoms or molecules in the interior of a crystal is called its *crystal structure*. The *unit cell* of a crystal is the smallest pattern of arrangement that can be contained in a parallelepiped, the edges of which form the *a*, *b*, and *c* axes of the crystal. The three-dimensional aggregation of unit cells in the crystal forms a *space lattice*, or *Bravais lattice* (see Fig. 20).

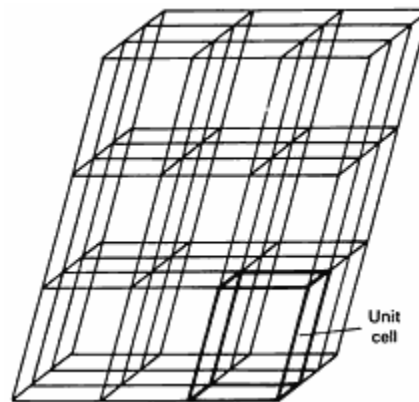

Fig. 20 A space lattice

Crystal Systems. Seven different *crystal systems* are recognized in crystallography, each having a different set of axes, unit-cell edge lengths, and interaxial angles (see Table 2). Unit-cell *edge lengths* *a*, *b*, and *c* are measured along the corresponding *a*, *b*, and *c* axes (see Fig. 21). Unit-cell faces are identified by capital letters: face *A* contains axes *b* and *c*, face *B* contains *c* and *a*, and face *C* contains *a* and *b*. (Faces are not labeled in Fig. 21.) *Interaxial angle* α occurs in face *A*, angle β in face *B*, and angle γ in face *C* (see Fig. 21).

Table 2 Relationships of edge lengths and of interaxial angles for the seven crystal systems.

Crystal system	Edge lengths	Interaxial angles	Examples
Triclinic (anorthic)	$a \neq b \neq c$	$\alpha \neq \beta \neq \gamma \neq 90^\circ$	HgK
Monoclinic	$a \neq b \neq c$	$\alpha = \gamma = 90^\circ \neq \beta$	β -S; CoSb ₂
Orthorhombic	$a \neq b \neq c$	$\alpha = \beta = \gamma = 90^\circ$	α -S; Ga; Fe ₃ C (cementite)

Tetragonal	$a \neq b \neq c$	$\alpha = \beta = \gamma = 90^\circ$	β -Sn (white); TiO ₂
Hexagonal	$a \neq b \neq c$	$\alpha = \beta = 90^\circ; \gamma = 120^\circ$	Zn; Cd; NiAs
Rhombohedral ^(a)	$a = b = c$	$\alpha = \beta = \gamma \neq 90^\circ$	As; Sb; Bi; calcite
Cubic	$a = b = c$	$\alpha = \beta = \gamma = 90^\circ$	Cu; Ag; Au; Fe; NaCl

(a) Rhombohedral crystals (sometimes called trigonal) also can be describe by using hexagonal axes (rhombohedral-hexagonal).

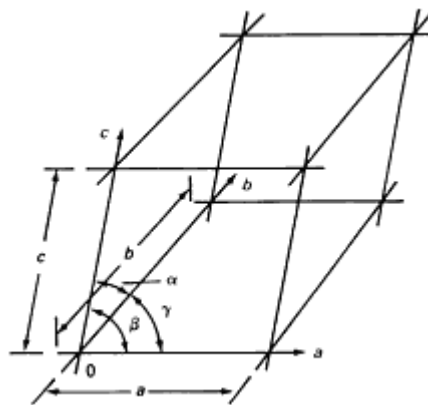

Fig. 21 Crystal axes and unit-cell edge lengths. Unit-cell faces are shown, but to avoid confusion they are not labeled.

Lattice Dimensions. It should be noted that the unit-cell edge lengths and interaxial angles are unique for each crystalline substance. The unique edge lengths are called *lattice parameters*. The term *lattice constant* also has been used for the length of an edge, but the values of edge length are not constant, varying with composition within a phase field and also with temperature due to thermal expansion and contraction. (Reported lattice parameter values are assumed to be room-temperature values unless otherwise specified.) Interaxial angles other than 90° or 120° also can change slightly with changes in composition. When the edges of the unit cell are not equal in all three directions, all unequal lengths must be stated to completely define the crystal. The same is true if all interaxial angles are not equal. When defining the unit-cell size of an alloy phase, the possibility of crystal ordering occurring over several unit cells should be considered. For example, in the copper-gold system, a superlattice forms that is made up of 10 cells of the disordered lattice, creating what is called *long-period ordering*.

Lattice Points. As shown in Fig. 20, a space lattice can be viewed as a three-dimensional network of straight lines. The intersections of the lines (called *lattice points*) represent locations in space for the same kind of atom or group of atoms of identical composition, arrangement, and orientation. There are five basic arrangements for lattice points within a unit cell. The first four are: primitive (simple), having lattice points solely at cell corners; base-face centered (end-centered), having lattice points centered on the *C* faces, or ends of the cell; all-face centered, having lattice points centered all faces; and innercentered (body-centered), having lattice points at the center of the volume of the unit cell. The fifth arrangement, the primitive rhombohedral unit cell, is considered a separate basic arrangement, as shown in the following section on crystal structure nomenclature. These five basic arrangements are identified by capital letters as follows: *P* for the primitive cubic, *C* for the cubic cell with lattice points on the two *C* faces, *F* for all-face-centered cubic, *I* for innercentered (body-centered) cubic, and *R* for primitive rhombohedral.

Crystal Structure Nomenclature. When the seven crystal systems are considered together with the five space lattices, the combinations listed in Table 3 are obtained. These 14 combinations form the basis of the system of *Pearson symbols* developed by William B. Pearson, which are widely used to identify crystal types. As can be seen in Table 3, the Pearson symbol uses a small letter to identify the crystal system and a capital letter to identify the space lattice. To these is added a number equal to the number of atoms in the unit cell conventionally selected for the particular crystal type. When determining the number of atoms in the unit cell, it should be remembered that each atom that is shared with an adjacent cell (or cells) must be counted as only a fraction of an atom. The Pearson symbols for some simple metal crystals are shown in Fig. 22(a), 22(b), 22(c), and 22(d), along with schematic drawings illustrating the atom arrangements in the unit cell. It should be noted that in these schematic representations, the different kinds of atoms in the prototype crystal illustrated are drawn to represent their relative sizes, but in order to show the arrangements more clearly, all the atoms are shown much smaller than their true effective size in real crystals.

Table 3 The 14 space (Bravais) lattices and their Pearson symbols

Crystal system	Space lattice	Pearson symbol
Triclinic (anorthic)	Primitive	<i>aP</i>
Monoclinic	Primitive	<i>mP</i>
	Base-centered ^(a)	<i>mC</i>
Orthorhombic	Primitive	<i>oP</i>
	Base-centered ^(a)	<i>oC</i>
	Face-centered	<i>oF</i>
	Body-centered	<i>oI</i>
Tetragonal	Primitive	<i>tP</i>
	Body-centered	<i>tI</i>
Hexagonal	Primitive	<i>hP</i>
Rhombohedral	Primitive	<i>hR</i>
Cubic	Primitive	<i>cP</i>
	Face-centered	<i>cF</i>

(a) The face that has a lattice point at its center may be chosen as the c face (the xy plan), denoted by the symbol C , or as the a or b face, denoted by A or B , because the choice of axes is arbitrary and does not alter the actual translations of the lattice.

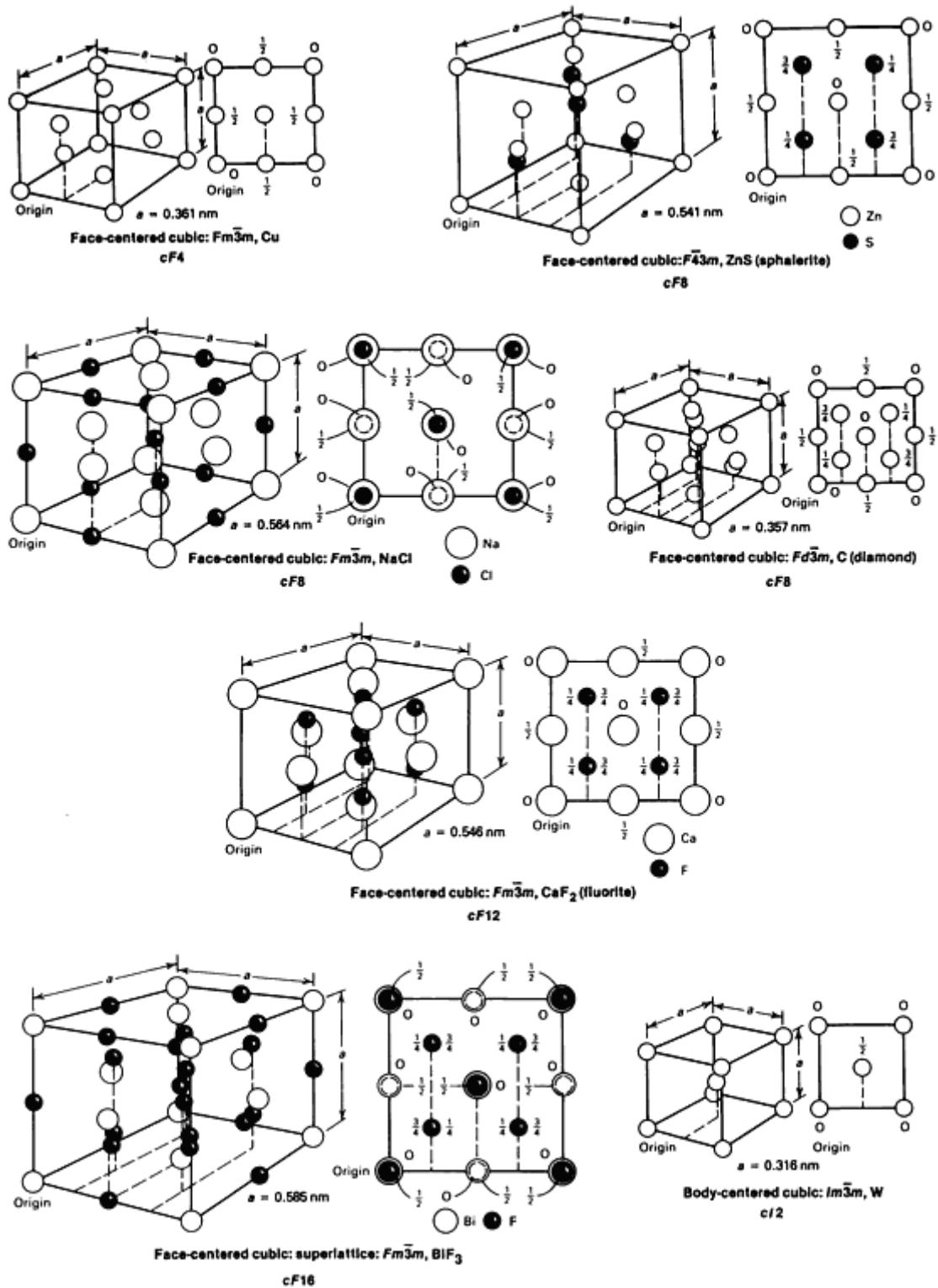

Fig. 22(a) Schematic drawings of the unit cells and ion positions for some simple metal crystals, arranged alphabetically according to Pearson symbol. Also listed are the space lattice and crystal system, space-group notation, and prototype for each crystal. Reported lattice parameters are for the prototype crystal.

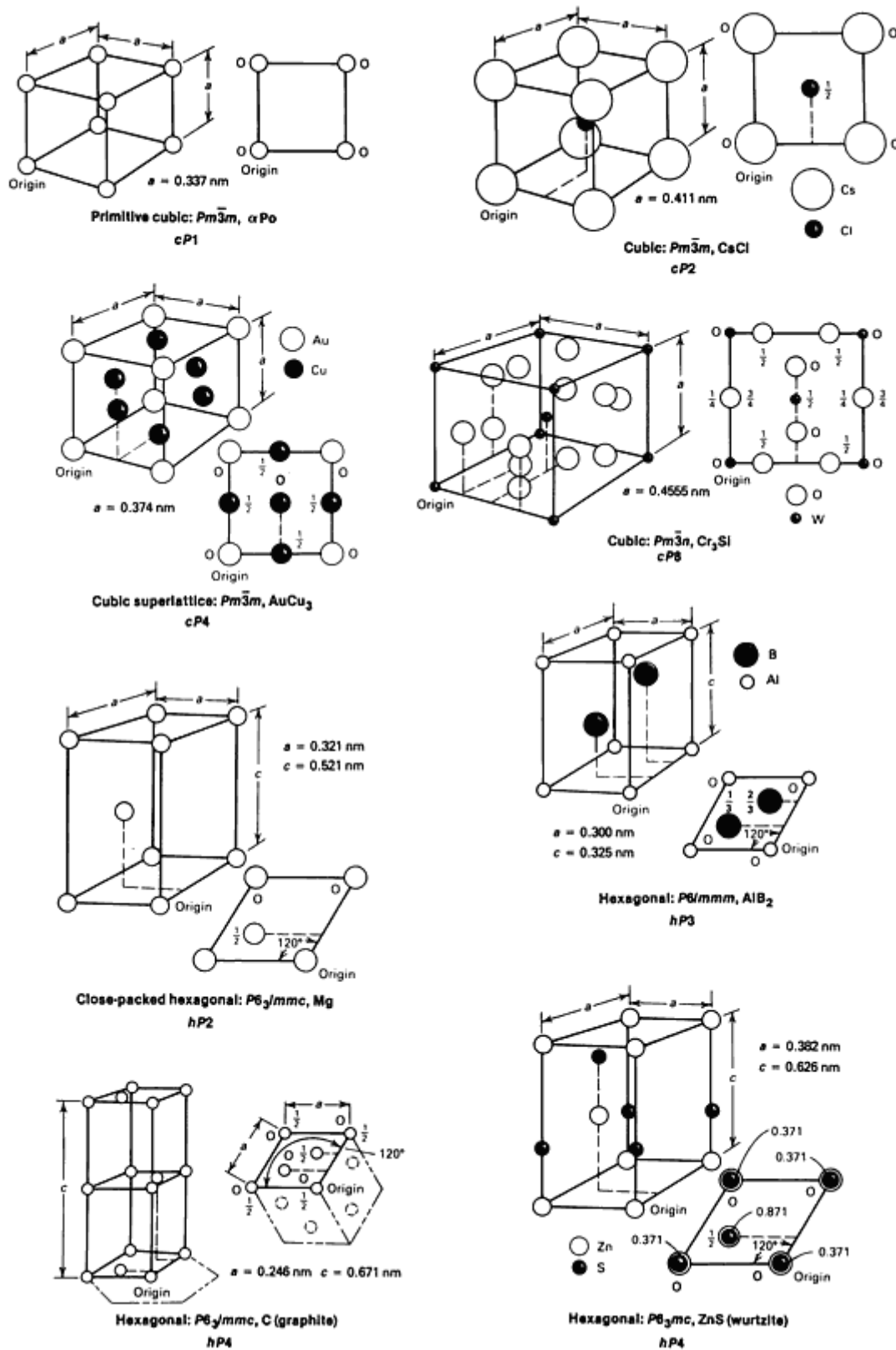

Fig. 22(b) Schematic drawings of the unit cells and ion positions for some simple metal crystals, arranged alphabetically according to Pearson symbol. Also listed are the space lattice and crystal system, space-group notation, and prototype for each crystal. Reported lattice parameters are for the prototype crystal.

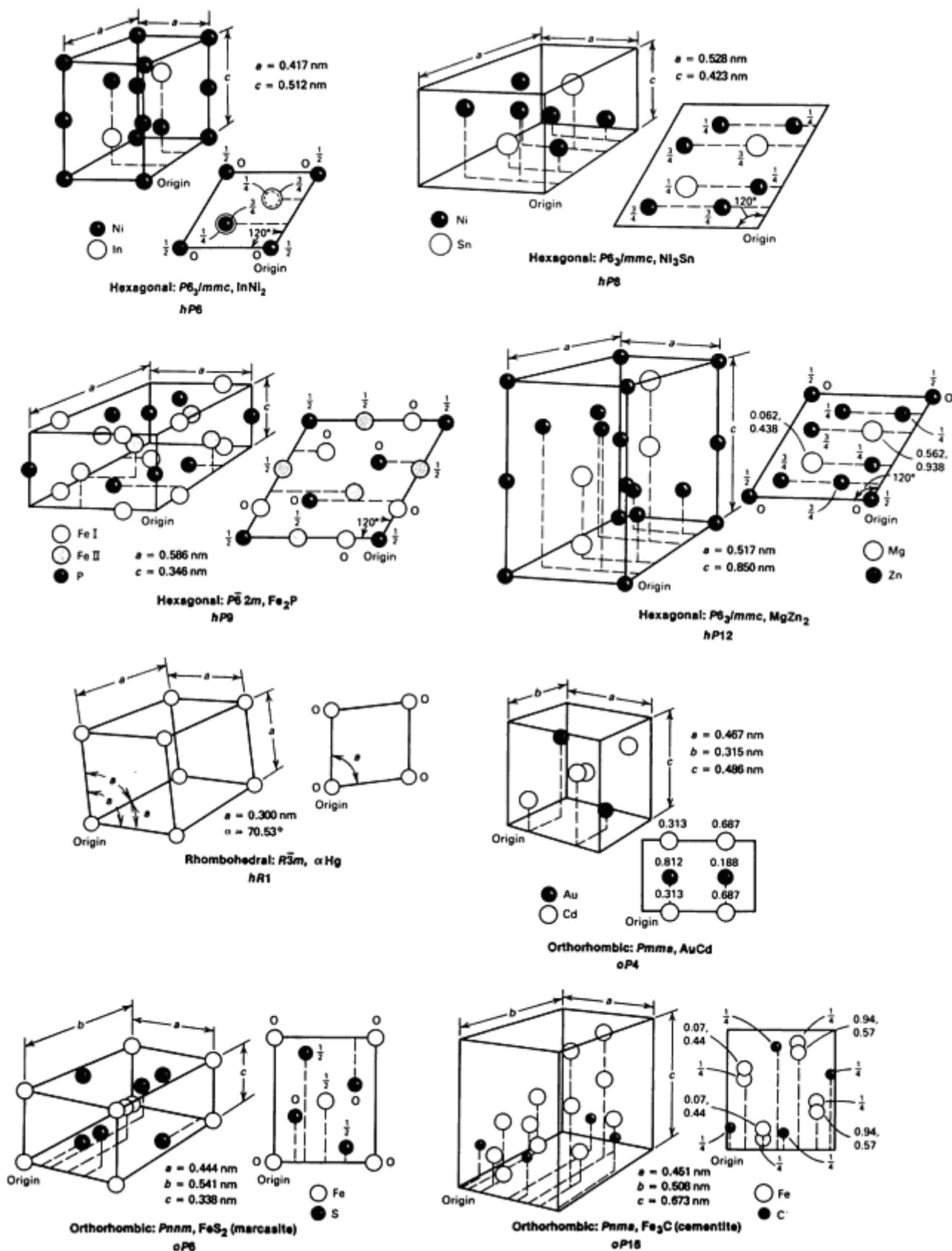

Fig. 22(c) Schematic drawings of the unit cells and ion positions for some simple metal crystals, arranged alphabetically according to Pearson symbol. Also listed are the space lattice and crystal system, space-group notation, and prototype for each crystal. Reported lattice parameters are for the prototype crystal.

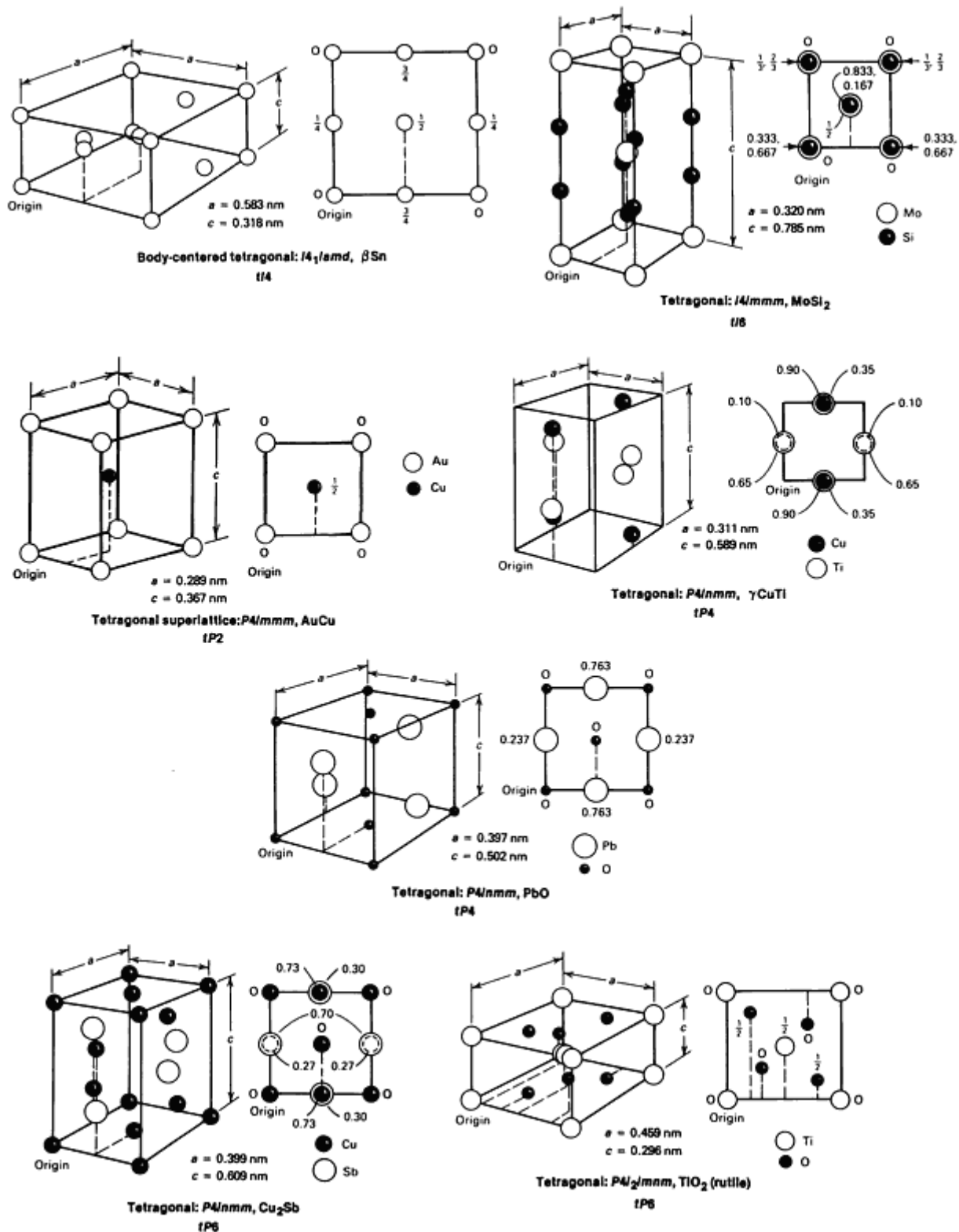

Fig. 22(d) Schematic drawings of the unit cells and ion positions for some simple metal crystals, arranged alphabetically according to Pearson symbol. Also listed are the space lattice and crystal system, space-group notation, and prototype for each crystal. Reported lattice parameters are for the prototype crystal.

Several of the many possible crystal structures are so commonly found in metallic systems that they are often identified by three-letter abbreviations that combine the space lattice with the crystal system. For example, bcc is used for body-centered cubic (two atoms per unit cell), fcc for face-centered cubic (four atoms per unit cell), and cph for close-packed hexagonal (two atoms per unit cell).

Space-group notation is a symbolic description of the space lattice and symmetry of a crystal. It consists of the symbol for the space lattice followed by letters and numbers that designate the symmetry of the crystal. The space-group notation for each unit cell illustrated in Figs. 22(a), 22(b), 22(c), and 22(d) is identified next to it. For a more complete list of Pearson symbols and space-group notations, consult the Appendix.

To assist in classification and identification, each crystal structure type is assigned a representative substance (element or phase) having that structure. The substance selected is called the *structure prototype*. Generally accepted prototypes for some metal crystals are listed in Figs. 22(a), 22(b), 22(c), and 22(d).

An important source of information on crystal structures for many years was *Structure Reports (Strukturbericht* in German). In this publication, crystal structures were classified by a designation consisting of a capital letter (*A* elements, *B* for AB-type phase, *C* for AB₂-type phases, *D* for other binary phases, *E* for ternary phases, and *L* for superlattices), followed by a number consecutively assigned (within each group) at the time the type was reported. To further distinguish among crystal types, inferior letters and numbers, as well as prime marks, were added to some designations. Because the Strukturbericht designation cannot be conveniently and systematically expanded to cover the large variety of crystal structures currently being encountered, the system is falling into disuse.

The relations among common Pearson symbols, space groups, structure prototypes, and Strukturbericht designations for crystal systems are given in various tables in the Appendix. Crystallographic information for the metallic elements can be found in the table of allotropes in the Appendix; data for intermetallic phases of the systems included in this Volume are listed with the phase diagrams. Crystallographic data for an exhaustive list of intermediate phases are presented in 91Vil 20 (see the Bibliography at the end of this Introduction).

Solid-Solution Mechanisms. There are only two mechanisms by which a crystal can dissolve atoms of a different element. If the atoms of the solute element are sufficiently smaller than the atoms comprising the solvent crystal, the solute atoms can fit into the spaces between the larger atoms to form an *interstitial solid solution* (see Fig. 23a). The only solute atoms small enough to fit into the interstices of metal crystals, however, are hydrogen, nitrogen, carbon, and boron. (The other small-diameter atoms, such as oxygen, tend to form compounds with metals rather than dissolve in them.) The rest of the elements dissolve in solid metals by replacing a solvent atom at a lattice point to form a *substitutional solid solution* (see Fig. 23b). When both small and large solute atoms are present, the solid solution can be both interstitial and substitutional. The addition of foreign atoms by either mechanism results in distortion of the crystal lattice and an increase in its internal energy. This distortion energy causes some hardening and strengthening of the alloy, called *solution hardening*. The solvent phase becomes saturated with the solute atoms and reaches its limit of homogeneity when the distortion energy reaches a critical value determined by the thermodynamics of the system.

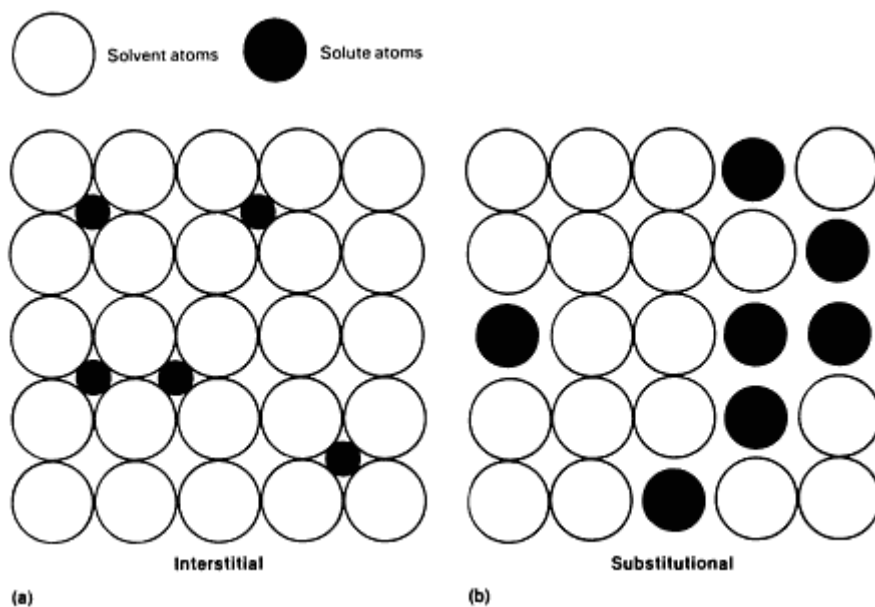

Fig. 23 Solid-solution mechanisms. (a) Interstitial. (b) Substitutional

Reference cited in this section

20. **91Vil:** P. Villars and L.D. Calvert, *Pearson's Handbook of Crystallographic Data for Intermediate Phases*, ASM International, 1991. *This third edition of Pearson's comprehensive compilation includes data from all the international literature from 1913 to 1989.*

Determination of Phase Diagrams

The data used to construct phase diagrams are obtained from a wide variety of measurements, many of which are conducted for reasons other than the determination of phase diagrams. No one research method will yield all of the information needed to construct an accurate diagram, and no diagram can be considered fully reliable without corroborating results obtained from the use of at least one other method.

Knowledge of the chemical composition of the sample and the individual phases is important in the construction of accurate phase diagrams. For example, the samples used should be prepared from high-purity constituents and accurately analyzed.

Chemical analysis is used in the determination of phase-field boundaries by measuring compositions of phases in a sample equilibrated at a fixed temperature by means of such methods as the diffusion-couple technique. The composition of individual phases can be measured by wet chemical methods, electron probe microanalysis, and so on.

Cooling Curves. One of the most widely used methods for the determination of phase boundaries is thermal analysis. The temperature of a sample is monitored while allowed to cool naturally from an elevated temperature (usually in the liquid field). The shape of the resulting curves of temperature versus time are then analyzed for deviations from the smooth curve found for materials undergoing no phase changes (see Fig. 24).

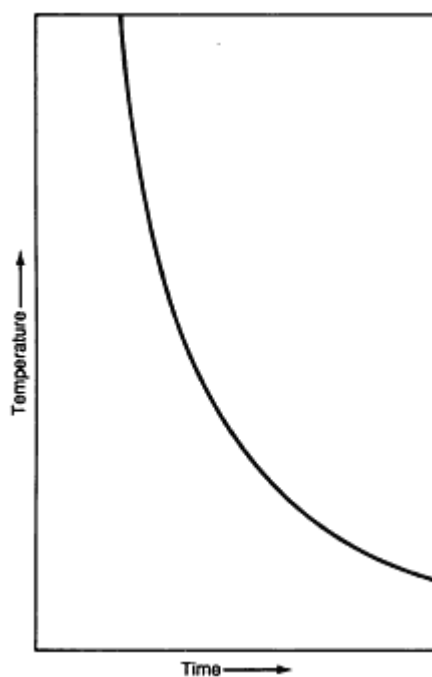

Fig. 24 Ideal cooling curve with no phase change

When a pure element is cooled through its freezing temperature, its temperature is maintained near that temperature until freezing is complete (see Fig. 25). The true freezing/melting temperature, however, is difficult to determine from a cooling curve because of the nonequilibrium conditions inherent in such a dynamic test. This is illustrated in the cooling and heating curves shown in Fig. 26, where the effects of both supercooling and superheating can be seen. The dip in the cooling curve often found at the start of freezing is caused by a delay in the start of crystallization.

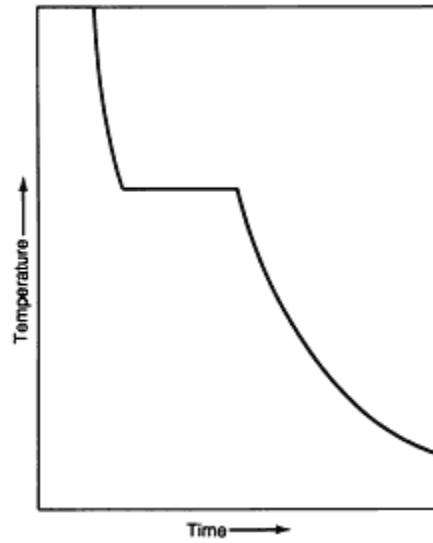

Fig. 25 Ideal freezing curve of a pure metal.

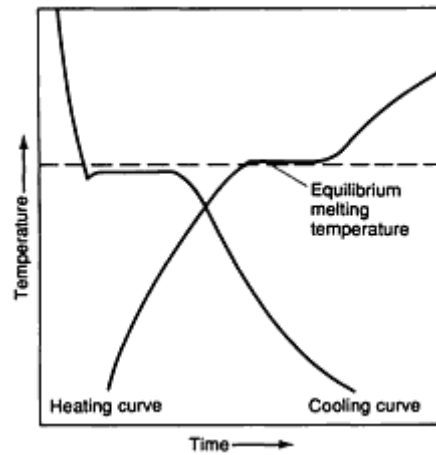

Fig. 26 Natural freezing and melting curves of a pure metal. Source: 56Rhi 3

The continual freezing that occurs during cooling through a two-phase liquid-plus-solid field results in a reduced slope to the curve between the liquidus and solidus temperatures (see Fig. 27). By preparing several samples having compositions across the diagram, the shape of the liquidus curves and the eutectic temperature of eutectic system can be determined (see Fig. 28). Cooling curves can be similarly used to investigate all other types of phase boundaries.

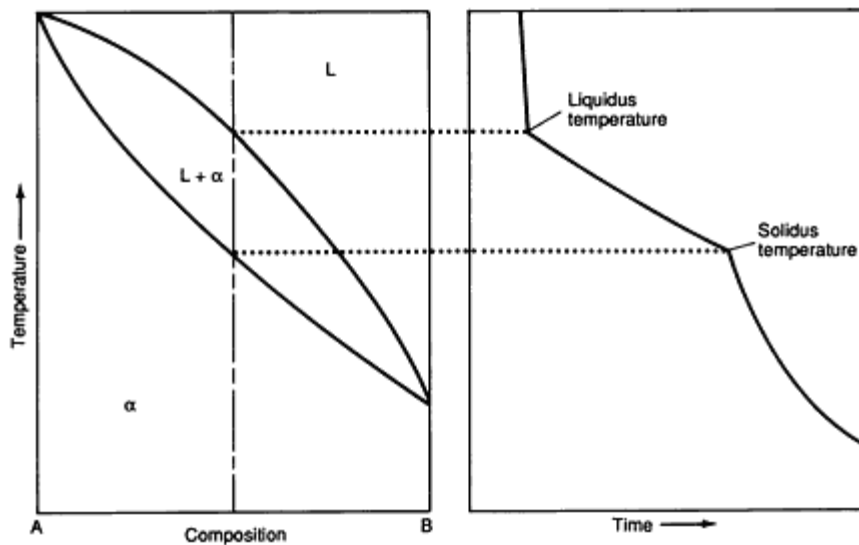

Fig. 27 Ideal freezing curve of a solid-solution alloy

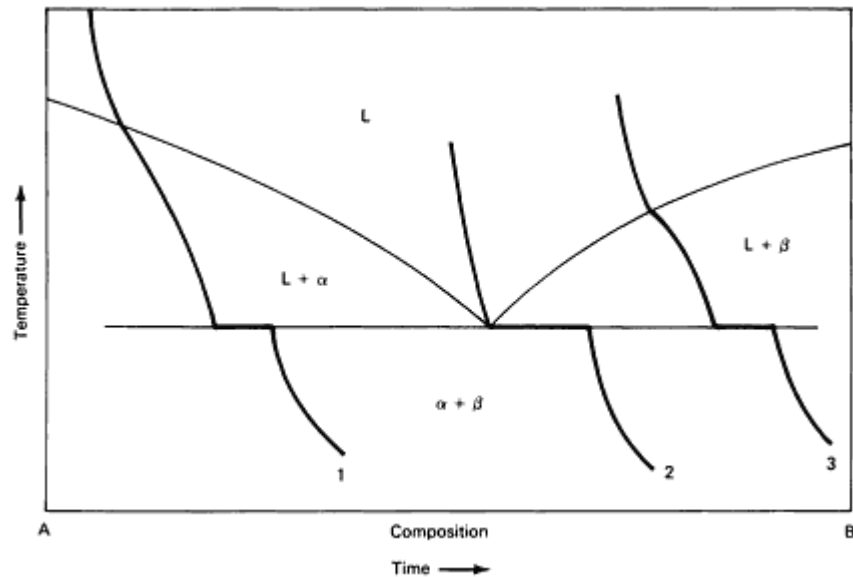

Fig. 28 Ideal freezing curves of (1) a hypoeutectic alloy, (2) a eutectic alloy, and (3) a hypereutectic alloy superimposed on a portion of a eutectic phase diagram. Source: Adapted from 66Pri 4

Differential thermal analysis is a technique used to increase test sensitivity by measuring the difference between the temperature of the sample and a reference material that does not undergo phase transformation in the temperature range being investigated.

Crystal Properties. X-ray diffraction methods are used to determine both crystal structure and lattice parameters of solid phases present in a system at various temperatures (phase identification). Lattice parameter scans across a phase field are useful in determining the limits of homogeneity of the phase; the parameters change with changing composition within the single-phase field, but they remain constant once the boundary is crossed into a two-phase field.

Physical Properties. Phase transformations within a sample are usually accompanied by changes in its physical properties (linear dimensions and specific volume, electrical properties, magnetic properties, hardness, etc.). Plots of these changes versus temperature or composition can be used in a manner similar to cooling curves to locate phase boundaries.

Metallographic Methods. Metallography can be used in many ways to aid in phase diagram determination. The most important problem with metallographic methods is that they usually rely on rapid quenching to preserve (or indicate) elevated-temperature microstructures for room-temperature observation. Hot-stage metallography, however, is an alternative. The application of metallographic techniques is discussed in the section on reading phase diagrams.

Thermodynamic Modeling. Because a phase diagram is a representation of the thermodynamic relationships between competing phases, it is theoretically possible to determine a diagram by considering the behavior of relevant Gibbs energy functions for each phase present in the system and physical models for the reactions in the system. How this can be accomplished is demonstrated for the simple problem of complete solid miscibility shown in Fig. 13. The models required to calculate the possible boundaries in the more complicated diagrams usually encountered are, of course, also more complicated, and involve the use of the equations governing solutions and solution interaction originally developed for physical chemistry. Although modeling alone cannot produce a reliable phase diagram, it is a powerful technique for validating those portions of a phase diagram already derived from experimental data. In addition, modeling can be used to estimate the relations in areas of diagrams where no experimental data exist, allowing much more efficient design of subsequent experiments.

References cited in this section

3. **56Rhi:** F.N. Rhines, *Phase Diagrams in Metallurgy: Their Development and Application*, McGraw-Hill, 1956. *This out-of-print book is a basic text designed for undergraduate students in metallurgy.*
4. **66Pri:** A. Prince, *Alloy Phase Equilibria*, Elsevier, 1966. *This out-of-print book covers the thermodynamic approach to binary, ternary, and quaternary phase diagrams.*

Reading Phase Diagrams

Composition Scales. Phase diagrams to be used by scientists are usually plotted in atomic percentage (or mole fraction), while those to be used by engineers are usually plotted in weight percentage. Conversions between weight and atomic composition also can be made using the equations given in the following section "Composition Conversions" and standard atomic weights listed in the Appendix.

Composition Conversions. The following equations can be used to make conversions in binary systems:

$$\text{wt}\% \text{ A} = \frac{\text{at.\% A} \times \text{at. wt of A}}{(\text{at.\% A} \times \text{at. wt of A}) + (\text{at.\% B} \times \text{at. wt of B})} \times 100$$

$$\text{at.\% A} = \frac{\text{wt}\% \text{ A} / \text{at. wt of A}}{(\text{wt}\% \text{ A} / \text{at. wt of A}) + (\text{wt}\% \text{ B} / \text{at. wt of B})} \times 100$$

The equation for converting from atomic percentages to weight percentages in higher-order systems is similar to that for binary systems, except that an additional term is added to the denominator for each additional component. For ternary systems, for example:

$$\text{wt}\% \text{ A} = \frac{\text{at.\% A} \times \text{at. wt of A}}{(\text{at.\% A} \times \text{at. wt of A}) + (\text{at.\% B} \times \text{at. wt of B}) + (\text{at.\% C} \times \text{at. wt of C})} \times 100$$

$$\text{at.\% A} = \frac{\text{wt}\% \text{ A} / \text{at. wt of A}}{(\text{wt}\% \text{ A} / \text{at. wt of A}) + (\text{wt}\% \text{ B} / \text{at. wt of B}) + (\text{wt}\% \text{ C} / \text{at. wt of C})} \times 100$$

The conversion from weight to atomic percentages for higher-order systems is easy to accomplish on a computer with a spreadsheet program.

Lines and Labels. Magnetic transitions (Curie temperature and Néel temperature) and uncertain or speculative boundaries are usually shown in phase diagrams as nonsolid lines of various types. The components of metallic systems, which usually are pure elements, are identified in phase diagrams by their symbols. (The symbols used for chemical elements are listed in the Appendix.) Allotropes of polymorphic elements are distinguished by small (lower-case) Greek letter prefixes. (The Greek alphabet appears in the Appendix.)

Terminal solid phases are normally designated by the symbol (in parentheses) for the allotrope of the component element, such as (Cr) or (α Ti). Continuous solid solutions are designated by the names of both elements, such as (Cu, Pd) or (β Ti, β Y).

Intermediate phases in phase diagrams are normally labeled with small (lower-case) Greek letters. However, certain Greek letters are conventionally used for certain phases, particularly disordered solutions: for example, β for disordered bcc, ζ or ϵ for disordered cph, γ for the γ -brass-type structure, and σ for the σ CrFe-type structure.

For line compounds, a stoichiometric phase name is used in preference to a Greek letter (for example, A_2B_3 rather than δ). Greek letter prefixes are used to indicate high- and low-temperature forms of the compound (for example, αA_2B_3 for the low-temperature form and βA_2B_3 for the high-temperature form).

Lever Rule. As explained in the section on the features of phase diagrams, a tie line is an imaginary horizontal line drawn in a two-phase field connecting two points that represent two coexisting phases in equilibrium at the temperature indicated by the line. Tie lines can be used to determine the fractional amounts of the phases in equilibrium by employing the *lever rule*. The lever rule is a mathematical expression derived by the principle of conservation of matter in which the phase amounts can be calculated from the bulk composition of the alloy and compositions of the conjugate phases, as shown in Fig. 29(a).

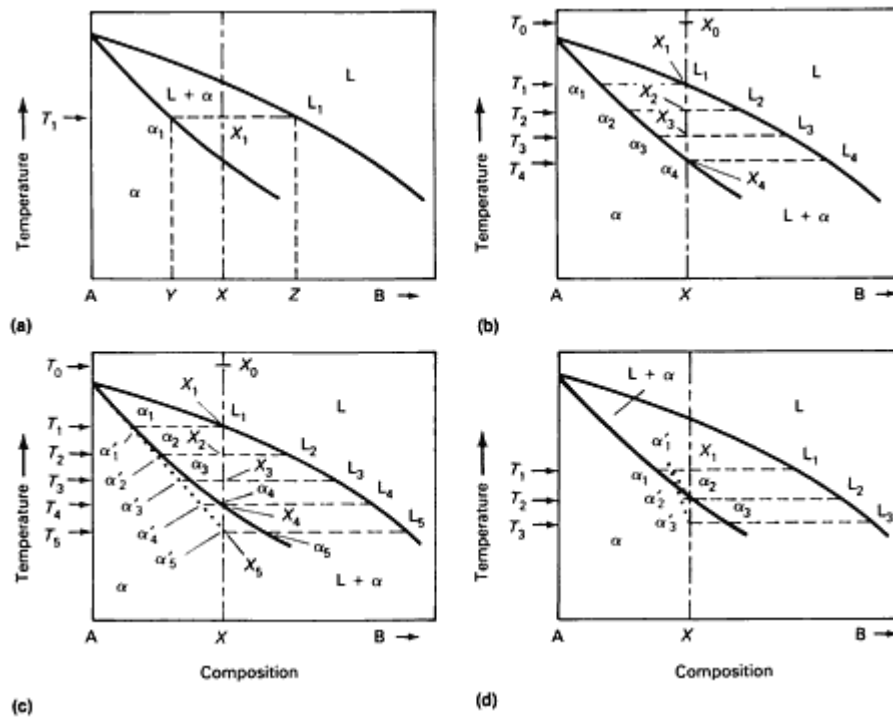

Fig. 29 Portion of a binary phase diagram containing a two-phase liquid-plus-solid field illustrating (a) the lever rule and its application to (b) equilibrium freezing, (c) nonequilibrium freezing and (d) heating of a homogenized sample. Source: 56Rhi 3

At the left end of the line between α_1 and L_1 , the bulk composition is $Y\%$ component B and $100 - Y\%$ component A, and consists of 100% α solid solution. As the percentage of component B in the bulk composition moves to the right, some liquid appears along with the solid. With further increases in the amount of B in the alloy, more of the mixture consists of liquid until the material becomes entirely liquid at the right end of the tie line. At bulk composition X , which is less than halfway to point L_1 , there is more solid present than liquid. According to the lever rule, the percentages of the two phases present can be calculated as follows:

$$\% \text{ liquid} = \frac{\text{length of line } \alpha_1 X_1}{\text{length of line } \alpha_1 L_1} \times 100$$

$$\% \text{ solid } \alpha = \frac{\text{length of line } X_1 L_1}{\text{length of line } \alpha_1 L_1} \times 100$$

It should be remembered that the calculated amounts of the phases present are either in weight or atomic percentages and do not directly indicate the area or volume percentages of the phases observed in microstructures.

Volume Fraction. In order to relate the weight fraction of a phase present in an alloy specimen as determined from a phase diagram to its two-dimensional appearance as observed in a micrograph, it is necessary to be able to convert between weight-fraction values and areal-fraction values, both in decimal fractions. This conversion can be developed as follows. The weight fraction of the phase is determined from the phase diagram, using the lever rule.

$$\text{Volume portion of the phase} = \frac{\text{weight fraction of the phase}}{\text{phase density}}$$

Total volume of all phases present = sum of the volume portions of each phase.

$$\text{Volume fraction of the phase} = \frac{\text{weight fraction of the phase}}{\text{phase density} \times \text{total volume}}$$

It has been shown by stereology and quantitative metallography that areal fraction is equal to volume fraction [85ASM 13]. (Areal fraction of a phase is the sum of areas of the phase intercepted by a microscopic traverse of the observed region of the specimen divided by the total area of the observed region.) Therefore:

$$\text{Areal fraction of the phase} = \frac{\text{weight fraction of the phase}}{\text{phase density} \times \text{total volume}}$$

The phase density value for the preceding equation can be obtained by measurement or calculation. The densities of chemical elements, and some line compounds, can be found in the literature. Alternatively, the density of a unit cell of a phase comprising one or more elements can be calculated from information about its crystal structure and the atomic weights of the elements comprising it as follows:

$$\text{Weight of each element} = \text{number of atoms} \times \frac{\text{atomic weight}}{\text{Avogadro's number}}$$

Total cell weight = sum of weights of each element

Density = total cell weight/cell volume

For example, the calculated density of pure copper, which has a fcc structure and a lattice parameter of 0.36146 nm, is:

$$\rho = \frac{4 \text{ atoms/cell} \times 63.546 \text{ g/mol}}{6.0227 \times 10^{23} \text{ atoms/mol} \times (0.36146 \times 10^{-9} \text{ m})^3} = 8.937 \text{ Mg/m}^3$$

This compares favorably with the published value of 8.93.

Phase-Fraction Lines. Reading the phase relationships in many ternary diagram sections (and other types of sections) often can be difficult because of the great many lines and areas present. *Phase-fraction lines* are used by some to simplify this task. In this approach, the sets of often non-parallel tie lines in the two-phase fields of isothermal sections (see Fig. 30a) are replaced with sets of curving lines of equal phase fraction (Fig. 30b). Note that the phase-fraction lines extend through the three-phase region, where they appear as a triangular network. As with tie lines, the number of phase-fraction lines used is up to the individual using the diagram. Although this approach to reading diagrams may not seem helpful for such a simple diagram, it can be useful aid in more complicated systems. For more information on this topic, see 84Mor 12 and 91Mor 17.

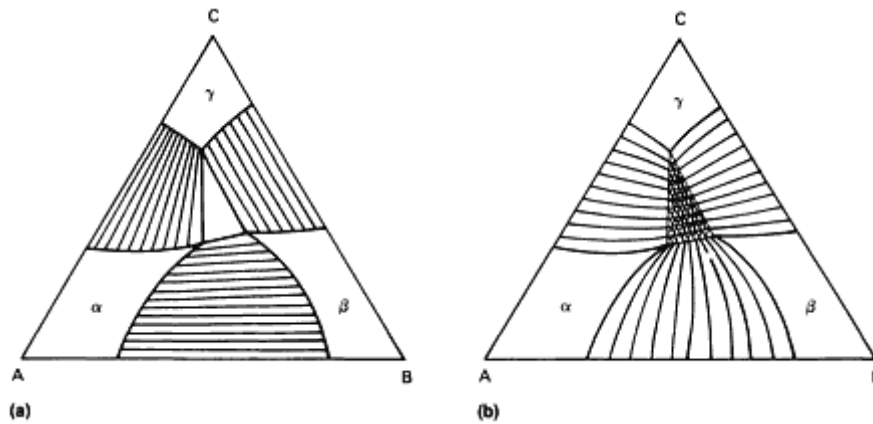

Fig. 30 Alternative systems for showing phase relationships in multiphase regions of ternary diagram isothermal sections. (a) Tie lines. (b) Phase-fraction lines. Source: 84Mor 12

Solidification. Tie lines and the lever rule can be used to understand the freezing of a solid-solution alloy. Consider the series of tie lines at different temperatures shown in Fig. 29(b), all of which intersect the bulk composition X. The first crystals to freeze have the composition α_1 . As the temperature is reduced to T_2 and the solid crystals grow, more A atoms are removed from the liquid than B atoms, thus shifting the composition of the remaining liquid to L_2 . Therefore, during freezing, the compositions of both the layer of solid freezing out on the crystals and the remaining liquid continuously shift to higher B contents and become leaner in A. Therefore, for equilibrium to be maintained, the solid crystals must absorb B atoms from the liquid and B atoms must migrate (diffuse) from the previously frozen material into subsequently deposited layers. When this happens, the average composition of the solid material follows the solidus line to temperature T_4 , where it equals the bulk composition of the alloy.

Coring. If cooling takes place too rapidly for maintenance of equilibrium, the successive layers deposited on the crystals will have a range of local compositions from their centers to their edges (a condition known as *coring*). The development of this condition is illustrated in Fig. 29(c). Without diffusion of B atoms from the material that solidified at temperature T_1 into the material freezing at T_2 , the average composition of the solid formed up to that point will not follow the solidus line. Instead it will remain to the left of the solidus, following compositions α'_1 through α'_5 . Note that final freezing does not occur until temperature T_5 , which means that nonequilibrium solidification takes place over a greater temperature range than equilibrium freezing. Because most metals freeze by the formation and growth of "treelike" crystals, called *dendrites*, coring is sometimes called *dendritic segregation*. An example of cored dendrites is shown in Fig. 31.



Fig. 31 Copper alloy C71500 (copper nickel, 30%) ingot. Dendritic structure shows coring: light areas are nickel rich; dark areas are low in nickel. 20 \times . Source: 85ASM 13

Liquation. Because the lowest freezing material in a cored microstructure is segregated to the edges of the solidifying crystals (the grain boundaries), this material can remelt when the alloy sample is heated to temperatures below the equilibrium solidus line. If grain-boundary melting (called *liquation*, or "burning") occurs while the sample also is under

stress, such as during hot forming, the liquefied grain boundaries will rupture and the sample will lose its ductility and be characterized as *hot short*.

Liquation also can have a deleterious effect on the mechanical properties (and microstructure) of the sample after it returns to room temperature. This is illustrated in Fig. 29(d) for a homogenized sample. If homogenized alloy X is heated into the liquid-plus-solid region for some reason (inadvertently or during welding, etc.), it will begin to melt when it reaches temperature T_2 ; the first liquid to appear will have the composition L_2 . When the sample is heated at normal rates to temperature T_1 , the liquid formed so far will have a composition L_1 , but the solid will not have time to reach the equilibrium composition α_1 . The average composition will instead lie at some intermediate value, such as α'_1 . According to the lever rule, this means that less than the equilibrium amount of liquid will form at this temperature. If the sample is then rapidly cooled from temperature T_1 , solidification will occur in the normal manner, with a layer of material having composition α_1 deposited on existing solid grains. This is followed by layers of increasing B content up to composition α_3 at temperature T_3 , where all of the liquid is converted to solid. This produces coring in the previously melted regions along the grain boundaries, and sometimes even voids that decrease the strength of the sample. Homogenization heat treatment will eliminate the coring, but not the voids.

Eutectic Microstructures. When an alloy of eutectic composition (such as alloy 2 in Fig. 28) is cooled from the liquid state, the eutectic reaction occurs at the eutectic temperature, where the two distinct liquidus curves meet. At this temperature, both α and β solid phases must deposit on the grain nuclei until all of the liquid is converted to solid. This simultaneous deposition results in microstructures made up of distinctively shaped particles of one phase in a matrix of the other phase, or alternate layers of the two phases. Examples of characteristic eutectic microstructures include spheroidal, nodular, or globular; acicular (needles) or rod; and lamellar (platelets, Chinese script or dendritic, or filigreed). Each eutectic alloy has its own characteristic microstructure when slowly cooled (see Fig. 32). More rapid cooling, however, can affect the microstructure obtained (see Fig. 33). Care must be taken in characterizing eutectic structures, because elongated particles can appear nodular and flat platelets can appear elongated or needlelike when viewed in cross section.

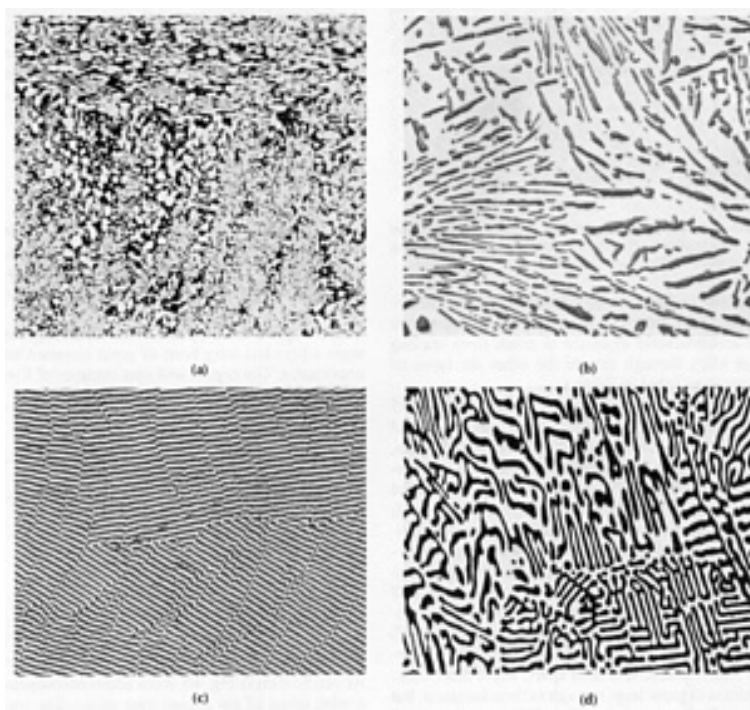

Fig. 32 Examples of characteristic eutectic microstructures in slowly cooled alloys. (a) 50Sn-50In alloy showing globules of tin-rich intermetallic phase (light) in a matrix of dark indium-rich intermetallic phase. 150 \times . (b) Al-13Si alloy showing an acicular structure consisting of short, angular particles of silicon (dark) in a matrix of aluminum. 200 \times . (c) Al-33Cu alloy showing a lamellar structure consisting of dark platelets of CuAl_2 and light platelets of aluminum solid solution. 180 \times . (d) Mg-37Sn alloy showing a lamellar structure consisting of Mg_2Sn "Chinese script" (dark) in a matrix of magnesium solid solution. 250 \times . Source: 85ASM 13

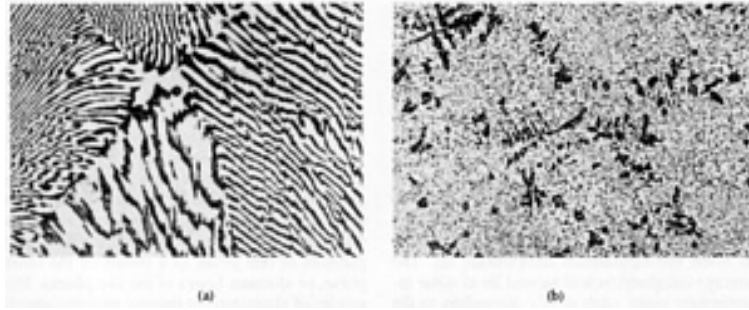

Fig. 33 Effect of cooling rate on the microstructure of Sn-37Pb alloy (eutectic soft solder). (a) Slowly cooled sample shows a lamellar structure consisting of dark platelets of lead-rich solid solution and light platelets of tin. 375 \times . (b) More rapidly cooled sample shows globules of lead-rich solid solution, some of which exhibit a slightly dendritic structure, in a matrix of tin. 375 \times . Source: 85ASM 13

If the alloy has a composition different from the eutectic composition (such as alloy 1 or 3 in Fig. 28), the alloy will begin to solidify before the eutectic temperature is reached. If the alloy is hypoeutectic (such as alloy 1), some dendrites of α will form in the liquid before the remaining liquid solidifies at the eutectic temperature. If the alloy is hypereutectic (such as alloy 3), the first (primary) material to solidify will be dendrites of β . The microstructure produced by slow cooling of a hypoeutectic and hypereutectic alloy will consist of relatively large particles of *primary constituent*, consisting of the phase that begins to freeze first surrounded by relatively fine eutectic structure. In many instances, the shape of the particles will show a relationship to their dendritic origin (see Fig. 34a). In other instances, the initial dendrites will have filled out somewhat into *idiomorphic particles* (particles having their own characteristic shape) that reflect the crystal structure of the phase (see Fig. 34b).

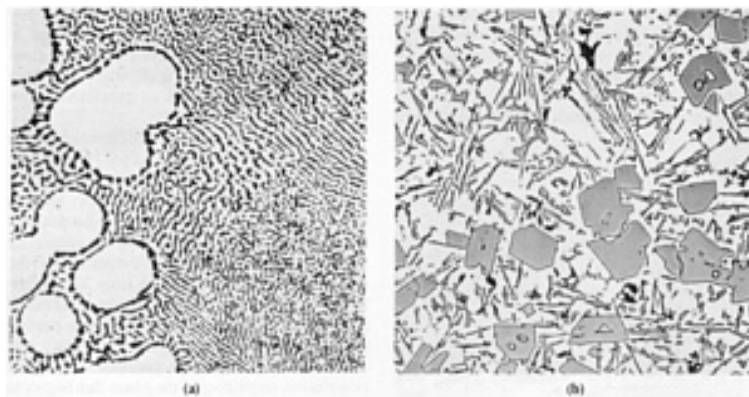

Fig. 34 Examples of primary particle shape. (a) Sn-30Pb hypoeutectic alloy showing dendritic particles of tin-rich solid solution in a matrix of tin-lead eutectic. 500 \times . (b) Al-19Si hypereutectic alloy, phosphorus-modified, showing idiomorphic particles of silicon in a matrix of aluminum-silicon eutectic. 100 \times . Source: 85ASM 13

As stated earlier, cooling at a rate that does not allow sufficient time to reach equilibrium conditions will affect the resulting microstructure. For example, it is possible for an alloy in a eutectic system to obtain some eutectic structure in an alloy outside the normal composition range for such a structure. This is illustrated in Fig. 35. With relatively rapid cooling of alloy X, the composition of the solid material that forms will follow line $\alpha_1-\alpha'_4$ rather than the solidus line to α_4 . As a result, the last liquid to solidify will have the eutectic composition L_4 , rather than L_3 , and will form some eutectic structure in the microstructure. The question of what takes place when the temperature reaches T_5 is discussed later.

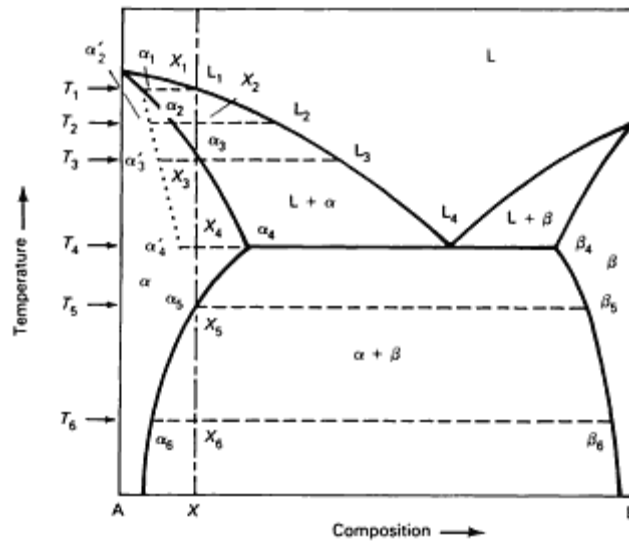

Fig. 35 Schematic binary phase diagram, illustrating the effect of cooling rate on an alloy lying outside the equilibrium eutectic transformation line. Rapid solidification into a terminal phase field can result in some eutectic structure being formed; homogenization at temperatures in the single-phase field will eliminate the eutectic structure; β phase will precipitate out of solution upon slow cooling into the α -plus- β field. Source: Adapted from 56Rhi 3

Eutectoid Microstructures. Because the diffusion rates of atoms are so much lower in solids than in liquids, nonequilibrium transformation is even more important in solid/solid reactions (such as the eutectoid reaction) than in liquid/solid reactions (such as the eutectic reaction). With slow cooling through the eutectoid temperature, most alloys of eutectoid composition, such as alloy 2 in Fig. 36, transform from a single-phase microstructure to a lamellar structure consisting of alternate platelets of α and β arranged in groups (or "colonies"). The appearance of this structure is very similar to lamellar eutectic structure (see Fig. 37). When found in cast irons and steels, this structure is called "pearlite" because of its shiny mother-of-pearl appearance under the microscope (especially under oblique illumination); when similar eutectoid structure is found in nonferrous alloys, it often is called "pearlite-like" or "pearlitic."

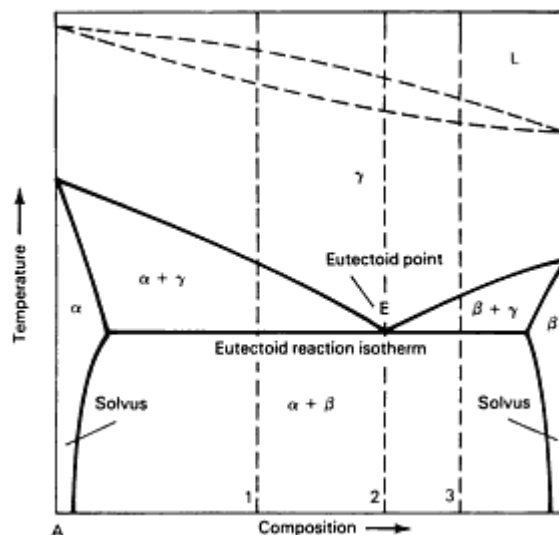

Fig. 36 Schematic binary phase diagram of a eutectoid system. Source: Adapted from 56Rhi 3

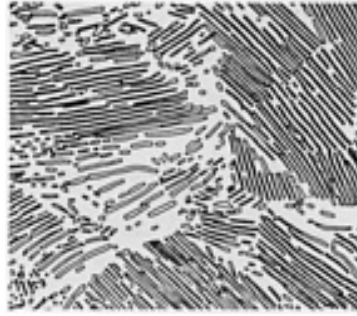

Fig. 37 Fe-0.8C alloy showing a typical pearlite eutectoid structure of alternate layers of light ferrite and dark cementite. 500 \times . Source: 85ASM 13

The terms *hypo*eutectoid and *hyper*eutectoid have the same relationship to the eutectoid composition as hypoeutectic and hypereutectic do in a eutectic system; alloy 1 in Fig. 36 is a hypoeutectoid alloy, whereas alloy 3 is hypereutectoid. The solid-state transformation of such alloys takes place in two steps, much like the freezing of hypoeutectic and hypereutectic alloys, except that the microconstituents that form before the eutectoid temperature is reached are referred to as *proeutectoid constituents* rather than "primary."

Microstructures of Other Invariant Reactions. Phase diagrams can be used in a manner similar to that described in the discussion of eutectic and eutectoid reactions to determine the microstructures expected to result from cooling an alloy through any of the other six types of reactions listed in Table 1.

Solid-State Precipitation. If alloy X in Fig. 35 is homogenized at a temperature between T_3 and T_5 , it will reach an equilibrium condition; that is, the β portion of the eutectic constituent will dissolve and the microstructure will consist solely of α grains. Upon cooling below temperature T_5 , this microstructure will no longer represent equilibrium conditions, but instead will be supersaturated with B atoms. In order for the sample to return to equilibrium, some of the B atoms will tend to congregate in various regions of the sample to form colonies of new β material. The B atoms in some of these colonies, called *Guinier-Preston zones*, will drift apart, while other colonies will grow large enough to form incipient, but not distinct, particles. The difference in crystal structures and lattice parameters between the α and β phases causes lattice strain at the boundary between the two materials, thereby raising the total energy level of the sample and hardening and strengthening it. At this stage, the incipient particles are difficult to distinguish in the microstructure. Instead, there usually is only a general darkening of the structure. If sufficient time is allowed, the β regions will break away from their host grains of α and precipitate as distinct particles, thereby relieving the lattice strain and returning the hardness and strength to the former levels. This process is illustrated for a simple eutectic system, but it can occur wherever similar conditions exist in a phase diagram; that is, there is a range of alloy compositions in the system for which there is a transition on cooling from a single-solid region to a region that also contains a second solid phase, and where the boundary between the regions slopes away from the composition line as cooling continues. Several examples of such systems are shown schematically in Fig. 38.

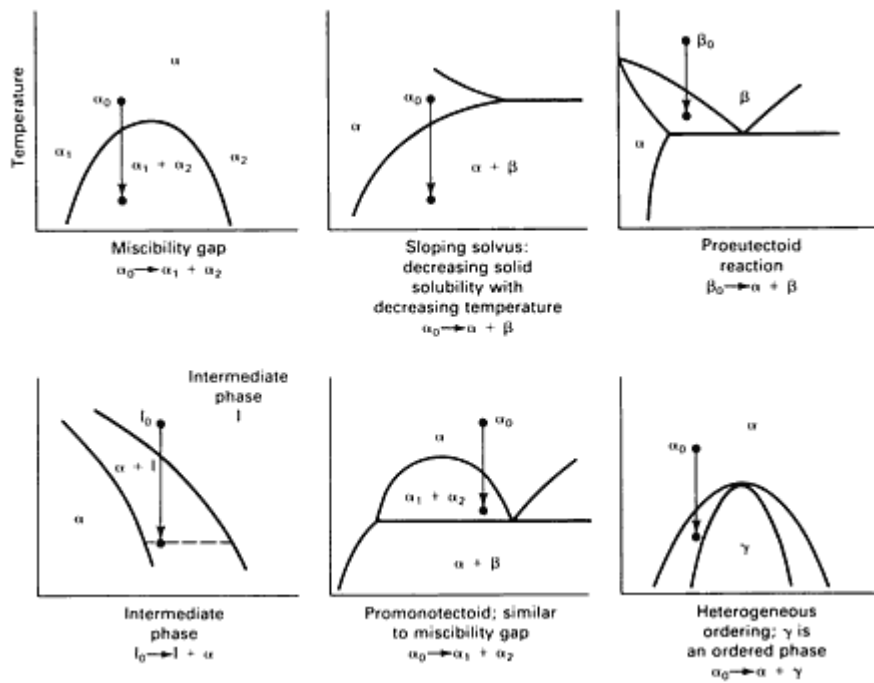

Fig. 38 Examples of binary phase diagrams that give rise to precipitation reactions. Source: 85ASM 13

Although this entire process is called *precipitation hardening*, the term normally refers only to the portion before much actual precipitation takes place. Because the process takes some time, the term *age hardening* is often used instead. The rate at which aging occurs depends on the level of supersaturation (how far from equilibrium), the amount of lattice strain originally developed (amount of lattice mismatch), the fraction left to be relieved (how far along the process has progressed), and the aging temperature (the mobility of the atoms to migrate). The β precipitate usually takes the form of small idiomorphic particles situated along the grain boundaries and within the grains of α phase. In most instances, the particles are more or less uniform in size and oriented in a systematic fashion. Examples of precipitation microstructures are shown in Fig. 39.

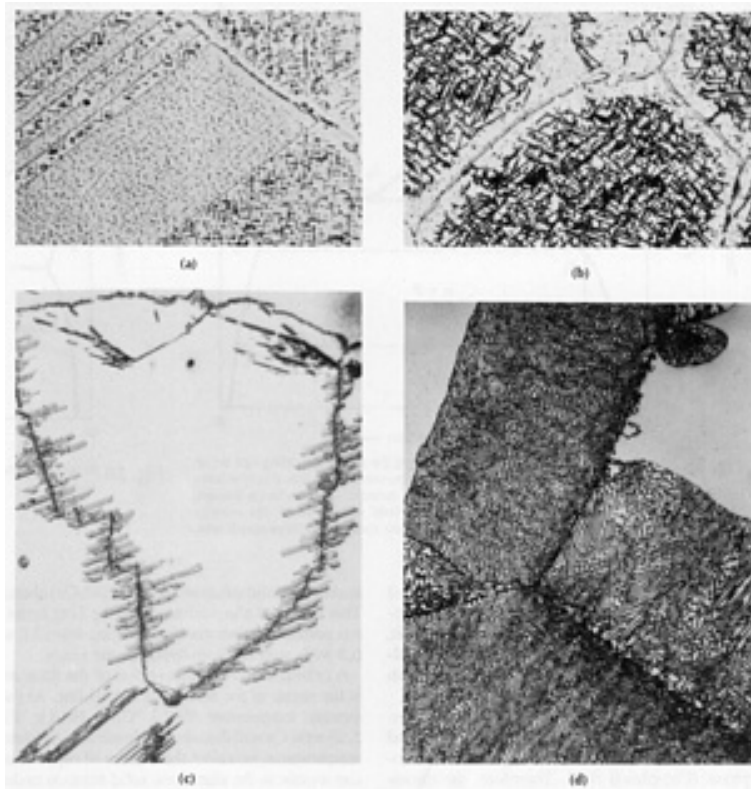

Fig. 39 Examples of characteristic precipitation microstructures. (a) General and grain-boundary precipitation of Co_3Ti (γ' phase) in a Co-12Fe-6Ti alloy aged 3×10^3 min at 800°C (1470°F). $1260\times$. (b) General precipitation (intragranular Widmanstätten) and localized grain-boundary precipitation in an Al-18Ag alloy aged 90 h at 375°C (710°F), with a distinct precipitation-free zone near the grain boundaries. $500\times$. (c) Preferential, or localized, precipitation along grain boundaries in a Ni-20Cr-1Al alloy. $500\times$. (d) Cellular, or discontinuous, precipitation growing out uniformly from the grain boundaries in an Fe-24.8Zn alloy aged 6 min at 600°C (1110°F). $1000\times$. Source: 85ASM 13

References cited in this section

3. **56Rhi:** F.N. Rhines, *Phase Diagrams in Metallurgy: Their Development and Application*, McGraw-Hill, 1956. *This out-of-print book is a basic text designed for undergraduate students in metallurgy.*
12. **84Mor:** J.E. Morral, Two-Dimensional Phase Fraction Charts, *Scr. Metall.*, Vol 18 (No. 4), 1984, p 407-410. *Gives a general description of phase-fraction charts.*
13. **85ASM:** *Metals Handbook*, 9th ed., Vol 9, *Metallography and Microstructures*, American Society for Metals, 1985. *A comprehensive reference covering terms and definitions, metallographic techniques, microstructures of industrial metals and alloys, and principles of microstructures and crystal structures.*
17. **91Mor:** J.E. Morral and H. Gupta, Phase Boundary, ZPF, and Topological Lines on Phase Diagrams, *Scr. Metall.*, Vol 25 (No. 6), 1991, p 1393-1396. *Reviews three different ways of considering the lines on a phase diagram.*

Examples of Phase Diagrams

The general principles of reading alloy phase diagrams are discussed in the preceding section. The application of these principles to actual diagrams for typical alloy systems is illustrated below.

The Copper-Zinc System. The metallurgy of brass alloys has long been of great commercial importance. The copper and zinc contents of five of the most common wrought brasses are:

UNS No.	Common name	Zinc content, wt%	
		Nominal	Range
C23000	Red brass, 85%	15	14.0-16.0
C24000	Low brass, 80%	20	18.5-21.5
C26000	Cartridge brass, 70%	30	28.5-31.5
C27000	Yellow brass, 65%	35	32.5-37.0

As can be seen in Fig. 40, these alloys encompass a wide range of the copper-zinc phase diagram. The alloys on the high-copper end (red brass, low brass, and cartridge brass) lie within the copper solid-solution phase field and are called alpha brasses after the old designation for this field. As expected, the microstructure of these brasses consists solely of grains of copper solid solution (see Fig. 41 a). The strain on the copper crystals caused by the presence of the zinc atoms, however, produces solution hardening in the alloys. As a result, the strength of the brasses, in both the work-hardened and the annealed conditions, increases with increasing zinc content.

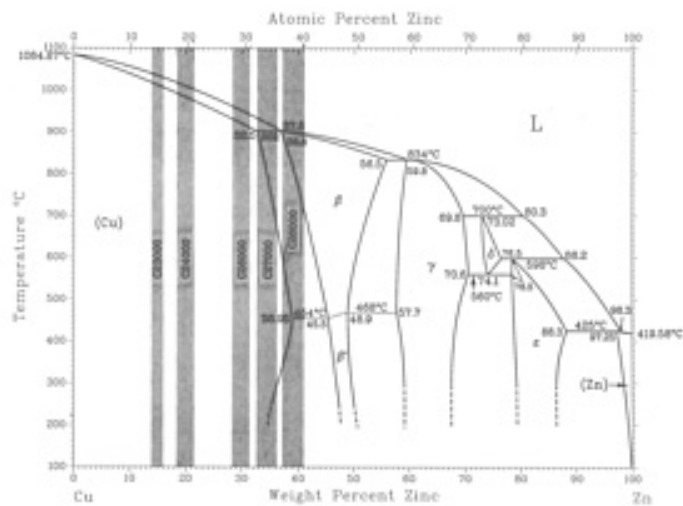

Fig. 40 The copper-zinc phase diagram, showing the composition range for five common brasses. Source: Adapted from 90Mas 15.

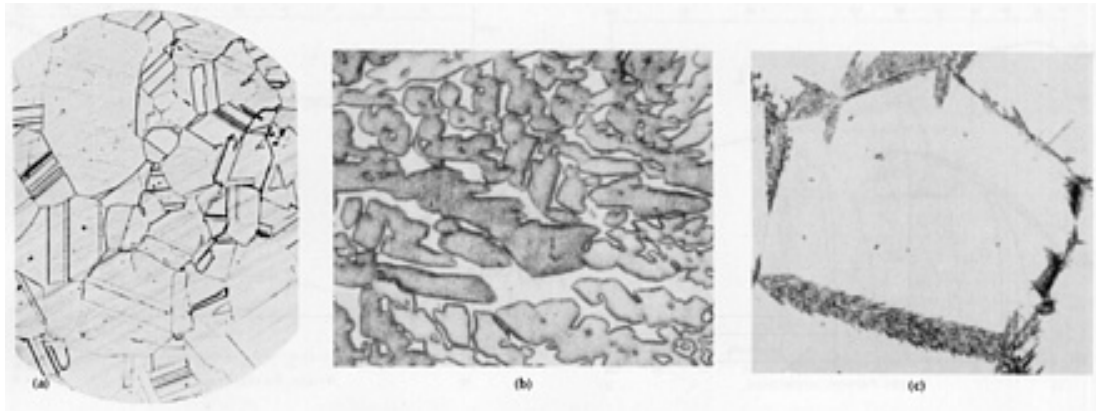

Fig. 41 The microstructures of two common brasses. (a) C26000 (cartridge brass, 70%), hot rolled, annealed, cold rolled 70%, and annealed at 638 °C (1180 °F), showing equiaxed grains of copper solid solution. Some grains are twinned. 75×. (b) C28000 (Muntz metal, 60%) ingot, showing dendrites of copper solid solution in a matrix of β . 200×. (c) C28000 (Muntz metal, 60%), showing feathery copper solid solution that formed at β grain boundaries during quenching of the all- β structure. 100×. Source: 85ASM 13

The composition range for those brasses containing higher amounts of zinc (yellow brass and Muntz metal), however, overlaps into the two-phase (Cu)-plus- β field. Therefore, the microstructure of these so-called alpha-beta alloys shows various amounts of β phase (see Fig. 41b and c), and their strengths are further increased over those of the alpha brasses.

The Aluminum-Copper System. Another alloy system of great commercial importance is aluminum-copper. Although the phase diagram of this system is fairly complicated (see Fig. 42), the alloys of concern in this discussion are limited to the region at the aluminum side of the diagram where a simple eutectic is formed between the aluminum solid solution and the θ (Al_2Cu) phase. This family of alloys (designated the 2xxx series) has nominal copper contents ranging from 2.3 to 6.3 wt%, making them hypoeutectic alloys.

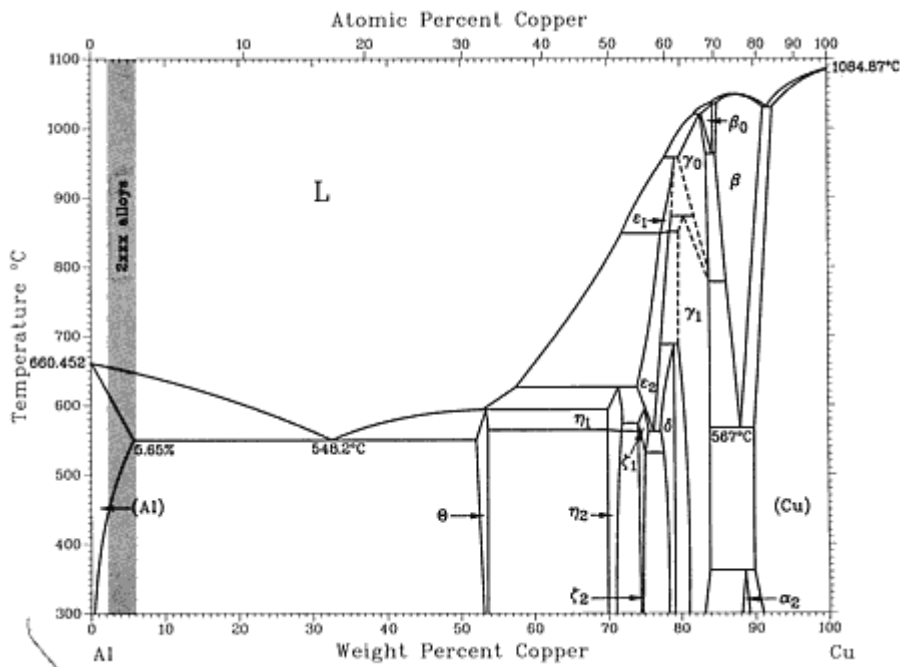

Fig. 42 The aluminum-copper phase diagram, showing the composition range for the 2xxx series of precipitation-hardenable aluminum alloys. Source: 90Mas 15

A critical feature of this region of the diagram is the shape of the aluminum solvus line. At the eutectic temperature (548.2 °C, or 1018.8 °F), 5.65 wt% Cu will dissolve in aluminum. At lower temperatures, however, the amount of copper that can remain in the aluminum solid solution under equilibrium conditions drastically decreases, reaching less than 1% at room temperature. This is the typical shape of the solvus line for precipitation hardening; if any of these alloys are homogenized at temperatures in or near the solid-solution phase field, they can be strengthened by aging at a substantially lower temperature.

The Titanium-Aluminum, Titanium-Chromium, and Titanium-Vanadium Systems. The phase diagrams of titanium systems are dominated by the fact that there are two allotropic forms of solid titanium: cph α Ti is stable at room temperature and up to 882 °C (1620 °F); bcc β Ti is stable from 882 °C (1620 °F) to the melting temperature. Most alloying elements used in commercial titanium alloys can be classified as alpha stabilizers (such as aluminum) or beta stabilizers (such as vanadium and chromium), depending on whether the allotropic transformation temperature is raised or lowered by the alloying addition (see Fig. 43). Beta stabilizers are further classified as those that are completely miscible with β Ti (such as vanadium, molybdenum, tantalum, and niobium) and those that form eutectoid systems with titanium (such as chromium and iron). Tin and zirconium also are often alloyed in titanium, but instead of stabilizing either phase, they have extensive solubilities in both α Ti and β Ti. The microstructures of commercial titanium alloys are complicated, because most contain more than one of these four types of alloying elements.

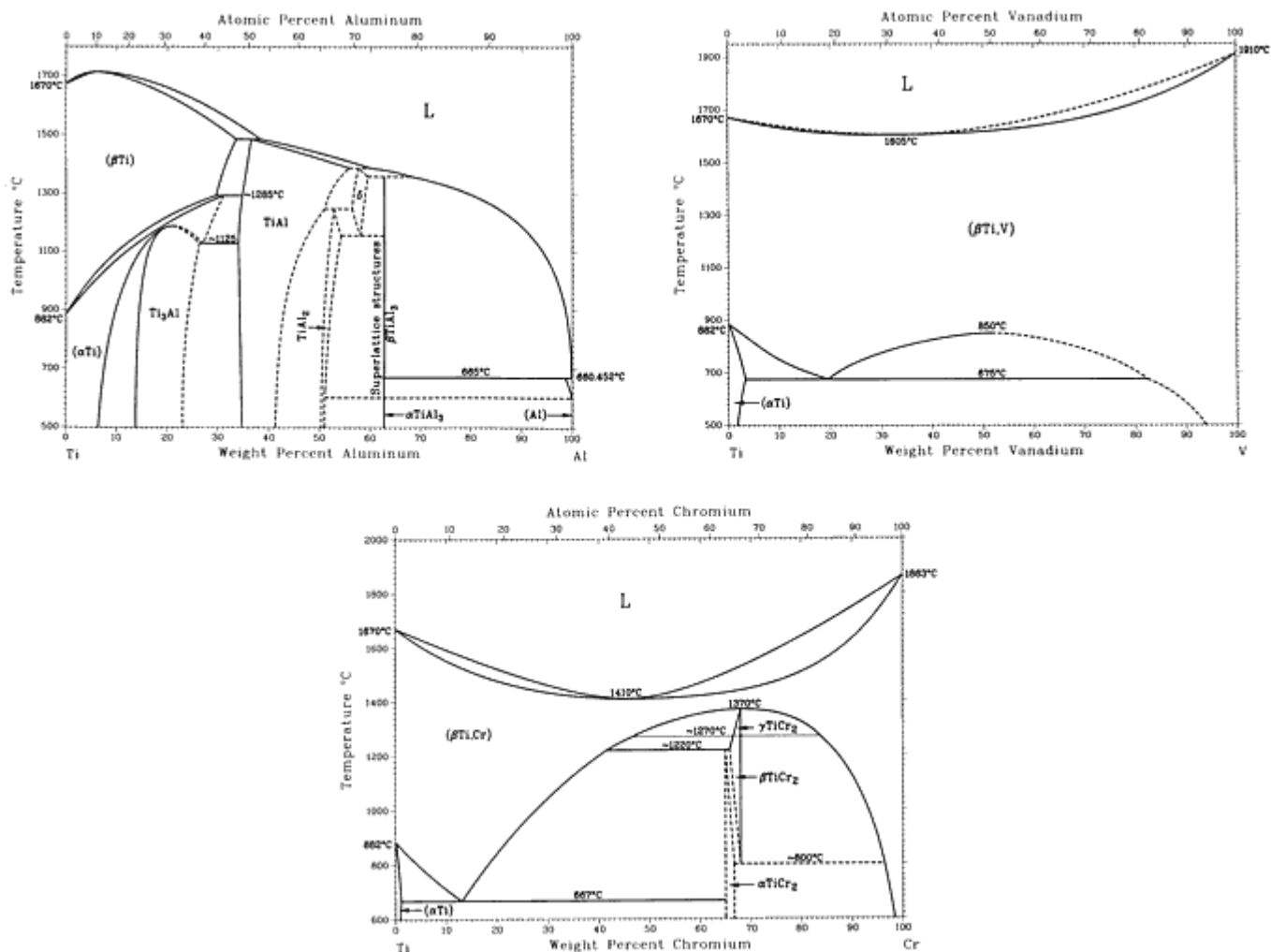

Fig. 43 Three representative binary titanium phase diagrams, showing alpha stabilization (Ti-Al), beta stabilization with complete miscibility (Ti-V), and beta stabilization with a eutectoid reaction (Ti-Cr). Source: 90Mas 15

The Iron-Carbon System. The iron-carbon diagram maps out the stable equilibrium conditions between iron and the graphitic form of carbon (see Fig. 44). Note that there are three allotropic forms of solid iron: the low-temperature phase,

α ; the medium-temperature phase, γ ; and the high-temperature phase, δ . In addition, ferritic iron undergoes a magnetic phase transition at 771 °C (1420 °F) between the low-temperature ferro-magnetic state and the higher-temperature paramagnetic state. The common name for bcc α -iron is "ferrite" (from *ferrum*, Latin for "iron"); the fcc γ phase is called "austenite" after William Roberts-Austen; bcc δ -iron is also commonly called ferrite, because (except for its temperature range) it is the same as α -iron. The main feature of the iron-carbon diagram is the presence of both a eutectic and a eutectoid reaction, along with the great difference between the solid solubilities of carbon in ferrite and austenite. It is these features that allow such a wide variety of microstructures and mechanical properties to be developed in iron-carbon alloys through proper heat treatment.

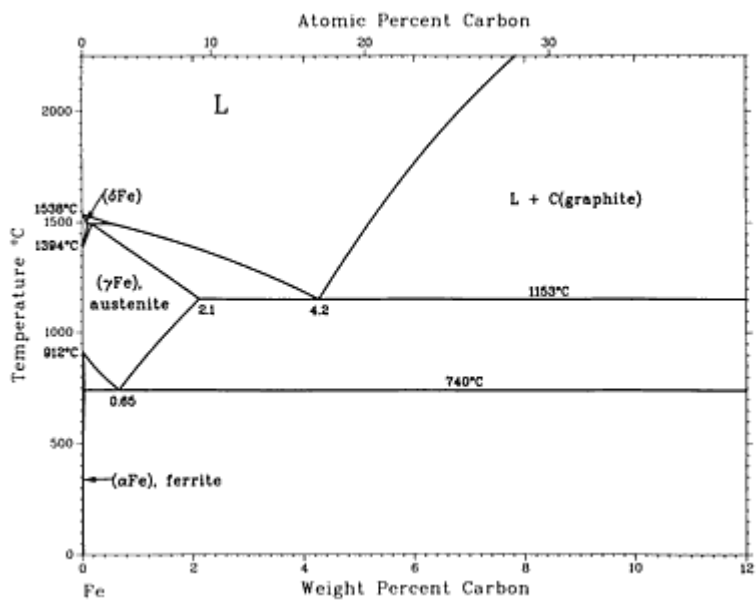

Fig. 44 The iron-carbon phase diagram. Source: Adapted from 90Mas 15

The Iron-Cementite System. In the solidification of steels, stable equilibrium conditions do not exist. Instead, any carbon not dissolved in the iron is tied up in the form of the metastable intermetallic compound, Fe_3C (also called cementite because of its hardness), rather than remaining as free graphite (see Fig. 45). It is, therefore, the iron-cementite phase diagram, rather than the iron-carbon diagram, that is important to industrial metallurgy. It should be remembered, however, that although cementite is an extremely enduring phase, given sufficient time, or the presence of a catalyzing substance, it will break down to iron and carbon. In cast irons, silicon is the catalyzing agent that allows free carbon (flakes, nodules, etc.) to appear in the microstructure (see Fig. 46).

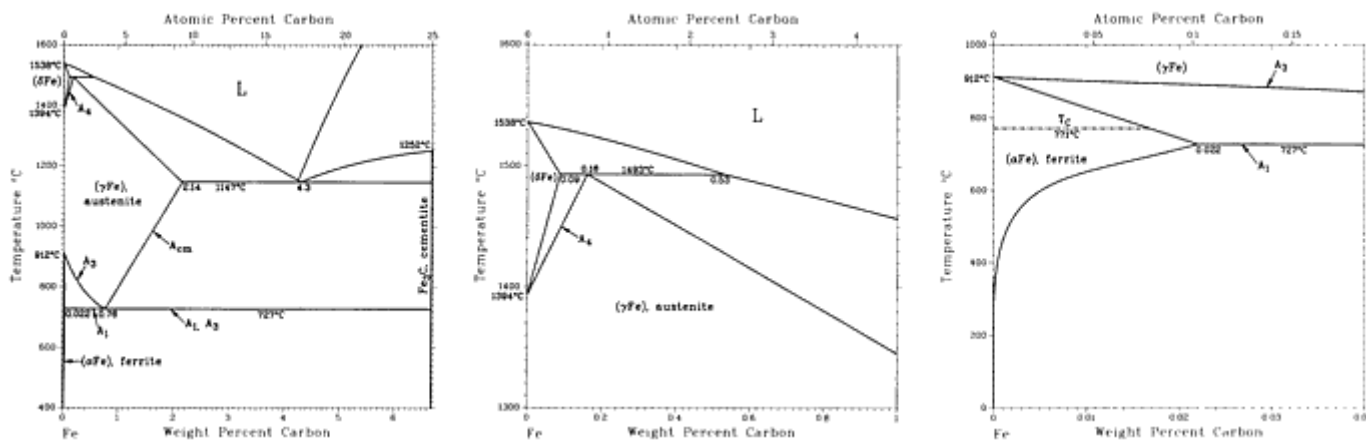

Fig. 45 The iron-cementite phase diagram and details of the (δ Fe) and (α Fe) phase fields. Source: Adapted

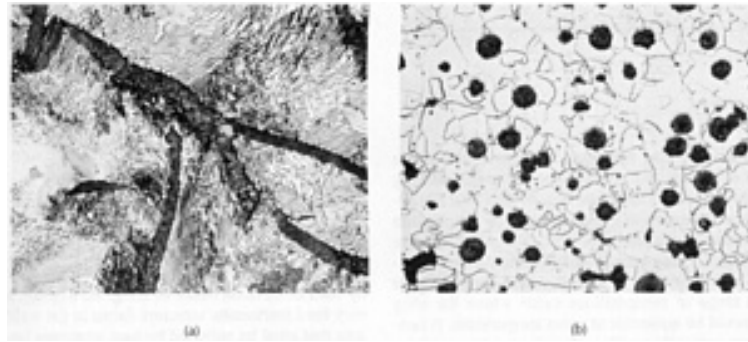

Fig. 46 The microstructures of two types of cast irons. (a) As-cast class 30 gray iron, showing type A graphite flakes in a matrix of pearlite. 500 \times . (b) As-cast grade 60-45-12 ductile iron, showing graphite nodules (produced by the addition of a calcium-silicon compound during pouring) in a ferrite matrix. 100 \times . Source: 85ASM 13.

The boundary lines on the iron-carbon and iron-cementite diagrams that are important to the heat treatment of steel and cast iron have been assigned special designations, which have been found useful in describing the treatments. These lines, where thermal arrest takes place during heating or cooling due to a solid-state reaction, are assigned the letter "A" for *arrêt* (French for "arrest"). These designations are shown in Fig. 45. To further differentiate the lines, an "e" is added to identify those indicating the changes occurring at equilibrium (to give Ae_1 , Ae_3 , Ae_4 , and Ae_{cm}). Also, because the temperatures at which changes actually occur on heating or cooling are displaced somewhat from the equilibrium values, the "e" is replaced with "c" (for *chauffage*, French for "heating") when identifying the slightly higher temperatures associated with changes that occur on heating. Likewise, "e" is replaced with "r" (for *refroidissement*, French for "cooling") when identifying those slightly lower temperatures associated with changes occurring on cooling. These designations are convenient terms because they are used not only for binary alloys of iron and carbon, but also for commercial steels and cast irons, regardless of the other elements present in them. Alloying elements such as manganese, chromium, nickel, and molybdenum, however, do affect these temperatures (mainly A_3). For example, nickel lowers A_3 , whereas chromium raises it.

The microstructures obtained in steels by slowly cooling are as follows. At carbon contents from 0.007 to 0.022%, the microstructure consists of ferrite grains with cementite precipitated in from ferrite, usually in too fine a form to be visible by light microscopy. (Because certain other metal atoms that may be present can substitute for some of the iron atoms in Fe_3C , the more general term, "carbide," is often used instead of "cementite" when describing microstructures.) In the hypoeutectoid range (from 0.022 to 0.76% C), ferrite and pearlite grains constitute the microstructure. In the hypereutectoid range (from 0.76 to 2.14% C), pearlite grains plus carbide precipitated from austenite are visible.

Slowly cooled hypoeutectic cast irons (from 2.14 to 4.3% C) have a microstructure consisting of dendritic pearlite grains (transformed from hypoeutectic primary austenite) and grains of iron-cementite eutectic (called "ledeburite") consisting of carbide and transformed austenite, plus carbide precipitated from austenite and particles of free carbon. For slowly cooled hypereutectic cast iron (between 4.3 and 6.67% C), the microstructure shows primary particles of carbide and free carbon, plus grains of transformed austenite.

Cast irons and steels, of course, are not used in their slowly cooled as-cast condition. Instead, they are more rapidly cooled from the melt, then subjected to some type of heat treatment and, for wrought steels, some type of hot and/or cold work. The great variety of microconstituents and microstructures that result from these treatments is beyond the scope of a discussion of stable and metastable equilibrium phase diagrams. Phase diagrams are invaluable, however, when designing heat treatments. For example, normalizing is usually accomplished by air cooling from about 55 $^{\circ}C$ (100 $^{\circ}F$) above the upper transformation temperature (A_3 for hypoeutectoid alloys and A_{cm} for hypereutectoid alloys). Full annealing is done by controlled cooling from about 28 to 42 $^{\circ}C$ (50 to 75 $^{\circ}F$) above A_3 for both hypoeutectoid and hypereutectoid alloys. All tempering and process annealing operations are done at temperatures below the lower transformation temperature (A_1). Austenitizing is done at a temperature sufficiently above A_3 and A_{cm} to ensure complete transformation to austenite, but low enough to prevent grain growth from being too rapid.

The Iron-Chromium-Nickel System. Many commercial cast irons and steels contain ferrite-stabilizing elements (such as silicon, chromium, molybdenum, and vanadium) and/or austenite stabilizers (such as manganese and nickel). The diagram for the binary iron-chromium system is representative of the effect of a ferrite stabilizer (see Fig. 47). At temperatures just below the solidus, bcc chromium forms a continuous solid solution with bcc (δ) ferrite. At lower temperatures, the γ -iron phase appears on the iron side of the diagram and forms a "loop" extending to about 11.2% Cr. Alloys containing up to 11.2% Cr, and sufficient carbon, are hardenable by quenching from temperatures within the loop.

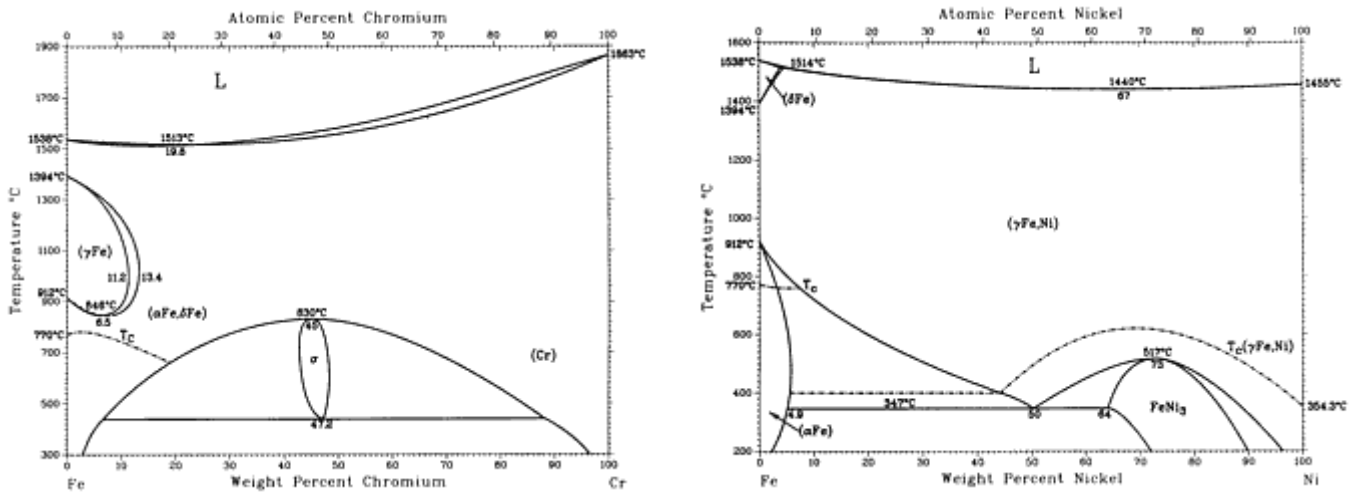

Fig. 47 Two representative binary iron phase diagrams, showing ferrite stabilization (Fe-Cr) and austenite stabilization (Fe-Ni). Source: 90Mas 15.

At still lower temperatures, the bcc solid solution is again continuous bcc ferrite, but this time with α Fe. This continuous bcc phase field confirms that δ -ferrite is the same as α -ferrite. The nonexistence of γ -iron in Fe-Cr alloys having more than about 13% Cr, in the absence of carbon, is an important factor in both the hardenable and nonhardenable grades of iron-chromium stainless steels. At these lower temperatures, a material known as sigma phase also appears in different amounts from about 14 to 90% Cr. Sigma is a hard, brittle phase and usually should be avoided in commercial stainless steels. Formation of sigma, however, is time dependent; long periods at elevated temperatures are usually required.

The diagram for the binary iron-nickel system is representative of the effect of an austenite stabilizer (see Fig. 47). The fcc nickel forms a continuous solid solution with fcc (γ) austenite that dominates the diagram, although the α -ferrite phase field extends to about 6% Ni. The diagram for the ternary iron-chromium-nickel system shows how the addition of ferrite-stabilizing chromium affects the iron-nickel system (see Fig. 48). As can be seen, the popular 18-8 stainless steel, which contains about 8% Ni, is an all-austenite alloy at 900 °C (1652 °F), even though it also contains about 18% Cr.

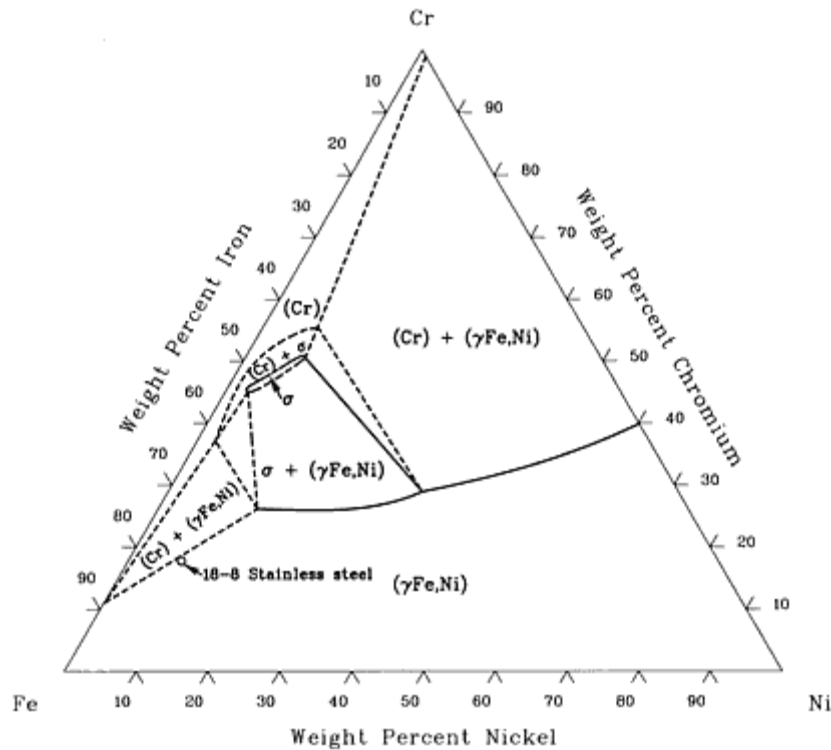

Fig. 48 The isothermal section at 900 °C (1652 °F) of the iron-chromium-nickel ternary phase diagram, showing the nominal composition of 18-8 stainless steel. Source: Adapted from G.V. Raynor and V.G. Rivlin, *Phase Equilibria in Iron Ternary Alloys*, Vol 4, The Institute of Metals, London, 1988

References cited in this section

13. **85ASM:** *Metals Handbook*, 9th ed., Vol 9, *Metallography and Microstructures*, American Society for Metals, 1985. *A comprehensive reference covering terms and definitions, metallographic techniques, microstructures of industrial metals and alloys, and principles of microstructures and crystal structures.*
15. **90Mas:** T.B. Massalski, Ed., *Binary Alloy. Phase Diagrams*, 2nd ed., ASM International, 1990. *The most comprehensive collection of binary phase diagrams published to date: diagrams for 2965 systems, presented in both atomic and weight percent, with crystal data and discussion.*

Practical Applications of Phase Diagrams

The following are but a few of the many instances where phase diagrams and phase relationships have proved invaluable in the efficient solving of practical metallurgical problems.

Alloy Design

Age Hardening Alloys. One of the earliest uses of phase diagrams in alloy development was in the suggestion in 1919 by the U.S. Bureau of Standards that precipitation of a second phase from solid solution would harden an alloy. The age hardening of certain aluminum-copper alloys (then called "Duralumin" alloys) had been accidentally discovered in 1904, but this process was thought to be a unique and curious phenomenon. The work at the Bureau, however, showed the scientific basis of this process (which was discussed in previous sections of this Introduction). This work has now led to the development of several families of commercial "age hardening" alloys covering different base metals.

Austenitic Stainless Steel. In connection with a research project aimed at the conservation of always expensive, sometimes scarce, materials, the question arose: Can manganese and aluminum be substituted for nickel and chromium in stainless steels? (In other words, can standard chromium-nickel stainless steels be replaced with an austenitic alloy

system?) The answer came in two stages--in both instances with the help of phase diagrams. It was first determined that manganese should be capable of replacing nickel because it stabilizes the γ -iron phase (austenite), and aluminum may substitute for chromium because it stabilizes the α -iron phase (ferrite), leaving only a small γ loop (see Fig. 47 and 49). Aluminum is known to impart good high-temperature oxidation resistance to iron. Next, the literature on phase diagrams of the aluminum-iron-manganese system was reviewed, which suggested that a range of compositions exists where the alloy would be austenitic at room temperature. A non-magnetic alloy with austenitic structure containing 44% Fe, 45% Mn, and 11% Al was prepared. However, it proved to be very brittle, presumably because of the precipitation of a phase based on β -Mn. By examining the phase diagram for carbon-iron-manganese (Fig. 50), as well as the diagram for aluminum-carbon-iron, the researcher determined that the problem could be solved through the addition of carbon to the aluminum-iron-manganese system, which would move the composition away from the β Mn phase field. The carbon addition also would further stabilize the austenite phase, permitting reduced manganese content. With this information, the composition of the alloy was modified to 7 to 10% Al, 30 to 35% Mn, and 0.75 to 1% C, with the balance iron. It had good mechanical properties, oxidation resistance, and moderate stainlessness.

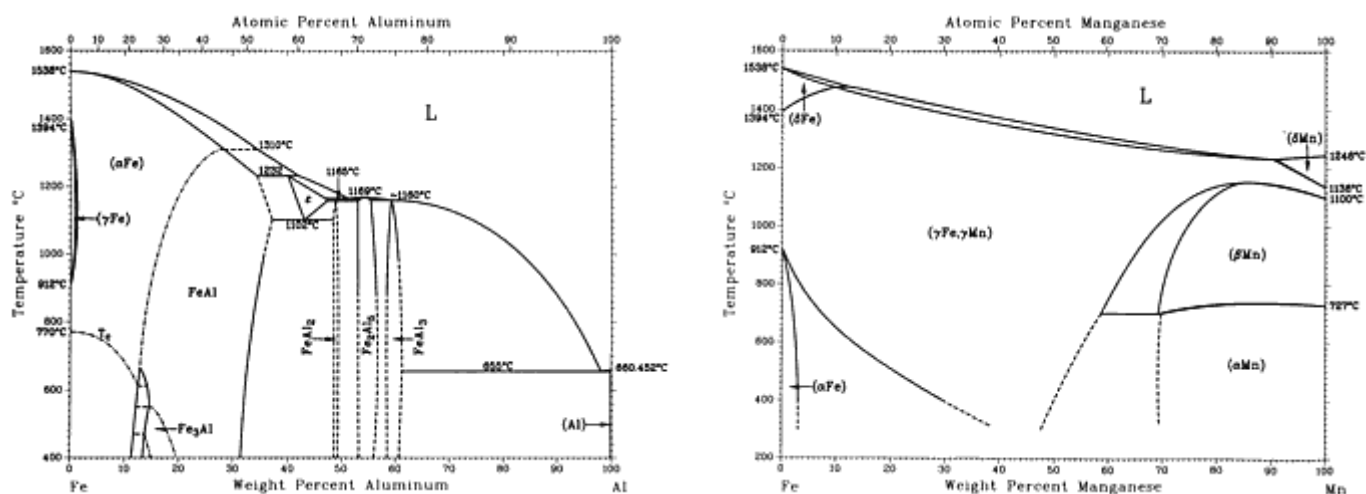

Fig. 49 The aluminum-iron and iron-manganese phase diagrams. Source: H. Okamoto, *Phase Diagrams of Binary Iron Alloys*, ASM International, 1992

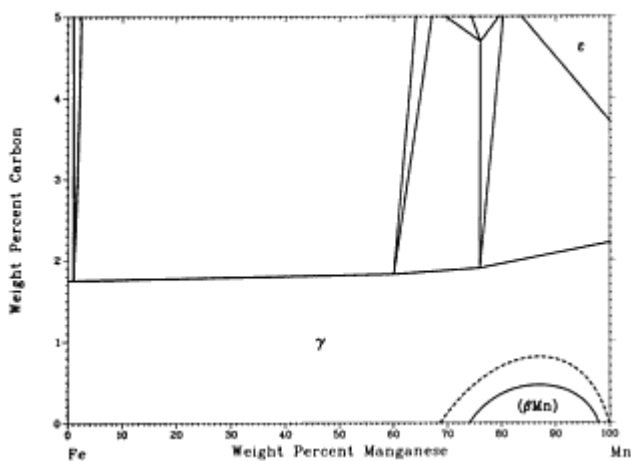

Fig. 50 The isothermal section at 1100 °C (2012 °F) of the iron-manganese-carbon phase diagram. Source: Adapted from R. Benz, J.F. Elliott, and J. Chipman, *Metall. Trans.*, Vol 4, 1973, p 1449

Permanent Magnets. A problem with permanent magnets based on Fe-Nd-B is that they show high magnetization and coercivity at room temperature, but unfavorable properties at higher temperatures. Because hard magnetic properties are limited by nucleation of severed magnetic domains, the surface and interfaces of grains in the sintered and heat-treated

material are the controlling factor. Therefore, the effects of alloying additives on the phase diagrams and microstructural development of the Fe-Nd-B alloy system plus additives were studied. These studies showed that the phase relationships and domain-nucleation difficulties were very unfavorable for the production of a magnet with good magnetic properties at elevated temperatures by the sintering method. However, such a magnet might be produced from Fe-Nd-C material by some other process, such as melt spinning or bonding (see 91Hay 16).

Processing

Hacksaw Blades. In the production of hacksaw blades, a strip of high-speed steel for the cutting edges is joined to a backing strip of low-alloy steel by laser or electron beam welding. As a result, a very hard martensitic structure forms in the weld area that must be softened by heat treatment before the composite strip can be further rolled or set. To avoid the cost of the heat treatment, an alternative technique was investigated. This technique involved alloy additions during welding to create a microstructure that would not require subsequent heat treatment. Instead of expensive experiments, several mathematical simulations were made based on additions of various steels or pure metals. In these simulations, the hardness of the weld was determined by combining calculations of the equilibrium phase diagrams and available information to calculate (assuming the average composition of the weld) the martensite transformation temperatures and amounts of retained austenite, untransformed ferrite, and carbides formed in the postweld microstructure. Of those alloy additions considered, chromium was found to be the most efficient (see 91 Hay 16).

Hardfacing. A phase diagram was used to design a nickel-base hardfacing alloy for corrosion and wear resistance. For corrosion resistance, a matrix of at least 15% Cr was desired; for abrasion resistance, a minimum amount of primary chromium-boride particles was desired. After consulting the B-Cr-Ni phase diagram, a series of samples having acceptable amounts of total chromium borides and chromium matrix were made and tested. Subsequent fine tuning of the composition to ensure fabricability of welding rods, weldability, and the desired combination of corrosion, abrasion, and impact resistance led to a patented alloy.

Reference cited in this section

16. **91Hay:** F.H. Hayes, Ed., *User Aspects of Phase Diagrams*, The Institute of Metals, London, 1991. A collection of 35 papers and posters presented at a conference held June 1990 in Petten, The Netherlands.

Performance

Heating elements made of Nichrome (a nickel-chromium-iron alloy registered by Driver-Harris Company, Inc., Harrison, NJ) in a heat treating furnace were failing prematurely. Reference to nickel-base phase diagrams suggested that low-melting eutectics can be produced by very small quantities of the chalcogens (sulfur, selenium, or tellurium), and it was thought that one of these eutectics could be causing the problem. Investigation of the furnace system resulted in the discovery that the tubes conveying protective atmosphere to the furnace were made of sulfur-cured rubber, which could result in liquid metal being formed at temperatures as low as 637 °C (1179 °F) (see Fig. 51). Armed with this information, a metallurgist solved the problem by substituting neoprene for the rubber.

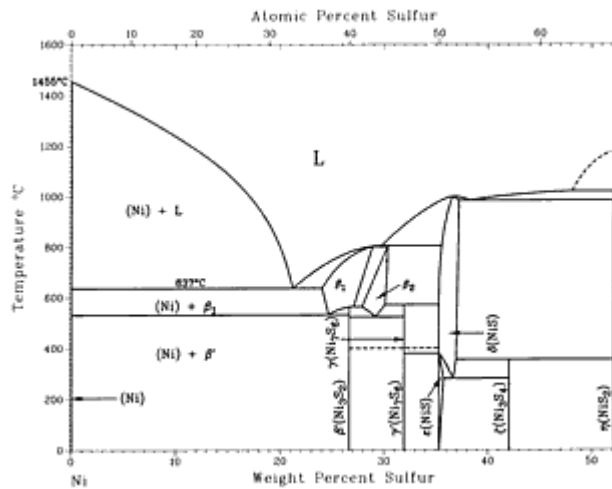

Fig. 51 The nickel-sulfur phase diagram. Source: Adapted from 90Mas 15

Electric Motor Housings. At moderately high service temperatures, cracks developed in electric motor housings that had been extruded from aluminum produced from a combination of recycled and virgin metal. Extensive studies revealed that the cracking was caused by small amounts of lead and bismuth in the recycled metal reacting to form bismuth-lead eutectic at the grain boundaries at 327 and ~270 °C (621 and ~518 °F), respectively, much below the melting point of pure aluminum (660.45 °C, or 1220.81 °F) (see Fig. 52). The question became: How much lead and bismuth can be tolerated in this instance? The phase diagrams showed that aluminum alloys containing either lead or bismuth in amounts exceeding their respective solubility limits (<0.05% and ~0.2%) can lead to hot cracking of the aluminum.

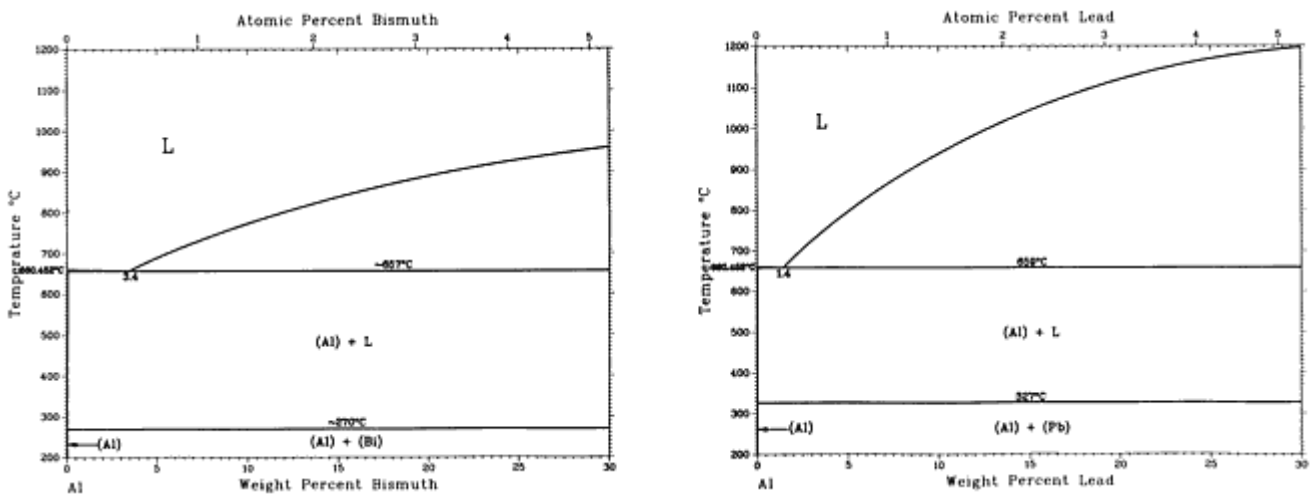

Fig. 52 The aluminum-bismuth and aluminum-lead phase diagrams. Source: Adapted from 90Mas 15

Carbide Cutting Tools. A manufacturer of carbide cutting tools once experienced serious trouble with brittleness of the sintered carbide. No impurities were found. The range of compositions for cobalt-bonded sintered carbides is shown in the shaded area of Fig. 53, along the dashed line connecting pure tungsten carbide (marked "WC") on the right and pure cobalt at the lower left. At 1400 °C (2552 °F), materials with these compositions consist of particles of tungsten carbide suspended in liquid metal. However, when there is a deficiency of carbon, compositions drop into the region labeled WC + η+ liquid, or the region labeled WC + η where tungsten carbide particles are surrounded by a matrix of η phase. The η phase is known to be brittle. The upward adjustment of the carbon content by only a few hundredths of a weight percent eliminated this problem.

References cited in this section

15. **90Mas:** T.B. Massalski, Ed., *Binary Alloy. Phase Diagrams*, 2nd ed., ASM International, 1990. *The most comprehensive collection of binary phase diagrams published to date: diagrams for 2965 systems, presented in both atomic and weight percent, with crystal data and discussion.*
16. **91Hay:** F.H. Hayes, Ed., *User Aspects of Phase Diagrams*, The Institute of Metals, London, 1991. *A collection of 35 papers and posters presented at a conference held June 1990 in Petten, The Netherlands.*

Introduction to Binary Alloy Phase Diagrams

Introduction

THE 1046 BINARY SYSTEMS presented in this Section have been selected for their commercial importance from the almost 3000 systems covered in *Binary Alloy Phase Diagrams*, Second Edition. The diagrams used were reproduced from that compilation, from more recent evaluations, or, in some instances, updated evaluations based on the most recent literature. The source is indicated with each phase diagram. "Unpublished" indicates the source is a complete evaluation that has not yet been published in the *Journal of Phase Equilibria* or in a monograph. The crystal structure data shown with the diagrams have been updated in some instances with information from *Pearson's Handbook of Crystallographic Data for Intermetallic Phases*, Second Edition.

Except when the information for a system is from one of the General References listed in the following pages, the specific author of the information is listed as the source, along with the year the investigation was completed. To locate the author's complete investigation of a system, consult the Binary Alloy Phase Diagrams Index in this Section, which lists source information for all 2965 binary alloy systems for which data exist.

Because this Handbook is designed to be used mainly by engineers to solve industrial problems, the primary composition scale is plotted in weight percent. Atomic percentages are shown as a secondary scale at the top of the diagrams. Conversions between weight and atomic composition also can be made using the standard atomic weights listed in the Appendix. For the sake of clarity, grid lines are not superimposed on the phase diagrams. However, tick marks are provided along the composition scale as well as the temperature scale, which is shown in degrees Celsius. Celsius temperatures can be easily converted to degrees Fahrenheit using the table in the Appendix. Magnetic transitions (Curie temperature and Néel temperature) are shown as dot-dashed lines. Dashed lines are used to denote uncertain or speculative boundaries.

All diagrams presented in this Section of the Handbook are for stable equilibrium conditions, except where metastable conditions are indicated.

Introduction to Binary Alloy Phase Diagrams

Binary Alloy Phase Diagrams Index

This index gives source information for all 2965 binary alloy systems. Column 2 designates all binary abstracts published in *Binary Alloy Phase Diagrams*, Second Edition (called "M2") and indicates if information for the system has been updated in the *Binary Alloy Phase Diagrams Updating Service* by listing the update year. Abstracts are a shortened version of the full evaluation giving concise descriptions of key features of the system, crystal structure data, primary references, and the equilibrium diagram, if any. Column 3 gives the source of the original abstract or the most recent full evaluation. Full evaluations include expanded information on the phase diagram, and any lattice parameter, thermodynamic, magnetism, and pressure information and ancillary figures available. A key to abbreviated titles of Alloy Phase Diagram Program source publications and General References used in column 3 precede the index. Systems marked "unpublished" have been submitted to the Alloy Phase Diagram Program, but have not yet been published. References to sources that are non-Alloy Phase Diagram publications follow the index. Column 4 indicates whether the evaluation includes a phase diagram (D) or is text only (T). Diagrams for systems marked by an asterisk are published in this handbook.

Binary Alloys Index

System	Published	Data source	Data type
Ac-Ag	M2	Unpublished	T
Ac-Au	M2	Binary Gold	T

Ac-B	M2	M2	D
Ac-Cr	M2	BAPD 6(5)	D
Ac-Cu	M2	M2	T
Ac-H	M2	M2	T
Ac-Mg	M2	Unpublished	T
Ac-Mo	M2	M2	D
Ac-O	M2	M2	T
Ac-Pt	M2	BAPD 10(4a)	D
Ac-S	M2	M2	T
Ac-W		Binary Tungsten	T
*Ag-Al	M2	BAPD 8(6)	D
Ag-Am	No Data		
Ag-Ar	M2	Unpublished	T
*Ag-As	M2	BAPD 11(2)	D
Ag-At	M2	Unpublished	T
*Ag-Au	M2	Binary Gold	D
Ag-B	M2,92	BAPD 11(6)	T
Ag-Ba	M2,92	Unpublished	D
*Ag-Be	M2	Binary Beryllium	D
*Ag-Bi	M2	BAPD 1(2)	D
Ag-Br	M2	M2	T

Ag-C	M2	BAPD 9(3)	D
*Ag-Ca	M2	BAPD 9(3)	D
*Ag-Cd	M2	[Hansen] 6	D
*Ag-Ce	M2	BAPD 6(5)	D
Ag-Cl	M2	M2	T
*Ag-Co	M2	BAPD 7(3)	D
Ag-Cr	M2	BAPD 11(3)	D
Ag-Cs	M2	BAPD 7(3)	T
*Ag-Cu	M2	Unpublished	D
*Ag-Dy	M2	BAPD 6(1)	D
*Ag-Er	M2	BAPD 6(1)	D
*Ag-Eu	M2	BAPD 6(1)	D
Ag-F	M2	M2	T
*Ag-Fe	M2	Binary Iron	D
Ag-Fr	M2	Unpublished	T
*Ag-Ga	M2,92	JPE 13(3)	D
*Ag-Gd	M2	BAPD 6(2)	D
*Ag-Ge	M2	BAPD 9(1)	D
Ag-H	M2,92	JPE 12(6)	T
Ag-He	M2	Unpublished	T
Ag-Hf	M2	BAPD 10(2)	T

*Ag-Hg	M2	Unpublished	D
*Ag-Ho	M2	BAPD 6(2)	D
Ag-I	M2	M2	T
*Ag-In	M2	Indium	D
Ag-Ir	M2	BAPD 7(4)	D
Ag-K	M2	BAPD 7(3)	T
Ag-Kr	M2	Unpublished	T
*Ag-La	M2	BAPD 4(4)	D
*Ag-Li	M2	BAPD 7(3)	D
Ag-Lu	M2	BAPD 4(4)	D
*Ag-Mg	M2	Binary Magnesium	D
Ag-Mn	M2	BAPD 11(5)	D
*Ag-Mo	M2	BAPD 11(6)	D
Ag-N	M2	BAPD 11(5)	T
*Ag-Na	M2	BAPD 7(2)	D
Ag-Nb	M2	BAPD 10(6)	T
*Ag-Nd	M2	BAPD 6(1)	D
Ag-Ne	M2	Unpublished	T
*Ag-Ni	M2	Binary Nickel	D
Ag-Np	M2	M2	T
Ag-O	M2	JPE 13(2)	D

Ag-Os	M2	BAPD 7(4)	D
*Ag-P	M2	BAPD 9(3)	D
Ag-Pa	M2	M2	T
*Ag-Pb	M2	BAPD 8(4)	D
*Ag-Pd	M2	BAPD 9(3)	D
Ag-Pm	M2,91	M2	T
Ag-Po	M2	M2	T
*Ag-Pr	M2	BAPD 6(1)	D
*Ag-Pt	M2	BAPD 8(4)	D
Ag-Pu	M2	[70Woo] 156	D
Ag-Ra	M2	Unpublished	T
Ag-Rb	M2	BAPD 7(1)	T
Ag-Re	M2	BAPD 9(3)	D
Ag-Rh	M2	BAPD 7(4)	D
Ag-Rn	M2	Unpublished	T
Ag-Ru	M2	BAPD 7(4)	D
*Ag-S	M2	BAPD 7(3)	D
*Ag-Sb	M2	[Hansen] 6	D
*Ag-Sc	M2	BAPD 4(4)	D
*Ag-Se	M2	BAPD 11(3)	D
*Ag-Si	M2	BAPD 10(6)	D

*Ag-Sm	M2,91	BAPD 6(2)	D
*Ag-Sn	M2	BAPD 8(4)	D
*Ag-Sr	M2	BAPD 11(2)	D
Ag-Ta	M2	BAPD 9(3)	T
Ag-Tb	M2	BAPD 6(2)	D
Ag-Tc	M2	Unpublished	T
*Ag-Te	M2	JPE 12(1)	D
Ag-Th	M2,92	JPE 12(3)	D
*Ag-Ti	M2	Binary Titanium	D
*Ag-Tl	M2	BAPD 10(6)	D
Ag-Tm	M2	M2	D
Ag-U	M2	BAPD 10(6)	D
Ag-V	M2	Binary Vanadium	D
Ag-W	M2,92	Binary Tungsten	D
Ag-Xe	M2	Unpublished	T
*Ag-Y	M2	BAPD 4(4)	D
*Ag-Yb	M2	BAPD 6(2)	D
*Ag-Zn	M2	[40And] 39	D
*Ag-Zr	M2	JPE 13(2)	D
Al-Am	M2	BAPD 10(3)	T
*Al-As	M2	BAPD 5(6)	D

*Al-Au	M2,91	BAPD 8(2)	D
Al-B	M2	BAPD 11(6)	D
*Al-Ba	M2,92	BAPD 2(3)	D
*Al-Be	M2	Binary Beryllium	D
*Al-Bi	M2	BAPD 5(3)	D
Al-Br	No Data		
Al-C	M2,91,92	M2	D
*Al-Ca	M2	BAPD 9(6)	D
*Al-Cd	M2	BAPD 3(2)	D
*Al-Ce	M2	BAPD 9(6)	D
Al-Cl	No Data		
Al-Cm	No Data		
*Al-Co	M2	BAPD 10(6)	D
*Al-Cr	M2	Unpublished	D
Al-Cs	M2	Unpublished	T
*Al-Cu	M2	[85Mur] 218	D
Al-Dy	M2	M2	D
*Al-Er	M2	BAPD 9(6)	D
Al-Eu	M2,91	M2	D
Al-F	No Data		
*Al-Fe	M2	Binary Iron	D

*Al-Ga	M2	BAPD 4(2)	D
*Al-Gd	M2	BAPD 9(6)	D
*Al-Ge	M2	BAPD 5(4)	D
*Al-H	M2	JPE 13(1)	D
Al-Hf	M2	Unpublished	D
*Al-Hg	M2	BAPD 6(3)	D
*Al-Ho	M2	BAPD 9(6)	D
Al-I	No Data		
*Al-In	M2	Indium	D
Al-Ir	M2	M2	D
Al-K	M2	Unpublished	T
*Al-La	M2	BAPD 9(6)	D
*Al-Li	M2,91	BAPD 3(2)	D
Al-Lu	M2	M2	D
*Al-Mg	M2	Binary Magnesium	D
*Al-Mn	M2	BAPD 8(5)	D
Al-Mo	M2,91	Unpublished	D
Al-N	M2	BAPD 7(4)	D
Al-Na	M2	BAPD 4(4)	D
*Al-Nb	M2	Unpublished	D
*Al-Nd	M2,91	BAPD 10(1)	D

*Al-Ni	M2	Binary Nickel	D
Al-Np	M2	BAPD 10(2)	T
Al-O	M2	BAPD 6(6)	D
Al-Os	M2	Unpublished	T
Al-P	M2	BAPD 6(3)	D
*Al-Pb	M2	BAPD 5(1)	D
*Al-Pd	M2	BAPD 7(4)	D
Al-Pm	M2	M2	D
*Al-Pr	M2	BAPD 10(1)	D
*Al-Pt	M2	BAPD 7(1)	D
Al-Pu	M2	BAPD 10(4a)	D
Al-Rb	M2	Unpublished	T
Al-Re	M2	Unpublished	T
Al-Rh	M2	M2	D
Al-Ru	M2	M2	D
*Al-S	M2,91	BAPD 8(2)	D
*Al-Sb	M2	BAPD 5(5)	D
Al-Sc	M2,91	BAPD 10(1)	D
*Al-Se	M2	BAPD 10(6)	D
*Al-Si	M2	BAPD 5(1)	D
Al-Sm	M2	BAPD 10(1)	D

*Al-Sn	M2	BAPD 4(4)	D
*Al-Sr	M2	BAPD 10(6)	D
*Al-Ta	M2	Unpublished	D
Al-Tb	M2	M2	D
Al-Tc	M2	M2	T
*Al-Te	M2	BAPD 11(2)	D
*Al-Th	M2	BAPD 10(4a)	D
*Al-Ti	M2	Binary Titanium	D
Al-Tl	M2,92	BAPD 10(2)	D
Al-Tm	M2	M2	D
*Al-U	M2,91	BAPD 11(1)	D
*Al-V	M2	Binary Vanadium	D
*Al-W	M2	Binary Tungsten	D
*Al-Y	M2	BAPD 10(1)	D
*Al-Yb	M2	BAPD 10(1)	D
*Al-Zn	M2	BAPD 4(1)	D
*Al-Zr	M2,92	JPE 13(3)	D
Am-As	M2	M2	T
Am-B	M2	M2	D
Am-Be	M2	Binary Beryllium	T
Am-Bi	M2	M2	T

Am-C	M2	M2	T
Am-Co	M2	M2	T
Am-Cr	M2	BAPD 6(5)	D
Am-Cu	M2	M2	T
Am-Fe	M2	M2	T
Am-H	M2	M2	T
Am-Ir	M2	M2	T
Am-Mo	M2	[Molybdenum] 12	D
Am-N	M2	M2	T
Am-Ni	M2	Binary Nickel	T
Am-O	M2,91	[Elliott] 4	T
Am-Os	M2	M2	T
Am-P	M2	M2	T
Am-Pd	M2	M2	T
Am-Pt	M2	BAPD 10(2)	D
Am-Pu	M2	[66E11] 125	D
Am-Rh	M2	M2	T
Am-Ru	M2	M2	T
Am-S	M2	M2	T
Am-Sb	M2	M2	T
Am-Se	M2	M2	T

Am-Si	M2	M2	D
Am-Te	M2	M2	T
Am-W		Binary Tungsten	T
Ar-Au	M2	Binary Gold	T
Ar-Be	M2	Binary Beryllium	T
Ar-Cu	M2	Unpublished	T
Ar-Mg	M2	Binary Magnesium	T
Ar-Mo	M2	[Molybdenum] 12	D
Ar-W		Binary Tungsten	T
*As-Au	M2	Binary Gold	D
As-B	M2	M2	D
As-Ba	M2	M2	T
As-Be	M2	Binary Beryllium	T
*As-Bi	M2	[53Gea] 48	D
As-Bk	M2	M2	T
As-Br	No Data		
As-C	M2	M2	T
As-Ca	M2	M2	T
*As-Cd	M2	JPE 13(2)	D
As-Ce	M2	BAPD 7(3)	T
As-Cf	M2	M2	T

As-Cl	No Data		
As-Cm	M2	M2	T
*As-Co	M2	BAPD 11(6)	D
As-Cr	M2	BAPD 11(5)	D
As-Cs	M2	M2	T
*As-Cu	M2	BAPD 9(5)	D
As-Dy	M2	M2	D
As-Er	M2	M2	D
As-Eu	M2	BAPD 7(3)	D
As-F	No Data		
*As-Fe	M2	Binary Iron	D
*As-Ga	M2	M2	D
As-Gd	M2	BAPD 7(4)	T
*As-Ge	M2,91	BAPD 6(3)	D
As-H	M2	M2	T
As-Hf	M2	M2	T
As-Hg	M2	M2	T
As-Ho	M2	M2	D
As-I	No Data		
*As-In	M2	Indium	D
As-Ir	M2	M2	T

*As-K	M2	[61Dorl] 82	D
As-La	M2	BAPD 7(4)	T
As-Li	M2	M2	T
As-Lu	M2	M2	D
As-Mg	M2	Binary Magnesium	D
*As-Mn	M2	BAPD 10(5)	D
As-Mo	M2,91	[Molybdenum] 12	D
As-N	M2	M2	T
As-Na	M2	M2	T
As-Nb	M2	M2	T
*As-Nd	M2	BAPD 7(4)	D
*As-Ni	M2	Binary Nickel	D
As-Np	M2	M2	T
As-O	M2	M2	T
As-Os	M2	M2	D
*As-P	M2	JPE 12(3)	D
As-Pa	M2	M2	T
*As-Pb	M2	BAPD 11(2)	D
*As-Pd	M2,91,92	BAPD 11(5)	D
As-Pm	No Data		
As-Pr	M2	BAPD 7(4)	T

As-Pt	M2	BAPD 11(5)	D
As-Pu	M2	M2	T
As-Rb	M2	M2	T
As-Re	M2	M2	T
As-Rh	M2	M2	T
As-Ru	M2	M2	T
*As-S	M2	M2	D
*As-Sb	M2	M2	D
As-Sc	M2	BAPD 7(4)	T
*As-Se	M2	M2	D
*As-Si	M2	BAPD 6(3)	D
As-Sm	M2	M2	D
*As-Sn	M2,91	BAPD 11(3)	D
As-Sr	M2	M2	T
As-Ta	M2	M2	T
As-Tb	M2	M2	D
As-Tc	M2	M2	T
*As-Te	M2	M2	D
As-Th	M2	[Smith] 18	D
As-Ti	M2	Binary Titanium	D
*As-Tl	M2	Unpublished	D

As-Tm	M2	M2	D
As-U	M2	M2	D
As-V	M2	JPE 12(4)	T
As-W	M2	Binary Tungsten	T
As-Y	M2	BAPD 7(4)	T
*As-Yb	M2	M2	D
*As-Zn	M2	JPE 13(2)	D
As-Zr	M2,91	BAPD 11(6)	T
At-Au	M2	Binary Gold	T
At-Mo	M2	M2	D
At-W		Binary Tungsten	T
Au-B	M2	Binary Gold	D
Au-Ba	M2	Binary Gold	T
*Au-Be	M2	Binary Beryllium	D
*Au-Bi	M2	M2	D
Au-Br	M2	Binary Gold	T
Au-C	M2	Binary Gold	D
*Au-Ca	M2	Binary Gold	D
*Au-Cd	M2	Binary Gold	D
*Au-Ce	M2	Binary Gold	D
Au-CI	M2	Binary Gold	D

Au-Cm	No Data		
*Au-Co	M2	Binary Gold	D
*Au-Cr	M2	Binary Gold	D
Au-Cs	M2	Binary Gold	D
*Au-Cu	M2	Binary Gold	D
*Au-Dy	M2	Binary Gold	D
Au-Er	M2	Binary Gold	D
*Au-Eu	M2	M2	D
Au-F	M2	Binary Gold	T
*Au-Fe	M2	Binary Iron	D
Au-Fr	M2	[68Gul1] 141	T
*Au-Ga	M2	Binary Gold	D
Au-Gd	M2	Binary Gold	D
*Au-Ge	M2	Binary Gold	D
Au-H	M2	Binary Gold	T
Au-He	M2	Binary Gold	T
Au-Hf	M2	Binary Gold	D
*Au-Hg	M2	BAPD 10(1)	D
Au-Ho	M2	Binary Gold	D
Au-I	M2	Binary Gold	T
*Au-In	M2	Indium	D

Au-Ir	M2	Binary Gold	T
*Au-K	M2	Binary Gold	D
Au-Kr	M2	Binary Gold	T
*Au-La	M2	Binary Gold	D
*Au-Li	M2	Binary Gold	D
Au-Lu	M2	Binary Gold	D
*Au-Mg	M2	Binary Magnesium	D
*Au-Mn	M2	Binary Gold	D
Au-Mo	M2	Binary Gold	D
Au-N	M2	Binary Gold	T
*Au-Na	M2	Binary Gold	D
*Au-Nb	M2	Binary Gold	D
Au-Nd	M2	Binary Gold	D
Au-Ne	M2	Binary Gold	T
*Au-Ni	M2	Binary Gold	D
Au-Np	M2	Binary Gold	T
Au-O	M2	Binary Gold	T
Au-Os	M2	Binary Gold	T
Au-P	M2	Binary Gold	D
Au-Pa	M2	Binary Gold	T
*Au-Pb	M2	Binary Gold	D

*Au-Pd	M2	Binary Gold	D
Au-Pm	M2	Binary Gold	D
Au-Po	M2	Binary Gold	T
*Au-Pr	M2	Binary Gold	D
*Au-Pt	M2	Binary Gold	D
*Au-Pu	M2	Binary Gold	D
Au-Ra	M2	Binary Gold	T
*Au-Rb	M2	Binary Gold	D
Au-Re	M2	Binary Gold	T
Au-Rh	M2	Binary Gold	D
Au-Rn	M2	Binary Gold	T
Au-Ru	M2	Binary Gold	D
Au-S	M2	Binary Gold	D
*Au-Sb	M2	Binary Gold	D
Au-Sc	M2	Binary Gold	D
*Au-Se	M2	Binary Gold	D
*Au-Si	M2	Binary Gold	D
Au-Sm	M2	Binary Gold	D
*Au-Sn	M2	Binary Gold	D
*Au-Sr	M2	Binary Gold	D
Au-Ta	M2	Binary Gold	D

Au-Tb	M2	Binary Gold	D
Au-Tc	M2	Binary Gold	T
*Au-Te	M2	Binary Gold	D
*Au-Th	M2,91	Binary Gold	D
*Au-Ti	M2	Binary Gold	D
*Au-Tl	M2	Binary Gold	D
Au-Tm	M2	Binary Gold	D
*Au-U	M2	M2	D
*Au-V	M2	Binary Vanadium	D
Au-W	M2	Binary Tungsten	D
Au-Xe	M2	Binary Gold	T
Au-Y	M2	Binary Gold	T
*Au-Yb	M2	Binary Gold	D
*Au-Zn	M2	BAPD 10(1)	D
*Au-Zr	M2	Binary Gold	D
B-Ba	M2	M2	D
B-Be	M2	Binary Beryllium	D
B-Bi	M2,91	M2	D
*B-C	M2,92	M2	D
B-Ca	M2	M2	D
B-Cd	M2	Unpublished	D

B-Ce	M2	Unpublished	D
B-Cm	No Data		
*B-Co	M2	BAPD 9(4)	D
*B-Cr	M2	BAPD 7(3)	D
B-Cs	No Data		
*B-Cu	M2	BAPD 3(1)	D
B-Dy	M2	Unpublished	D
B-Er	M2	Unpublished	D
B-Eu	M2	Unpublished	D
*B-Fe	M2	Binary Iron	D
B-Ga	M2,91	M2	D
B-Gd	M2	Unpublished	D
B-Ge	M2	BAPD 5(5)	D
B-H	M2	M2	T
B-Hf	M2	M2	D
B-Hg	M2	Unpublished	D
B-Ho	M2	Unpublished	D
B-In	M2	Indium	D
B-Ir	M2	M2	T
B-K	M2	M2	T
B-La	M2,91	Unpublished	D

B-Li	M2	BAPD 10(3)	T
B-Lu	M2	Unpublished	D
B-Mg	M2	Binary Magnesium	D
*B-Mn	M2,91	BAPD 7(6)	D
*B-Mo	M2,91	BAPD 9(4)	D
B-N	M2	M2	D
B-Na	M2	M2	T
*B-Nb	M2	M2	D
B-Nd	M2	Unpublished	D
*B-Ni	M2	Binary Nickel	D
B-Np	M2	M2	D
B-O	M2	M2	D
B-Os	M2	M2	D
B-P	M2	M2	T
B-Pa	M2	M2	D
B-Pb	M2	M2	D
*B-Pd	M2	Unpublished	D
B-Pm	M2	Unpublished	D
B-Pr	M2	Unpublished	D
*B-Pt	M2	M2	D
B-Pu	M2	Unpublished	D

B-Rb	No Data		
*B-Re	M2	[72Por] 166	D
B-Rh	M2	[Moffatt] 11	D
*B-Ru	M2	[63Obr] 99	D
B-S	M2	[Moffatt] 11	D
B-Sb	M2,91	M2	D
*B-Sc	M2	BAPD 11(4)	D
B-Se	M2	[69Bor] 149	D
*B-Si	M2	BAPD 5(5)	D
B-Sm	M2	Unpublished	D
B-Sn	M2	M2	D
B-Sr	M2	M2	D
*B-Ta	M2	M2	D
B-Tb	M2	BAPD 11(4)	D
B-Tc	M2	M2	D
B-Te	No Data		
B-Th	M2	[Moffatt] 11	D
*B-Ti	M2	Binary Titanium	D
B-Tl	M2,91	M2	D
B-Tm	M2	Unpublished	D
B-U	M2	M2	D

*B-V	M2,91	Binary Vanadium	D
*B-W	M2,92	Binary Tungsten	D
*B-Y	M2	Unpublished	D
B-Yb	M2	Unpublished	D
B-Zn	M2,91	M2	D
*B-Zr	M2	[Zirconium] 21	D
Ba-Be	M2,91	Binary Beryllium	D
Ba-Bi	M2	[38Gru] 38	D
Ba-Br	M2	M2	D
Ba-C	M2	M2	T
*Ba-Ca	M2	BAPD 7(4)	D
*Ba-Cd	M2	M2	D
Ba-Ce	M2	M2	T
Ba-Cl	M2	M2	D
Ba-Cm	No Data		
Ba-Co	M2	Unpublished	T
Ba-Cr	M2	BAPD 6(3)	T
Ba-Cs	M2	BAPD 5(5)	T
*Ba-Cu	M2	BAPD 5(6)	D
Ba-Dy	M2	M2	T
Ba-Er	M2	M2	T

Ba-Eu	M2,91	BAPD 9(3)	D
Ba-F	M2	M2	D
Ba-Fe	M2	M2	D
*Ba-Ga	M2	JPE 12(5)	D
Ba-Gd	M2	M2	T
*Ba-Ge	M2	M2	D
*Ba-H	M2	[60Pet1] 76	D
Ba-Hf	No Data		
*Ba-Hg	M2	M2	D
Ba-Ho	M2	M2	T
Ba-I	M2	M2	D
*Ba-In	M2	Indium	D
Ba-Ir	No Data		
Ba-K	M2	BAPD 5(5)	T
Ba-La	M2	M2	D
*Ba-Li	M2	BAPD 5(5)	D
Ba-Lu	M2	M2	T
*Ba-Mg	M2	Binary Magnesium	D
Ba-Mn	M2	[64Obi1] 111	D
Ba-Mo	M2	M2	D
Ba-N	M2	M2	T

*Ba-Na	M2	BAPD 6(1)	D
Ba-Nb	No Data		
Ba-Nd	M2	BAPD 9(3)	D
Ba-Ni	M2	Binary Nickel	D
Ba-Np	No Data		
Ba-O	M2	M2	D
Ba-Os	No Data		
*Ba-P	M2	M2	D
*Ba-Pb	M2	[Hansen] 6	D
Ba-Pd	M2,91	JPE 12(4)	D
Ba-Pm	M2	M2	D
Ba-Po	M2	M2	T
Ba-Pr	M2	BAPD 9(3)	D
Ba-Pt	M2,91	JPE 12(4)	D
Ba-Pu	M2	M2	T
Ba-Rb	M2	BAPD 5(5)	T
Ba-Re	No Data		
Ba-Rh	M2	M2	T
Ba-Ru	No Data		
Ba-S	M2	M2	D
Ba-Sb	M2	M2	T

Ba-Sc	M2	M2	D
*Ba-Se	M2	JPE 12(4)	D
*Ba-Si	M2	[64Obi2] 112	D
Ba-Sm	M2	BAPD 9(3)	D
Ba-Sn	M2,91	M2	D
Ba-Sr	M2,91	BAPD 8(6)	D
Ba-Ta	No Data		
Ba-Tb	M2	M2	T
Ba-Tc	No Data		
*Ba-Te	M2	Unpublished	D
Ba-Th	No Data		
Ba-Ti	M2	Binary Titanium	D
*Ba-Tl	M2	[66Bru] 122	D
Ba-Tm	M2	M2	T
Ba-U	No Data		
Ba-V	M2	Binary Vanadium	D
Ba-W	M2	Binary Tungsten	T
Ba-Y	M2	M2	D
Ba-Yb	M2,91	BAPD 9(3)	D
*Ba-Zn	M2	JPE 12(4)	D
Ba-Zr	No Data		

Be-Bi	M2	Binary Beryllium	D
Be-Br	M2	Binary Beryllium	T
Be-C	M2	Binary Beryllium	T
Be-Ca	M2,91	Binary Beryllium	D
Be-Cd	M2	Binary Beryllium	T
Be-Ce	M2	Binary Beryllium	D
Be-Cl	M2	Binary Beryllium	D
Be-Cm	M2	Binary Beryllium	T
*Be-Co	M2	BAPD 9(5)	D
*Be-Cr	M2	Binary Beryllium	D
Be-Cs	M2	Binary Beryllium	T
*Be-Cu	M2,92	BAPD 8(3)	D
Be-Dy	M2	Binary Beryllium	T
Be-Er	M2	Binary Beryllium	T
Be-Eu	M2	Binary Beryllium	T
Be-F	M2	Binary Beryllium	T
*Be-Fe	M2	Binary Iron	D
Be-Ga	M2	Binary Beryllium	D
Be-Gd	M2	Binary Beryllium	T
Be-Ge	M2	Binary Beryllium	D
Be-H	M2,91	Binary Beryllium	D

*Be-Hf	M2	Binary Beryllium	D
Be-Hg	M2	Binary Beryllium	T
Be-Ho	M2	Binary Beryllium	T
Be-I	M2	Binary Beryllium	T
Be-In	M2	Indium	D
Be-Ir	M2	Binary Beryllium	T
Be-K	M2	Binary Beryllium	T
Be-La	M2	Binary Beryllium	T
Be-Li	M2	Binary Beryllium	D
Be-Lu	M2	Binary Beryllium	T
Be-Mg	M2	Binary Magnesium	D
Be-Mn	M2	Binary Beryllium	T
Be-Mo	M2	Binary Beryllium	D
Be-N	M2	Binary Beryllium	T
Be-Na	M2	Binary Beryllium	D
*Be-Nb	M2,91	Binary Beryllium	D
Be-Nd	M2	Binary Beryllium	T
*Be-Ni	M2	Binary Nickel	D
Be-Np	M2	Binary Beryllium	T
Be-O	M2,91	Binary Beryllium	D
Be-Os	M2	Binary Beryllium	T

Be-P	M2	Binary Beryllium	T
Be-Pa	M2	Binary Beryllium	T
Be-Pb	M2	Binary Beryllium	T
*Be-Pd	M2	Binary Beryllium	D
Be-Pm	M2	M2	T
Be-Po	M2	Binary Beryllium	T
Be-Pr	M2	Binary Beryllium	T
Be-Pt	M2	Binary Beryllium	D
Be-Pu	M2	Binary Beryllium	D
Be-Rb	M2	Binary Beryllium	T
Be-Re	M2	Binary Beryllium	D
Be-Rh	M2	Binary Beryllium	T
Be-Ru	M2	Binary Beryllium	D
Be-S	M2	Binary Beryllium	T
Be-Sb	M2	Binary Beryllium	D
Be-Sc	M2	Binary Beryllium	T
Be-Se	M2	Binary Beryllium	T
*Be-Si	M2	Binary Beryllium	D
Be-Sm	M2	Binary Beryllium	T
Be-Sn	M2	Binary Beryllium	D
Be-Sr	M2	Binary Beryllium	D

Be-Ta	M2	Binary Beryllium	D
Be-Tb	M2	Binary Beryllium	T
Be-Tc	M2	Binary Beryllium	T
Be-Te	M2	Binary Beryllium	T
*Be-Th	M2	Binary Beryllium	D
*Be-Ti	M2	Binary Beryllium	D
Be-Tl	No Data		
Be-Tm	M2	Binary Beryllium	T
Be-U	M2	Binary Beryllium	D
Be-V	M2	Binary Vanadium	D
*Be-W	M2	Binary Tungsten	D
Be-Y	M2	Binary Beryllium	D
Be-Yb	M2	Binary Beryllium	D
Be-Zn	M2	Binary Beryllium	D
*Be-Zr	M2	Binary Beryllium	D
Bi-Br	M2	M2	D
Bi-C	M2	Unpublished	T
*Bi-Ca	M2,91	M2	D
*Bi-Cd	M2	BAPD 9(4)	D
Bi-Ce	M2	BAPD 9(4)	D
Bi-Cl	M2	M2	D

Bi-Cm	M2	M2	T
Bi-Co	M2	JPE 12(3)	D
Bi-Cr	M2	BAPD 9(3)	D
*Bi-Cs	M2	JPE 12(4)	D
*Bi-Cu	M2	BAPD 5(2)	D
Bi-Dy	M2	BAPD 10(4a)	D
Bi-Er	M2	M2	D
Bi-Eu	M2	BAPD 10(4a)	T
Bi-Fe	M2	Binary Iron	D
*Bi-Ga	M2	M2	D
Bi-Gd	M2	BAPD 10(4a)	D
*Bi-Ge	M2	BAPD 7(6)	D
Bi-H	M2	M2	T
Bi-Hf	M2	M2	D
*Bi-Hg	M2	Unpublished	D
Bi-Ho	M2	M2	D
Bi-I	M2	M2	D
*Bi-In	M2	Indium	D
Bi-Ir	M2	M2	D
*Bi-K	M2	JPE 12(1)	D
*Bi-La	M2	BAPD 10(4a)	D

*Bi-Li	M2	JPE 12(4)	D
Bi-Lu	M2	M2	D
*Bi-Mg	M2	Binary Magnesium	D
*Bi-Mn	M2	M2	D
Bi-Mo	M2	M2	D
Bi-N	M2	M2	T
*Bi-Na	M2	JPE 12(4)	D
Bi-Nb	M2	[Moffatt] 11	D
*Bi-Nd	M2	BAPD 10(4a)	D
*Bi-Ni	M2	Binary Nickel	D
Bi-Np	M2	M2	T
Bi-O	M2	M2	T
Bi-Os	M2	Unpublished	D
Bi-P	M2	M2	T
Bi-Pa	M2	BAPD 2(4)	T
*Bi-Pb	M2,92	JPE 13(1)	D
*Bi-Pd	M2	Unpublished	D
Bi-Pm	No Data		
Bi-Po	M2	M2	T
Bi-Pr	M2	M2	D
*Bi-Pt	M2	JPE 12(2)	D

Bi-Pu	M2	[Chiotti] 3	D
*Bi-Rb	M2	Unpublished	D
Bi-Re	M2	M2	D
Bi-Rh	M2	[Elliott] 4	D
Bi-Ru	M2	[Moffatt] 11	D
*Bi-S	M2	Unpublished	D
*Bi-Sb	M2	Unpublished	D
Bi-Sc	M2	BAPD 10(4a)	T
*Bi-Se	M2	Unpublished	D
Bi-Si	M2	BAPD 6(4)	D
*Bi-Sm	M2	M2	D
*Bi-Sn	M2	M2	D
*Bi-Sr	M2	[Elliott] 4	D
Bi-Ta	M2,92	JPE 13(3)	T
Bi-Tb	M2	M2	D
Bi-Tc	No Data		
*Bi-Te	M2	Unpublished	D
Bi-Th	M2	M2	D
Bi-Ti	M2	Binary Titanium	D
*Bi-Tl	M2	Unpublished	D
Bi-Tm	M2	M2	D

*Bi-U	M2	[Chiotti] 3	D
Bi-V	M2	Binary Vanadium	D
Bi-W	M2	Binary Tungsten	T
Bi-Xe	M2	[Elliott] 4	T
*Bi-Y	M2	BAPD 10(4a)	D
*Bi-Yb	M2	M2	D
*Bi-Zn	M2,91	M2	D
*Bi-Zr	M2,91	BAPD 11(3)	D
Bk-Mo	M2	[Molybdenum] 12	D
Bk-N	M2	M2	T
Bk-O	M2	M2	T
Bk-P	M2	M2	T
Bk-S	M2	M2	T
Bk-Sb	M2	M2	T
Bk-W		Binary Tungsten	T
Br-Cu	M2	Unpublished	D
Br-In	M2	Indium	D
Br-K	M2	M2	D
Br-Mg	M2	Binary Magnesium	T
Br-Mo	M2	M2	D
Br-Na	M2	M2	D

Br-Ni	M2	Binary Nickel	T
Br-Rb	M2	M2	D
Br-Sc	M2	M2	D
Br-Sr	M2	M2	D
Br-Te	M2	M2	D
Br-W	M2	Binary Tungsten	T
C-Ca	M2	M2	T
C-Cd	M2	M2	T
C-Ce	M2	M2	D
*C-Co	M2	JPE 12(4)	D
*C-Cr	M2	BAPD 11(2)	D
C-Cs	M2	[87Gor] 222	T
*C-Cu	M2	Unpublished	D
C-Dy	M2	BAPD 7(5)	T
C-Er	M2	BAPD 7(5)	T
C-Eu	M2	BAPD 7(5)	T
*C-Fe	M2	Binary Iron	D
C-Ga	No Data		
C-Gd	M2	BAPD 7(5)	T
C-Ge	M2	BAPD 5(5)	D
*C-Hf	M2	BAPD 11(4)	D

C-Hg	M2	M2	T
C-Ho	M2	BAPD 7(5)	T
C-In	M2	Indium	T
C-Ir	M2	M2	D
C-K	M2	M2	T
*C-La	M2	BAPD 7(5)	D
C-Li	M2	BAPD 10(1)	D
C-Lu	M2	BAPD 7(6)	T
C-Mg	M2	Binary Magnesium	T
*C-Mn	M2	M2	D
*C-Mo	M2	M2	D
C-Na	M2	M2	T
C-Nb	M2	Unpublished	D
C-Nd	M2	BAPD 7(6)	T
*C-Ni	M2	Binary Nickel	D
C-Np	M2	M2	T
C-Os	M2	[Moffatt] 11	D
C-Pa	M2	M2	T
C-Pb	M2	M2	T
C-Pd	M2	M2	D
C-Po	M2	M2	T

*C-Pr	M2	M2	D
C-Pt	M2	M2	D
C-Pu	M2	M2	D
C-Rb	M2	M2	T
C-Re	M2	M2	D
C-Rh	M2	M2	D
C-Ru	M2	M2	D
C-Sb	M2	M2	T
*C-Sc	M2	M2	D
C-Se	M2	M2	T
*C-Si	M2	BAPD 5(5)	D
C-Sm	M2	BAPD 7(6)	T
C-Sn	M2	M2	T
C-Sr	M2	M2	T
*C-Ta	M2	[86Bar1] 219	D
C-Tb	M2	BAPD 7(6)	T
C-Tc	M2,91	M2	D
C-Te	No Data		
*C-Th	M2	[69Ben1] 147	D
*C-Ti	M2	Binary Titanium	D
C-Tl	M2	M2	T

C-Tm	M2	BAPD 7(6)	T
*C-U	M2	[67Sto 140, 69Ben2 148]	D
*C-V	M2,91	Binary Vanadium	D
*C-W	M2,91	Binary Tungsten	D
*C-Y	M2	BAPD 7(6)	D
C-Yb	M2	BAPD 7(6)	T
C-Zn	M2	M2	T
*C-Zr	M2	M2	D
*Ca-Cd	M2	M2	D
Ca-Ce	M2	BAPD 8(6)	D
Ca-Cl	M2	M2	D
Ca-Cm	No Data		
Ca-Co	M2	M2	D
Ca-Cr	M2	BAPD 6(3)	T
Ca-Cs	M2	BAPD 6(2)	T
*Ca-Cu	M2	BAPD 5(6)	D
Ca-Dy	M2	BAPD 8(6)	T
Ca-Er	M2	BAPD 8(6)	T
Ca-Eu	M2	BAPD 8(6)	D
Ca-F	M2	M2	D
Ca-Fe	M2	Binary Iron	D

*Ca-Ga	M2,92	JPE 13(3)	D
Ca-Gd	M2	BAPD 8(6)	T
*Ca-Ge	M2	M2	D
Ca-H	M2	M2	D
*Ca-Hg	M2	M2	D
Ca-Ho	M2	M2	T
*Ca-In	M2	Indium	D
Ca-Ir	M2	Unpublished	T
Ca-K	M2	BAPD 6(1)	T
Ca-La	M2	BAPD 8(6)	D
*Ca-Li	M2	BAPD 8(2)	D
Ca-Lu	M2	M2	D
*Ca-Mg	M2	Binary Magnesium	D
Ca-Mn	M2	[Shunk] 17	D
Ca-Mo	M2	M2	D
Ca-N	M2	BAPD 11(5)	D
*Ca-Na	M2	BAPD 6(1)	D
Ca-Nb	M2	M2	T
*Ca-Nd	M2	BAPD 8(6)	D
*Ca-Ni	M2,91	Binary Nickel	D
Ca-Np	No Data		

*Ca-O	M2	BAPD 6(4)	D
Ca-Os	NoData		
Ca-P	M2	M2	T
*Ca-Pb	M2	JPE 13(2)	D
*Ca-Pd	M2,92	M2	D
Ca-Pm	M2	M2	D
Ca-Po	M2	M2	T
Ca-Pr	M2	BAPD 8(6)	T
*Ca-Pt	M2	M2	D
Ca-Pu	M2	BAPD 10(4a)	D
Ca-Rb	M2	BAPD 6(1)	T
Ca-Re	No Data		
Ca-Rh	M2	M2	T
Ca-Ru	No Data		
Ca-S	M2	M2	T
*Ca-Sb	M2	M2	D
Ca-Sc	M2	M2	D
Ca-Se	M2	M2	T
*Ca-Si	M2	M2	D
Ca-Sm	M2	BAPD 8(6)	T
Ca-Sn	M2,91	M2	D

*Ca-Sr	M2	BAPD 7(5)	D
Ca-Ta	No Data		
Ca-Tb	M2	M2	D
Ca-Te	M2	M2	T
Ca-Th	No Data		
Ca-Ti	M2	Binary Titanium	D
*Ca-Tl	M2	M2	D
Ca-Tm	M2	M2	D
Ca-U	M2	M2	T
Ca-V	M2	Binary Vanadium	D
Ca-W	M2	Binary Tungsten	T
Ca-Y	M2	BAPD 8(6)	D
*Ca-Yb	M2	BAPD 8(6)	D
*Ca-Zn	M2	BAPD 11(4)	D
Ca-Zr	No Data		
Cd-Ce	M2	BAPD 9(1)	D
Cd-Co	M2	M2	T
Cd-Cr	M2	JPE 13(2)	D
Cd-Cs	M2	BAPD 8(6)	D
*Cd-Cu	M2	BAPD 11(2)	D
Cd-Dy	M2	BAPD 9(1)	T

Cd-Er	M2	BAPD 9(1)	T
*Cd-Eu	M2	BAPD 9(1)	D
Cd-Fe	M2	Binary Iron	D
*Cd-Ga	M2	Unpublished	D
*Cd-Gd	M2	BAPD 9(1)	D
*Cd-Ge	M2	BAPD 7(2)	D
Cd-H	M2	M2	T
Cd-Hf	M2	M2	T
*Cd-Hg	M2	JPE 13(4)	D
Cd-Ho	M2	BAPD 9(1)	T
*Cd-In	M2	JPE 13(3)	D
Cd-Ir	No Data		
Cd-K	M2	BAPD 8(6)	D
Cd-Kr	M2	M2	T
*Cd-La	M2	BAPD 9(1)	D
*Cd-Li	M2	BAPD 9(1)	D
Cd-Lu	M2	BAPD 9(1)	T
*Cd-Mg	M2	BAPD 5(1)	D
Cd-Mn	M2	Unpublished	D
Cd-Mo	M2	M2	D
Cd-N	M2	BAPD 9(3)	T

*Cd-Na	M2	BAPD 9(1)	D
Cd-Nb	M2	M2	T
Cd-Nd	M2	BAPD 9(2)	D
*Cd-Ni	M2	Binary Nickel	D
Cd-Np	M2	BAPD 2(4)	D
Cd-O	M2	BAPD 8(2)	D
Cd-Os	M2	M2	T
*Cd-P	M2	M2	D
*Cd-Pb	M2	BAPD 9(6)	D
Cd-Pd	M2	M2	D
Cd-Pm	M2	M2	D
Cd-PO	M2	M2	T
Cd-Pr	M2	BAPD 9(2)	D
Cd-Pt	M2	[52Now] 45	D
Cd-Pu	M2	[64Wit] 117	D
Cd-Rb	M2	BAPD 8(6)	D
Cd-Re	M2	M2	T
Cd-Rh	M2	M2	T
Cd-Ru	No Data		
Cd-S	M2	Unpublished	D
*Cd-Sb	M2	M2	D

Cd-Sc	M2	BAPD 9(2)	T
*Cd-Se	M2	Unpublished	D
Cd-Si	M2	BAPD 6(6)	D
*Cd-Sm	M2	BAPD 9(2)	D
*Cd-Sn	M2	BAPD 10(3)	D
*Cd-Sr	M2	M2	D
Cd-Ta	No Data		
Cd-Tb	M2	BAPD 9(2)	T
Cd-Tc	M2	M2	T
*Cd-Te	M2	BAPD 10(4)	D
*Cd-Th	M2	Unpublished	D
Cd-Ti	M2	Binary Titanium	D
*Cd-Tl	M2	M2	D
Cd-Tm	M2	BAPD 9(2)	T
Cd-U	M2	BAPD 1(2)	D
Cd-V	M2	Binary Vanadium	D
Cd-W	M2	Binary Tungsten	T
*Cd-Y	M2	BAPD 9(2)	D
*Cd-Yb	M2	BAPD 9(2)	D
*Cd-Zn	M2	BAPD 5(1)	D
Cd-Zr	M2	[Zirconium] 21	D

Ce-Cl	M2	M2	D
Ce-Cm	No Data		
*Ce-Co	M2	[74Gsc1] 174	D
Ce-Cr	M2	BAPD 11(5)	D
Ce-Cs	No Data		
*Ce-Cu	M2	BAPD 9(3a)	D
Ce-Dy	M2	BAPD 3(1)	T
Ce-Er	M2	M2	D
Ce-Eu	M2	BAPD 3(2)	D
*Ce-Fe	M2	Binary Iron	D
*Ce-Ga	M2	M2	D
Ce-Gd	M2	BAPD 3(2)	D
*Ce-Ge	M2	BAPD 10(2)	D
Ce-H	M2	M2	D
Ce-Hf	M2	M2	D
Ce-Hg	M2	Unpublished	D
Ce-Ho	M2	M2	D
*Ce-In	M2	Indium	D
*Ce-Ir	M2	JPE 12(5)	D
Ce-La	M2	BAPD 2(4)	D
Ce-Li	No Data		

Ce-Lu	M2	M2	D
*Ce-Mg	M2	Binary Magnesium	D
*Ce-Mn	M2	Unpublished	D
Ce-Mo	M2	Unpublished	D
Ce-N	M2	[74Gsc2] 175	D
Ce-Na	No Data		
Ce-Nb	M2	M2	D
Ce-Nd	M2	M2	D
*Ce-Ni	M2	Binary Nickel	D
Ce-Np	No Data		
*Ce-O	M2	M2	D
Ce-Os	M2	M2	T
Ce-P	M2	M2	T
Ce-Pb	M2	M2	D
*Ce-Pd	M2,91	M2	D
Ce-Pm	M2	M2	D
Ce-Po	M2	[Shunk] 17	T
Ce-Pr	M2	BAPD 3(2)	D
Ce-Pt	M2	M2	D
*Ce-Pu	M2	[Plutonium] 16	D
Ce-Rb	No Data		

Ce-Re	M2	M2	T
Ce-Rh	M2	M2	D
Ce-Ru	M2,92	M2	D
*Ce-S	M2	[74Gsc1] 174	D
Ce-Sb	M2	M2	D
Ce-Sc	M2	BAPD 3(2)	D
Ce-Se	M2	M2	D
*Ce-Si	M2	BAPD 10(1)	D
Ce-Sm	M2	BAPD 3(2)	D
*Ce-Sn	M2	M2	D
Ce-Sr	No Data		
Ce-Ta	M2	[66Den1] 123	D
Ce-Tb	M2	M2	D
Ce-Tc	M2	M2	T
*Ce-Te	M2	M2	D
Ce-Th	M2	M2	D
*Ce-Ti	M2	Binary Titanium	D
*Ce-Tl	M2	Unpublished	D
Ce-Tm	M2	M2	D
Ce-U	M2	[Elliott] 4	D
Ce-V	M2	Binary Vanadium	D

Ce-W	M2	Binary Tungsten	D
Ce-Y	M2	BAPD 3(2)	D
Ce-Yb	M2	BAPD 3(1)	T
*Ce-Zn	M2	M2	D
Ce-Zr	M2,91	JPE 12(1)	D
Cf-Mo	M2	[Molybdenum] 12	D
Cf-O	M2	M2	T
Cf-Pt	M2	M2	T
Cf-S	M2	M2	T
Cf-Sb	M2	M2	T
Cf-W		Binary Tungsten	T
*Cl-Cs	M2	M2	D
Cl-Cu	M2	Unpublished	D
Cl-Dy	M2	M2	D
Cl-Er	M2	M2	D
*Cl-Ga	M2	M2	D
Cl-Gd	M2	M2	D
*Cl-Hg	M2	M2	D
*Cl-In	M2	Indium	D
Cl-K	M2	M2	D
Cl-La	M2	M2	D

Cl-Mg	M2	Binary Magnesium	T
Cl-Mo	M2	M2	D
*Cl-Na	M2	M2	D
Cl-Ni	M2	Binary Nickel	D
Cl-Pd	M2	M2	D
Cl-Rb	M2	M2	D
Cl-Sc	M2	M2	D
Cl-Sn	M2	M2	D
Cl-Sr	M2	M2	D
Cl-Te	M2	M2	D
Cl-Th	M2	M2	D
Cl-Tl	M2	M2	D
Cl-Tm	M2	M2	D
Cl-W	M2	Binary Tungsten	T
Cl-Y	M2	M2	D
Cl-Yb	M2	M2	D
Cm-Cr	M2	BAPD 6(5)	D
Cm-Cu	M2	M2	T
Cm-Ir	M2	M2	T
Cm-Mo	M2	[Molybdenum] 12	D
Cm-N	M2	M2	T

Cm-O	M2	M2	T
Cm-P	M2	M2	T
Cm-Pd	M2	M2	T
Cm-Pt	M2	BAPD 10(2)	D
Cm-Rh	M2	M2	T
Cm-S	M2	M2	T
Cm-Sb	M2	M2	T
Cm-Se	M2	M2	T
Cm-Si	M2	M2	T
Cm-Te	M2	M2	T
Cm-W	M2	Binary Tungsten	T
*CO-Cr	M2	BAPD 11(4)	D
Co-Cs	No Data		
*CO-Cu	M2	BAPD 5(2)	D
*Co-Dy	M2	M2	D
*Co-Er	M2	M2	D
Co-Eu	No Data		
*Co-Fe	M2	Binary Iron	D
*Co-Ga	M2	M2	D
*Co-Gd	M2	M2	D
*Co-Ge	M2	JPE 12(1)	D

Co-H	M2	M2	D
*Co-Hf	M2	JPE 12(4)	D
Co-Hg	M2	M2	T
*Co-Ho	M2	M2	D
Co-In	M2	Indium	D
Co-Ir	M2	[52Kos] 46	D
Co-K	M2	Unpublished	T
Co-La	M2	[74Ray1] 177	D
Co-Li	M2	BAPD 11(5)	T
Co-Lu	M2	M2	D
Co-Mg	M2	Binary Magnesium	D
*Co-Mn	M2	BAPD 11(2)	D
*Co-Mo	M2	[Molybdenum] 12	D
Co-N	M2	Unpublished	T
Co-Na	M2	BAPD 11(5)	T
*Co-Nb	M2	[67Par] 138	D
*Co-Nd	M2	[74Ray2] 178	D
*CO-Ni	M2	Binary Nickel	D
Co-Np	M2	M2	T
Co-O	M2	M2	D
Co-Os	M2	[52Kos] 46	D

*Co-P	M2	BAPD 11(6)	D
Co-Pb	M2	M2	D
*Co-Pd	M2,91	JPE 12(1)	D
Co-Pm	No Data		
*Co-Pr	M2	[74Ray1] 177	D
*Co-Pt	M2	M2	D
*Co-Pu	M2	[61Poo] 88	D
Co-Rb	M2	Unpublished	T
*Co-Re	M2	M2	D
Co-Rh	M2	[52Kos] 46	D
Co-Ru	M2	[52Kos] 46	D
*Co-S	M2	[08Fri] 29	D
*Co-Sb	M2,91	BAPD 11(3)	D
Co-Sc	M2	[Moffatt] 11	D
*Co-Se	M2	M2	D
*CO-Si	M2	JPE 12(5)	D
*Co-Sm	M2	[Moffatt] 11	D
*CO-Sn	M2	JPE 12(1)	D
Co-Sr	M2	JPE 13(3)	T
*Co-Ta	M2,91	[86Bar2] 220	D
*Co-Tb	M2	M2	D

Co-Tc	M2	M2	T
*Co-Te	M2	Unpublished	D
*Co-Th	M2	Unpublished	D
Co-Ti	M2	Binary Titanium	D
*Co-Tl	M2	M2	T
Co-Tm	M2	M2	T
Co-U	M2	Unpublished	D
*Co-V	M2	JPE 12(3)	D
*Co-W	M2	Binary Tungsten	D
*Co-Y	M2,92	JPE 12(5)	D
Co-Yb	M2	[76Ian] 185	D
*Co-Zn	M2	M2	D
Co-Zr	M2	[64Pec] 113	D
Cr-Cs	M2	BAPD 5(4)	D
*Cr-Cu	M2	BAPD 5(4)	D
Cr-Dy	M2	M2	D
Cr-Er	M2	M2	D
Cr-Eu	M2	M2	D
*Cr-Fe	M2	Binary Iron	D
*Cr-Ga	M2	[72Bor] 162	D
Cr-Gd	M2	[Elliott] 4	D

*Cr-Ge	M2	BAPD 7(5)	D
Cr-H	M2	JPE 12(6)	D
*Cr-Hf	M2	BAPD 7(6)	D
Cr-Hg	M2	BAPD 10(2)	D
Cr-Ho	M2	[75Sve] 183	D
Cr-In	M2	Indium	D
*Cr-Ir	M2	BAPD 11(1)	D
Cr-K	M2	BAPD 5(4)	D
Cr-La	M2	M2	D
Cr-Li	M2	BAPD 5(4)	D
*Cr-Lu	M2,92	[Moffatt] 11	D
Cr-Mg	M2	Binary Magnesium	T
*Cr-Mn	M2	BAPD 7(5)	D
*Cr-Mo	M2	BAPD 8(3)	D
Cr-N	M2	Unpublished	D
Cr-Na	M2	BAPD 5(4)	D
*Cr-Nb	M2	BAPD 7(5)	D
Cr-Nd	M2	[Moffatt] 11	D
*Cr-Ni	M2	Binary Nickel	D
Cr-Np	M2	BAPD 6(5)	D
*Cr-O	M2	[80Ban] 201	D

*Cr-Os	M2	BAPD 11(1)	D
Cr-P	M2	BAPD 11(5)	D
Cr-Pb	M2	BAPD 9(2)	D
*Cr-Pd	M2	BAPD 11(1)	D
Cr-Pm	No Data		
Cr-Po	M2	BAPD 9(2)	T
Cr-Pr	M2	M2	D
*Cr-Pt	M2	BAPD 11(1)	D
Cr-Pu	M2	BAPD 6(5)	D
Cr-Ra	M2	BAPD 6(4)	T
Cr-Rb	M2	BAPD 5(4)	D
*Cr-Re	M2	BAPD 8(2)	D
*Cr-Rh	M2	BAPD 8(2)	D
*Cr-Ru	M2	BAPD 8(2)	D
*Cr-S	M2,91	Unpublished	D
*Cr-Sb	M2,92	BAPD 11(5)	D
*Cr-Sc	M2	BAPD 6(5)	D
*Cr-Se	M2	Unpublished	D
*Cr-Si	M2	BAPD 8(5)	D
Cr-Sm	M2	[73Sve] 173	D
*Cr-Sn	M2	BAPD 9(2)	D

Cr-Sr	M2	BAPD 6(4)	T
*Cr-Ta	M2	BAPD 8(2)	D
Cr-Tb	M2	[71Sve] 161	D
Cr-Tc	M2	BAPD 7(6)	D
*Cr-Te	M2	Unpublished	D
Cr-Th	M2	BAPD 6(5)	D
*Cr-Ti	M2	Binary Titanium	D
Cr-Tl	No Data		
Cr-Tm	M2	M2	D
*Cr-U	M2	BAPD 6(5)	D
*Cr-V	M2	Binary Vanadium	D
*Cr-W	M2	Binary Tungsten	D
Cr-Y	M2,92	BAPD 6(5)	D
Cr-Yb	M2	M2	D
Cr-Zn	M2	JPE 13(2)	D
*Cr-Zr	M2	BAPD 7(3)	D
Cs-Cu	M2	BAPD 8(1)	T
Cs-F	M2	M2	D
Cs-Fe	M2	Binary Iron	T
Cs-Ga	M2	BAPD 11(4)	D
*Cs-G	M2	M2	D

Cs-H	M2	M2	T
Cs-Hf	M2	BAPD 8(1)	D
*Cs-Hg	M2	[Hansen] 6	D
Cs-Ho	No Data		
Cs-I	M2	M2	D
*Cs-In	M2	Indium	D
Cs-Ir	M2	M2	T
*Cs-K	M2	BAPD 4(4)	D
Cs-La	No Data		
Cs-Li	M2	BAPD 10(3)	D
Cs-Lu	No Data		
Cs-Mg	M2	Binary Magnesium	D
Cs-Mo	M2,91	M2	D
Cs-N	M2	M2	T
*Cs-Na	M2	BAPD 3(3)	D
Cs-Nb	M2	BAPD 9(1)	D
Cs-Nd	No Data		
Cs-Ni	No Data		
Cs-Np	NoData		
*Cs-O	M2	M2	D
Cs-Os	M2	[81Loe] 209	T

Cs-P	M2	M2	T
Cs-Pb	M2	M2	T
Cs-Pd	M2	[81Loe] 209	T
Cs-Pr	M2	M2	D
Cs-Pt	M2	[81Loe] 209	T
Cs-Pu	No Data		
*Cs-Rb	M2	BAPD 4(4)	D
Cs-Re	No Data		
Cs-Rh	M2	[81Loe] 209	T
Cs-Ru	M2	[81Loe] 209	T
*Cs-S	M2	[Smithells] 19	D
*Cs-Sb	M2	[61Dor2] 83	D
Cs-Sc	No Data		
*Cs-Se	M2	M2	D
Cs-Si	M2	M2	T
Cs-Sm	No Data		
*Cs-Sn	M2	[87Mel] 223	D
Cs-Sr	M2	BAPD 6(1)	T
Cs-Ta	M2,91	JAPD 6(2)	D
*Cs-Te	M2	Unpublished	D
Cs-Th	No Data		

Cs-Ti	M2	BAPD 10(2)	D
*Cs-Tl	M2	[81Bus] 207	D
Cs-Tm	No Data		
Cs-U	No Data		
Cs-V	M2	Binary Vanadium	D
Cs-W	M2	Binary Tungsten	T
Cs-Y	No Data		
Cs-Yb	No Data		
Cs-Zn	M2	BAPD 8(5)	T
Cs-Zr	M2	BAPD 8(1)	D
*Cu-Dy	M2	BAPD 9(3a)	D
*Cu-Er	M2	BAPD 9(3a)	D
*Cu-Eu	M2	BAPD 9(3a)	D
Cu-F	M2	Unpublished	T
*Cu-Fe	M2	Binary Iron	D
Cu-Fr	M2	M2	T
*Cu-Ga	M2	Unpublished	D
*Cu-Gd	M2	BAPD 9(3a)	D
*Cu-Ge	M2	BAPD 7(1)	D
*Cu-H	M2	[86Bar3] 221	D
Cu-He	M2	Unpublished	T

*Cu-Hf	M2	BAPD 9(1)	D
*Cu-Hg	M2	BAPD 6(6)	D
Cu-Ho	M2	BAPD 9(3a)	D
Cu-I	M2	M2	T
*Cu-In	M2,91	Indium	D
*Cu-Ir	M2	BAPD 8(2)	D
Cu-K	M2	BAPD 7(3)	T
Cu-Kr	M2	Unpublished	T
*Cu-La	M2,91	BAPD 2(3)	D
*Cu-Li	M2	BAPD 7(2)	D
Cu-Lu	M2	BAPD 9(3a)	D
*Cu-Mg	M2,92	Binary Magnesium	D
*Cu-Mn	M2	Unpublished	D
Cu-Mo	M2	BAPD 11(2)	D
Cu-N	M2	M2	T
Cu-Na	M2	BAPD 7(2)	D
*Cu-Nb	M2,91	BAPD 2(4)	D
*Cu-Nd	M2	BAPD 9(3a)	D
Cu-Ne	M2	Unpublished	T
*Cu-Ni	M2	Binary Nickel	D
Cu-Np	M2	M2	T

*Cu-O	M2,91	BAPD 5(2)	D
Cu-Os	M2	Unpublished	D
*Cu-P	M2	M2	D
Cu-Pa	M2	M2	T
*Cu-Pb	M2	BAPD 5(5)	D
*Cu-Pd	M2	JPE 12(2)	D
Cu-Pm	M2	BAPD 9(3a)	D
Cu-Po	M2	Unpublished	T
Cu-Pr	M2	BAPD 9(3a)	D
*Cu-Pt	M2	Unpublished	D
*Cu-Pu	M2	[67Kut1] 135	D
Cu-Ra	M2	[68Gul1] 141	T
Cu-Rb	M2	BAPD 7(1)	T
Cu-Re	M2	Unpublished	D
*Cu-Rh	M2	BAPD 2(4)	D
Cu-Rn	M2	Unpublished	T
Cu-Ru	M2,92	Unpublished	D
*Cu-S	M2	BAPD 4(3)	D
*Cu-Sb	M2	M2	D
Cu-Sc	M2	BAPD 9(3a)	D
*Cu-Se	M2	BAPD 2(3)	D

*Cu-Si	M2	BAPD 7(2)	D
Cu-Sm	M2	BAPD 9(3a)	D
*Cu-Sn	M2	BAPD 11(3)	D
*Cu-Sr	M2	BAPD 5(4)	D
Cu-Ta	M2	BAPD 10(6)	D
Cu-Tb	M2	BAPD 9(3a)	D
Cu-Tc	M2	Unpublished	D
*Cu-Te	M2	Unpublished	D
*Cu-Th	M2	BAPD 7(1)	D
*Cu-ti	M2	Binary Titanium	D
*Cu-Tl	M2	BAPD 5(2)	D
Cu-Tm	M2	BAPD 9(3a)	D
Cu-U	M2	[Metals] 10	D
*Cu-V	M2	Binary Vanadium	D
Cu-W	M2	Binary Tungsten	D
Cu-Xe	M2	Unpublished	T
Cu-Y	M2,92	BAPD 2(3)	D
*Cu-Yb	M2	BAPD 9(3a)	D
*Cu-Zn	M2	Unpublished	D
*Cu-Zr	M2	BAPD 11(5)	D
D-Fe		Binary Iron	D

D-Nb	M2	BAPD 4(1)	T
D-Ta	92	[90Con] 225	D
D-V	M2	Binary Vanadium	D
Dy-Er	M2	BAPD 4(3)	D
*Dy-Fe	M2	Binary Iron	D
*Dy-Ga	M2	[Moffatt] 11	D
Dy-Gd	M2	BAPD 4(3)	D
*Dy-Ge	M2,91	[77Ere] 188	D
Dy-H	M2	[58Mul] 63	D
Dy-Hf	No Data		
Dy-Hg	M2	Unpublished	D
Dy-Ho	M2	BAPD 4(3)	D
Dy-I	M2	M2	D
*Dy-In	M2	Indium	D
Dy-Ir	M2	JPE 13(2)	D
Dy-K	No Data		
Dy-La	M2	M2	D
Dy-Lu	M2	M2	D
Dy-Mg	M2,92	Binary Magnesium	D
*Dy-Mn	M2	[67Kirl] 133	D
Dy-Mo	M2	M2	D

Dy-N	M2	M2	T
Dy-Na	No Data		
Dy-Nb	No Data		
Dy-Nd	M2	BAPD 3(3)	D
*Dy-Ni	M2	Binary Nickel	D
Dy-Np	No Data		
Dy-O	M2	M2	T
Dy-Os	M2	[8OPal 205, 59Boz 64]	T
Dy-P	M2	M2	T
*Dy-Pb	M2	[68Mcm] 144	D
*Dy-Pd	M2	M2	D
Dy-Pm	M2	M2	D
Dy-Po	M2	M2	T
Dy-Pr	M2	M2	D
Dy-Pt	M2	M2	D
Dy-Pu	M2,92	M2	D
Dy-Re	M2	[65E11] 119	T
Dy-Rh	M2	M2	D
Dy-Ru	M2	M2	D
*Dy-S	M2	M2	D
*Dy-Sb	M2	M2	D

Dy-Sc	No Data		
Dy-Se	M2	M2	T
Dy-Si	M2	M2	T
Dy-Sm	M2	M2	D
*Dy-Sn	M2	M2	D
Dy-Sr	No Data		
Dy-Ta	M2	[66Den1] 123	D
Dy-Tb	M2	M2	D
Dy-Tc	M2	M2	T
*Dy-Te	M2	M2	D
Dy-Th	M2	[69Bad] 146	D
Dy-Ti	M2	M2	D
*Dy-Tl	M2	Unpublished	D
Dy-Tm	M2	M2	D
Dy-U	M2	M2	T
Dy-V	M2	Binary Vanadium	D
Dy-W	M2	Binary Tungsten	D
Dy-Y	M2	BAPD 4(1)	D
Dy-Yb	M2	M2	D
Dy-Zn	M2	M2	D
*Dy-Zr	M2	[60Cro] 71	D

*Er-Fe	M2	Binary Iron	D
*Er-Ga	M2	M2	D
Er-Gd	M2	BAPD 4(3)	D
*Er-Ge	M2	M2	D
Er-H	M2	[58Mul] 63	D
Er-Hf	M2	[Hafnium] 5	D
Er-Hg	M2	Unpublished	D
Er-Ho	M2	BAPD 4(3)	D
Er-I	M2	M2	D
*Er-In	M2	Indium	D
Er-Ir	M2	JPE 13(2)	D
Er-K	No Data		
Er-La	M2	M2	D
Er-Li	No Data		
Er-Lu	M2	M2	D
Er-Mg	M2	Binary Magnesium	D
*Er-Mn	M2	[67Kir2] 134	D
Er-Mo	M2	M2	D
Er-N	M2	M2	T
Er-Na	No Data		
Er-Nb	M2	[61Lov] 87	T

Er-Nd	M2	BAPD 3(3)	D
*Er-Ni	M2	Binary Nickel	D
Er-Np	No Data		
Er-O	M2	[61Lov] 87	D
Er-Os	M2	M2	T
Er-P	M2	M2	T
Er-Pb	M2	M2	T
*Er-Pd	M2,91	[73Loe] 171	D
Er-Pm	M2	M2	D
Er-Po	M2	[Shunk] 17	T
Er-Pr	M2	M2	D
*Er-Pt	M2	M2	D
Er-Pu	M2	M2	D
Er-Re	M2	M2	D
Er-Rh	M2	[73Gha] 169	D
*Er-Ru	M2	M2	D
Er-S	M2	M2	T
Er-Sb	M2	M2	T
Er-Sc	M2	BAPD 4(1)	D
*Er-Se	M2	M2	D
Er-Si	M2	M2	D

Er-Sm	M2	M2	D
Er-Sn	M2	M2	D
Er-Ta	M2	[66Den1] 123	D
Er-Tb	M2	BAPD 4(3)	D
Er-Tc	M2	M2	T
*Er-Te	M2	M2	D
Er-Th	M2	M2	D
*Er-Ti	M2	Binary Titanium	D
*Er-Tl	M2	Unpublished	D
Er-Tm	M2	M2	D
Er-U	M2	M2	T
Er-V	M2	Binary Vanadium	D
Er-W	M2	Binary Tungsten	D
Er-Y	M2	BAPD 4(1)	D
Er-Yb	M2	M2	D
Er-Zn	M2	M2	D
Er-Zr	M2	[Zirconium] 21	D
Es-Mo	M2	[Molybdenum] 12	D
Es-O	M2	M2	T
Es-W		Binary Tungsten	T
Eu-Fe	M2	Binary Iron	D

*Eu-Ga	M2	[78Yat] 197	D
*Eu-Ge	M2	JPE 12(4)	D
Eu-H	M2	M2	T
Eu-Hf	M2	M2	D
Eu-Hg	M2	Unpublished	T
Eu-Ho	M2	BAPD 4(2)	T
*Eu-In	M2	Indium	D
Eu-Ir	M2	Unpublished	T
Eu-K	No Data		
Eu-La	M2,91	M2	D
*Eu-Mg	M2,92	Binary Magnesium	D
Eu-Mn	M2	M2	D
Eu-Mo	M2	M2	D
Eu-N	M2	M2	T
Eu-Na	No Data		
Eu-Nb	M2	M2	D
Eu-Ni	M2,92	Binary Nickel	D
Eu-Np	No Data		
Eu-O	M2	M2	D
Eu-Os	No Data		
Eu-P	M2	M2	T

*Eu-Pb	M2	[67Mcm] 137	D
*Eu-Pd	M2	M2	D
Eu-Po	M2	M2	T
Eu-Pr	No Data		
*Eu-Pt	M2	[81Ian] 208	D
Eu-Pu	M2	M2	D
Eu-Re	M2	M2	T
Eu-Rh	No Data		
Eu-Ru	No Data		
Eu-S	M2	M2	D
Eu-Sb	M2	M2	T
Eu-Sc	M2	M2	D
Eu-Se	M2	M2	T
Eu-Si	M2	M2	T
Eu-Sm	M2	M2	T
Eu-Sn	M2	M2	T
Eu-Sr	No Data		
Eu-Ta	M2	M2	D
Eu-Tb	No Data		
*Eu-Te	M2	[70Sad] 153	D
Eu-Th	M2	M2	D

Eu-Ti	M2	Binary Titanium	T
Eu-Tl	M2	M2	T
Eu-U	M2	M2	D
Eu-V	M2	Binary Vanadium	D
Eu-W	M2	Binary Tungsten	D
Eu-Y	M2	M2	D
Eu-Yb	M2	M2	D
Eu-Zn	M2	M2	D
Eu-Zr	M2	M2	D
F-In	M2	Indium	T
F-K	M2	M2	D
F-Mg	M2	Binary Magnesium	T
F-Mo	M2	M2	D
F-Na	M2	M2	D
F-Ni	M2	Binary Nickel	T
F-Rb	M2	M2	D
F-Sm	M2	M2	D
F-Sn	M2	M2	D
F-W	92	Binary Tungsten	T
F-Yb	M2	M2	D
*Fe-Ga	M2,91	Binary Iron	D

*Fe-Gd	M2	Binary Iron	D
*Fe-Ge	M2	Binary Iron	D
*Fe-H	M2	Binary Iron	D
*Fe-Hf	M2	Binary Iron	D
Fe-Hg	M2	Binary Iron	D
*Fe-Ho	M2,91	Binary Iron	D
Fe-In	M2	Binary Iron	D
*Fe-Ir	M2	Binary Iron	D
Fe-K	M2	Binary Iron	D
*Fe-La	M2	Binary Iron	D
Fe-Li	M2	Binary Iron	D
*Fe-Lu	M2	Binary Iron	D
Fe-Mg	M2	Binary Iron	D
*Fe-Mn	M2	Binary Iron	D
*Fe-Mo	M2	Binary Iron	D
*Fe-N	M2	Binary Iron	D
Fe-Na	M2	Binary Iron	D
*Fe-Nb	M2	Binary Iron	D
*Fe-Nd	M2	Binary Iron	D
*Fe-Ni	M2	Binary Iron	D
Fe-Np	M2	Binary Iron	T

*Fe-O	M2	Binary Iron	D
Fe-Os	M2	Binary Iron	D
*Fe-P	M2	Binary Iron	D
Fe-Pb	M2	Binary Iron	D
*Fe-Pd	M2	Binary Iron	D
Fe-Pm	M2	Binary Iron	D
Fe-Pr	M2	Binary Iron	D
Fe-Pt	M2	Binary Iron	D
*Fe-Pu	M2	Binary Iron	D
Fe-Rb	M2	Binary Iron	T
Fe-Re		Binary Iron	D
*Fe-Rh	M2	Binary Iron	D
Fe-Ru	M2	Binary Iron	D
*Fe-S	M2	Binary Iron	D
*Fe-Sb	M2	Binary Iron	D
*Fe-Sc	M2	Binary Iron	D
*Fe-Se	M2,91	Binary Iron	D
*Fe-Si	M2	Binary Iron	D
*Fe-Sm	M2	Binary Iron	D
*Fe-Sn	M2,92	Binary Iron	D
Fe-Sr	M2	Binary Iron	D

Fe-Ta	M2	Binary Iron	D
*Fe-Tb	M2	Binary Iron	D
Fe-Tc	M2	Binary Iron	D
*Fe-Te	M2	Binary Iron	D
*Fe-Th	M2,91	Binary Iron	D
*Fe-Ti	M2	Binary Iron	D
Fe-Tl	M2	Binary Iron	T
*Fe-Tm	M2	Binary Iron	D
*Fe-U	M2	Binary Iron	D
*Fe-V	M2	Binary Iron	D
*Fe-W	M2	Binary Iron	D
Fe-Y	M2	Binary Iron	D
Fe-Yb	M2	Binary Iron	D
*Fe-Zn	M2	Binary Iron	D
*Fe-Zr	M2	Binary Iron	D
Fm-Mo	M2	[Molybdenum] 12	D
Fr-Mg	M2	[68Gul2] 142	T
Fr-Mo	M2	[Molybdenum] 12	D
Fr-W		Binary Tungsten	T
*Ga-Gd	M2	BAPD 11(1)	D
Ga-Ge	M2	BAPD 6(3)	D

Ga-H	No Data		
Ga-Hf	M2	M2	D
Ga-Hg	M2	[60Pre] 78	D
*Ga-Ho	M2	M2	D
Ga-I	M2	M2	D
*Ga-In	M2	Indium	D
Ga-Ir	M2	M2	T
Ga-K	M2	BAPD 11(4)	D
*Ga-La	M2	BAPD 11(1)	D
*Ga-Li	M2	JPE 12(1)	D
*Ga-Lu	M2	[79Yat] 200	D
*Ga-Mg	M2,91	Binary Magnesium	D
*Ga-Mn	M2	[80Lu] 204	D
*Ga-Mo	M2	[Molybdenum] 12	D
Ga-N	M2	M2	T
*Ga-Na	M2	BAPD 11(4)	D
*Ga-Nb	M2	M2	D
*Ga-Nd	M2	[Moffatt] 11	D
*Ga-Ni	M2	Binary Nickel	D
Ga-Np	M2	M2	T
Ga-O	M2	M2	T

Ga-Os	M2	M2	T
Ga-P	M2	[Shunk] 17	D
*Ga-Pb	M2	JPE 12(1)	D
*Ga-Pd	M2	M2	D
Ga-Pm	M2,92	M2	D
*Ga-Pr	M2	M2	D
*Ga-Pt	M2	M2	D
*Ga-Pu	M2	BAPD 9(3)	D
Ga-Rb	M2,92	BAPD 11(4)	D
Ga-Re	M2	M2	D
Ga-Rh	M2	M2	T
Ga-Ru	M2	M2	T
*Ga-S	M2	[67Rus] 139	D
*Ga-Sb	M2	BAPD 9(5)	D
*Ga-Sc	M2	[79Yat] 200	D
*Ga-Se	M2	[Moffatt] 11	D
Ga-Si	M2	BAPD 6(4)	D
*Ga-Sm	M2	[Moffatt] 11	D
*Ga-Sn	M2	JPE 13(2)	D
*Ga-Sr	M2	JPE 13(2)	D
Ga-Ta	M2	M2	D

*Ga-Tb	M2	[Moffatt] 11	D
*Ga-Te	M2	Unpublished	D
Ga-Th	M2	M2	T
Ga-Ti	M2	Binary Titanium	D
*Ga-Tl	M2	JPE 12(6)	D
*Ga-Tm	M2	[Moffatt] 11	D
*Ga-U	M2	[73Bus] 168	D
*Ga-V	M2	Binary Vanadium	D
Ga-W	M2	Binary Tungsten	T
*Ga-Y	M2	[77Yat] 193	D
*Ga-Yb	M2,92	JPE 13(1)	D
*Ga-Zn	M2	BAPD 11(1)	D
*Ga-Zr	M2	[Shunk] 17	D
*Gd-Ge	M2	BAPD 10(2)	D
Gd-H	M2	[60Bec] 69	D
Gd-Hg	M2	Unpublished	D
Gd-Ho	M2	BAPD 4(3)	D
Gd-I	M2	M2	D
*Gd-In	M2	Indium	D
Gd-Ir	M2	Unpublished	D
Gd-K	No Data		

Gd-La	M2	BAPD 2(4)	D
Gd-Li	No Data		
Gd-Lu	M2	M2	D
*Gd-Mg	M2	Binary Magnesium	D
Gd-Mn	M2	M2	D
Gd-Mo	M2	BAPD 1(2)	D
Gd-N	M2	M2	T
Gd-Na	No Data		
Gd-Nb	M2	M2	T
Gd-Nd	M2	BAPD 3(3)	D
*Gd-Ni	M2	Binary Nickel	D
Gd-Np	No Data		
Gd-O	M2	M2	T
Gd-Os	M2	[80Pal] 205	T
Gd-P	M2	M2	T
*Gd-Pb	M2	JPE 12(6)	D
*Gd-Pd	M2	M2	D
Gd-Pm	M2	M2	D
Gd-Po	M2	M2	T
Gd-Pr	M2	M2	D
Gd-Pt	M2	M2	D

Gd-Pu	M2	M2	D
Gd-Re	M2	M2	D
*Gd-Rh	M2	M2	D
Gd-Ru	M2	[Moffatt] 11	D
Gd-S	M2	M2	D
*Gd-Sb	M2	M2	D
Gd-Sc	M2	BAPD 4(2)	D
*Gd-Se	M2	[82Pri] 213	D
Gd-Si	M2	BAPD 9(5)	D
Gd-Sm	M2	BAPD 4(2)	D
*Gd-Sn	M2	JPE 12(6)	D
Gd-Sr	No Data		
Gd-Ta	M2	[66Den1] 123	D
Gd-Tb	M2	BAPD 4(3)	D
Gd-Tc	M2	M2	T
*Gd-Te	M2	M2	D
Gd-Th	M2	[69Bad] 146	D
*Gd-Ti	M2	Binary Titanium	D
*Gd-Tl	M2	Unpublished	D
Gd-Tm	M2	M2	D
Gd-U	M2	[Elliott] 4	T

Gd-V	M2	Binary Vanadium	D
Gd-W	M2	Binary Tungsten	D
Gd-Y	M2	BAPD 4(2)	D
Gd-Yb	M2	BAPD 4(3)	D
Gd-Zn	M2	M2	D
Gd-Zr	M2	M2	D
Ge-H	M2	[Elliott] 4	T
Ge-Hf	M2	BAPD 11(3)	D
Ge-Hg	M2	Unpublished	T
*Ge-Ho	M2	[80Ere] 203	D
Ge-I	M2	M2	D
*Ge-In	M2	Indium	D
Ge-Ir	M2	M2	T
*Ge-K	M2	M2	D
*Ge-La	M2	BAPD 10(4)	D
*Ge-Li	M2	M2	D
*Ge-Lu	M2	M2	D
*Ge-Mg	M2	Binary Magnesium	D
*Ge-Mn	M2	BAPD 11(5)	D
*Ge-Mo	M2	BAPD 8(1)	D
Ge-N	M2	BAPD 11(6)	T

*Ge-Na	M2	M2	D
*Ge-Nb	M2	[Moffatt] 11	D
*Ge-Nd	M2	BAPD 10(2)	D
*Ge-Ni	M2	Binary Nickel	D
Ge-Np	No Data		
Ge-O	M2	[56Tru] 58	D
Ge-Os	M2	M2	T
*Ge-P	M2,91	BAPD 6(3)	D
*Ge-Pb	M2	BAPD 5(4)	D
*Ge-Pd	M2	JPE 13(4)	D
Ge-Pm	No Data		
*Ge-Pr	M2,91	BAPD 10(3)	D
*Ge-Pt	M2	JPE 13(4)	D
Ge-Pu	M2	M2	T
Ge-Rb	M2	M2	D
Ge-Re	M2	[Moffatt] 11	D
Ge-Rh	M2	M2	D
Ge-Ru	M2	M2	D
*Ge-S	M2	[63Liu] 98	D
*Ge-Sb	M2	BAPD 7(3)	D
*Ge-Sc	M2	BAPD 7(6)	D

*Ge-Se	M2	BAPD 11(3)	D
*Ge-Si	M2	BAPD 5(2)	D
*Ge-Sm	M2	BDPD 9(5)	D
*Ge-Sn	M2	BAPD 5(3)	D
*Ge-Sr	M2	M2	D
Ge-Ta	M2,92	JPE 12(6)	T
*Ge-Tb	M2	M2	D
*Ge-Te	M2	M2	D
Ge-Th	M2	[Thorium] 20	D
*Ge-Ti	M2	Binary Titanium	D
*Ge-Tl	M2	BAPD 6(2)	D
*Ge-Tm	M2	M2	D
*Ge-U	M2	[60Lya] 75	D
Ge-V	M2	Binary Vanadium	D
Ge-W	M2	Binary Tungsten	D
*Ge-Y	M2	BAPD 9(1)	D
*Ge-Yb	M2	[83Ere] 215	D
*Ge-Zn	M2	BAPD 6(6)	D
Ge-Zr	M2	BAPD 7(1)	D
H-Hf	M2,91	M2	D
H-Hg	M2	M2	T

H-Ho	M2	M2	T
H-In	M2	Indium	T
H-Ir	M2,91	Unpublished	T
H-K	M2	M2	T
*H-La	M2	BAPD 11(1)	D
H-Li	M2	M2	D
H-Lu	M2	[82Sub] 214	D
H-Mg	M2	BAPD 8(5)	D
H-Mn	M2	Unpublished	D
H-Mo	M2	[Molybdenum] 12	D
H-Na	M2	BAPD 11(3)	D
*H-Nb	M2	BAPD 4(1)	D
*H-Nd	M2	M2	D
*H-Ni	M2	Binary Nickel	D
H-Np	M2	M2	T
H-Os	M2	Unpublished	T
H-Pa	M2	M2	T
H-Pb	M2	M2	T
*H-Pd	M2	Unpublished	D
H-Po	M2	[Shunk] 17	T
H-Pr	M2	M2	D

H-Pt	M2,91	Unpublished	T
H-Pu	M2	[56Mul] 54	D
H-Rb	M2	M2	T
H-Re	M2	Unpublished	T
H-Rh	M2,91	Unpublished	T
H-Ru	M2,91	Unpublished	T
H-Sb	M2	M2	T
H-Sc	M2	M2	D
H-Se	M2	M2	T
H-Si	M2	Unpublished	D
H-Sm	M2	M2	D
H-Sn	M2	M2	T
*H-Sr	M2	[64Pet] 114	D
*H-Ta	M2	JPE 12(3)	D
H-Tb	M2	M2	T
H-Te	No Data		
H-Th	M2	[Smith] 18	D
*H-Ti	M2,92	Binary Titanium	D
H-Tl	M2	M2	T
H-Tm	M2	M2	D
*H-U	M2	Unpublished	D

*H-V	M2	Binary Vanadium	D
H-W	M2	Binary Tungsten	T
H-Y	M2	BAPD 9(3)	D
H-Yb	M2	M2	D
H-Zn	M2	BAPD 10(6)	D
*H-Zr	M2	BAPD 11(4)	D
He-Mo	M2	[Molybdenum] 12	D
He-W		Binary Tungsten	T
Hf-Hg	M2	M2	D
Hf-In	M2	Indium	T
*Hf-Ir	M2	M2	D
Hf-K	M2	BAPD 8(1)	D
Hf-La	No Data		
Hf-Li	M2	BAPD 10(3)	D
Hf-Lu	No Data		
Hf-Mg	M2	Binary Magnesium	D
*Hf-Mn	M2	Unpublished	D
*Hf-Mo	M2	[Molybdenum] 12	D
*Hf-N	M2	BAPD 11(2)	D
Hf-Na	M2	BAPD 8(1)	D
*Hf-Nb	M2,91	JPE 12(2)	D

*Hf-Ni	M2,91	Binary Nickel	D
Hf-Np	No Data		
*Hf-O	M2	[Hafnium] 5	D
*Hf-Os	M2	M2	D
Hf-P	M2	M2	T
Hf-Pd	M2	[72Shu] 167	D
Hf-Po	M2	M2	T
Hf-Pr	M2	[71Gri] 159	D
Hf-Pt	M2	M2	T
Hf-Pu	M2	M2	D
Hf-Rb	M2	BAPD 8(1)	D
Hf-Re	M2	[63Tay] 102	D
*Hf-Rh	M2	M2	D
Hf-Ru	M2	M2	D
Hf-Si	M2	M2	T
Hf-Sb	M2	M2	T
Hf-Sc	M2	M2	D
Hf-Se	M2	M2	T
*Hf-Si	M2	BAPD 10(4)	D
Hf-Sm	No Data		
Hf-Sn	M2	JPE 12(4)	D

Hf-Sr	No Data		
*Hf-Ta	M2	JAPD 5(2)	D
Hf-Tb	No Data		
Hf-Tc	M2	M2	T
Hf-Te	M2	M2	D
Hf-Th	M2	[58Gib] 62	D
Hf-Ti	M2	Binary Titanium	D
Hf-Tl	No Data		
Hf-Tm	No Data		
*Hf-U	M2	[60Pet2] 77	D
*Hf-V	M2	Binary Vanadium	D
*Hf-W	M2,92	Binary Tungsten	D
Hf-Y	M2	[62Lun] 90	D
Hf-Yb	M2	[Moffatt] 11	D
Hf-Zn	M2	M2	T
*Hf-Zr	M2	BAPD 3(1)	D
Hg-Ho	M2	Unpublished	D
*Hg-In	M2	Indium	D
Hg-Ir	M2	M2	D
*Hg-K	M2	[79Vol] 199	D
*Hg-La	M2	Unpublished	D

*Hg-Li	M2	[Hansen] 6	D
Hg-Lu	M2	Unpublished	T
*Hg-Mg	M2	Binary Magnesium	D
Hg-Mn	M2	M2	D
Hg-Mo	M2	M2	D
Hg-N	M2	M2	T
*Hg-Na	M2	M2	D
Hg-Nb	M2	Unpublished	D
Hg-Nd	M2	Unpublished	D
Hg-Ni	M2,91	Binary Nickel	D
Hg-Np	No Data		
Hg-O	M2	M2	T
Hg-Os	M2	M2	D
Hg-P	No Data		
*Hg-Pb	M2	[Hansen] 6	D
Hg-Pd	M2	BAPD 11(1)	D
Hg-Po	M2	M2	T
Hg-Pr	M2	Unpublished	D
Hg-Pt	M2	BAPD 11(1)	D
Hg-Pu	M2	[59Sch] 68	D
*Hg-Rb	M2	[Hansen] 6	D

Hg-Re	M2	M2	D
Hg-Rh	M2	[67Jan] 132	D
Hg-Ru	M2	M2	D
*Hg-S	M2	JPE 13(5)	D
Hg-Sb	M2	BAPD 11(4)	D
Hg-Sc	M2	Unpublished	T
*Hg-Se	M2	JPE 13(5)	D
Hg-Si	M2	Unpublished	T
Hg-Sm	M2	Unpublished	D
*Hg-Sn	M2	M2	D
*Hg-Sr	M2	M2	D
Hg-Ta	M2	[05Bol] 24	T
Hg-Tb	M2	Unpublished	D
*Hg-Te	M2	Unpublished	D
Hg-Th	M2	[58Dom] 61	D
Hg-Ti	M2	Binary Titanium	D
*Hg-Tl	M2	Unpublished	D
Hg-Tm	M2	Unpublished	T
Hg-U	M2	M2	D
Hg-V	M2	Binary Vanadium	D
Hg-W	M2	Binary Tungsten	T

Hg-Y	M2	Unpublished	D
Hg-Yb	M2	Unpublished	D
*Hg-Zn	M2	Unpublished	D
Hg-Zr	M2	M2	D
Ho-I	M2	M2	D
*Ho-In	M2	Indium	D
Ho-Ir	M2	Unpublished	D
Ho-K	No Data		
Ho-La	M2	M2	D
Ho-Li	No Data		
Ho-Lu	M2	M2	D
Ho-Mg	M2	Binary Magnesium	D
*Ho-Mn	M2	[67Kir2] 134	D
Ho-Mo	M2	M2	D
Ho-N	M2	M2	T
Ho-Na	No Data		
Ho-Nb	No Data		
Ho-Nd	M2	M2	D
Ho-Ni	M2,92	Binary Nickel	D
Ho-Np	No Data		
Ho-O	M2	M2	T

Ho-Os	M2	M2	T
Ho-P	M2	M2	T
Ho-Pb	M2	M2	T
*Ho-Pd	M2,91	M2	D
Ho-Pm	M2	M2	D
Ho-Po	M2	M2	T
Ho-Pr	M2	M2	D
Ho-Pt	M2	M2	D
Ho-Pu	M2,91	M2	D
Ho-Rb	No Data		
Ho-Re	M2	M2	T
Ho-Rh	M2	M2	D
Ho-Ru	M2	M2	D
Ho-S	M2	M2	T
*Ho-Sb	M2	M2	D
Ho-Sc	M2	M2	D
Ho-Se	M2,91	M2	T
Ho-Si	M2	[Pearson3] 14	T
Ho-Sm	M2	M2	D
Ho-Sn	M2	M2	T
Ho-Sr	No Data		

Ho-Ta	M2	[Moffatt] 11	D
Ho-Tb	M2	BAPD 4(3)	D
Ho-Tc	M2	M2	T
*Ho-Te	M2	[74Yar] 179	D
Ho-Th	M2	M2	D
Ho-Ti	No Data		
*Ho-Tl	M2	Unpublished	D
Ho-Tm	M2	M2	D
Ho-U	M2	M2	T
Ho-V	M2	Binary Vanadium	D
Ho-W	M2	Binary Tungsten	D
Ho-Y	M2	BAPD 4(1)	D
Ho-Yb	M2	M2	D
Ho-Zn	M2	M2	D
Ho-Zr	M2	M2	D
I-In	M2	Indium	D
I-K	M2	M2	D
I-Mg	M2	Binary Magnesium	T
I-Mo	M2	M2	D
I-Na	M2	M2	D
I-Ni	M2	Binary Nickel	T

I-Rb	M2,91	M2	D
I-Se	M2	M2	D
I-Sr	M2	M2	D
I-Tb	M2	M2	D
I-Te	M2	M2	D
I-Th	M2	[Smith] 18	D
I-Tl	M2	M2	D
I-W	M2	Binary Tungsten	T
I-Y	M2	M2	D
In-Ir	M2	Indium	T
*In-K	M2,92	Indium	D
In-Kr	M2	M2	T
*In-La	M2	Indium	D
*In-Li	M2	Indium	D
*In-Lu	M2	Indium	D
*In-Mg	M2	Indium	D
*In-Mn	M2,92	Indium	D
In-Mo	M2	Indium	D
In-N	M2	Indium	T
*In-Na	M2	Indium	D
*In-Nb	M2	Indium	D

*In-Nd	M2,91	Indium	D
*In-Ni	M2	Indium	D
In-Np	No Data		
In-O	M2,91	Indium	D
In-Os	M2	Indium	T
*In-P	M2	Indium	D
*In-Pb	M2	Indium	D
*In-Pd	M2	Indium	D
In-Pm	M2	Indium	D
*In-Pr	M2	Indium	D
*In-Pt	M2,91	Indium	D
*In-Pu	M2	Indium	D
*In-Rb	M2	Indium	D
In-Re	M2	Indium	T
In-Rh	M2	Indium	T
In-Ru	M2	Indium	T
*In-S	M2	Indium	D
*In-Sb	M2	Indium	D
*In-Sc	M2	Indium	D
*In-Se	M2,91	Indium	D
*In-Si	M2	Indium	D

*In-Sm	M2	Indium	D
*In-Sn	M2,91	Indium	D
*In-Sr	M2	Indium	D
In-Ta	M2	Indium	D
*In-Tb	M2	Indium	D
*In-Te	M2,91	Indium	D
*In-Th	M2	Indium	D
*In-Ti	M2	Indium	D
*In-Tl	M2	Indium	D
*In-Tm	M2	Indium	D
In-U	M2	Indium	D
*In-V	M2	Indium	D
In-W	M2	Binary Tungsten	T
*In-Y	M2	Indium	D
*In-Yb	M2	Indium	D
*In-Zn	M2	Indium	D
In-Zr	M2	Indium	D
Ir-K	M2	[64Rhy] 115	T
*Ir-La	M2	JPE 12(5)	D
Ir-Li	M2	JPE 13(1)	D
Ir-Lu	M2	Unpublished	D

Ir-Mg	M2	Binary Magnesium	D
Ir-Mn	M2	Unpublished	D
*Ir-Mo	M2	[Molybdenum] 12	D
Ir-N	M2	[05Emi] 25	T
Ir-Na	M2	[64Rhy] 115	T
*Ir-Nb	M2	Unpublished	D
Ir-Nd	M2	Unpublished	D
*Ir-Ni	M2	Binary Nickel	D
Ir-Np	M2	M2	T
Ir-O	M2	M2	T
Ir-Os	M2	Unpublished	D
Ir-P	M2	BAPD 11(4)	D
Ir-Pa	M2	M2	T
Ir-Pb	M2	M2	T
*Ir-Pd	M2,91	JPE 12(5)	D
Ir-Pm	M2	Unpublished	D
Ir-Pr	M2	Unpublished	D
*Ir-Pt	M2	[30Mul 35, 56Rau 56]	D
Ir-Pu	M2	M2	T
Ir-Rb	M2	[76Vol] 187	T
Ir-Re	M2	Unpublished	D

*Ir-Rh	M2,91	JPE 12(5)	D
*Ir-Ru	M2	JPE 13(5)	D
Ir-S	M2	M2	T
Ir-Sb	M2	Unpublished	D
Ir-Sc	M2	Unpublished	T
Ir-Se	M2	M2	T
Ir-Si	M2	M2	T
Ir-Sm	M2	Unpublished	D
Ir-Sn	M2	M2	T
Ir-Sr	M2	M2	T
*Ir-Ta	M2	[Metals] 10	D
Ir-Tb	M2	Unpublished	D
Ir-Tc	M2	M2	D
Ir-Te	M2	M2	D
*Ir-Th	M2	JPE 12(5)	D
*Ir-Ti	M2,92	Binary Titanium	D
Ir-Tl	No Data		
Ir-Tm	M2	Unpublished	D
*Ir-U	M2	JPE 13(5)	D
*Ir-V	M2	Binary Vanadium	D
*Ir-W	M2,92	Binary Tungsten	D

Ir-Y	M2	Unpublished	D
Ir-Yb	M2	JPE 13(2)	D
Ir-Zn	M2	[64Rhy] 115	T
*Ir-Zr	M2	JPE 13(5)	D
K-La	No Data		
K-Li	M2	BAPD 10(3)	D
K-Mg	M2	Binary Magnesium	D
K-Mo	M2	M2	D
K-N	M2	M2	T
*K-Na	M2	BAPD 3(3)	D
K-Nb	M2	BAPD 9(4)	D
K-Nd	No Data		
K-Ni	M2	[65Swi] 121	T
K-Np	No Data		
K-O	M2	M2	T
K-Os	M2	M2	T
K-P	M2	M2	T
*K-Pb	M2	M2	D
K-Pd	M2	M2	T
K-Pr	No Data		
K-Pu	M2	[59Sch] 68	T

*K-Rb	M2	BAPD 4(4)	D
K-Re	No Data		
K-Rh	M2	M2	T
K-Ru	M2	M2	T
*K-S	M2	M2	D
*K-Sb	M2	[6lDor2] 83	D
*K-Se	M2	M2	D
K-Si	M2	M2	T
K-Sm	No Data		
*K-Sn	M2	M2	D
K-Sr	M2	BAPD 6(2)	T
K-Ta	M2	JAPD 6(1)	D
K-Tb	No Data		
*K-Te	M2	BAPD 11(5)	D
K-Th	M2	M2	T
K-Ti	M2	BAPD 10(2)	D
*K-Tl	M2	M2	T
K-Tm	No Data		
K-U	M2	M2	T
K-V	M2	Binary Vanadium	D
K-W	M2	Binary Tungsten	T

K-Y	No Data		
K-Yb	No Data		
K-Zn	M2	BAPD 8(6)	D
K-Zr	M2	BAPD 10(3)	D
Kr-Mo	M2	[Molybdenum] 12	D
Kr-W		Binary Tungsten	T
La-Li	No Data		
La-Lu	M2	M2	D
*La-Mg	M2	Binary Magnesium	D
*La-Mn	M2	BAPD 11(5)	D
La-Mo	M2	M2	D
La-N	M2	M2	T
La-Na	No Data		
La-Nb	M2	Unpublished	D
La-Nd	M2	BAPD 2(4)	D
*La-Ni	M2,91	Binary Nickel	D
La-Np	No Data		
La-O	M2	M2	T
La-Os	M2	M2	T
La-P	M2	M2	T
*La-Pb	M2,92	JPE 13(1)	D

La-Pd	M2	M2	T
La-Pm	M2	M2	D
La-Pr	M2	M2	D
La-Pt	M2	M2	D
La-Pu	M2	M2	D
La-Rb	No Data		
La-Re	M2	M2	D
La-Rh	M2	M2	D
La-Ru	M2,91	M2	D
*La-S	M2	Unpublished	D
*La-Sb	M2	[54Vog] 49	D
*La-Sc	M2	BAPD 3(1)	D
*La-Se	M2	M2	D
La-Si	M2	M2	T
La-Sm	M2	M2	D
*La-Sn	M2,92	JPE 13(1)	D
La-Sr	No Data		
La-Ta	M2	[Moffatt] 11	D
La-Tb	M2	M2	D
La-Te	M2	[65Haa] 120	D
La-Th	M2	[69Bad] 146	D

La-Ti	M2	Binary Titanium	D
*La-Tl	M2	Unpublished	D
La-Tm	M2	M2	D
La-U	M2	M2	T
La-V	M2	Binary Vanadium	D
La-W	M2	Binary Tungsten	D
La-Y	M2	BAPD 3(1)	D
La-Yb	M2	M2	D
*La-Zn	M2	[41Rol] 40	D
La-Zr	M2	M2	T
*Li-Mg	M2	Binary Magnesium	D
Li-Mn	M2	[640bi1] 111	D
Li-Mo	M2	M2	D
Li-N	M2,92	JPE 13(3)	D
*Li-Na	M2	BAPD 10(3)	D
Li-Nb	M2	BAPD 9(4)	D
Li-Ni	M2	Binary Nickel	D
Li-Np	No Data		
Li-O	M2,92	JPE 13(3)	T
Li-Os	M2	JPE 13(1)	T
Li-P	M2	Unpublished	T

*Li-Pb	M2	[Hansen] 6	D
*Li-Pd	M2	JPE 13(1)	D
Li-Pt	M2	JPE 12(6)	D
Li-Pu	M2	M2	D
Li-Rb	M2	BAPD 10(3)	D
Li-Re	M2	JPE 12(6)	T
Li-Rh	M2	JPE 12(6)	D
Li-Ru	M2	JPE 12(6)	T
*Li-S	M2	Unpublished	D
Li-Sb	M2	M2	D
*Li-Se	M2	[71Cun] 158	D
*Li-Si	M2	BAPD 11(3)	D
*Li-Sn	M2	[Moffatt] 11	D
*Li-Sr	M2	BAPD 10(3)	D
Li-Ta	M2	JAPD 6(1)	D
Li-Tb	No Data		
Li-Tc	M2	Unpublished	T
*Li-Te	M2	JPE 13(3)	D
Li-Th	No Data		
Li-Ti	M2	BAPD 10(2)	D
*Li-Tl	M2	[34Gru] 36	D

Li-Tm	No Data		
Li-U	M2	M2	T
Li-V	M2	Binary Vanadium	D
Li-W	M2	Binary Tungsten	T
Li-Y	No Data		
Li-Yb	No Data		
*Li-Zn	M2	JPE 12(1)	D
Li-Zr	M2	BAPD 8(1)	D
Lr-Mo	M2	[Molybdenum] 12	D
Lu-Mg	M2	Binary Magnesium	D
Lu-Mn	M2	M2	D
Lu-Mo	M2	[Molybdenum] 12	D
Lu-N	M2	M2	T
Lu-Na	No Data		
Lu-Nb	No Data		
Lu-Nd	M2	M2	D
Lu-Ni	M2	Binary Nickel	T
Lu-Np	No Data		
Lu-O	M2	M2	T
Lu-Os	M2	M2	T
Lu-P	M2	M2	T

*Lu-Pb	M2	[69Mcm] 150	D
Lu-Pd	M2	M2	T
Lu-Pm	M2	M2	D
Lu-Po	M2	M2	T
Lu-Pr	M2	M2	D
Lu-Pt	M2	M2	D
Lu-Pu	M2,91	M2	D
Lu-Rb	No Data		
Lu-Re	M2	M2	T
Lu-Rh	M2	M2	D
Lu-Ru	M2	M2	D
Lu-S	M2	M2	T
Lu-Sb	M2,91	M2	T
Lu-Sc	No Data		
Lu-Se	M2	M2	T
Lu-Si	M2	M2	D
Lu-Sm	M2	M2	D
Lu-Sn	M2	M2	D
Lu-Sr	No Data		
Lu-Ta	M2	[66Den1] 123	D
Lu-Tb	M2	M2	D

Lu-Tc	M2	M2	T
Lu-Te	M2	M2	T
Lu-Th	M2	M2	D
Lu-Ti	M2	M2	D
*Lu-Tl	M2	M2	D
Lu-Tm	M2	M2	D
Lu-U	M2	M2	T
Lu-V	M2	Binary Vanadium	D
Lu-W	M2	Binary Tungsten	D
Lu-Y	M2	M2	D
Lu-Yb	M2,91	BAPD 4(3	D
Lu-Zn	M2	M2	D
Lu-Zr	M2	M2	D
Md-Mo	M2	[Molybdenum] 12	D
*Mg-Mn	M2	Binary Magnesium	D
Mg-Mo	M2	Binary Magnesium	D
Mg-N	M2	Binary Magnesium	D
Mg-Na	M2	Binary Magnesium	D
Mg-Nb	M2	Binary Magnesium	D
Mg-Nd	M2,91	Binary Magnesium	D
*Mg-Ni	M2	Binary Nickel	D

Mg-Np	M2	[68Gul1] 141	T
Mg-O	M2	Binary Magnesium	D
Mg-Os	M2	[68Gul2] 142	T
Mg-P	M2	Binary Magnesium	T
Mg-Pa	M2	[68Gul1] 141	T
*Mg-pb	M2	Binary Magnesium	D
Mg-Pd	M2	Binary Magnesium	D
Mg-Pm	M2	[68Gul2] 142	T
Mg-Po	M2	Binary Magnesium	T
Mg-Pr	M2	BAPD 10(1)	D
Mg-Pt	M2	Binary Magnesium	T
Mg-Pu	M2	M2	D
Mg-Ra	M2	[68Gul2] 142	T
Mg-Rb	M2	Binary Magnesium	D
Mg-Re	M2	[68Gul2] 142	T
Mg-Rh	M2	Binary Magnesium	T
Mg-Ru	M2	Binary Magnesium	T
Mg-S	M2	Binary Magnesium	D
*Mg-Sb	M2	Binary Magnesium	D
*Mg-Sc	M2	Binary Magnesium	D
Mg-Se	M2	Binary Magnesium	T

*Mg-Si	M2	Binary Magnesium	D
*Mg-Sm	M2	M2	D
*Mg-Sn	M2	Binary Magnesium	D
*Mg-Sr	M2	Binary Magnesium	D
Mg-Ta	M2	[68Gul2] 142	T
Mg-Tb	M2	Binary Magnesium	D
Mg-Tc	M2	[68Gul2] 142	T
Mg-Te	M2	Binary Magnesium	T
*Mg-Th	M2	Binary Magnesium	D
Mg-Ti	M2	Binary Magnesium	D
*Mg-Tl	M2	Binary Magnesium	D
Mg-Tm	M2	Binary Magnesium	D
Mg-U	M2	Binary Magnesium	D
Mg-V	M2	Binary Magnesium	D
Mg-W	M2	Binary Tungsten	T
*Mg-Y	M2,92	Binary Magnesium	D
*Mg-Yb	M2	Binary Magnesium	D
*Mg-Zn	M2	Binary Magnesium	D
*Mg-Zr	M2	Binary Magnesium	D
*Mn-Mo	M2	[Molybdenum] 12	D
*Mn-N	M2	BAPD 11(1)	D

Mn-Na	No Data		
Mn-Nb	M2	M2	D
*Mn-Nd	M2,92	[70Kir] 151	D
*Mn-Ni	M2	JPE 12(3)	D
Mn-Np	M2	M2	T
*Mn-O	M2	M2	D
*Mn-P	M2	[50Ber] 43	D
Mn-Pb	M2	[56Pel] 55	D
*Mn-Pd	M2	[Hansen] 6	D
Mn-Pm	91	[90Sac] 226	D
*Mn-Pr	M2	M2	D
Mn-Pt	M2	[55Rau] 51	D
*Mn-Pu	M2	[55Kon] 50	D
Mn-Rb	No Data		
Mn-Re	M2	[61Sav] 89	D
Mn-Rh	M2	[55Rau 51, 59Hel 67]	D
Mn-Ru	M2	M2	D
Mn-S	M2	Unpublished	D
*Mn-Sb	M2	M2	D
Mn-Sc	M2	M2	D
Mn-Se	M2	Unpublished	D

*Mn-Si	M2,91	BAPD 11(5)	D
*Mn-Sm	M2	[70Kir] 151	D
*Mn-Sn	M2	M2	D
Mn-Sr	M2	M2	D
Mn-Ta	M2	[60Sav] 79	D
Mn-Tb	M2	[70Kir] 151	D
Mn-Tc	M2	M2	T
Mn-Te	M2	Unpublished	D
Mn-Th	M2	[Brandes] 2	D
*Mn-Ti	M2	Binary Titanium	D
Mn-Tl	M2	M2	D
Mn-Tm	M2	M2	D
*Mn-U	M2	[Hansen] 6	D
*Mn-V	M2,92	Binary Vanadium	D
Mn-W	M2	Binary Tungsten	T
*Mn-Y	M2,91	JPE 12(4)	D
Mn-Yb	M2	M2	D
*Mn-Zn	M2	BAPD 11(4)	D
*Mn-Zr	M2	Unpublished	D
*Mo-N	M2	M2	D
Mo-Na	M2	M2	D

*Mo-Nb	M2,91	[Molybdenum] 12	D
Mo-Nd	M2	M2	D
Mo-Ne	M2	[Molybdenum] 12	D
*Mo-Ni	M2,91	Binary Nickel	D
Mo-No	M2	[Molybdenum] 12	D
Mo-Np	M2	[Molybdenum] 12	D
*Mo-O	M2	BAPD 1(2)	D
*Mo-Os	M2	[Molybdenum] 12	D
*Mo-P	M2	[Molybdenum] 12	D
Mo-Pa	M2	[Molybdenum] 12	D
Mo-Pb	M2	M2	D
*Mo-Pd	M2,92	M2	D
Mo-Pm	M2	M2	D
Mo-Po	M2	[Molybdenum] 12	T
Mo-Pr	M2	M2	D
*Mo-Pt	M2	BAPD 1(2)	D
*Mo-Pu	M2	[Molybdenum] 12	D
Mo-Ra	M2	[Molybdenum] 12	D
Mo-Rb	M2	M2	D
Mo-Re	M2	M2	D
*Mo-Rh	M2	[Molybdenum] 12	D

Mo-Rn	M2	[Molybdenum] 12	D
*Mo-Ru	M2	M2	D
*Mo-S	M2	BAPD 1(2)	D
Mo-Sb	M2	[Molybdenum] 12	D
Mo-Sc	M2	[Molybdenum] 12	D
Mo-Se	M2	[Molybdenum] 12	D
*MO-Si	M2	JPE 12(4)	D
Mo-Sm	M2	M2	D
Mo-Sn	M2	BAPD 1(2)	D
Mo-Sr	M2	M2	D
*Mo-Ta	M2	JAPD 2(3)	D
Mo-Tb	M2	M2	D
Mo-Tc	M2	[Molybdenum] 12	D
Mo-Te	M2	[Molybdenum] 12	D
Mo-Th	M2	[Molybdenum] 12	D
*MO-Ti	M2	Binary Titanium	D
Mo-Tl	M2	M2	D
Mo-Tm	M2	M2	D
*Mo-U	M2	M2	D
*MO-V	M2	JPE 13(1)	D
*MO-W	M2	Binary Tungsten	D

Mo-Xe	M2	[Molybdenum] 12	D
Mo-Y	M2	[Molybdenum] 12	D
Mo-Yb	M2	M2	D
Mo-Zn	M2	[Molybdenum] 12	D
*Mo-Zr	M2	[Zirconium] 21	D
N-Na	M2	M2	T
*N-Nb	M2	[74Lev] 176	D
N-Nd	M2	M2	T
*N-Ni	M2	Binary Nickel	D
N-Np	M2	M2	T
N-Os	M2	M2	T
N-Pa	M2	M2	T
N-Pb	M2	M2	T
N-Pd	M2	[10Sie] 31	T
N-Pr	M2	M2	T
N-Pt	No Data		
N-Pu	M2	BAPD 10(5)	D
N-Rb	M2	M2	T
N-Re	M2	M2	T
N-Rh	No Data		
N-Ru	No Data		

N-Sb	No Data		
N-Sc	M2	M2	T
N-Se	M2	M2	T
N-Si	M2	BAPD 11(6)	D
N-Sm	M2	M2	T
N-Sn	M2	[08Fis 28, 10Sie 31]	T
N-Sr	M2	M2	T
*N-Ta	M2	[75Gat] 181	D
N-Tb	M2	M2	T
N-Tc	M2	M2	T
N-Te	M2	M2	T
*N-Th	M2	M2	D
*N-Ti	M2	Binary Titanium	D
N-Tl	M2	M2	T
N-Tm	M2	M2	T
*N-U	M2	[Metals] 10	D
N-V	M2	Binary Vanadium	D
N-W	M2	Binary Tungsten	D
N-Y	M2	M2	D
N-Yb	M2	M2	T
N-Zn	M2	BAPD 9(3)	T

*N-Zr	M2	[Zirconium] 21	D
Na-Nb	M2	BAPD 9(4)	D
Na-Nd	No Data		
Na-Ni	M2	Binary Nickel	T
Na-Np	No Data		
*Na-O	M2	BAPD 8(3)	D
Na-Os	M2	[81Loe] 209	T
Na-P	No Data		
*Na-Pb	M2	[Metals] 10	D
Na-Pd	M2	M2	D
Na-Po	M2	M2	T
Na-Pr	No Data		
Na-Pt	M2	M2	D
Na-Pu	M2	M2	T
*Na-Rb	M2	BAPD 3(3)	D
Na-Re	No Data		
Na-Rh	M2	[81Loe] 209	T
Na-Ru	M2	[81Loe] 209	T
*Na-S	M2	M2	D
*Na-Sb	M2	[06Mat] 26	D
Na-Sc	No Data		

*Na-Se	M2	M2	D
Na-Si	M2	JPE 13(1)	T
Na-Sm	No Data		
*Na-Sn	M2	M2	D
*Na-Sr	M2	BAPD 6(1)	D
Na-Ta	M2,91	JAPD 6(1)	D
Na-Tb	No Data		
*Na-Te	M2	BAPD 11(5)	D
Na-Th	M2	[42Gru] 41	D
Na-Ti	M2	BAPD 10(2)	D
*Na-Tl	M2	[36Gru] 37	D
Na-Tm	No Data		
Na-U	M2	M2	T
Na-V	M2	Binary Vanadium	D
Na-W	M2	Binary Tungsten	T
Na-Y	No Data		
Na-Yb	No Data		
Na-Zn	M2	BAPD 8(6)	D
Na-Zr	M2	BAPD 8(1)	D
Nb-Nd	M2	M2	T
*Nb-Ni	M2	Binary Nickel	D

Nb-Np	No Data		
Nb-O	M2	[59Ell 66, Shunk 17]	D
*Nb-Os	M2	[77Wat] 192	D
Nb-P	M2	M2	T
Nb-Pb	M2	M2	T
*Nb-Pd	M2	BAPD 9(4)	D
Nb-Pr	No Data		
*Nb-Pt	M2	M2	D
Nb-Pu	M2	M2	D
Nb-Rb	M2	BAPD 11(3)	D
Nb-Re	M2	[60Gra] 73	D
*Nb-Rh	M2	[64Rit] 116	D
*Nb-Ru	M2	M2	D
Nb-S	M2	M2	D
Nb-Sb	M2	M2	D
Nb-Sc	M2	M2	D
Nb-Se	M2	M2	D
*Nb-Si	M2	Unpublished	D
Nb-Sm	M2,92	[Moffatt] 11	D
Nb-Sn	M2	[Shunk] 17	D
Nb-Sr	No Data		

*Nb-Ta	M2	JAPD 3(1)	D
Nb-Tb	No Data		
Nb-Tc	M2	M2	T
Nb-Te	M2	M2	D
*Nb-Th	M2	[56Car] 52	D
*Nb-Ti	M2	Binary Titanium	D
Nb-Tl	M2	M2	D
Nb-Tm	No Data		
*Nb-U	M2	M2	D
*Nb-V	M2	Binary Vanadium	D
*Nb-W	M2	Binary Tungsten	D
Nb-Y	M2	JPE 12(2)	D
Nb-Yb	M2	M2	D
Nb-Zn	M2	JPE 13(4)	D
*Nb-Zr	M2,92	BAPD 3(1)	D
*Nd-Ni	M2,92	Binary Nickel	D
Nd-Np	No Data		
Nd-O	M2	M2	D
Nd-Os	M2	M2	T
Nd-P	M2	M2	T
Nd-Pb	M2	M2	T

Nd-Pd	M2,92	M2	D
Nd-Pm	M2	M2	D
Nd-Pr	M2	BAPD 3(2)	D
*Nd-Pt	M2	M2	D
Nd-Pu	M2	M2	D
Nd-Rb	No Data		
Nd-Re	M2	M2	T
*Nd-Rh	M2	M2	D
Nd-Ru	M2,91	M2	D
Nd-S	M2	M2	T
*Nd-Sb	M2	M2	D
Nd-Sc	M2	BAPD 3(3)	D
Nd-Se	M2	M2	T
*Nd-Si	M2	BAPD 10(3)	D
Nd-Sm	M2	BAPD 3(2)	D
*Nd-Sn	M2	M2	D
Nd-Sr	M2	[78Esh] 195	D
Nd-Ta	M2	[Moffatt] 11	D
Nd-Tb	M2	M2	D
*Nd-Te	M2	M2	D
Nd-Th	M2	[67Bad1] 128	D

*Nd-Ti	M2	Binary Titanium	D
*Nd-Tl	M2	Unpublished	D
Nd-Tm	M2	M2	D
Nd-U	M2	M2	D
Nd-V	M2	Binary Vanadium	D
Nd-W	M2	Binary Tungsten	D
Nd-Y	M2	BAPD 3(2)	D
Nd-Yb	M2	BAPD 3(2)	D
*Nd-Zn	M2	[72Mas] 165	D
Nd-Zr	M2	[Shunk 17, Elliott 4]	T
Ne-W		Binary Tungsten	T
Ni-Np	M2	Binary Nickel	T
*Ni-O	M2	Binary Nickel	D
*Ni-OS	M2	Binary Nickel	D
*Ni-P	M2	Binary Nickel	D
*Ni-Pb	M2	Binary Nickel	D
*Ni-Pd	M2	Binary Nickel	D
Ni-Pm	M2	Binary Nickel	T
Ni-Po	M2	[Moffatt] 11	D
*Ni-Pr	M2	Binary Nickel	D
*Ni-Pt	M2	Binary Nickel	D

*Ni-Pu	M2	Binary Nickel	D
Ni-Rb	No Data		
*Ni-Re	M2,92	Binary Nickel	D
*Ni-Rh	M2	Binary Nickel	D
*Ni-Ru	M2	Binary Nickel	D
*Ni-S	M2	Binary Nickel	D
*Ni-Sb	M2	Binary Nickel	D
*Ni-Sc	M2	Binary Nickel	D
*Ni-Se	M2	Binary Nickel	D
*Ni-Si	M2	Binary Nickel	D
*Ni-Sm	M2	Binary Nickel	D
*Ni-Sn	M2	Binary Nickel	D
Ni-Sr	M2	Binary Nickel	D
*Ni-Ta	M2	Binary Nickel	D
Ni-Tb	M2	Binary Nickel	T
Ni-Tc	M2	Binary Nickel	D
*Ni-Te	M2	Binary Nickel	D
Ni-Th	M2,91	Binary Nickel	D
*Ni-Ti	M2	Binary Nickel	D
Ni-Tl	M2	[08Vos] 30	D
Ni-Tm	M2	Binary Nickel	T

*Ni-U	M2	Binary Nickel	D
*Ni-V	M2	Binary Nickel	D
*Ni-W	M2,91	Binary Tungsten	D
*Ni-Y	M2	Binary Nickel	D
*Ni-Yb	M2	Binary Nickel	D
*Ni-Zn	M2	Binary Nickel	D
*Ni-Zr	M2	Binary Nickel	D
Np-O	M2	M2	D
Np-Os	M2	M2	T
Np-P	M2	M2	T
Np-Pb	No Data		
Np-Pd	M2	M2	T
Np-Pr	No Data		
Np-Pt	M2	BAPD 10(2)	T
*Np-Pu	M2	BAPD 6(3)	D
Np-Rb	No Data		
Np-Re	M2	M2	T
Np-Rh	M2	M2	T
Np-Ru	M2	M2	T
Np-S	M2	M2	T
Np-Sb	M2	M2	T

Np-Sc	No Data		
Np-Se	M2	M2	T
Np-Si	M2	M2	T
Np-Sm	No Data		
Np-Sn	M2	M2	T
Np-Sr	No Data		
Np-Ta	No Data		
Np-Tb	No Data		
Np-Te	M2	M2	T
Np-Th	No Data		
Np-Ti	No Data		
Np-Tl	M2	M2	T
Np-Tm	No Data		
*Np-U	M2	BAPD 6(3)	D
Np-V	No Data		
Np-W	M2	Binary Tungsten	T
Np-Y	No Data		
Np-Yb	No Data		
Np-Zn	No Data		
Np-Zr	No Data		
O-Os	M2	M2	T

O-Pa	M2	M2	T
*O-Pb	M2	BAPD 9(2)	D
O-Pd	M2	[Pearson3] 14	T
O-Pm	M2	M2	T
O-Po	M2	M2	T
*O-Pr	M2	M2	D
O-Pt	M2	[Pearson3] 14	T
*O-Pu	M2	BAPD 11(2)	D
O-Rb	M2	M2	D
O-Re	M2	[Pearson3] 14	T
O-Rh	M2	M2	T
O-Ru	M2	M2	T
O-Sb	M2	M2	D
O-Sc	M2	M2	D
O-Se	M2	M2	T
O-Si	M2	BAPD 11(1)	D
O-Sm	M2	M2	T
*O-Sn	M2	[Hansen] 6	
O-Sr	M2	[56Swa 57, 63Sch 101]	T
O-Ta	M2	[72Jeh] 164	D
O-Tb	M2	M2	D

O-Tc	M2	M2	T
O-Te	M2	M2	D
O-Th	M2	[Smith] 18	D
*O-Ti	M2	Binary Titanium	D
O-Tl	M2	M2	T
O-Tm	M2	M2	T
O-U	M2	[Elliott] 4	D
*O-V	M2	Binary Vanadium	D
*O-W	M2	Binary Tungsten	D
*O-Y	M2	BAPD 11(1)	D
O-Yb	M2	M2	T
O-Zn	M2	BAPD 8(2)	D
*O-Zr	M2	BAPD 7(2)	D
Os-P	M2	M2	D
Os-Pb	No Data		
Os-Pd	M2	[63Tyl] 104	D
Os-Pr	M2	M2	D
*Os-Pt	M2	M2	D
*Os-Pu	M2	[55Kon] 50	D
Os-Rb	M2	[81Loe] 209	T
*Os-Re	M2	[62Ty11] 93	D

*Os-Rh	M2	M2	D
*Os-Ru	M2	[62Ty12] 94	D
Os-S	M2	M2	D
Os-Sb	M2	M2	T
Os-Sc	M2	M2	T
Os-Se	M2	M2	D
*Os-Si	M2	M2	D
Os-Sm	M2	[59Com 65, 80Pal 205]	T
Os-Sn	M2	M2	T
Os-Sr	No Data		
Os-Ta	M2	[60Kau] 74	D
Os-Tb	M2	[59Boz 64, 80Pal 205]	T
Os-Tc	M2	M2	T
Os-Te	M2	M2	D
Os-Th	M2	M2	D
*Os-Ti	M2	Binary Nickel	D
Os-Tl	No Data		
Os-Tm	M2	M2	T
*Os-U	M2	[Shunk] 17	D
*Os-V	M2	Binary Vanadium	D
*Os-W	M2,92	Binary Tungsten	D

Os-Y	M2	[73Sav] 172	D
Os-Yb	M2	M2	D
Os-Zn	M2	M2	T
*Os-Zr	M2	M2	D
P-Pa	M2	M2	T
P-Pb	M2	[1898Gra 23, 22Bru 33]	T
*P-Pd	M2	Unpublished	D
*P-Pr	M2	[Moffatt] 11	D
P-Pt	M2	BAPD 11(5)	D
P-Pu	M2	M2	T
P-Rb	M2	M2	T
P-Re	M2	M2	T
P-Rh	M2	BAPD 11(4)	D
*P-Ru	M2	M2	D
P-S	91	[79Bla] 198	D
P-Sb	M2,91	JPE 12(2)	D
P-Sc	M2	M2	T
P-Se	M2	Unpublished	D
P-Si	M2	BAPD 6(2)	D
P-Sm	M2	M2	T
*P-Sn	M2	[20Viv] 32	D

P-Sr	M2	M2	T
P-Ta	M2	[Pearson3] 14	T
P-Tb	M2	M2	T
P-Tc	M2	M2	T
P-Te	M2	[42Mon] 42	T
P-Th	M2	M2	D
*P-Ti	M2	Binary Titanium	D
P-Tl	M2	Unpublished	D
P-Tm	M2	M2	T
P-U	M2	M2	T
P-V	M2	JPE 12(4)	T
P-W	M2	Binary Tungsten	T
P-Y	M2	M2	T
P-Yb	M2	M2	T
*P-Zn	M2	JPE 12(4)	D
P-Zr	M2	M2	T
Pa-Pt	M2	BAPD 10(2)	T
Pa-Rh	M2	M2	T
Pa-Sb	M2	M2	T
Pa-Th	M2	M2	T
Pa-W	M2	Binary Tungsten	T

*Pb-Pd	M2	M2	D
Pb-Pm	M2	[63Wil] 105	T
Pb-Po	M2	M2	T
*Pb-Pr	M2	M2	D
*Pb-Pt	M2	[Hansen] 6	D
*Pb-Pu	M2	BAPD 9(3)	D
*Pb-Rb	M2	[77Kuz 191, 64Hew 110]	D
Pb-Re	No Data		
*Pb-Rh	M2	M2	D
Pb-Ru	M2	M2	T
*Pb-S	M2	BAPD 7(4)	D
*Pb-Sb	M2	BAPD 2(1)	D
Pb-Sc	No Data		
*Pb-Se	M2	Unpublished	D
Pb-Si	M2	BAPD 5(3)	D
Pb-Sm	M2	[Moffatt] 11	D
*Pb-Sn	M2	BAPD 9(2)	D
*Pb-Sr	M2	[81Bru] 206	D
Pb-Ta	No Data		
Pb-Tb	M2	M2	T
*Pb-Te	M2	BAPD 10(4)	D

Pb-Th	M2	M2	D
Pb-Ti	M2	Binary Titanium	D
*Pb-Tl	M2	[Hultgren,B] 7	D
Pb-Tm	M2	M2	T
Pb-U	M2	BAPD 8(6)	D
Pb-V	M2	Binary Vanadium	T
Pb-W	M2	Binary Tungsten	T
*Pb-Y	M2	[67Car] 131	D
*Pb-Yb	M2	JPE 12(4)	D
*Pb-Zn	M2	[Hansen] 6	D
Pb-Zr	M2	M2	D
Pd-Pr	M2	JAPD 6(2)	D
*Pd-Pt	M2,91	M2	D
*Pd-Pu	M2	[67Kut1] 135	D
Pd-Rb	M2	[81Loe] 209	T
Pd-Re	M2	M2	D
*Pd-Rh	M2	M2	D
*Pd-Ru	M2	M2	D
*Pd-S	M2,92	[76Mat] 186	D
*Pd-Sb	M2,92	M2	D
Pd-Sc	M2	M2	D

*Pd-Se	M2,91	JPE 13(1)	D
*Pd-Si	M2,91	JPE 12(3)	D
*Pd-Sm	M2	M2	D
*Pd-Sn	M2	M2	D
Pd-Sr	M2	M2	T
Pd-Ta	M2	JAPD 6(2)	D
Pd-Tb	M2,91	M2	T
Pd-Tc	M2	M2	D
*Pd-Te	M2	JPE 13(1)	D
Pd-Th	M2	M2	D
*Pd-Ti	M2	Binary Titanium	D
*Pd-Tl	M2	M2	D
Pd-Tm	M2	M2	T
*Pd-U	M2,92	[56Cat 53, 63Pel 100]	D
*Pd-V	M2	Binary Vanadium	D
*Pd-W	M2,91,92	Binary Tungsten	D
*Pd-Y	M2,91	M2	D
*Pd-Yb	M2	[73Ian] 170	D
*Pd-Zn	M2	M2	D
PD-Zr	M2,92	JAPD 6(1)	D
Pm-Po	M2	M2	T

Pm-Pr	M2	M2	D
Pm-Pu	M2,92	M2	D
Pm-Rh	M2	M2	D
Pm-Ru	M2	M2	D
Pm-Sm	M2	M2	D
Pm-Tb	M2	M2	D
Pm-Th	M2	M2	D
Pm-Tl	M2	[88Sac] 224	D
Pm-Tm	M2	M2	D
Pm-V	M2	Binary Vanadium	D
Pm-V	M2	Binary Tungsten	T
Pm-Y	M2	M2	D
Po-Pr	M2	[63Ker 97, Shunk 17]	T
Po-Pt	M2	M2	T
Po-S	M2	[Hansen] 6	T
Po-Sc	M2	M2	T
Po-Sm	M2	M2	T
Po-Sr	M2	M2	T
Po-Ta	M2	[60Wit] 80	T
Po-Tb	M2	M2	T
Po-Ti	M2	M2	T

Po-Tm	M2	M2	T
Po-W	M2	Binary Tungsten	T
Po-Y	M2	M2	T
Po-Yb	M2	M2	T
Po-Zn	M2	M2	T
Po-Zr	M2	M2	T
Pr-Pt	M2	M2	D
Pr-Pu	M2	M2	D
Pr-Rb	No Data		
Pr-Re	M2	[64EII] 108	D
Pr-Rh	M2	M2	D
Pr-Ru	M2	M2	D
Pr-S	M2,91	M2	T
*Pr-Sb	M2	M2	D
Pr-Sc	No Data		
*Pr-Se	M2	[70Yar] 157	D
*Pr-Si	M2	M2	D
Pr-Sm	M2	M2	D
*Pr-Sn	M2	M2	D
Pr-Sr	No Data		
Pr-Ta	M2	[Moffatt] 11	D

Pr-Tb	M2	M2	D
Pr-Tc	M2	[64Dar] 107	T
*Pr-Te	M2	[70Yar] 157	D
Pr-Th	M2	[67Bad1] 128	D
Pr-Ti	M2	M2	D
*Pr-Tl	M2	Unpublished	D
Pr-Tm	M2	M2	D
Pr-U	M2	M2	D
Pr-V	M2	Binary Vanadium	D
Pr-W	M2	Binary Tungsten	D
Pr-Y	M2	M2	D
Pr-Yb	No Data		
*Pr-Zn	M2	[70Mas] 152	D
Pt-Pu	M2	BAPD 10(4a)	D
Pt-Rb	M2	[81Loe] 209	T
Pt-Re	M2	M2	D
*Pt-Rh	M2,92	[Moffatt] 11	D
Pt-Ru	M2	[72Hut] 163	D
Pt-S	M2	Unpublished	D
Pt-Sb	M2,92	M2	D
Pt-Sc	M2	M2	D

Pt-Se	M2	M2	T
*Pt-Si	M2	JPE 12(5)	D
Pt-Sm	M2	M2	D
*Pt-Sn	M2	[Hansen] 6	D
Pt-Sr	M2	M2	D
Pt-Ta	M2	[81Wat] 211	D
Pt-Tb	M2	M2	D
Pt-Tc	M2	M2	D
*Pt-Te	M2	M2	D
Pt-Th	M2	BAPD 11(3)	D
*Pt-Ti	M2	Binary Titanium	D
*Pt-Tl	M2	M2	D
Pt-Tm	M2	M2	D
*Pt-U	M2	BAPD 11(3)	D
*Pt-V	M2	Binary Vanadium	D
Pt-W	M2,91	Binary Tungsten	D
Pt-Y	M2	BAPD 11(5)	D
Pt-Yb	M2	M2	D
Pt-Zn	M2	JPE 12(4)	D
*Pt-Zr	M2	M2	D
Pu-Rb	No Data		

Pu-Re	M2	[67Bow] 130	D
Pu-Rh	M2	[78Lan] 196	D
Pu-Ru	M2	[67Kut2] 136	D
Pu-S	M2	M2	T
Pu-Sb	M2	M2	T
*Pu-Sc	M2	M2	D
Pu-Se	M2	M2	T
Pu-Si	M2	[Shunk] 17	D
Pu-Sm	M2	M2	D
Pu-Sn	M2	BAPD 9(2)	D
Pu-Sr	M2	M2	T
Pu-Ta	M2	JPE 12(5)	D
Pu-Tb	M2	M2	D
Pu-Te	M2	M2	T
Pu-Th	M2	BAPD 6(3)	D
Pu-Ti	M2	Binary Titanium	D
Pu-Tl	M2	[58Boc] 59	T
Pu-Tm	M2	M2	D
*Pu-U	M2,92	BAPD 10(2)	D
Pu-V	M2,91	JPE 12(5)	D
Pu-W	M2	Binary Tungsten	D

Pu-Y	M2	M2	D
Pu-Yb	M2	M2	D
*Pu-Zn	M2	[Chiotti] 3	D
*Pu-Zr	M2	[Elliott] 4	D
Ra-S	M2	M2	T
Ra-Se	M2	M2	T
Ra-W	M2	Binary Tungsten	T
Rb-Re	No Data		
Rb-Rh	M2	[81Loe] 209	T
Rb-Ru	M2	[81Loe] 209	T
Rb-S	M2	M2	D
*Rb-Sb	M2	[61Dor2] 83	D
Rb-Sc	No Data		
*Rb-Se	M2	M2	D
Rb-Si	M2	M2	T
Rb-Sm	No Data		
Rb-Sn	M2	M2	T
Rb-Sr	M2	BAPD 6(1)	T
Rb-Ta	M2,91	JAPD 6(3)	D
Rb-Tb	No Data		
Rb-Te	M2	Unpublished	D

Rb-Th	No Data		
Rb-Ti	M2	BAPD 10(2)	D
*Rb-Tl	M2	[70Thu] 155	D
Rb-Tm	No Data		
Rb-U	No Data		
Rb-V	M2	Binary Vanadium	D
Rb-W	M2	Binary Tungsten	T
Rb-Y	No Data		
Rb-Yb	No Data		
Rb-Zn	M2	BAPD 8(5)	D
Rb-Zr	M2	BAPD 8(1)	D
Re-Rh	M2	[62Ty13] 95	D
*Re-Ru	M2	[62Rud] 92	D
Re-S	M2	M2	T
Re-Sb	M2	M2	D
Re-Sc	M2	[66Sav] 126	D
Re-Se	M2	M2	T
*Re-Si	M2	Unpublished	D
Re-Sm	M2	M2	T
Re-Sn	M2	M2	D
Re-Sr	No Data		

Re-Ta	M2	[60Bro] 70	D
Re-Tb	M2	[68Sav] 145	D
Re-Tc	M2	M2	D
*Re-Te	M2	[77Kur] 190	D
Re-Th	M2	[77Gar] 189	D
Re-Ti	M2	Binary Titanium	D
Re-Tl	No Data		
Re-Tm	M2	M2	T
*Re-U	M2	M2	D
*Re-V	M2	Binary Vanadium	D
Re-W	M2,92	Binary Tungsten	D
Re-Y	M2	[61Lun] 86	D
Re-Yb	M2	M2	T
Re-Zn	M2	M2	T
Re-Zr	M2	M2	D
Rh-Ru	M2	[84Pas] 217	D
Rh-S	M2,92	[Moffatt] 11	D
Rh-Sb	M2	[Shunk] 17	D
Rh-Sc	M2	[58Com 60, 61Dwi 84]	T
*Rh-Se	M2	M2	D
Rh-Si	M2,92	JPE 13(1)	D

Rh-Sm	M2	M2	D
Rh-Sn	M2	[Hansen] 6	D
Rh-Sr	M2	M2	T
*Rh-Ta	M2	[64Gie] 109	D
Rh-Tb	M2	M2	D
Rh-Tc	M2	M2	D
Rh-Te	M2,91	M2	D
Rh-Th	M2	[63Tho] 103	D
*Rh-Ti	M2	Binary Titanium	D
Rh-Tl	No Data		
Rh-Tm	M2	M2	T
*Rh-U	M2	[Ivanov] 8	D
*Rh-V	M2	Binary Vanadium	D
Rh-W	M2	Binary Tungsten	D
Rh-Y	M2	M2	D
Rh-Yb	M2	[76Ian] 185	D
Rh-Zn	M2	M2	D
Rh-Zr	M2	Unpublished	D
Rn-W		Binary Tungsten	T
Ru-S	M2,91	M2	D
Ru-Sb	M2	M2	T

Ru-Sc	M2	[Moffatt] 11	D
Ru-Se	M2	M2	D
*Ru-Si	M2,92	M2	D
Ru-Sm	M2,91	M2	D
Ru-Sn	M2	M2	D
Ru-Sr	No Data		
*Ru-Ta	M2,91	M2	D
Ru-Tb	M2	M2	D
Ru-Tc	M2	M2	T
Ru-Te	M2	M2	D
Ru-Th	M2	[63Tho] 103	D
*Ru-Ti	M2	Binary Titanium	D
Ru-Tl	No Data	D	
Ru-Tm	M2	M2	D
*Ru-U	M2	BAPD 2(4)	D
*Ru-V	M2	Binary Vanadium	D
Ru-W	M2,92	Binary Tungsten	D
Ru-Y	M2	M2	D
Ru-Yb	M2	[76Ian] 185	D
Ru-Zn	M2	M2	D
Ru-Zr	M2	Unpublished	D

S-Sb	M2	M2	D
S-Sc	M2	M2	T
*S-Se	M2	Unpublished	D
S-Si	M2	M2	D
S-Sm	M2	M2	D
*S-Sn	M2	BAPD 7(3)	D
S-Sr	M2	M2	T
S-Ta	No Data		
S-Tb	M2	M2	T
S-Tc	M2	M2	T
*S-Te	M2	BAPD 10(4)	D
S-Th	M2	M2	T
*S-Ti	M2	Binary Titanium	D
S-Tl	M2	M2	D
S-Tm	M2	M2	T
S-U	M2	M2	D
S-V	M2	Binary Vanadium	D
S-W	M2	Binary Tungsten	D
S-Y	M2	M2	T
S-Yb	M2	[78Eli] 194	D
S-Zn	M2	Unpublished	D

S-Zr	M2	M2	D
*Sb-Se	M2	M2	D
*Sb-Si	M2	BAPD 6(5)	D
*Sb-Sm	M2	M2	D
*Sb-Sn	M2	[71Pre] 160	D
*Sb-Sr	M2	[75Vak] 184	D
Sb-Ta	No Data		
*Sb-Tb	M2	M2	D
*Sb-Te	M2	M2	D
Sb-Th	M2	M2	T
Sb-Ti	M2	Binary Titanium	D
*Sb-Tl	M2	Unpublished	D
Sb-Tm	M2	M2	T
*Sb-U	M2	BAPD 1(2)	D
Sb-V	M2	Binary Vanadium	T
Sb-W	M2,92	Binary Tungsten	T
*Sb-Y	M2	[70Sch] 154	D
Sb-Yb	M2	M2	D
*Sb-Zn	M2	[27Tak 34, 66Vui 127]	D
Sb-Zr	M2	Unpublished	D
Sc-Se	M2	M2	T

Sc-Si	M2	BAPD 7(4)	D
Sc-Sm	No Data		
Sc-Sn	M2	M2	T
Sc-Sr	M2	M2	D
Sc-Ta	M2	[66Den1] 123	D
Sc-Tb	M2	M2	D
Sc-Tc	M2	M2	T
Sc-Te	M2	M2	D
Sc-Th	M2,91	[69Bad] 146	D
*Sc-Ti	M2	Binary Titanium	D
Sc-Tl	No Data		
Sc-Tm	No Data		
Sc-U	M2	M2	D
Sc-V	M2	Binary Vanadium	D
Sc-W	M2	Binary Tungsten	D
*Sc-Y	M2	BAPD 4(2)	D
Sc-Yb	M2	M2	D
Sc-Zn	M2	[Pearson3] 14	T
*Sc-Zr	M2	JPE 12(1)	D
Se-Si	M2	M2	T
Se-Sm	M2	M2	T

*Se-Sn	M2	BAPD 7(1)	D
*Se-Sr	M2	[75Lys] 182	D
Se-Ta	M2	[Pearson3] 14	T
Se-Tb	M2	M2	T
*Se-Te	M2	Unpublished	D
Se-Th	M2	[Hansen] 6	D
Se-Ti	M2	Binary Titanium	T
*Se-Tl	M2	[81Mor] 210	D
*Se-Tm	M2	M2	D
*Se-U	M2	[75E11] 180	D
Se-V	M2	Binary Vanadium	D
Se-W	M2	Binary Tungsten	T
Se-Y	M2	M2	T
Se-Yb	M2	M2	D
Se-Zn	M2	Unpublished	D
Se-Zr	M2	M2	T
Si-Sm	M2	BAPD 9(5)	D
*Si-Sn	M2	BAPD 5(3)	D
*Si-Sr	M2	BAPD 10(6)	D
*Si-Ta	M2	Unpublished	D
Si-Tb	M2	M2	T

Si-Tc	M2	M2	T
*Si-Te	M2	[80Dav] 202	D
*Si-Th	M2	[Thorium] 20	D
*Si-Ti	M2	Binary Titanium	D
Si-Tl	M2	BAPD 6(6)	D
Si-Tm	M2	M2	D
*Si-U	M2	M2	D
*Si-V	M2	Binary Vanadium	D
Si-W	M2	Binary Tungsten	D
Si-Y	M2,91	BAPD 7(5)	D
Si-Yb	M2	M2	D
*Si-Zn	M2	BAPD 6(6)	D
*Si-Zr	M2	BAPD 11(5)	D
*Sm-Sn	M2	[82Bor] 212	D
Sm-Sr	No Data		
Sm-Ta	M2	[66Den2] 124	D
Sm-Tb	M2	M2	D
Sm-Te	M2	M2	T
Sm-Th	M2	M2	D
Sm-Ti	No Data		
*Sm-Tl	M2	Unpublished	D

Sm-Tm	M2	M2	D
Sm-U	M2	M2	D
Sm-V	M2	Binary Vanadium	D
Sm-W	M2	Binary Tungsten	D
Sm-Y	M2	BAPD 4(2)	D
Sm-Yb	No Data		
*Sm-Zn	M2	[Moffatt] 11	D
Sm-Zr	M2	[Elliott] 4	T
Sn-Sr	M2	M2	D
Sn-Ta	M2	M2	T
Sn-Tb	No Data		
Sn-Tc	M2	M2	T
*Sn-Te	M2	BAPD 7(1)	D
Sn-Th	M2	BAPD 10(4a)	D
*Sn-Ti	M2	Binary Titanium	D
*Sn-Tl	M2	M2	D
Sn-Tm	M2	M2	T
*Sn-U	M2	BAPD 8(4)	D
Sn-V	M2	Binary Vanadium	D
Sn-W	M2	Binary Tungsten	T
*Sn-Y	M2	M2	D

*Sn-Yb	M2	JPE 12(4)	D
*Sn-Zn	M2	BAPD 6(4)	D
*Sn-Zr	M2	BAPD 4(2)	D
Sr-Ta	No Data		
Sr-Tb	No Data		
*Sr-Te	M2	[75Lys] 182	D
Sr-Th	No Data		
Sr-Ti	M2	Binary Titanium	D
*Sr-Tl	M2	M2	D
Sr-Tm	No Data		
Sr-U	M2	M2	T
Sr-V	M2	Binary Vanadium	D
Sr-W	M2	Binary Tungsten	T
Sr-Y	M2	M2	D
Sr-Yb	No Data		
*Sr-Zn	M2	M2	D
Sr-Zr	No Data		
T-Ta	92	[90Con] 225	D
Ta-Tb	M2	[66Den1] 123	D
Ta-Tc	M2	M2	T
Ta-Te	M2,92	JPE 13(3)	T

*Ta-Th	M2	JAPD 5(1)	D
*Ta-Ti	M2	Binary Titanium	D
Ta-Tl	M2	M2	D
Ta-Tm	M2	[66Den1] 123	D
*Ta-U	M2	JAPD 4(3)	D
*Ta-V	M2	Binary	D
*Ta-W	M2	Binary Tungsten	D
Ta-Y	M2	M2	D
Ta-Yb	M2	M2	D
Ta-Zn	M2	[Pearson3] 14	T
*Ta-Zr	M2	JAPD 5(2)	D
Tb-Tc	M2	M2	T
Tb-Te	M2	M2	T
Tb-Th	M2	[67Bad2] 129	D
Tb-Ti	M2	[83Kub] 216	D
*Tb-Ti	M2	Unpublished	D
Tb-Tm	M2	M2	D
Tb-U	M2	[Elliott] 4	T
Tb-V	M2	Binary Vanadium	D
Tb-W	M2	Binary Tungsten	D
Tb-Y	M2	BAPD 4(2)	D

Tb-Yb	M2	M2	D
Tb-Zn	M2	M2	D
Tb-Zr	M2	[Moffatt] 11	D
Tc-Te	M2	M2	D
Tc-Th	M2	[65Dar] 118	T
Tc-Ti	M2	Binary Titanium	D
Tc-U	M2	[65Dar] 118	T
Tc-V	M2	Binary Vanadium	D
Tc-W	M2	Binary Tungsten	D
Tc-Y	M2	M2	T
Tc-Zn	M2	[64Cha] 106	D
Tc-Zr	M2	M2	T
Te-Th	M2	M2	T
Te-Ti	M2	Binary Titanium	T
*Te-Tl	M2,91	M2	D
Te-Tm	M2	M2	D
*Te-U	M2	[Moffatt] 11	D
Te-V	M2	Binary Vanadium	D
Te-W	M2	Binary Tungsten	D
Te-Y	M2	M2	D
*Te-Yb	M2	M2	D

*Te-Zn	M2	BAPD 8(1)	D
Te-Zr	M2	M2	D
*Th-Ti	M2	Binary Titanium	D
*Th-Tl	M2	M2	D
Th-Tm	M2	[Moffatt] 11	D
Th-U	M2	BAPD 6(5)	D
Th-V	M2	Binary Vanadium	D
Th-W	M2	Binary Tungsten	D
Th-Y	M2	[60Eas] 72	D
Th-Yb	M2	M2, D	
*Th-Zn	M2	[61Chi] 81	D
*Th-Zr	M2	[58Gib 62, 61Joh 85]	D
Ti-Tm	M2	M2	D
*Ti-U	M2	Binary Titanium	D
*Ti-V	M2	Binary Vanadium	D
*Ti-W	M2	Binary Tungsten	D
*Ti-Y	M2	Binary Titanium	D
Ti-Yb	M2	M2	D
Ti-Zn	M2	Binary Titanium	D
*Ti-Zr	M2	Binary Titanium	D
Tl-Tm	M2	M2	D

Tl-U	M2	[52Ian 44, 63Joh 96]	T
Tl-V	M2	Binary Vanadium	D
Tl-W	M2	Binary Tungsten	T
Tl-Y	M2,91	M2	T
*Tl-Yb	M2	Unpublished	D
*Tl-Zn	M2	[07Veg 27, 52Sei 47]	D
Tl-Zr	M2	M2	T
Tm-U	M2	M2	T
Tm-V	M2	Binary Vanadium	D
Tm-W	M2	Binary Tungsten	D
Tm-Y	M2	M2	D
Tm-Yb	M2	M2	D
Tm-Zn	M2	M2	D
Tm-Zr	M2	[Shunk] 17	T
U-V	M2	Binary Vanadium	D
U-W	M2	Binary Tungsten	D
U-Y	M2	M2	D
U-Yb	M2	M2	D
U-Zn	M2	BAPD 1(2)	D
*U-Zr	M2,92	BAPD 10(2)	D
*V-W	M2	Binary Tungsten	D

V-Y	M2	Binary Vanadium	D
V-Yb	M2	Binary Vanadium	D
V-Zn	M2	Binary Vanadium	D
*V-Zr	M2	Binary Vanadium	D
W-Xe		Binary Tungsten	T
W-Y	M2	Binary Tungsten	D
W-Yb	M2	Binary Tungsten	D
W-Zn	M2	Binary Tungsten	T
*W-Zr	M2,92	Binary Tungsten	D
Y-Yb	M2	M2	D
*Y-Zn	M2	M2	D
*Y-Zr	M2	JPE 12(4)	D
*Yb-Zn	M2	[68Mas] 143	D
Yb-Zr	M2	M2	D
Zn-Zr	M2	JPE 13(4)	D

- (a) Key to titles of Alloy Phase Diagram Publications abbreviated under "Published" and "Data Source": **BAPD** Bulletin of Alloy Phase Diagrams ASM International **Binary Beryllium** Phase Diagrams of Binary Beryllium Alloys ASM International, 1987 **Binary Gold** Phase Diagrams of Binary Gold Alloys ASM International, 1988 **Binary Iron** Phase Diagrams of Binary Iron Alloys ASM International, 1993 **Binary Magnesium** Phase Diagrams of Binary Magnesium Alloys ASM International, 1988 **Binary Nickel** Phase Diagrams of Binary Nickel Alloys ASM International, 1991 **Binary Titanium** Phase Diagrams of Binary Titanium Alloys ASM International, 1987 **Binary Tungsten** Phase Diagrams of Binary Tungsten Alloys The Indian Institute of Metals, 1991 **Binary Vanadium** Phase Diagrams of Binary Vanadium Alloys ASM International, 1989 **Indium** Phase Diagrams of Indium Alloys and Their Engineering Applications ASM International, 1992 **JAPD** Journal of Alloy Phase Diagrams The Indian Institute of Metals **JPE** Journal of Phase Equilibria ASM International **M2** Binary Alloy Phase Diagrams, 2nd edition ASM International, 1990 **91** Binary Alloy Phase Diagrams Updating Service ASM International, Dec. 1991 **92** Binary Alloy Phase Diagrams Updating Service ASM International, July and Dec. 1992

References cited in this section

2. [**Brandes**]: E.A. Brandes and R.F. Flint, Ed., *Manganese Phase Diagrams*, The Manganese Centre, 17 Avenue Hoche, 75008 Paris, France (1980).

3. [**Chiotti**]: P. Chiotti, V.V. Akhachinskij, and I. Ansara, *The Chemical Thermodynamics of Actinide Elements and Compounds*, Part 5: The Actinide Binary Alloys, V. Medvedev, M.H. Rand, E.F. Westrum, Jr., and F.L. Oetting, Ed., International Atomic Energy Agency, Vienna (1981).
4. [**Elliott**]: R.P. Elliott, *Constitution of Binary Alloys, First Supplement*, McGraw-Hill, New York or General Electric Co., Business Growth Services, Schenectady, New York (1965).
5. [**Hafnium**]: P.J. Spencer, O. von Goldbeck, R. Ferro, R. Marazza, K. Girgis, and O. Kubaschewski, *Hafnium: Physico-Chemical Properties of Its Compounds and Alloys*, K.L. Komerek, Ed., Atomic Energy Review Special Issue No.8, International Atomic Energy Agency, Vienna (1981).
6. [**Hansen**]: M. Hansen and K. Anderko, *Constitution of Binary Alloys*, McGraw-Hill, New York or General Electric Co., Business Growth Services, Schenectady, New York (1958).
7. [**Hultgren, B**]: R. Hultgren, P.D. Desai, D.T. Hawkins, M. Gleiser, and K.K. Kelley, *Selected Values of the Thermodynamic Properties of Binary Alloys*, American Society for Metals, Metals Park, Ohio (1973).
8. [**Ivanov**]: O.S. Ivanov, T.A. Badaeva, R.M. Sofronova, V.B. Kishenevskii, and N.P. Kushnir, *Phase Diagrams of Uranium Alloys*, Nauka, Moscow (1972).
10. [**Metals**]: *Metals Handbook*, Metallography, Structures and Phase Diagrams, Vol.8, 8th ed., American Society for Metals, Metals Park, OH (1973).
11. [**Moffatt**]: W.G. Moffatt, Ed., *Handbook of Binary Phase Diagrams*, Business Growth Services, General Electric Co., Schenectady, NY (1976).
12. [**Molybdenum**]: L. Brewer, *Molybdenum: Physico-Chemical Properties of Its Compounds and Alloys*, O. Kubaschewski, Ed., Atomic Energy Review Special Issue No.7, International Atomic Energy Agency, Vienna (1980).
14. [**Pearson3**]: P. Villars and L.D. Calvert, *Pearson's Handbook of Crystallographic Data for Intermetallic Phases*, Vol.1, 2, and 3, American Society for Metals, Metals Park, OH (1985).
16. [**Plutonium**]: M.H. Rand, D.T. Livey, P. Feschotte, H. Nowotny, K. Seifert, and R. Ferro, *Plutonium: Physico-Chemical Properties of Its Compounds and Alloys*, O. Kubaschewski, Ed., Atomic Energy Review Special Issues No. 1, International Atomic Energy Agency, Vienna (1966).
17. [**Shunk**]: F.A. Shunk, *Constitution of Binary Alloys, Second Supplement*, McGraw-Hill, New York or General Electric Co., Business Growth Services, Schenectady, New York (1969).
18. [**Smith**]: J.F. Smith, O.N. Carlson, D.T. Peterson, and T.E. Scott, *Thorium: Preparation and Properties*, Iowa State University Press, Ames, IA (1975).
19. [**Smithells**]: C.J. Smithells and E.A. Brandes, *Metals Reference Book*, 5th ed., Butterworths, Wobum, MA (1976).
20. [**Thorium**]: M.H. Rand, O. von Goldbeck, R. Ferro, K. Girgis, and A.L. Dragoo, *Thorium: Physico-Chemical Properties of Its Compounds and Alloys*, O. Kubaschewski, Ed., Atomic Energy Review Special Issue No.5, International Atomic Energy Agency, Vienna (1975).
21. [**Zirconium**]: C.B. Alcock, K.T. Jacob, S. Zador, O. von Goldbeck, H. Nowotny, K. Seifert, and O. Kubaschewski, *Zirconium: Physico-Chemical Properties of Its Compounds and Alloys*, O. Kubaschewski, Ed., Atomic Energy Review Special Issue No.6, International Atomic Energy Agency, Vienna (1976).
23. **1898Gra**: A. Granger, *Ann. Chim. Phys.*, 14, 5-90 (1898).
24. **05Bol**: W. v.Bolton, *Z. Elektrochem.*, 11, 51 (1905).
25. **05Emi**: F. Emich, *Monatsh. Chem.*, 26, 1013 (1905).
26. **06Mat**: C.H. Mathewson, *Z. Anorg. Allg. Chem.*, 50, 192-195 (1906).
27. **07Veg**: A.V. Vegesack, *Z. Anorg. Allg. Chem.*, 52, 30-34 (1907).
28. **08Fis**: F. Fisher and G. Iliovich, *Ber. Dtsch. Chem Ges.*, 41, 3802, 4449 (1908); 42, 527 (1909); quoted in [Elliott].
29. **08Fri**: K. Friedrich, *Metallurgie*, 5, 212-215 (1908).
30. **08Vos**: G. Voss, *Z. Anorg. Allg. Chem.*, 57, 49-52 (1908).
31. **10Sie**: A. Sieverts and W. Krumbhaar, *Ber. Dtsch. Chem. Ges.*, 43, 894 (1910) in German.
32. **20Viv**: A.C. Vivian, *J. Inst. Met.* 23, 325-366 (1920).

33. **22Bru:** A. Brukel, *Z. Anorg. Allg. Chem.*, *125*, 255-256 (1922).
34. **27Tak:** T. Takei, *Sci. Rep. Tohoku Univ.*, *16*, 1031-1056 (1927).
35. **30Mul:** L. Muller, *Ann. Phys.*, *7*, 9-47 (1930) in German.
36. **34Gru:** G. Grube and G. Schaufler, *Z. Elektrochem.*, *40*, 593-600 (1934).
37. **36Gru:** G. Grube and A. Schmidt, *Z. Elektrochem.*, *42*, 201-209 (1936).
38. **38Gru:** G. Grube and A. Dietrich, *Z. Elektrochem.*, *44*, 755-758 (1938).
39. **40And:** K.W. Andrews, H.E. Davies, W. Hume-Rothery, and C.R. Oswin, *Proc. Roy. Soc. (London)*, *A177*, 149-167 (1940-1941).
40. **41Rol:** L. Rolla and A. Iandelli, *Ric. Sci.*, *20*, 1216-1226 (1941).
41. **42Gru:** G. Grube and L. Botzenhardt, *Z. Elektrochem.*, *48*, 418-425 (1942).
42. **42Mon:** E. Montignie, *Bull. Soc. Chim. Fr.*, *9*, 658-661 (1942).
43. **50Ber:** J. Berak and T. Heumann, *Z. Metallkd.*, *41*, 19-23 (1950).
44. **52Ian:** A. Iandelli and R. Ferro, *Ann. Chim. (Rome)*, *42*, 598-606 (1952).
45. **52Now:** H. Nowotny, E. Bauer, A. Stampfl, and H. Bittmer, *Monatsh. Chem.*, *83*, 221-236 (1952).
46. **52Kos:** W. Koster and E. Horn, *Z. Metallkd.*, *43*, 444-449 (1952).
47. **52Sei:** W. Seith, H. Johnson, and J. Wagner, *Z. Metallkd.*, *46*, 773-779 (1952).
48. **53Gea:** G.A. Geach and R.A. Jettery, *J. Met.*, *5*, 1084 (1953).
49. **54Vog:** R. Vogel and H. Klose, *Z. Metallkd.*, *45*, 633-638 (1954).
50. **55Kon:** S.T. Konobeevsky, Conf. Acad. Sci. USSR. Peaceful Uses Atomic Energy, Div. Chem. Sci., *1* (1955).
51. **55Rau:** E. Raub and W. Mahler, *Z. Metallkd.*, *46*, 282-290 (1955).
52. **56Car:** O.N. Carlson, J.M. Dickenson, H.E. Lunt, and H.A. Wilhelm, *Trans. AIME*, *206*, 132-136 (1956).
53. **56Cat:** J.A. Catterall, J.D. Grogan, and R.J. Pleasance, *J. Inst. Met.*, *85*, 63-67 (1956).
54. **56MuI:** R.N.P. Mulford and G.E. Sturdy, *J. Am. Chem. Soc.*, *78*, 3897-3901 (1956).
55. **56Pel:** E. Pelzel, *Metall*, *10*, 717-718 (1956).
56. **56Rau:** E. Raub and W. Plate, *Z. Metallkd.*, *47*, 688-693 (1956) in German.
57. **56Swa:** H.E. Swanson, N.T. Gilfrich, and G.M. Ugrinic, NBS Circ. 539 (1956).
58. **56Tru:** F.A. Trumbore, C.D. Thurmond, and M. Kowalchik, *J. Chem. Phys.*, *24*, 1112 (1956).
59. **58Boc:** A.A. Bochvar *et al.*, Proc. U.N. Int Conf. Peaceful Uses At. Energy, 2nd, Geneva, Vol. 6, 184-193 (1958); quoted from [Shunk].
60. **58Com:** V.B. Compton, *Acta Crystallogr*, *11*, 446 (1958).
61. **58Dom:** R.F. Domagala, R.P. Elliott, and W. Rostoker, *Trans. AIME*, *212*, 393-395 (1958)
62. **58Gib:** E.D. Gibson, B.A. Loomis, and O.N. Carlson, *Trans. ASM*, *50*, 348-369 (1958).
63. **58Mul:** R.N.R. Mulford, USAEC, AECU-3813 (1958).
64. **59Boz:** R.M. Bozworth, B.T. Matthias, H. Suhl, E. Corenzwit, and D.D. Davis, *Phys. Rev.*, *115*, 1595-1596 (1959).
65. **59Com:** V.B. Compton and B.T. Matthias, *Acta Crystallogr.*, *12*, 651-654 (1959).
66. **59Ell:** R.P. Elliott, *Trans. ASM*, *52*, 990-1014 (1959).
67. **59Hel:** A. Hellawell, *J. Less-Common Met.*, *1*, 343-347 (1959).
68. **59Sch:** F.W. Schonfeld, E.M. Cramer, W.N. Miner, F.H. Elinger, and A.S. Coffinberry, *Progress in Nuclear Energy*, Ser. V, Vol. 2, Pergamon Press, New York, 579-599, (1959).
69. **60Bec:** R.L. Beck, USAEC, LAR-10, 93 p (1960).
70. **60Bro:** J.H. Brophy, P. Schwarzkopt, and J. Wulff, *Trans. AIME*, *218*, 910-914 (1960).
71. **60Cro:** J. Croni, C.E. Armantrout, and H. Kato, U.S. Bur. Mines, Rep. Invest. 5688, 12 p (1960).
72. **60Eas:** D.T. Eash and O.N. Carlson, *Trans, ASM*, *52*, 1097-1114 (1960).

73. **60Gra:** N.J. Grant and B.C. Giessen, WADD Tech. Rept., 60-132, 90-112 (1960); *J. Met.*, 13, 87 (1961); as quoted in [Elliott].
74. **60Kau:** A.R. Kaufmann, E.J. Rapperport, and M.F. Smith, WADD Tech. Rep. 60-132, 33-39 (1960).
75. **60Lya:** V.S. Lyashenko and V. Bykov, *At. Energy (USSR)*, 8, 146-148 (1960) in Russian; TR: *Sov. J. At. Energy*, 8, 132-134 (1960).
76. **60Pet1:** D.T. Peterson and M. Indig, *J. Am. Chem. Soc.*, 80, 5645-5646 (1960).
77. **60Pet2:** D.T. Peterson and D.J. Beerntsen, *Trans. ASM*, 52, 763-777 (1960).
78. **60Pre:** B. Predel, *Z. Phys. Chem.*, 24, 206-216 (1960).
79. **60Sav:** E.M. Savitskii and C.V. Kopetskii, *Zh. Neorg. Khim.*, 5, 2638-2640 (1960) in Russian; TR: *Russ J. Inorg. Chem.*, 5, 1274-1275 (1960).
80. **60Wit:** W.G. Witteman, A.L. Giorgi, and D.T. Vier, *J. Phys. Chem.*, 64, 434-440 (1960).
81. **61Chi:** P. Chiotti and K.J. Gill, *Trans. AIME*, 221, 573-580 (1961).
82. **61Dor1:** F.W. Dorn, W. Klemm, and S. Lohmeyer, *Z. Anorg. Allg. Chem.*, 209, 204-209 (1961).
83. **61Dor2:** F.W. Dorn and W. Klemm, *Z. Anorg. Allg. Chem.*, 309, 189-203 (1961).
84. **61Dwi:** A.E. Dwight, J.W. Downey, and R.A. Conner, Jr., *Acta Crystallogr*, 14, 75-76 (1961).
85. **61Joh:** R.H. Johnson and R.W.K. Honeycombe, *J. Nucl. Mater*, 4, 66-69 (1961).
86. **61Lun:** C.E. Lundin, in *The Rare Earths*, F.H. Spedding and A.H. Daane, Ed., John Wiley & Sons, New York, 263-264 (1961).
87. **61Lov:** B. Love, WADD Tech. Rep., 61-123, 179p (1961); quoted in [Elliott].
88. **61Poo:** D.M. Poole, M.G. Bale, P.G. Mardon, J.A.C. Marples, and J.L. Nichols, *Plutonium 1960*, Cleaver-Humes Press, London, 267-280 (1961).
89. **61Sav:** E.M. Savitskii, M.A. Tylkina, R.V. Kirilenko, and C.V. Kopetskii, *Zh. Neorg. Khim.*, 6, 1474-1476 (1961) in Russian; TR: *Russ. J. Inorg. Chem.*, 6, 755-756 (1961).
90. **62Lun:** C.E. Lundin and D.T. Klodt, *Trans. AIME*, 224, 367-372 (1962).
92. **62Rud:** E. Rudy, B. Kietter, and H. Froelich, *Z. Metallkd.*, 53, 90-92 (1962).
93. **62Tyl1:** M.A. Tylkina, V.P. Polyakova, and E.M. Savitskii, *Zh. Neorg. Khim.*, 7, 1469-1470 (1962) in Russian; TR: *Russ. J. Inorg. Chem.*, 7, 755-756 (1962).
94. **62Tyl2:** M.A. Tylkina, V.P. Polyakova, and E.M. Savitskii, *Zh. Neorg. Khim.*, 7, 1467-1468 (1962) in Russian; TR: *Russ. J. Inorg. Chem.*, 7, 755-756 (1962).
95. **62Tyl3:** M.A. Tylkina, V.P. Polyakova, and E.M. Savitskii, *Zh. Neorg. Khim.*, 7, 1919-1927 (1962) in Russian; TR: *Russ. J. Inorg. Chem.*, 7, 990-996 (1962).
96. **63Joh:** I. Johnson and M.G. Chasanov, *Trans. ASM*, 56, 272-277 (1963).
97. **63Ker:** C.J. Kershner and R.H. Steinmeyer, USAEC, MLM-1163, F1-F6 (1963).
98. **63Liu:** C.H. Liu, A.S. Pashinkin, and A.V. Novoselova, *Dokl. Akad. Nauk SSSR*, 151, 1335-1338 (1963) in Russian; TR: *Dokl. Chem.*, 151, 662-664 (1963).
99. **63Obr:** W. Obrowski, *Metall*, 17, 108-112 (1963).
100. **63Pel:** G.P. Pells, *J. Inst. Met.*, 92, 416-418 (1963-1964).
101. **63Sch:** S.J. Schneider, NBS Monograph 68, 31 pp (1963).
102. **63Tay:** A. Taylor, B.J. Kagle, and N.J. Doyle, *J. Less-Common Met.*, 5, 26-40 (1963).
103. **63Tho:** J.R. Thompson, *J. Less-Common Met.*, 5, 437-442 (1963).
104. **63Tyl:** M.A. Tylkina, V.P. Polyakova, and O.Kh. Khamidov, *Zh. Neorg. Khim.*, 8, 776-778 (1963) in Russian; TR: *Russ. J. Inorg. Chem.*, 8, 395-397 (1963).
105. **63Wil:** G.P. Williams and L. Slifkin, *Acta Metall.*, 11, 319-322 (1963).
106. **64Cha:** M.G. Chasanov, I. Johnson, and R.V. Schablaske, *J. Less-Common Met.*, 7, 127-132 (1964).
107. **64Dar:** J.B. Darby, Jr., L.J. Norton, and J.W. Downey, *J. Less-Common Met.*, 6, 165-167 (1964).
108. **64EII:** R.P. Elliott, in *Rare Earth Research III*, Proc. 4th Conf. Rare Earth Res., L. Eyring, Ed., Gordon and Breach, New York, 215-245 (1964).

109. **64Gie:** B.C. Giessen, H. Ibach, and N.J. Grant, *Trans. AIME*, 230, 113-122 (1964).
110. **64Hew:** I.F. Hewaidy, E. Busmann, and W. Klemm, *Z. Anorg. Allg. Chem.*, 328, 283-293 (1964).
111. **64Obi1:** I. Obinata, Y. Takeuchi, K. Kurihara, and M. Watanabe, *Nippon Kinzoku Gakkaishi*, 28, 562-568 (1964).
112. **64Obi2:** I. Obinata, Y. Takeuchi, K. Kurihara, and M. Watanabe, *Nippon Kinzoku Gakkaishi*, 28, 568-576 (1964).
113. **64Pec:** W.H. Pechin, D.E. Williams, and W.L. Larsen, *Trans. ASM*, 57, 464-473 (1964).
114. **64Pet:** D.T. Peterson and R.P. Colburn, USAEC Comm. IS-613, 13 p (1964); quoted from [Shunk].
115. **64Rhy:** D.W. Rhys and E.G. Price, *Met. Ind.*, 105, 243-247 (1964).
116. **64Rit:** D.L. Ritter, B.C. Giessen, and N.J. Grant, *Trans. AIME.*, 230, 1250-1267 (1964).
117. **64Wit:** L.J. Wittenburg and G.R. Grove, USAEC, MLM-1208, 8-11 (1964); USAEC, MLM-1244, p 56 (1964); quoted in [Shunk].
118. **65Dar:** J.B. Darby, Jr., A.F. Berndt, and J.W. Downey, *J. Less-Common Met.*, 9, 466-468 (1965).
119. **65Ell:** R.P. Elliott, in *Rare Earth Research III*, L. Eyring, Ed., Gordon and Breach, Science Publishers, New York, 215-245 (1965).
120. **65Haa:** D.J. Haase, H. Steinfink, and E.J. Wpss, in *Rare Earth Research III*, Gordon and Breach, Science Publishers, New York, 535-544 (1965).
121. **65Swi:** J.H. Swisher, NASA Tech. Note, NASA-TN-D-2734, 18 p (1965); quoted in [Shunk].
122. **66Bru:** G. Bruzzone, *Ann. Chim. (Rome)*, 56, 1306-1319 (1966).
123. **66Den1:** D.H. Dennison, M.J. Tschetter, and K.A. Gschneidner, Jr., *J. Less-Common Met.*, 10 (2), 108-115 (1966).
124. **66Den2:** D.H. Dennison, M.J. Tschetter, and K.A. Gschneidner, Jr., *J. Less-Common Met.*, 11, 423-435 (1966).
125. **66Ell:** F.H. Ellinger, K.A. Johnson, and V.O. Struebing, *J. Nucl. Mat.*, 20, 83-86 (1966).
126. **66Sav:** E.M. Savitskiy, M.A. Tylkina, and O.Kh. Khamidov, *Russ. Metall.*, 4, 52-56 (1966).
127. **66Vui:** G. Vuillard and J.P. Piton, *Compt. Rend. C*, 263, 1018-1021 (1966).
128. **67Bad1:** T.A. Badayeva and R.I. Juznetsova, *Russ. Metall.*, (1), 89-92 (1967).
129. **67Bad2:** T.A. Badayeva and R.I. Juznetsova, *Russ. Metall.*, 6, 99-100 (1967).
130. **67Bow:** D.F. Bowersox and J.A. Leary, *J. Nucl. Mater.*, 21, 219-224 (1967).
131. **67Car:** O.N. Carlson, F.A. Schmidt, and D.E. Diesburg, *Trans. ASM*, 60(2), 119-124 (1967).
132. **67Jan:** G. Jangg, H.R. Kirchmayr, and W. Lugscheider, *Z. Metallkd.*, 58, 724-726 (1967) in German.
133. **67Kir1:** H.R. Kirchmayr and W. Lugscheider, *Z. Metallkd.*, 58(3), 185-188 (1967).
134. **67Kir2:** H.R. Kirchmayr and W. Lugscheider, *Z. Metallkd.*, 58, 185-193 (1967) in German.
135. **67Kut1:** V.I. Kutaitsev, N.T. Chebortarev, I.G. Lebedev, M.A. Andrianov, V.N. Konev, and T.S. Menshikova, *Plutonium 1965*, Chapman & Hall, London, 420-449 (1967).
136. **67Kut2:** V.I. Kutaitsev, N.T. Chebortarev, I.G. Lebedev, M.A. Andrianov, V.N. Konev, and T.S. Menshikova, *Plutonium 1965*, Chapman & Hall, London, 420-447 (1967).
137. **67Mcm:** O.D. McMasters and K.A. Gschneidner, Jr., *J. Less-Common Met.*, 13, 193-199 (1967).
138. **67Par:** J.K. Pargeter and W. Hume-Rothery, *J. Less-Common Met.*, 12, 366-374 (1967).
139. **67Rus:** P.G. Rustamov, B.N. Mardakhaev, and M.G. Safarov, *Inorg. Mater.*, 3(3), 429-433 (1967).
140. **67Sto:** E.K. Storms, *The Refractory Carbides*, Academic Press, New York (1967).
141. **68Gul1:** B.B. Gulyaev and G.F. Dvorshkaya, in *Phase Diagrams of Metallic Systems*, E.M. Savitskii, Ed., Akad. Nauk SSSR, 267-273 (1968) in Russian.
142. **68Gul2:** B.B. Gulyaev, in *Phase Diagrams of Metallic Systems*, E.M. Savitskii, Ed., Nauka, Moscow, 257-267 (1986) in Russian.
143. **68Mas:** J.T. Mason and P. Chiotti, *Trans. AIME*, 242, 1167-1171 (1968).
144. **68Mcm:** O.D. McMasters, T.J. O'Keefe, and K.A. Gschneidner, Jr., *Trans. Metall. Soc. AIME*, 242(5),

936-939 (1968).

145. **68Sav:** E.M. Savitskii and O.Kh. Khamidov, *Russ. Metall.*, (6), 108-111 (1968).
146. **69Bad:** T.A. Badayera and R.I. Kuznetsova, *Izv. Akad. Nauk SSSR, Met.*, (15), 156-193 (1969) in Russian; TR: *Russ. Metall.*, (5), 101-106 (1969).
147. **69Ben1:** R. Benz and P. L. Stone, *High Temp. Sci.*, 1, 114-127 (1969).
148. **69Ben2:** R. Benz, C.G. Hoffman, and G.N. Rupert, *High. Temp. Sci.*, 1, 342-359 (1969).
149. **69Bor:** V.A. Boryaleova, Ya Kh. Grinberg, E.G. Shukov, V.A. Koryazhkin, and Z.S. Medvedeva, *Inorg. Mater. J.*, 397-399 (1969).
150. **69Mcm:** O.D. McMasters and K.A. Gschneidner, Jr., *J. Less-Common Met.*, 19, 337-344 (1969).
151. **70Kir:** H.R. Kirchmayr and W. Lugscheider, *Z: Metallkd*, 61, 22-23 (1970).
152. **70Mas:** J.T. Mason and P. Chiotti, *Metall. Trans.*, 1, 2119-2123 (1970).
153. **70Sad:** O.A. Sadvovskaya and E.I. Yarembash, *Russ. Inorg. Mater.*, 6(7), 1097-1101 (1970).
154. **70Sch:** F.A. Schmidt and O.D. McMasters, *J. Less-Common Met.*, 21, 415-425 (1970).
155. **70Thu:** R. Thummel and W. Klemm, *Z. Anorg. Allg. Chem.*, 376, 44-63 (1970) in German.
156. **70Woo:** D.H. Wood, E.M. Cramer, and P.L. Wallace, *Nucl. Metall.*, 17, 707-719 (1970).
157. **70Yar:** E.I. Yarembach, *Colloq. Intern. CNRS (Paris)*, 1, 472-481 (1970).
158. **71Cun:** P.T. Cunningham, S.A. Johnson, and E.J. Cairns, *J. Electrochem. Soc.*, 118, 1941-1944 (1971).
159. **71Gri:** R.B. Griffin and K.A. Gschneidner, Jr., *Metall. Trans.*, 2(9), 2517-2524 (1971).
160. **71Pre:** B. Predel and W. Schwermann, *J. Inst. Met.*, 99, 169-173 (1971).
161. **71Sve:** V.N. Svechnikov, G.F. Kobzenko, and V.G. Ivanchenko, *Metallofizika*, (33), 93-95 (1971).
162. **72Bor:** J.D. Bornand and P. Feschotte, *J Less-Common Met.*, 29, 81-91 (1972) in French.
163. **72Hut:** J.M. Hutchinson, Jr., *Platinum Met. Rev.*, 16, 88-90 (1972).
164. **72Jeh:** H. Jehn and E. Olzi, *J. Less-Common Met.*, 27, 297-309 (1972).
165. **72Mas:** J.T. Mason and P. Chiotti, *Metall. Trans.*, 3, 2851-2855 (1972).
166. **72Por:** K.I. Portnoi and V.M. Romashov, *Sov. Powder Metall. Met. Ceram.*, 11, 378-384 (1972).
167. **72Shu:** A.K. Shurin and V.V. Pet'kov, *Russ. Metall.*, (2), 122-144 (1972).
168. **73Bus:** K.H.J. Buschow, *J. Less-Common Met.*, 31, 165-168 (1973).
169. **73Gha:** H. Ghassem and A. Raman, *Metall. Trans.*, 4, 745-748 (1973).
170. **73Ian:** A. Iandelli and A. Palenzona, *Rev. Chim. Miner.*, 303-308 (1973).
171. **73Loe:** O. Loebich, Jr. and E. Raub, *J. Less-Common Met.*, 30, 47-62 (1973).
172. **73Sav:** E. Savitskii, V. Polyakova, and E. Tsyganova, *Redkozemel. Met., Splavy Soedineniya*, Izd. Nauk, Moscow, 182-184(1973).
173. **73Sve:** V.N. Svechnikov, G.F. Kobzenko, and V.G. Ivanchenko, *Dokl. Akad. Nauk SSSR*, 213, 1062-1064 (1973).
174. **74Gsc1:** K.A. Gschneidner, Jr. and M.E. Verkade, Document IS-RIC-7, Rare Earth Information Center, Iowa State Univ., Ames, IA, 40-41(1974).
175. **74Gsc2:** K.A. Gschneidner, Jr. and M.E. Verkade, IS-RIC-7, Rare Earth Information Center, Iowa State Univ., Ames, IA, 30-31 (1974).
176. **74Lev:** Yu.V. Levinskiy, *Russ. Metall.*, (1), 34-37 (1974).
177. **74Ray1:** A.E. Ray, *Cobalt*, (1), 13-20 (1974).
178. **74Ray2:** A.E. Ray, *Cobalt*, (1), 3-20 (1974).
179. **74Yar:** E.I. Yarembash, E.S. Vigileva, A.A. Eliseev, A.V. Zachatskaya, T.G. Aminov, and M.A. Chernitsyna, *Inorg. Mater.*, 10(8), 1212-1215 (1974).
180. **75Ell:** G.V. Ellert, V.G. Sevast'yanov, and V.K. Slovyanskikh, *Russ. J. Inorg. Chem.*, 20(1), 120-124 (1975).
181. **75Gat:** J. Gatterer, D. Dufek, P. Ettmayer, and R. Kieffer, *Monatsh. Chem.*, 106, 1137-1147 (1975).

182. **75Lys:** Yu.B. Lyskova and A.V. Vakhobov, *Inorg. Mater.*, 11, 361-362(1975).
183. **75Sve:** V.N. Svechnikov, G.F. Kobzenko, and V.G. Ivanchenko, *Metallofizika*, (59), 77-83 (1975).
184. **75Vak:** A.V. Vakhobov, Z.U. Niyazova, and B .N. Polev, *Inorg. Mater.*, 11, 306-307 (1975).
185. **76Ian:** A. Iandelli and A. Palenzona, *Rev. Chim. Minerale*, 13, 55-61(1976).
186. **76Mat:** P. Matkovic, M. El-Boragy, and K. Schubert, *J. Less-Common Met.*, 50, 165-176 (1976).
187. **76Vol:** A.E. Vol and I.K. Kagan, *Handbook of Binary Metallic Systems*, Nauka, Moscow (1976) in Russian; TR: NBS/NSF, 760-761 (1985).
188. **77Ere:** V.N. Eremenko, V.G. Batalin, Yu.I. Buyanov, and I.M. Obushenko, *Dop. Akad. Nauk Ukr.RSR, B*, (6) 516-521 (1977) in Russian.
189. **77Gar:** S.P. Garg and R.J. Ackermann, *J. Nucl. Mater.*, 64, 265-274(1977).
190. **77Kur:** T.Kh. Kurbanov, R.A. Dovlyatshina, I.A. Dzhavodova, and F.A. Akhmenov, *Russ J. Inorg. Chem.*, 22, 622-624 (1977).
191. **77Kuz:** A.N. Kuznetsov, K.A. Chuntunov, and S.P. Yatsenko, *Russ. Metall.*, (5), 178-180 (1977).
192. **77Wat:** R.M. Waterstrat and R.C. Manuszewski, *J. Less Common Met.*, 51, 55-67 (1977).
193. **77Yat:** S.P. Yatsenko, *J. Chim. Phys.*, 74, 836-843 (1977).
194. **78Eli:** A.A. Eliseev, G.M. Kuz'micheva, and V.I. Yushrov, *Zh. Neorg. Khim.*, 23,(2), 492-296 (1978) in Russian; TR: *Russ J. Inorg. Chem.*, 23(2), 273-276 (1978).
195. **78Esh:** K.K. Eshnov, M.A. Zukhuridinov, A.V. Vakhobov, and T.D. Zhurayev, *Russ. Metall.*, (1), 171-173 (1978).
196. **78Lan:** C.C. Land, D.E. Peterson, and R.B. Root, *J. Nucl. Mat.*, 75, 262-273 (1978).
197. **78Yat:** S.P. Yatsenko, B.G. Semenov, and K.A. Chuntunov, *Izv. Akad. Nauk SSSR, Met.*, (5) 222-224 (1978) in Russian; TR: *Russ. Metall.*, (51), 173-174(1978).
198. **79Bla:** R. Blachnik and A. Hoppe, *Z. Anorg. Allg. Chem*, 457, 91-104 (1979) in German.
199. **79Vol:** A.E. Vol and I.K. Kagan, *Handbook of Binary Metallic Systems*, Vol.4, Nauka, Moscow (1979) in Russian; translated by NBS and NSF, 588-605 (1986).
200. **79Yat:** S.P. Yatsenko, A.A. Semyannikov, B.G. Semenov, and K.A. Chuntunov, *J. Less-Common Met.*, 64, 185-199 (1979).
201. **80Ban:** G. Banik, T. Schmitt, P. Etmayer, and B. Lux, *Z. Metallkd.*, 71 (10), 644-645 (1980) in German.
202. **80Dav:** T.G. Davey and E.H. Baker, *J. Mater. Sci. Lett.*, 15, 1601-1602 (1980).
203. **80Ere:** V.N. Eremenko, I.M. Obushenko, and Yu.I. Buyanov, *Dop. Akad. Nauk Ukr. RSRA*, (7), 87-91(1980).
204. **80Lu:** X.S. Lu, J.K. Liang, and M.G. Zhou, *Acta Phys. Sin. (China)*, 29, 469-484 (1980).
205. **80Pal:** A. Palenzona, *J. Less-Common Met.*, 72(1), P21-P24 (1980).
206. **81Bru:** G. Bruzzone, E. Franceschi, and F. Merlo, *J. Less-Common Met.*, 81, 155-160 (1981).
207. **81Bus:** V.D. Busmanov and S.P. Yatsenko, *Russ. Metall.*, (5), 157-160 (1981).
208. **81Ian:** A. Iandelli and A. Palenzona, *J. Less-Common Met.*, 80, P71-P82 (1981).
209. **81Loe:** O. Loebich, Jr. and C.J. Raub, *Platinum Met. Rev.*, 25(3), 113-120 (1981).
210. **81Mor:** G. Morgaut, B. Legendre, S. Mareglier-Lacordaire, and C. Souleau, *Ann. Chim. Fr.*, 6, 315-326 (1981).
211. **81Wat:** R.M. Waterstrat, *J. Less-Common Met.*, 80, P31-P36 (1981).
212. **82Bor:** G. Borzone, A. Borsese, and R. Ferro, *J. Less-Common Met.*, 85, 195-203 (1982).
213. **82Pri:** N.Yu. Pribyl'skii, I.G. Vasileva, and R.S. Gamidov, *Mater. Res. Bull.*, 17, 1147-1153 (1982).
214. **82Sub:** P.R. Subramanian and J.F. Smith, *J. Less-Common Met.*, 87, 205-213 (1982).
215. **83Ere:** V.N. Eremenko, K.A. Meleshevich, and Yu.I. Buyanov, *Dop. Akad. Nauk Ukr. RSRA*, (3), 83-88 (1983).
216. **83Kub:** O. Kubaschewski-Von Goldbeck, *Titimum: Physicochemical Properties of Its Compounds and Alloys*, Atomic Energy Review; Spec. Issue No. 9, O. Kubaschewski, Ed., IAEA, Vienna, 156 (1983).

217. **84Pas**: J.D.A. Paschoal, H. Kleykamp, and F. Thummler, *J. Less-Common Met.*, 98, 279-284 (1984).
218. **85Mur**: J.L. Murray, *Int. Met. Rev.*, 30(5), 211-233, 1985.
219. **86Bar1**: O.M. Barabash and Yu.N. Koval, *Crystal Structure of Metals and Alloys*, Naukova Dumka, Kiev, 211-212 (1986).
220. **86Bar2**: O.M. Barabash and Yu. N. Koval, *Crystal Structure of Metals and Alloys*, Naukova Dumka, Kiev, 247-248 (1986).
221. **86Bar3**: O.M. Barabash and Yu.N. Koval, *Crystal Structure of Metals and Alloys*, Naukova Dumka, Kiev, 296-297 (1986) in Russian.
222. **87Gor**: O.V. Gordiichuk, Author's Abstract of Candidate's Thesis, Chemical Sciences, Kiev (1987).
223. **87Mel**: L.Z. Melenkov, S.P. Yatsenko, K.A. Chuntunov, and Yu.N. Grin, *Izv. Akad. Nauk SSSR, Met.*, (2), 201-203 (1987) in Russian; TR: *Russ. Metall.*, (2), 208-211 (1987).
224. **88Sac**: A. Saccone, S. Delfino, and R. Ferro, *J. Less-Common Met.*, 143, 1-23 (1988).
225. **90Con**: J.B. Condon, T. Schober, and R. Lasser, *J. Nud. Mater.*, 170, 24-30(1990).
226. **90Sac**: A. Saccone, S. Delfino, and R. Ferro, *Calphad*, 14(2), 161 (1990).

References

Binary General References

1. *The following list of references has provided the foundation of much of the phase diagram data that is currently cited in the literature. To conserve space these references will be cited by their general reference symbol in the index.*
2. [**Brandes**]: E.A. Brandes and R.F. Flint, Ed., *Manganese Phase Diagrams*, The Manganese Centre, 17 Avenue Hoche, 75008 Paris, France (1980).
3. [**Chiotti**]: P. Chiotti, V.V. Akhachinskij, and I. Ansara, *The Chemical Thermodynamics of Actinide Elements and Compounds*, Part 5: The Actinide Binary Alloys, V. Medvedev, M.H. Rand, E.F. Westrum, Jr., and F.L. Oetting, Ed., International Atomic Energy Agency, Vienna (1981).
4. [**Elliott**]: R.P. Elliott, *Constitution of Binary Alloys, First Supplement*, McGraw-Hill, New York or General Electric Co., Business Growth Services, Schenectady, New York (1965).
5. [**Hafnium**]: P.J. Spencer, O. von Goldbeck, R. Ferro, R. Marazza, K. Girgis, and O. Kubaschewski, *Hafnium: Physico-Chemical Properties of Its Compounds and Alloys*, K.L. Komerek, Ed., Atomic Energy Review Special Issue No.8, International Atomic Energy Agency, Vienna (1981).
6. [**Hansen**]: M. Hansen and K. Anderko, *Constitution of Binary Alloys*, McGraw-Hill, New York or General Electric Co., Business Growth Services, Schenectady, New York (1958).
7. [**Hultgren, B**]: R. Hultgren, P.D. Desai, D.T. Hawkins, M. Gleiser, and K.K. Kelley, *Selected Values of the Thermodynamic Properties of Binary Alloys*, American Society for Metals, Metals Park, Ohio (1973).
8. [**Ivanov**]: O.S. Ivanov, T.A. Badaeva, R.M. Sofronova, V.B. Kishenevskii, and N.P. Kushnir, *Phase Diagrams of Uranium Alloys*, Nauka, Moscow (1972).
9. [**Kubaschewski**]: O. Kubaschewski, *Iron--Binary Phase Diagrams*, Springer-Verlag, New York (1982).
10. [**Metals**]: *Metals Handbook*, Metallography, Structures and Phase Diagrams, Vol.8, 8th ed., American Society for Metals, Metals Park, OH (1973).
11. [**Moffatt**]: W.G. Moffatt, Ed., *Handbook of Binary Phase Diagrams*, Business Growth Services, General Electric Co., Schenectady, NY (1976).
12. [**Molybdenum**]: L. Brewer, *Molybdenum: Physico-Chemical Properties of Its Compounds and Alloys*, O. Kubaschewski, Ed., Atomic Energy Review Special Issue No.7, International Atomic Energy Agency, Vienna (1980).
13. [**Pearson2**]: W.B. Pearson, *Handbook of Lattice Spacings and Structures of Metals and Alloys*, Vol. 2, Pergamon Press, New York (1967)
14. [**Pearson3**]: P. Villars and L.D. Calvert, *Pearson's Handbook of Crystallographic Data for Intermetallic Phases*, Vol.1, 2, and 3, American Society for Metals, Metals Park, OH (1985).

15. **[Pearson4]**: P. Villars and L.D. Calvert, *Pearson's Handbook of Crystallographic Data for Intermetallic Phases*, 2nd ed., Vol. 1,2,3, and 4, ASM International, Materials Park, OH (1991).
16. **[Plutonium]**: M.H. Rand, D.T. Livey, P. Feschotte, H. Nowotny, K. Seifert, and R. Ferro, *Plutonium: Physico-Chemical Properties of Its Compounds and Alloys*, O. Kubaschewski, Ed., Atomic Energy Review Special Issues No. 1, International Atomic Energy Agency, Vienna (1966).
17. **[Shunk]**: F.A. Shunk, *Constitution of Binary Alloys, Second Supplement*, McGraw-Hill, New York or General Electric Co., Business Growth Services, Schenectady, New York (1969).
18. **[Smith]**: J.F. Smith, O.N. Carlson, D.T. Peterson, and T.E. Scott, *Thorium: Preparation and Properties*, Iowa State University Press, Ames, IA (1975).
19. **[Smithells]**: C.J. Smithells and E.A. Brandes, *Metals Reference Book*, 5th ed., Butterworths, Wobum, MA (1976).
20. **[Thorium]**: M.H. Rand, O. von Goldbeck, R. Ferro, K. Girgis, and A.L. Dragoo, *Thorium: Physico-Chemical Properties of Its Compounds and Alloys*, O. Kubaschewski, Ed., Atomic Energy Review Special Issue No.5, International Atomic Energy Agency, Vienna (1975).
21. **[Zirconium]**: C.B. Alcock, K.T. Jacob, S. Zador, O. von Goldbeck, H. Nowotny, K. Seifert, and O. Kubaschewski, *Zirconium: Physico-Chemical Properties of Its Compounds and Alloys*, O. Kubaschewski, Ed., Atomic Energy Review Special Issue No.6, International Atomic Energy Agency, Vienna (1976).

References Cited in Binary Alloys Index

22. The references listed below represent the best available sources for the diagrams and data developed from them. They do not, however, represent *evaluations* conducted under the International Alloy Phase Diagram Programme.
23. **1898Gra**: A. Granger, *Ann. Chim. Phys.*, 14, 5-90 (1898).
24. **05Bol**: W. v.Bolton, *Z. Elektrochem.*, 11, 51 (1905).
25. **05Emi**: F. Emich, *Monatsh. Chem.*, 26, 1013 (1905).
26. **06Mat**: C.H. Mathewson, *Z. Anorg. Allg. Chem.*, 50, 192-195 (1906).
27. **07Veg**: A.V. Vegesack, *Z. Anorg. Allg. Chem.*, 52, 30-34 (1907).
28. **08Fis**: F. Fisher and G. Iliovich, *Ber. Dtsch. Chem Ges.*, 41, 3802, 4449 (1908); 42, 527 (1909); quoted in [Elliott].
29. **08Fri**: K. Friedrich, *Metallurgie*, 5, 212-215 (1908).
30. **08Vos**: G. Voss, *Z. Anorg. Allg. Chem.*, 57, 49-52 (1908).
31. **10Sie**: A. Sieverts and W. Krumbhaar, *Ber. Dtsch. Chem. Ges.*, 43, 894 (1910) in German.
32. **20Viv**: A.C. Vivian, *J. Inst. Met.* 23, 325-366 (1920).
33. **22Bru**: A. Brukel, *Z. Anorg. Allg. Chem.*, 125, 255-256 (1922).
34. **27Tak**: T. Takei, *Sci. Rep. Tohoku Univ.*, 16, 1031-1056 (1927).
35. **30Mul**: L. Muller, *Ann. Phys.*, 7, 9-47 (1930) in German.
36. **34Gru**: G. Grube and G. Schaufler, *Z. Elektrochem.*, 40, 593-600 (1934).
37. **36Gru**: G. Grube and A. Schmidt, *Z. Elektrochem.*, 42, 201-209 (1936).
38. **38Gru**: G. Grube and A. Dietrich, *Z. Elektrochem.*, 44, 755-758 (1938).
39. **40And**: K.W. Andrews, H.E. Davies, W. Hume-Rothery, and C.R. Oswin, *Proc. Roy. Soc. (London)*, A177, 149-167 (1940-1941).
40. **41Rol**: L. Rolla and A. Iandelli, *Ric. Sci.*, 20, 1216-1226 (1941).
41. **42Gru**: G. Grube and L. Botzenhardt, *Z. Elektrochem.*, 48, 418-425 (1942).
42. **42Mon**: E. Montignie, *Bull. Soc. Chim. Fr.*, 9, 658-661 (1942).
43. **50Ber**: J. Berak and T. Heumann, *Z. Metallkd.*, 41, 19-23 (1950).
44. **52Ian**: A. Iandelli and R. Ferro, *Ann. Chim. (Rome)*, 42, 598-606 (1952).
45. **52Now**: H. Nowotny, E. Bauer, A. Stampfl, and H. Bittmer, *Monatsh. Chem.*, 83, 221-236 (1952).
46. **52Kos**: W. Koster and E. Horn, *Z. Metallkd.*, 43, 444-449 (1952).

47. **52Sei:** W. Seith, H. Johnson, and J. Wagner, *Z. Metallkd.*, *46*, 773-779 (1952).
48. **53Gea:** G.A. Geach and R.A. Jettery, *J. Met.*, *5*, 1084 (1953).
49. **54Vog:** R. Vogel and H. Klose, *Z. Metallkd.*, *45*, 633-638 (1954).
50. **55Kon:** S.T. Konobeevsky, Conf. Acad. Sci. USSR. Peaceful Uses Atomic Energy, Div. Chem. Sci., *1* (1955).
51. **55Rau:** E. Raub and W. Mahler, *Z. Metallkd.*, *46*, 282-290 (1955).
52. **56Car:** O.N. Carlson, J.M. Dickenson, H.E. Lunt, and H.A. Wilhelm, *Trans. AIME*, *206*, 132-136 (1956).
53. **56Cat:** J.A. Catterall, J.D. Grogan, and R.J. Pleasance, *J. Inst. Met.*, *85*, 63-67 (1956).
54. **56Mul:** R.N.P. Mulford and G.E. Sturdy, *J. Am. Chem. Soc.*, *78*, 3897-3901 (1956).
55. **56Pel:** E. Pelzel, *Metall*, *10*, 717-718 (1956).
56. **56Rau:** E. Raub and W. Plate, *Z. Metallkd.*, *47*, 688-693 (1956) in German.
57. **56Swa:** H.E. Swanson, N.T. Gilfrich, and G.M. Ugrinic, NBS Circ. 539 (1956).
58. **56Tru:** F.A. Trumbore, C.D. Thurmond, and M. Kowalchik, *J. Chem. Phys.*, *24*, 1112 (1956).
59. **58Boc:** A.A. Bochvar *et al.*, Proc. U.N. Int Conf. Peaceful Uses At. Energy, 2nd, Geneva, Vol. 6, 184-193 (1958); quoted from [Shunk].
60. **58Com:** V.B. Compton, *Acta Crystallogr*, *11*, 446 (1958).
61. **58Dom:** R.F. Domagala, R.P. Elliott, and W. Rostoker, *Trans. AIME*, *212*, 393-395 (1958)
62. **58Gib:** E.D. Gibson, B.A. Loomis, and O.N. Carlson, *Trans. ASM*, *50*, 348-369 (1958).
63. **58Mul:** R.N.R. Mulford, USAEC, AECU-3813 (1958).
64. **59Boz:** R.M. Bozworth, B.T. Matthias, H. Suhl, E. Corenzwit, and D.D. Davis, *Phys. Rev.*, *115*, 1595-1596 (1959).
65. **59Com:** V.B. Compton and B.T. Matthias, *Acta Crystallogr.*, *12*, 651-654 (1959).
66. **59Ell:** R.P. Elliott, *Trans. ASM*, *52*, 990-1014 (1959).
67. **59Hel:** A. Hellawell, *J. Less-Common Met.*, *1*, 343-347 (1959).
68. **59Sch:** F.W. Schonfeld, E.M. Cramer, W.N. Miner, F.H. Elinger, and A.S. Coffinberry, *Progress in Nuclear Energy*, Ser. V, Vol. 2, Pergamon Press, New York, 579-599, (1959).
69. **60Bec:** R.L. Beck, USAEC, LAR-10, 93 p (1960).
70. **60Bro:** J.H. Brophy, P. Schwarzkopt, and J. Wulff, *Trans. AIME*, *218*, 910-914 (1960).
71. **60Cro:** J. Croni, C.E. Armantrout, and H. Kato, U.S. Bur. Mines, Rep. Invest. 5688, 12 p (1960).
72. **60Eas:** D.T. Eash and O.N. Carlson, *Trans. ASM*, *52*, 1097-1114 (1960).
73. **60Gra:** N.J. Grant and B.C. Giessen, WADD Tech. Rept., 60-132, 90-112 (1960); *J. Met.*, *13*, 87 (1961); as quoted in [Elliott].
74. **60Kau:** A.R. Kaufmann, E.J. Rapperport, and M.F. Smith, WADD Tech. Rep. 60-132, 33-39 (1960).
75. **60Lya:** V.S. Lyashenko and V. Bykov, *At. Energy (USSR)*, *8*, 146-148 (1960) in Russian; TR: *Sov. J. At. Energy*, *8*, 132-134 (1960).
76. **60Pet1:** D.T. Peterson and M. Indig, *J. Am. Chem. Soc.*, *80*, 5645-5646 (1960).
77. **60Pet2:** D.T. Peterson and D.J. Beerntsen, *Trans. ASM*, *52*, 763-777 (1960).
78. **60Pre:** B. Predel, *Z. Phys. Chem.*, *24*, 206-216 (1960).
79. **60Sav:** E.M. Savitskii and C.V. Kopetskii, *Zh. Neorg. Khim.*, *5*, 2638-2640 (1960) in Russian; TR: *Russ J. Inorg. Chem.*, *5*, 1274-1275 (1960).
80. **60Wit:** W.G. Witteman, A.L. Giorgi, and D.T. Vier, *J. Phys. Chem.*, *64*, 434-440 (1960).
81. **61Chi:** P. Chiotti and K.J. Gill, *Trans. AIME*, *221*, 573-580 (1961).
82. **61Dor1:** F.W. Dorn, W. Klemm, and S. Lohmeyer, *Z. Anorg. Allg. Chem.*, *209*, 204-209 (1961).
83. **61Dor2:** F.W. Dorn and W. Klemm, *Z. Anorg. Allg. Chem.*, *309*, 189-203 (1961).
84. **61Dwi:** A.E. Dwight, J.W. Downey, and R.A. Conner, Jr., *Acta Crystallogr*, *14*, 75-76 (1961).
85. **61Joh:** R.H. Johnson and R.W.K. Honeycombe, *J. Nucl. Mater*, *4*, 66-69 (1961).

86. **61Lun:** C.E. Lundin, in *The Rare Earths*, F.H. Spedding and A.H. Daane, Ed., John Wiley & Sons, New York, 263-264 (1961).
87. **61Lov:** B. Love, WADD Tech. Rep., 61-123, 179p (1961); quoted in [Elliott].
88. **61Poo:** D.M. Poole, M.G. Bale, P.G. Mardon, J.A.C. Marples, and J.L. Nichols, *Plutonium 1960*, Cleaver-Humes Press, London, 267-280 (1961).
89. **61Sav:** E.M. Savitskii, M.A. Tylkina, R.V. Kirilenko, and C.V. Kopetskii, *Zh. Neorg. Khim.*, 6, 1474-1476 (1961) in Russian; TR: *Russ. J. Inorg. Chem.*, 6, 755-756 (1961).
90. **62Lun:** C.E. Lundin and D.T. Klodt, *Trans. AIME*, 224, 367-372 (1962).
91. **62Rap:** E.J. Rapperport and M.F. Smith, Tech. Rep., WADD-TR-60-132, Pt. II, 8-27 (1962).
92. **62Rud:** E. Rudy, B. Kietter, and H. Froelich, *Z. Metallkd.*, 53, 90-92 (1962).
93. **62Tyl1:** M.A. Tylkina, V.P. Polyakova, and E.M. Savitskii, *Zh. Neorg. Khim.*, 7, 1469-1470 (1962) in Russian; TR: *Russ. J. Inorg. Chem.*, 7, 755-756 (1962).
94. **62Tyl2:** M.A. Tylkina, V.P. Polyakova, and E.M. Savitskii, *Zh. Neorg. Khim.*, 7, 1467-1468 (1962) in Russian; TR: *Russ. J. Inorg. Chem.*, 7, 755-756 (1962).
95. **62Tyl3:** M.A. Tylkina, V.P. Polyakova, and E.M. Savitskii, *Zh. Neorg. Khim.*, 7, 1919-1927 (1962) in Russian; TR: *Russ. J. Inorg. Chem.*, 7, 990-996 (1962).
96. **63Joh:** I. Johnson and M.G. Chasanov, *Trans. ASM*, 56, 272-277 (1963).
97. **63Ker:** C.J. Kershner and R.H. Steinmeyer, USAEC, MLM-1163, F1-F6 (1963).
98. **63Liu:** C.H. Liu, A.S. Pashinkin, and A.V. Novoselova, *Dokl. Akad. Nauk SSSR*, 151, 1335-1338 (1963) in Russian; TR: *Dokl. Chem.*, 151, 662-664 (1963).
99. **63Obr:** W. Obrowski, *Metall*, 17, 108-112 (1963).
100. **63Pel:** G.P. Pells, *J. Inst. Met.*, 92, 416-418 (1963-1964).
101. **63Sch:** S.J. Schneider, NBS Monograph 68, 31 pp (1963).
102. **63Tay:** A. Taylor, B.J. Kagle, and N.J. Doyle, *J. Less-Common Met.*, 5, 26-40 (1963).
103. **63Tho:** J.R. Thompson, *J. Less-Common Met.*, 5, 437-442 (1963).
104. **63Tyl:** M.A. Tylkina, V.P. Polyakova, and O.Kh. Khamidov, *Zh. Neorg. Khim.*, 8, 776-778 (1963) in Russian; TR: *Russ. J. Inorg. Chem.*, 8, 395-397 (1963).
105. **63Wil:** G.P. Williams and L. Slifkin, *Acta Metall.*, 11, 319-322 (1963).
106. **64Cha:** M.G. Chasanov, I. Johnson, and R.V. Schablaske, *J. Less-Common Met.*, 7, 127-132 (1964).
107. **64Dar:** J.B. Darby, Jr., L.J. Norton, and J.W. Downey, *J. Less-Common Met.*, 6, 165-167 (1964).
108. **64EII:** R.P. Elliott, in *Rare Earth Research III*, Proc. 4th Conf. Rare Earth Res., L. Eyring, Ed., Gordon and Breach, New York, 215-245 (1964).
109. **64Gie:** B.C. Giessen, H. Ibach, and N.J. Grant, *Trans. AIME*, 230, 113-122 (1964).
110. **64Hew:** I.F. Hewaidy, E. Busmann, and W. Klemm, *Z. Anorg. Allg. Chem.*, 328, 283-293 (1964).
111. **64Obi1:** I. Obinata, Y. Takeuchi, K. Kurihara, and M. Watanabe, *Nippon Kinzoku Gakkaishi*, 28, 562-568 (1964).
112. **64Obi2:** I. Obinata, Y. Takeuchi, K. Kurihara, and M. Watanabe, *Nippon Kinzoku Gakkaishi*, 28, 568-576 (1964).
113. **64Pec:** W.H. Pechin, D.E. Williams, and W.L. Larsen, *Trans. ASM*, 57, 464-473 (1964).
114. **64Pet:** D.T. Peterson and R.P. Colburn, USAEC Comm. IS-613, 13 p (1964); quoted from [Shunk].
115. **64Rhy:** D.W. Rhys and E.G. Price, *Met. Ind.*, 105, 243-247 (1964).
116. **64Rit:** D.L. Ritter, B.C. Giessen, and N.J. Grant, *Trans. AIME.*, 230, 1250-1267 (1964).
117. **64Wit:** L.J. Wittenburg and G.R. Grove, USAEC, MLM-1208, 8-11 (1964); USAEC, MLM-1244, p 56 (1964); quoted in [Shunk].
118. **65Dar:** J.B. Darby, Jr., A.F. Berndt, and J.W. Downey, *J. Less-Common Met.*, 9, 466-468 (1965).
119. **65EII:** R.P. Elliott, in *Rare Earth Research III*, L. Eyring, Ed., Gordon and Breach, Science Publishers, New York, 215-245 (1965).

120. **65Haa:** D.J. Haase, H. Steinfink, and E.J. Wpss, in *Rare Earth Research 111*, Gordon and Breach, Science Publishers, New York, 535-544 (1965).
121. **65Swi:** J.H. Swisher, NASA Tech. Note, NASA-TN-D-2734, 18 p (1965); quoted in [Shunk].
122. **66Bru:** G. Bruzzone, *Ann. Chim. (Rome)*, 56, 1306-1319 (1966).
123. **66Den1:** D.H. Dennison, M.J. Tschetter, and K.A. Gschneidner, Jr., *J. Less-Common Met.*, 10 (2), 108-115 (1966).
124. **66Den2:** D.H. Dennison, M.J. Tschetter, and K.A. Gschneidner, Jr., *J. Less-Common Met.*, 11, 423-435 (1966).
125. **66Ell:** F.H. Ellinger, K.A. Johnson, and V.O. Struebing, *J. Nucl. Mat.*, 20, 83-86 (1966).
126. **66Sav:** E.M. Savitskiy, M.A. Tylkina, and O.Kh. Khamidov, *Russ. Metall.*, 4, 52-56 (1966).
127. **66Vui:** G. Vuillard and J.P. Piton, *Compt. Rend. C*, 263, 1018-1021 (1966).
128. **67Bad1:** T.A. Badayeva and R.I. Juznetsova, *Russ. Metall.*, (1), 89-92 (1967).
129. **67Bad2:** T.A. Badayeva and R.I. Juznetsova, *Russ. Metall.*, 6, 99-100 (1967).
130. **67Bow:** D.F. Bowersox and J.A. Leary, *J. Nucl. Mater.*, 21, 219-224 (1967).
131. **67Car:** O.N. Carlson, F.A. Schmidt, and D.E. Diesburg, *Trans. ASM*, 60(2), 119-124 (1967).
132. **67Jan:** G. Jangg, H.R. Kirchmayr, and W. Lugscheider, *Z. Metallkd.*, 58, 724-726 (1967) in German.
133. **67Kir1:** H.R. Kirchmayr and W. Lugscheider, *Z. Metallkd.*, 58(3), 185-188 (1967).
134. **67Kir2:** H.R. Kirchmayr and W. Lugscheider, *Z. Metallkd.*, 58, 185-193 (1967) in German.
135. **67Kut1:** V.I. Kutaitsev, N.T. Chebortarev, I.G. Lebedev, M.A. Andrianov, V.N. Konev, and T.S. Menshikova, *Plutonium 1965*, Chapman & Hall, London, 420-449 (1967).
136. **67Kut2:** V.I. Kutaitsev, N.T. Chebortarev, I.G. Lebedev, M.A. Andrianov, V.N. Konev, and T.S. Menshikova, *Plutonium 1965*, Chapman & Hall, London, 420-447 (1967).
137. **67Mcm:** O.D. McMasters and K.A. Gschneidner, Jr., *J. Less-Common Met.*, 13, 193-199 (1967).
138. **67Par:** J.K. Pargeter and W. Hume-Rothery, *J. Less-Common Met.*, 12, 366-374 (1967).
139. **67Rus:** P.G. Rustamov, B.N. Mardakhaev, and M.G. Safarov, *Inorg. Mater.*, 3(3), 429-433 (1967).
140. **67Sto:** E.K. Storms, *The Refractory Carbides*, Academic Press, New York (1967).
141. **68Gul1:** B.B. Gulyaev and G.F. Dvorshkaya, in *Phase Diagrams of Metallic Systems*, E.M. Savitskii, Ed., Akad. Nauk SSSR, 267-273 (1968) in Russian.
142. **68Gul2:** B.B. Gulyaev, in *Phase Diagrams of Metallic Systems*, E.M. Savitskii, Ed., Nauka, Moscow, 257-267 (1986) in Russian.
143. **68Mas:** J.T. Mason and P. Chiotti, *Trans. AIME*, 242, 1167-1171 (1968).
144. **68Mcm:** O.D. McMasters, T.J. O'Keefe, and K.A. Gschneidner, Jr., *Trans. Metall. Soc. AIME*, 242(5), 936-939 (1968).
145. **68Sav:** E.M. Savitskii and O.Kh. Khamidov, *Russ. Metall.*, (6), 108-111 (1968).
146. **69Bad:** T.A. Badayera and R.I. Kuznetsova, *Izv. Akad. Nauk SSSR, Met.*, (15), 156-193 (1969) in Russian; TR: *Russ. Metall.*, (5), 101-106 (1969).
147. **69Ben1:** R. Benz and P. L. Stone, *High Temp. Sci.*, 1, 114-127 (1969).
148. **69Ben2:** R. Benz, C.G. Hoffman, and G.N. Rupert, *High. Temp. Sci.*, 1, 342-359 (1969).
149. **69Bor:** V.A. Boryaleova, Ya Kh. Grinberg, E.G. Shukov, V.A. Koryazhkin, and Z.S. Medvedeva, *Inorg. Mater. J.*, 397-399 (1969).
150. **69Mcm:** O.D. McMasters and K.A. Gschneidner, Jr., *J. Less-Common Met.*, 19, 337-344 (1969).
151. **70Kir:** H.R. Kirchmayr and W. Lugscheider, *Z. Metallkd*, 61, 22-23 (1970).
152. **70Mas:** J.T. Mason and P. Chiotti, *Metall. Trans.*, 1, 2119-2123 (1970).
153. **70Sad:** O.A. Sadovskaya and E.I. Yarembash, *Russ. Inorg. Mater.*, 6(7), 1097-1101 (1970).
154. **70Sch:** F.A. Schmidt and O.D. McMasters, *J. Less-Common Met.*, 21, 415-425 (1970).
155. **70Thu:** R. Thummel and W. Klemm, *Z. Anorg. Allg. Chem.*, 376, 44-63 (1970) in German.

156. **70Woo:** D.H. Wood, E.M. Cramer, and P.L. Wallace, *Nucl. Metall.*, 17, 707-719 (1970).
157. **70Yar:** E.I. Yarembach, *Colloq. Intern. CNRS (Paris)*, 1, 472-481 (1970).
158. **71Cun:** P.T. Cunningham, S.A. Johnson, and E.J. Cairns, *J. Electrochem. Soc.*, 118, 1941-1944 (1971).
159. **71Gri:** R.B. Griffin and K.A. Gschneidner, Jr., *Metall. Trans.*, 2(9), 2517-2524 (1971).
160. **71Pre:** B. Predel and W. Schwermann, *J. Inst. Met.*, 99, 169-173 (1971).
161. **71Sve:** V.N. Svechnikov, G.F. Kobzenko, and V.G. Ivanchenko, *Metallofizika*, (33), 93-95 (1971).
162. **72Bor:** J.D. Bornand and P. Feschotte, *J Less-Common Met.*, 29, 81-91 (1972) in French.
163. **72Hut:** J.M. Hutchinson, Jr., *Platinum Met. Rev.*, 16, 88-90 (1972).
164. **72Jeh:** H. Jehn and E. Olzi, *J. Less-Common Met.*, 27, 297-309 (1972).
165. **72Mas:** J.T. Mason and P. Chiotti, *Metall. Trans.*, 3, 2851-2855 (1972).
166. **72Por:** K.I. Portnoi and V.M. Romashov, *Sov. Powder Metall. Met. Ceram.*, 11, 378-384 (1972).
167. **72Shu:** A.K. Shurin and V.V. Pet'kov, *Russ. Metall.*, (2), 122-144 (1972).
168. **73Bus:** K.H.J. Buschow, *J. Less-Common Met.*, 31, 165-168 (1973).
169. **73Gha:** H. Ghassem and A. Raman, *Metall. Trans.*, 4, 745-748 (1973).
170. **73Ian:** A. Iandelli and A. Palenzona, *Rev. Chim. Miner.*, 303-308 (1973).
171. **73Loe:** O. Loebich, Jr. and E. Raub, *J. Less-Common Met.*, 30, 47-62 (1973).
172. **73Sav:** E. Savitskii, V. Polyakova, and E. Tsyganova, *Redkozemel. Met., Splavy Soedineniya*, Izd. Nauk, Moscow, 182-184(1973).
173. **73Sve:** V.N. Svechnikov, G.F. Kobzenko, and V.G. Ivanchenko, *Dokl. Akad. Nauk SSSR*, 213, 1062-1064 (1973).
174. **74Gsc1:** K.A. Gschneidner, Jr. and M.E. Verkade, Document IS-RIC-7, Rare Earth Information Center, Iowa State Univ., Ames, IA, 40-41(1974).
175. **74Gsc2:** K.A. Gschneidner, Jr. and M.E. Verkade, IS-RIC-7, Rare Earth Information Center, Iowa State Univ., Ames, IA, 30-31 (1974).
176. **74Lev:** Yu.V. Levinskiy, *Russ. Metall.*, (1), 34-37 (1974).
177. **74Ray1:** A.E. Ray, *Cobalt*, (1), 13-20 (1974).
178. **74Ray2:** A.E. Ray, *Cobalt*, (1), 3-20 (1974).
179. **74Yar:** E.I. Yarembach, E.S. Vigileva, A.A. Eliseev, A.V. Zachatskaya, T.G. Aminov, and M.A. Chernitsyna, *Inorg. Mater.*, 10(8), 1212-1215 (1974).
180. **75Ell:** G.V. Ellert, V.G. Sevast'yanov, and V.K. Slovyanskikh, *Russ. J. Inorg. Chem.*, 20(1), 120-124 (1975).
181. **75Gat:** J. Gatterer, D. Dufek, P. Etmayer, and R. Kieffer, *Monatsh. Chem.*, 106, 1137-1147 (1975).
182. **75Lys:** Yu.B. Lyskova and A.V. Vakhobov, *Inorg. Mater.*, 11, 361-362(1975).
183. **75Sve:** V.N. Svechnikov, G.F. Kobzenko, and V.G. Ivanchenko, *Metallofizika*, (59), 77-83 (1975).
184. **75Vak:** A.V. Vakhobov, Z.U. Niyazova, and B. N. Polev, *Inorg. Mater.*, 11, 306-307 (1975).
185. **76Ian:** A. Iandelli and A. Palenzona, *Rev. Chim. Minerale*, 13, 55-61(1976).
186. **76Mat:** P. Matkovic, M. El-Boragy, and K. Schubert, *J. Less-Common Met.*, 50, 165-176 (1976).
187. **76Vol:** A.E. Vol and I.K. Kagan, *Handbook of Binary Metallic Systems*, Nauka, Moscow (1976) in Russian; TR: NBS/NSF, 760-761 (1985).
188. **77Ere:** V.N. Eremenko, V.G. Batalin, Yu.I. Buyanov, and I.M. Obushenko, *Dop. Akad. Nauk Ukr.RSR*, B, (6) 516-521 (1977) in Russian.
189. **77Gar:** S.P. Garg and R.J. Ackermann, *J. Nucl. Mater.*, 64, 265-274(1977).
190. **77Kur:** T.Kh. Kurbanov, R.A. Dovlyatshina, I.A. Dzhavodova, and F.A. Akhmenov, *Russ J. Inorg. Chem.*, 22, 622-624 (1977).
191. **77Kuz:** A.N. Kuznetsov, K.A. Chuntunov, and S.P. Yatsenko, *Russ. Metall.*, (5), 178-180 (1977).
192. **77Wat:** R.M. Waterstrat and R.C. Manuszewski, *J. Less Common Met.*, 51, 55-67 (1977).

193. **77Yat:** S.P. Yatsenko, *J. Chim. Phys.*, 74, 836-843 (1977).
194. **78Eli:** A.A. Eliseev, G.M. Kuz'micheva, and V.I. Yushrov, *Zh. Neorg. Khim.*, 23,(2), 492-296 (1978) in Russian; TR: *Russ J. Inorg. Chem.*, 23(2), 273-276 (1978).
195. **78Esh:** K.K. Eshnov, M.A. Zukhuritdinov, A.V. Vakhobov, and T.D. Zhurayev, *Russ. Metall.*, (1), 171-173 (1978).
196. **78Lan:** C.C. Land, D.E. Peterson, and R.B. Root, *J. Nucl. Mat.*, 75, 262-273 (1978).
197. **78Yat:** S.P. Yatsenko, B.G. Semenov, and K.A. Chuntunov, *Izv. Akad. Nauk SSSR, Met.*, (5) 222-224 (1978) in Russian; TR: *Russ. Metall.*, (51), 173-174(1978).
198. **79Bla:** R. Blachnik and A. Hoppe, *Z. Anorg. Allg. Chem*, 457, 91-104 (1979) in German.
199. **79Vol:** A.E. Vol and I.K. Kagan, *Handbook of Binary Metallic Systems*, Vol.4, Nauka, Moscow (1979) in Russian; translated by NBS and NSF, 588-605 (1986).
200. **79Yat:** S.P. Yatsenko, A.A. Semyannikov, B.G. Semenov, and K.A. Chuntunov, *J. Less-Common Met.*, 64, 185-199 (1979).
201. **80Ban:** G. Banik, T. Schmitt, P. Ettmayer, and B. Lux, *Z. Metallkd.*, 71 (10), 644-645 (1980) in German.
202. **80Dav:** T.G. Davey and E.H. Baker, *J. Mater. Sci. Lett.*, 15, 1601-1602 (1980).
203. **80Ere:** V.N. Eremenko, I.M. Obushenko, and Yu.I. Buyanov, *Dop. Akad. Nauk Ukr. RSRA*, (7), 87-91(1980).
204. **80Lu:** X.S. Lu, J.K. Liang, and M.G. Zhou, *Acta Phys. Sin. (China)*, 29, 469-484 (1980).
205. **80Pal:** A. Palenzona, *J. Less-Common Met.*, 72(1), P21-P24 (1980).
206. **81Bru:** G. Bruzzone, E. Franceschi, and F. Merlo, *J. Less-Common Met.*, 81, 155-160 (1981).
207. **81Bus:** V.D. Busmanov and S.P. Yatsenko, *Russ. Metall.*, (5), 157-160 (1981).
208. **81Ian:** A. Iandelli and A. Palenzona, *J. Less-Common Met.*, 80, P71-P82 (1981).
209. **81Loe:** O. Loebich, Jr. and C.J. Raub, *Platinum Met. Rev.*, 25(3), 113-120 (1981).
210. **81Mor:** G. Morgaut, B. Legendre, S. Mareglier-Lacordaire, and C. Souleau, *Ann. Chim. Fr.*, 6, 315-326 (1981).
211. **81Wat:** R.M. Waterstrat, *J. Less-Common Met.*, 80, P31-P36 (1981).
212. **82Bor:** G. Borzone, A. Borsese, and R. Ferro, *J. Less-Common Met.*, 85, 195-203 (1982).
213. **82Pri:** N.Yu. Pribyl'skii, I.G. Vasileva, and R.S. Gamidov, *Mater. Res. Bull.*, 17, 1147-1153 (1982).
214. **82Sub:** P.R. Subramanian and J.F. Smith, *J. Less-Common Met.*, 87, 205-213 (1982).
215. **83Ere:** V.N. Eremenko, K.A. Meleshevich, and Yu.I. Buyanov, *Dop. Akad. Nauk Ukr. RSRA*, (3), 83-88 (1983).
216. **83Kub:** O. Kubaschewski-Von Goldbeck, *Titamum: Physicochemical Properties of Its Compounds and Alloys*, Atomic Energy Review; Spec. Issue No. 9, O. Kubaschewski, Ed., IAEA, Vienna, 156 (1983).
217. **84Pas:** J.D.A. Paschoal, H. Kleykamp, and F. Thummler, *J. Less-Common Met.*, 98, 279-284 (1984).
218. **85Mur:** J.L. Murray, *Int. Met. Rev.*, 30(5), 211-233, 1985.
219. **86Bar1:** O.M. Barabash and Yu.N. Koval, *Crystal Structure of Metals and Alloys*, Naukova Dumka, Kiev, 211-212 (1986).
220. **86Bar2:** O.M. Barabash and Yu. N. Koval, *Crystal Structure of Metals and Alloys*, Naukova Dumka, Kiev, 247-248 (1986).
221. **86Bar3:** O.M. Barabash and Yu.N. Koval, *Crystal Structure of Metals and Alloys*, Naukova Dumka, Kiev, 296-297 (1986) in Russian.
222. **87Gor:** O.V. Gordiichuk, Author's Abstract of Candidate's Thesis, Chemical Sciences, Kiev (1987).
223. **87Mel:** L.Z. Melenkov, S.P. Yatsenko, K.A. Chuntunov, and Yu.N. Grin, *Izv. Akad. Nauk SSSR, Met.*, (2), 201-203 (1987) in Russian; TR: *Russ. Metall.*, (2), 208-211 (1987).
224. **88Sac:** A. Saccone, S. Delfino, and R. Ferro, *J. Less-Common Met.*, 143, 1-23 (1988).
225. **90Con:** J.B. Condon, T. Schober, and R. Lasser, *J. Nud. Mater.*, 170, 24-30(1990).
226. **90Sac:** A. Saccone, S. Delfino, and R. Ferro, *Calphad*, 14(2), 161 (1990).

Ag-Al (Silver - Aluminum)

A.J. McAlister, 1987

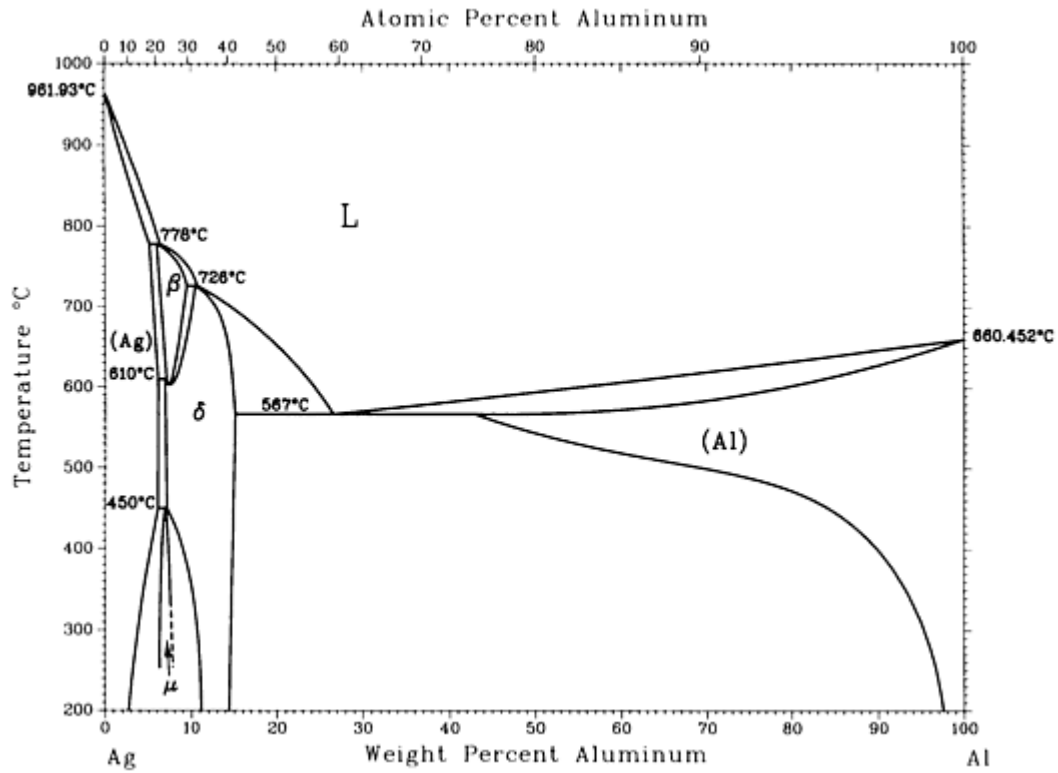

Ag-Al phase diagram

Ag-Al crystallographic data

Phase	Composition, wt% Al	Pearson symbol	Space group
(Ag)	0.0	<i>cF4</i>	<i>Fm</i> $\bar{3}m$
β	6.1 to 7.4	<i>cI2</i>	<i>Im</i> $\bar{3}m$
δ	6.9 to 15.3	<i>hP2</i>	<i>P6</i> ₃ / <i>mmc</i>
μ	~6.2 to 7.3	<i>cP20</i>	<i>P4</i> ₁ <i>32</i> <i>P2</i> ₁ <i>3</i> ^(a)
(Al)	100	<i>cF4</i>	<i>Fm</i> $\bar{3}m$

(a) ~300 °C

Ag-As (Silver - Arsenic)

M.R. Baren, 1990

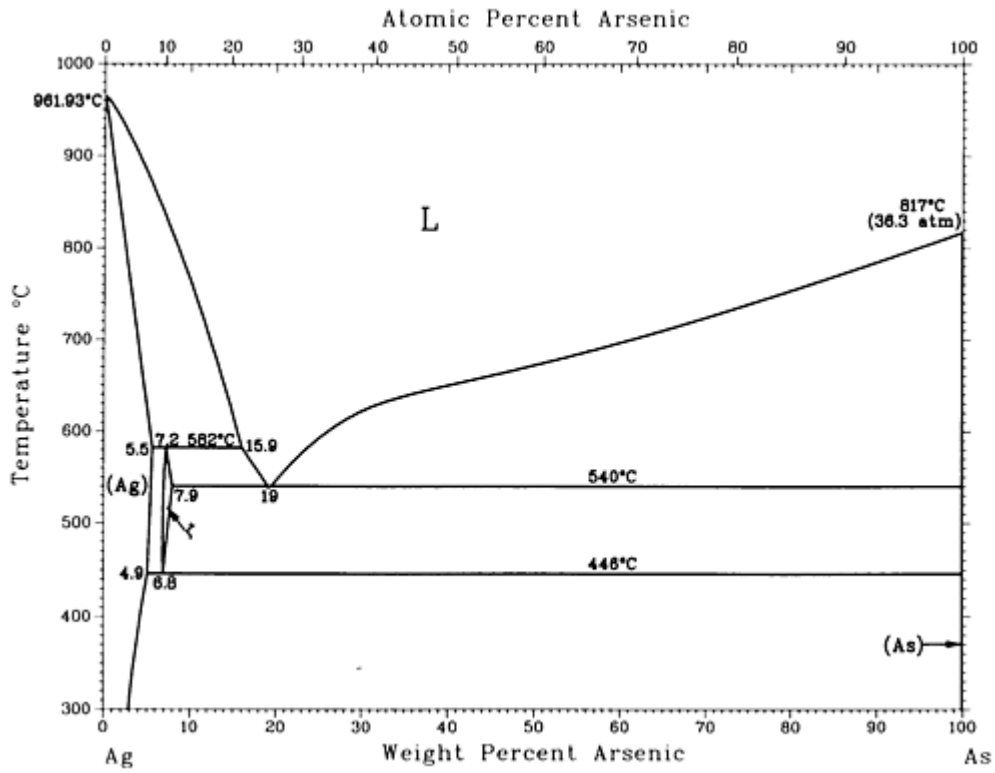

Ag-As phase diagram

Ag-As crystallographic data

Phase	Composition, wt% As	Pearson symbol	Space group
(Ag)	0 to 5.5	$cF4$	$Fm\bar{3}m$
ζ	6.8 to 7.9	$hP2$	$P6_3/mmc$
(As)	100	$hR2$	$R\bar{3}m$

Ag-Au (Silver - Gold)

H. Okamoto and TB. Massalski, 1987

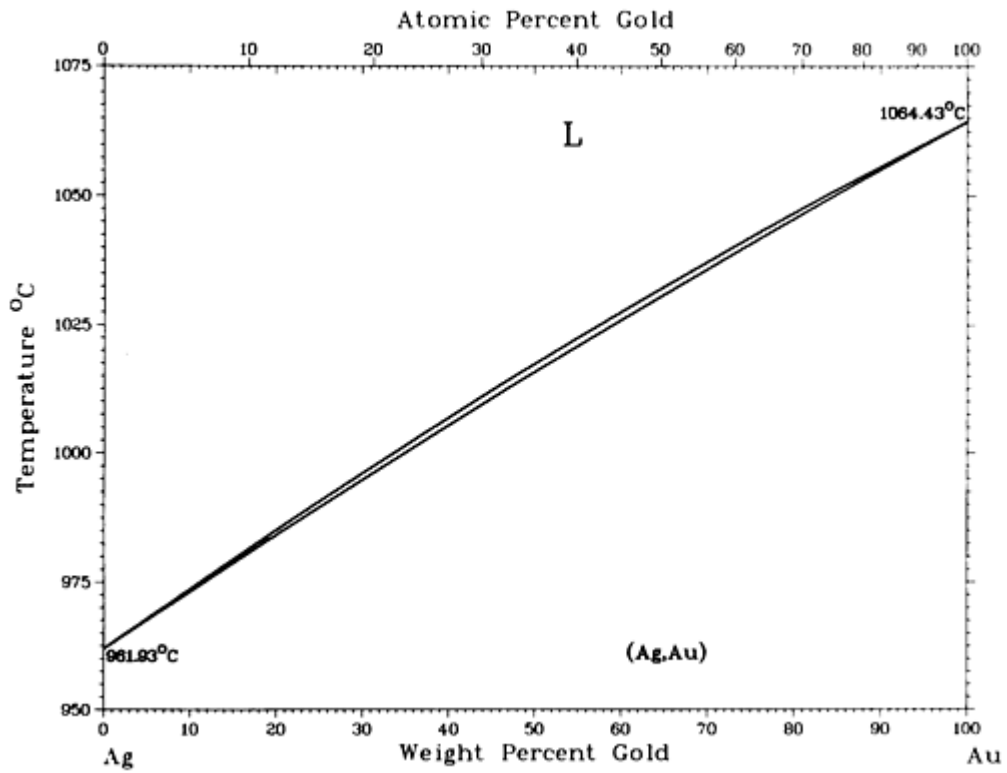

Ag-Au phase diagram

Ag-Au crystallographic data

Phase	Composition, wt% Au	Pearson symbol	Space group
(Ag,Au)	0 to 100	$cF4$	$Fm\bar{3}m$

Ag-Be (Silver - Beryllium)

H. Okamoto and L.E. Tanner, 1987

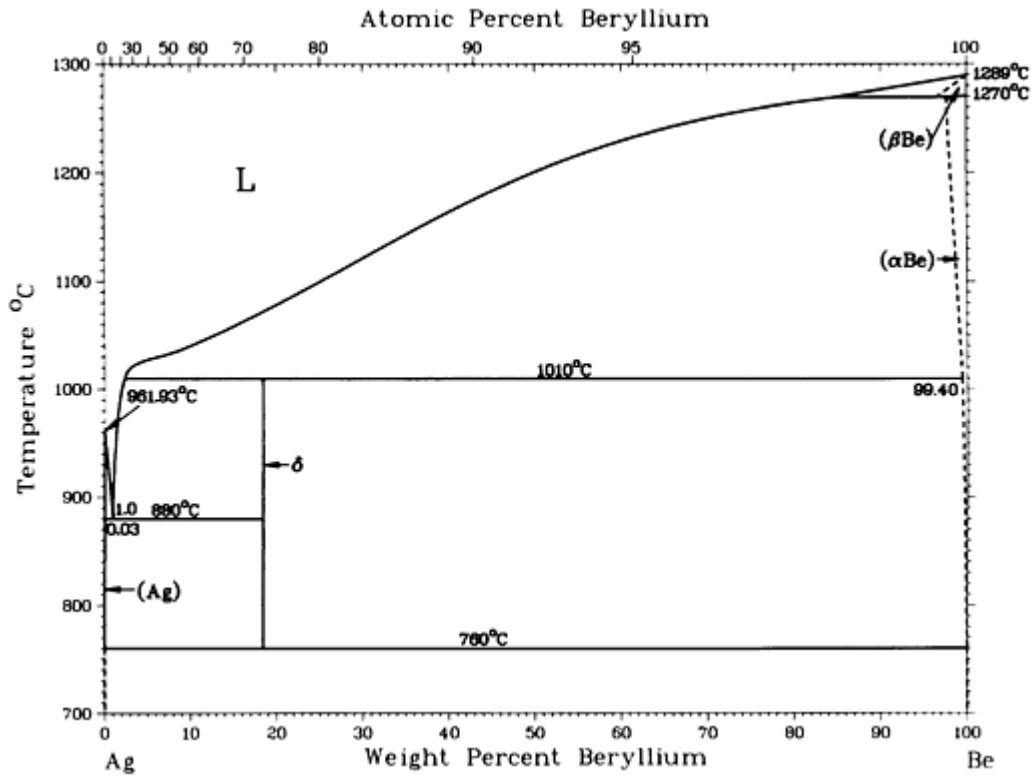

Ag-Be phase diagram

Ag-Be crystallographic data

Phase	Composition, wt% Be	Pearson symbol	Space group
(Ag)	0 to 0.03	<i>cF4</i>	<i>Fm</i> $\bar{3}m$
δ or AgBe ₂	~18?	<i>cF24</i>	<i>Fd</i> $\bar{3}m$
(αBe)	99.40 to 100	<i>hP2</i>	<i>P6₃/mmc</i>
(βBe)	100	<i>cI2</i>	<i>Im</i> $\bar{3}m$
Questionable phases (stable? metastable?)			
γ	~12	?	?
AgBe ₁₂	50	<i>tI26</i>	<i>I4/mmm</i>

Ag-Bi (Silver - Bismuth)

R.P. Elliott and F.A. Shunk, 1980

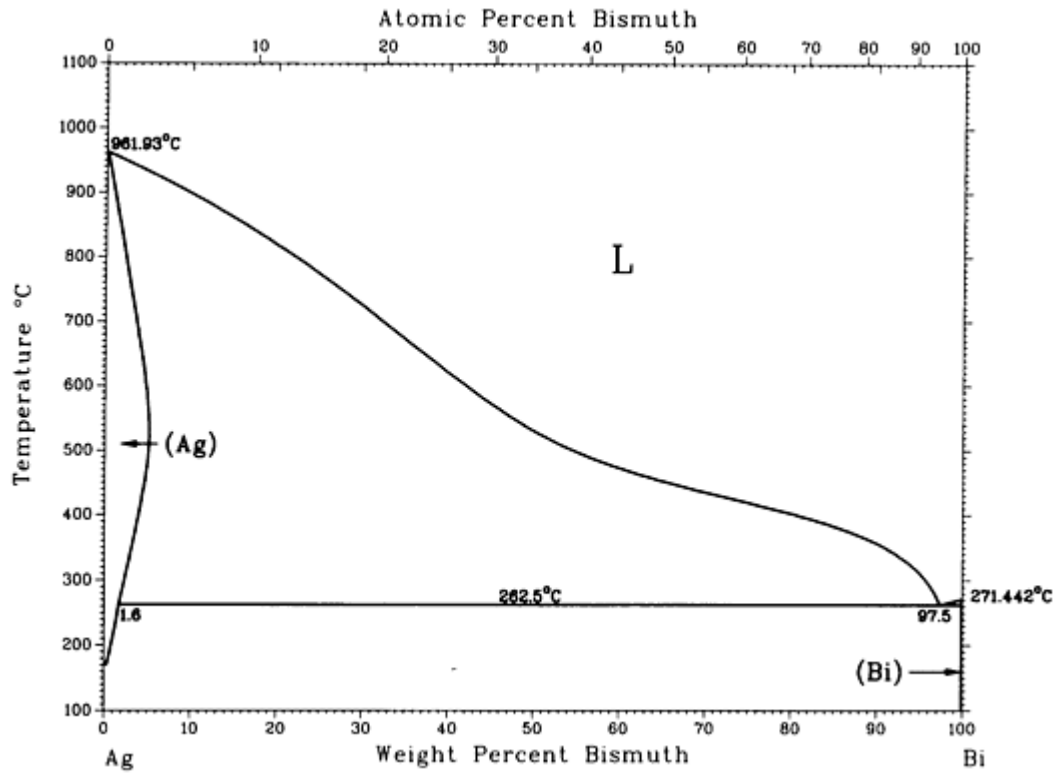

Ag-Bi phase diagram

Ag-Bi crystallographic data

Phase	Composition, wt% Bi	Pearson symbol	Space group
(Ag)	0 to 4.945	$cF4$	$Fm\bar{3}m$
(Bi)	~100	$hR2$	$R\bar{3}m$

Ag-Ca (Silver - Calcium)

M.R. Baren, 1988

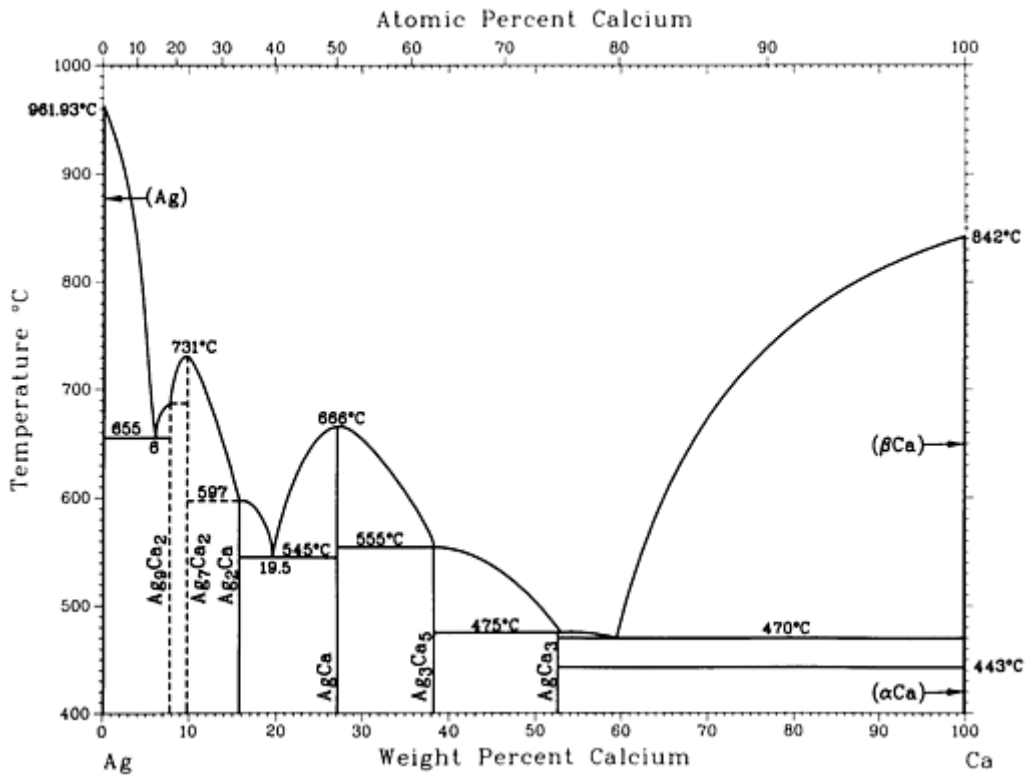

Ag-Ca phase diagram

Ag-Ca crystallographic data

Phase	Composition, wt% Bi	Pearson symbol	Space group
(Ag)	0	<i>cF4</i>	<i>Fm</i> $\bar{3}m$
Ag ₉ Ca ₂	7.7
Ag ₇ Ca ₂	9.6	<i>hP18</i>	<i>P6</i> ₃ <i>22</i>
Ag ₂ Ca	15.6	<i>oI12</i>	<i>Imma</i>
AgCa	27.1	<i>oC8</i>	<i>Cmcm</i>
Ag ₃ Ca ₅	38.2	<i>tI32</i>	<i>I4/mcm</i>
AgCa ₃	52.7

(α Ca)	100	$cF4$	$Fm\bar{3}m$
(β Ca) ^(a)	100	$cI2$	$Im\bar{3}m$

(a) Above 443 °C

Ag-Cd (Silver - Cadmium)

From [Hansen] 6

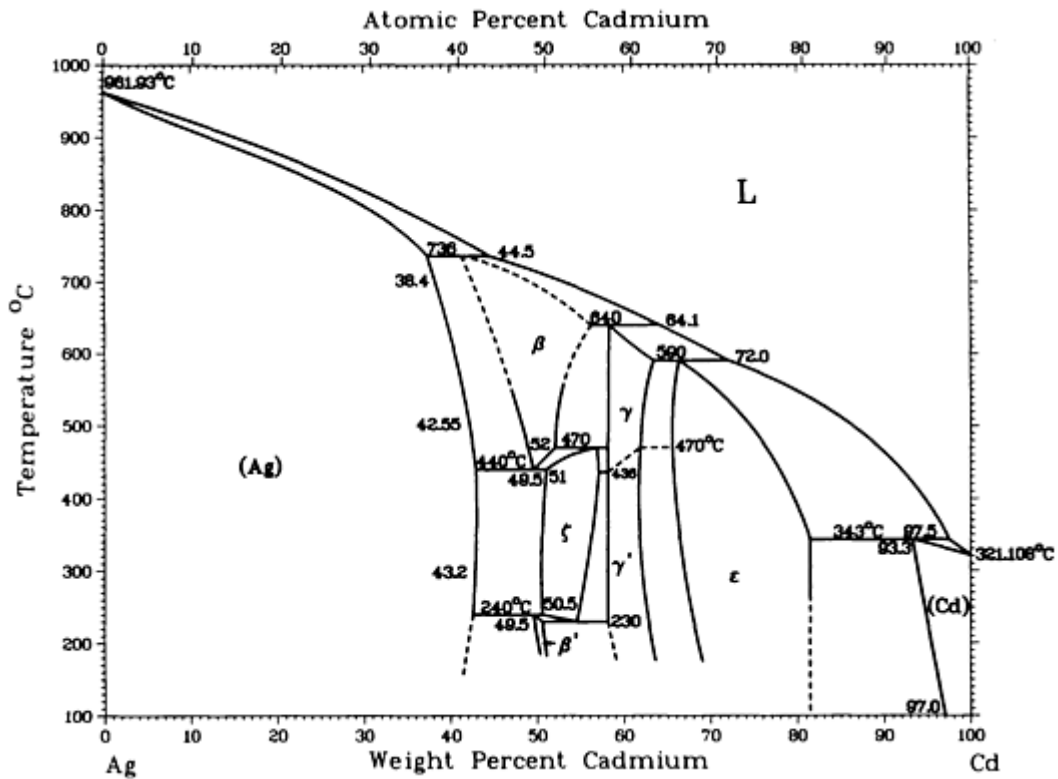

Ag-Cd phase diagram

Ag-Cd crystallographic data

Phase	Composition, wt% Cd	Pearson symbol	Space group
(Ag)	0 to 43.2	$cF4$	$Fm\bar{3}m$
β	41 to 56	$cI2$	$Im\bar{3}m$
β'	49.5 to 51.0	(a)	...

ζ	50.5 to 57	(b)	...
γ'	58 to 63.5
γ	58 to 63.5	$cI52$	$\bar{1}4_3m$
ε	65.4 to 82	$hP2$	$P6_3/mmc$
(Cd)	93.3 to 100	$hP2$	$P6_3/mmc$

(a) Ordered bcc.

(b) cph

Reference cited in this section

6. [Hansen]: M. Hansen and K. Anderko, *Constitution of Binary Alloys*, McGraw-Hill, New York or General Electric Co., Business Growth Services, Schenectady, New York (1958).

Ag-Ce (Silver - Cerium)

K.A. Gschneidner, Jr. and F.W. Calderwood, 1985

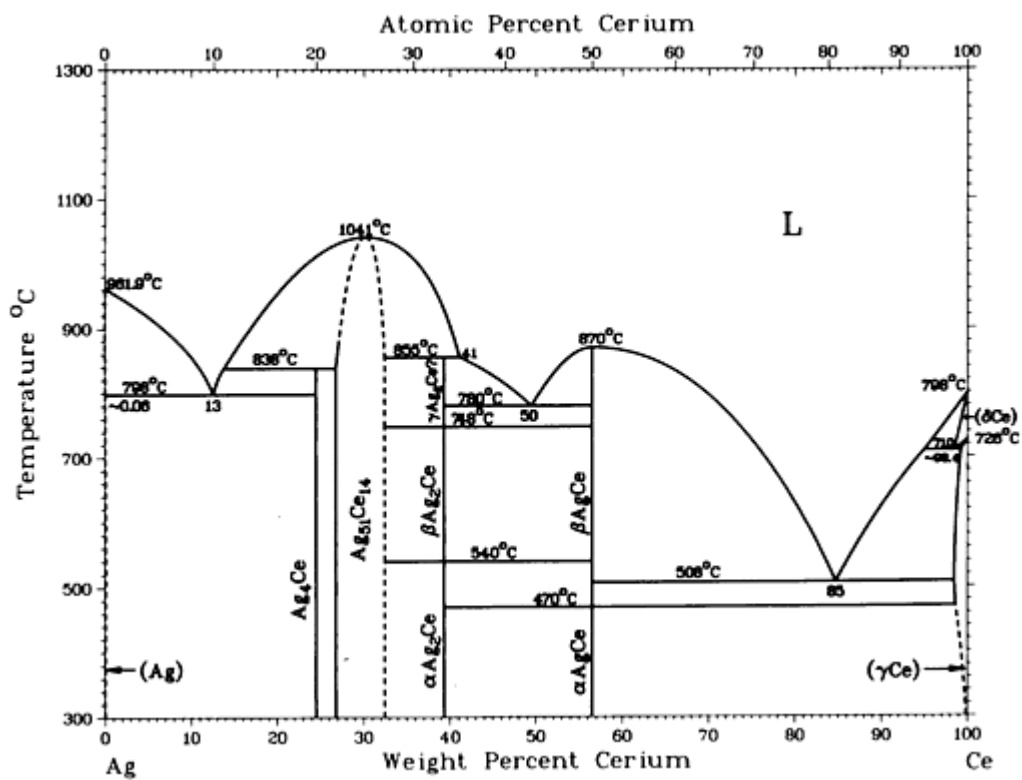

Ag-Ce phase diagram

Ag-Ce crystallographic data

Phase	Composition, wt% Ce	Pearson symbol	Space group
(Ag)	0 to ~0.06	<i>cF4</i>	<i>Fm</i> $\bar{3}m$
Ag ₅₁ Ce ₁₄	26.2 to ~30	<i>hP65</i>	<i>P6/m</i>
α Ag ₂ Ce	39.3	<i>oI12</i>	<i>Imma</i>
AgCe	56.5	<i>cP2</i>	<i>Pm</i> $\bar{3}m$
(δ Ce)	~98 to 100	<i>cI2</i>	<i>Im</i> $\bar{3}m$
(γ Ce)	~98 to 100	<i>cF4</i>	<i>Fm</i> $\bar{3}m$
(β Ce)	100	<i>hP4</i>	<i>P6₃/mmc</i>
(α Ce)	100	<i>cF4</i>	<i>Fm</i> $\bar{3}m$

Ag-Co (Silver - Cobalt)

I. Karakaya and W.T. Thompson, 1986

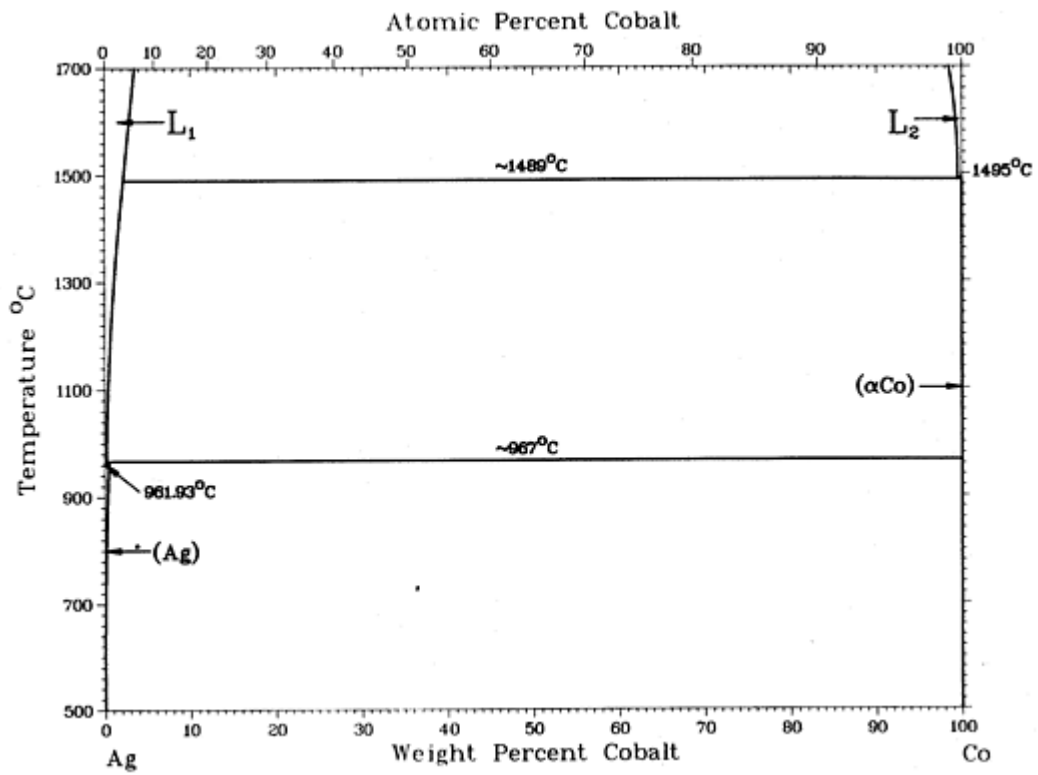

Ag-Co phase diagram

Ag-Co crystallographic data

Phase	Composition, wt% Co	Pearson symbol	Space group
(Ag)	0 to 0.44	<i>cF4</i>	<i>Fm</i> $\bar{3}m$
(εCo) ^(a)	100	<i>hP2</i>	<i>P6</i> ₃ / <i>mmc</i>
(αCo)	~100	<i>cF4</i>	<i>Fm</i> $\bar{3}m$

(a) Below 422 °C

Ag-Cu (Silver - Copper)

P.R. Subramanian and J.H. Perepezko, unpublished

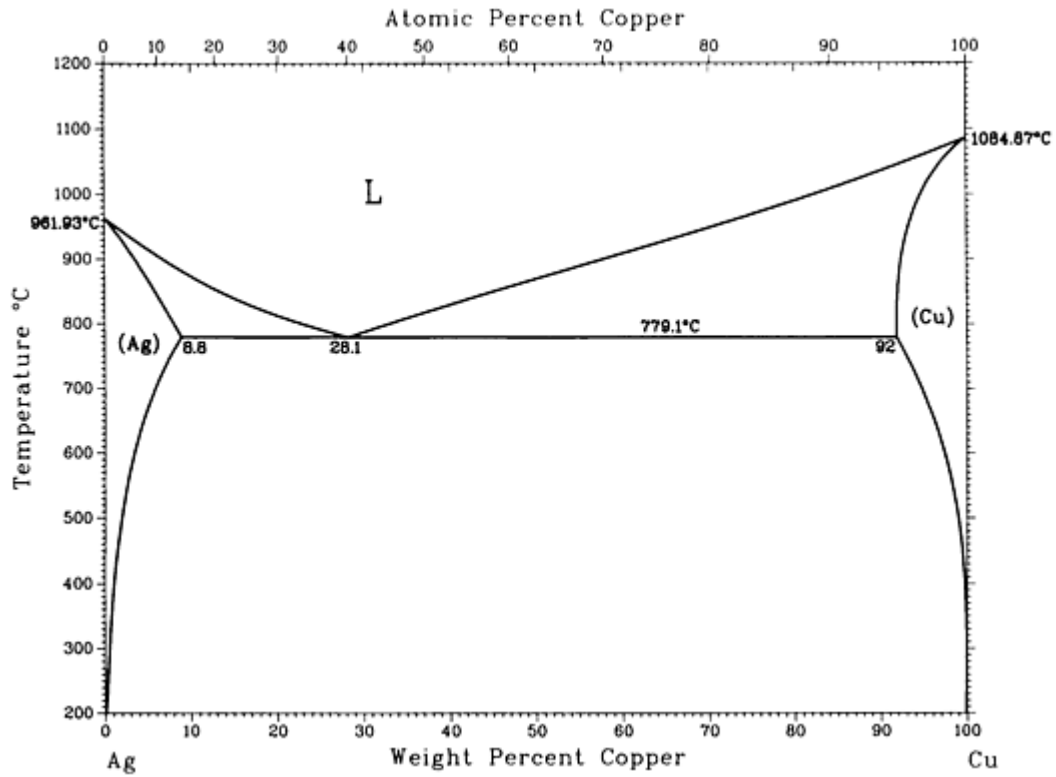

Ag-Cu phase diagram

Ag-Cu crystallographic data

Phase	Composition, wt% Cu	Pearson symbol	Space group
(Ag)	0 to 8.8	$cF4$	$Fm\bar{3}m$
(Cu)	92.0 to 100	$cF4$	$Fm\bar{3}m$

Ag-Dy (Silver - Dysprosium)

K.A. Gschneidner, Jr. and F.W. Calderwood, 1985

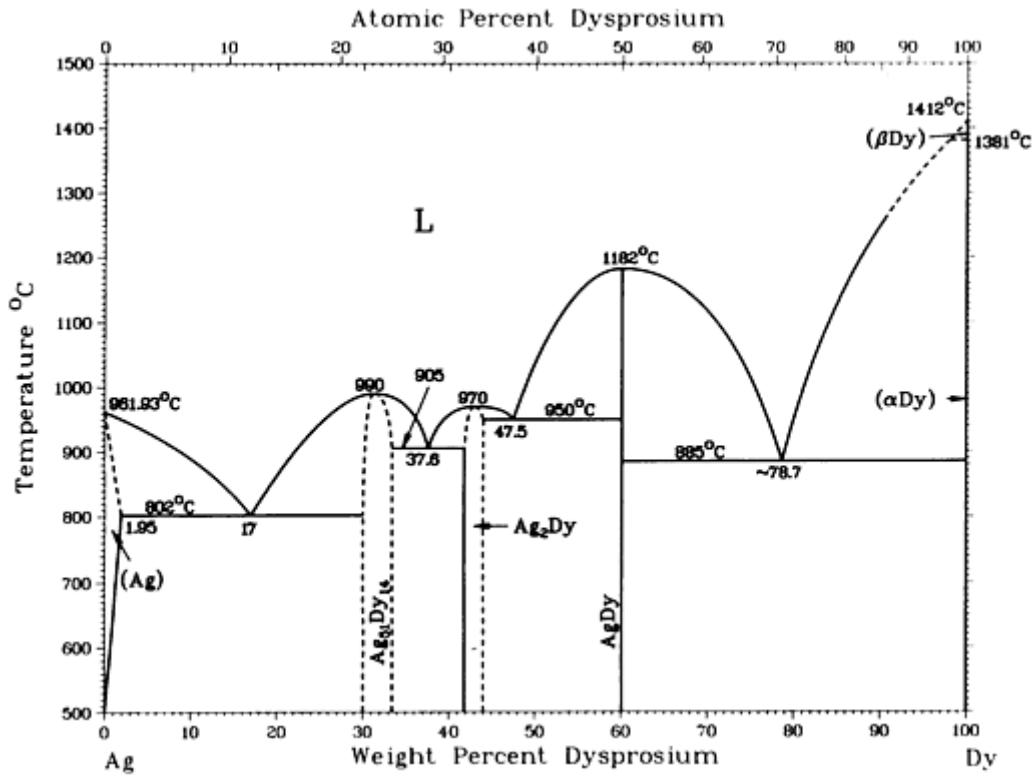

Ag-Dy phase diagram

Ag-Dy crystallographic data

Phase	Composition, wt% Dy	Pearson symbol	Space group
(Ag)	0 to 1.95	<i>cF4</i>	<i>Fm</i> $\bar{3}m$
Ag ₅₁ Dy ₁₄	29.2 to 34.0	<i>hP65</i>	...
Ag ₂ Dy	41.8 to 44.0	<i>tI6</i>	<i>I4/mmm</i>
AgDy	60.1	<i>cP2</i>	<i>Pm</i> $\bar{3}m$
(βDy)	100	<i>cI2</i>	<i>Im</i> $\bar{3}m$
(αDy)	100	<i>hP2</i>	<i>P6₃/mmc</i>
(α'Dy) ^(a)	100

(a) Below -187 °C

Ag-Er (Silver - Erbium)

K.A. Gschneidner, Jr. and F.W. Calderwood, 1985

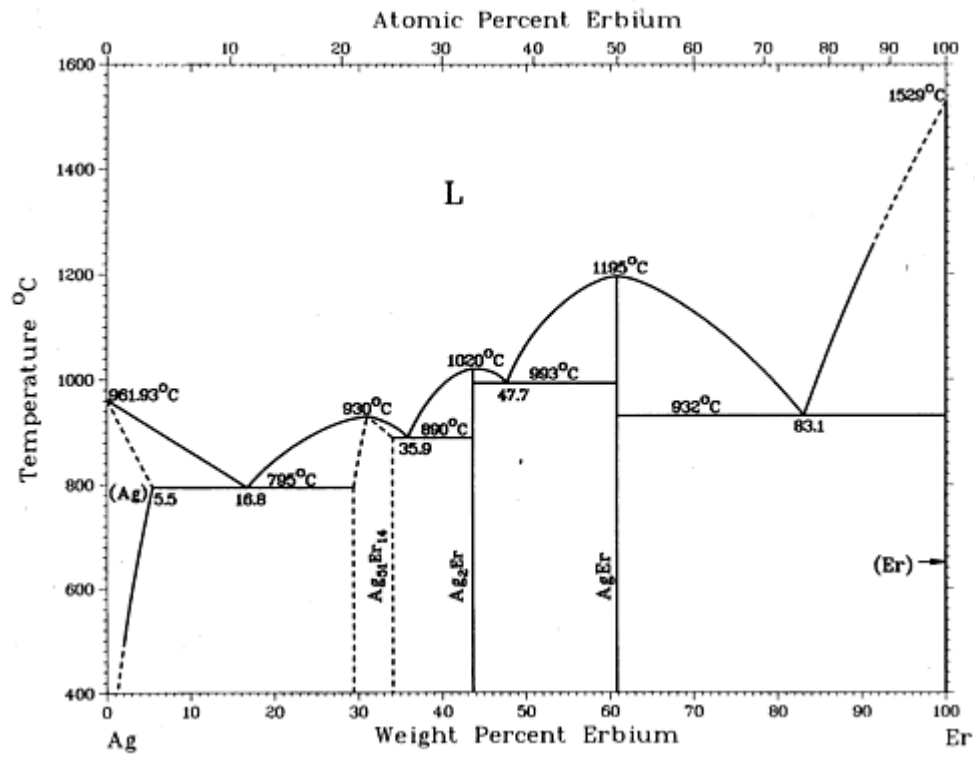

Ag-Er phase diagram

Ag-Er crystallographic data

Phase	Composition, wt% Er	Pearson symbol	Space group
(Ag)	0 to 5.5	<i>cF4</i>	<i>Fm</i> $\bar{3}$ <i>m</i>
$Ag_{51}Er_{14}$	29.8 to 34.7	<i>hP65</i>	...
Ag_2Er	43.6	<i>tI6</i>	<i>I4/mmm</i>
AgEr	60.8	<i>cP2</i>	<i>Pm</i> $\bar{3}$ <i>m</i>
(Er)	100	<i>hP2</i>	<i>P6_3/mmc</i>

Ag-Eu (Silver - Europium)

K.A. Gschneidner, Jr. and F.W. Calderwood, 1985

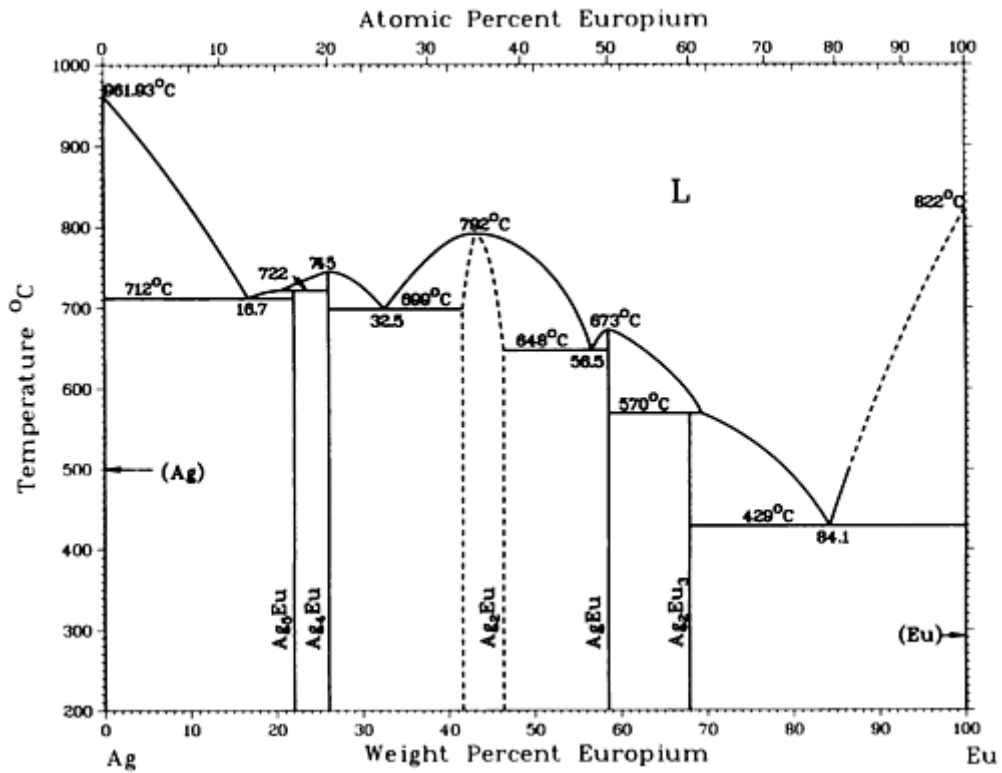

Ag-Eu phase diagram

Ag-Eu crystallographic data

Phase	Composition, wt% Eu	Pearson symbol	Space group
(Ag)	0	$cF4$	$Fm\bar{3}m$
Ag_5Eu	22.0	$hP6$	$P6/mmm$
Ag_4Eu	26	$tI10$	$I4/m$
Ag_2Eu	41.3	$oI12$	$Imma$
$AgEu$	58.5	$oP8$	$Pnma$
Ag_2Eu_3	67.9	$tP10$	$P4/mbm$
(Eu)	100	$cI2$	$Im\bar{3}m$

Ag-Fe (Silver - Iron)

L.J. Swartzendruber, 1984

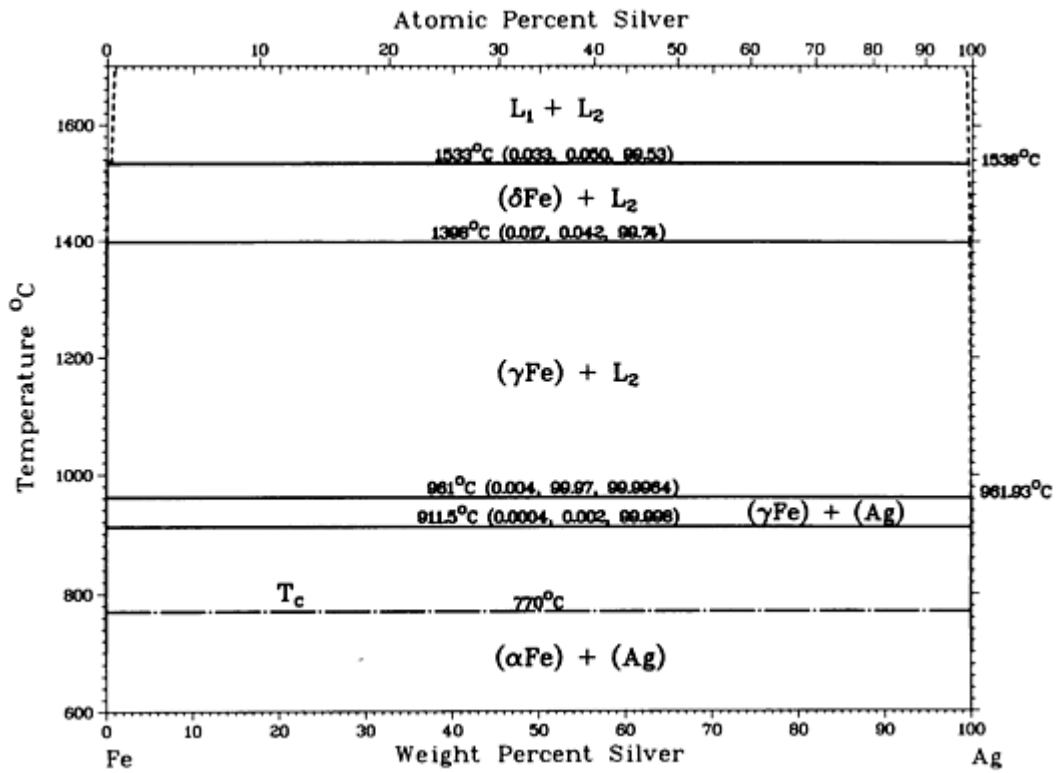

Ag-Fe phase diagram

Ag-Fe crystallographic data

Phase	Composition, wt% Ag	Pearson symbol	Space group
δ or (δFe)	0 to 0.033	$cI2$	$Im\bar{3}m$
γ or (γFe)	0 to 0.042	$cF4$	$Fm\bar{3}m$
α or (αFe)	0 to 0.0004	$cI2$	$Im\bar{3}m$
(Ag)	99.99663 to 100	$cF4$	$Fm\bar{3}m$

Ag-Ga (Silver - Gallium)

H. Okamoto, 1992

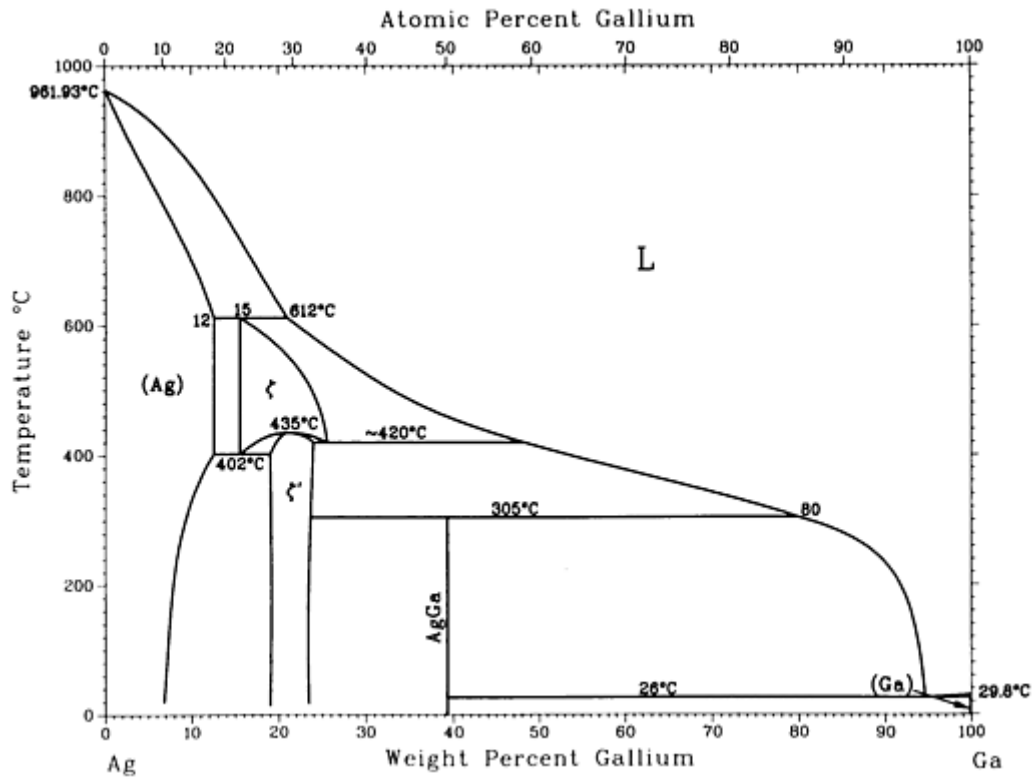

Ag-Ga phase diagram

Ag-Ga crystallographic data

Phase	Composition, wt% Ga	Pearson symbol	Space group
(Ag)	0 to 12	<i>cF4</i>	<i>Fm</i> $\bar{3}m$
ζ	15 to 25	<i>hP2</i>	<i>P6</i> ₃ / <i>mmc</i>
ζ'	18 to 24	<i>hP9</i>	<i>P</i> $\bar{3}$
AgGa	39.2	<i>cI2</i>	<i>Im</i> $\bar{3}m$
(Ga)	100	<i>oC8</i>	<i>Cmca</i>

Ag-Gd (Silver - Gadolinium)

K.A. Gschneidner, Jr. and F.W. Calderwood, 1985

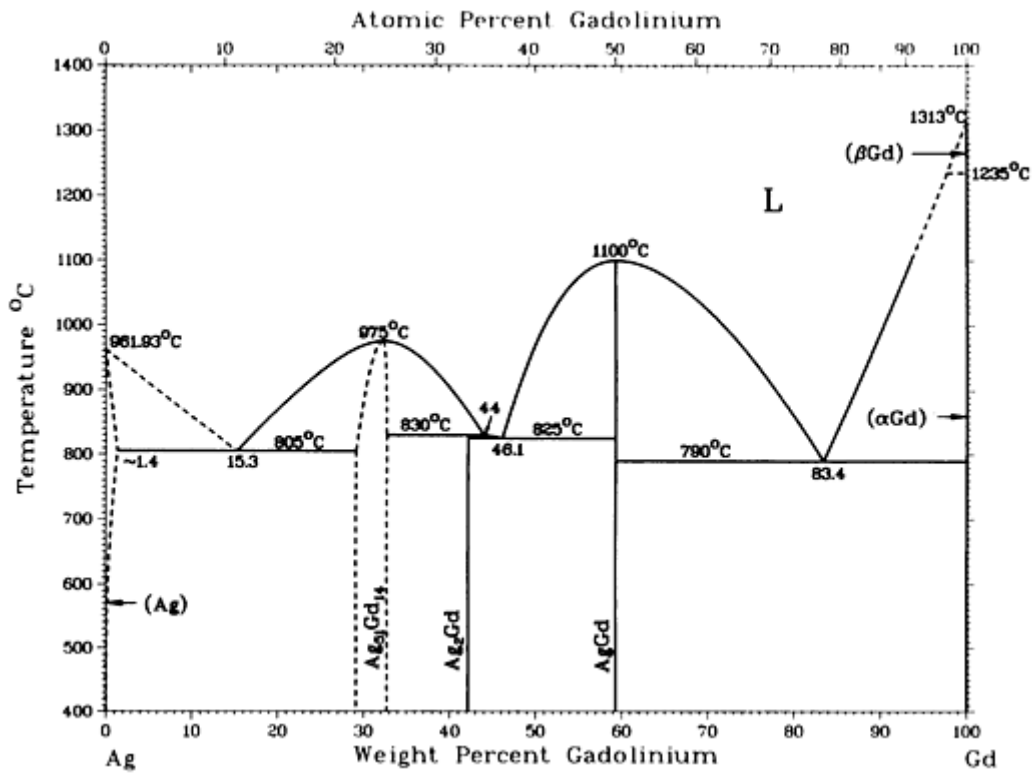

Ag-Gd phase diagram

Ag-Gd crystallographic data

Phase	Composition, wt% Gd	Pearson symbol	Space group
(Ag)	0 to ~1.4	<i>cF4</i>	<i>Fm</i> $\bar{3}m$
Ag ₅₁ Gd ₁₄	28.5	<i>tP65</i>	<i>P6/m</i>
Ag ₂ Gd	42.1	<i>tI6</i>	<i>I4/mmm</i>
AgGd	59.3	<i>cP2</i>	<i>Pm</i> $\bar{3}m$
(βGd)	100	<i>cI2</i>	<i>Im</i> $\bar{3}m$
(αGd)	100	<i>hP2</i>	<i>P6₃/mmc</i>

Ag-Ge (Silver - Germanium)

R.W. Olesinski and G.J. Abbaschian, 1988

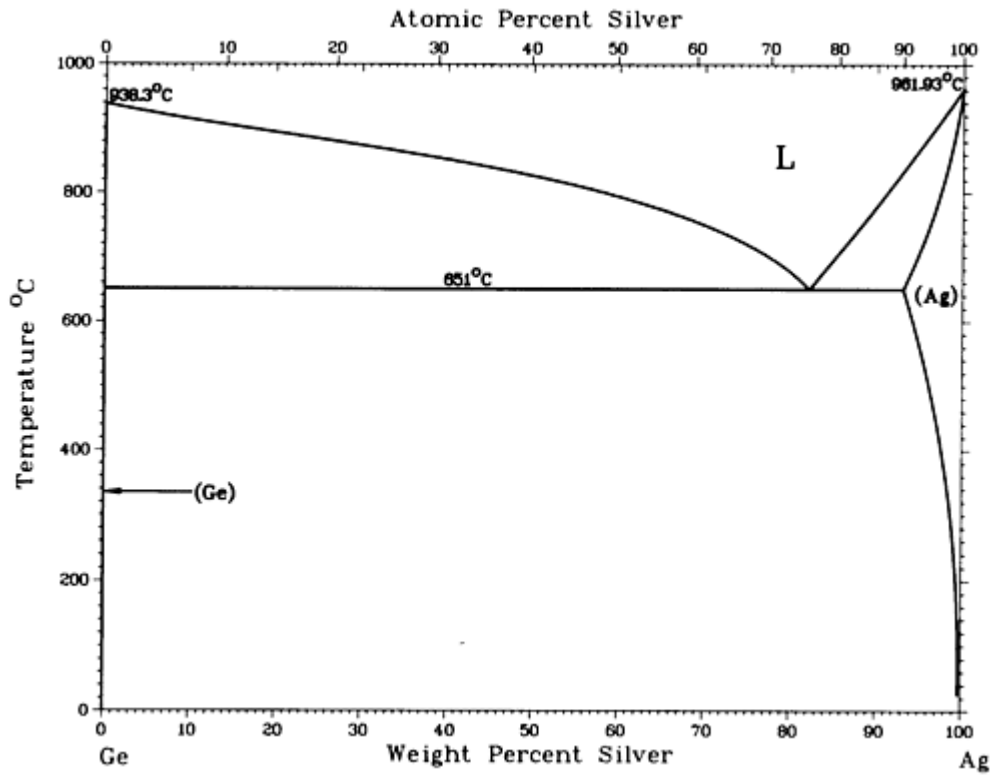

Ag-Ge phase diagram

Ag-Ge crystallographic data

Phase	Composition, wt% Ag	Pearson symbol	Space group
(Ge)	~0	<i>cF8</i>	<i>Fd$\bar{3}m$</i>
GeII (HP)	0	<i>tI4</i>	<i>I4₁/amd</i>
(Ag)	93.3 to 100	<i>cF4</i>	<i>Fm$\bar{3}m$</i>
Metastable phases			
β (cph)	83 to 86	<i>hP*</i>	...
Tetragonal	85	<i>t**</i>	...

Ag-Hg (Silver - Mercury)

M.R. Baren, unpublished

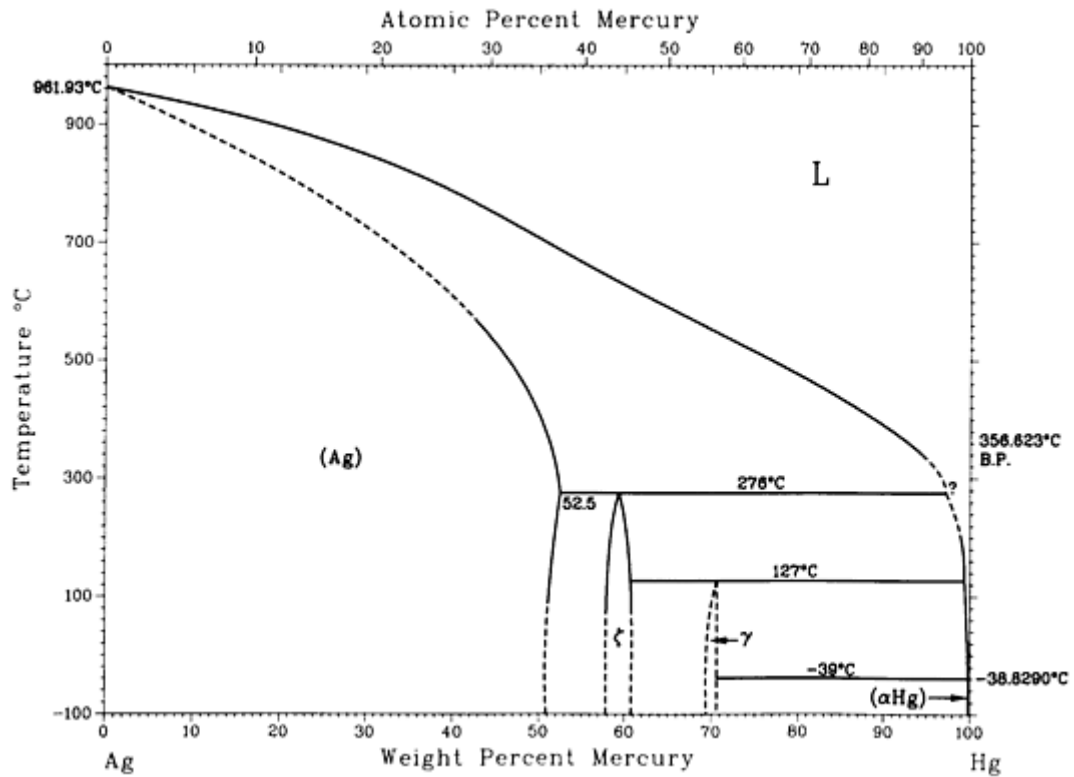

Ag-Hg phase diagram

Ag-Hg crystallographic data

Phase	Composition, wt% Hg	Pearson symbol	Space group
(Ag)	0 to 52.5	$cF4$	$Fm\bar{3}m$
ζ	58.9 to 61.3	$hP2$	$P6_3/mmc$
γ	70.0 to 71.0	cI^*	$I23$
(αHg)	100	$hR1$	$R\bar{3}m$

Ag-Ho (Silver - Holmium)

K.A. Gschneidner, Jr. and F.W. Calderwood, 1985

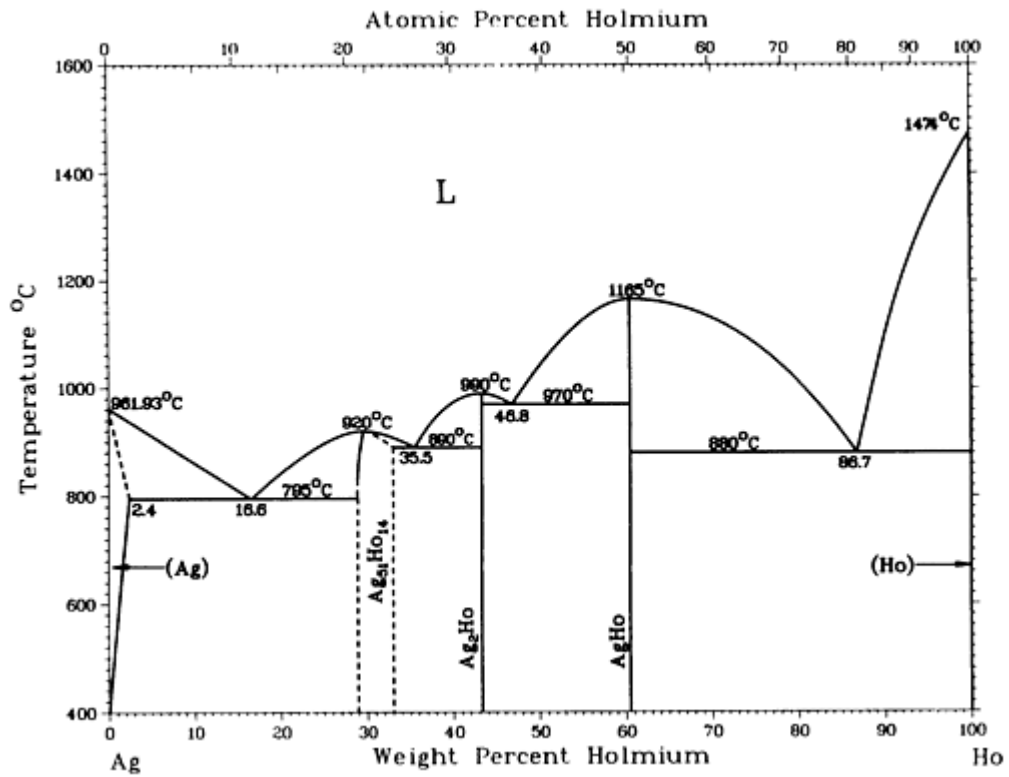

Ag-Ho phase diagram

Ag-Ho crystallographic data

Phase	Composition, wt% Ho	Pearson symbol	Space group
(Ag)	0 to 2.4	<i>cF4</i>	<i>Fm</i> $\bar{3}m$
$Ag_{51}Ho_{14}$	29.5	<i>hP65</i>	<i>P6/m</i>
Ag_2Ho	43.3	<i>tI6</i>	<i>I4/mmm</i>
AgHo	60.5	<i>cP2</i>	<i>Pm</i> $\bar{3}m$
(Ho)	100	<i>hP2</i>	<i>P6_3/mmc</i>

Ag-In (Silver - Indium)

M.R. Baren, 1992

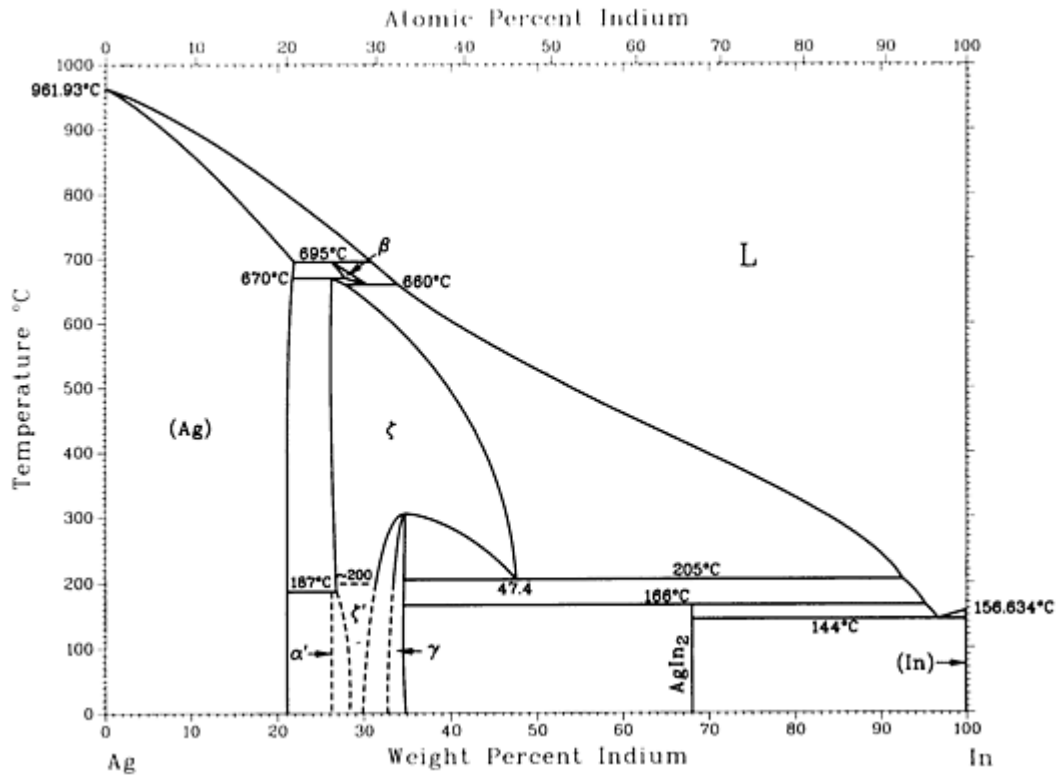

Ag-In phase diagram

Ag-In crystallographic data

Phase	Composition, wt% In	Pearson symbol	Space group
α (Ag)	0 to 22.1	<i>cF4</i>	<i>Fm</i> $\bar{3}m$
β	26.2 to 31.3	<i>cI2</i>	<i>Im</i> $\bar{3}m$
α' (Ag ₃ In)	26	<i>cP4</i> ?	<i>Pm</i> $\bar{3}m$?
ζ	26.2 to 47.6	<i>hP*</i>	...
ζ'	?	<i>hP8</i>	<i>P6</i> ₃ / <i>mmc</i>
γ (Ag ₂ In)	32.5 to 35.0	<i>cP52</i>	<i>P</i> $\bar{4}$ <i>3m</i>

φ (AgIn ₂)	68.1	<i>tI12</i>	<i>I4/mcm</i>
(In)	100	<i>tI2</i>	<i>I4/mmm</i>
Metastable phases			
...	19.4	<i>hP2</i>	<i>P6₃/mmc</i>
...	71 to 81	<i>cF4</i>	<i>Fm$\bar{3}$m</i>

Ag-La (Silver - Lanthanum)

K.A. Gschneidner, Jr. and F.W. Calderwood, 1983

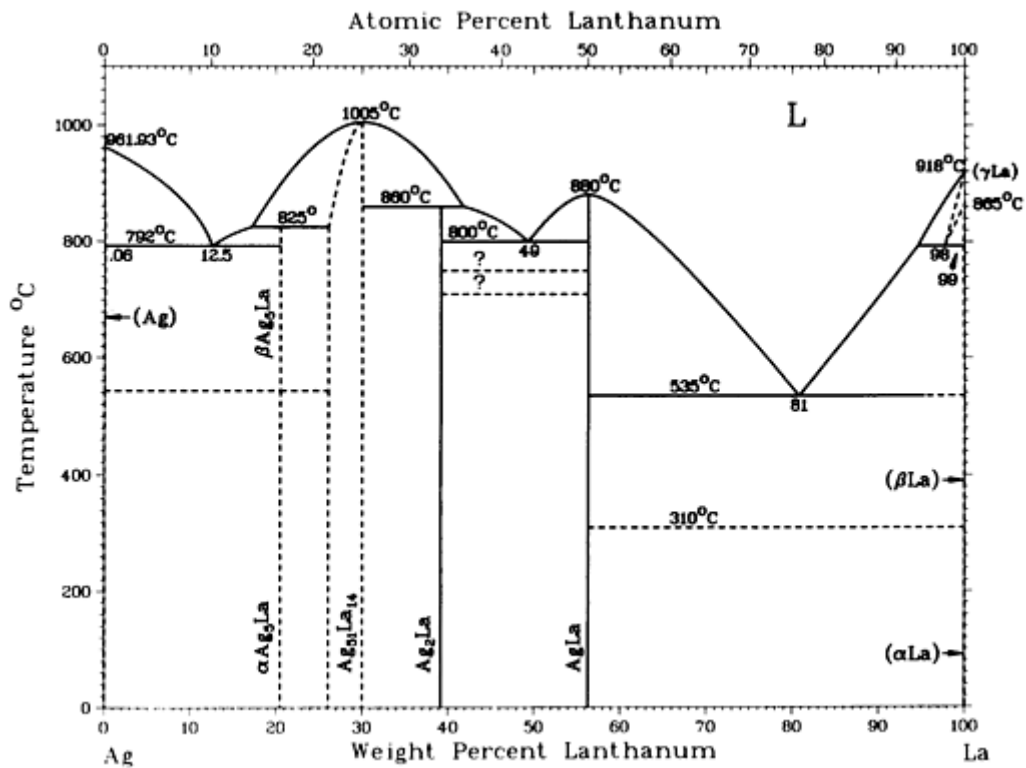

Ag-La phase diagram

Ag-La crystallographic data

Phase	Composition, wt% La	Pearson symbol	Space group
(Ag)	0	<i>cF4</i>	<i>Fm$\bar{3}$m</i>

Ag ₅ La	20.5	<i>hP?</i>	...
Ag ₅₁ La ₁₄	26.1	<i>hP65</i>	...
Ag ₂ La	39.1	<i>oI12</i>	<i>Imma</i>
AgLa	56.3	<i>cP2</i>	<i>Pm$\bar{3}m$</i>
(γ La)	100	<i>cI2</i>	<i>Im$\bar{3}m$</i>
(β La)	100	<i>cF4</i>	<i>Fm$\bar{3}m$</i>
(α La)	100	<i>hP4</i>	<i>P6₃/mmc</i>

Ag-Li (Silver - Lithium)

A.D. Pelton, 1986

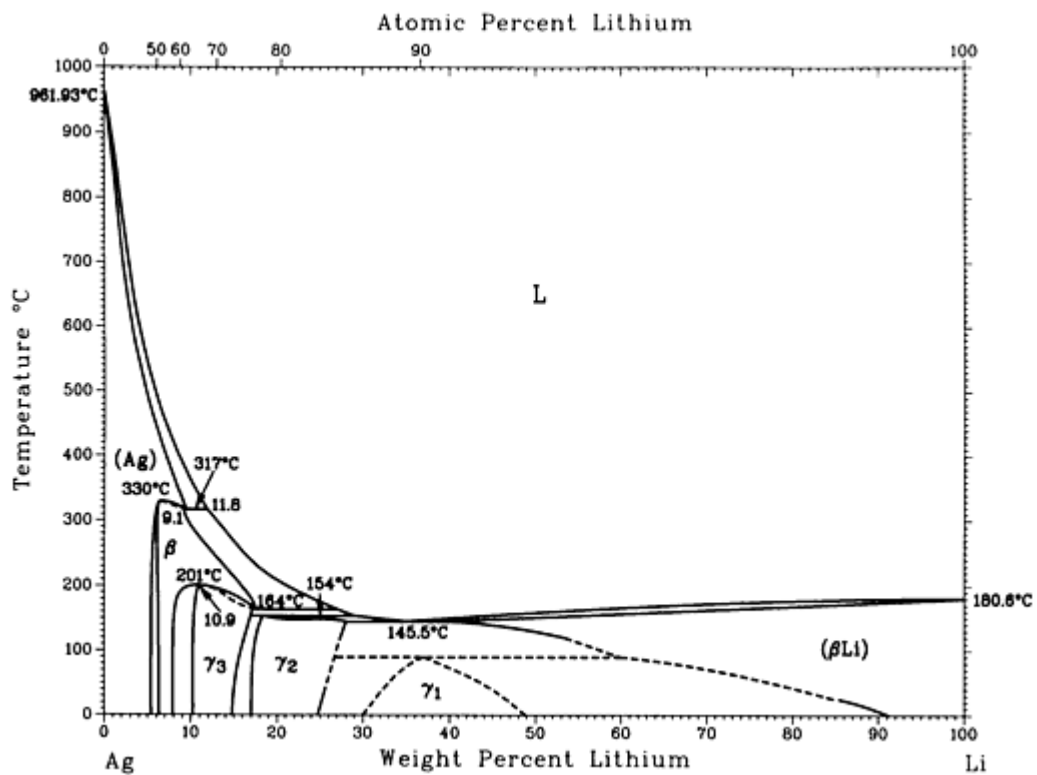

Ag-Li phase diagram

Ag-Li crystallographic data

Phase	Composition, wt% Li	Pearson symbol	Space group
(Ag)	0 to 9.1	$cF4$	$Fm\bar{3}m$
β	6.1 to 18	$cP2$	$Pm\bar{3}m$
γ_3	10.9 to 17	Cubic ($cP52?$)	$P\bar{4}3m?$
γ_2	17 to 28	Cubic ($cI52?$)	$I\bar{4}3m?$
γ_1	32 to 43	Cubic	...
(β Li)	39 to 100	$cI2$	$Im\bar{3}m$
(α Li)	100	$hP2$	$P6_3/mmc$

Ag-Mg (Silver - Magnesium)

A.A. Nayeb-Hashemi and J.B. Clark, 1988, with modifications

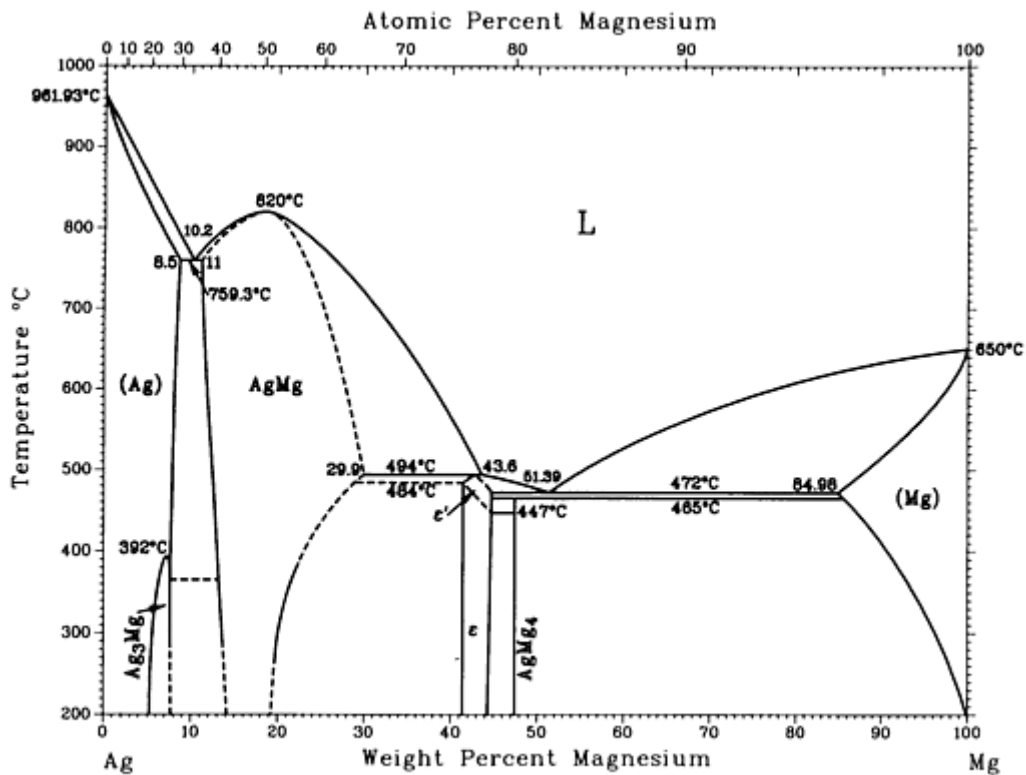

The two-phase region between (Ag) and Ag₃Mg (ordered) is not shown here.

Ag-Mg phase diagram

Ag-Mg crystallographic data

Phase	Composition, wt% Mg	Pearson symbol	Space group
(Ag) or α	0 to 8.5	$cF4$	$Fm\bar{4}m$
Ag_3Mg ord or α'	7	$cP4$	$Pm\bar{4}m$
AgMg or β'	11 to 29.9	$cP2$	$Pm\bar{4}m$
ϵ'	41.4 to 44.7	tI^*	...
ϵ	41.4 to 44.7	cF^*	...
AgMg_4	47	hP^*	...
(Mg) or δ	84.98 to 100	$hP2$	$P6_3/mmc$

Ag-Mo (Silver - Molybdenum)

M.R. Baren, 1990

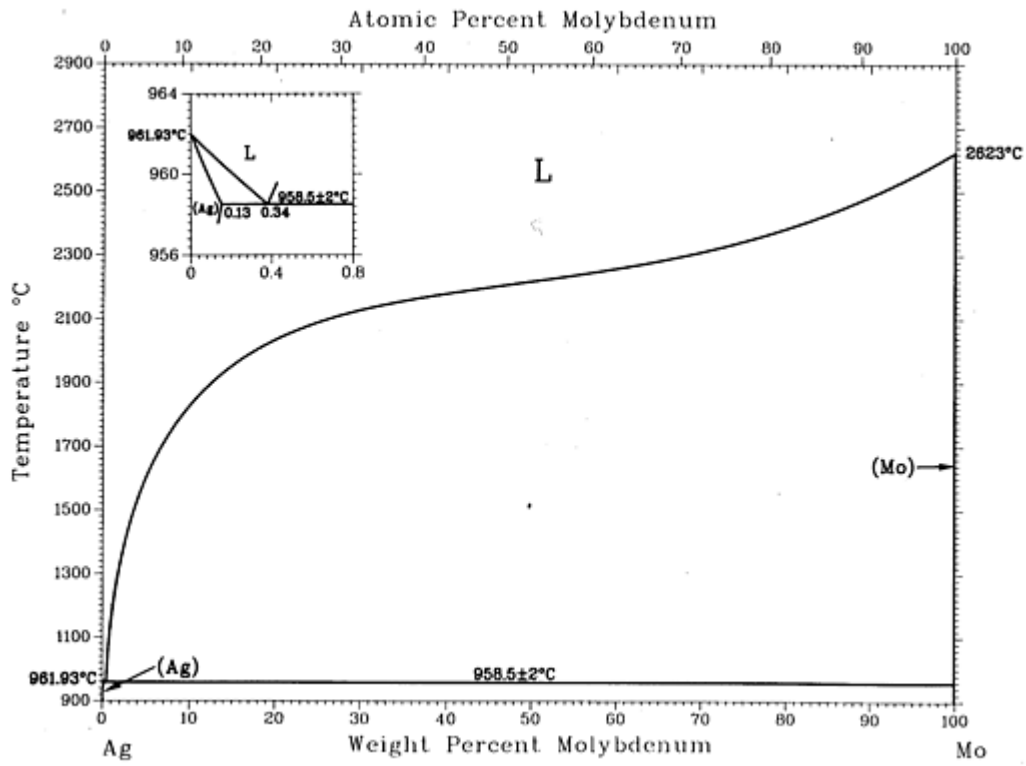

Ag-Mo phase diagram

Ag-Mo crystallographic data

Phase	Composition, wt% Mo	Pearson symbol	Space group
(Ag)	0 to 0.13	<i>cF4</i>	<i>Fm</i> $\bar{3}m$
(Mo)	100	<i>cI2</i>	<i>Im</i> $\bar{3}m$

Ag-Na (Silver - Sodium)

A.D. Pelton, 1986

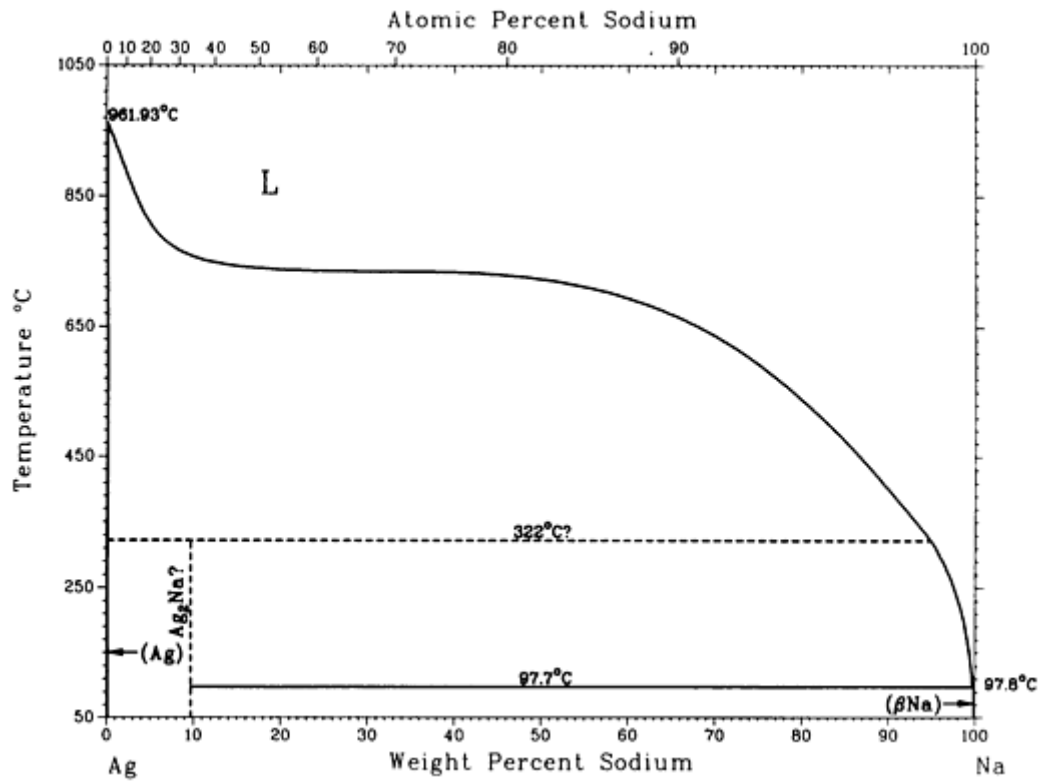

Ag-Na phase diagram

Ag-Na crystallographic data

Phase	Composition, wt% Na	Pearson symbol	Space group
(Ag)	0	<i>cF4</i>	<i>Fm</i> $\bar{3}m$
Ag ₂ Na	9.6	<i>cF24</i>	<i>Fd</i> $\bar{3}m$
(βNa)	100	<i>cI2</i>	<i>Im</i> $\bar{3}m$

Ag-Nd (Silver - Neodymium)

K.A. Gschneidner, Jr. and F.W. Calderwood, 1985

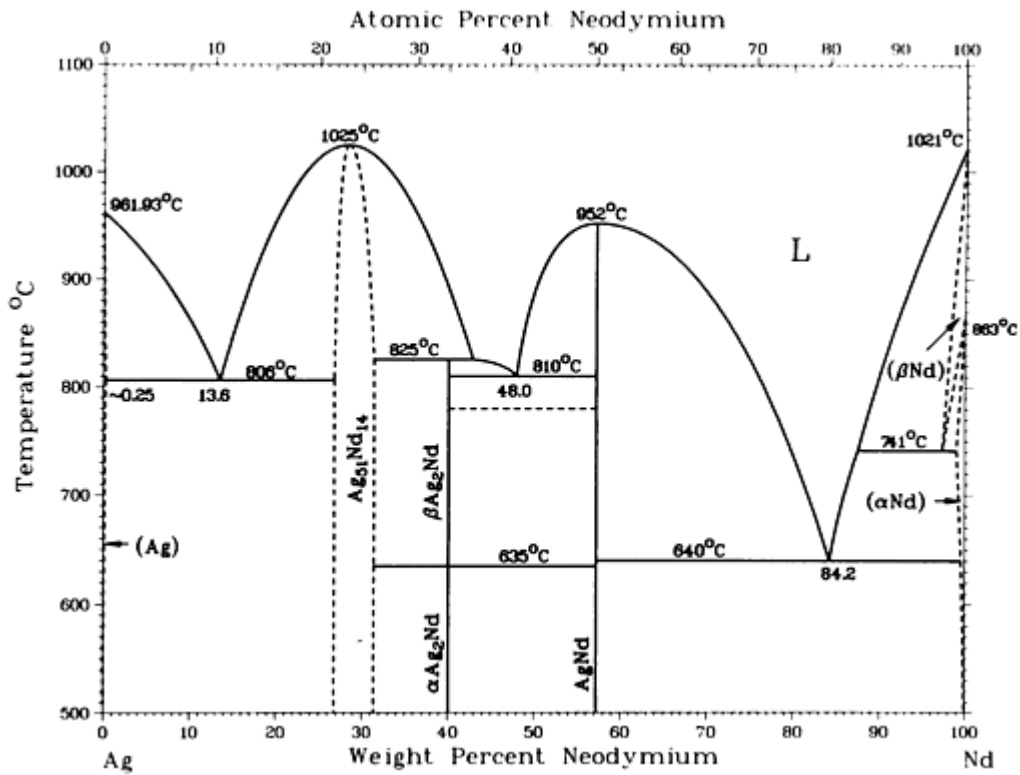

Ag-Nd phase diagram

Ag-Nd crystallographic data

Phase	Composition, wt% Nd	Pearson symbol	Space group
(Ag)	0 to ~5	<i>cF4</i>	<i>Fm</i> $\bar{3}m$
$Ag_{51}Nd_{14}$	26.8 to 31.4	<i>hP65</i>	...
βAg_2Nd	40.0	<i>hP?</i>	...
αAg_2Nd	40.0	<i>oI12</i>	<i>Imma</i>
AgNd	57.2	<i>cP2</i>	<i>Pm</i> $\bar{3}m$
(βNd)	97.4 to 100	<i>cI2</i>	<i>Im</i> $\bar{3}m$
(αNd)	99.0 to 100	<i>hP4</i>	<i>P6_3/mmc</i>

Ag-Ni (Silver - Nickel)

M. Singleton and P. Nash, 1991

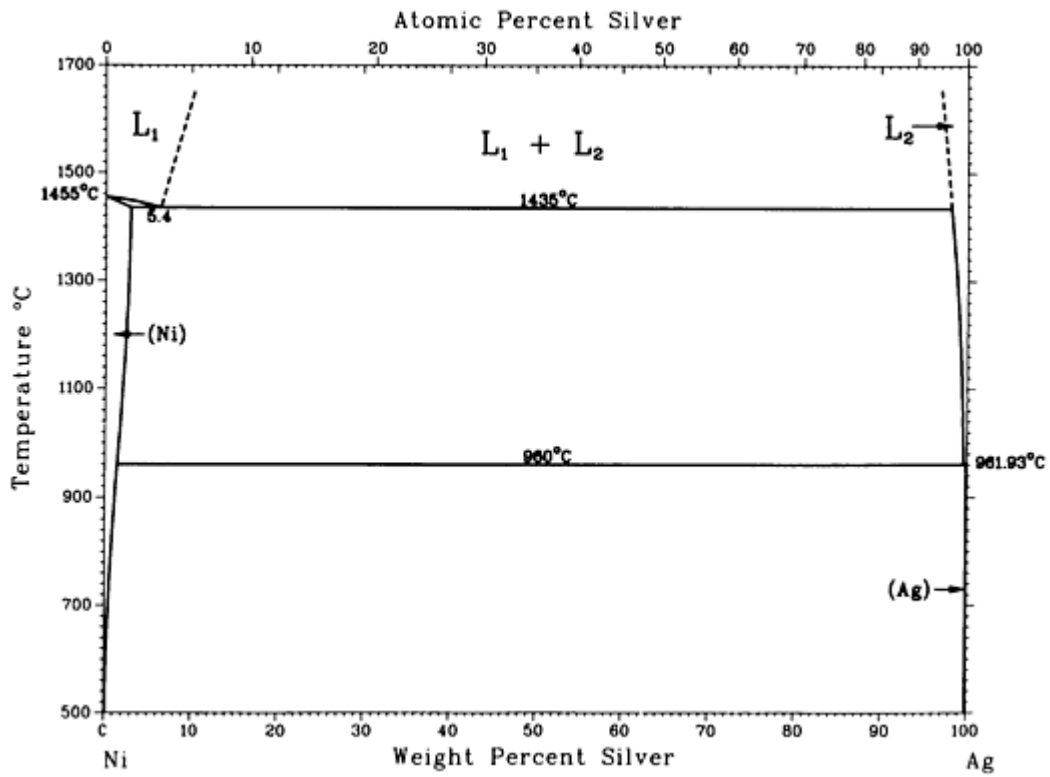

Ag-Ni phase diagram

Ag-Ni crystallographic data

Phase	Composition, wt% Ag	Pearson symbol	Space group
(Ni)	0 to 1.8	$cF4$	$Fm\bar{3}m$
(Ag)	99.3 to 100	$cF4$	$Fm\bar{3}m$

Ag-P (Silver - Phosphorus)

I. Karakaya and W.T. Thompson, 1988

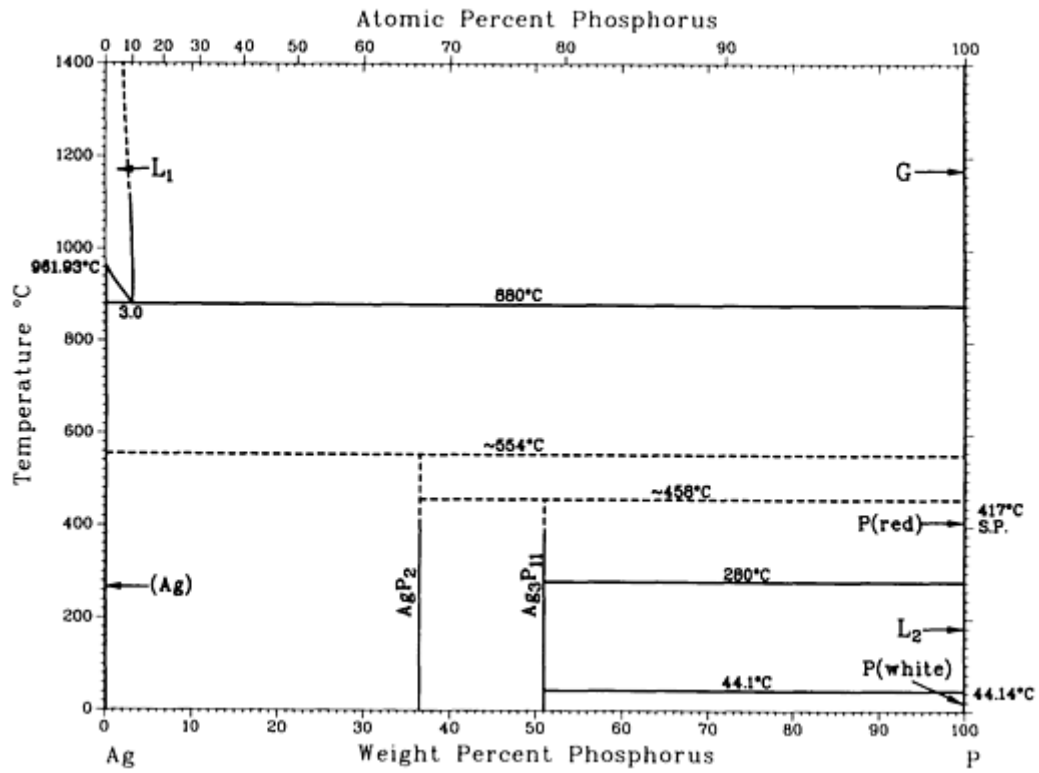

Ag-P phase diagram

Ag-P crystallographic data

Phase	Composition, wt% P	Pearson symbol	Space group
(Ag)	0	<i>cF4</i>	<i>Fm$\bar{3}m$</i>
AgP ₂	36.5	(a)	...
Ag ₃ P ₁₁	51.0	(b)	<i>Cm</i>
P(black)	100	<i>oC8^(c)</i>	<i>Cmca</i>
P(white)	100	(d)	...
P(red)	100	(e)	...

(a) Monoclinic structure with $\beta = 113.48^\circ$.

(b) Monoclinic structure with $\beta = 118.84^\circ$.

(c) At high pressures black P transforms to a rhombohedral structure.

(d) Cubic below -35°C .

(e) Cubic with 66 atoms per unit cell.

Ag-Pb (Silver - Lead)

I. Karakaya and W.T. Thompson, 1987

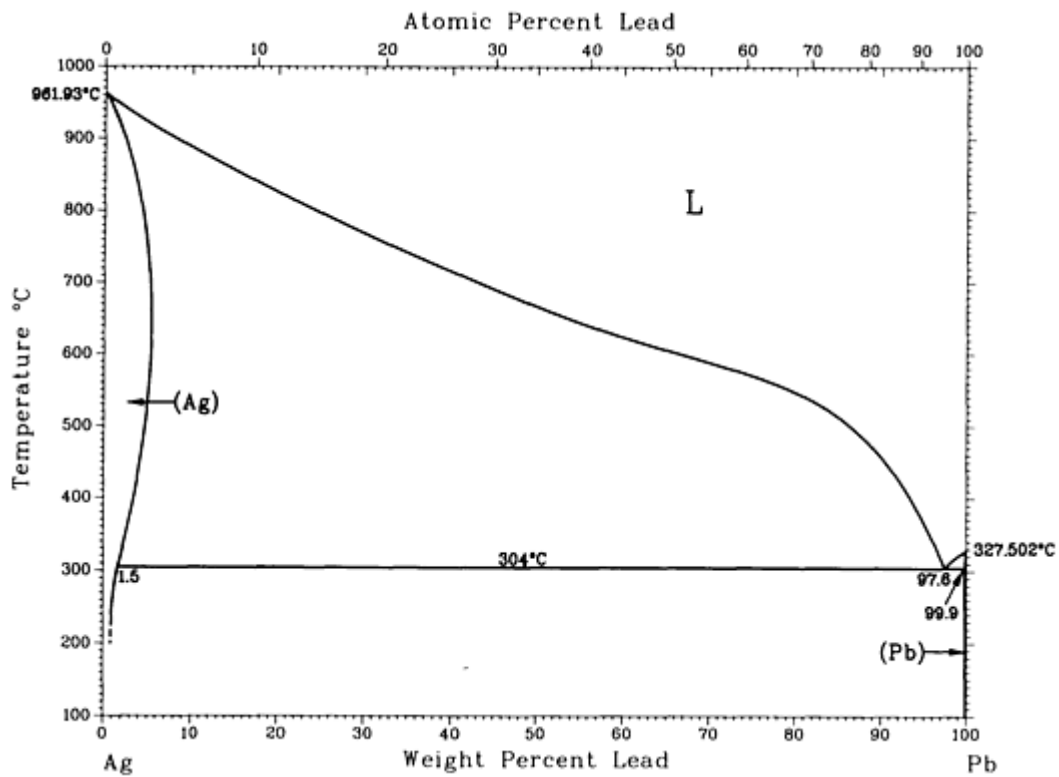

Ag-Pb phase diagram

Ag-Pb crystallographic data

Phase	Composition, wt% Pb	Pearson symbol	Space group
(Ag)	0 to 5.2	$cF4$	$Fm\bar{3}m$

(Pb)	99.9 to 100	$cF4$	$Fm\bar{3}m$
------	-------------	-------	--------------

Ag-Pd (Silver - Palladium)

I. Karakaya and W.T. Thompson, 1988

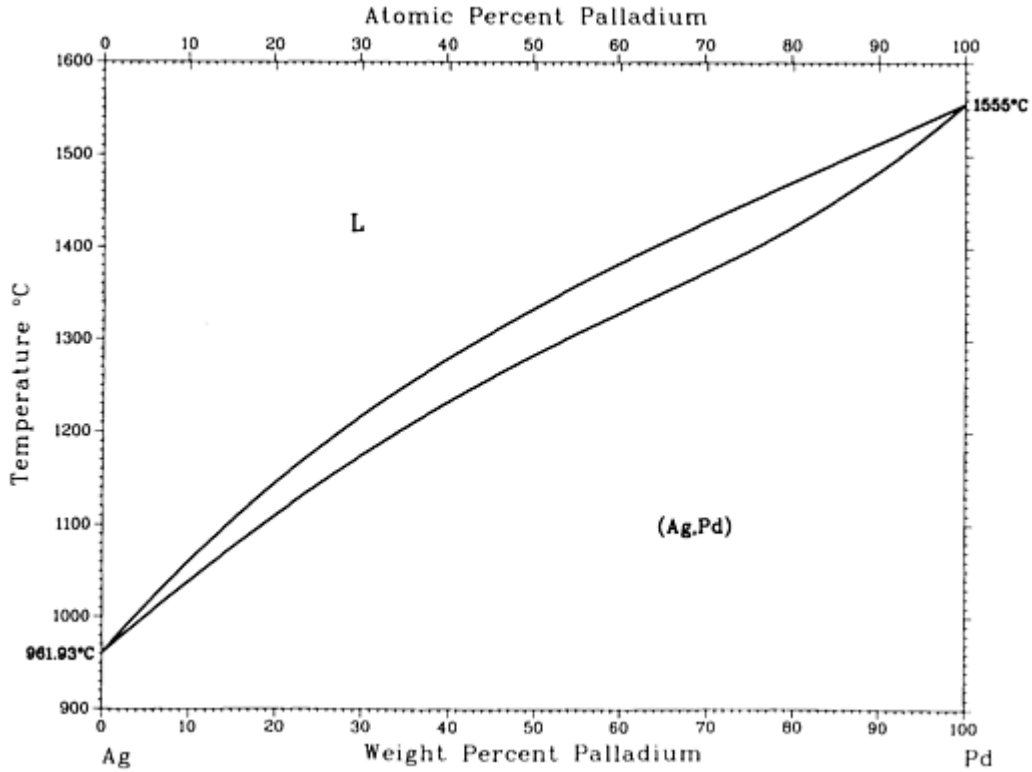

Ag-Pd phase diagram

Ag-Pd crystallographic data

Phase	Composition, wt% Pd	Pearson symbol	Space group
(Ag,Pd)	0 to 100	$cF4$	$Fm\bar{3}m$

Ag-Pr (Silver - Praseodymium)

K.A. Gschneidner, Jr. and F.W. Calderwood, 1985

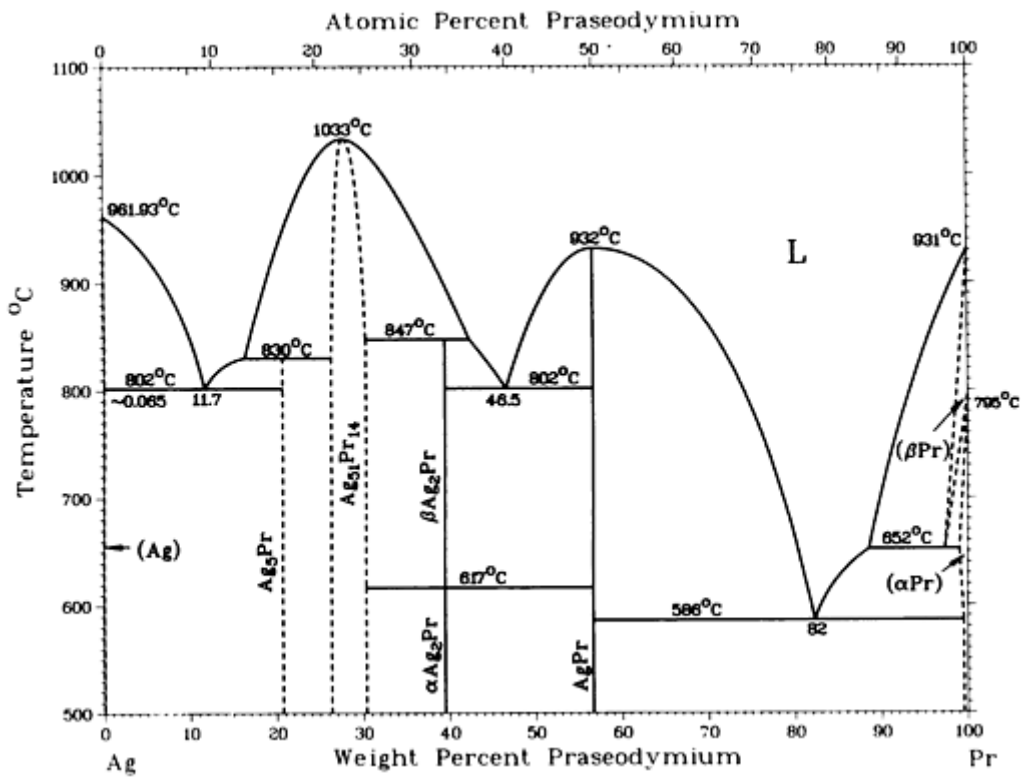

Ag-Pr phase diagram

Ag-Pr crystallographic data

Phase	Composition, wt% Pr	Pearson symbol	Space group
(Ag)	0 to ~0.065	<i>cF4</i>	<i>Fm</i> $\bar{3}m$
Ag ₅ Pr	20.8
Ag ₅₁ Pr ₁₄	26.4 to 30.3	<i>hP65</i>	...
βAg ₂ Pr	39.5	<i>hP?</i>	...
αAg ₂ Pr	39.5	<i>oI12</i>	<i>Imma</i>
AgPr	56.6	<i>cP2</i>	<i>Pm</i> $\bar{3}m$
(βPr)	97.3 to 100	<i>cI2</i>	<i>Im</i> $\bar{3}m$

(α Pr)	99.0 to 100	$hP4$	$P6_3/mmc$
----------------	-------------	-------	------------

Ag-Pt (Silver - Platinum)

I. Karakaya and W.T. Thompson, 1987

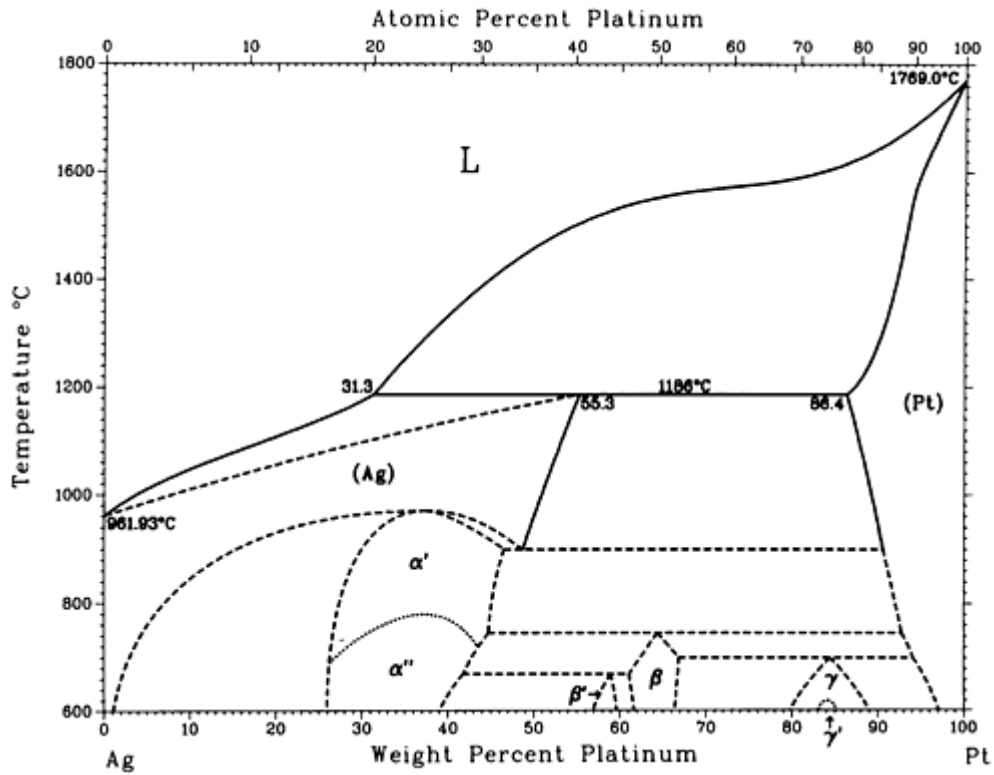

Ag-Pt phase diagram

Ag-Pt crystallographic data

Phase	Composition ^(a) , wt% Pt	Pearson symbol	Space group
(Ag)	0 to 55.3	$cF4$	$Fm\bar{3}m$
(Pt)	86.4 to 100	$cF4$	$Fm\bar{3}m$
α'	26 to 47	$cF4$	$Fm\bar{3}m$
α''	26 to 43	$cP4$	$Pm\bar{3}m$
$\beta^{(b)}$	61 to 67

$\beta^{(b)}$	57 to 60
γ	80 to 89	$cP4$	$Pm\bar{3}m$
γ'	83 to 85	cF^*	...

Note: α' , α'' , β , β' , γ , and γ' phases are questionable.

(a) Rough composition from phase diagram.

(b) Rhombohedrally distorted cubic structure

Ag-S (Silver - Sulfur)

R.C. Sharma and Y.A. Chang, 1986

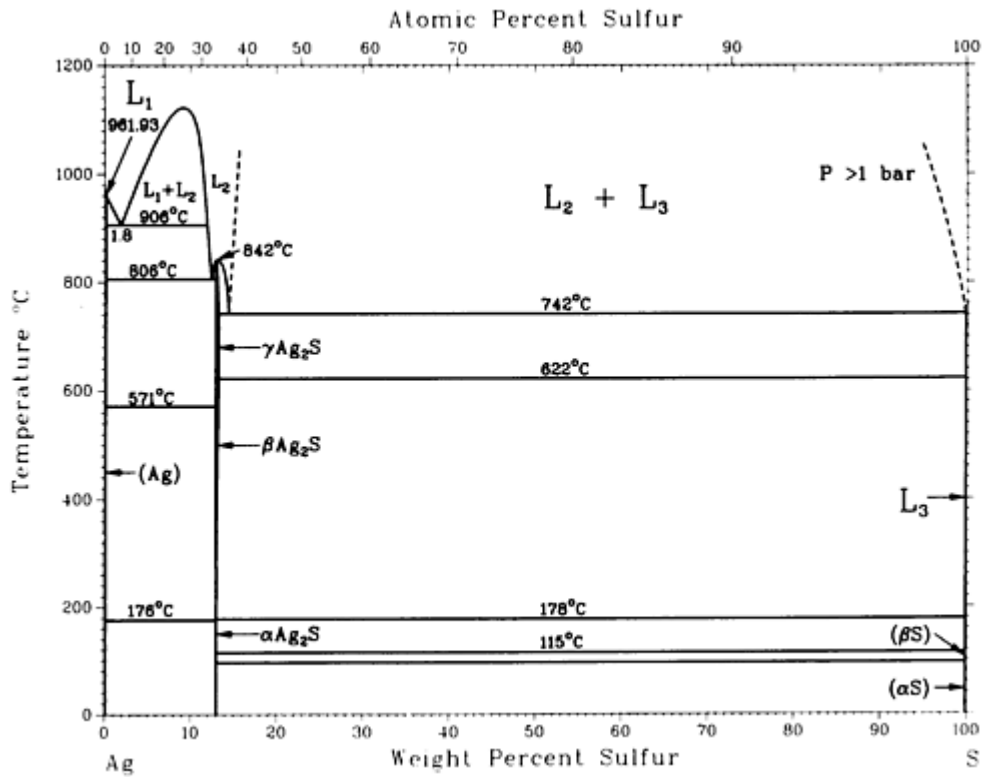

Ag-S phase diagram

Ag-S crystallographic data

Phase	Composition, wt% S	Pearson symbol	Space group

(Ag)	0.04	$cF4$	$Fm\bar{3}m$
$\alpha\text{Ag}_2\text{S}$	12.9	$mP24$	$P2_1/c$
$\alpha\text{Ag}_2\text{S}$ (acanthite)	12.9	$mP12$	$P2_1/n$
$\beta\text{Ag}_2+\delta\text{S}$	12.9	$cI6$...
$\gamma\text{Ag}_2+\delta\text{S}$	12.9	$cF12$...
$\delta\text{Ag}_2\text{S}^{(a)}$	12.9	t^{**}	...
(αS)	~ 100	$oF128$	$Fddd$
(βS)	~ 100	mP^*	$P2_1/c$

(a) High-pressure phase

Ag-Sb (Silver - Antimony)

From [Hansen] 6

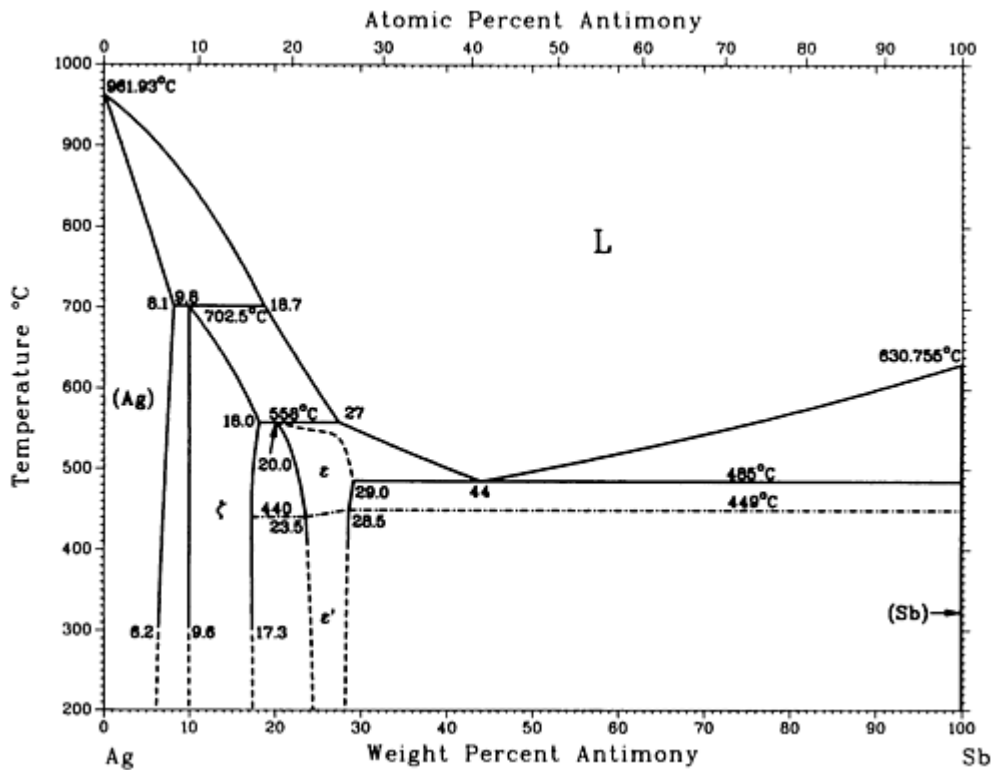

Ag-Sb phase diagram

Ag-Sb crystallographic data

Phase	Composition, wt% Sb	Pearson symbol	Space group
(Ag)	0 to 8.1	$cF4$	$Fm\bar{3}m$
ζ	9.6 to 18.0	$hP2$	$P6_3/mmc$
ϵ	20.0 to 29.0	$tP4$	$P4/mmm$
ϵ'	23.5 to 28.5	^(a)	...
(Sb)	100	$hR2$	$R\bar{3}m$

(a) Ordered orthorhombic, $L6_0$ related

Reference cited in this section

6. [Hansen]: M. Hansen and K. Anderko, *Constitution of Binary Alloys*, McGraw-Hill, New York or General Electric Co., Business Growth Services, Schenectady, New York (1958).

Ag-Sc (Silver - Scandium)

K.A. Gschneidner, Jr. and F.W. Calderwood, 1983

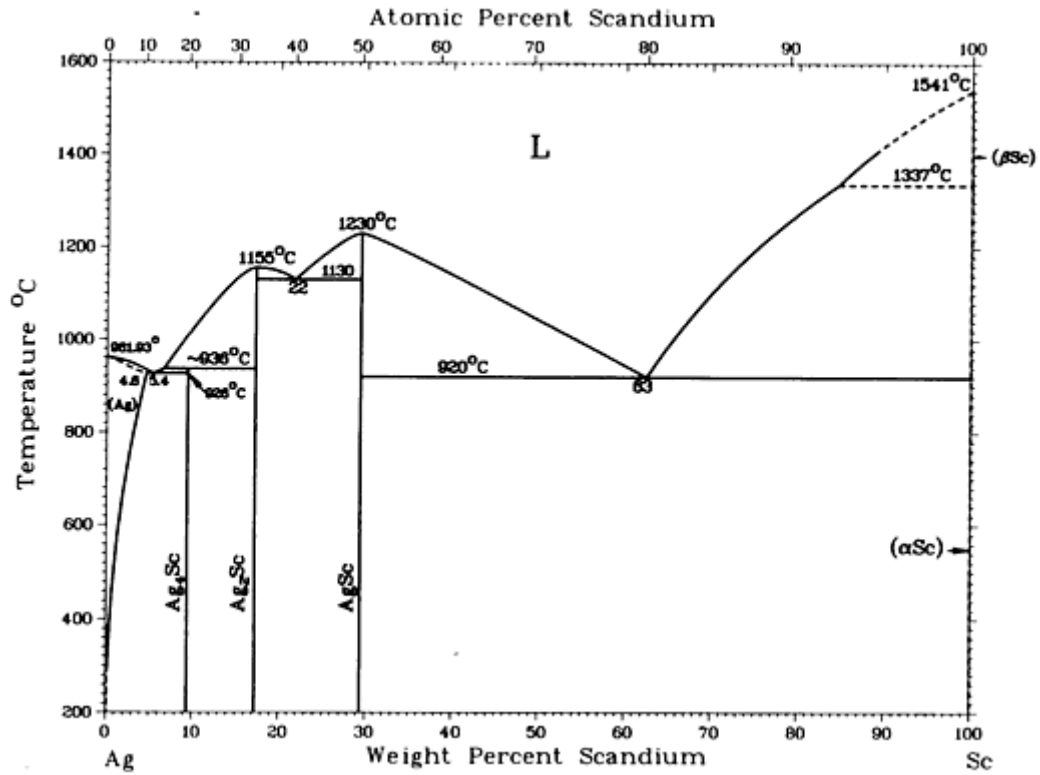

Ag-Sc phase diagram

Ag-Sc crystallographic data

Phase	Composition, wt% Sc	Pearson symbol	Space group
(Ag)	0 to 4.6	<i>cF4</i>	<i>Fm</i> $\bar{3}m$
Ag ₄ Sc	9	<i>tI10</i>	<i>I4/m</i>
Ag ₂ Sc	17.2	<i>tI6</i>	<i>I4/mmm</i>
AgSc	29.4	<i>cP2</i>	<i>Pm</i> $\bar{3}m$
(β Sc)	100	<i>cI2</i>	<i>Im</i> $\bar{3}m$
(α Sc)	100	<i>hP2</i>	<i>P6₃/mmc</i>

Ag-Se (Silver - Selenium)

I. Karakaya and W.T. Thompson, 1990

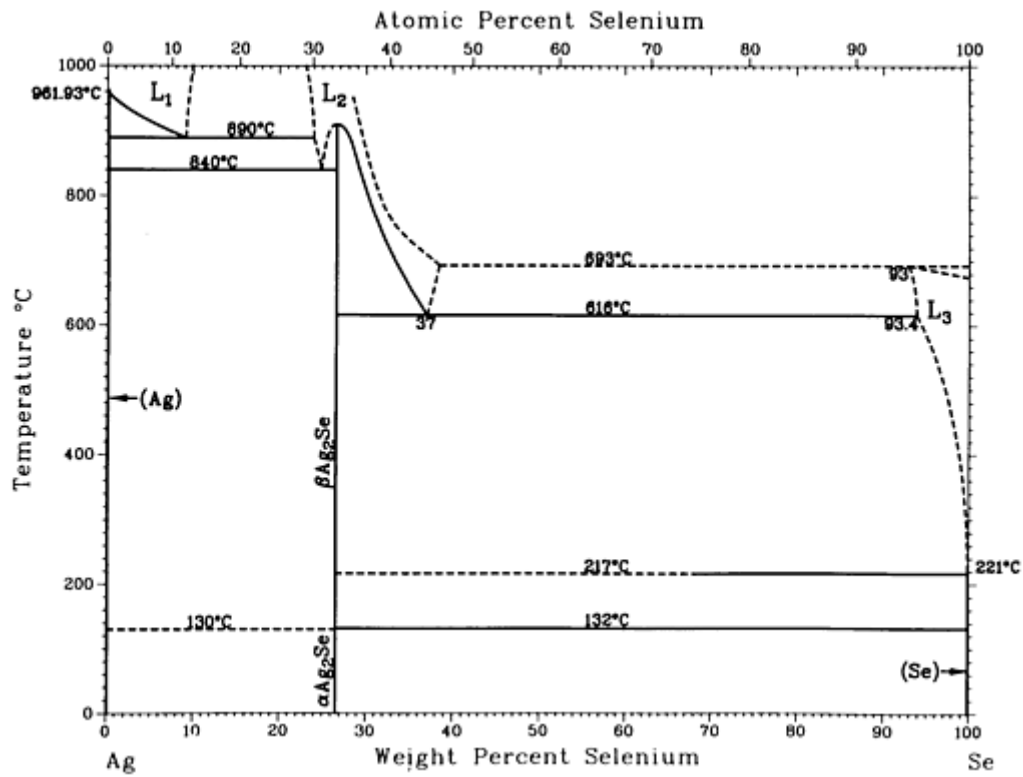

Ag-Se phase diagram

Ag-Se crystallographic data

Phase	Composition, wt% Se	Pearson symbol	Space group
(Ag)	0	<i>cF4</i>	<i>Fm</i> $\bar{3}m$
β Ag ₂ Se	26.8	<i>cI</i> *	...
α Ag ₂ Se	26.8	<i>o</i> **	...
(Se)	100	<i>hP3</i>	<i>P3</i> ₁ 21

Ag-Si (Silver - Silicon)

R.W. Olesinski and G.J. Abbaschian, 1989

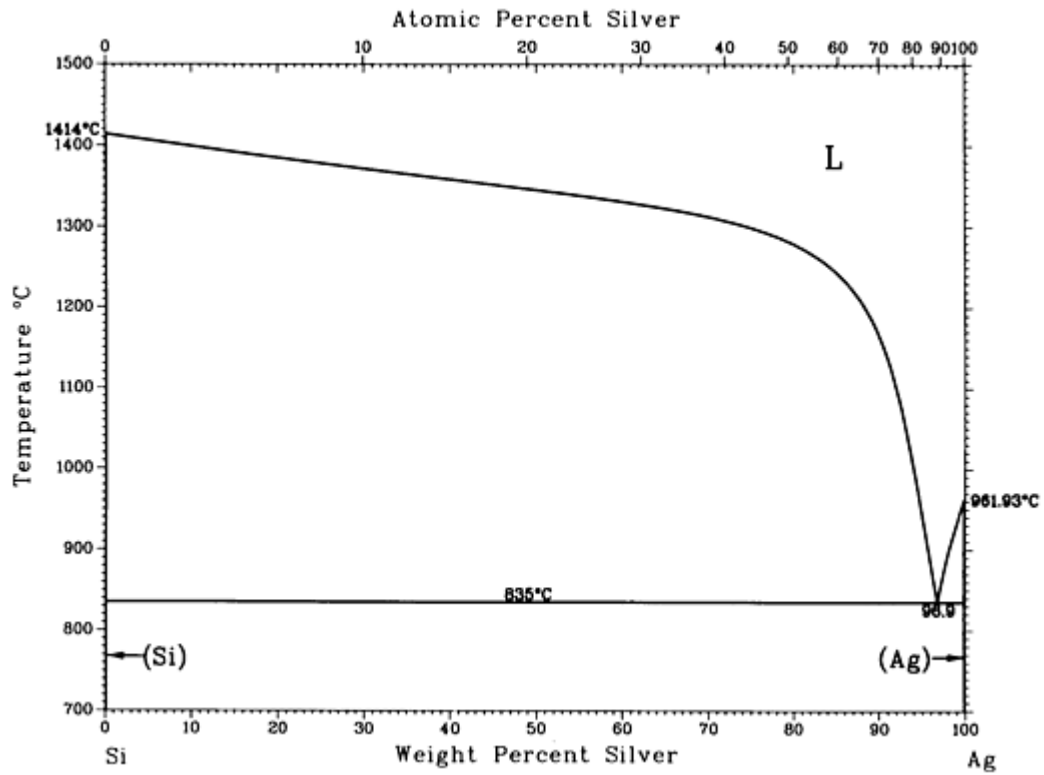

Ag-Si phase diagram

Ag-Si crystallographic data

Phase	Composition, wt% Ag	Pearson symbol	Space group
(Si)	0	<i>cF8</i>	<i>Fd$\bar{3}m$</i>
SiII(HP)	0	<i>tI4</i>	<i>I4₁/amd</i>
(Ag)	100	<i>cF4</i>	<i>Fm$\bar{3}m$</i>
Metastable phases			
SiAg ₂	~90	(a)	...
β	92 to 99	(b)	...

(a) Orthorhombic.

(b) cph

Ag-Sm (Silver - Samarium)

K.A. Gschneidner, Jr. and F.W. Calderwood, 1985

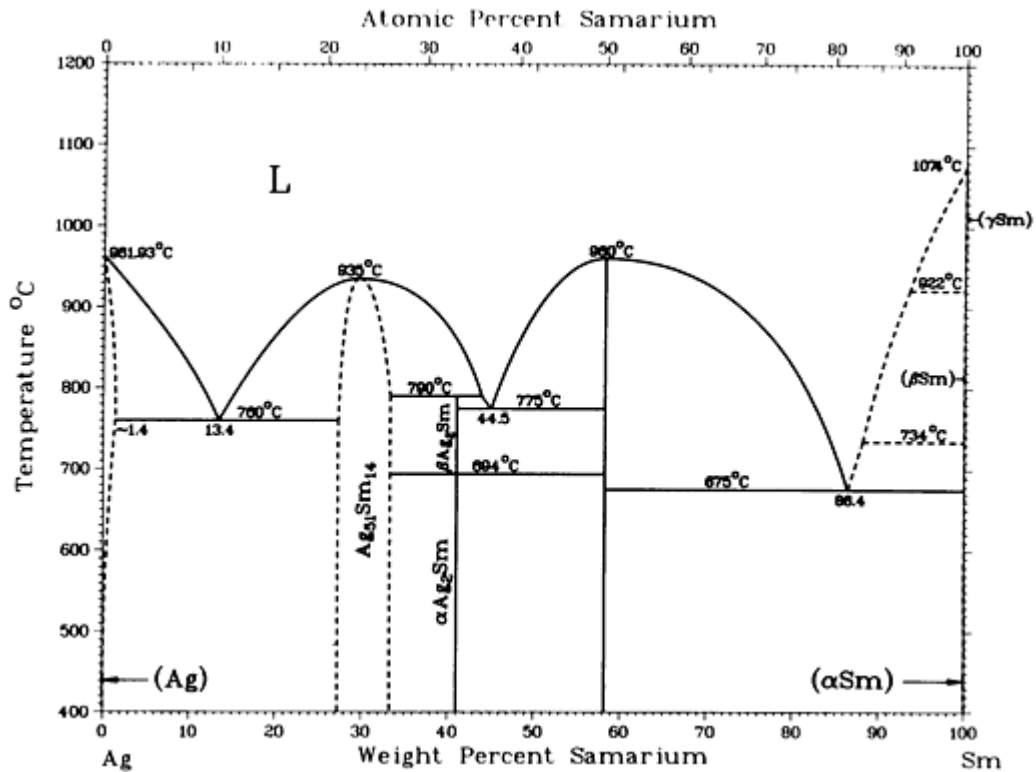

Ag-Sm phase diagram

Ag-Sm crystallographic data

Phase	Composition, wt% Sm	Pearson symbol	Space group
(Ag)	0 to ~1.4	<i>cF4</i>	<i>Fm</i> $\bar{3}m$
Ag ₅₁ Sm ₁₄	~27.6 to 32.3	<i>hP65</i>	<i>P6/m</i>
βAg ₂ Sm	41.0	<i>hP?</i>	<i>P6₃(?)</i>
αAg ₂ Sm	41.0
AgSm	58.2	<i>cP2</i>	<i>Pm</i> $\bar{3}m$

(γ Sm)	100
(β Sm)	100	$hP2$	$P6_3/mmc$
(α Sm)	100	$hR3$	$R\bar{3}m$

Ag-Sn (Silver - Tin)

I. Karakaya and W.T. Thompson, 1987

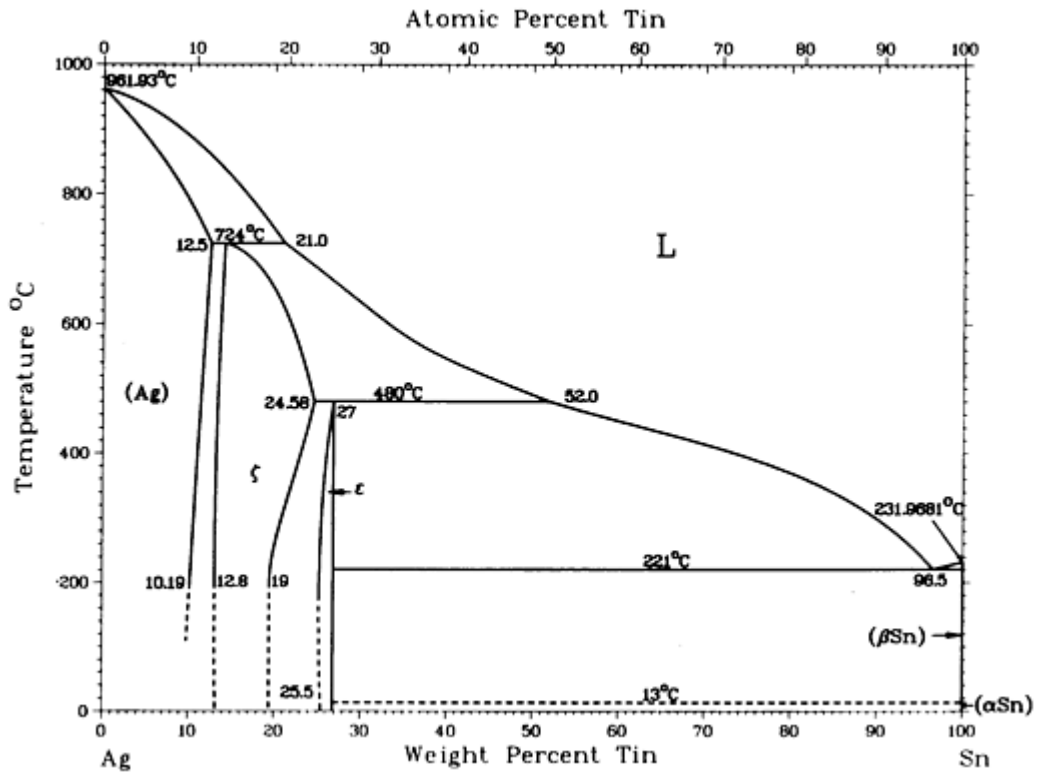

Ag-Sn phase diagram

Ag-Sn crystallographic data

Phase	Composition, wt% Sn	Pearson symbol	Space group
(Ag)	0 to 12.5	$cF4$	$Fm\bar{3}m$
ζ	12.8 to 24.58	$hP2$	$P6_3/mmc$
ϵ	25.5 to 27	$oP8$	$Pm\bar{m}n$

(β Sn)	99.92 to 100	<i>tI4</i>	<i>I4₁/amd</i>
(α Sn)	100	<i>cF8</i>	<i>Fd$\bar{3}m$</i>

Ag-Sr (Silver - Strontium)

M.R. Baren, 1990

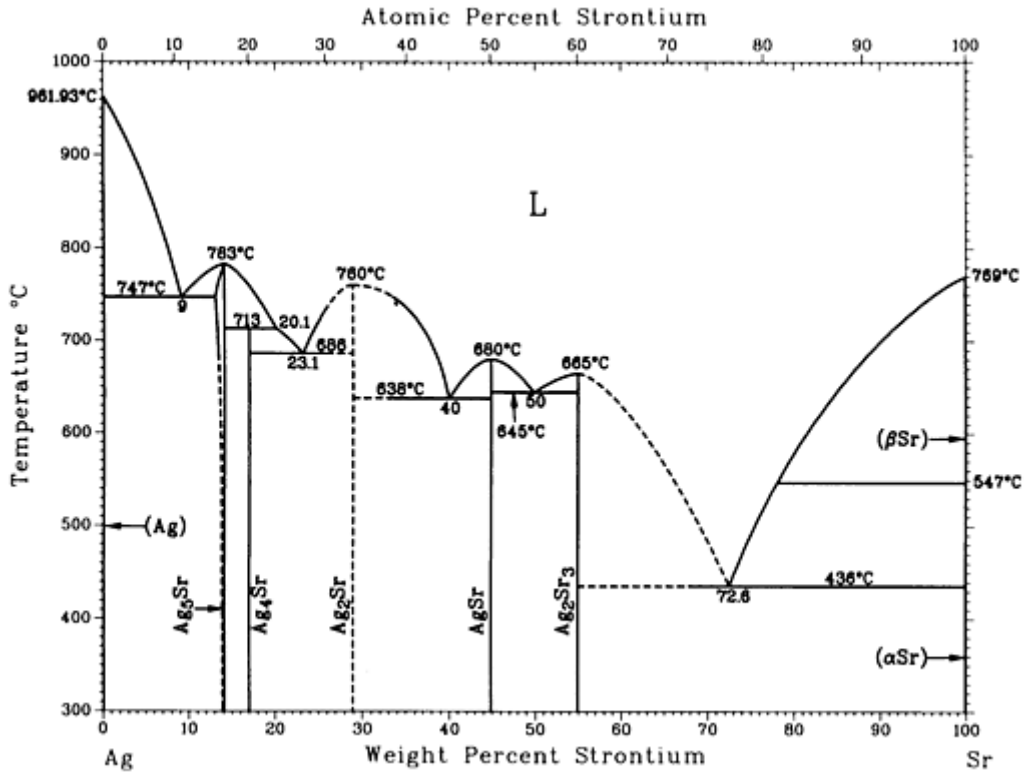

Ag-Sr phase diagram

Ag-Sr crystallographic data

Phase	Composition, wt% Sr	Pearson symbol	Space group
(Ag)	0	<i>cF4</i>	<i>Fm$\bar{3}m$</i>
Ag ₅ Sr	12.9 to 14.1	<i>hP6</i>	<i>P6/mmm</i>
Ag ₄ Sr	17
Ag ₂ Sr	28.9	...	<i>Imma</i>

AgSr	44.8	<i>oP8</i>	<i>Pnma</i>
Ag ₂ Sr ₃	55	<i>hR45</i>	<i>R$\bar{3}$</i>
Ag ₃ Sr ₇ ^(a)	65	<i>hP20</i>	<i>P6₃mc</i>
(α Sr)	100	<i>cF4</i>	<i>Fm$\bar{3}m$</i>
(β Sr) ^(b)	100	<i>cI2</i>	<i>Im$\bar{3}m$</i>

(a) Not shown on diagram; probably a peritectic reaction.

(b) Above 547 °C

Ag-Te (Silver - Tellurium)

I. Karakaya and W.T. Thompson, 1991

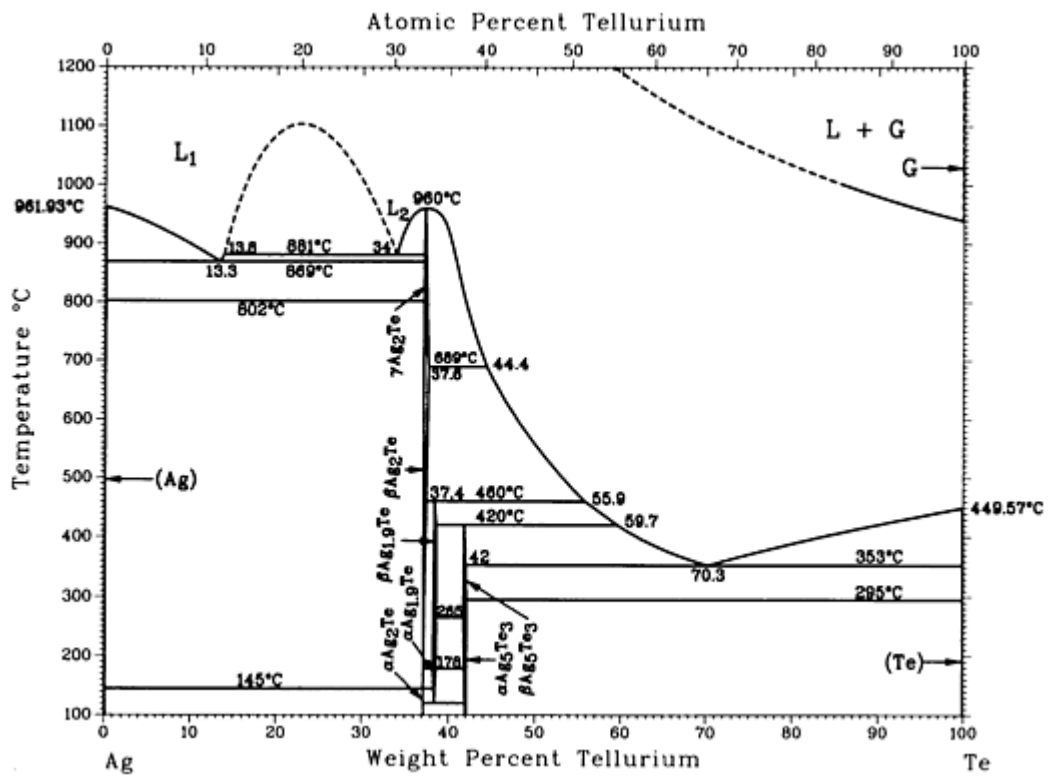

Ag-Te phase diagram

Ag-Te crystallographic data

Phase	Composition ^(a) , wt% Te	Pearson symbol	Space group
(Ag)	0	<i>cF4</i>	<i>Fm$\bar{3}m$</i>
$\alpha\text{Ag}_2\text{Te}$	37.1	<i>mP12</i>	<i>P21/c</i>
$\beta\text{Ag}_2\text{Te}^{(b)}$	37.1 to 37.6	<i>cF12</i>	...
$\gamma\text{Ag}_2\text{Te}^{(c)}$	37.1 to 37.6
$\alpha\text{Ag}_{1.9}\text{Te}$	38.23 to 38.6
$\alpha\text{Ag}_5\text{Te}_3^{(d)}$	41.67 to 42.06	<i>hP55</i>	<i>P6/mmm</i>
$\text{AgTe}^{(e)}$...	<i>oP32</i>	...
$\text{Ag}_2\text{TeII}^{(f)}$
$\text{Ag}_2\text{TeIII}^{(g)}$
$\text{AgTe}_4\text{-AgTe}_{2.33}^{(h)}$
$\text{AgTe}_3^{(i)}$...	<i>hR12</i>	<i>R$\bar{3}m$</i>
(Te)	100	<i>hP3</i>	<i>P3$_1$21</i>

(a) Compositions are taken from the assessed diagram.

(b) fcc structure.

(c) bcc structure.

(d) Referred to as Ag_7Te_4 by [Pearson2] 13.

(e) Mineral empressite (regarded as metastable).

(f) Tetragonal structure stable at pressures 2200 to 2500 kPa. Lattice parameters were measured at 2400 kPa pressure.

(g) Tetragonal structure stable at pressures over 2500 kPa. Lattice parameters were measured at 4000 kPa pressure.

(h) Simple cubic structure (metastable).

(i) Stable at temperatures higher than 358 °C and pressures over 4.0 GPa

Reference cited in this section

13. [Pearson2]: W.B. Pearson, *Handbook of Lattice Spacings and Structures of Metals and Alloys*, Vol. 2, Pergamon Press, New York (1967)

Ag-Ti (Silver - Titanium)

J.L. Murray and K.J. Bhansali, 1987

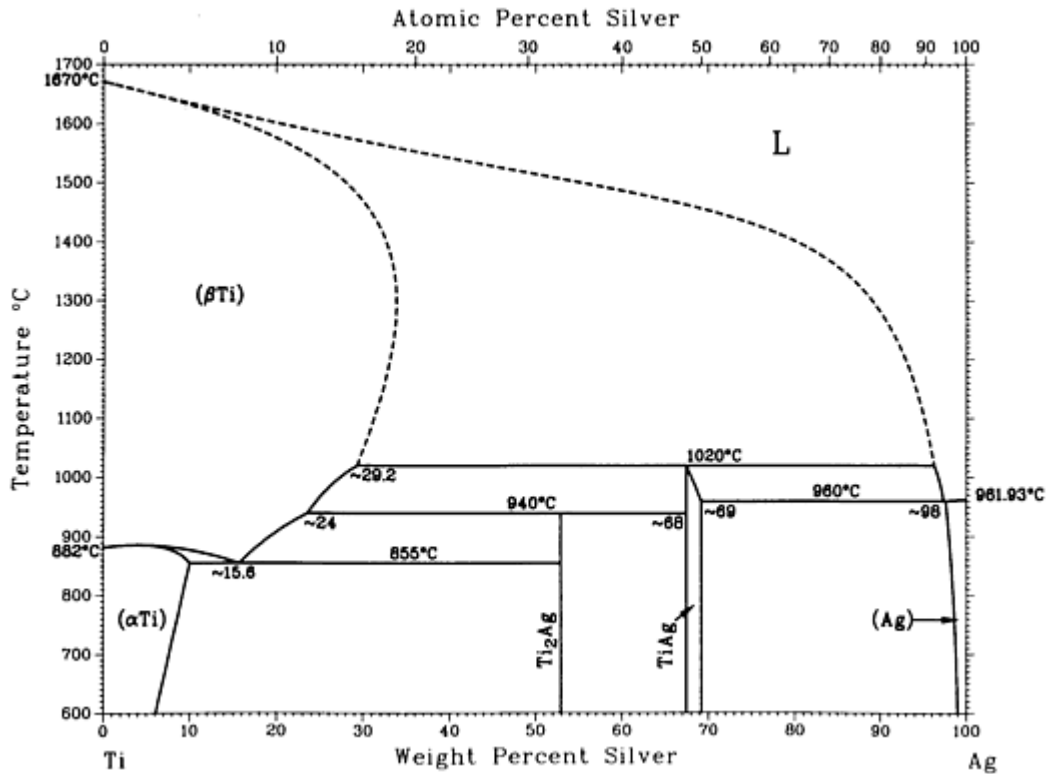

Ag-Ti phase diagram

Ag-Ti crystallographic data

Phase	Composition, wt% Ag	Pearson symbol	Space group
(αTi)	0 to ~1.0	<i>hP2</i>	<i>P6₃/mmc</i>

(βTi)	0 to 29.2	<i>cI2</i>	<i>Im</i> $\bar{3}m$
Ti ₂ Ag	52.9	<i>tI6</i>	<i>I4/mmm</i>
TiAg	~68 to ~69	<i>tP4</i>	<i>P4/nmm</i>
(Ag)	~98 to 100	<i>cF4</i>	<i>Fm</i> $\bar{3}m$

Ag-Tl (Silver - Thallium)

M.R. Baren, 1989

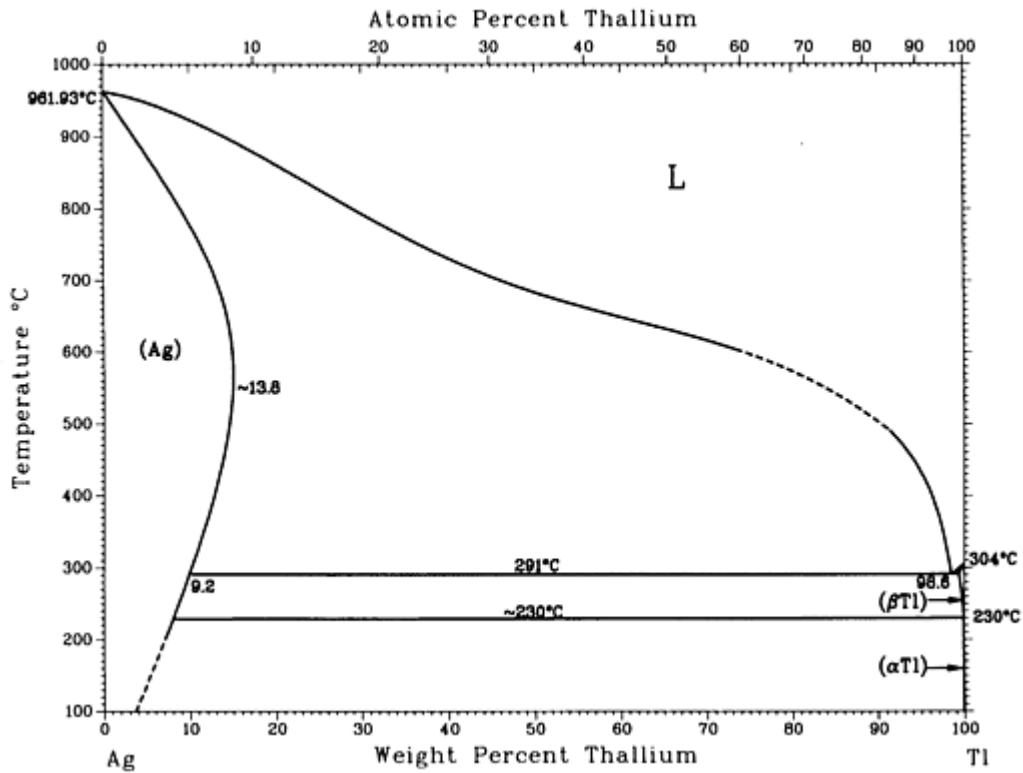

Ag-Tl phase diagram

Ag-Tl crystallographic data

Phase	Composition, wt% Tl	Pearson symbol	Space group
(Ag)	0 to ~13.8	<i>cF4</i>	<i>Fm</i> $\bar{3}m$
(αTl)	100	<i>hP2</i>	<i>P6₃/mmc</i>

$(\beta\text{Tl})^{(a)}$? to 100	$cI2$	$Im\bar{3}m$
--------------------------	----------	-------	--------------

(a) Above 230 °C

Ag-Y (Silver - Yttrium)

K.A. Gschneidner, Jr. and F.W. Calderwood, 1983

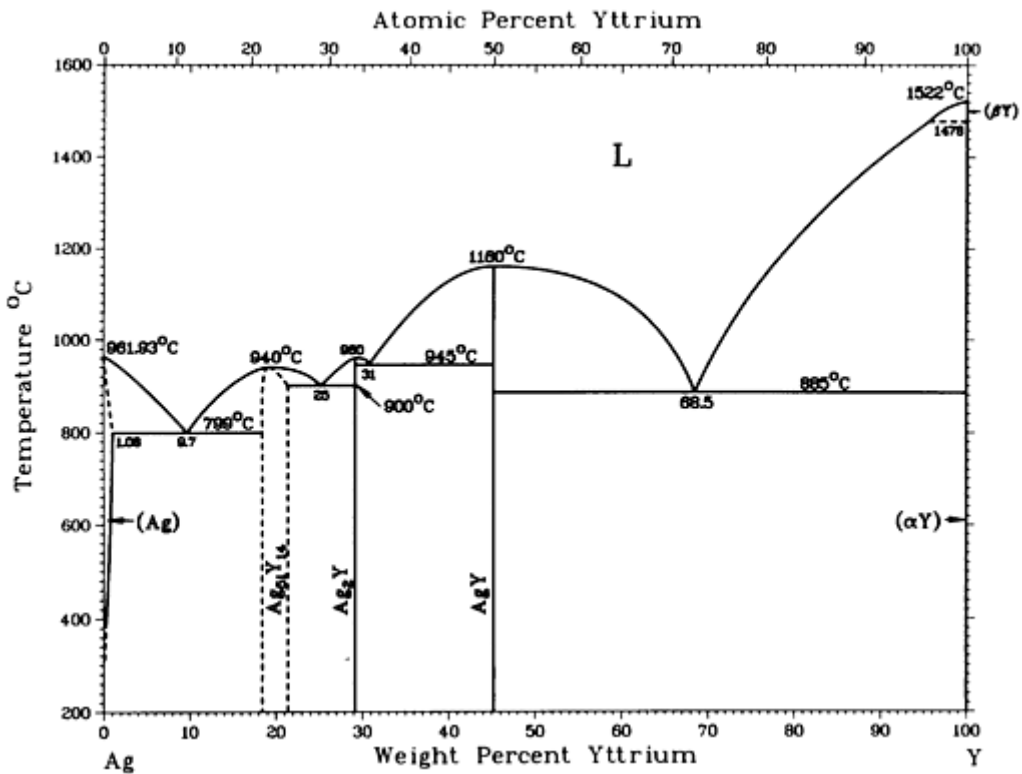

Ag-Y phase diagram

Ag-Y crystallographic data

Phase	Composition, wt% Y	Pearson symbol	Space group
(Ag)	0 to 1.08	$cF4$	$Fm\bar{3}m$
Ag ₅₁ Y ₁₄	18.4	$hP65$...
Ag ₂ Y	29.2	$tI6$	$I4/mmm$
AgY	45.1	$cP2$	$Pm\bar{3}m$

(β Y)	100	$cI2$	$Im\bar{3}m$
(α Y)	100	$hP2$	$P6_3/mmc$

Ag-Yb (Silver - Ytterbium)

K.A. Gschneidner, Jr. and F.W. Calderwood, 1985

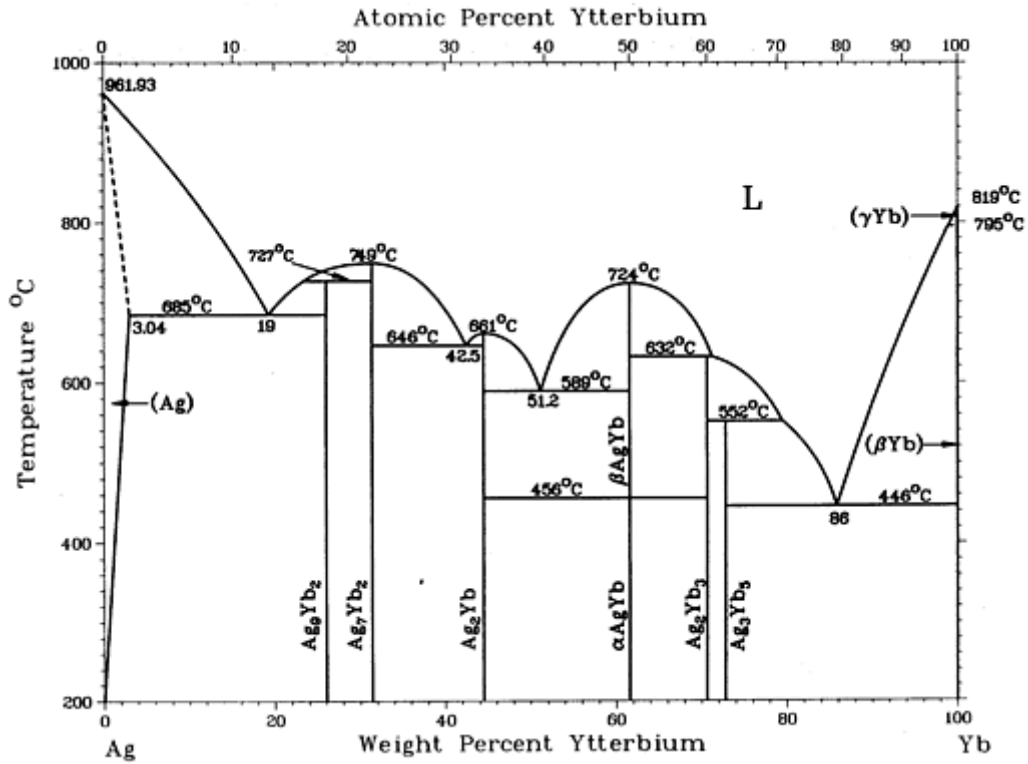

Ag-Yb phase diagram

Ag-Yb crystallographic data

Phase	Composition, wt% Yb	Pearson symbol	Space group
(Ag)	0 to 3.04	$cF4$	$Fm\bar{3}m$
Ag_9Yb_2
Ag_7Yb_2	31.4	$hP18$...
Ag_2Yb	44.5	$oI2$	$Imma$

βAgYb	61.6	$cP2$	$Pm\bar{3}m$
αAgYb	61.6	$oP8$	$Pnma$
Ag_2Yb_3	70.6	$tP10$	$P4/mbm$
Ag_3Yb_5	72.8	$tI32$	$I4/mcm$
(γYb)	100	$cI2$	$Im\bar{3}m$
(βYb)	100	$cF4$	$Fm\bar{3}m$
(αYb)	100	$hP2$	$P6_3/mmc$

Ag-Zn (Silver - Zinc)

K.W. Andrews, H.E. Davies, W. Hume-Rothery, and C.R. Oswin, 1940

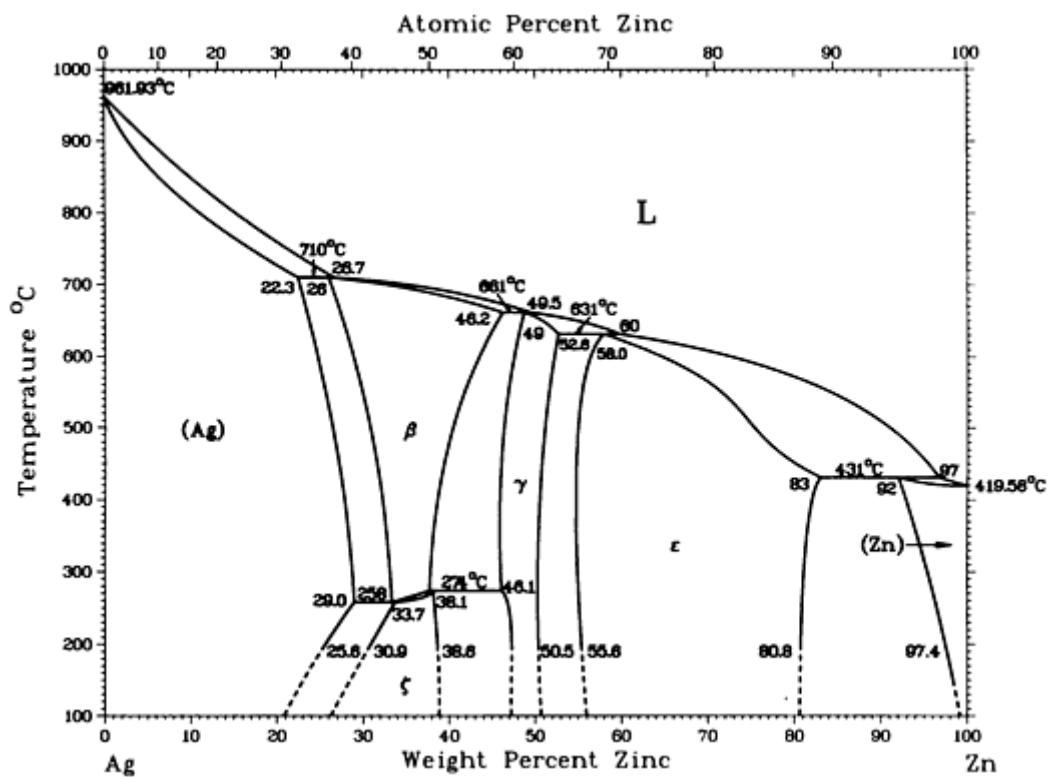

Ag-Zn phase diagram

Ag-Zn crystallographic data

Phase	Composition, wt% Zn	Pearson symbol	Space group
(Ag)	0 to 29.0	$cF4$	$Fm\bar{3}m$
$\zeta(\text{AgZn})$	26 to ~38.8	(a)	...
$\beta(\text{AgZn})$	26 to 46.2	$cI2$	$Im\bar{3}m$
$\gamma(\text{Ag}_5\text{Zn}_8)$	46.1 to 52.6	$cI52$	$I\bar{3}m$
ε	~54.3 to 83	$hP2$	$P6_3/mmc$
(Zn)	92 to 100	$hP2$	$P6_3/mmc$

(a) Ordered hexagonal

Ag-Zr (Silver - Zirconium)

I. Karakaya and W.T. Thompson, 1992

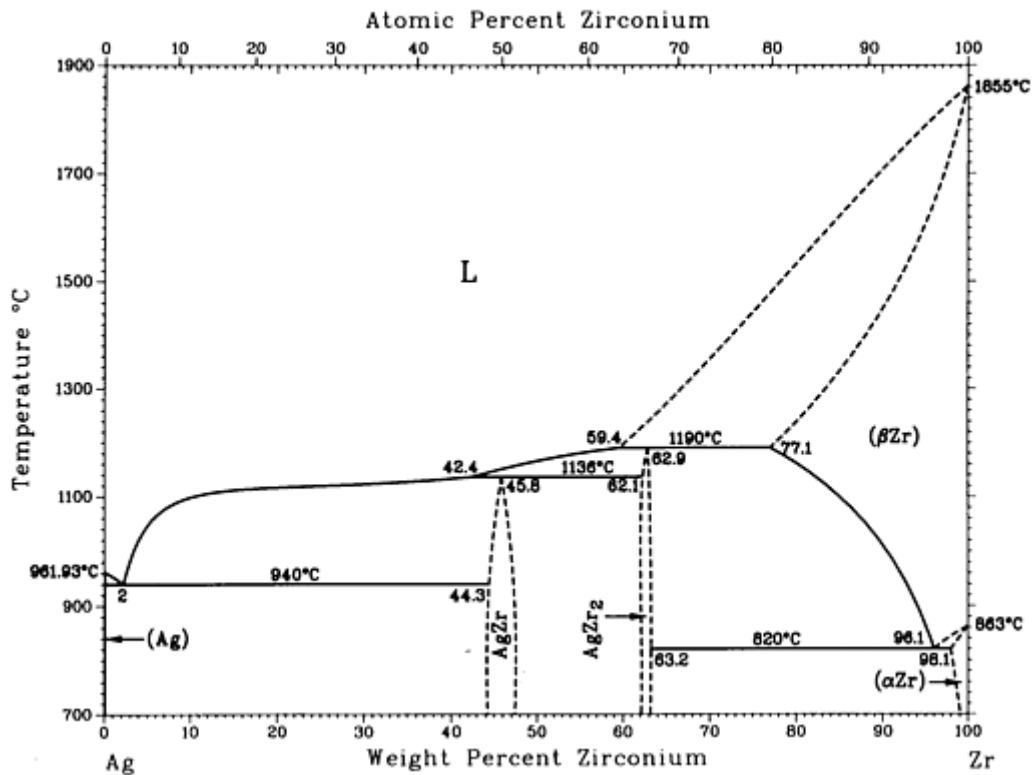

Ag-Zr phase diagram

Ag-Zr crystallographic data

Phase	Composition, wt% Zr	Pearson symbol	Space group
(Ag)	0 to 0.08	<i>cF4</i>	<i>Fm</i> $\bar{3}m$
AgZr	~45.8	<i>tP4</i>	<i>P4/nmm</i>
AgZr ₂	~62.9	<i>tI6</i>	<i>I4/mmm</i>
(α Zr)	98.1 to 100	<i>hP2</i>	<i>P6₃/mmc</i>
(β Zr)	100	<i>cI2</i>	<i>Im</i> $\bar{3}m$

Al (Aluminum) Binary Alloy Phase Diagrams

Introduction

THIS ARTICLE includes systems where aluminum is the first-named element in the binary pair. Additional binary systems that include aluminum are provided in the following location in this Volume:

- [“Ag-Al \(Silver - Aluminum\)”](#) in the article [“Ag \(Silver\) Binary Alloy Phase Diagrams.”](#)

Al-As (Aluminum - Arsenic)

A. J. McAlister, 1984

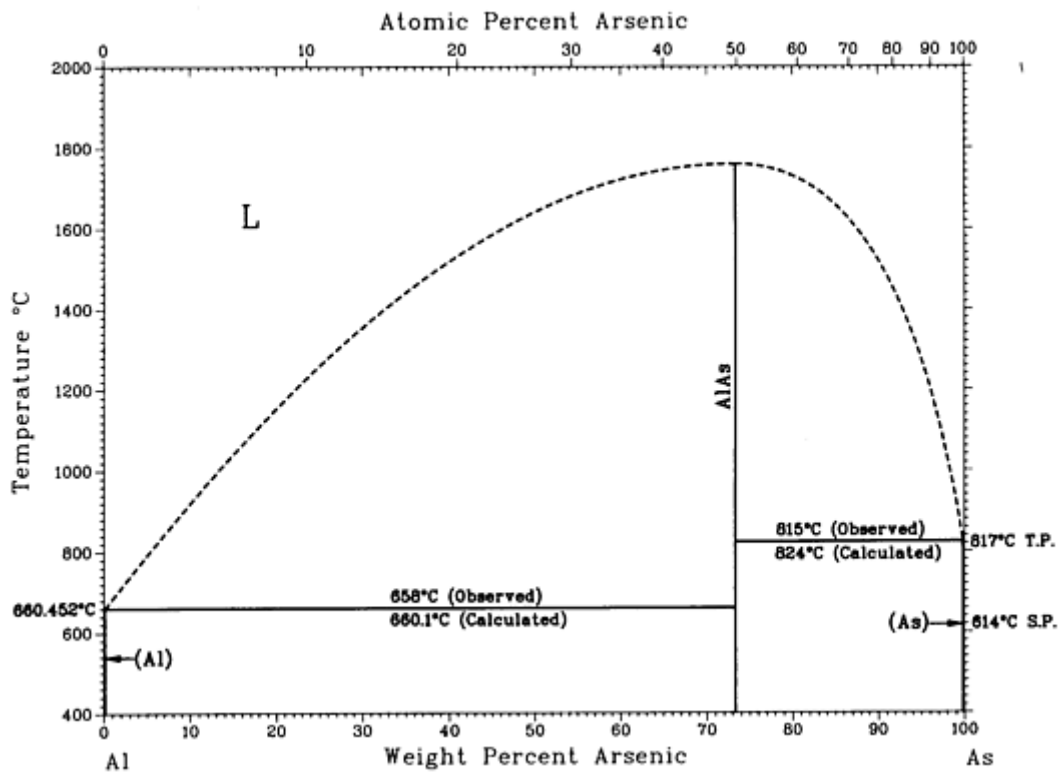

Al-As phase diagram

Al-As crystallographic data

Phase	Composition, wt% As	Pearson symbol	Space group
(Al)	0	$cF4$	$Fm\bar{3}m$
AlAs	73.5	$cF8$	$F\bar{4}3m$
(As)	100	$hR2$	$R\bar{3}m$

Al-Au (Aluminum - Gold)

H. Okamoto, 1991

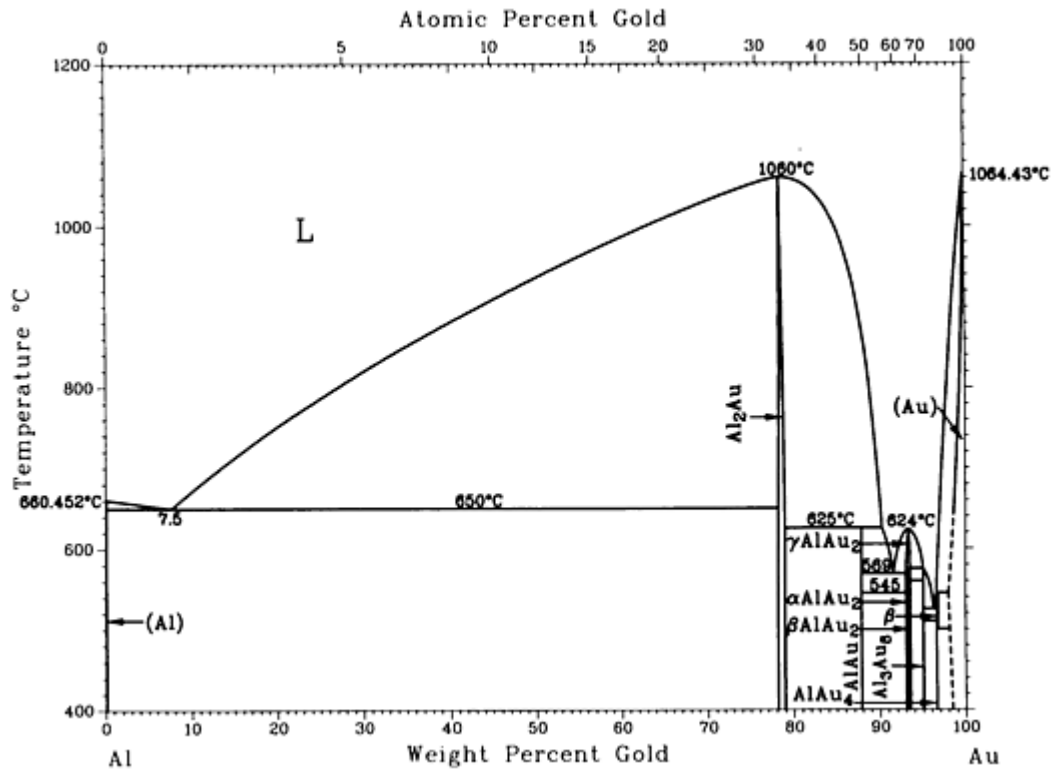

Al-Au phase diagram

Al-Au crystallographic data

Phase	Composition, wt% Au	Pearson symbol	Space group
(Al)	0 to 0.44	<i>cF4</i>	<i>Fm</i> $\bar{3}m$
Al ₂ Au	78 to 79	<i>cF12</i>	<i>Fm</i> $\bar{3}m$
AlAu	88	<i>mP28</i>	<i>P2</i> ₁ / <i>m</i>
γAlAu ₂	93 to 93.6	<i>tI6</i>	<i>I4/mmm</i>
βAlAu ₂	93.2 to 93.4	<i>oP32</i>	<i>Pn</i> <i>mn</i>
αAlAu ₂	93.5 to 93.6	<i>oP12</i>	<i>Pn</i> <i>ma</i>
Al ₃ Au ₈	95.1	<i>hR132</i>	<i>R</i> $\bar{3}c$

β	96.7 to 96.9	$cI2$	$Im\bar{3}m$
$AlAu_4$	96.7	$cP20$	$P2_13$
(Au)	98 to 100	$cF4$	$Fm\bar{3}m$

Al-Ba (Aluminum - Barium)

H. Okamoto, 1992

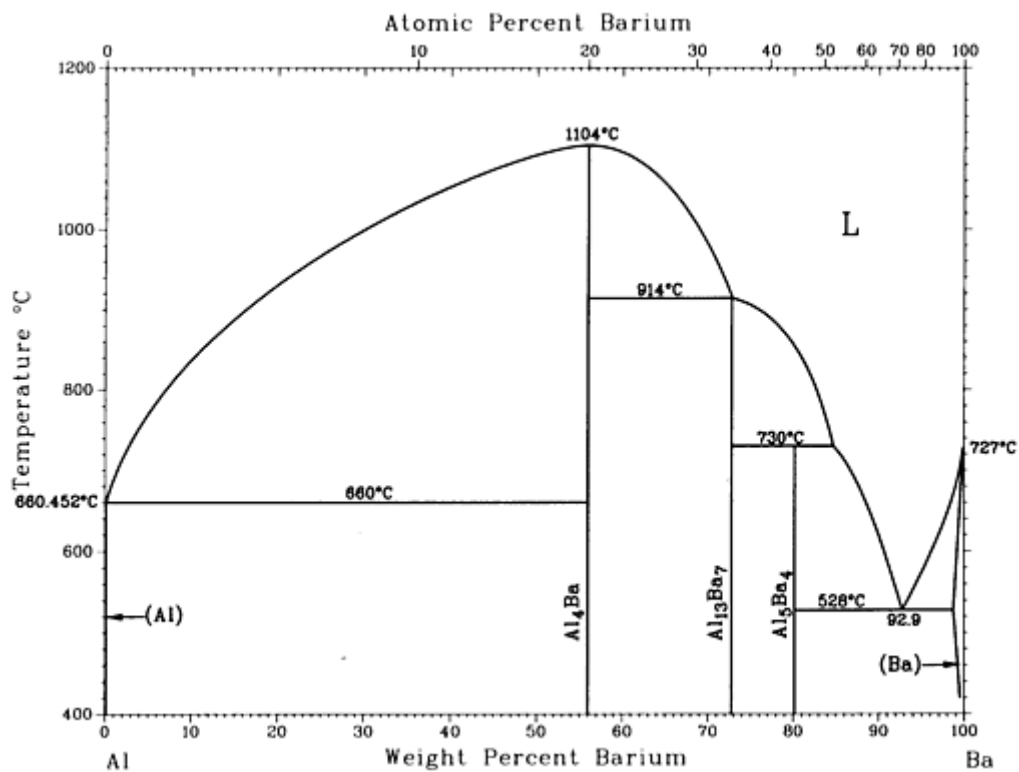

Al-Ba phase diagram

Al-Ba crystallographic data

Phase	Composition, wt% Ba	Pearson symbol	Space group
(Al)	0	$cF4$	$Fm\bar{3}m$
Al_4Ba	56	$tI10$	$I4/mmm$
$Al_{13}Ba_7$	73	$hP20$	$P\bar{3}m1$

Al_5Ba_4	80.3	$hP18$	$P6_3/mmc$
(Ba)	100	$cI2$	$Im\bar{3}m$
Other phases			
Al_5Ba_3	75.3	$hP16$	$P6_3/mmc$

Al-Be (Aluminum - Beryllium)

J. L. Murray and D. J. Kahan, 1988

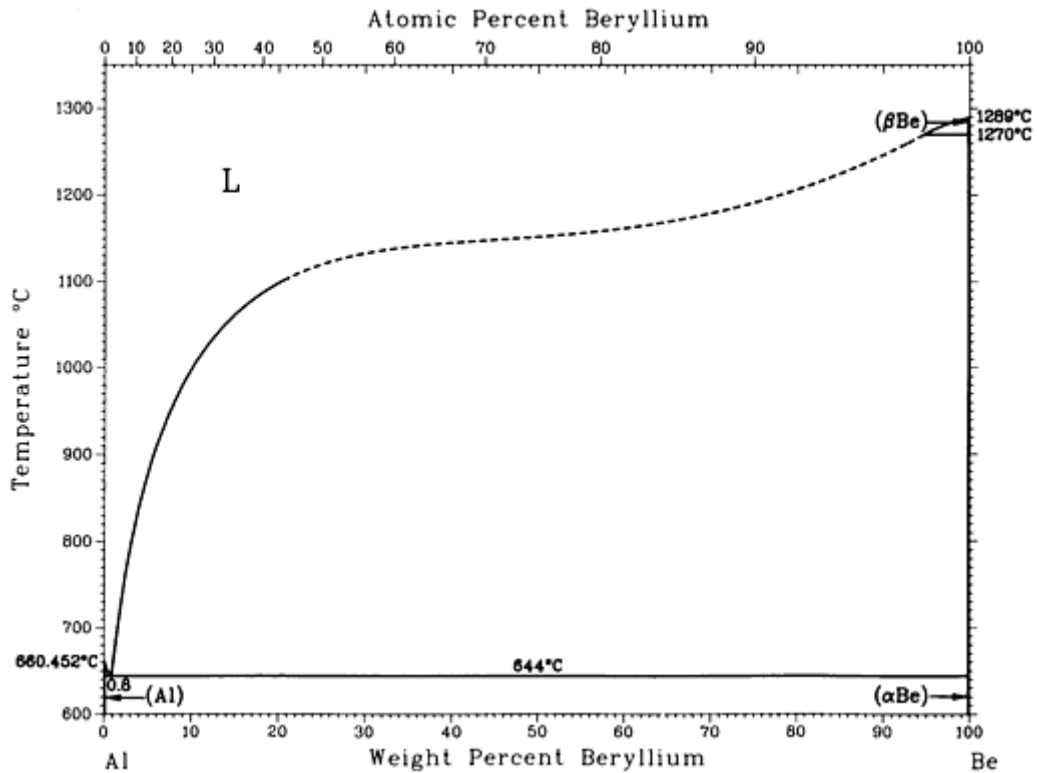

Al-Be (calculated) phase diagram

Al-Be crystallographic data

Phase	Composition, wt% Be	Pearson symbol	Space group
(Al)	0 to 0.10	$cF4$	$Fm\bar{3}m$
(βBe)	99.979 to 100	$cI2$	$Im\bar{3}m$

(α Be)	99.979 to 100	$hP2$	$P6_3/mmc$
----------------	---------------	-------	------------

Al-Bi (Aluminum - Bismuth)

A. J. McAllister, 1984

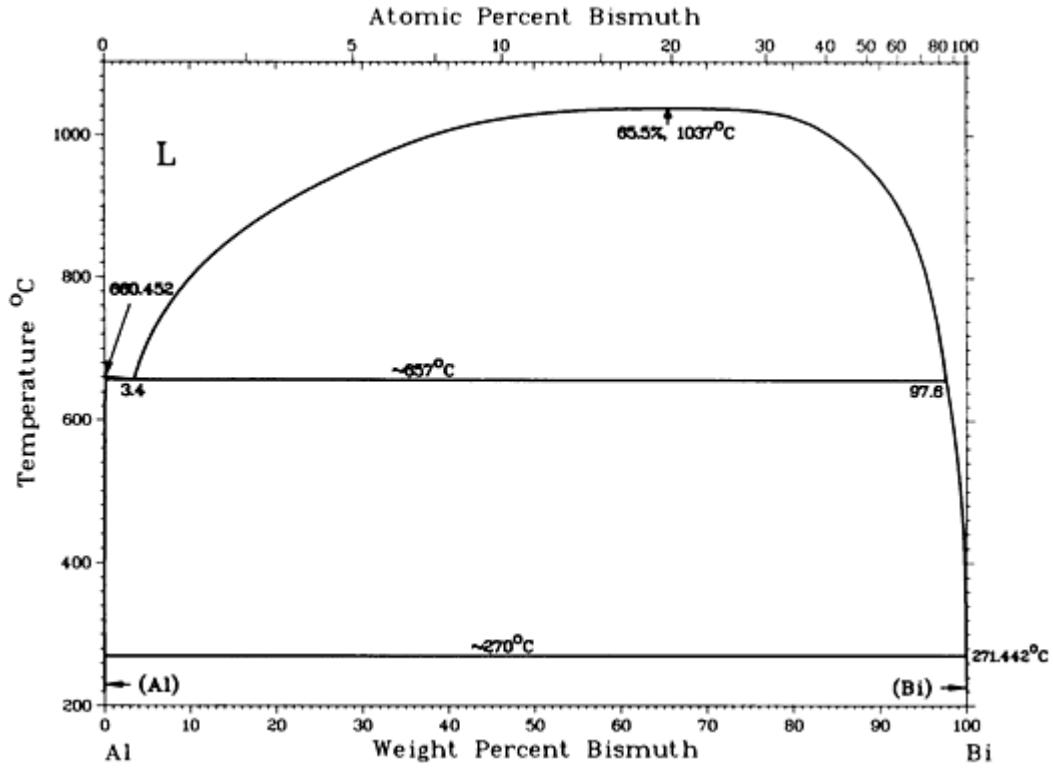

Al-Bi phase diagram

Al-Bi crystallographic data

Phase	Composition, wt% Bi	Pearson symbol	Space group
(Al)	0 to ~0.23	$cF4$	$Fm\bar{3}m$
(Bi)	100	$hR2$	$R\bar{3}m$

Al-Ca (Aluminum - Calcium)

V. P. Itkin, C. B. Alcock, P. J. van Ekeren, and H. A. J. Oonk, 1988

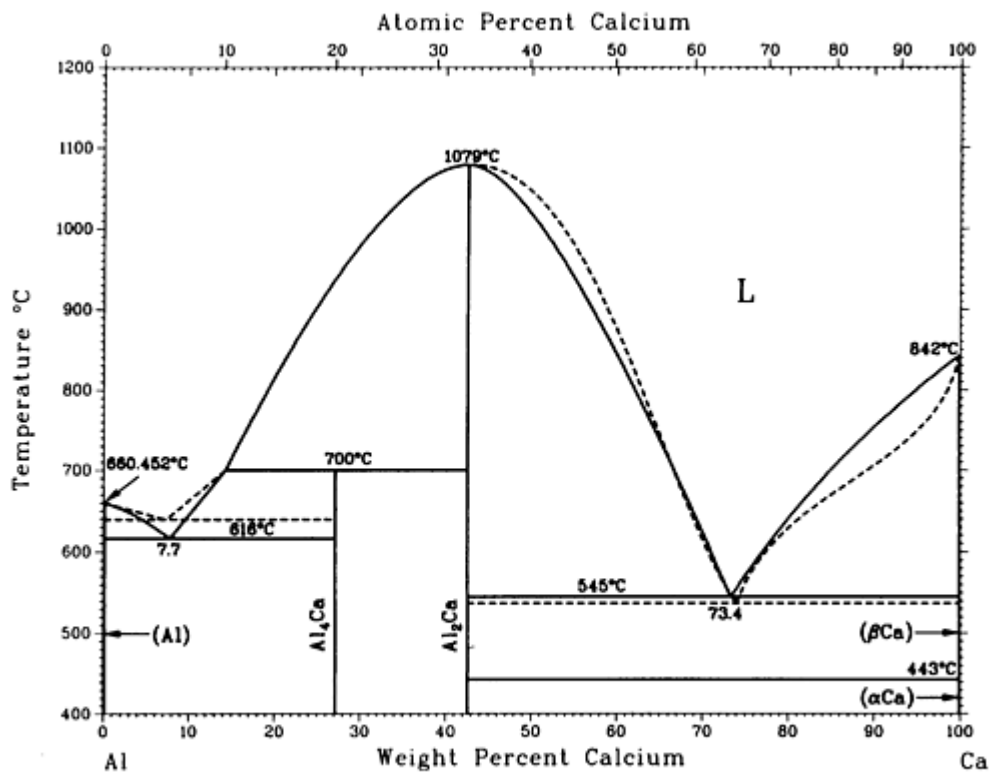

Dashed lines = calculated.

Al-Ca phase diagram

Al-Ca crystallographic data

Phase	Composition, wt% Ca	Pearson symbol	Space group
(Al)	0	<i>cF4</i>	<i>Fm</i> $\bar{3}m$
Al ₄ Ca	27	<i>tI10</i>	<i>I4/mmm</i>
Al ₂ Ca	42.6	<i>cF24</i>	<i>Fd</i> $\bar{3}m$
(αCa)	100	<i>cF4</i>	<i>Fm</i> $\bar{3}m$
(βCa)	100	<i>cI2</i>	<i>Im</i> $\bar{3}m$

Al-Cd (Aluminum - Cadmium)

A. J. McAlister, 1982

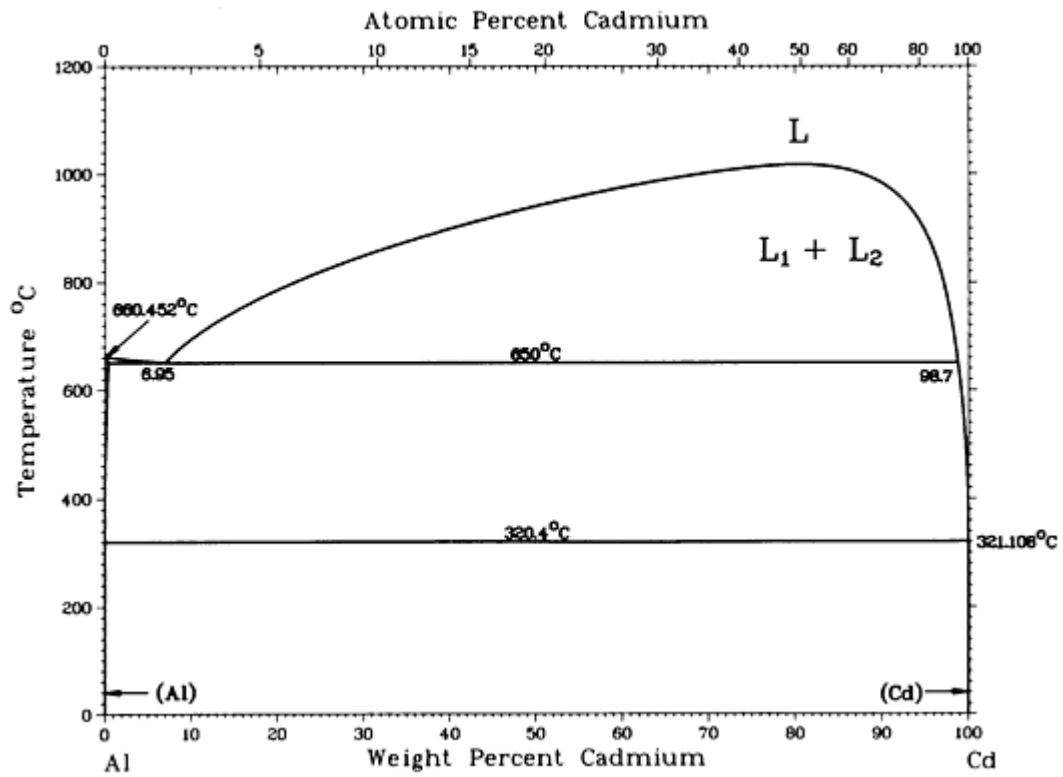

Al-Cd phase diagram

Al-Cd crystallographic data

Phase	Composition, wt% Cd	Pearson symbol	Space group
(Al)	0	<i>cF4</i>	<i>Fm</i> $\bar{3}m$
(Cd)	100	<i>hP2</i>	<i>P6₃/mmc</i>

Al-Ce (Aluminum - Cerium)

K.A. Gschneidner, Jr. and F.W. Calderwood, 1988

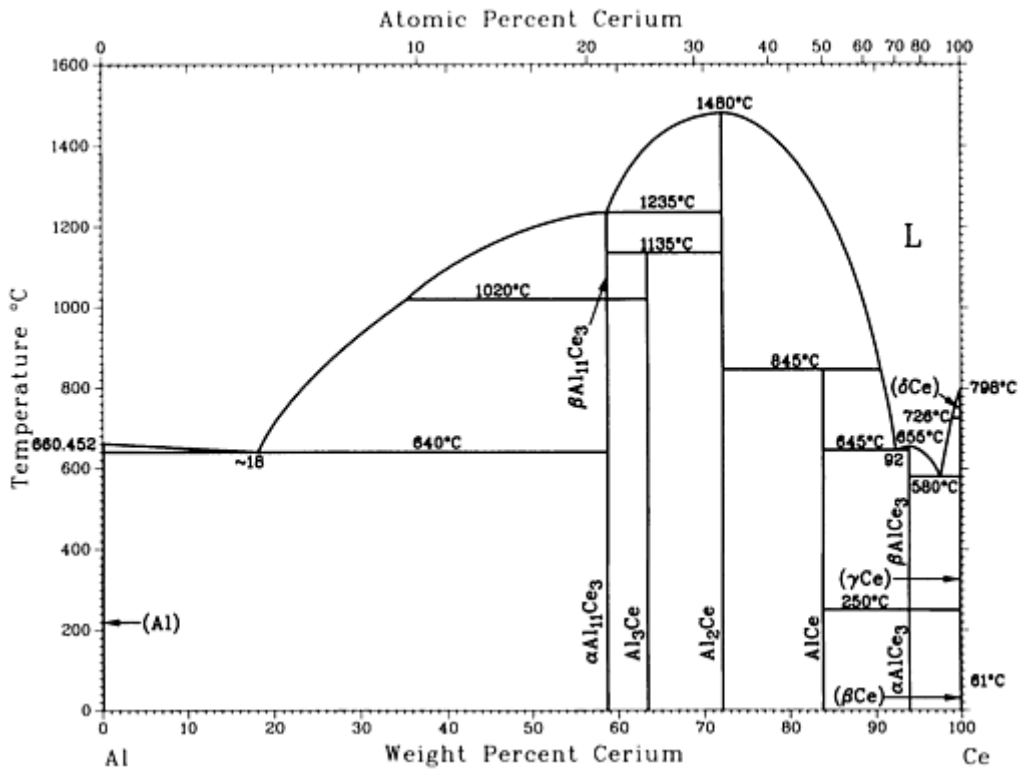

Al-Ce phase diagram

Al-Ce crystallographic data

Phase	Composition, wt% Ce	Pearson symbol	Space group
(Al)	0	<i>cF4</i>	<i>Fm</i> $\bar{3}m$
αAl ₁₁ Ce ₃	58.6	<i>oI28</i>	<i>Immm</i>
βAl ₁₁ Ce ₃	58.6	<i>tI10</i>	<i>I₄/mmm</i>
Al ₃ Ce	63	<i>hP8</i>	<i>P6₃/mmc</i>
Al ₂ Ce	72.2	<i>cF24</i>	<i>Fd</i> $\bar{3}m$
AlCe	83.9	<i>oC16</i>	<i>Cmc2</i> or <i>Cmcm</i>
αAlCe ₃	94	<i>hP8</i>	<i>P6₃/mmc</i>

βAlCe_3	94	$cP4$	$Pm\bar{3}m$
(αCe)	100	$cF4$	$Fm\bar{3}m$
(βCe)	100	$hP4$	$P6_3/mmc$
(γCe)	100	$cF4$	$Fm\bar{3}m$
(δCe)	100	$cI2$	$Im\bar{3}m$

Al-Co (Aluminum - Cobalt)

A.J. McAlister, 1989

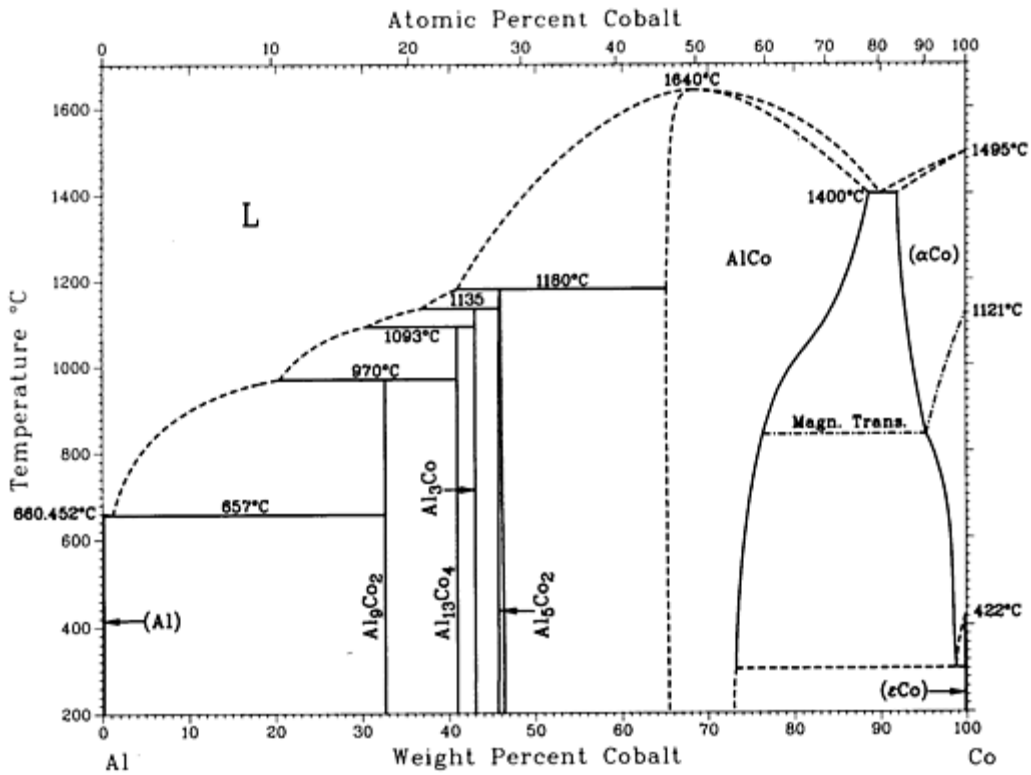

Al-Co phase diagram

Al-Co crystallographic data

Phase	Composition, wt% Co	Pearson symbol	Space group
(Al)	~0	$cF4$	$Fm\bar{3}m$

Al_9Co_2	32.6	<i>mP22</i>	<i>P2_{1/a}</i>
$\text{Al}_{13}\text{Co}_4$	40.2	<i>mC93</i>	<i>Cm</i>
Al_3Co	42.9	...	(a)
Al_5Co_2	46.7	<i>hP28</i>	<i>P6_{3/mmc}</i>
AlCo	~67 to 88.9	<i>cP2</i>	<i>Pm$\bar{3}m$</i>
(ϵCo)	92 to 100	<i>hP2</i>	<i>P6_{3/mmc}</i>
(αCo)	~97 to 100	<i>cF4</i>	<i>Fm$\bar{3}m$</i>
Metastable phases			
α^{I}	95 to 98	...	(b)
α^{II}	93 to 94	...	(b)
α^{III}	92 to 93	...	(b)
α^{IV}	93 to 94	...	(b)

(a) Unknown.

(b) Hexagonal

Al-Cr (Aluminum - Chromium)

J.L. Murray, unpublished

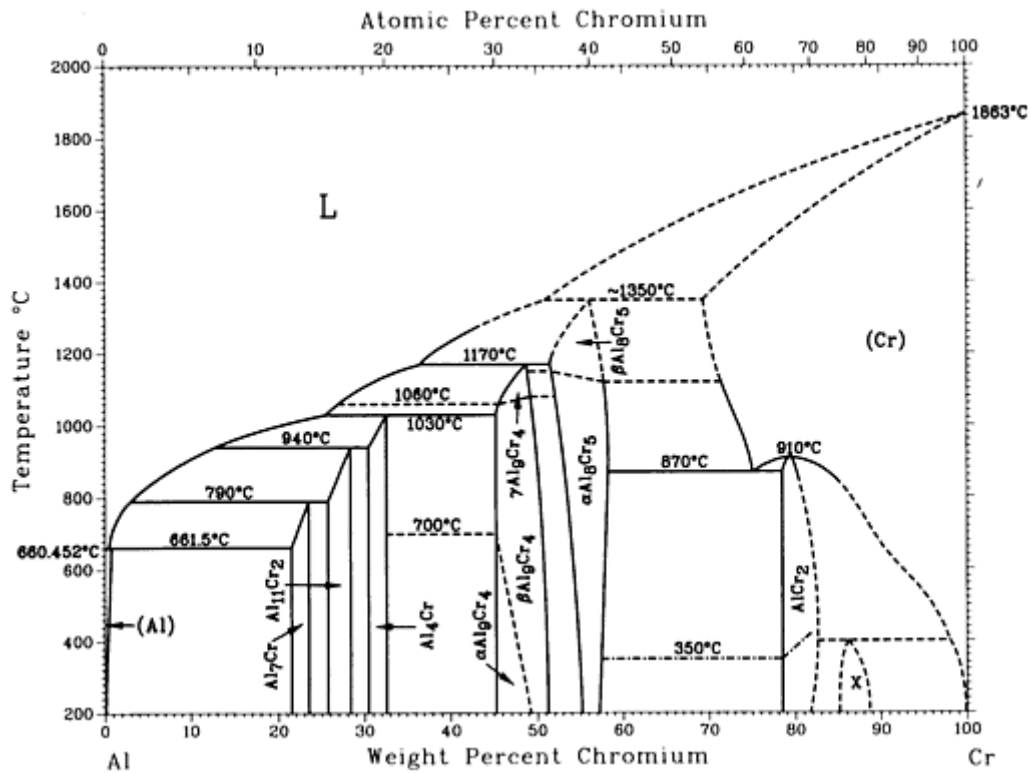

Al-Cr phase diagram

Al-Cr crystallographic data

Phase	Composition, wt% Cr	Pearson symbol	Space group
(Al)	0 to 0.71	<i>cF4</i>	$Fm\bar{3}m$
Al_7Cr ($Al_{13}Cr_2$)	~21.4 to ~23.4	<i>mC104</i>	$C2/m$
$Al_{11}Cr_2$ (Al_5Cr)	~25.7 to ~28	<i>mP48</i>	$P2$
Al_4Cr	~30.4 to ~33	<i>mP180</i>	$P2/m$
$\alpha-Al_9Cr_4$	~45 to ~49.3	<i>cI52</i>	$I\bar{4}3m$
$\alpha-Al_8Cr_5$	~51.5 to ~58	<i>hR26</i>	$R\bar{3}m$
$AlCr_2$	~78.5 to ~82.8	<i>tI6</i>	$I4/mmm$

$X^{(a)}$	~85
(Cr)	69 to 100	$cI2$	$Im\bar{3}m$

(a) It has been proposed that the structure is analogous to the ω phase seen in, for example, Zr at high pressure, but based on ordered bcc $AlCr_2$ rather than on the disordered bcc structure.

Al-Cu (Aluminum - Copper)

J.L. Murray, 1985

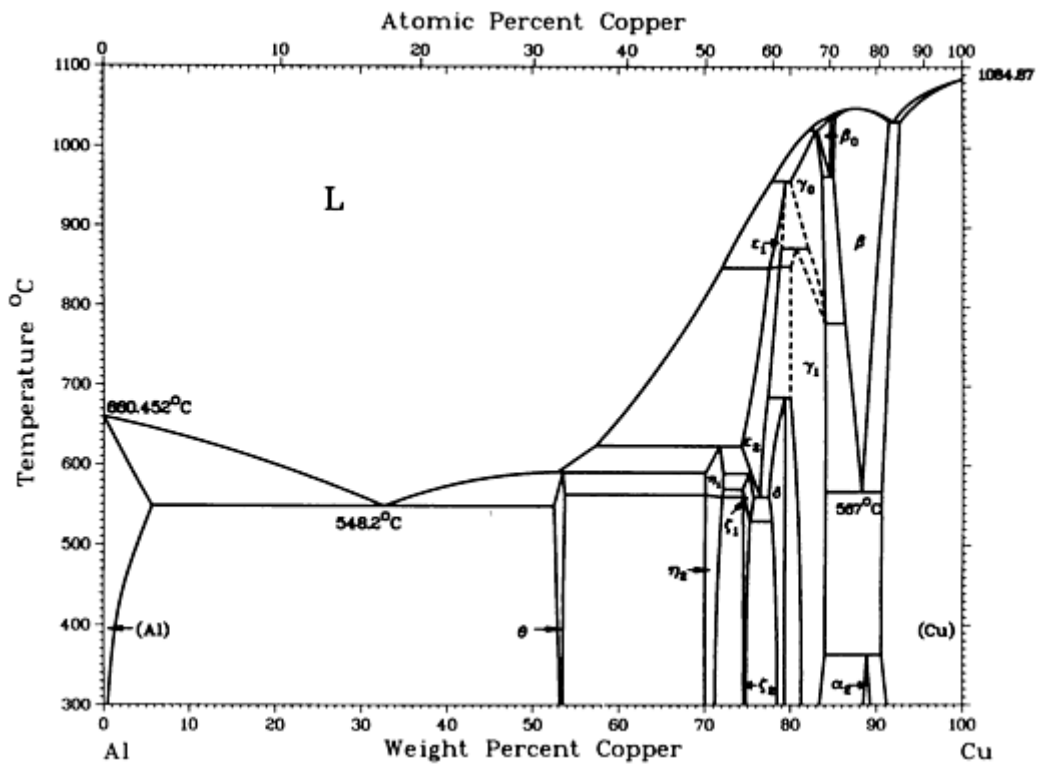

Al-Cu phase diagram

Al-Cu crystallographic data

Phase	Composition, wt% Cu	Pearson symbol	Space group
(Al)	0 to 5.65	$cF4$	$Fm\bar{3}m$
θ	52.5 to 53.7	$tI12$	$I4/mcm$
η_1	70.0 to 72.2	$oP16$ or $oC16$	$Pban$ or $Cmmm$

η_2	70.0 to 72.1	<i>mC20</i>	<i>C2/m</i>
ζ_1	74.4 to 77.8	<i>hP42</i>	<i>P6/mmm</i>
ζ_2	74.4 to 75.2	(a)	...
ε_1	77.5 to 79.4	(b)	...
ε_2	72.2 to 78.7	<i>hP4</i>	<i>P6₃/mmc</i>
δ	77.4 to 78.3	(c)	<i>R$\bar{3}m$</i>
γ_0	77.8 to 84	(d)	...
γ_1	79.7 to 84	<i>cP52</i>	<i>P$\bar{4}3m$</i>
β_0	83.1 to 84.7	(d)	...
β	85.0 to 91.5	<i>cI2</i>	<i>Im$\bar{3}m$</i>
α_2	88.5 to 89	(e)	...
(Cu)	90.6 to 100	<i>cF4</i>	<i>Fm$\bar{3}m$</i>
Metastable phases			
θ'	...	<i>tP6</i>	...
β'	...	<i>cF16</i>	<i>Fm$\bar{3}m$</i>
Al_3Cu_2	61 to 70	<i>hP5</i>	<i>P$\bar{3}m1$</i>

(a) Monoclinic?

(b) Cubic?

(c) Rhombohedral.

(d) Unknown.

(e) $D0_{22}$ -type long-period superlattice

Al-Er (Aluminum - Erbium)

K.A. Gschneidner, Jr. and F.W. Calderwood, 1988

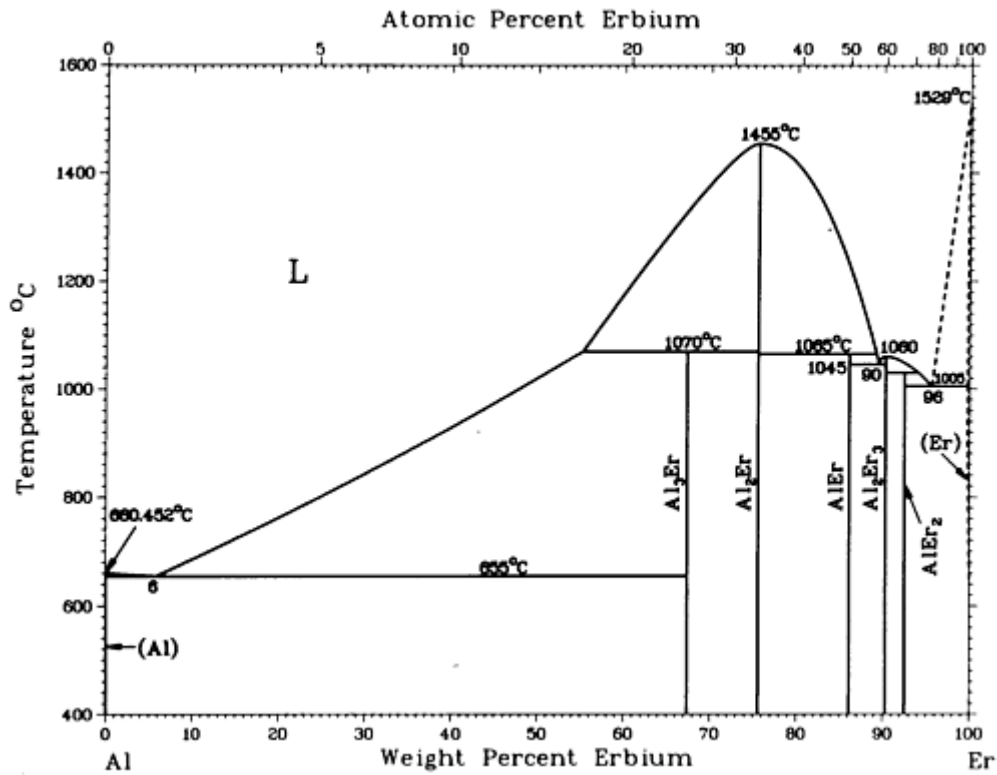

Al-Er phase diagram

Al-Er crystallographic data

Phase	Composition, wt% Er	Pearson symbol	Space group
(Al)	0	$cF4$	$Fm\bar{3}m$
Al_3Er	67	$cP4$	$Pm\bar{3}m$
Al_2Er	75.6	$cF24$	$Fd\bar{3}m$
AlEr	86.1	$oP16$	$Pmma$

Al ₂ Er ₃	90	<i>tP20</i>	<i>P4₂/mmm</i>
AlEr ₂	92.6	<i>oP12</i>	<i>Pnma</i>
(Er)	100	<i>hP2</i>	<i>P6₃/mmc</i>

Al-Fe (Aluminum - Iron)

U.R. Kattner and B.P. Burton, 1992

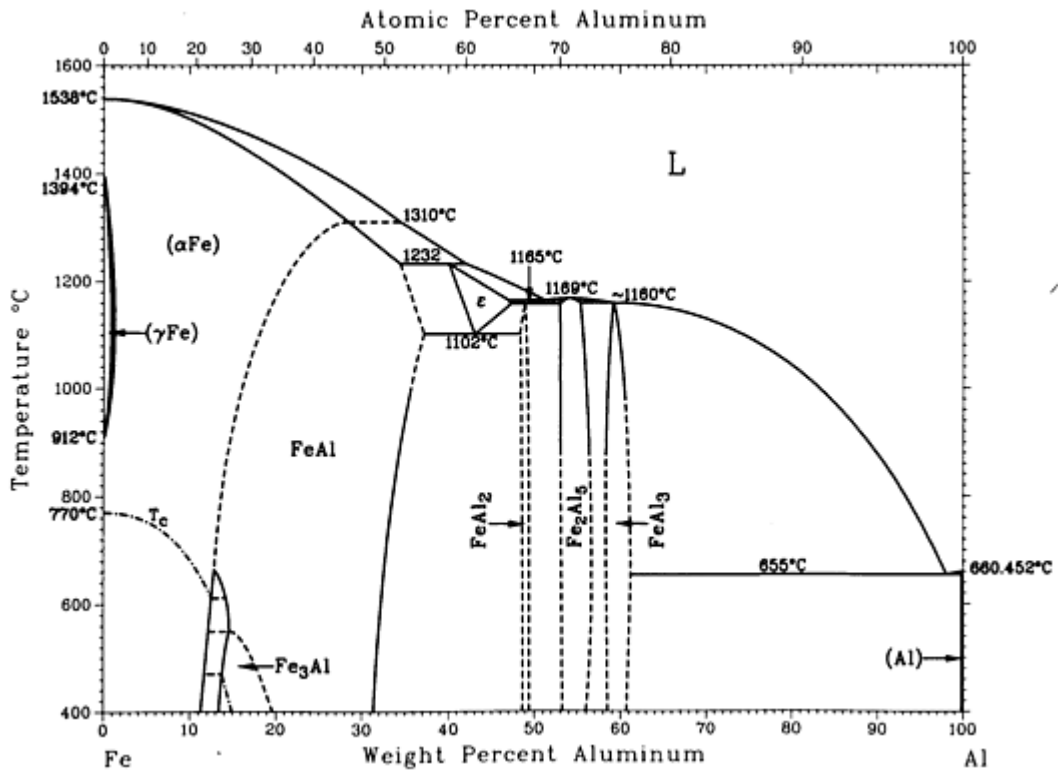

Al-Fe phase diagram

Al-Fe crystallographic data

Phase	Composition, wt% Al	Pearson symbol	Space group
(α Fe)	0 to ~28	<i>cI2</i>	<i>Im$\bar{3}m$</i>
(γFe)	0 to 0.6	<i>cF4</i>	<i>Fm$\bar{3}m$</i>
FeAl	12.8 to ~37	<i>cP8</i>	<i>Pm$\bar{3}m$</i>

Fe ₃ Al	~13 to ~20	<i>cF16</i>	<i>Fm</i> $\bar{3}m$
ϵ	~40 to ~47	<i>cI16?</i>	...
FeAl ₂	48 to 49.4	<i>aP18</i>	<i>P1</i>
Fe ₂ Al ₅	53 to 57	<i>oC?</i>	<i>Cmcm</i>
FeAl ₃	58.5 to 61.3	<i>mC102</i>	<i>C2/m</i>
(Al)	100	<i>cF4</i>	<i>Fm</i> $\bar{3}m$
Metastable phases			
Fe ₂ Al ₉	68.5	<i>mP22</i>	<i>P2₁/c</i>
FeAl ₆	74.3	<i>oC28</i>	<i>Cmc2₁</i>

Al-Ga (Aluminum - Gallium)

J.L. Murray, 1983

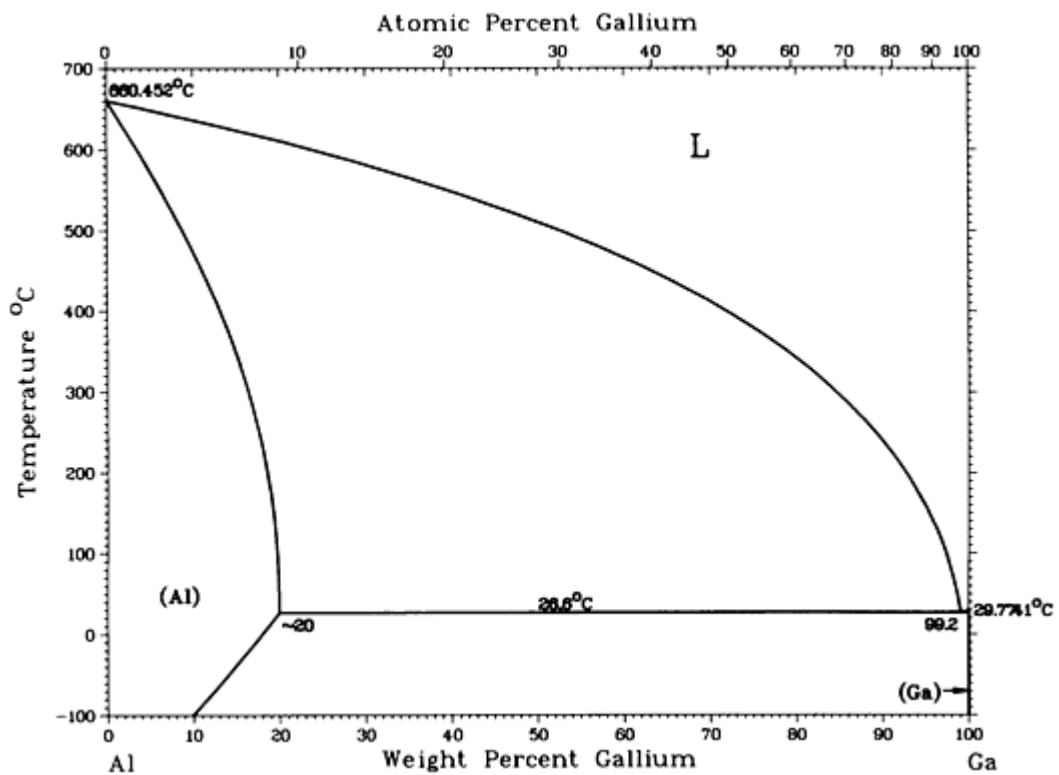

Al-Ga phase diagram

Al-Ga crystallographic data

Phase	Composition, wt% Ga	Pearson symbol	Space group
(Al)	0 to ~20 ^(a)	<i>cF4</i>	<i>Fm$\bar{3}m$</i>
(Ga)	100	<i>oC8</i>	<i>Cmca</i>
Metastable phases			
α'	83 to 92.4	<i>tI2</i>	<i>I4/mmm</i>
ϕ	94 to 95	(b)	(b)

(a) Can be extended to 83 wt% Ga by splat quenching.

(b) Undetermined, low symmetry.

Al-Gd (Aluminum - Gadolinium)

K.A. Gschneidner, Jr. and F.W. Calderwood, 1988

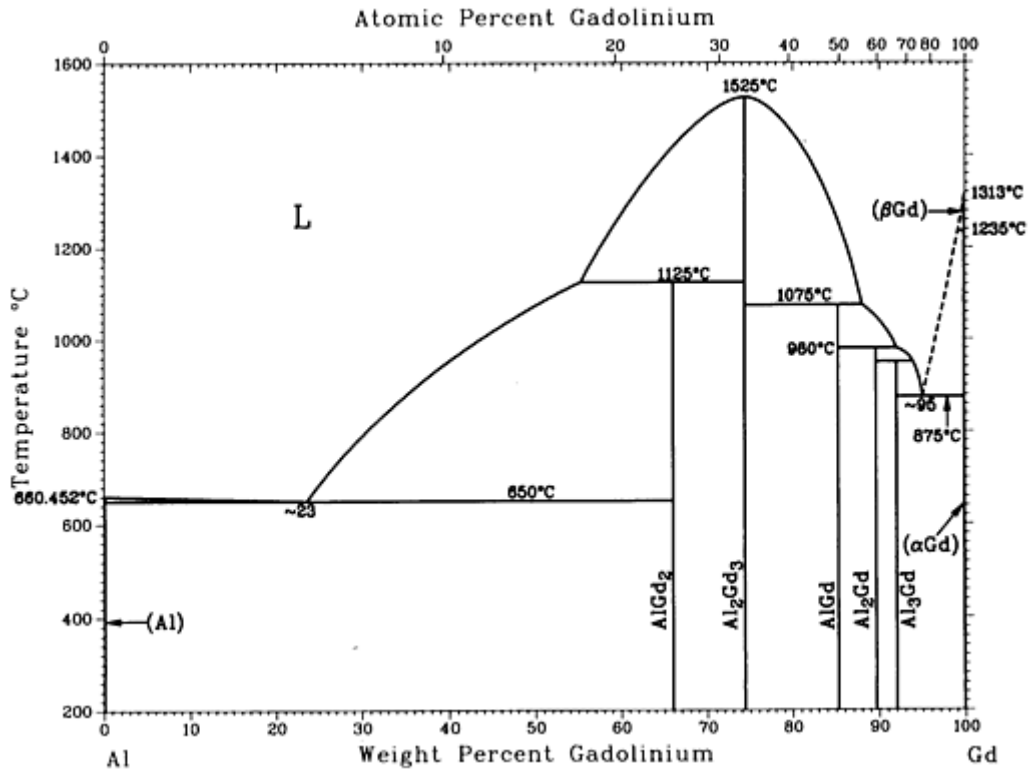

Al-Gd phase diagram

Al-Gd crystallographic data

Phase	Composition, wt% Gd	Pearson symbol	Space group
(Al)	0	<i>cF4</i>	<i>Fm</i> $\bar{3}m$
Al ₃ Gd	66	<i>hP8</i>	<i>P6</i> ₃ / <i>mmc</i>
Al ₂ Gd	74.4	<i>cF24</i>	<i>Fd</i> $\bar{3}m$
AlGd	85.4	<i>oP16</i>	<i>Pmma</i>
Al ₂ Gd ₃	90	<i>tP20</i>	<i>P4</i> ₂ / <i>mnm</i>
AlGd ₂	92.1	<i>oP12</i>	<i>Pnma</i>
(βGd)	100	<i>cI2</i>	<i>Im</i> $\bar{3}m$

(α Gd)	100	<i>hP2</i>	<i>P6₃/mmc</i>
----------------	-----	------------	---------------------------

Al-Ge (Aluminum - Germanium)

A.J. McAlister and J.L. Murray, 1984

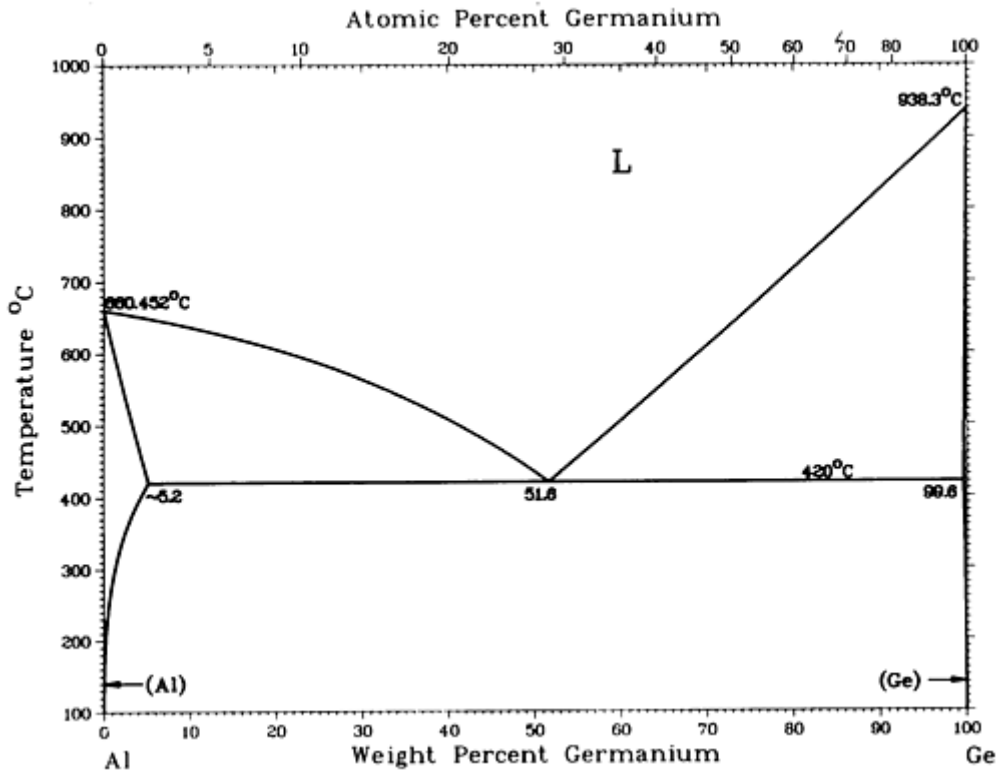

Al-Ge phase diagram

Al-Ge crystallographic data

Phase	Composition, wt% Ge	Pearson symbol	Space group
(Al)	0 to ~5.2	<i>cF4</i>	<i>Fm$\bar{3}m$</i>
(Ge)	99.6 to 100	<i>cF8</i>	<i>Fd$\bar{3}m$</i>
Metastable phases			
γ_1	...	<i>hR*</i> <i>t**</i>	...
γ_2	...	<i>cP*</i> <i>mC*</i>	...

		f^{**}	...
γ_3	...	cP^* hP^*

Al-H (Aluminum - Hydrogen)

A. San-Martin and F.D. Manchester, 1992

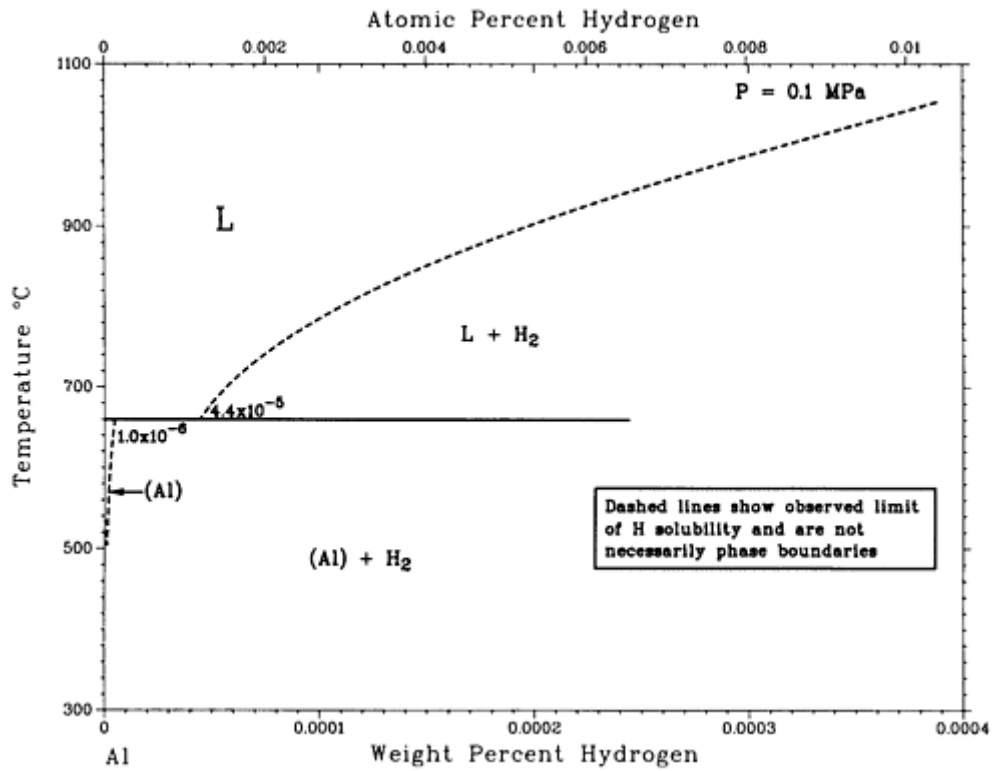

Al-H phase diagram

Al-H crystallographic data

Phase	Composition, wt% H	Pearson symbol	Space group
(Al)	0 to $4.48 \times 10^{-6(a)}$	$cF4$	$Fm\bar{3}m$
$AlH_3^{(b)}$	10.1	...	$R\bar{3}c$

(a) At 660 °C and 0.1 MPa.

(b) Produced by chemical reaction of organic solvents at atmospheric pressure

Al-Hg (Aluminum - Mercury)

A.J. McAlister, 1985

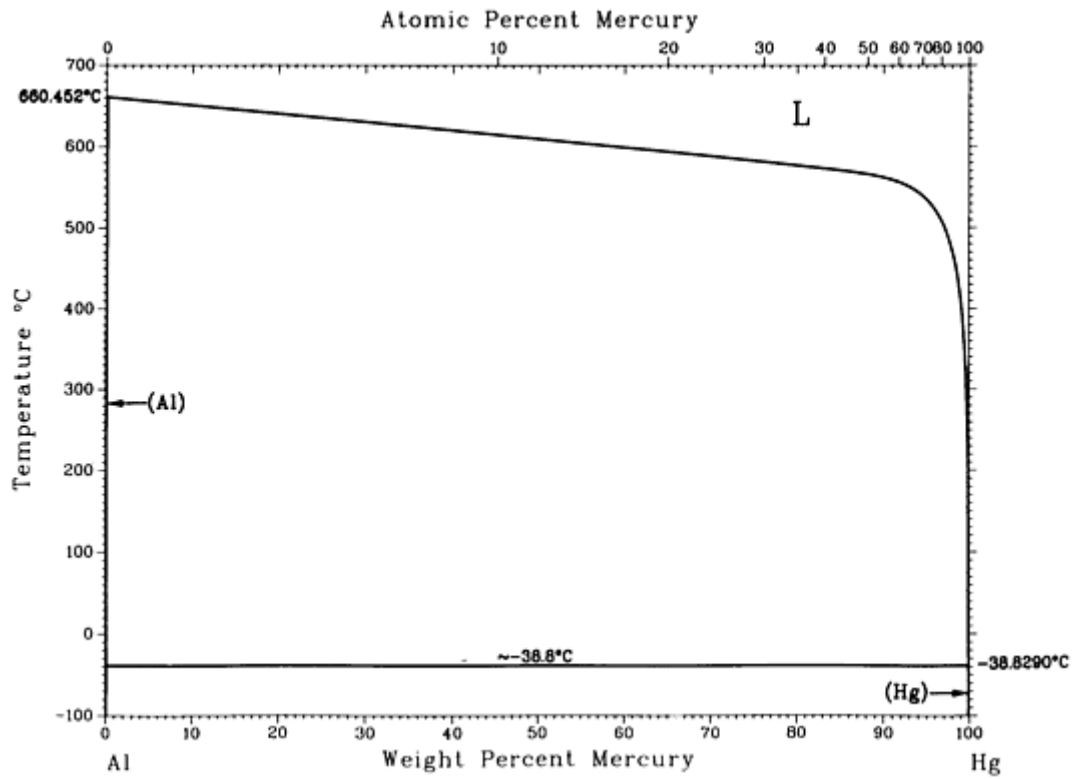

Al-Hg phase diagram

Al-Hg crystallographic data

Phase	Composition, wt% Hg	Pearson symbol	Space group
(Al)	0	<i>cF4</i>	<i>Fm</i> $\bar{3}m$
(Hg)	100	<i>hR1</i>	<i>R</i> $\bar{3}m$

Al-Ho (Aluminum - Holmium)

K.A. Gschneidner, Jr. and F.W. Calderwood, 1988

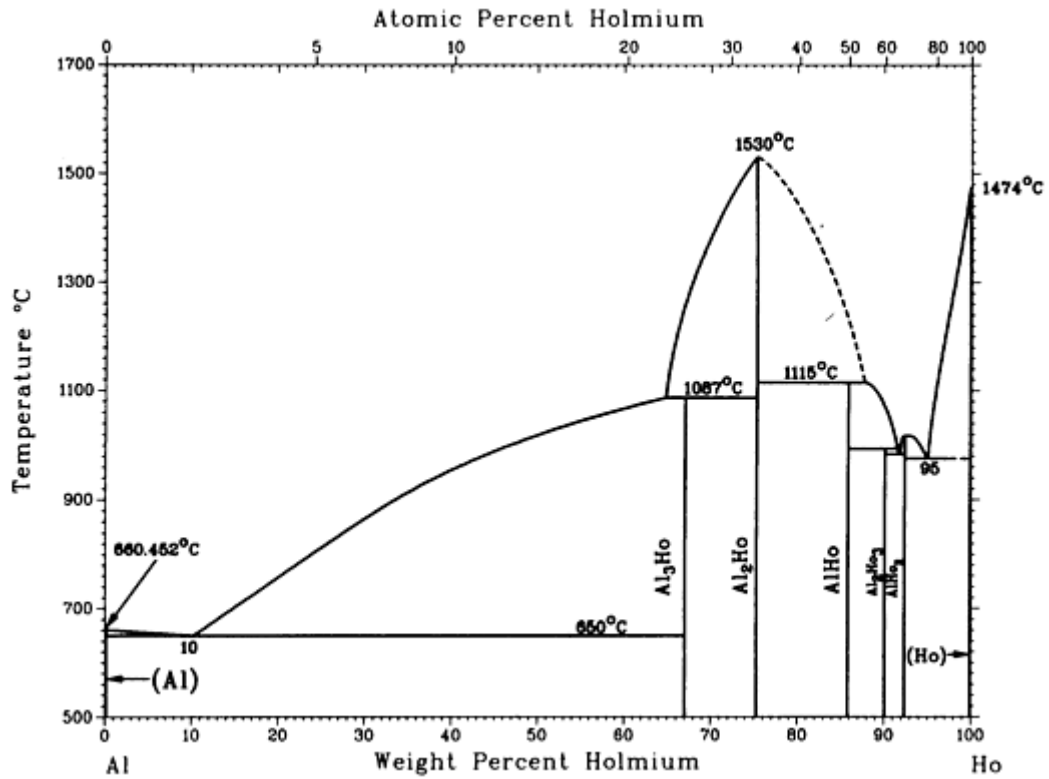

Al-Ho phase diagram

Al-Ho crystallographic data

Phase	Composition, wt% Ho	Pearson symbol	Space group
(Al)	0	<i>cF4</i>	<i>Fm</i> $\bar{3}m$
Al ₃ Ho	67	<i>hR20</i>	<i>R</i> $\bar{3}m$
Al ₂ Ho	75.3	<i>cF24</i>	<i>Fd</i> $\bar{3}m$
AlHo	85.9	<i>oP16</i>	<i>Pmma</i>
Al ₂ Ho ₃	90	<i>tP20</i>	<i>P4</i> ₂ / <i>mnm</i>
AlHo ₂	92.5	<i>oP12</i>	<i>Pnma</i>
(Ho)	100	<i>hP2</i>	<i>P6</i> ₃ / <i>mmc</i>

Al-In (Aluminum - Indium)

J. L. Murray, 1983

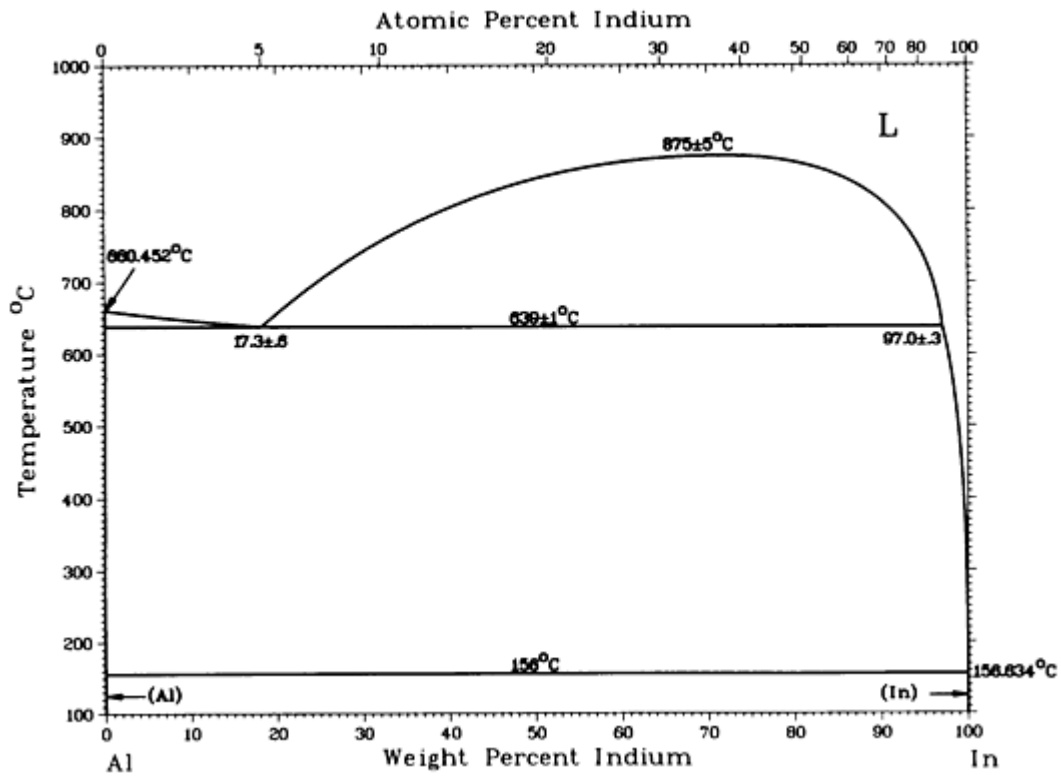

Al-In phase diagram

Al-In crystallographic data

Phase	Composition, wt% In	Pearson symbol	Space group
(Al)	0 to 0.19	<i>cF4</i>	<i>Fm</i> $\bar{3}m$
(In)	~100	<i>tI2</i>	<i>I4/mmm</i>
Metastable phases			
(In')	...	<i>cF4</i>	<i>Fm</i> $\bar{3}m$

Al-La (Aluminum - Lanthanum)

K.A. Gschneidner, Jr. and F.W. Calderwood, 1988

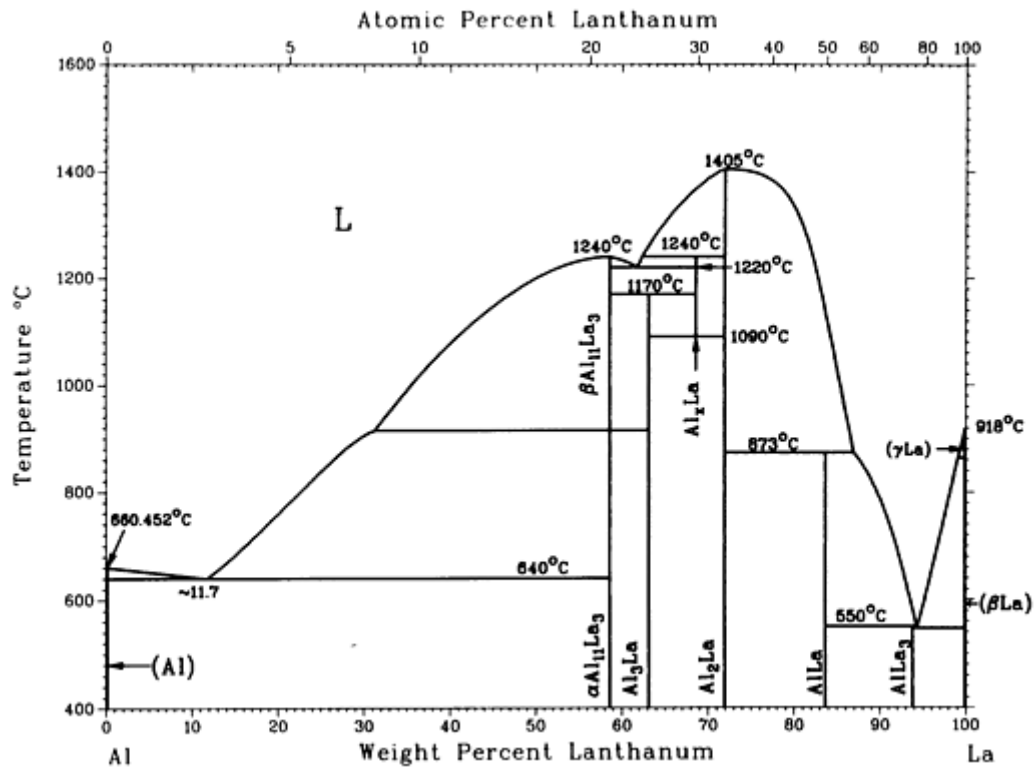

Al-La phase diagram

Al-La crystallographic data

Phase	Composition, wt% La	Pearson symbol	Space group
(Al)	0 to ~0.05	<i>cF4</i>	<i>Fm</i> $\bar{3}$ <i>m</i>
$\alpha\text{Al}_{11}\text{La}_3$	58.4	<i>oI28</i>	<i>I</i> <i>mmm</i>
$\beta\text{Al}_{11}\text{La}_3$	58.4	<i>tI10</i>	<i>I4/mmm</i>
Al_3La	63	<i>hP8</i>	<i>P6</i> ₃ / <i>mmc</i>
Al_xLa	68.1	<i>hP3</i>	<i>P6</i> ₃ / <i>mmm</i>
Al_2La	72.0	<i>cF24</i>	<i>Fd</i> $\bar{3}$ <i>m</i>
AlLa	83.7	<i>oC16</i>	<i>Cmc2</i> or <i>Cmcm</i>

AlLa ₃	94	<i>hP</i> 8	<i>P6₃/mmc</i>
(α La)	100	<i>hP</i> 4	<i>P6₃/mmc</i>
(β La)	100	<i>cF</i> 4	<i>Fm</i> $\bar{3}m$
(γ La)	100	<i>cI</i> 2	<i>Im</i> $\bar{3}m$

Al-Li (Aluminum - Lithium)

A.J. McAlister, 1991

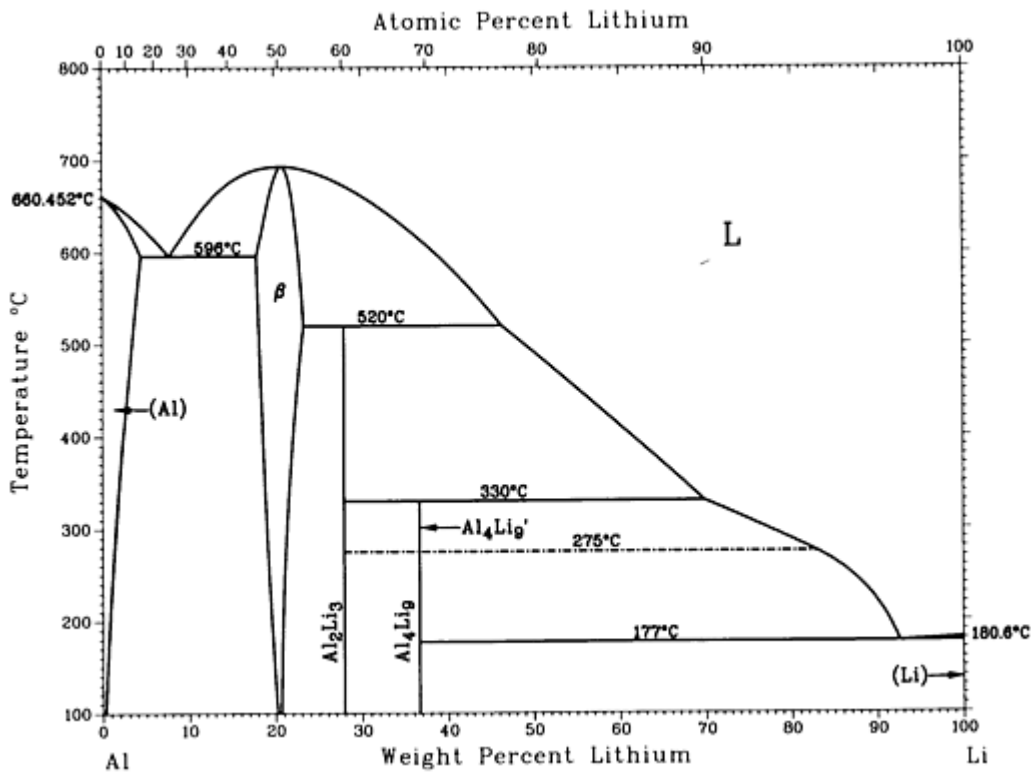

Al-Li phase diagram

Al-Li crystallographic data

Phase	Composition, wt% Li	Pearson symbol	Space group
(Al)	0 to 4	<i>cF</i> 4	<i>Fm</i> $\bar{3}m$
β	17 to 24	<i>cF</i> 16	<i>Fd</i> $\bar{3}m$

Al_2Li_3	28 to 29	$hR15$	$R\bar{3}m$
Al_4Li_9	36.6	$mC26$	$C2/m$
$\text{Al}_4\text{Li}_9'$	36.6
(βLi)	100	$cI2$	$Im\bar{3}m$
(αLi)	100	$hP2$	$P6_3/mmc$
Metastable phases			
Al_3Li	...	$cP4$	$Pm\bar{3}m$

Al-Mg (Aluminum - Magnesium)

J.L. Murray, 1988

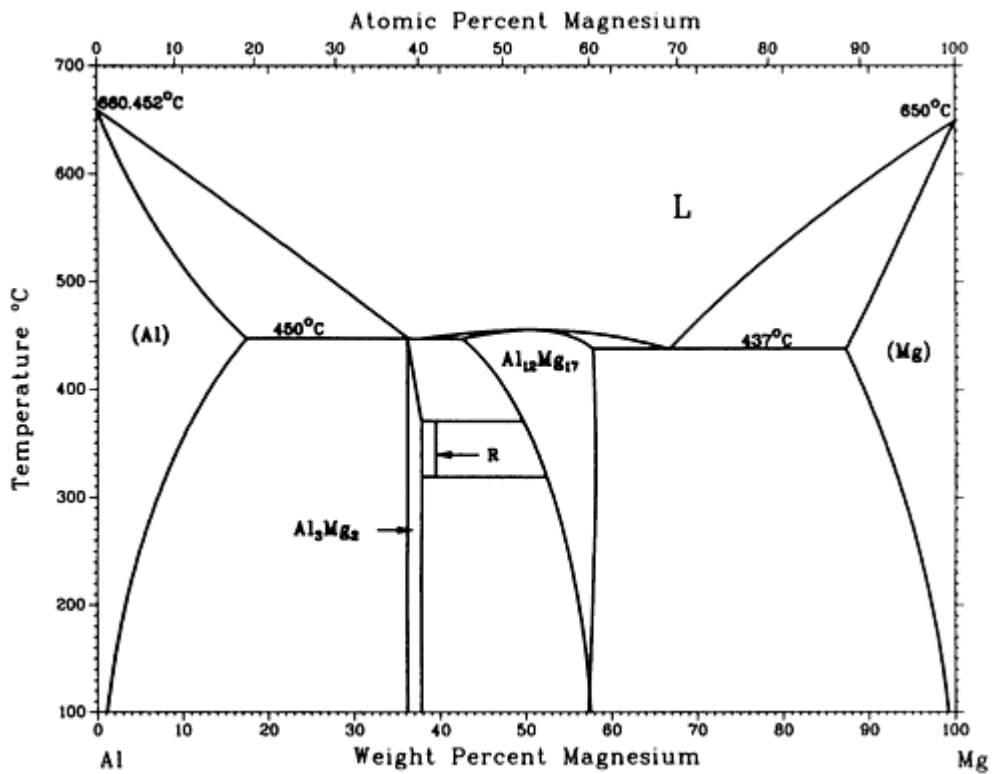

Al-Mg phase diagram

Al-Mg crystallographic data

Phase	Composition, wt% Mg	Pearson symbol	Space group
(Al)	0 to 17.1	<i>cF4</i>	<i>Fm</i> $\bar{3}m$
$\beta(\text{Al}_3\text{Mg}_2)$	36.1 to 37.8	<i>cF1168</i>	<i>Fd</i> $\bar{3}m$
<i>R</i>	39	<i>hR53</i>	<i>R</i> $\bar{3}$
$\gamma(\text{Al}_{12}\text{Mg}_{17})$	42 to 58.0	<i>cI58</i>	<i>I</i> $\bar{4}3m$
(Mg)	87.1 to 100	<i>hP2</i>	<i>P6</i> $_3/mmc$
Metastable phases			
Al_2Mg	31.0	<i>tI24</i>	<i>I</i> $4_1/amd$
γ'	38 to 56.2	^(a)	...

(a) Tetragonal

Al-Mn (Aluminum - Manganese)

A.J. McAlister and J.L. Murray, 1987

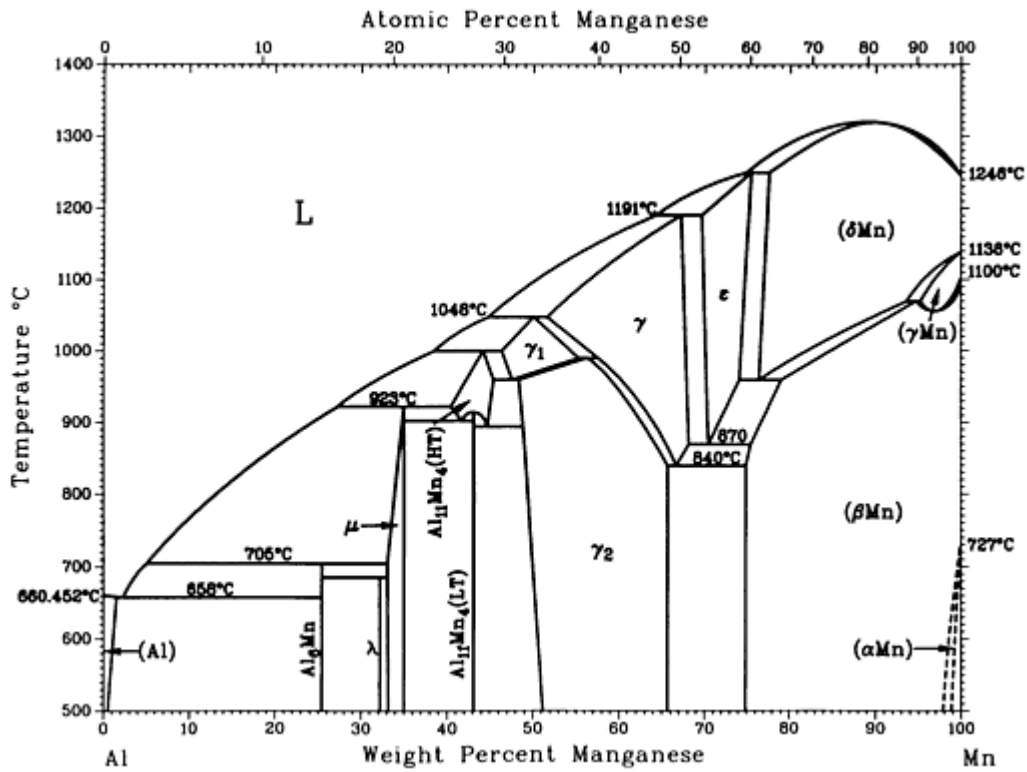

Al-Mn phase diagram

Al-Mn crystallographic data

Phase	Composition, wt% Mn	Pearson symbol	Space group
(Al)	0 to 1.25	<i>cF4</i>	<i>Fm</i> $\bar{3}m$
$G^{(a)}$	^(b)	<i>cI26</i>	<i>Im</i> $\bar{3}m$
Al_6Mn	25.2	<i>oC28</i>	<i>Cmcm</i>
λ (" Al_4Mn ") ^(c)	~29.4 to ~32	^(d)	...
μ	~32 to 34.8	^(d)	...
$Al_{10}Mn_3(\phi)$	^(b)	<i>hP28</i>	<i>P6_3/mmc</i>
$Al_{11}Mn_4(LT)^{(e)}$	43	<i>aP30</i>	<i>P</i> $\bar{1}$

$\text{Al}_{11}\text{Mn}_4(\text{HT})^{(e)}$	40 to 45.0	<i>oP160</i>	<i>Pnma</i>
γ_1	47 to 55.7	^(f)	...
$\gamma_2^{(g)}$	48.2 to 64	<i>hR26</i>	<i>R\bar{3}m</i>
γ	51.8 to 68.2	^(f)	...
ϵ	69.8 to 75	<i>hP2</i>	<i>P6_3/mmc</i>
τ	^(b)	<i>tP2</i>	<i>P4/mmm</i>
(δ_{Mn})	76.5 to 100	<i>cI2</i>	<i>Im\bar{3}m</i>
(γ_{Mn})	95.3 to 100	<i>cF4</i>	<i>Fm\bar{3}m</i>
(β_{Mn})	75.0 to 100	<i>cP20</i>	<i>P4_132</i>
(α_{Mn})	~ 99 to 100	<i>cI58</i>	<i>I\bar{4}3m</i>

(a) Several other structures have been ascribed to the G phase or variants of the G phase (G', G").

(b) Metastable phase.

(c) A simple orthorhombic structure was reported in an alloy described as "Al₄Mn."

(d) Hexagonal.

(e) Variants of this structure are described as complex stacking sequences along the *b* axis.

(f) Unknown.

(g) The structure has been described as distorted γ -brass type, cubic (bcc or fcc), and rhombohedral.

Al-Nb (Aluminum - Niobium)

U.R. Kattner, unpublished

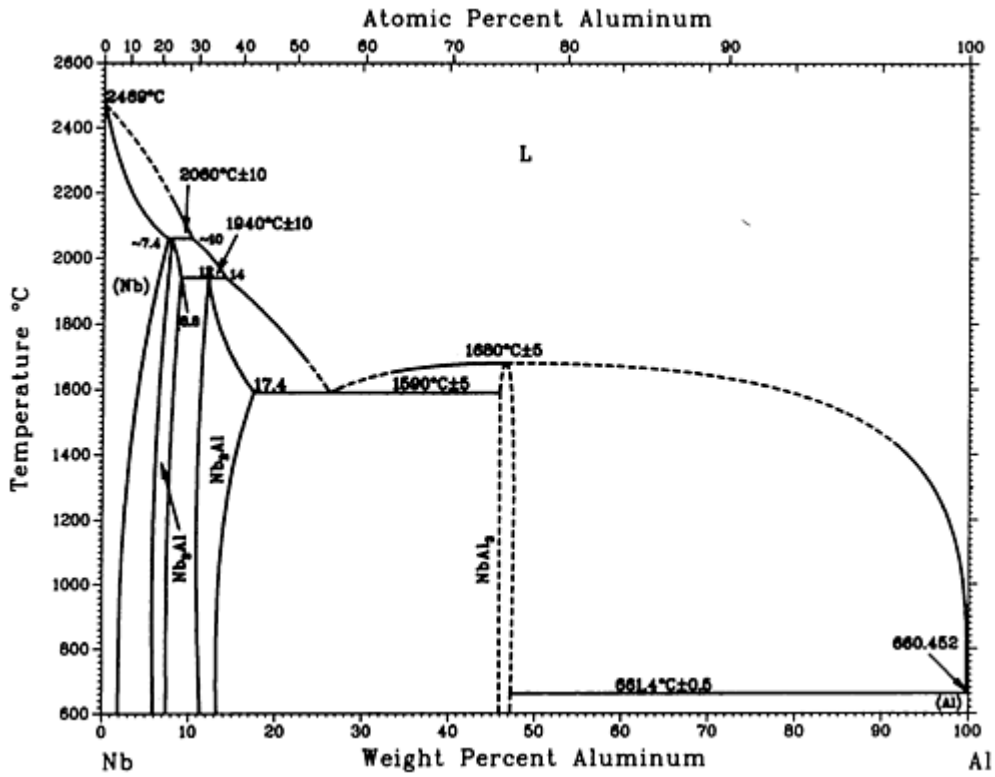

Al-Nb phase diagram

Al-Nb crystallographic data

Phase	Composition, wt% Al	Pearson symbol	Space group
(Nb)	0 to ~7.4	<i>cI2</i>	<i>Im</i> $\bar{3}m$
Nb ₃ Al	18.6 to 8.8	<i>cP8</i>	<i>Pm</i> $\bar{3}n$
Nb ₂ Al	11 to 17.4	<i>tP30</i>	<i>P4</i> ₂ <i>/mmm</i>
NbAl ₃	47	<i>tI8</i>	<i>I4</i> <i>/mmm</i>
(Al)	100	<i>cF4</i>	<i>Fm</i> $\bar{3}m$

Al-Nd (Aluminum - Neodymium)

H. Okamoto, 1991

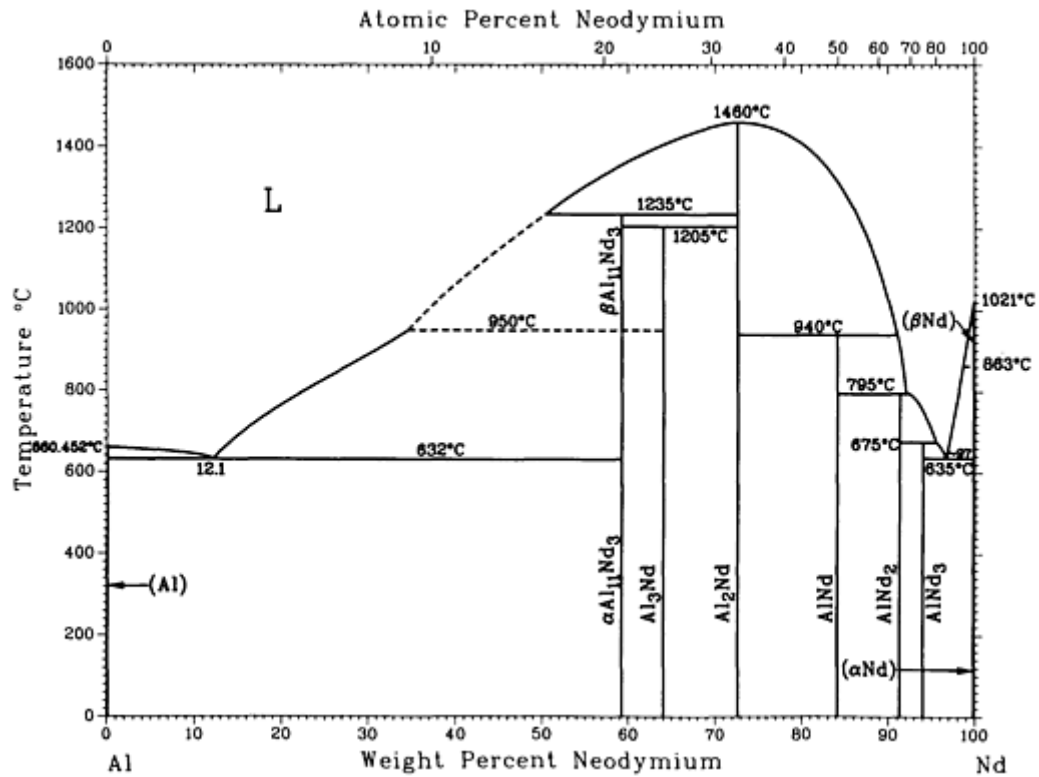

Al-Nd phase diagram

Al-Nd crystallographic data

Phase	Composition, wt% Nd	Pearson symbol	Space group
(Al)	0 to 0.05	<i>cF4</i>	<i>Fm</i> $\bar{3}m$
$\alpha\text{Al}_{11}\text{Nd}_3$	59.3	<i>oI28</i>	<i>Immm</i>
$\beta\text{Al}_{11}\text{Nd}_3$	59.3	<i>tI10</i>	<i>I4/mmm</i>
Al_3Nd	64	<i>hP8</i>	<i>P6_3/mmc</i>
Al_2Nd	72.7	<i>cF24</i>	<i>Fd</i> $\bar{3}m$
AlNd	84.2	<i>oP16</i>	<i>Pmma</i>
AlNd_2	91.5	<i>oP12</i>	<i>Pnma</i>

AlNd ₃	94	<i>hP8</i>	<i>P6₃/mmc</i>
(α Nd)	100	<i>hP4</i>	<i>P6₃/mmc</i>
(β Nd)	100	<i>cI2</i>	<i>Im$\bar{3}m$</i>

Al-Ni (Aluminum - Nickel)

P. Nash, M.F. Singleton, and J.L. Murray, 1991

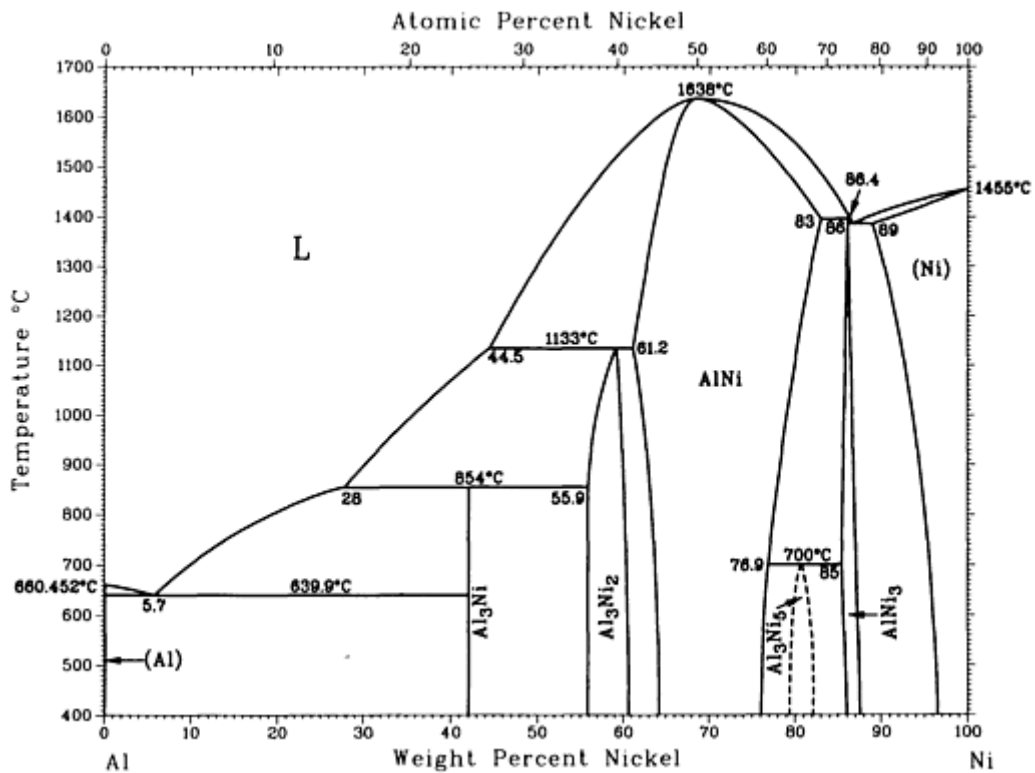

Al-Ni phase diagram

Al-Ni crystallographic data

Phase	Composition, wt% Ni	Pearson symbol	Space group
(Al)	0 to 0.24	<i>cF4</i>	<i>Fm$\bar{3}m$</i>
Al ₃ Ni	42	<i>oP16</i>	<i>Pnma</i>
Al ₃ Ni ₂	55.9 to 60.7	<i>hP5</i>	<i>P$\bar{3}m1$</i>

AlNi	61 to 83.0	<i>cP2</i>	<i>Pm</i> $\bar{3}m$
Al ₃ Ni ₅	79 to ~82	...	<i>Cmmm</i>
AlNi ₃	85 to 87	<i>cP4</i>	<i>Pmvm</i>
(Ni)	89.0 to 100	<i>cF4</i>	<i>Fm</i> $\bar{3}m$

Al-Pb (Aluminum - Lead)

A.J. McAlister, 1984

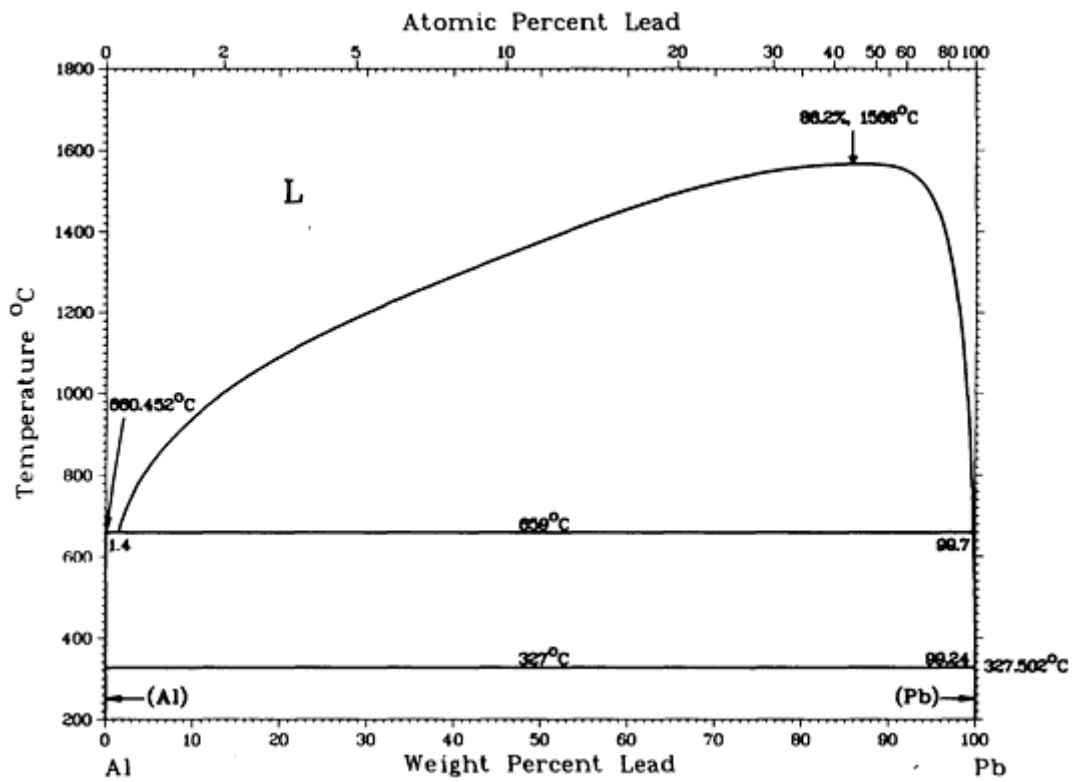

Al-Pb phase diagram

Al-Pb crystallographic data

Phase	Composition, wt% Pb	Pearson symbol	Space group
(Al)	0	<i>cF4</i>	<i>Fm</i> $\bar{3}m$
(Pb)	99.7 to 100	<i>cF4</i>	<i>Fm</i> $\bar{3}m$

Al-Pd (Aluminum - Palladium)

A.J. McAlister, 1986

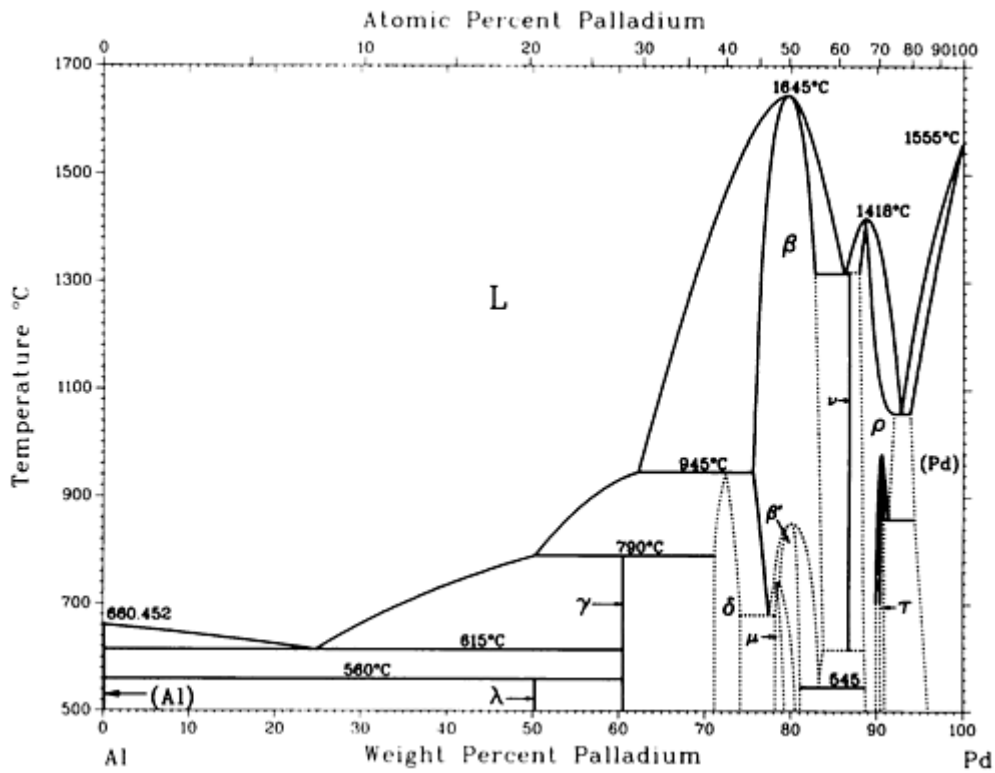

Al-Pd phase diagram

Al-Pd crystallographic data

Phase	Composition, wt% Pd	Pearson symbol	Space group
(Al)	0	$cF4$	$Fm\bar{3}m$
λ	~50	(a)	...
γ	~60.1	(b)	...
δ	71 to 73.7	$hP5$	$P\bar{3}m1$
β	76 to 83	$cP8$	$Pm\bar{3}m$
β'	78.8 to 81.5	$hR78$	$R\bar{3}$
μ	78 to 79	$cP8$	$P2_13$

ν	86.8	<i>oP16</i>	<i>Pbam</i>
ρ	88 to 91	<i>oP12</i>	<i>Pnma</i>
τ	90.5 to 90.9	<i>oP28</i>	<i>Pbmn</i>
(Pd)	94 to 100	<i>cF4</i>	<i>Fm$\bar{3}m$</i>

(a) Hexagonal.

(b) Orthorhombic

Al-Pr (Aluminum - Praseodymium)

K.A. Gschneidner, Jr. and F.W. Calderwood, 1989

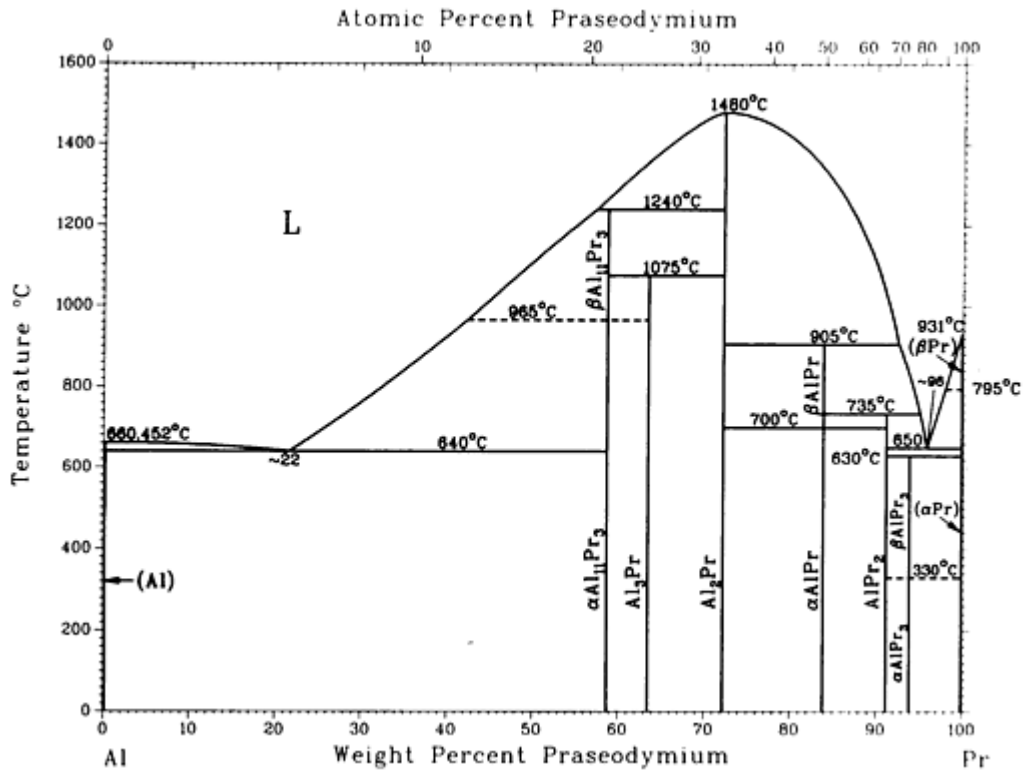

Al-Pr phase diagram

Al-Pr crystallographic data

Phase	Composition, wt% Pr	Pearson symbol	Space group

(Al)	0 to ~ 0.05	<i>cF4</i>	<i>Fm</i> $\bar{3}m$
α Al ₁₁ Pr ₃	58.7	<i>oI28</i>	<i>Immm</i>
β Al ₁₁ Pr ₃	58.7	<i>tI10</i>	<i>I4/mmm</i>
Al ₃ Pr	64	<i>hP8</i>	<i>P6₃/mmc</i>
Al ₂ Pr	72.3	<i>cF24</i>	<i>Fd</i> $\bar{3}m$
α AlPr	83.9	<i>oP16</i>	<i>Pmma</i>
β AlPr	83.9	<i>oC16</i>	<i>Cmc2</i> or <i>Cmcm</i>
AlPr ₂	91.3	<i>oP12</i>	<i>Pnma</i>
α AlPr ₃	94	<i>hP8</i>	<i>P6₃/mmc</i>
β AlPr ₃	94	<i>cP4</i>	<i>Pm</i> $\bar{3}m$
(α Pr)	100	<i>hP4</i>	<i>P6₃/mmc</i>
(β Pr)	100	<i>cI2</i>	<i>Im</i> $\bar{3}m$

Al-Pt (Aluminum - Platinum)

A.J. McAlister and D.J. Kahan, 1986

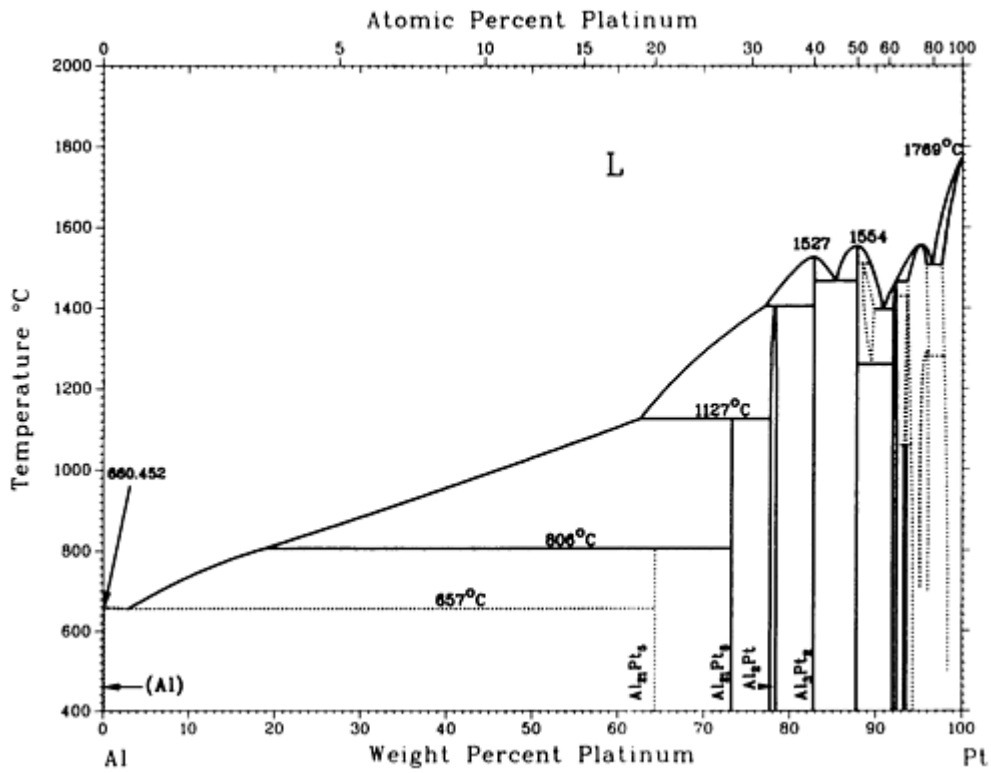

Al-Pt phase diagram

Al-Pt crystallographic data

Phase	Composition, wt% Pt	Pearson symbol	Space group
(Al)	0	<i>cF4</i>	<i>Fm</i> $\bar{3}m$
Al ₂₁ Pt ₅	63.2	<i>c**</i>	...
Al ₂₁ Pt ₈	72.8	<i>tI116</i>	<i>I4</i> ₁ <i>a</i>
Al ₂ Pt	76.9 to 78.5	<i>cF12</i>	<i>Fm</i> $\bar{3}m$
Al ₃ Pt ₂	82.8	<i>hP5</i>	<i>P3m1</i>
AlPt	87.9	<i>cP8</i>	<i>P2</i> ₁ <i>3</i>
β	~89 to ~90	<i>cP2</i>	<i>Pm</i> $\bar{3}m$

Al_3Pt_5	~ 92.0 to ~ 92.5	$oP16$	$Pbam$
AlPt_2	~ 93 to ~ 94	$oP12$	$Pnma$
$\text{AlPt}_2(\text{LT})$	~ 93 to ~ 94	$oP24$	$Pmma$
AlPt_3	~ 93.7 to ~ 96.18	$cP4$	$Pm\bar{3}m$
$\text{AlPt}_3(\text{LT})$	~ 95.3 to ~ 96.25	$tP16$	$P4/m\bar{3}m$
(Pt)	~ 97.4 to 100	$cF4$	$Fm\bar{3}m$
Metastable phases			
α'	...	$cF4$	$Fm\bar{3}m$
Al_4Pt	~ 64	hP^*	...
Al_6Pt	~ 54	o^{**}	...
ϵ'	...	c^{**}	...
λ'	45 to 71

Al-S (Aluminum - Sulfur)

R.C. Sharma and Y.A. Chang, 1991

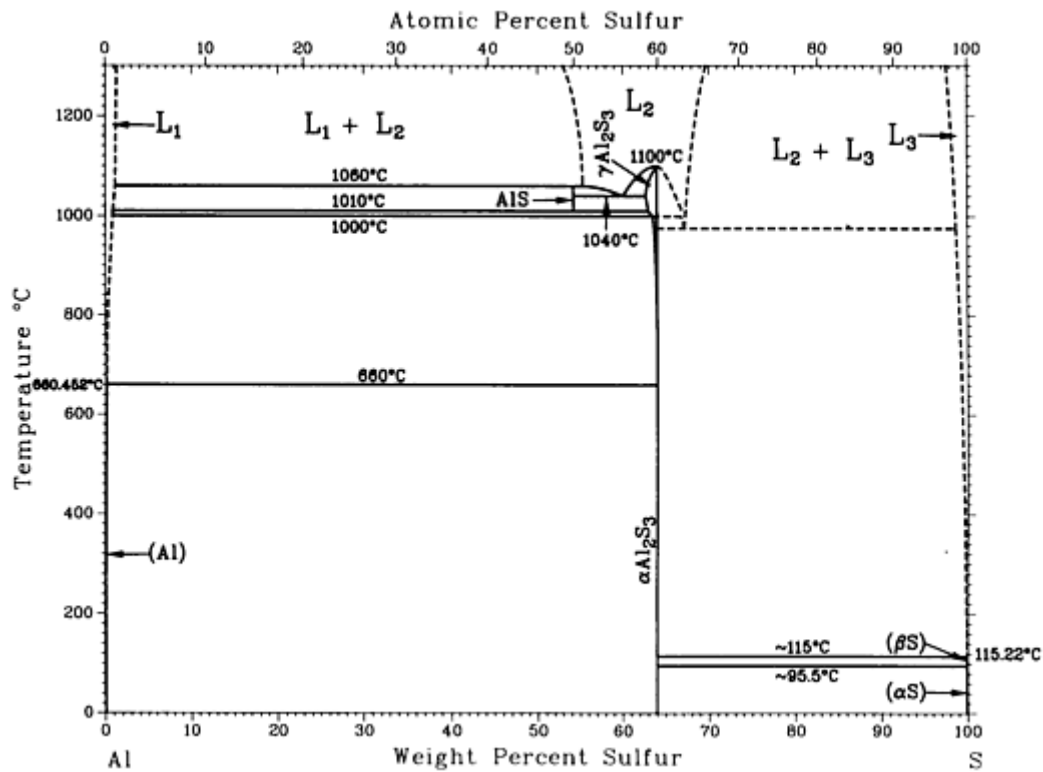

Al-S phase diagram

Al-S crystallographic data

Phase	Composition, wt% S	Pearson symbol	Space group
(Al)	0	<i>cF4</i>	<i>Fm$\bar{3}m$</i>
$\alpha\text{-Al}_2\text{S}_3$	64	<i>hP30</i>	...
$\beta\text{-Al}_2\text{S}_3^{(a)}$	64	^(b)	<i>P6$_3$mc</i>
$\gamma\text{-Al}_2\text{S}_3$	63 to 64	<i>hR10</i>	<i>R3c</i>
$\text{Al}_2\text{S}_3^{(c)}$	64	^(d)	<i>I4$_1$/amd</i>
$\text{Al}_2\text{S}_3^{(e)}$	64	^(f)	<i>Fd$\bar{3}m$</i>
(α S)	100	<i>oF128</i>	<i>Fddd</i>

(β_S)	100	mP^*	$P2_1/c$
-------------	-----	--------	----------

(a) Stable in the presence of Al_4C_3 between 1000 and 1100 °C.

(b) Hexagonal.

(c) High pressure, formed at 2 to 65 kbar and 1000 to 1200 °C.

(d) Tetragonal.

(e) High pressure, formed at 40 kbar and 400 °C.

(f) Cubic

Al-Sb (Aluminum - Antimony)

A.J. McAlister, 1984

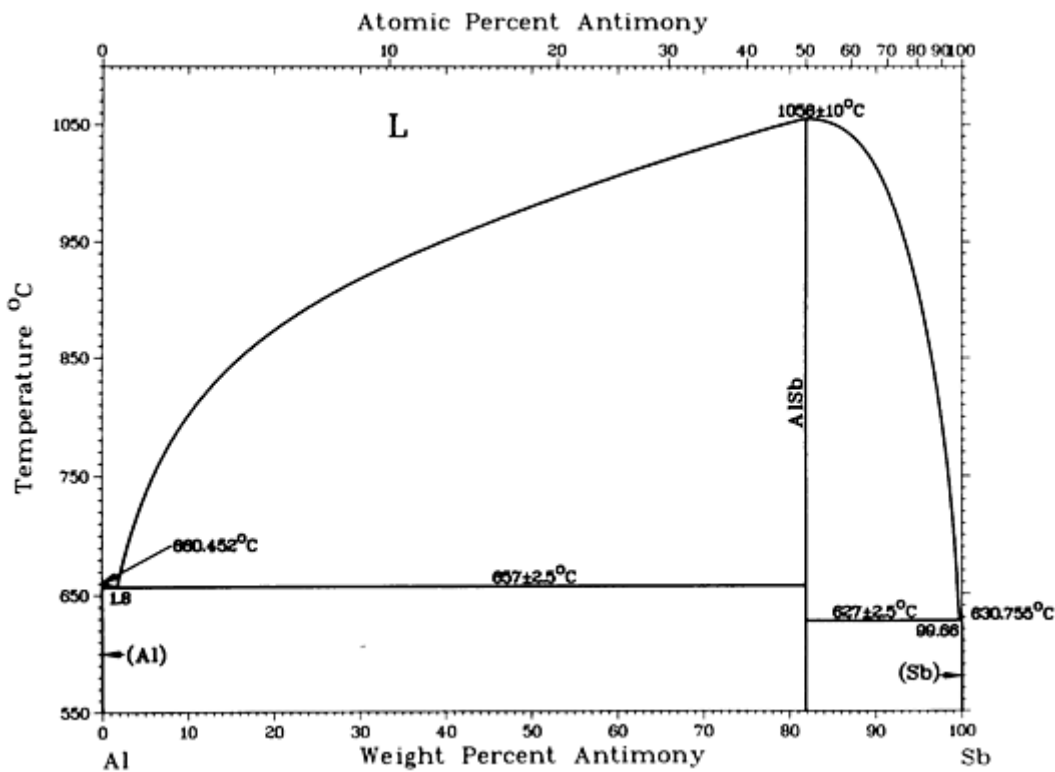

Al-Sb phase diagram

Al-Sb crystallographic data

Phase	Composition, wt% Sb	Pearson symbol	Space group
(Al)	0	$cF4$	$Fm\bar{3}m$
AlSb	81.9	$cF8$	$F\bar{4}3m$
(Sb)	100	$hR2$	$R\bar{3}m$
High-pressure phase			
AlSb ^(a)	81.9	$tI4$	$I4_1/amd$

(a) At 120 kbar.

Al-Se (Aluminum - Selenium)

J.M. Howe, 1989

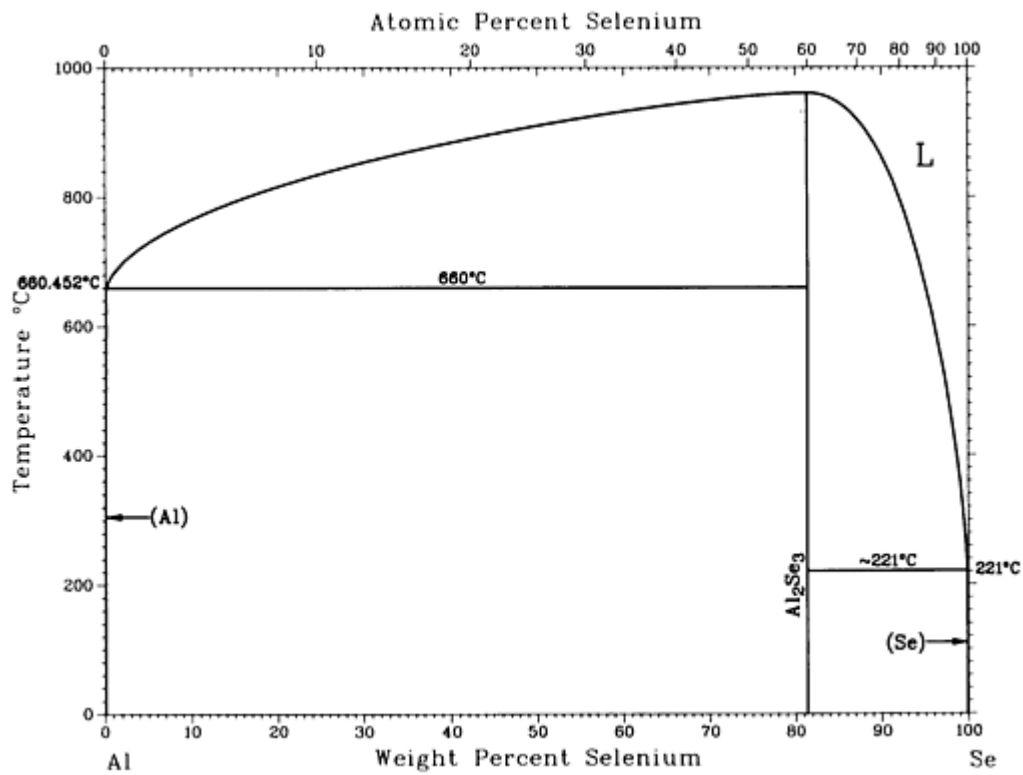

Al-Se phase diagram

Al-Se crystallographic data

Phase	Composition, wt% Se	Pearson symbol	Space group
(Al)	<0.009	<i>cF4</i>	<i>Fm</i> $\bar{3}m$
Al ₂ Se ₃	81	<i>mC20</i>	<i>C_c</i>
(Se)	100	<i>hP3</i>	<i>P3₁21</i>

Al-Si (Aluminum - Silicon)

J.L. Murray and A.J. McAlister, 1984

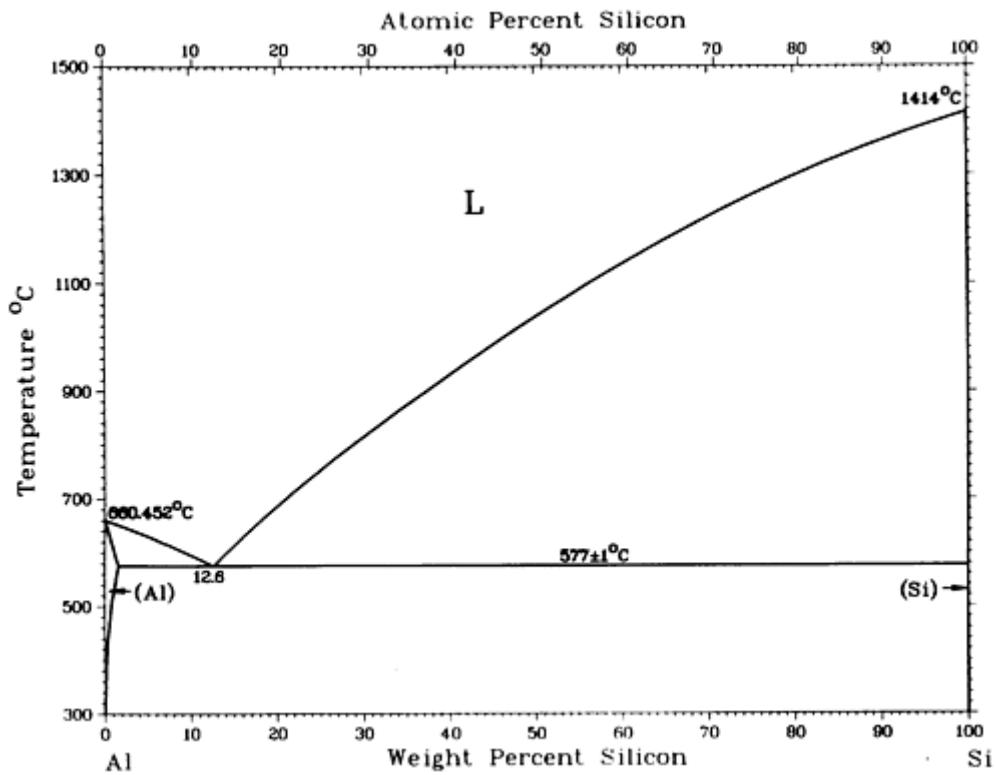

Al-Si phase diagram

Al-Si crystallographic data

Phase	Composition, wt% Si	Pearson symbol	Space group
-------	---------------------	----------------	-------------

(Si)	99.985 to 100	<i>cF8</i>	<i>Fd$\bar{3}m$</i>
------	---------------	------------	--------------------------------

Al-Sn (Aluminum - Tin)

A.J. McAlister and D.J. Kahan, 1983

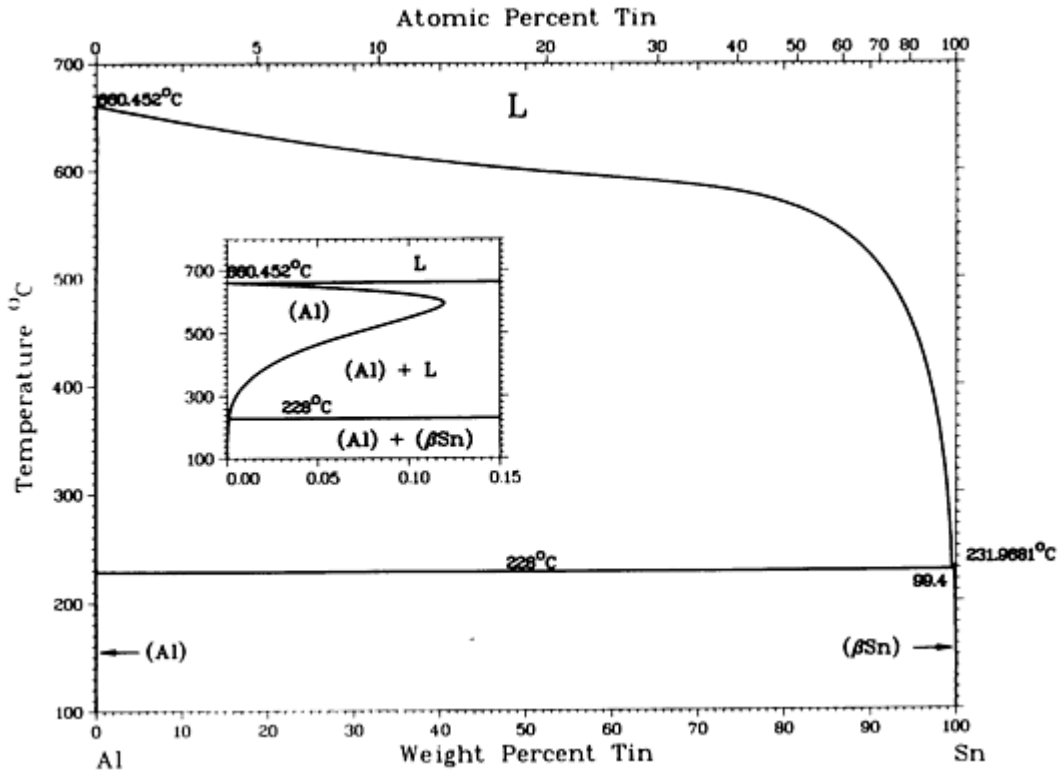

Al-Sn phase diagram

Al-Sn crystallographic data

Phase	Composition, wt% Sn	Pearson symbol	Space group
(Al)	0	<i>cF4</i>	<i>Fm$\bar{3}m$</i>
(βSn)	100	<i>tI4</i>	<i>I4₁/amd</i>
(αSn)	100	<i>cF8</i>	<i>Fd$\bar{3}m$</i>
Metastable phase			
Γ	>81.5	<i>hP1</i>	<i>P6/mmm</i>

Al-Sr (Aluminum - Strontium)

C.B. Alcock and V.P. Itkin, 1989

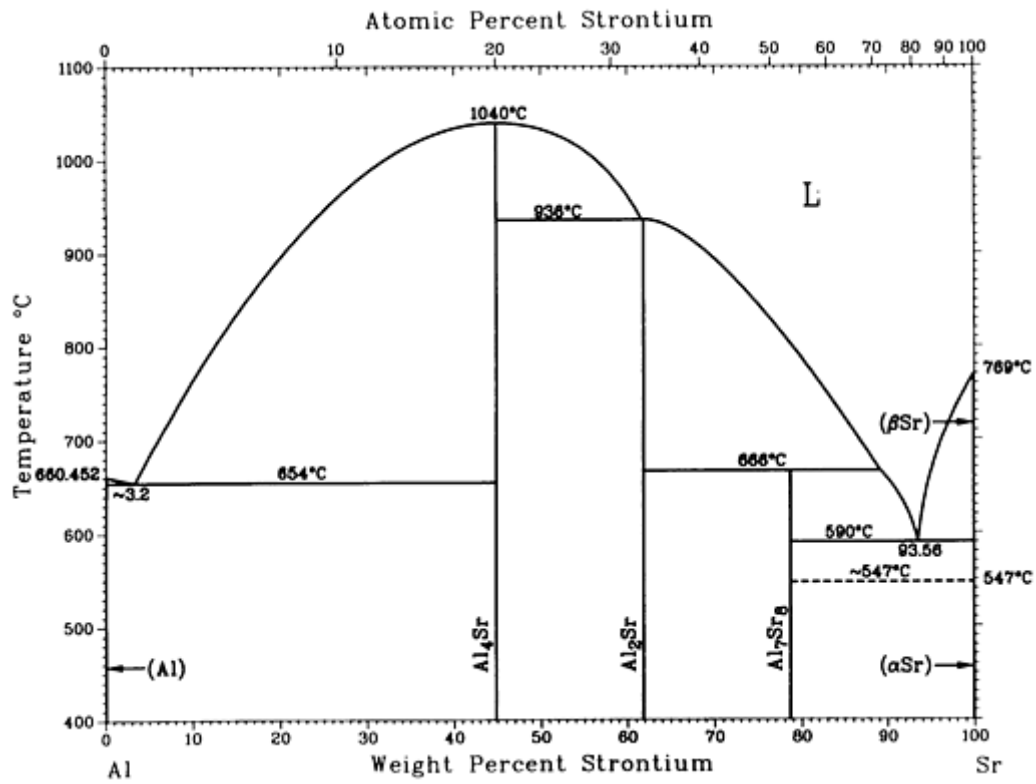

Al-Sr phase diagram

Al-Sr crystallographic data

Phase	Composition, wt% Sr	Pearson symbol	Space group
(Al)	0	<i>cF4</i>	<i>Fm</i> $\bar{3}m$
Al ₄ Sr	45	<i>tI10</i>	<i>I4/mmm</i>
Al ₂ Sr	61.9	<i>oI12</i>	<i>Imma</i>
Al ₇ Sr ₈	78.8	<i>cP60</i>	<i>P2</i> ₁ <i>3</i>
(βSr)	100	<i>cI2</i>	<i>Im</i> $\bar{3}m$
(αSr)	100	<i>cF4</i>	<i>Fm</i> $\bar{3}m$

Al-Ta (Aluminum - Tantalum)

U.R Kattner, unpublished

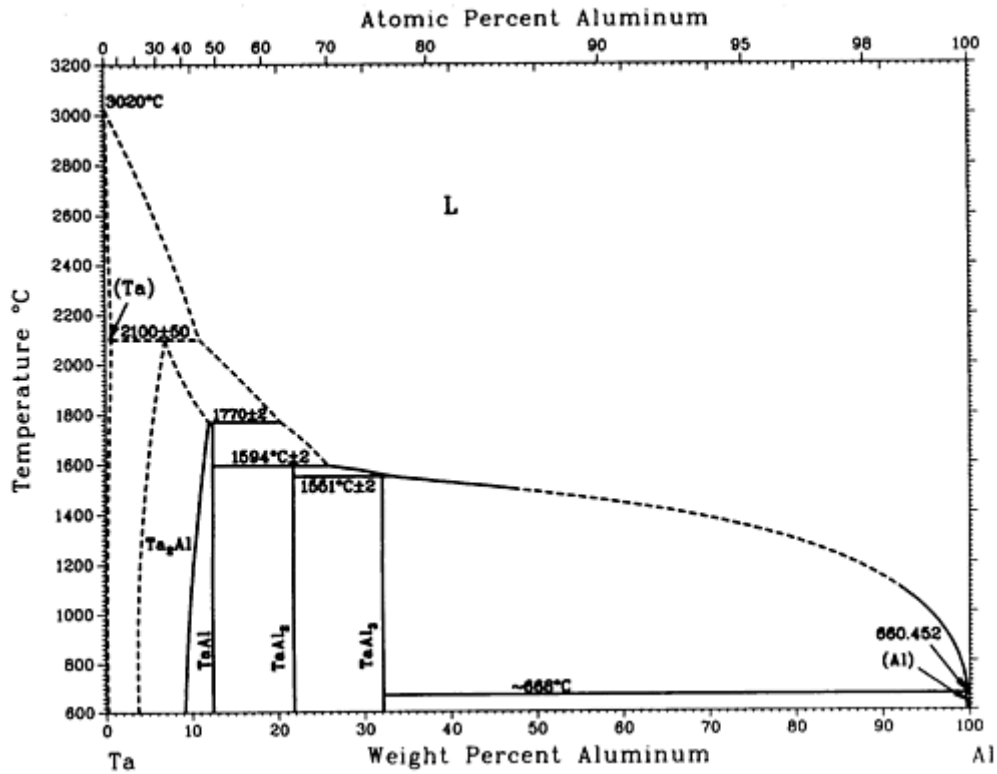

Al-Ta phase diagram

Al-Ta crystallographic data

Phase	Composition, wt% Al	Pearson symbol	Space group
(Ta)	0 to 0.6	<i>cI2</i>	<i>Im</i> $\bar{3}m$
Ta ₂ Al	4 to 9	<i>tP30</i>	<i>P4</i> ₂ / <i>mmm</i>
TaAl	12.3
TaAl ₂	22	<i>c, h, or o</i>	...
TaAl ₃	32	<i>tI8</i>	<i>I4</i> / <i>mmm</i>
(Al)	100	<i>cF4</i>	<i>Fm</i> $\bar{3}m$

Note: Different unit cells are proposed for TaAl₂.

Al-Te (Aluminum - Tellurium)

N. Prabhu and J.M. Howe, 1990

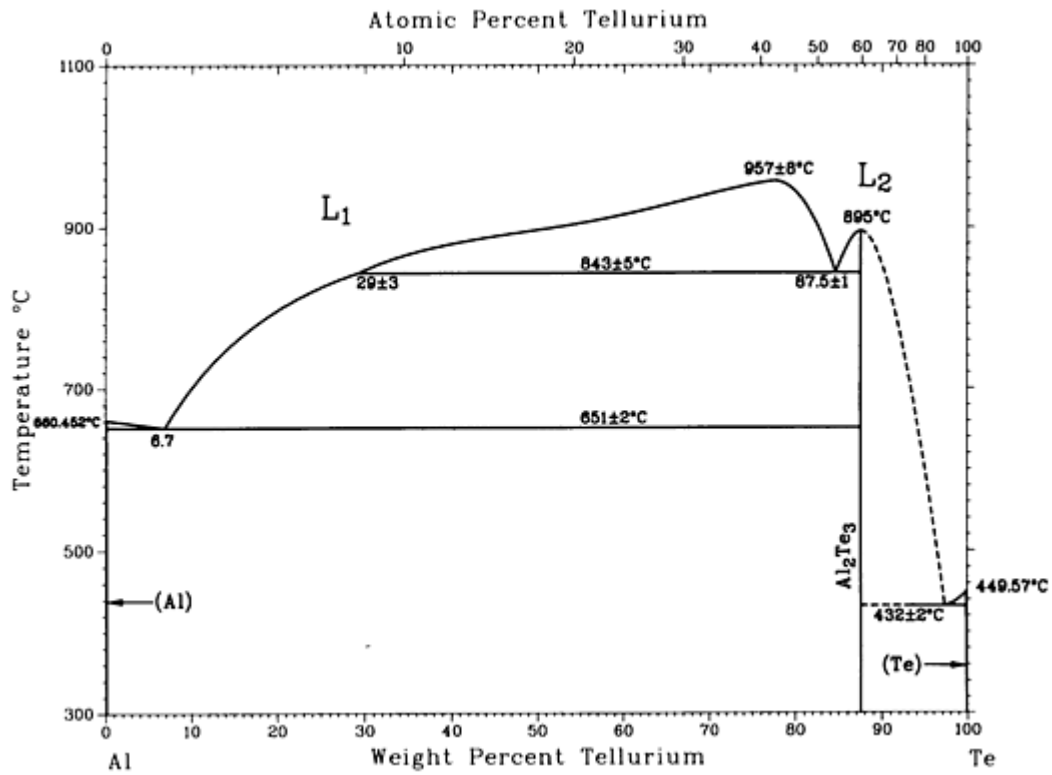

Al-Te phase diagram

Al-Te crystallographic data

Phase	Composition, wt% Te	Pearson symbol	Space group
(Al)	0	$cF4$	$Fm\bar{3}m$
Al_2Te_3	88	$hP4$	$P6_3/mc$
(Te)	100	$hP3$	$P3_121$

Al-Th (Aluminum - Thorium)

M.E. Kassner and D.E. Peterson, 1989

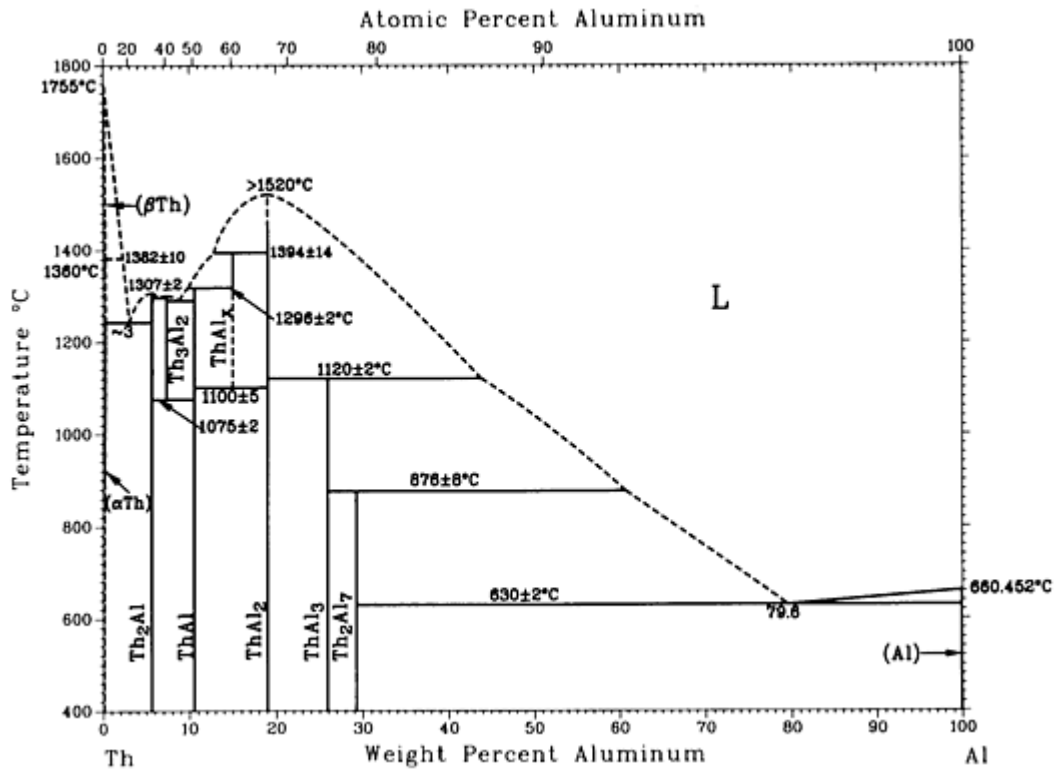

Al-Th phase diagram

Al-Th crystallographic data

Phase	Composition, wt% Al	Pearson symbol	Space group
(αTh)	0 to 0.10	<i>cF4</i>	<i>Fm</i> $\bar{3}m$
(βTh)	0	<i>cI2</i>	<i>Im</i> $\bar{3}m$
Th ₂ Al	5.5	<i>tI12</i>	<i>I4/mcm</i>
Th ₃ Al ₂	7	<i>tP10</i>	<i>P4/mbm</i>
ThAl	10.4	<i>oC8</i>	<i>Cmcm</i>
ThAl _x	15.6 to 16.2	(a)	...
Th ₂ Al ₃ ^(b)	15	(a)	...

Th ₄ Al ₇ ^(b)	16.9	(a)	...
ThAl ₂	18.9	<i>hP3</i>	<i>P6/mmm</i>
ThAl ₃	26	<i>hP8</i>	<i>P6₃/mmc</i>
Th ₂ Al ₇	29.0	<i>oP18</i>	<i>Pbam</i>
(Al)	100	<i>cF4</i>	<i>Fm$\bar{3}m$</i>

(a) Tetragonal.

(b) Considered same as ThAl_x

Al-Ti (Aluminum - Titanium)

J.L. Murray, 1987

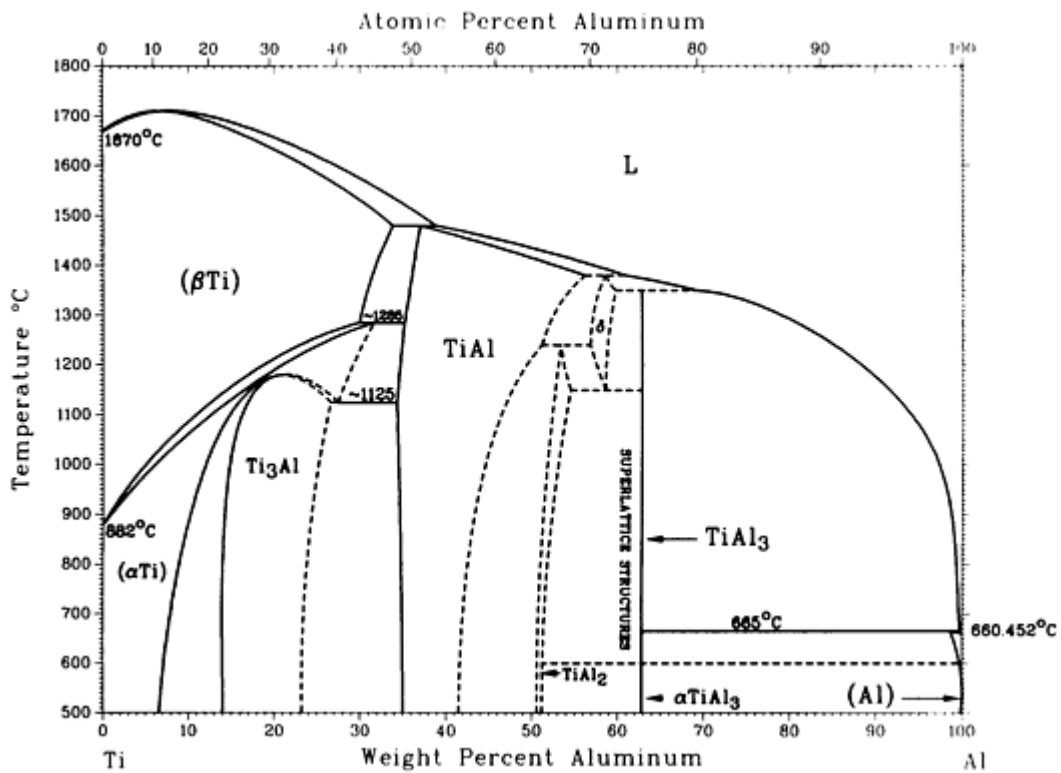

Al-Ti phase diagram

Al-Ti crystallographic data

Phase	Composition, wt% Al	Pearson symbol	Space group
(βTi)	0 to 33.8	<i>cI2</i>	<i>Im</i> $\bar{3}m$
(αTi)	0 to 32	<i>hP2</i>	<i>P6</i> $\bar{3}/mmc$
Ti ₃ Al	14 to 26	<i>hP8</i>	<i>P6</i> $\bar{3}/mmc$
TiAl	34 to 56.2	<i>tP4</i>	<i>P4/mmm</i>
Ti ₃ Al ₅ ^(a)	44 to 49	<i>tP32</i>	<i>I4/mbm</i>
TiAl ₂	51 to 54	<i>tI24</i>	<i>I4</i> $\bar{1}/amd$
αTiAl_2 ^(b)	...	<i>oC12</i>	<i>Cmmm</i>
δ	57 to 59.8	^(c)	...
TiAl ₃	63	<i>tI8</i>	<i>I4/mmm</i>
αTiAl_2	63	^(d)	...
(Al)	98.8 to 100	<i>cF4</i>	<i>Fm</i> $\bar{3}m$

(a) Not an equilibrium phase.

(b) Not shown on the assessed diagram.

(c) Long-period superlattice structures.

(d) Tetragonal; a superstructure of the *D0*₂₂ lattice

Al-U (Aluminum - Uranium)

M.E. Kassner, M.G. Adamson, P.H. Adler, and D.E. Peterson, 1990

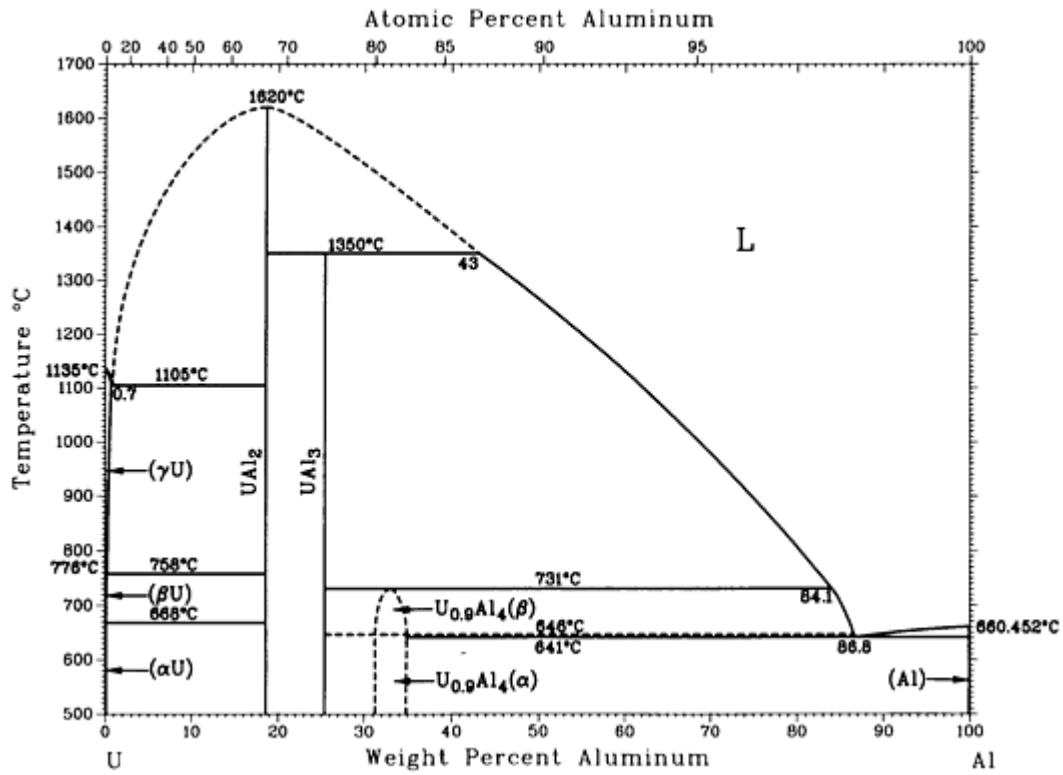

Al-U phase diagram

Al-U crystallographic data

Phase	Composition, wt% Al	Pearson symbol	Space group
(γU)	0 to 0.6	<i>cI2</i>	<i>Im</i> $\bar{3}m$
(βU)	0 to 0.06	<i>tP30</i>	<i>P</i> $\bar{4}n2$
(αU)	0	<i>oC4</i>	<i>Cmcm</i>
UAl ₂	18.5 18.5	^(a) <i>cF24</i>	... <i>Fd</i> $\bar{3}m$
UAl ₃	25 25	<i>cP4</i> ^(a)	<i>Pm</i> $\bar{3}m$...
UAl ₄ ^(b)	31	<i>oI20</i>	<i>I2ma</i> or <i>Imma</i>

$U_{0.9}Al_4(\alpha)$	33.5	<i>oI20</i>	<i>Imma</i>
$U_{0.9}Al_4(\beta)$	33.5	<i>oI20</i>	<i>Imma</i>
UAl_5	...	(c)	...
(Al)	100	<i>cF4</i>	<i>Fm$\bar{3}m$</i>

(a) Cubic.

(b) Considered same as $U_{0.9}Al_4(\alpha)$.

(c) Unknown.

Al-V (Aluminum - Vanadium)

J.L. Murray, 1989

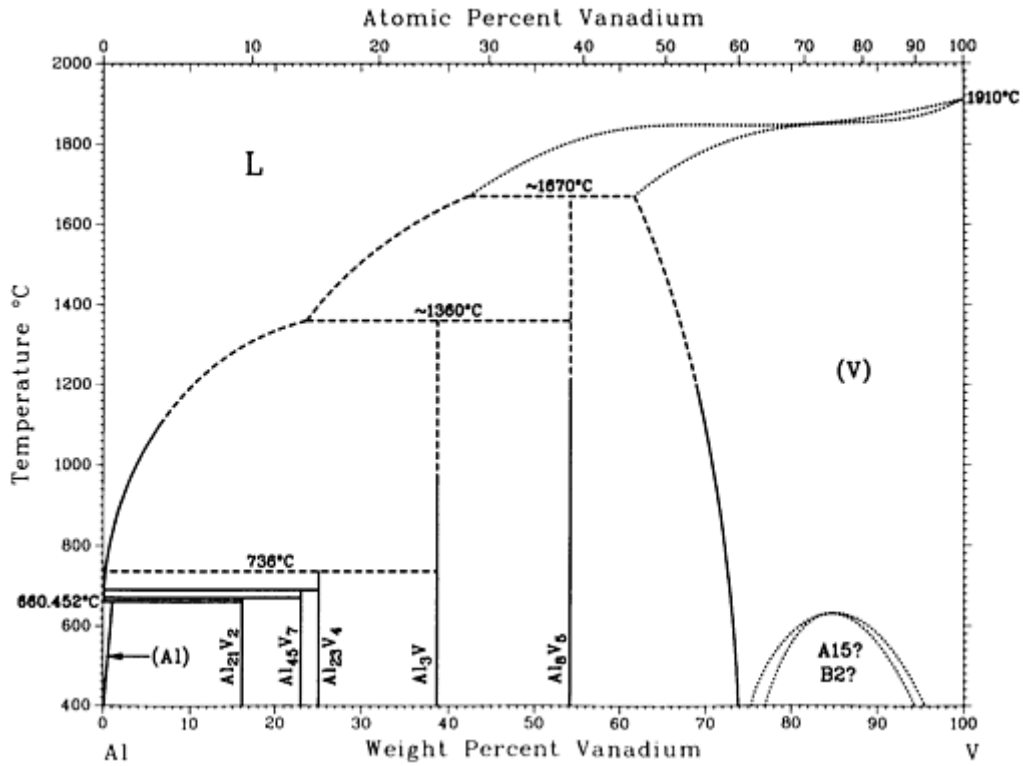

Al-V phase diagram

Al-V crystallographic data

Phase	Composition, wt% V	Pearson symbol	Space group
(Al)	0 to 0.6	<i>cF4</i>	<i>Fm</i> $\bar{3}m$
Al ₂₁ V ₂	~15.3 to 15.9	<i>cF176</i>	<i>Fd</i> $\bar{3}m$
Al ₄₅ V ₇	~23.1	<i>mC104</i>	<i>C2/m</i>
Al ₂₃ V ₄	~24.7	<i>hP54</i>	<i>P6₃/mmc</i>
Al ₃ V	~39	<i>tI8</i>	<i>I4/mmm</i>
Al ₈ V ₅	54.2	<i>cI52</i>	<i>I4</i> $\bar{3}m$
(V)	~65 to 100	<i>cI2</i>	<i>Im</i> $\bar{3}m$
AlV ₃	(a)	<i>cP8</i>	<i>Pm</i> $\bar{3}m$
β AlV ₃	(a)	<i>h**</i>	...
α AlV ₃	(a)	<i>t**</i>	...

Note: The structure of Al₂₃V₄ is related to that of Co₂Al₅ (ϕ). It contains nearly regular icosahedra as structural elements.

(a) Unknown

Al-W (Aluminum - Tungsten)

From [Metals] 10

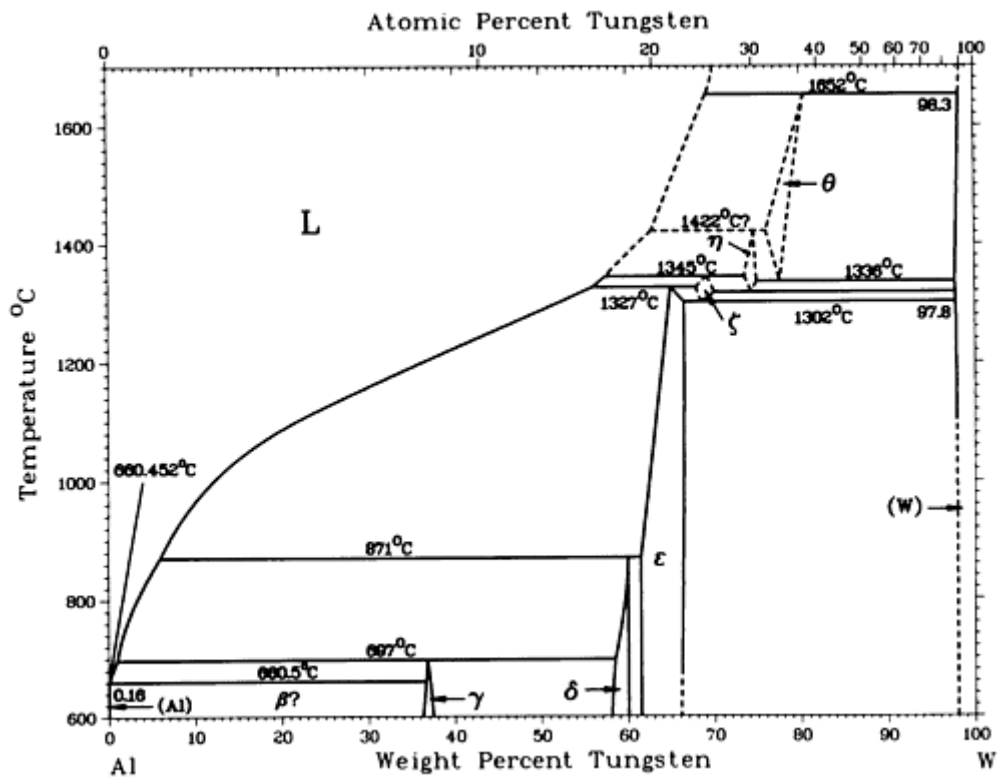

Al-W phase diagram

Al-W crystallographic data

Phase	Composition, wt% W	Pearson symbol	Space group
(Al)	0	$cF4$	$Fm\bar{3}m$
γ	~37	$cI26$	$Im\bar{3}$
δ	~58 to 60	$hP12$	$P6_3$
ϵ	~62 to 66	$mC30$	Cm
(W)	100	$cI2$	$Im\bar{3}m$

Reference cited in this section

- [Metals]: *Metals Handbook*, Metallography, Structures and Phase Diagrams, Vol.8, 8th ed., American Society for Metals, Metals Park, OH (1973).

Al-Y (Aluminum - Yttrium)

K.A. Gschneidner, Jr. and F.W. Calderwood, 1989

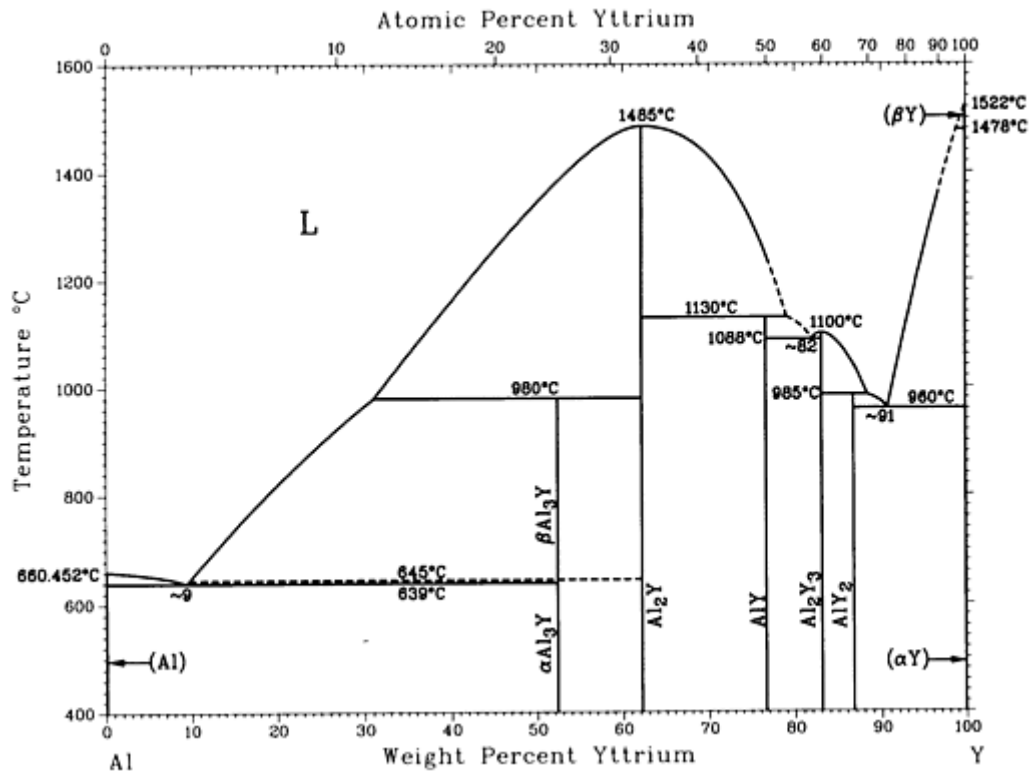

Al-Y phase diagram

Al-Y crystallographic data

Phase	Composition, wt% Y	Pearson symbol	Space group
(Al)	0 to ~0.17	<i>cF4</i>	<i>Fm</i> $\bar{3}m$
α -Al ₃ Y	52	<i>hP8</i>	<i>P6</i> ₃ / <i>mmc</i>
β -Al ₃ Y	52	<i>hR12</i>	<i>R</i> $\bar{3}m$
Al ₂ Y	62.2	<i>cF24</i>	<i>Fd</i> $\bar{3}m$
AlY	76.7	<i>oC8</i>	<i>Cmcm</i>
Al ₂ Y ₃	83	<i>tP20</i>	<i>P4</i> ₂ / <i>mnm</i>
AlY ₂	86.8	<i>oP12</i>	<i>Pnma</i>

$AlY_3^{(a)}$	91	$cP4$	$Pm\bar{3}m$
(αY)	100	$hP2$	$P6_3/mmc$
(βY)	100	$cI2$	$Im\bar{3}m$

(a) Metastable

Al-Yb (Aluminum - Ytterbium)

K.A. Gschneidner, Jr. and F.W. Calderwood, 1989

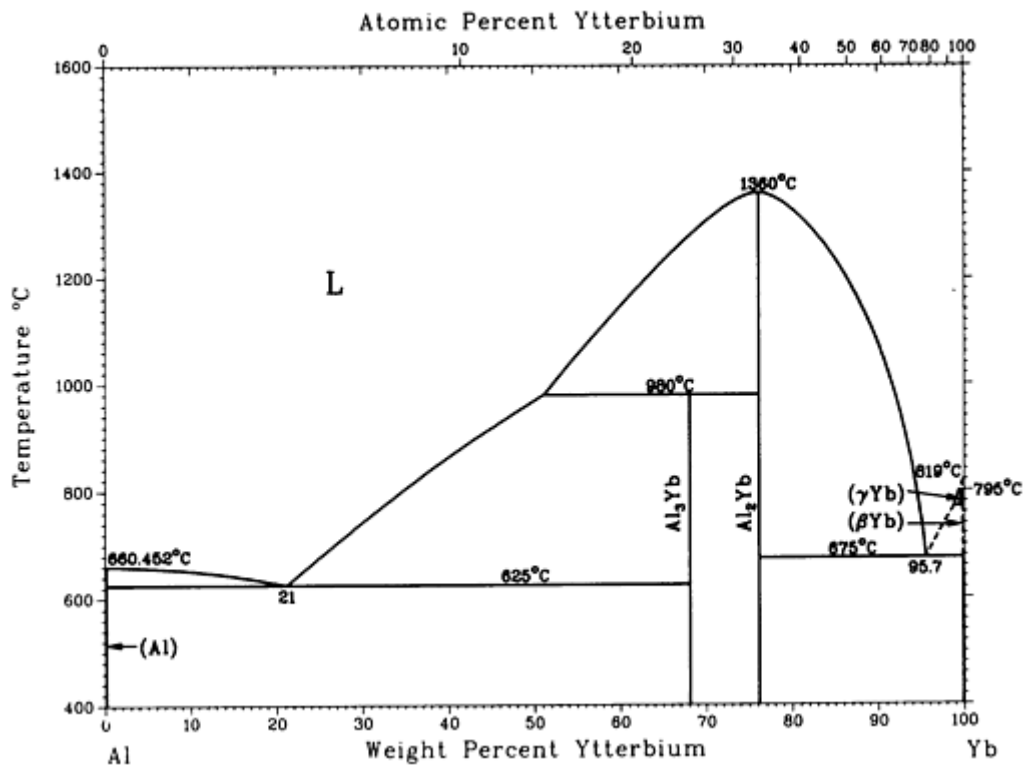

Al-Yb phase diagram

Al-Yb crystallographic data

Phase	Composition, wt% Yb	Pearson symbol	Space group
(Al)	0	$cF4$	$Fm\bar{3}m$
Al_3Yb	68	$cP4$	$Pm\bar{3}m$

Al ₂ Yb	76.2	<i>cF24</i>	<i>Fd$\bar{3}m$</i>
(γ Yb)	99.6 to 100	<i>cI2</i>	<i>Im$\bar{3}m$</i>
(β Yb)	99.9 to 100	<i>cF4</i>	<i>Fm$\bar{3}m$</i>

Al-Zn (Aluminum - Zinc)

J.L. Murray, 1983

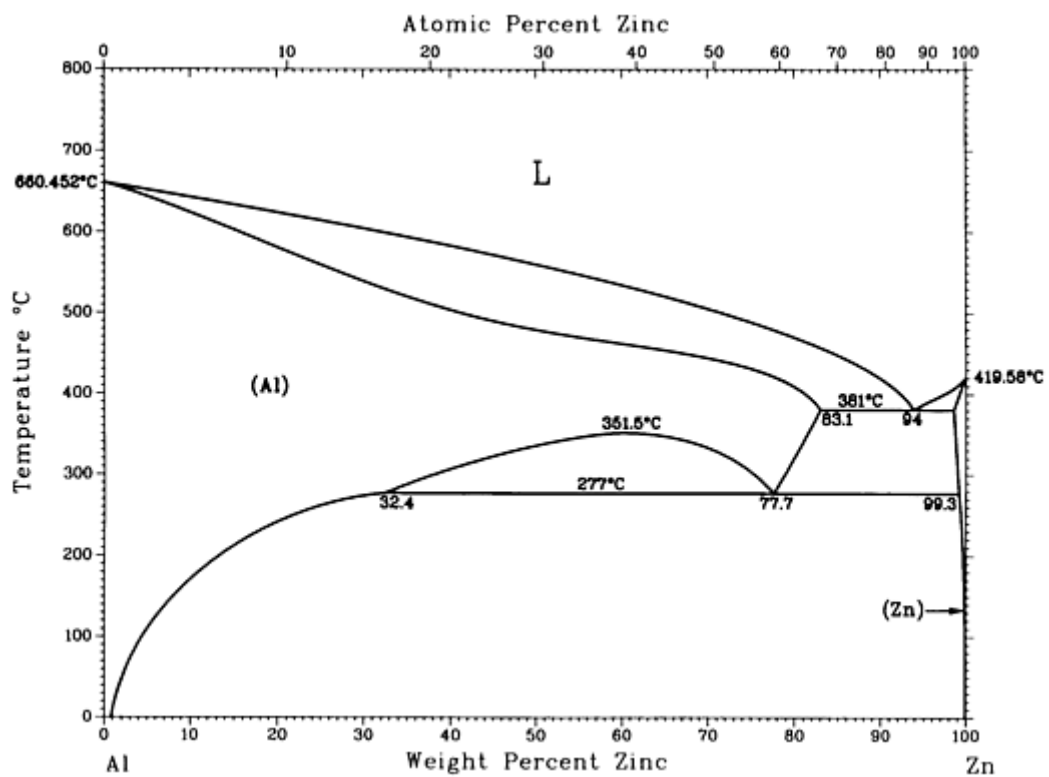

Al-Zn phase diagram

Al-Zn crystallographic data

Phase	Composition, wt% Zn	Pearson symbol	Space group
(Al)	0 to 83.1	<i>cF4</i>	<i>Fm$\bar{3}m$</i>
(Zn)	98.8 to 100	<i>hP2</i>	<i>P6₃/mmc</i>
Metastable phases			

$(\alpha'Al)_R$	78 to ~ 85	...	$R\bar{3}m$
"R"	(a)
Y

(a) Coherent precipitate

Al-Zr (Aluminum - Zirconium)

J. Murray, A. Peruzzi, and J.P. Abriata, 1992

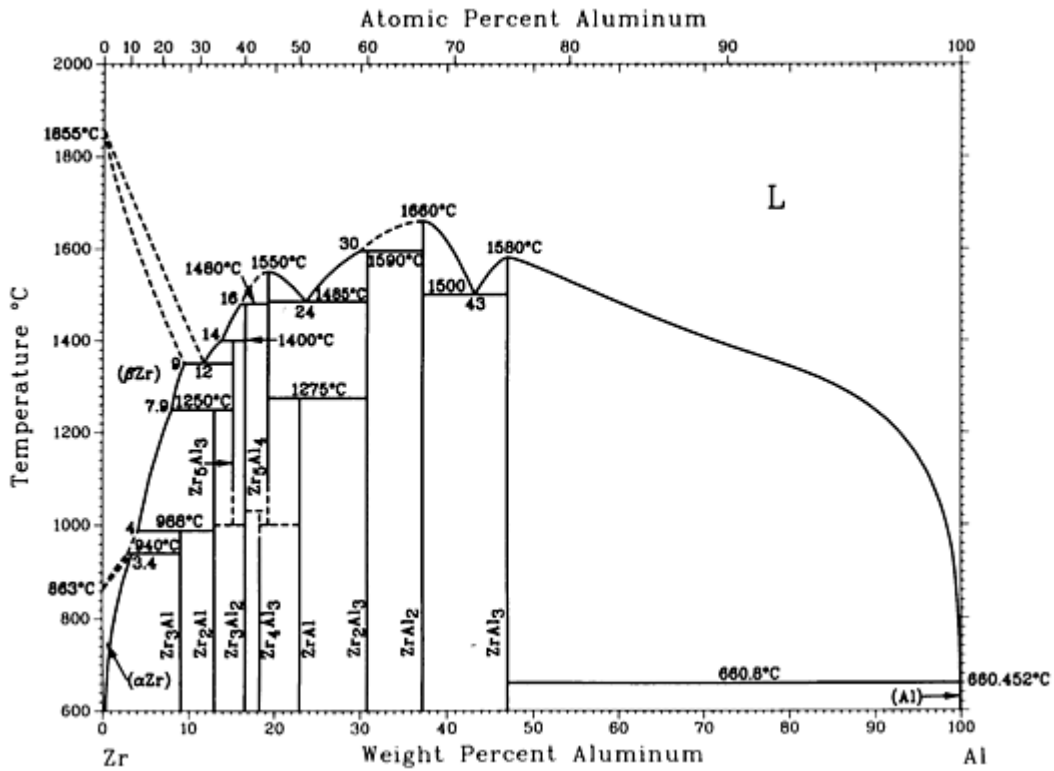

Al-Zr phase diagram

Al-Zr crystallographic data

Phase	Composition, wt% Al	Pearson symbol	Space group
(αZr)	0 to 3.4	$hP2$	$P6_3/mmc$
(βZr)	0 to 9.4	$cI2$	$Im\bar{3}m$

Zr ₃ Al	9.0	<i>cP4</i>	<i>Pm</i> $\bar{3}m$
Zr ₂ Al	12.9	<i>hP6</i>	<i>P6₃/mmc</i>
Zr ₅ Al ₃	15.1	<i>tI32</i>	<i>I4/mcm</i>
Zr ₃ Al ₂	16	<i>tP20</i>	<i>P4₂/mmm</i>
Zr ₄ Al ₃	18.2	<i>hP7</i>	<i>P</i> $\bar{6}$
Zr ₅ Al ₄	19.1	<i>hP18</i>	<i>P6₃/mcm</i>
ZrAl	22.8	<i>oC8</i>	<i>Cmcm</i>
Zr ₂ Al ₃	31	<i>oF40</i>	<i>Fdd2</i>
ZrAl ₂	37.2	<i>hP12</i>	<i>P6₃/mmc</i>
ZrAl ₃	47	<i>tI16</i>	<i>I4/mmm</i>
(Al)	99.86 to 100	<i>cF4</i>	<i>Fm</i> $\bar{3}m$

As (Arsenic) Binary Alloy Phase Diagrams

Introduction

THIS ARTICLE includes systems where arsenic is the first-named element in the binary pair. Additional binary systems that include arsenic are provided in the following locations in this Volume:

- “Ag-As (Silver - Arsenic)” in the article “Ag (Silver) Binary Alloy Phase Diagrams.”
- “Al-As (Aluminum - Arsenic)” in the article “Al (Aluminum) Binary Alloy Phase Diagrams.”

As-Bi (Arsenic - Bismuth)

G.A. Geach and R.A. Jettery, 1953

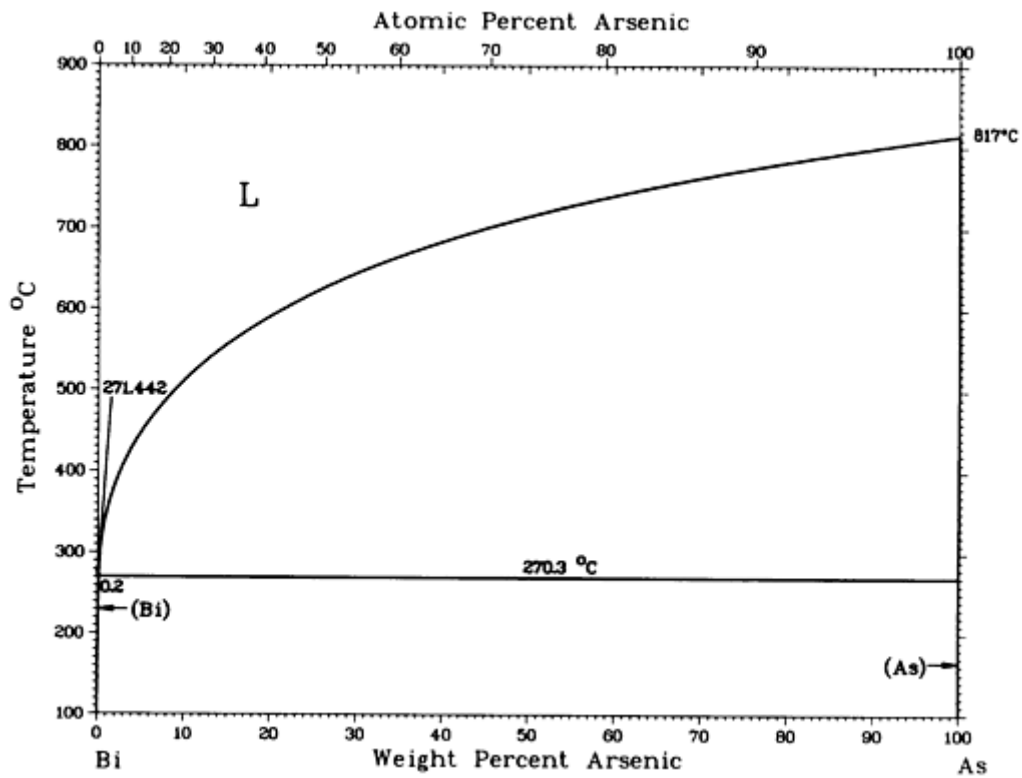

As-Bi phase diagram

As-Bi crystallographic data

Phase	Composition, wt% As	Pearson symbol	Space group
(Bi)	0 to ~0.2	$hR2$	$R\bar{3}m$
(As)	~100	$hR2$	$R\bar{3}m$

As-Cd (Arsenic - Cadmium)

H. Okamoto, 1992

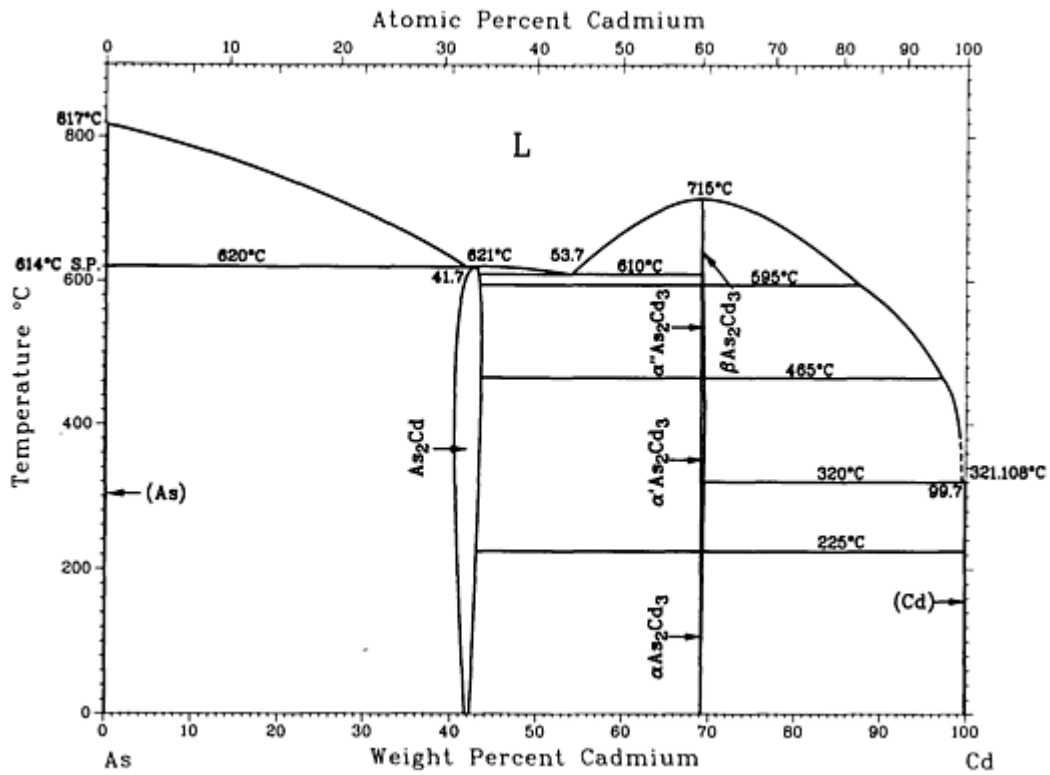

As-Cd phase diagram

As-Cd crystallographic data

Phase	Composition, wt% Cd	Pearson symbol	Space group
(As)	0	<i>hR2</i>	$R\bar{3}m$
As ₂ Cd	42.8	<i>tI12</i>	$I4_122$
β _{As₂Cd₃}	69	<i>cF12</i>	$Fm\bar{3}m$
α'' _{As₂Cd₃}	69	<i>tP40</i>	$P4_2/nmc$
α' _{As₂Cd₃}	69	<i>tP160</i>	$P4_2/nbc$
α _{As₂Cd₃}	69	<i>tI160</i>	$I4_1cd$
(Cd)	100	<i>hP2</i>	$P6_3/mmc$

High-pressure phases			
As ₂ CdII	42.8
As ₂ CdIII ^(a)	42.8
AsCd	60	<i>oP16</i>	<i>Pbca</i>
As ₂ Cd ₃ ^(b)	69	<i>hP30</i>	...
As ₂ Cd ₃ II ^(c)	69	<i>hP5</i> <i>oP*</i>	<i>P$\bar{3}m1$</i> <i>Pmmn</i>
As ₂ Cd ₃ II'	69
As ₂ Cd ₃ III	69
As ₂ Cd ₃ III'	69
Metastable phase			
As ₄ Cd	27	<i>t*20</i>	...
Other phases			
As ₂ Cd ₃ ^(d)	69	<i>iI160</i>	<i>I4₁/acd</i>
As ₂ Cd ₃ ^(e)	69	<i>iI160</i>	<i>I4₁a</i>
As₂Cd₃^(f)	69	<i>iI160</i>	<i>Iacd</i>

(a) >46 kbar.

(b) 55 kbar.

(c) 30 kbar.

(d) Also might be β As₂Cd₃.

(e) Vapor deposition.

(f) Synthesis at 675 °C

As-Co (Arsenic - Cobalt)

K. Ishida and T. Nishizawa, 1990

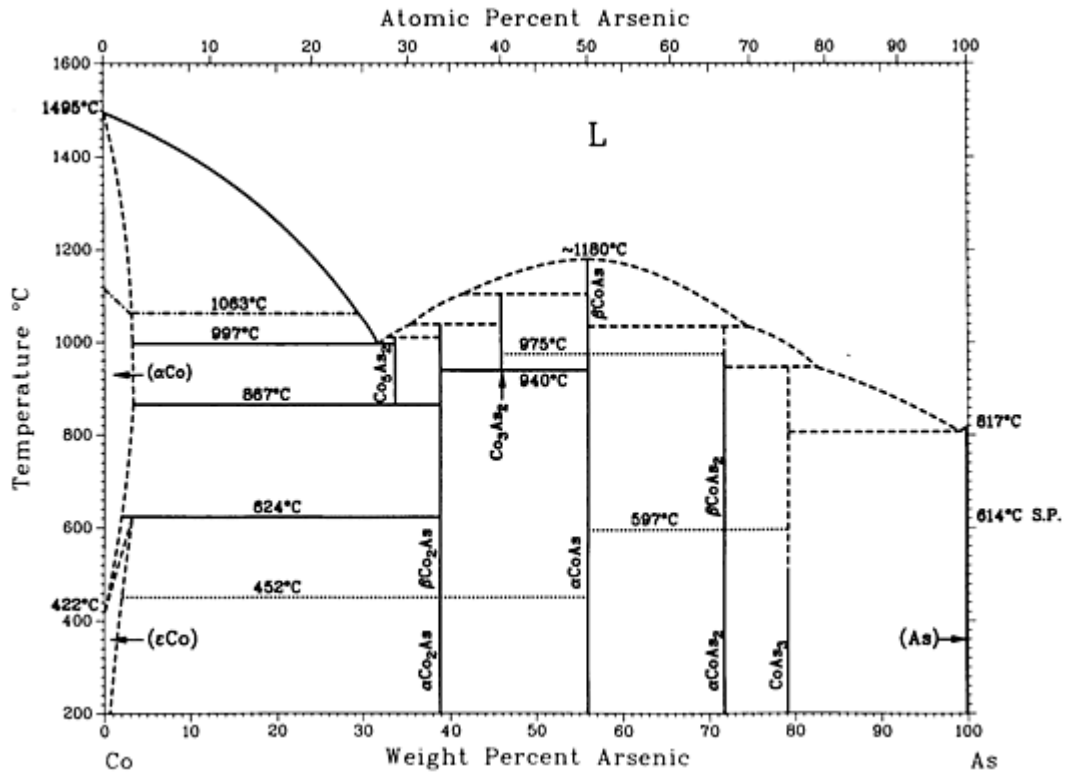

As-Co phase diagram

As-Co crystallographic data

Phase	Composition, wt% As	Pearson symbol	Space group
(αCo)	0 to ~3.2	<i>cF4</i>	<i>Fm</i> $\bar{3}m$
(εCo)	0 to ~3	<i>hP2</i>	<i>P6₃/mmc</i>
Co ₃ As ₂	33.7	<i>hP42</i>	<i>P6₃cm</i>
βCo ₂ As ^(a)	38.8 to 39.2	<i>hP9</i>	<i>P62m</i>
αCo ₂ As ^(a)	38.8

Co_3As_2	46	?	?
βCoAs	55.9	$hP4$	$P6_3/mmc$
αCoAs	55.9	$oP8$	$Pna2_1$
βCoAs_2	71.8	$oP6$	$Pnmm$
αCoAs_2	71.8	$mP12$	$P2_1/c$
CoAs_3	79 to 79.2	$cI32$	$Im\bar{3}$
(As)	~ 100	$hR2$	$R\bar{3}m$

(a) $\alpha\text{Co}_2\text{As}$ (low-temperature form) transforms into $\beta\text{Co}_2\text{As}$ (high-temperature form) at 452 °C

As-Cu (Arsenic - Copper)

P.R. Subramanian and D.E. Laughlin, 1988

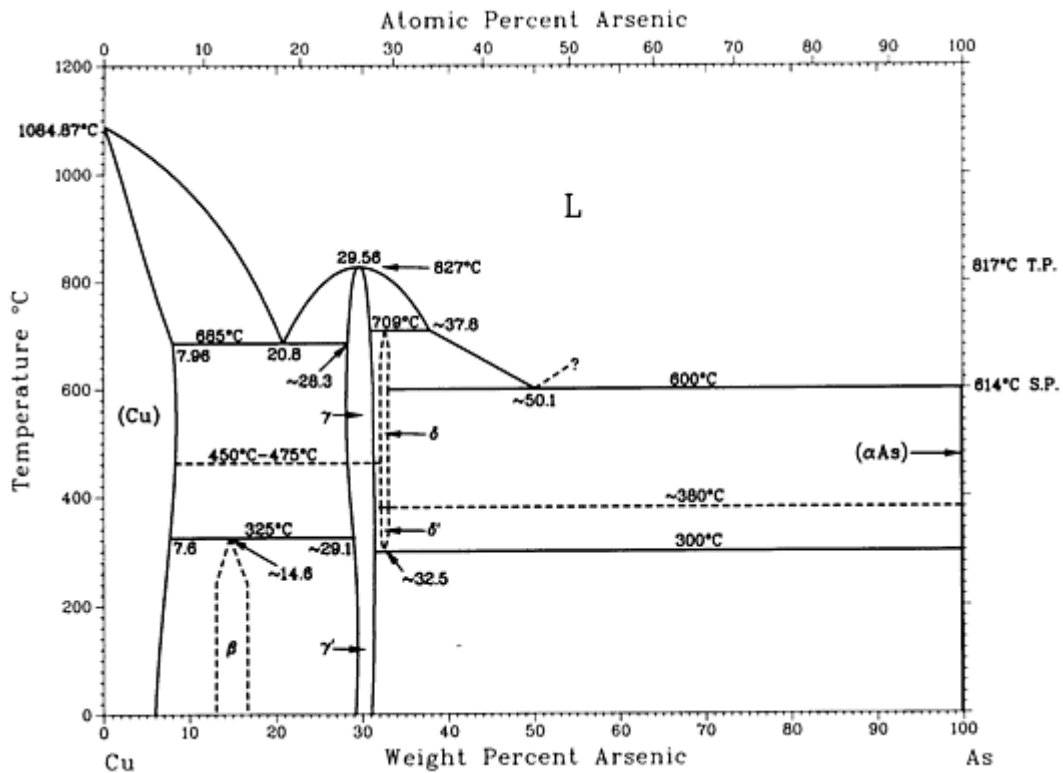

As-Cu phase diagram

As-Cu crystallographic data

Phase	Composition, wt% As	Pearson symbol	Space group
(Cu)	0 to ~ 7.96	<i>cF4</i>	<i>Fm</i> $\bar{3}m$
β	12.8 to 16.4	<i>hP2</i>	<i>P6</i> $_3/mmc$
γ' (HT)	28.2 to 31.2	<i>hP8</i>	<i>P6</i> $_3/mmc$
γ (LT)	28.8 to 31.2	<i>hP24</i>	<i>P</i> $\bar{3}c1$
δ (HT)	32.1 to 33.1	<i>cF16</i>	<i>Fm</i> $\bar{3}m$
δ' (LT)	32.1 to 33.1	<i>oI28</i>	<i>Ibam</i>
(As)	100	<i>hR2</i>	<i>R</i> $\bar{3}m$
Metastable phases			
Cu_2As	~ 37.1	<i>tP6</i>	<i>P4/nmm</i>
Cu_3As_4	~ 61.12	<i>oI28</i>	<i>Immm</i>

As-Fe (Arsenic - Iron)

H. Okamoto, 1992

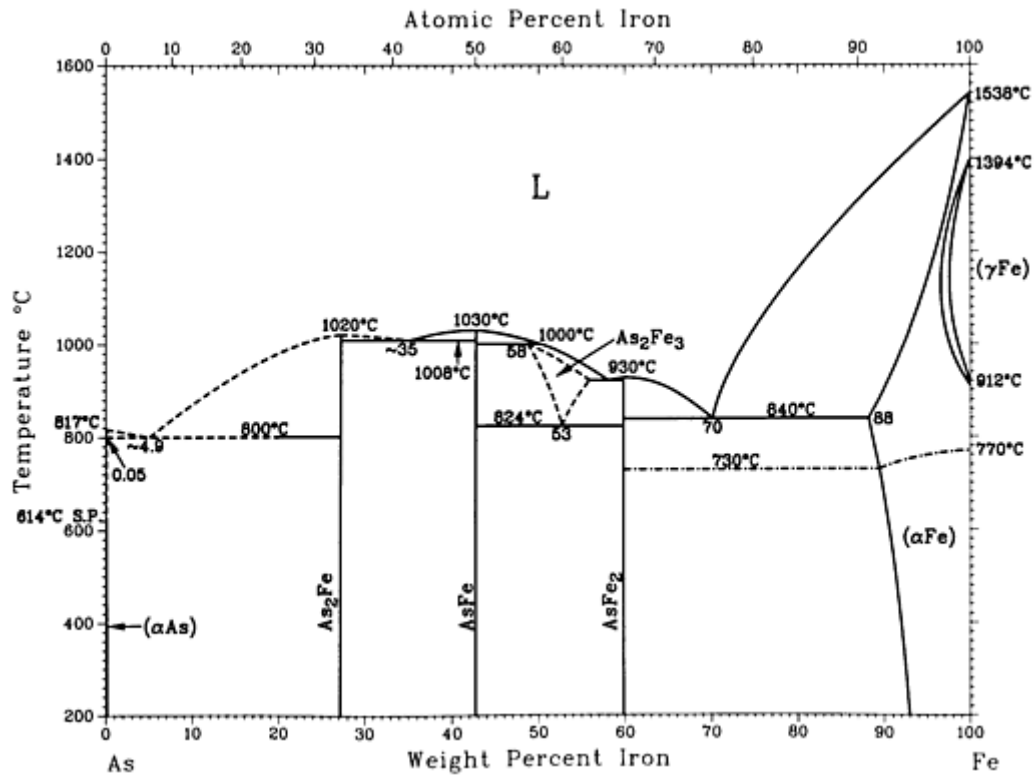

As-Fe phase diagram

As-Fe crystallographic data

Phase	Composition, wt% Fe	Pearson symbol	Space group
(αAs)	0 to 0.05	<i>hR2</i>	<i>R</i> $\bar{3}m$
As ₂ Fe	27.1	<i>oP6</i>	<i>Pnmm</i>
AsFe	42.7	<i>oP8</i>	<i>Pnma</i>
As ₂ Fe ₃	50 to 55
AsFe ₂	59.9	<i>tP6</i>	<i>P4/nmm</i>
(αFe)	88 to 100	<i>cI2</i>	<i>Im</i> $\bar{3}m$
(γFe)	98.7 to 100	<i>cF4</i>	<i>Fm</i> $\bar{3}m$

High-pressure phase			
As ₅ Fe ₁₂	64.2	<i>hR17</i>	<i>R3</i>

As-Ga (Arsenic - Gallium)

H. Okamoto, 1990

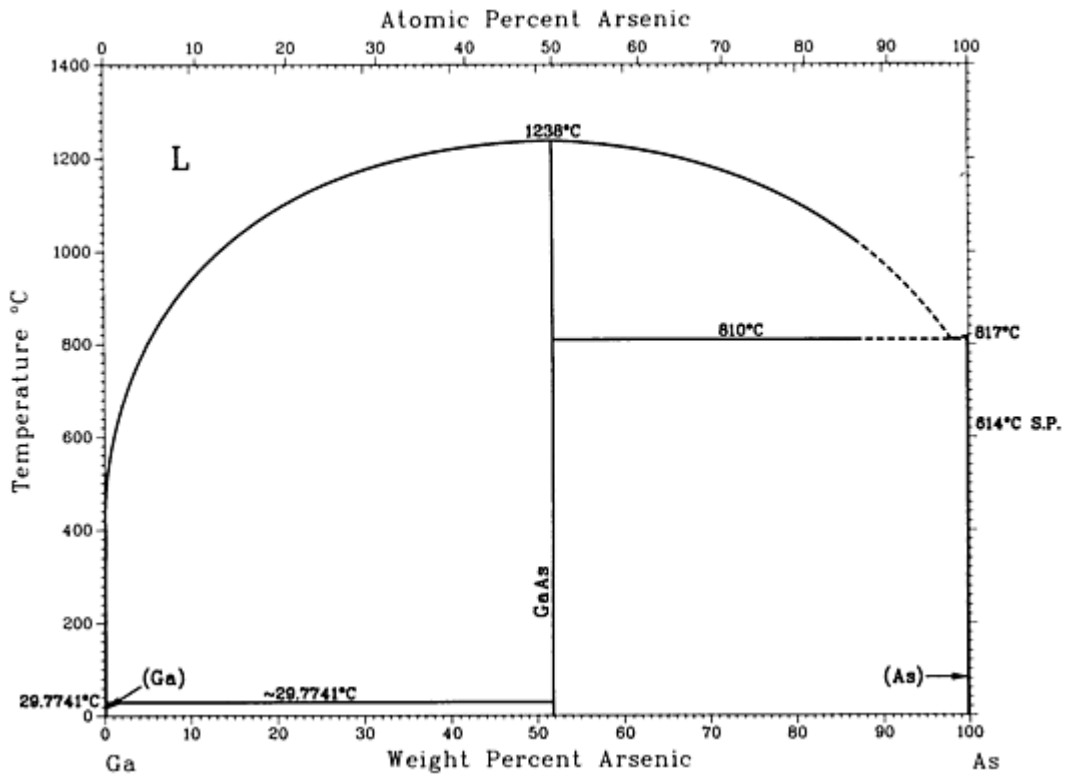

As-Ga phase diagram

As-Ga crystallographic data

Phase	Composition, wt% As	Pearson symbol	Space group
(Ga)	0	<i>oC8</i>	<i>Cmca</i>
GaAs	51.8	<i>cF8</i>	$F\bar{4}3m$
(As)	100	<i>hR2</i>	$R\bar{3}m$

As-Ge (Arsenic - Germanium)

H. Okamoto, 1991

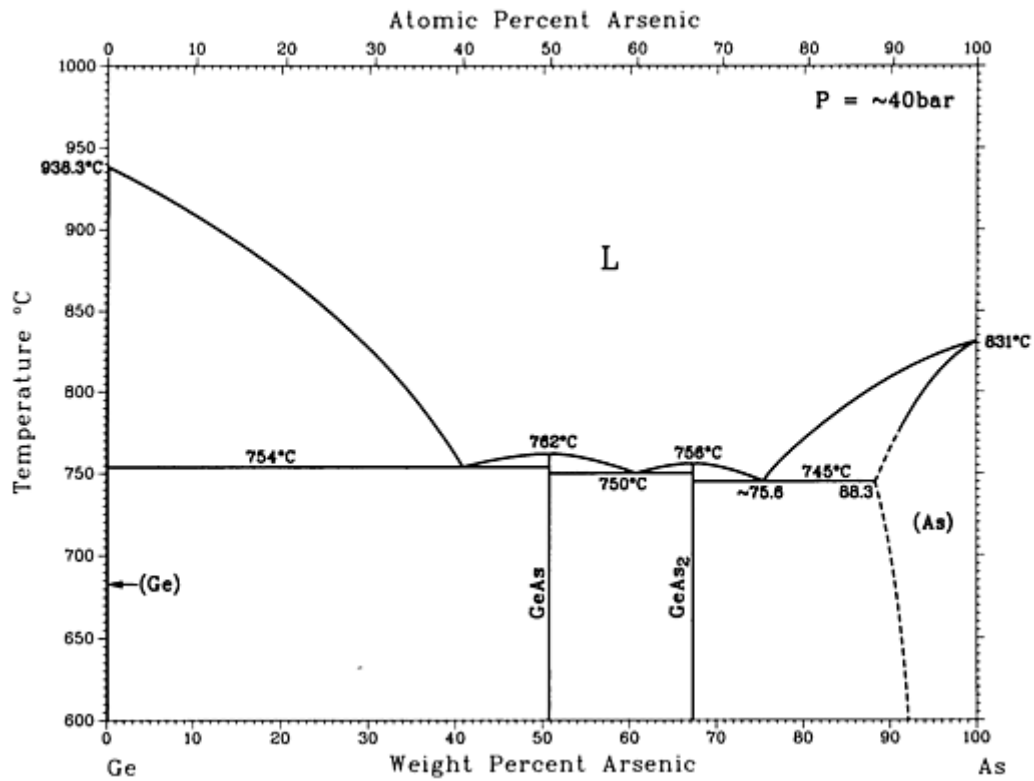

As-Ge phase diagram

As-Ge crystallographic data

Phase	Composition, wt% As	Pearson symbol	Space group
(Ge)	0 to 0.19	<i>cF8</i>	<i>Fm</i> $\bar{3}m$
GeAs	50.8	<i>mC24</i>	<i>C2/m</i>
GeAs ^(a)	50.8	<i>tI4</i>	<i>I4mm</i>
GeAs ₂	67.4	<i>oP24</i>	<i>Pbam</i>
(As)	88 to 100	<i>hR2</i>	<i>R</i> $\bar{3}m$

(a) High-pressure phase

As-In (Arsenic - Indium)

H. Okamoto, 1992

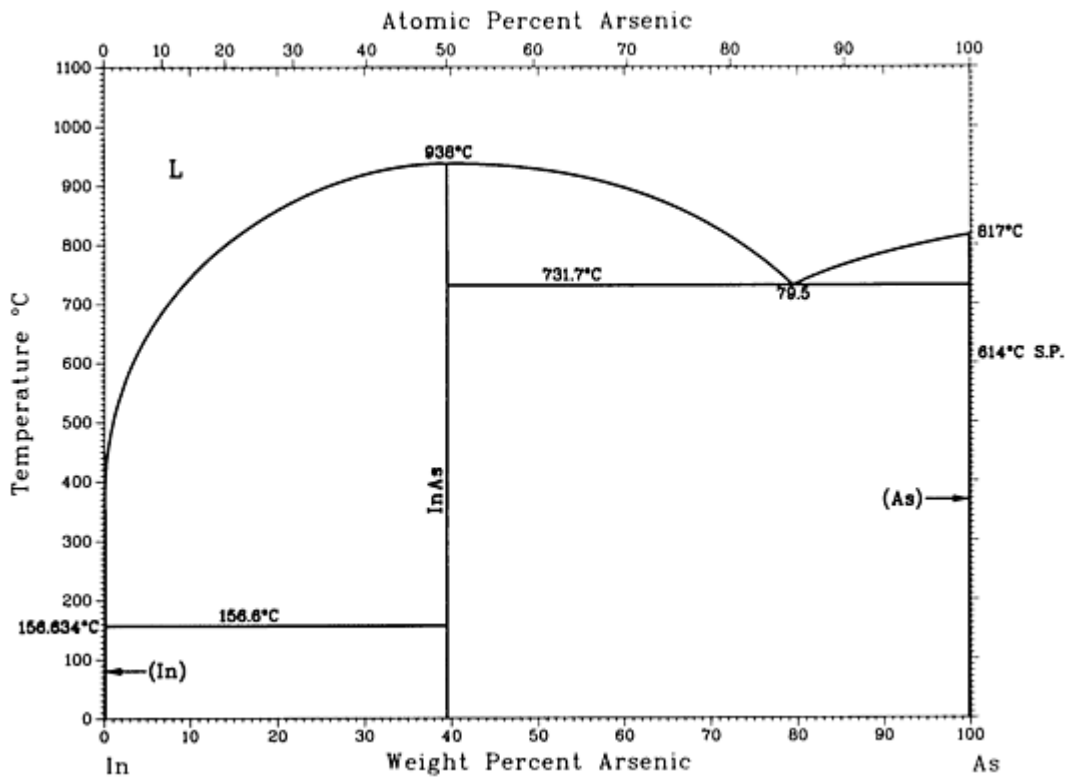

As-In phase diagram

As-In crystallographic data

Phase	Composition, wt% As	Pearson symbol	Space group
Stable phases			
(In)	0	<i>tI2</i>	<i>I4/mmm</i>
InAs	39.5	<i>cF8</i>	<i>F$\bar{4}3m$</i>
(As)	100	<i>hR2</i>	<i>R$\bar{3}m$</i>
High-pressure phases			
InAs II ^(a)	39.5	<i>cF8</i>	<i>Fm$\bar{3}m$</i>
InAs III ^(b)	39.5	<i>tI4</i>	<i>I4/amd</i>

(a) Between 7 and 15 GPa.

(b) Above 17 GPa (hysteresis between 15 and 17 GPa)

As-K (Arsenic - Potassium)

F.W. Dorn, W. Klemm, and S. Lohmeyer, 1961

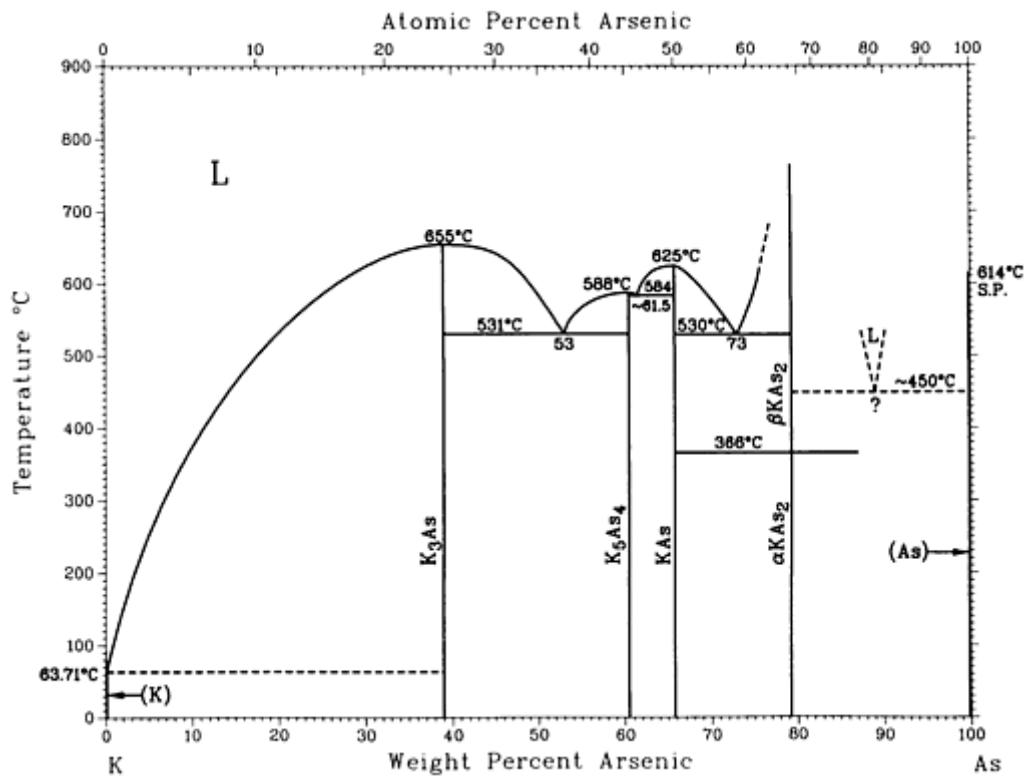

As-K phase diagram

As-K crystallographic data

Phase	Composition, wt% As	Pearson symbol	Space group
(K)	~0	<i>cI2</i>	$Im\bar{3}m$
K_3As	39	<i>hP8</i>	$P6_3/mmc$
K_5As_4	60.5
KAs	65.7	<i>oP16</i>	$P2_12_12_1$

β_{KAs_2}	79.3
α_{KAs_2}	79.3
(As)	~ 100	<i>hR8</i>	$R\bar{3}m$

As-Mn (Arsenic - Manganese)

H. Okamoto, 1989

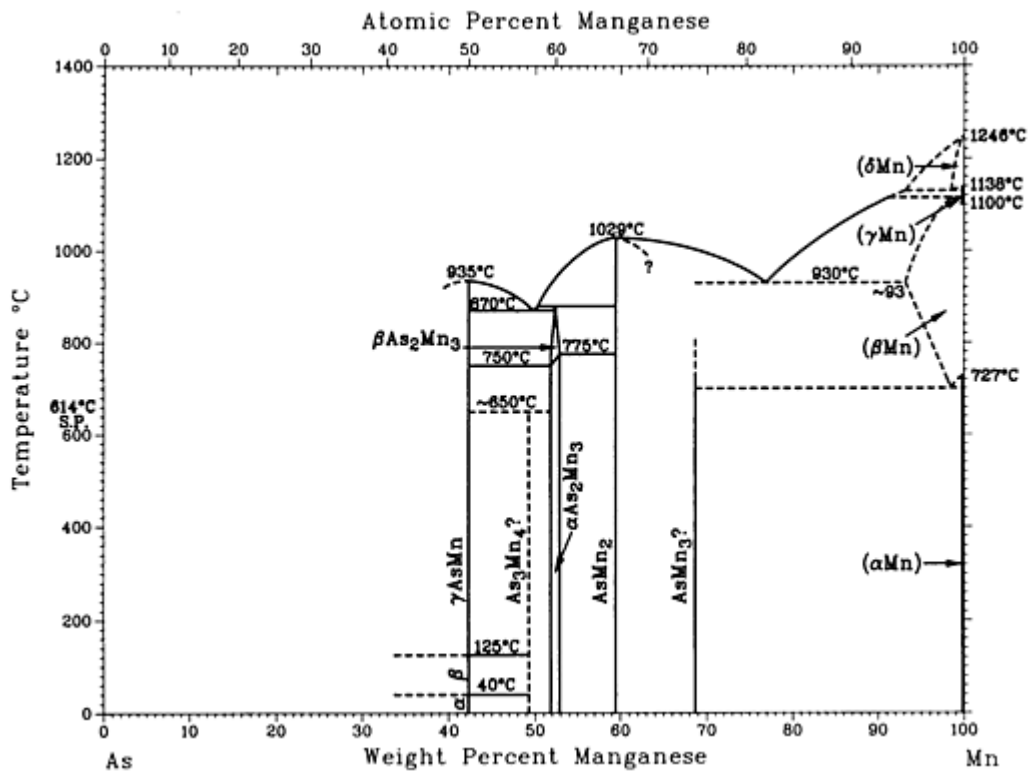

As-Mn phase diagram

As-Mn crystallographic data

Phase	Composition, wt% Mn	Pearson symbol	Space group
(As)	0	<i>hR2</i>	$R\bar{3}m$
γAsMn	42.3	<i>hP4</i>	$P6_3/mmc$
βAsMn	42.3	<i>oP8</i>	$Pnma$

αAsMn	42.3	$hP4$	$P6_3/mmc$
As_3Mn_4	49.4	tI^*	...
$\beta\text{As}_2\text{Mn}_3$	52
$\alpha\text{As}_2\text{Mn}_3$	52	(a)	...
AsMn_2	59.5	$tP6$	$P4/nmm$
AsMn_3	69	$oP16$	$Pmmn$
(δMn)	100	$cI2$	$Im\bar{3}m$
(γMn)	100	$cF4$	$Fm\bar{3}m$
(βMn)	~ 93 to 100	$cP20$	$P4_132$
(αMn)	100	$cI58$	$I4\bar{3}m$
High-pressure phase			
AsMn_2	59.5	$hP9$	$P\bar{6}2m$

(a) Distorted cubic

As-Nd (Arsenic - Neodymium)

K.A. Gschneidner, Jr. and F.W. Calderwood, 1986

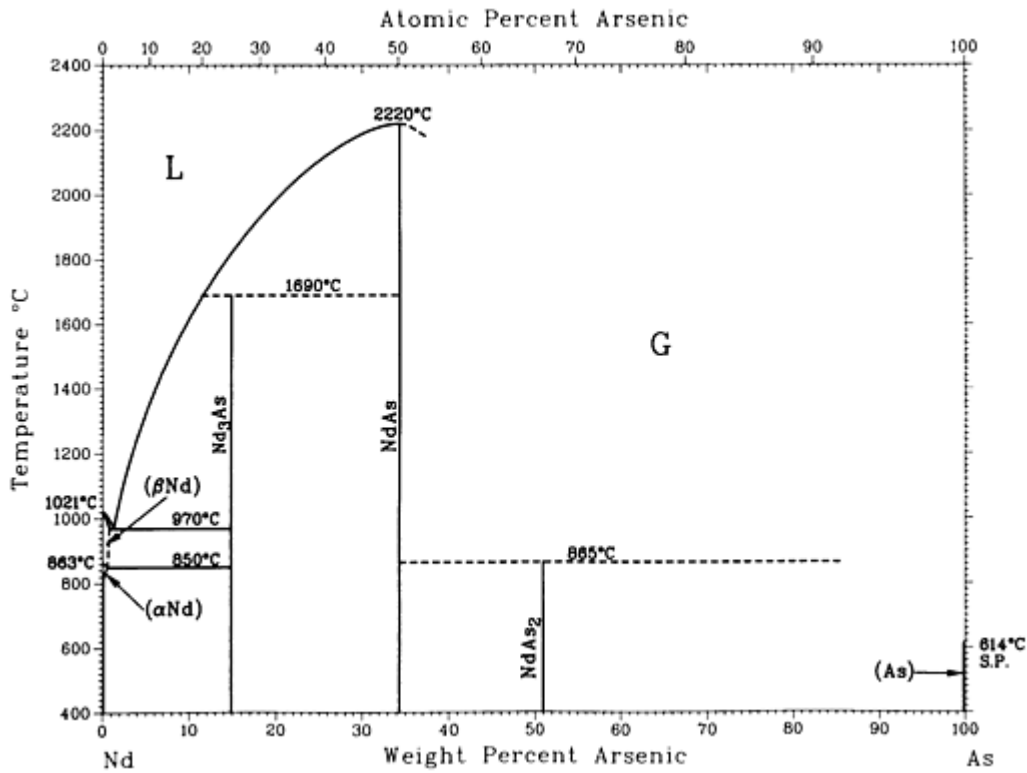

As-Nd phase diagram

As-Nd crystallographic data

Phase	Composition, wt% As	Pearson symbol	Space group
(α Nd)	0	<i>hP4</i>	<i>P6₃/mmc</i>
(β Nd)	0	<i>cI2</i>	<i>Im$\bar{3}m$</i>
Nd_3As	15	(a)	...
NdAs	34.2	<i>cF8</i>	<i>Fm$\bar{3}m$</i>
NdAs_2	51.0	<i>mP12</i>	<i>P2₁/c</i>
(As)	100	<i>hR2</i>	<i>R$\bar{3}m$</i>

(a) Structure not known

As-Ni (Arsenic - Nickel)

M. Singleton and P. Nash, 1991

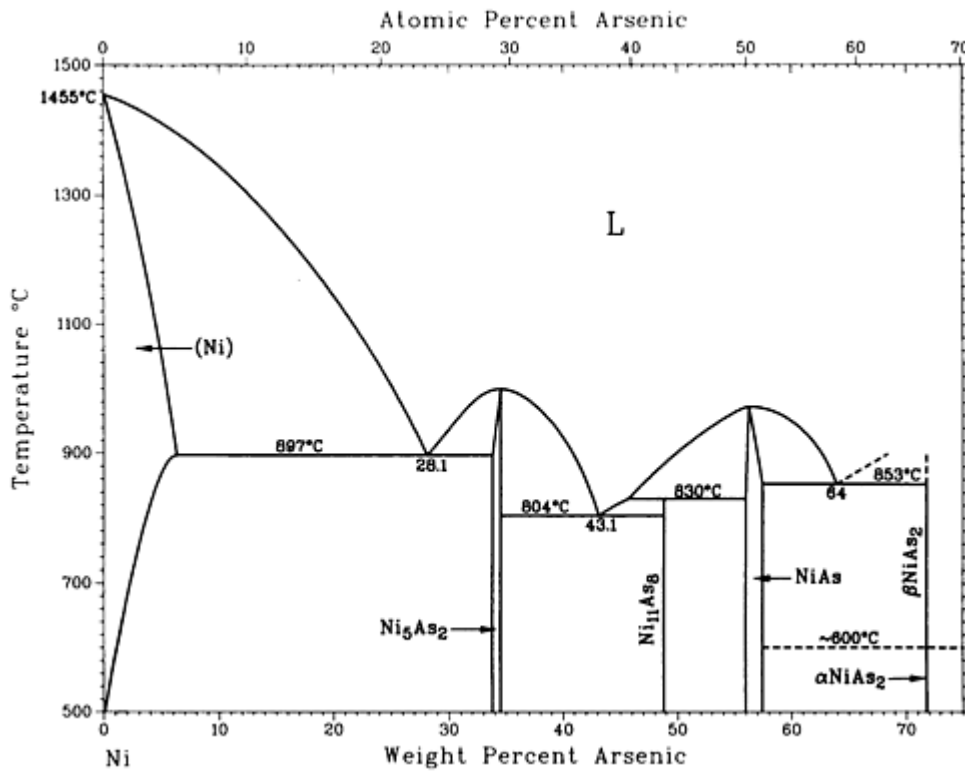

As-Ni phase diagram

As-Ni crystallographic data

Phase	Composition, wt% As	Pearson symbol	Space group
(Ni)	0 to 6.30	<i>cF4</i>	<i>Fm</i> $\bar{3}m$
Ni ₅ As ₂	33.27 to 33.99	<i>hP42</i>	<i>Pb</i> ₃ <i>cm</i>
Ni ₁₁ As ₈	48.1	<i>tP76</i>	<i>P4</i> ₁ <i>2</i> ₁ <i>2</i>
NiAs	56.1 to 57.4	<i>hP4</i>	<i>P6</i> ₃ / <i>mmc</i>
αNiAs ₂	71.86 ^(a)	<i>oP24</i>	<i>Pbca</i>
βNiAs ₂	71.86	<i>oP6</i>	<i>Pnmm</i>

(a) Up to 600 °C

As-P (Arsenic - Phosphorus)

I. Karakaya and W.T. Thompson, 1991

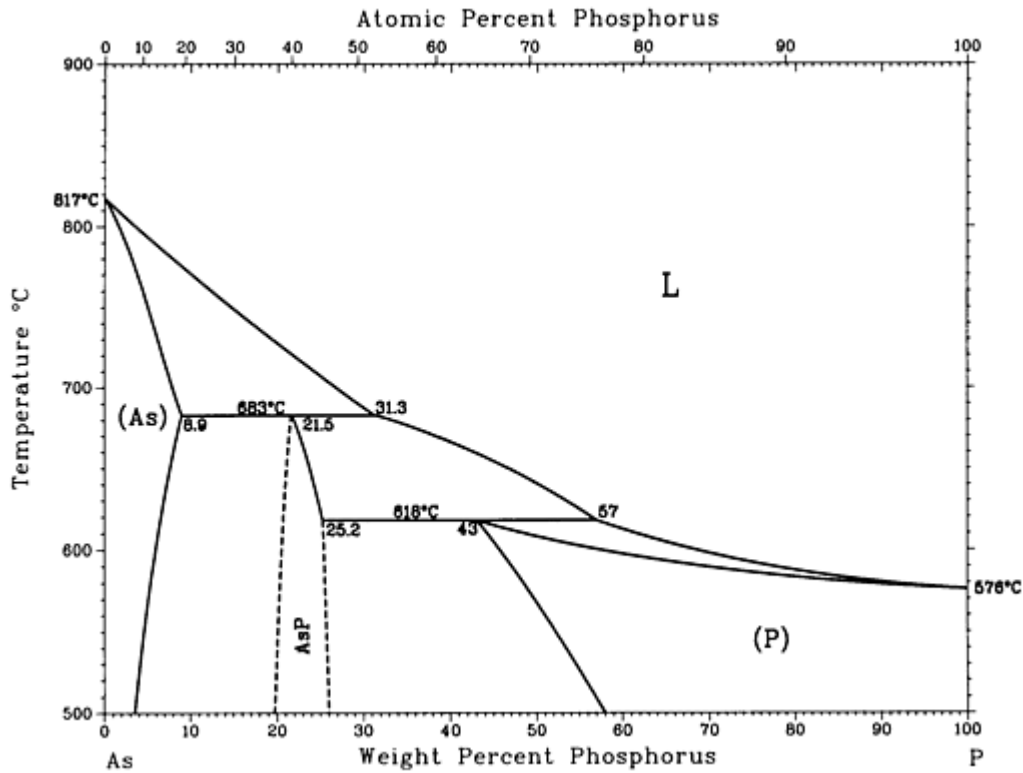

As-P phase diagram

As-P crystallographic data

Phase	Composition, wt% P	Pearson symbol	Space group
(As)	0 to 8.9	<i>hR2</i>	$R\bar{3}m$
AsP	~21.5
P (black)	100	<i>oC8^(a)</i>	<i>Cmca</i>
P (white)	43 to 100	^(b)	...

P (red)	100	(c)	...
---------	-----	-----	-----

- (a) At high pressures, transforms to a rhombohedral structure.
- (b) Cubic at 35 °C.
- (c) Cubic with 66 atoms per unit cell

As-Pb (Arsenic - Lead)

N.A. Gokcen, 1990

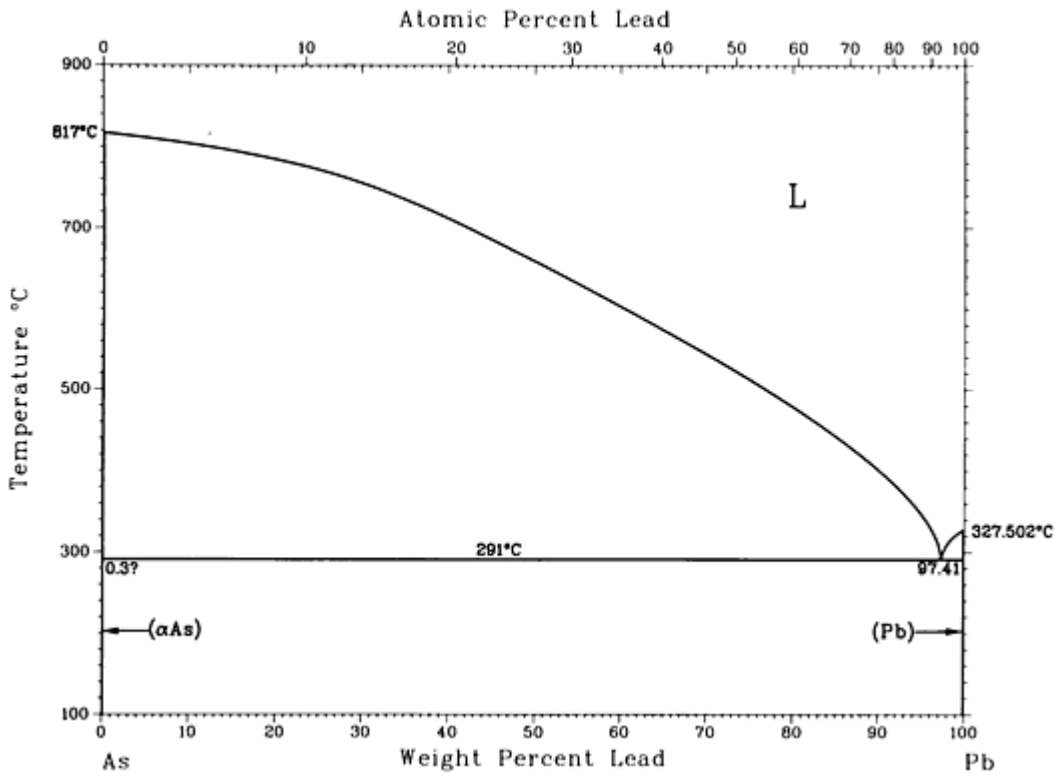

As-Pb phase diagram

As-Pb crystallographic data

Phase	Composition, wt% Pb	Pearson symbol	Space group
(As)	0	$hR2$	$R\bar{3}m$

(Pb)	100	$cF4$	$Fm\bar{3}m$
------	-----	-------	--------------

As-Pd (Arsenic - Palladium)

H. Okamoto, 1992

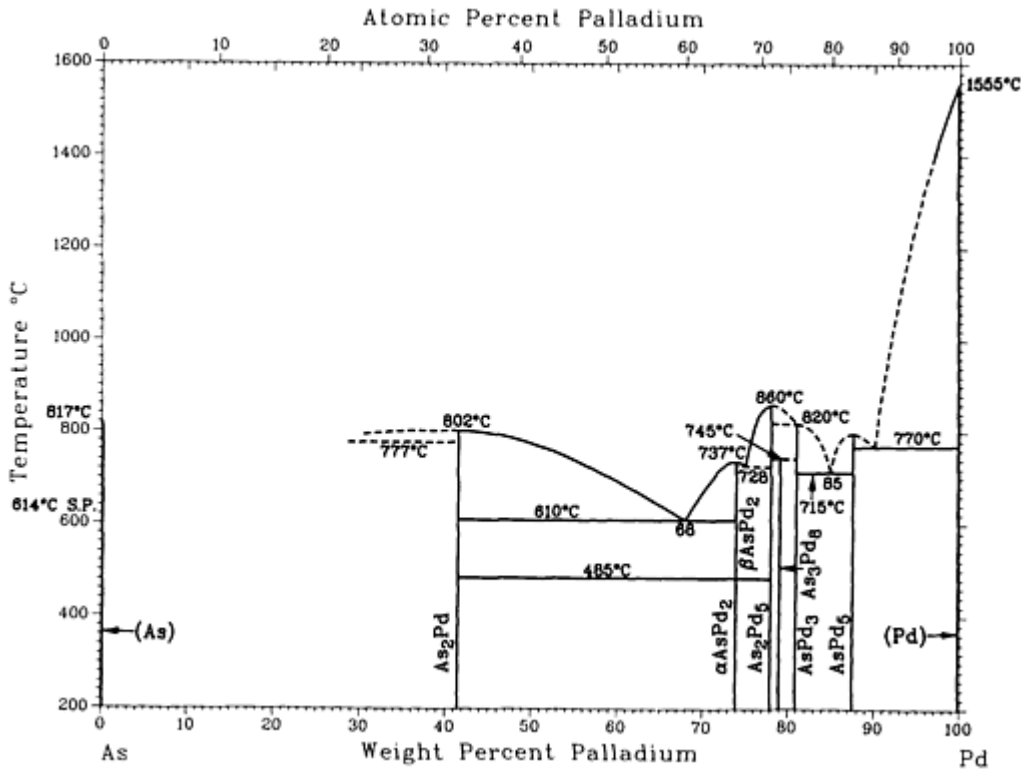

As-Pd phase diagram

As-Pd crystallographic data

Phase	Composition, wt% Pb	Pearson symbol	Space group
(As)	0	$hR2$	$R\bar{3}m$
As_2Pd	41.5	$cP12$	$Pa\bar{3}$
$\beta AsPd_2$	74.0	$hP9$	$P\bar{6}2m$
$\alpha AsPd_2$	74.0	$mP54$	$P2/m$

As ₂ Pd ₅	78.0	<i>hP</i> 84	<i>P</i> $\bar{3}m1$
As ₂ Pd ₅	78.0	<i>hP</i> *	<i>P</i> 6 ₃ 22
As ₂ Pd ₅	78.0	<i>hP</i> *	<i>P</i> $\bar{3}m1$
As ₃ Pd ₈	79.1	<i>hP</i> 33	<i>P</i> 3
AsPd ₃	81	<i>tI</i> 32	$\bar{1}4$
AsPd ₅	87.6	<i>mC</i> 24	<i>C</i> 2
(Pd)	100	<i>cF</i> 4	<i>Fm</i> $\bar{3}m$
Metastable phase			
AsPd ₅	87.6	<i>cI</i> 2	<i>Im</i> $\bar{3}m$
Questionable phases			
α AsPd ₂	74.0	<i>oC</i> 24	<i>Cmc</i> 2 ₁
α AsPd ₂	74.0	<i>hP</i> *	...
As ₂ Pd ₅	78.0	<i>o</i> **	...

As-S (Arsenic - Sulfur)

H. Okamoto, 1990

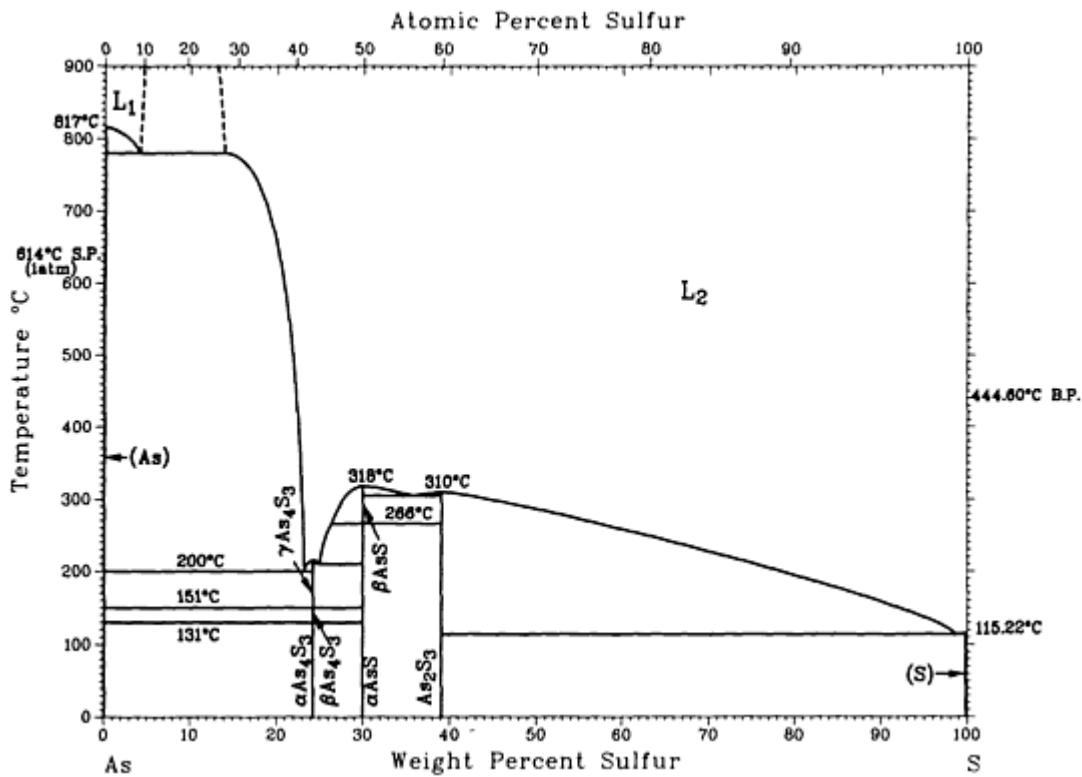

As-S phase diagram

As-S crystallographic data

Phase	Composition, wt% S	Pearson symbol	Space group
(α As)	0	<i>hR2</i>	$R\bar{3}m$
γ As ₄ S ₃	24.3
β As ₄ S ₃	24.3	<i>t**</i>	...
α As ₄ S ₃	24.3	<i>oP28</i>	<i>Pnma</i>
β AsS	30.0	<i>mP32</i>	<i>P2₁/n</i>
α AsS	30.0	<i>mP32</i>	<i>P2₁/c</i>

As ₂ S ₃	39	<i>mP20</i>	<i>P2₁/c</i>
(S)	100	<i>oF128</i>	<i>Fddd</i>

As-Sb (Arsenic - Antimony)

H. Okamoto, 1990

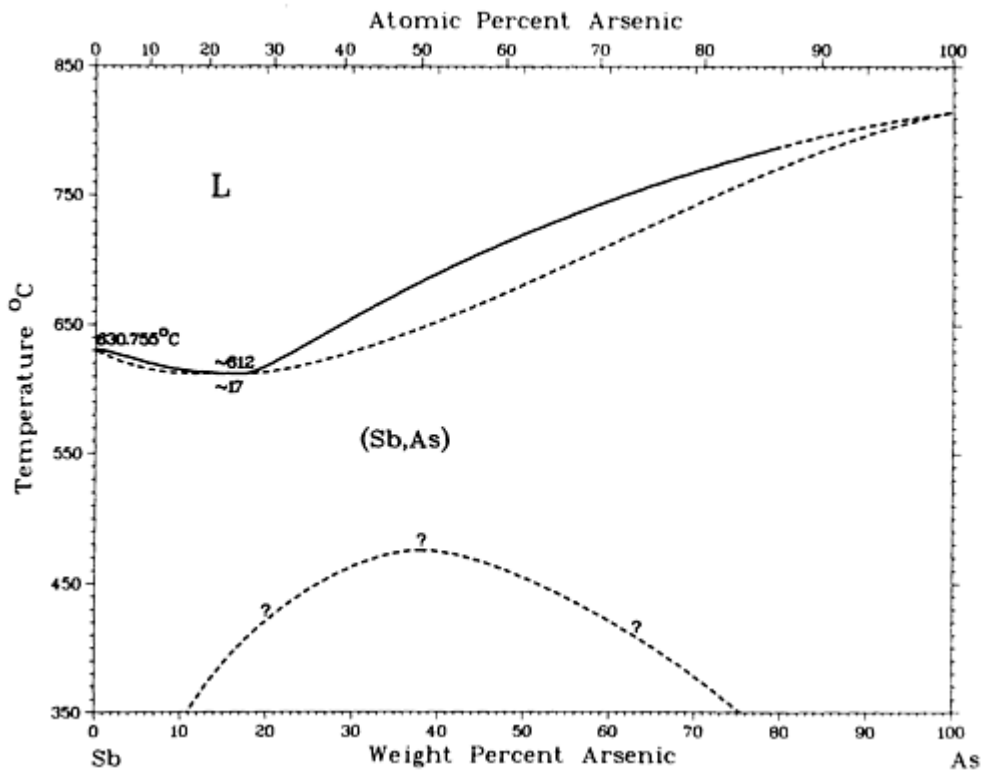

As-Sb phase diagram

As-Sb crystallographic data

Phase	Composition, wt% As	Pearson symbol	Space group
(Sb,As)	0 to 100	<i>hR2</i>	<i>R$\bar{3}m$</i>

As-Se (Arsenic - Selenium)

H. Okamoto, 1990

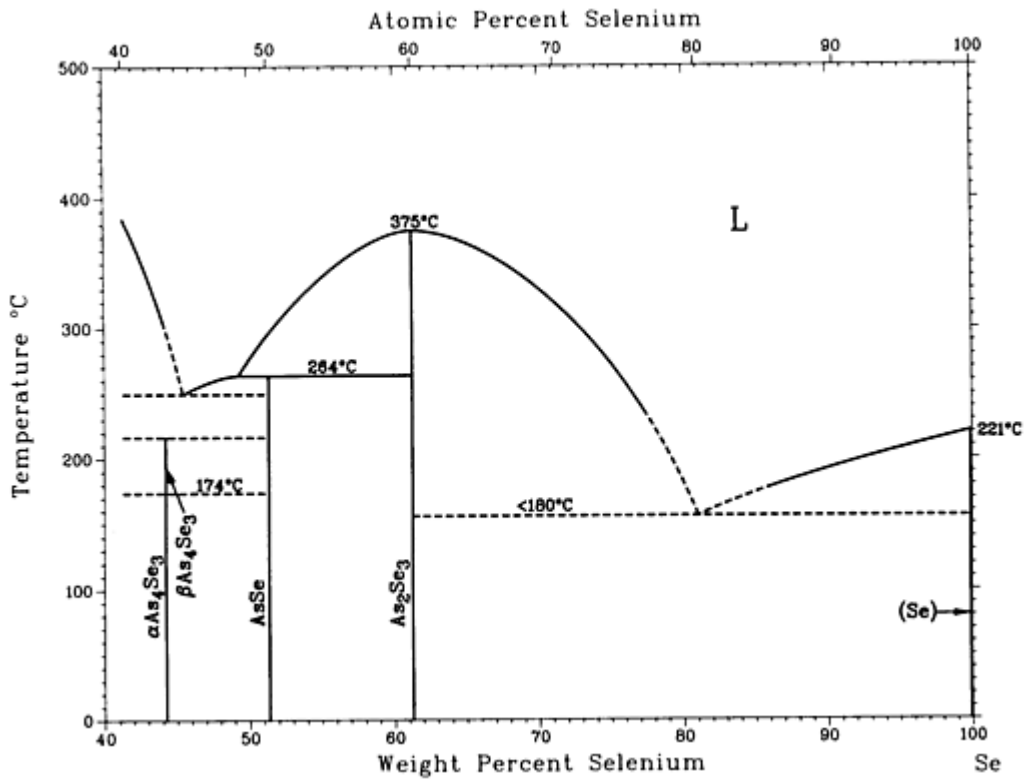

As-Se phase diagram

As-Se crystallographic data

Phase	Composition, wt% Se	Pearson symbol	Space group
(As)	0	<i>hR2</i>	$R\bar{3}m$
$\beta\text{As}_4\text{Se}_3$	44.2	<i>mC112</i>	<i>C2/c</i>
$\alpha\text{As}_4\text{Se}_3$	44.2	<i>oP28</i>	<i>Pnma</i>
AsSe	51.3	<i>mP32</i>	<i>P2₁/c</i>
As_2Se_3	61	<i>mP20</i>	<i>P2₁/c</i>
(γ Se)	100	<i>hP3</i>	<i>P3₁21</i>

As-Si (Arsenic - Silicon)

R. W. Olesinski and G.J. Abbaschian, 1985

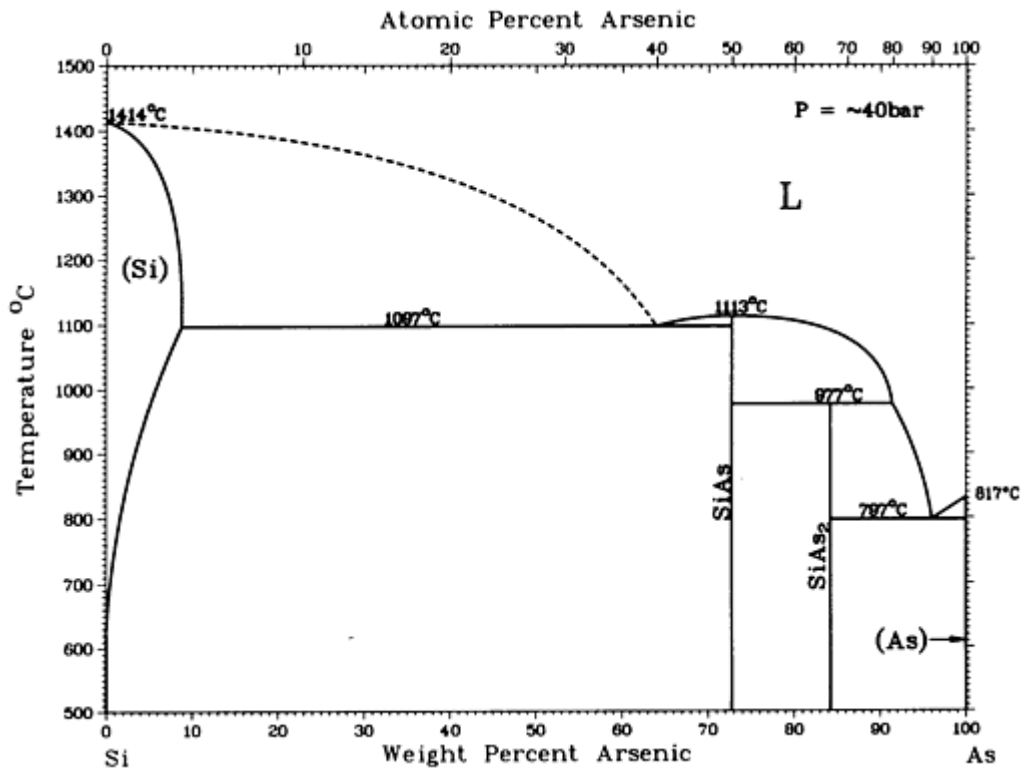

As-Si phase diagram

As-Si crystallographic data

Phase	Composition, wt% As	Pearson symbol	Space group
(Si)	0 to 8.8	<i>cF8</i>	$Fd\bar{3}m$
SiAs	72.7	<i>o**</i>	...
SiAs ₂	84.2	<i>oP*</i>	<i>Pbam</i>
SiAs ₂ ^(a)	84.2	<i>cP12</i>	$Pa\bar{3}$
(As)	~100	<i>hR2</i>	$R\bar{3}m$

(a) High-pressure phase

As-Sn (Arsenic - Tin)

N.A. Gokcen, 1990

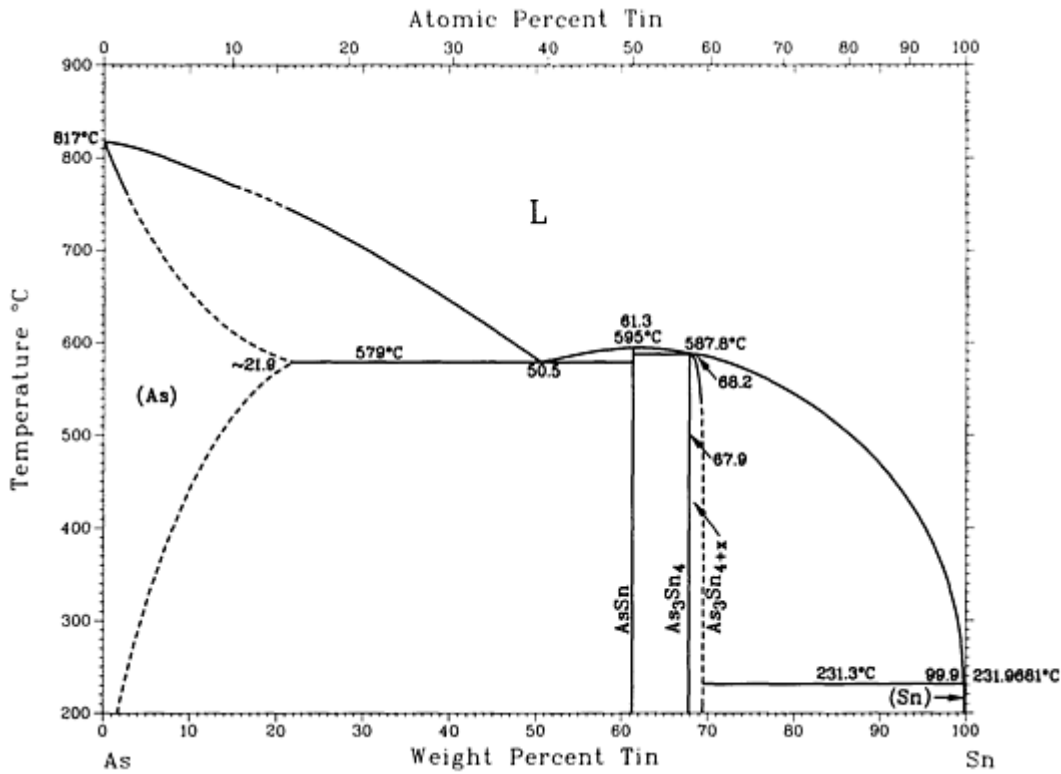

As-Sn phase diagram

As-Sn crystallographic data

Phase	Composition, wt% Sn	Pearson symbol	Space group
(As)	0 to ~21.9	<i>hR2</i>	$R\bar{3}m$
AsSn	61.3	<i>cF8</i>	$Fm\bar{3}m$
As ₃ Sn ₄	67.87 to 70?	<i>hR7</i>	$R\bar{3}m$
(βSn) ^(a)	99.9 to 100	<i>tI4</i>	$I4_1/amd$
(αSn) ^(b)	100	<i>cF8</i>	$Fm\bar{3}m$

(a) White tin, stable above 13 °C.

(b) Grey tin, stable below 13 °C

As-Te (Arsenic - Tellurium)

H. Okamoto, 1990

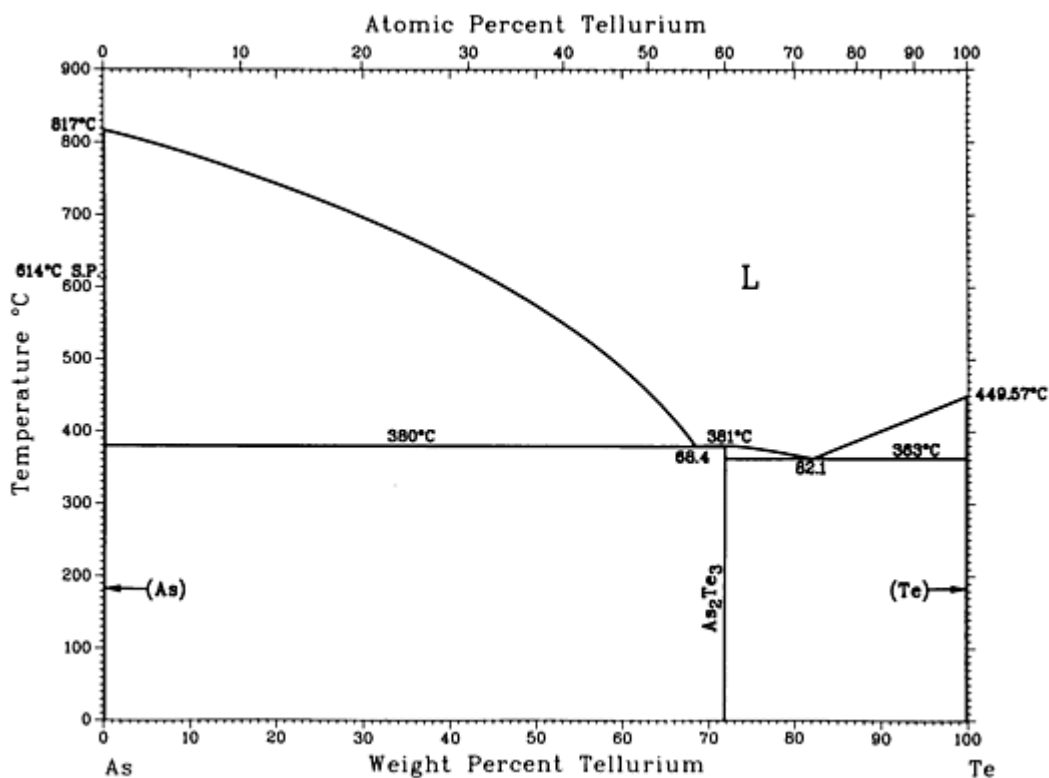

As-Te phase diagram

As-Te crystallographic data

Phase	Composition, wt% Te	Pearson symbol	Space group
(As)	0	<i>hR2</i>	$R\bar{3}m$
As ₂ Te ₃	72	<i>mC20</i>	<i>Cm</i> /2
(Te)	100	<i>hP3</i>	<i>P3</i> ₁ 21

As-Tl (Arsenic - Thallium)

R.C. Sharma and Y.A. Chang, unpublished

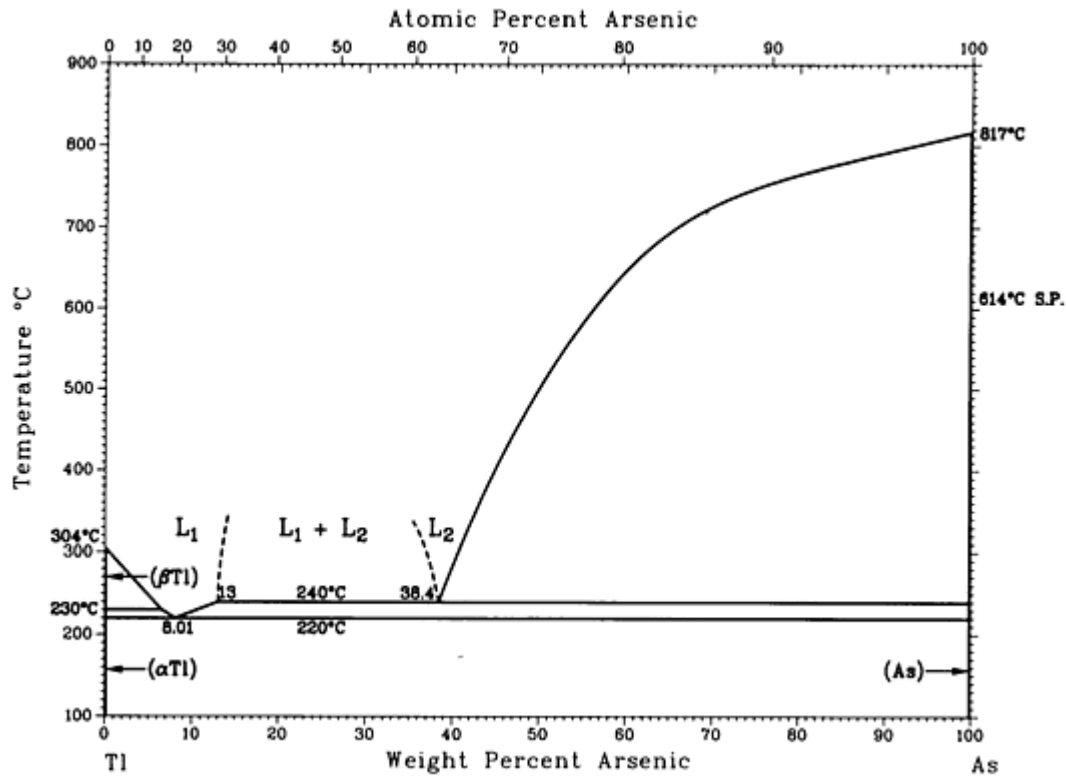

As-Tl phase diagram

As-Tl crystallographic data

Phase	Composition, wt% As	Pearson symbol	Space group
(αTl)	0	<i>hP2</i>	<i>P6₃/mmc</i>
(βTl)	0	<i>cI2</i>	<i>Im$\bar{3}m$</i>
(As)	100	<i>hR2</i>	<i>R$\bar{3}m$</i>

As-Yb (Arsenic - Ytterbium)

H. Okamoto, 1990

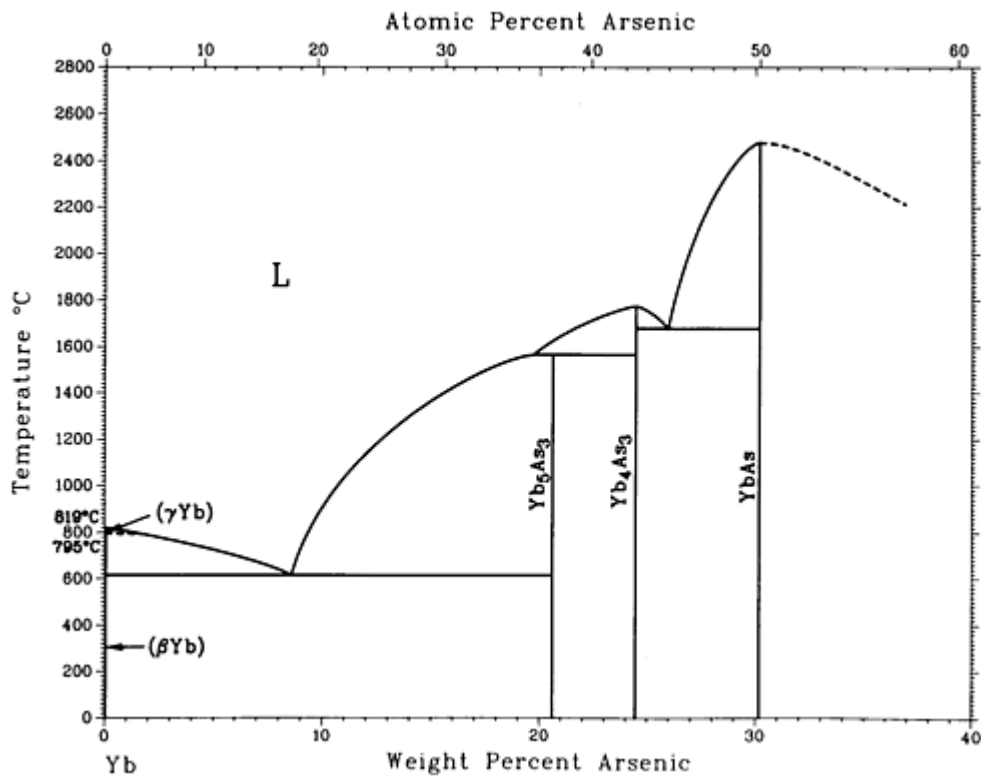

As-Yb phase diagram

As-Yb crystallographic data

Phase	Composition, wt% As	Pearson symbol	Space group
(αYb)	0	<i>hP2</i>	<i>P6₃/mmc</i>
(βYb)	0	<i>cF4</i>	<i>Fm$\bar{3}$m</i>
(γYb)	0	<i>cI2</i>	<i>Im$\bar{3}$m</i>
Yb ₅ As ₃	20.6	<i>hP16</i>	<i>P6₃/mcm</i>
αYb ₄ As ₃	24.5	<i>hR28</i>	<i>R3</i>
βYb ₄ As ₃	24.5	<i>cI28</i>	<i>I$\bar{4}$3d</i>

YbAs	30.2	<i>cF8</i>	<i>Fm</i> $\bar{3}m$
(As)	100	<i>hR2</i>	<i>R</i> $\bar{3}m$

As-Zn (Arsenic - Zinc)

H. Okamoto, 1992

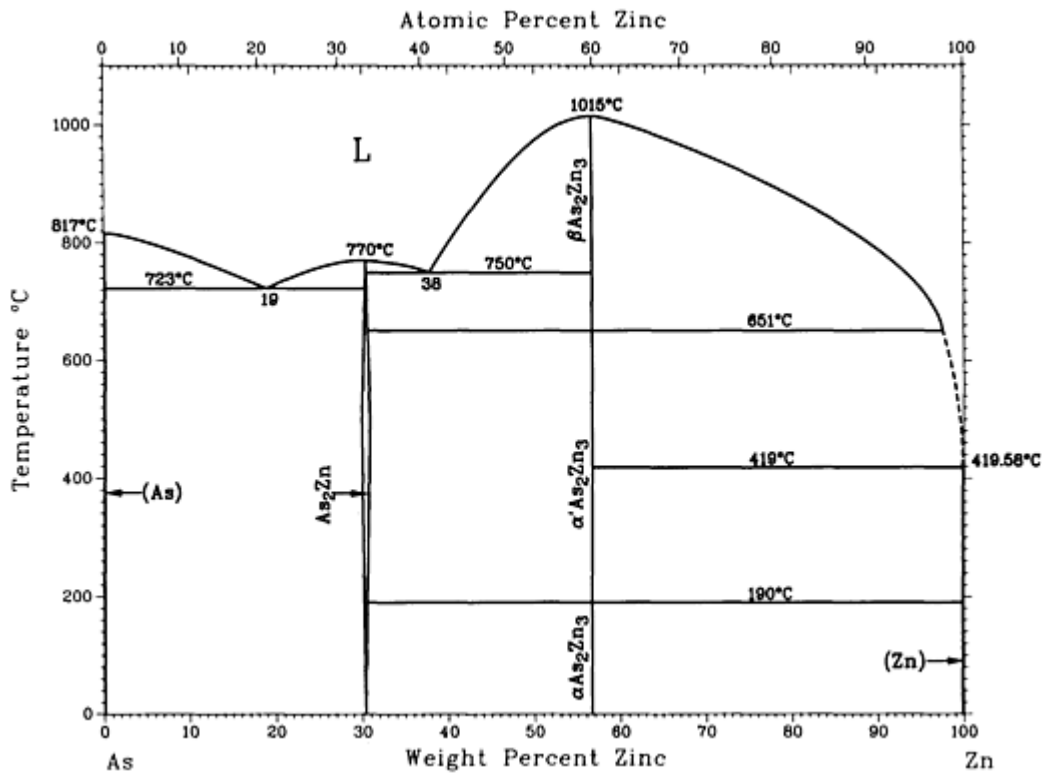

As-Zn phase diagram

As-Zn crystallographic data

Phase	Composition, wt% Zn	Pearson symbol	Space group
(α As)	0	<i>hR2</i>	<i>R</i> $\bar{3}m$
As ₂ Zn	30.3	<i>mP24</i>	<i>P2</i> ₁ / <i>c</i>
β As ₂ Zn ₃	56.7	<i>cF12</i>	<i>Fm</i> $\bar{3}m$

α' As ₂ Zn ₃	56.7	<i>tP160</i>	<i>P4₂/nbc</i>
α As ₂ Zn ₃	56.7	<i>tI160</i>	<i>I4₁cd</i>
(Zn)	100	<i>hP2</i>	<i>P6₃/mmc</i>
High-pressure phases			
AsZn	46.6	<i>oP16</i>	<i>Pbca</i>
As ₂ Zn ₃ II ^(a)	56.7	<i>cF*</i>	...
As ₂ Zn ₃ II'	56.7	<i>oP*</i>	<i>Pmmn</i>
As ₂ Zn ₃ III	56.7
As ₂ Zn ₃ ^(b)	56.7	<i>hP30</i>	...
Other phases			
As ₂ Zn	30.39	<i>o*32</i>	...
As ₂ Zn ₃	56.7 56.7	<i>cI80</i> <i>tP40</i>	<i>Ia3</i> <i>P4₂/mmc</i>

(a) At 55 kbar.

(b) At 70 kbar

Au (Gold) Binary Alloy Phase Diagrams

Introduction

THIS ARTICLE includes systems where gold is the first-named element in the binary pair. Additional binary systems that include gold are provided in the following locations in this Volume:

- [“Ag-Au \(Silver - Gold\)”](#) in the article [“Ag \(Silver\) Binary Alloy Phase Diagrams.”](#)
- [“Al-Au \(Aluminum - Gold\)”](#) in the article [“Al \(Aluminum\) Binary Alloy Phase Diagrams.”](#)
- [“As-Au \(Arsenic - Gold\)”](#) in the article [“As \(Arsenic\) Binary Alloy Phase Diagrams.”](#)

Au-Be (Gold - Beryllium)

H. Okamoto and T.B. Massalski, 1987

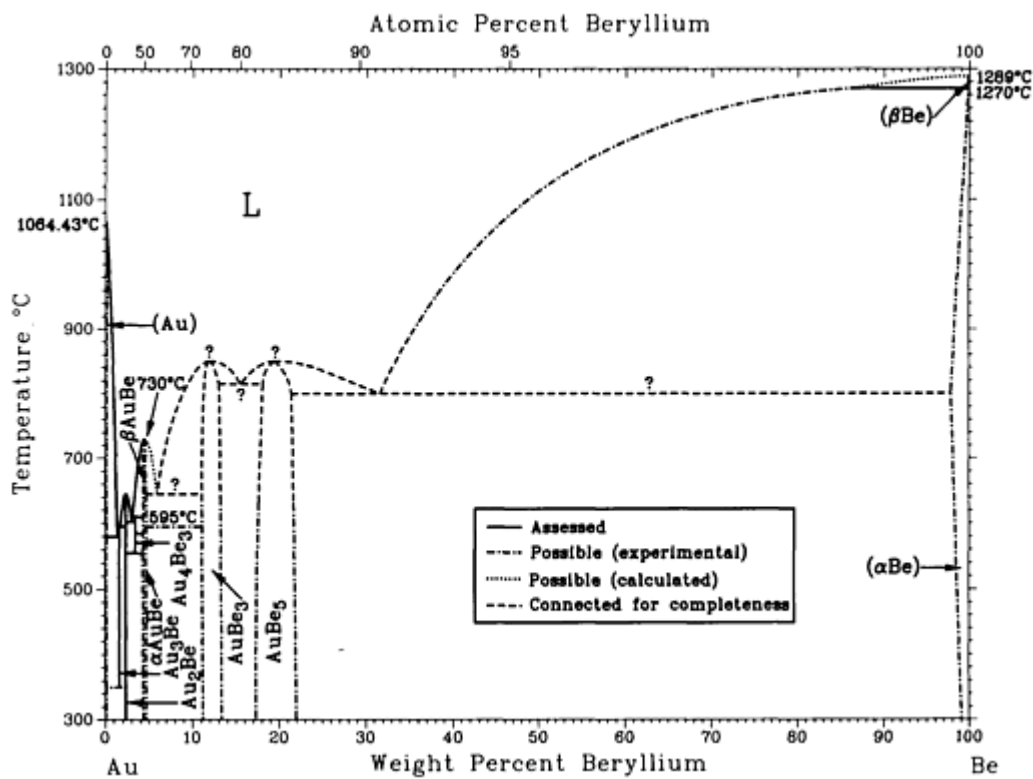

Au-Be phase diagram

Au-Be crystallographic data

Phase	Composition, wt% Be	Pearson symbol	Space group
(Au)	0 to 0.009	<i>cF4</i>	<i>Fm</i> $\bar{3}m$
Au ₃ Be	2	<i>o**</i>	...
Au ₂ Be	2.2	<i>tI6</i>	<i>I4/mmm</i>
Au ₄ Be ₃	3.3
β AuBe	4.2 to 4.6
α AuBe	4.2 to 4.6	<i>cP8</i>	<i>P2</i> $\bar{1}3$
AuBe ₃	11 to 13	<i>cF16</i>	<i>Fd</i> $\bar{3}m$
AuBe ₅	17 to 22	<i>cF24</i>	<i>F</i> $\bar{4}3m$

(βBe)	? to 100	$cI2$	$Im\bar{3}m$
(αBe)	94.81 to 100	$hP2$	$P6_3/mmc$

Au-Bi (Gold - Bismuth)

H. Okamoto, 1990

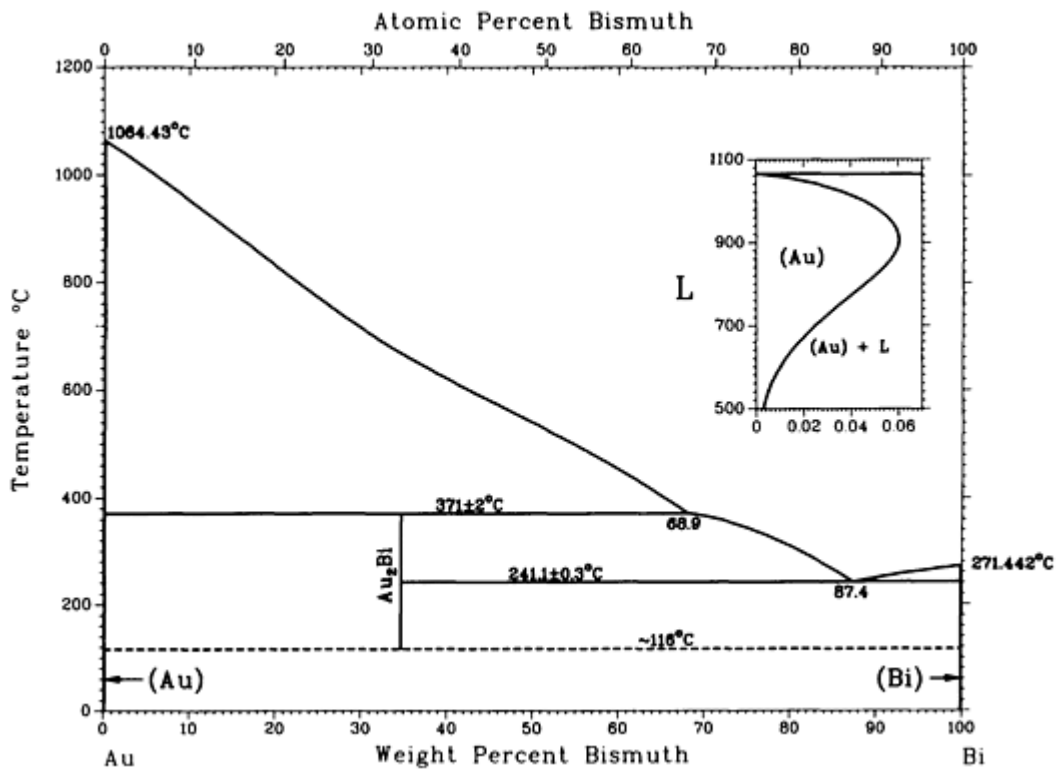

Au-Bi phase diagram

Au-Bi crystallographic data

Phase	Composition, wt% Bi	Pearson symbol	Space group
(Au)	0	$cF4$	$Fm\bar{3}m$
Au ₂ Bi	34.6	$cF24$	$Fd\bar{3}m$
(Bi)	100	$hR2$	$R\bar{3}m$

Metastable phases			
π	76 to 81	$cP1$	$Pm\bar{3}m$
π'	61	$hR1$	$R\bar{3}m$
Microcrystalline	46 to 71	~ 200 π' -like unit cells	...
(AuBi)?	56	Complex	...

Au-Ca (Gold - Calcium)

H. Okamoto, T.B. Massalski, C.B. Alcock, and V.P. Itkin, 1987

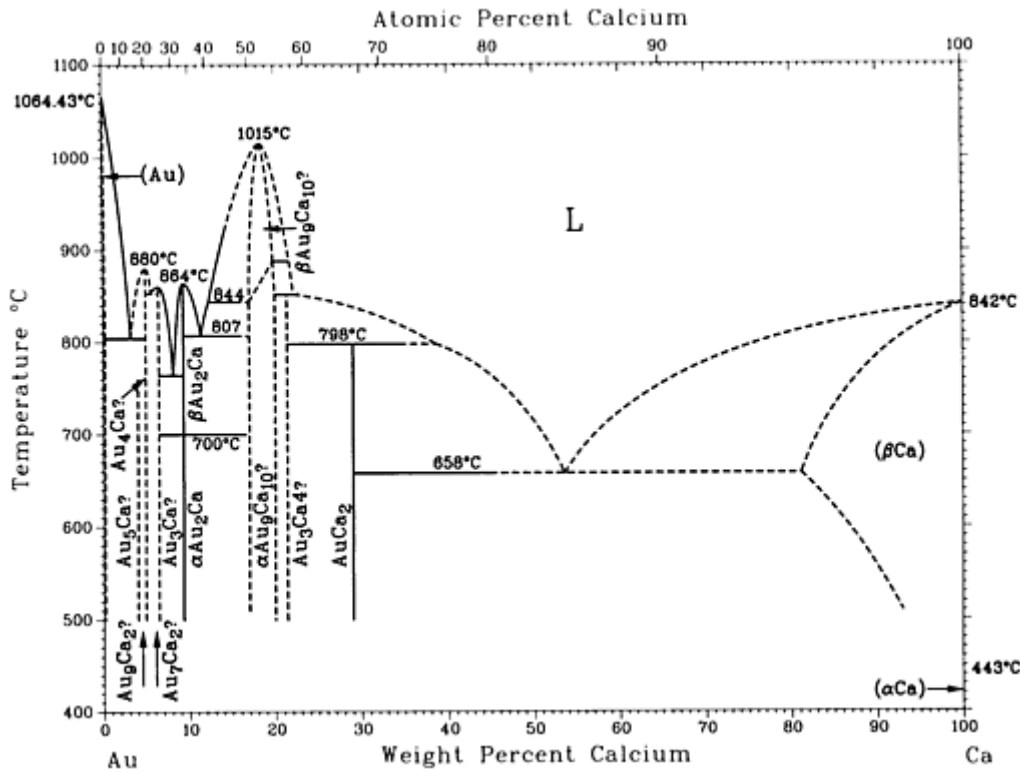

Au-Ca phase diagram

Au-Ca crystallographic data

Phase	Composition, wt% Ca	Pearson symbol	Space group
(Au)	0 to <4.3	$cF4$	$Fm\bar{3}m$

Au ₅ Ca	3.9	<i>cF24</i>	<i>F$\bar{4}3m$</i>
Au ₉ Ca ₂	4.3	?	...
Au ₄ Ca	5	?	...
Au ₇ Ca ₂	5.5	(a)	...
Au ₃ Ca	6	(b)	...
β Au ₂ Ca	9.2	?	...
α Au ₂ Ca	9.2	?	...
AuCa	17	<i>oC8</i>	<i>Cmcm</i>
β Au ₉ Ca ₁₀	17 to 20	(c)	...
α Au ₉ Ca ₁₀	16 to 20.2	?	...
Au ₃ Ca ₄	21.3	?	...
AuCa ₂	29.0	?	...
(β Ca)	81.2 to 100	<i>cI2</i>	<i>Im$\bar{3}m$</i>
(α Ca)	? to 100	<i>cF4</i>	<i>Fm$\bar{3}m$</i>

(a) Same as Au₃Ca?

(b) Not cubic.

(c) Same as AuCa?

Au-Cd (Gold - Cadmium)

H. Okamoto and T.B. Massalski, 1987

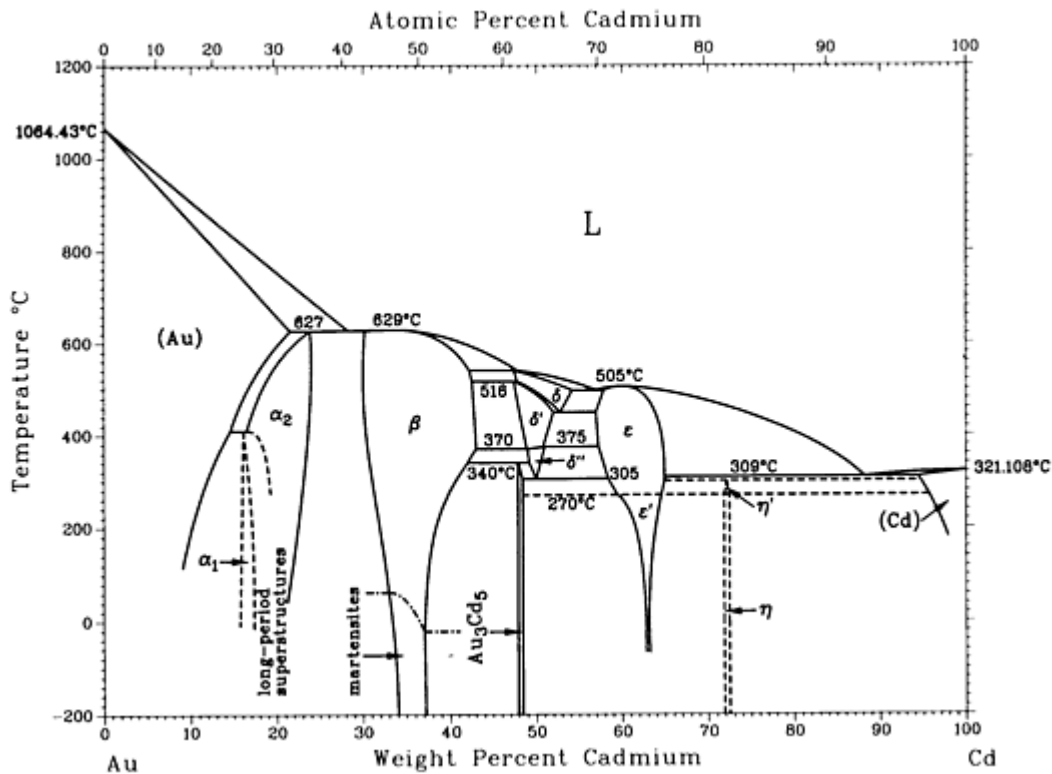

Au-Cd phase diagram

Au-Cd crystallographic data

Phase	Composition, wt% Cd	Pearson symbol	Space group
(Au)	0 to 21.6	<i>cF4</i>	<i>Fm</i> $\bar{3}m$
α_1	~16	...	<i>Pm</i> $\bar{3}m$
Long-period superstructures			
Au ₃ Cd	15	<i>tI16</i>	<i>I4/mmm</i>
4H (1d)	16	<i>hP4</i>	<i>P6₃/mmc</i>
9a ₀ -4H (2d)	15 to 17	^(a)	...

$6H$	16 to 17	$hR3$	$R\ m$
$9R$	16.7 to 19.7	^(b)	...
$7a_0 - 2H$	19 to 23	^(a)	$P6_3/mmc$
$9a_0 - 2H$	19 to 23	^(a)	$P6_3/mcm$
2	16.3 to 24.0	hP^*	...
β	30 to 43	$cP2$	$Pm\ m$
$\beta_{(c)}$	34.1	$oP4$	$Pmma$
$\beta''_{(c)}$	36	^(a)	...
δ	47.3 to 54.3	$cI52$	$I\bar{4}3m$
δ'	47.3 to 52.0	$cI52$	$I\bar{4}3m$
δ''	48.9 to 50.9
Au_3Cd_5	47.8 to 48.3	$tI32$	$I4/mcm$
ϵ	57.0 to 65.0	^(d)	...
ϵ'	59 to 64	^(d)	...
η	72
η'	72
(Cd)	94.0 to 100	$hP2$	$P6_3/mmc$

Note. d = dimensional.

(a) Hexagonal.

(b) Rhombohedral.

(c) Not shown in the assessed diagram.

(d) bct

Au-Co (Gold - Cobalt)

H. Okamoto, T.B. Massalski, M. Hasebe, and T. Nishizawa, 1987

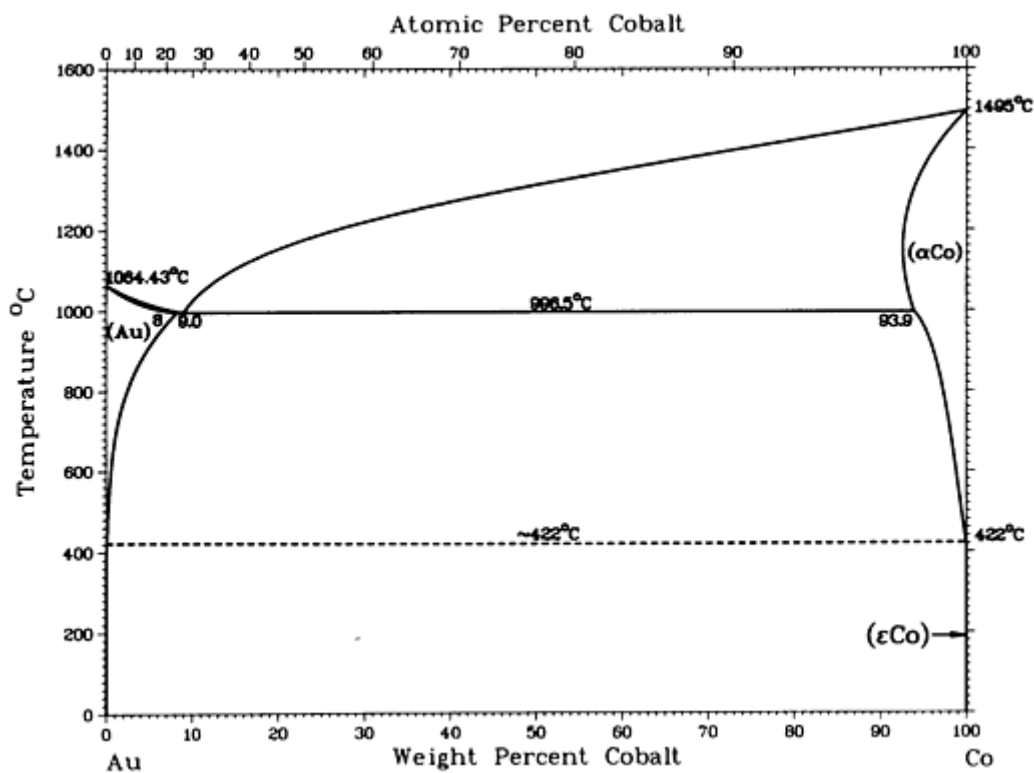

Au-Co phase diagram

Au-Co crystallographic data

Phase	Composition, wt% Co	Pearson symbol	Space group
(Au)	0 to 8	<i>cF4</i>	<i>Fm</i> $\bar{3}m$
(α Co)	92.1 to 100	<i>cF4</i>	<i>Fm</i> $\bar{3}m$
(ϵ Co)	? to 100	<i>hP2</i>	<i>P6</i> ₃ / <i>mmc</i>

Au-Cr (Gold - Chromium)

H. Okamoto and T.B. Massalski, 1987

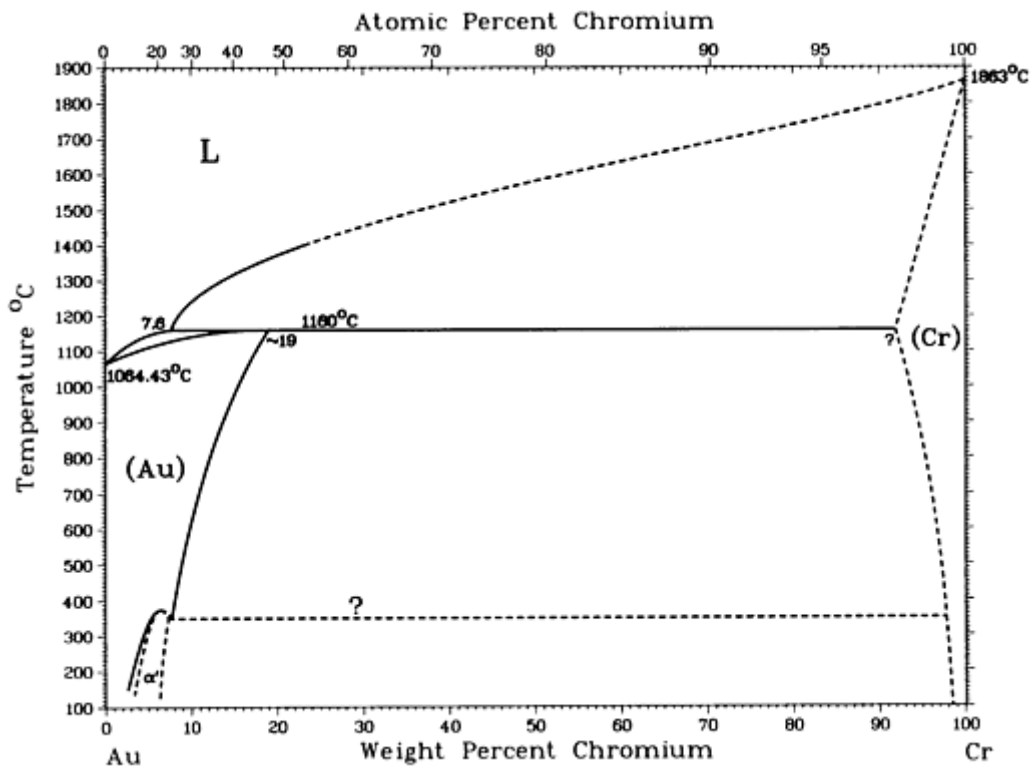

Au-Cr phase diagram

Au-Cr crystallographic data

Phase	Composition, wt% Cr	Pearson symbol	Space group
(Au)	0 to ~19	<i>cF4</i>	<i>Fm</i> $\bar{3}m$
α'	2 to 8	<i>tI10</i>	<i>I4/m</i>
(Cr)	~90 to 100	<i>cI2</i>	<i>Im</i> $\bar{3}m$

Au-Cu (Gold - Copper)

H. Okamoto, D.J. Chakrabarti, D.E. Laughlin, and T.B. Massalski, 1987

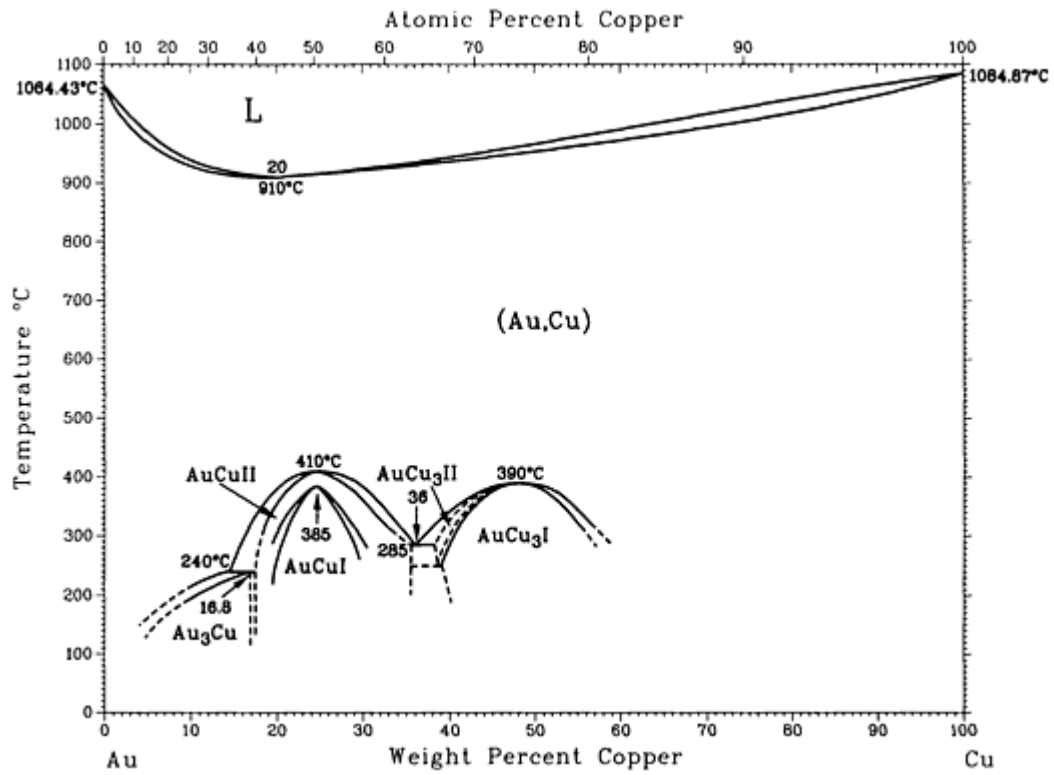

Au-Cu phase diagram

Au-Cu crystallographic data

Phase	Composition, wt% Cu	Pearson symbol	Space group
(Au,Cu)	0 to 100	<i>cF4</i>	<i>Fm</i> $\bar{3}m$
Au ₃ Cu	3 to 16.8	<i>cP4</i>	<i>Pm</i> $\bar{3}m$
AuCu(I)	19 to 30	<i>tP4</i>	<i>P4/mmm</i>
AuCu(II)	16.8 to 35	<i>oI40</i>	<i>Imma</i>
AuCu ₃ (I)	40 to 58	<i>cP4</i>	<i>Pm</i> $\bar{3}m$
AuCu ₃ (II)	39 to ?	<i>tP28</i>	<i>P mm</i>

Au-Dy (Gold - Dysprosium)

K.A. Gschneidner, Jr., F.W. Calderwood, H. Okamoto, and T.B. Massalski, 1987

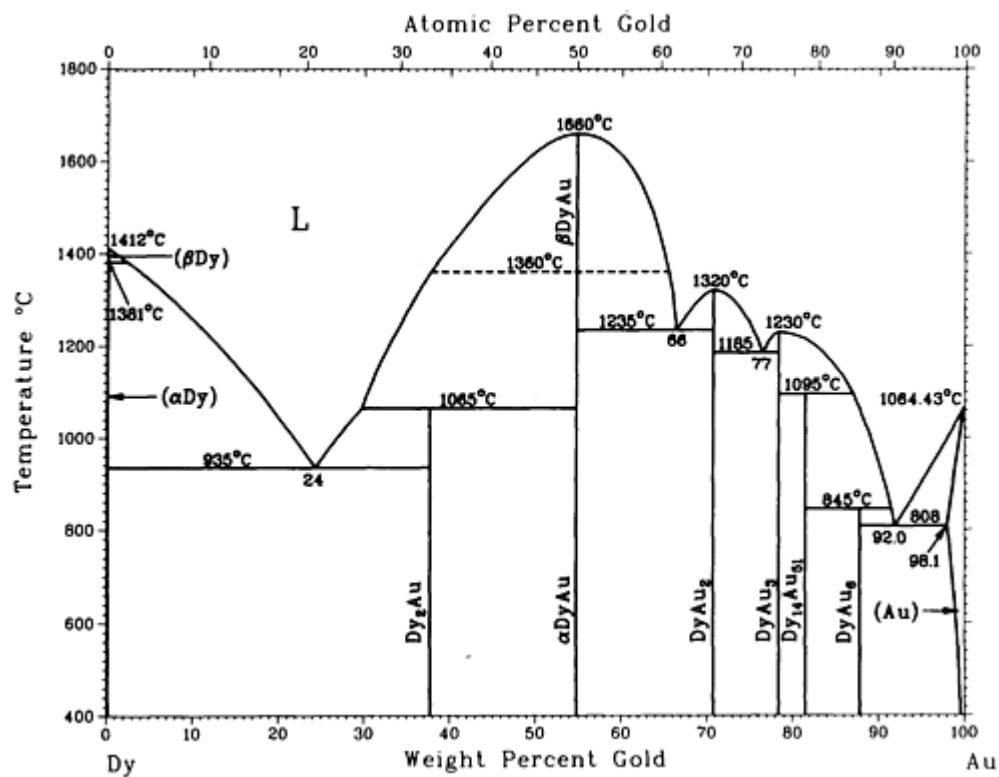

Au-Dy phase diagram

Au-Dy crystallographic data

Phase	Composition, wt% Au	Pearson symbol	Space group
(αDy)	0	<i>hP2</i>	<i>P6₃/mmc</i>
(α'Dy)	0	(a)	...
(βDy)	0	<i>cI2</i>	<i>Im$\bar{3}m$</i>
Dy ₂ Au	37.7	<i>oP12</i>	<i>Pnma</i>
αDyAu	55	<i>oC8</i>	<i>Cmcm</i>
βDyAu	56	<i>cP2</i>	<i>Pm$\bar{3}m$</i>
DyAu ₂	70.8	<i>tI6</i>	<i>I4/mmm</i>

DyAu ₃	78	<i>oP8</i>	<i>Pmmm</i>
Dy ₁₄ Au ₅₁	~81.6	<i>hP65</i>	<i>P6/m</i>
DyAu ₆	87.9	<i>tP56</i>	<i>P4₂/ncm</i>
(Au)	98.1 to 100	<i>cF4</i>	<i>Fm$\bar{3}m$</i>

(a) Orthorhombic distortion, $T \lesssim 86$ K

Au-Eu (Gold - Europium)

H. Okamoto, 1990

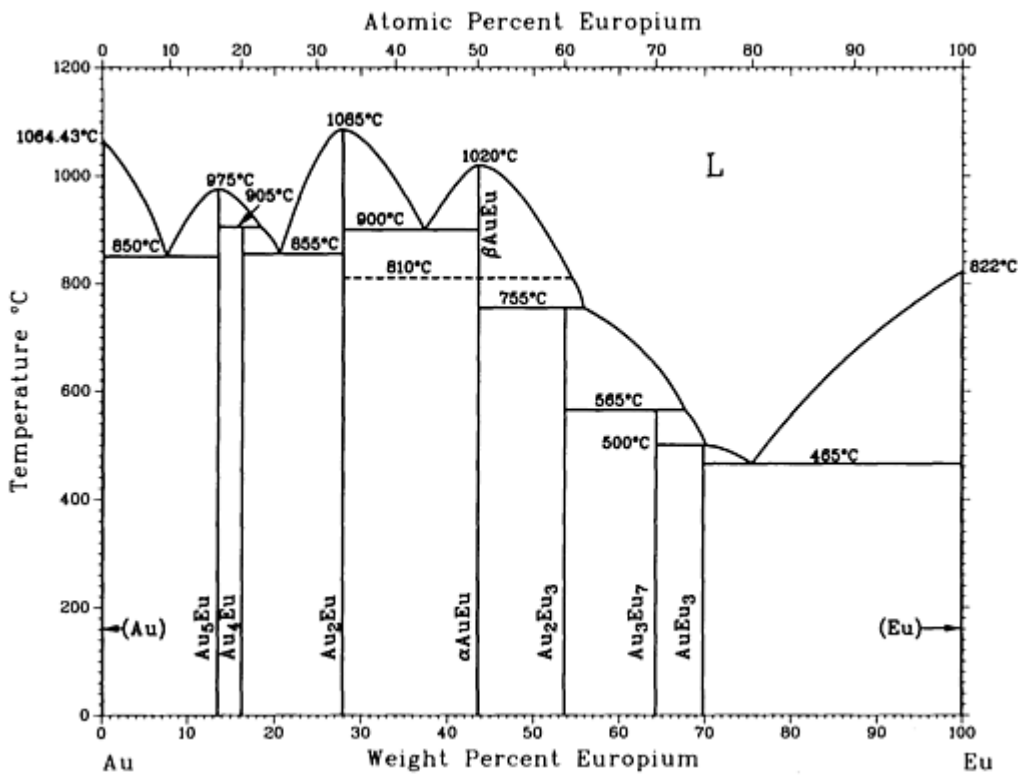

Au-Eu phase diagram

Au-Eu crystallographic data

Phase	Composition, wt% Eu	Pearson symbol	Space group
(Au)	0	<i>cF4</i>	<i>Fm$\bar{3}m$</i>

Au ₅ Eu	13.4	<i>hP6</i>	<i>P6/mmm</i>
Au ₄ Eu	16
Au ₂ Eu	27.8	<i>oI12</i>	<i>Imma</i>
β _{AuEu}	43.6
α _{AuEu}	43.6	<i>oP8</i>	<i>Pnma</i>
Au ₂ Eu ₃	54	<i>hR45</i>	$R\bar{3}$
Au ₃ Eu ₇	64	<i>hP20</i>	<i>P6₃/mc</i>
AuEu ₃	70	<i>oP16</i>	<i>Pnma</i>
(Eu)	100	<i>cI2</i>	<i>Im$\bar{3}m$</i>

Au-Fe (Gold - Iron)

H. Okamoto, T.B. Massalski, L.J. Swartzendruber, and P.A. Beck, 1987

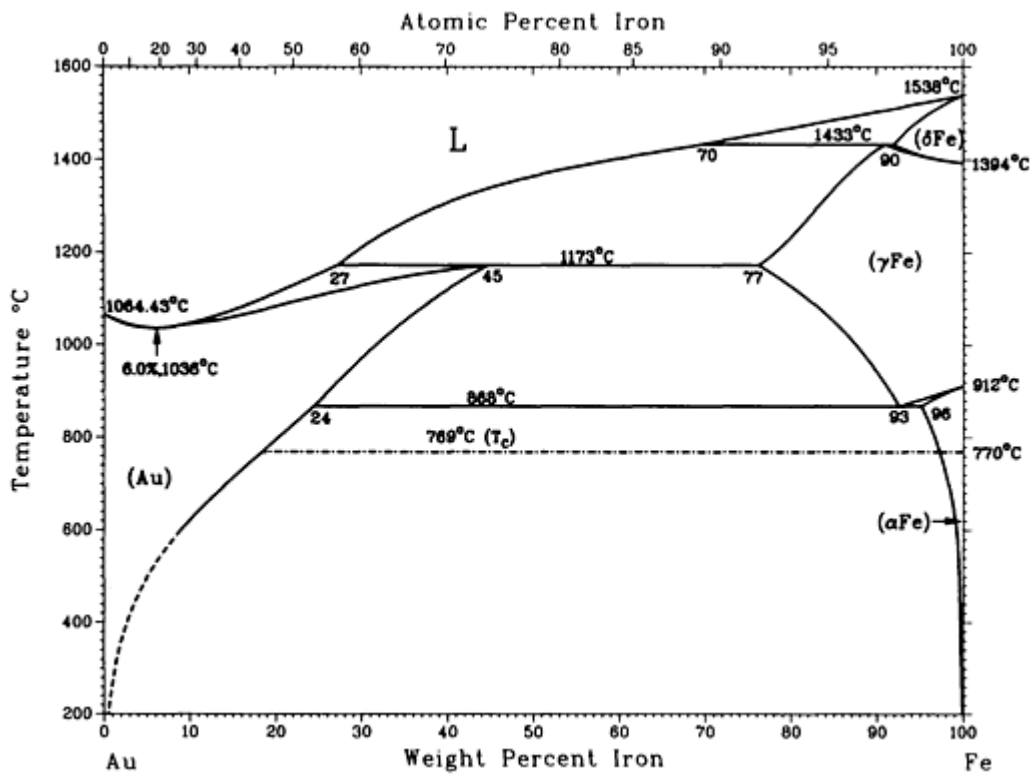

Au-Fe phase diagram

Au-Fe crystallographic data

Phase	Composition, wt% Fe	Pearson symbol	Space group
(Au)	0 to 45	<i>cF4</i>	<i>Fm</i> $\bar{3}m$
(γ Fe)	77 to 100	<i>cF4</i>	<i>Fm</i> $\bar{3}m$
(α Fe)	96 to 100	<i>cI2</i>	<i>Im</i> $\bar{3}m$
(δ Fe)	93 to 100	<i>cI2</i>	<i>Im</i> $\bar{3}m$
Metastable phases			
Amorphous ^(a)	19 to 72
fcc ^(b)	30 to 32
bcc ^(b)	32 to 53

(a) Found in thin films deposited at liquid nitrogen temperature or below.

(b) Formed by crystallization on heating amorphous phase

Au-Ga (Gold - Gallium)

T.B. Massalski and H. Okamoto, 1987

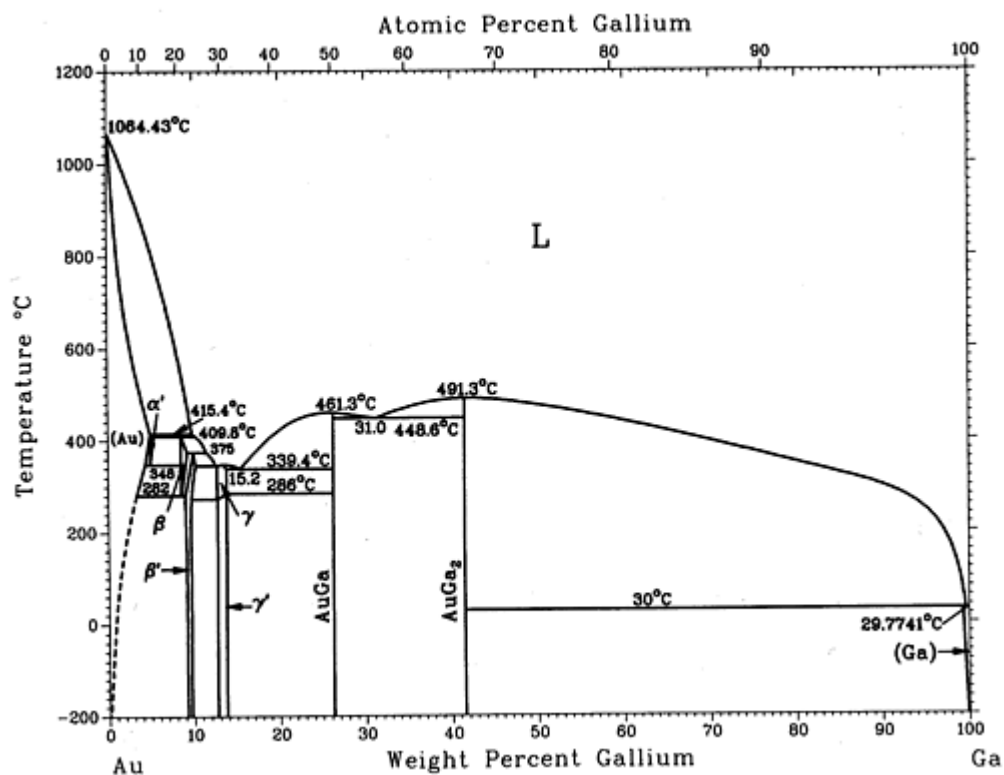

Au-Ga phase diagram

Au-Ga crystallographic data

Phase	Composition, wt% Ga	Pearson symbol	Space group
(Au)	0 to 4.8	<i>cF4</i>	<i>Fm$\bar{3}m$</i>
α'	4.9 to 5.5	<i>hP16</i>	<i>P6₃/mmc</i>
β	8.3 to 9.1	(a)	...
β'	8.7 to 10.5	(b)	...
γ	13.1 to 14	(b)	...
γ'	13.1 to 14	(b)	...
AuGa	26.1	<i>oP8</i>	<i>Pnma</i>

AuGa ₂	41.5	<i>cF12</i>	<i>Fm</i> $\bar{3}m$
(Ga)	100	<i>oC8</i>	<i>Cmca</i>

(a) Hexagonal.

(b) Orthorhombic

Au-Ge (Gold - Germanium)

H. Okamoto and T.B. Massalski, 1987

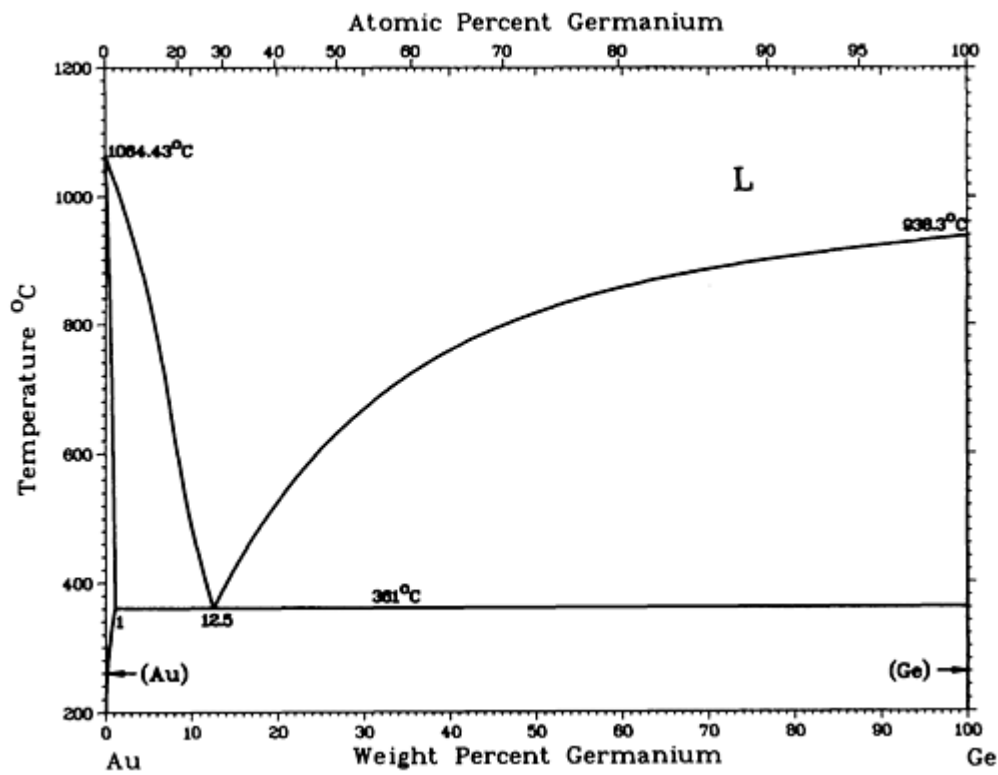

Au-Ge phase diagram

Au-Ge crystallographic data

Phase	Composition, wt% Ge	Pearson symbol	Space group
(Au)	0 to 1 ^(a)	<i>cF4</i>	<i>Fm</i> $\bar{3}m$
(Ge)	100 ^(a)	<i>cF8</i>	<i>Fd</i> $\bar{3}m$

Metastable phases			
β	7 to 11 ^(a)	<i>hP2</i>	<i>P6₃/mmc</i>
γ	11 to 29 ^(a)	<i>tI*</i>	...

(a) Approximate composition from the phase diagram

Au-Hg (Gold - Mercury)

H. Okamoto and T.B. Massalski, 1989

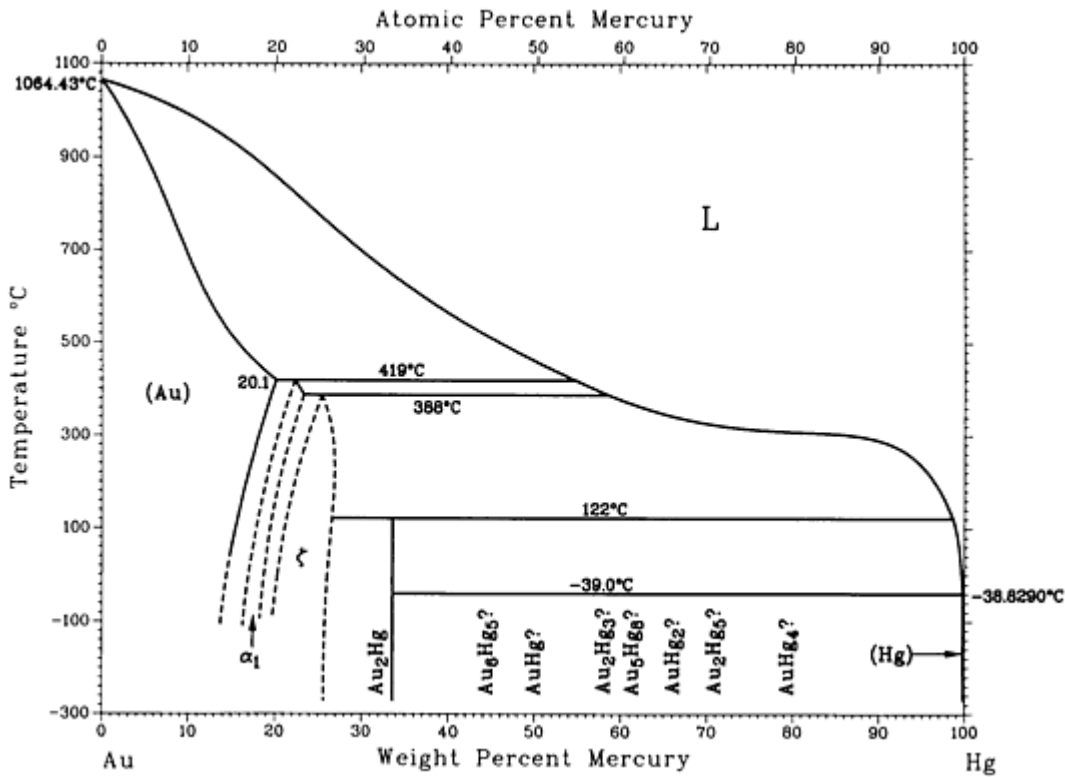

Au-Hg phase diagram

Au-Hg crystallographic data

Phase	Composition, wt% Hg	Pearson symbol	Space group
(Au)	0 to 20.1	<i>cF4</i>	<i>Fm$\bar{3}m$</i>
α_1	16.2 to 23	<i>hP36</i>	<i>P6₃/mmc</i>

ζ	21 to 26	$hP2$	$P6_3/mmc$
Au_2Hg	33.7	$hP\sim 150$ $hP22$	$P6_3/mcm$
Au_6Hg_5	46.0	$hP22$	$P6_3/mcm$
Au_5Hg_8	62.0	$cI52$	$I\bar{4}3m$
(Hg)	100	$hR1$	$R\bar{3}m$

Au-In (Gold - Indium)

H. Okamoto and T.B. Massalski, 1992

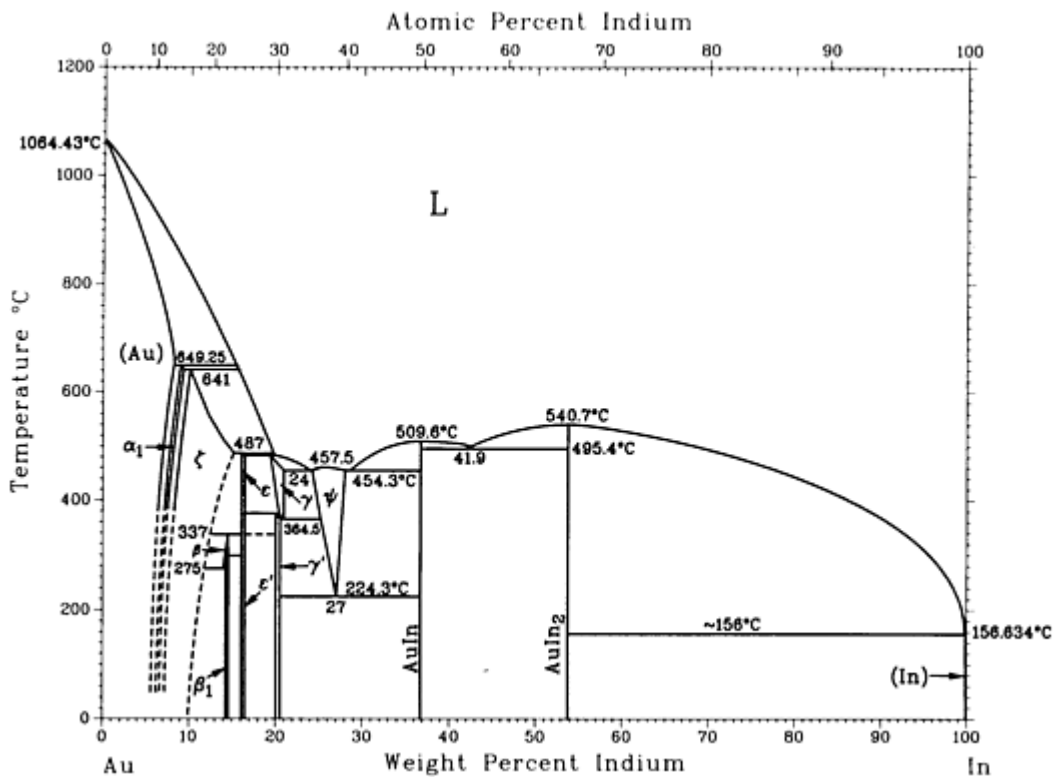

Au-In phase diagram

Au-In crystallographic data

Phase	Composition, wt% In	Pearson symbol	Space group
(Au)	0 to 7.8	$cF4$	$Fm\bar{3}m$

α_1	7.4 to 8.9	<i>hP16</i> <i>hP4</i>	<i>P6₃/mmc</i> <i>P6₃/mmc</i>
ζ	8 to 14.8	<i>hP2</i>	<i>P6₃/mmc</i>
β	13.8 to 14.3	(a) (b)
β_1	13.9 to 14.5	<i>hP26</i> (a)	<i>P3</i> ...
ϵ	15.9 to 16.3	(b)	...
ϵ'	15.9 to 16.3	<i>oP8</i>	<i>Pmmn</i>
γ	19.1 to 21.1	<i>cP52</i> <i>cP76</i>	<i>P$\bar{4}$3m</i> <i>P$\bar{4}$3m</i>
γ'	19.8 to 20.5	<i>hP60</i>	<i>P3</i>
ψ	24.1 to 27.6	<i>hP5</i>	<i>P$\bar{3}$m1</i>
AuIn	37 to 36.9	(c)	...
AuIn ₂	53.9	<i>cF12</i>	<i>Fm$\bar{3}$m</i>
(In)	100	<i>tI2</i>	<i>I4/mmm</i>

(a) Hexagonal.

(b) Orthorhombic.

(c) Triclinic

Au-K (Gold - Potassium)

A.D. Pelton, 1987

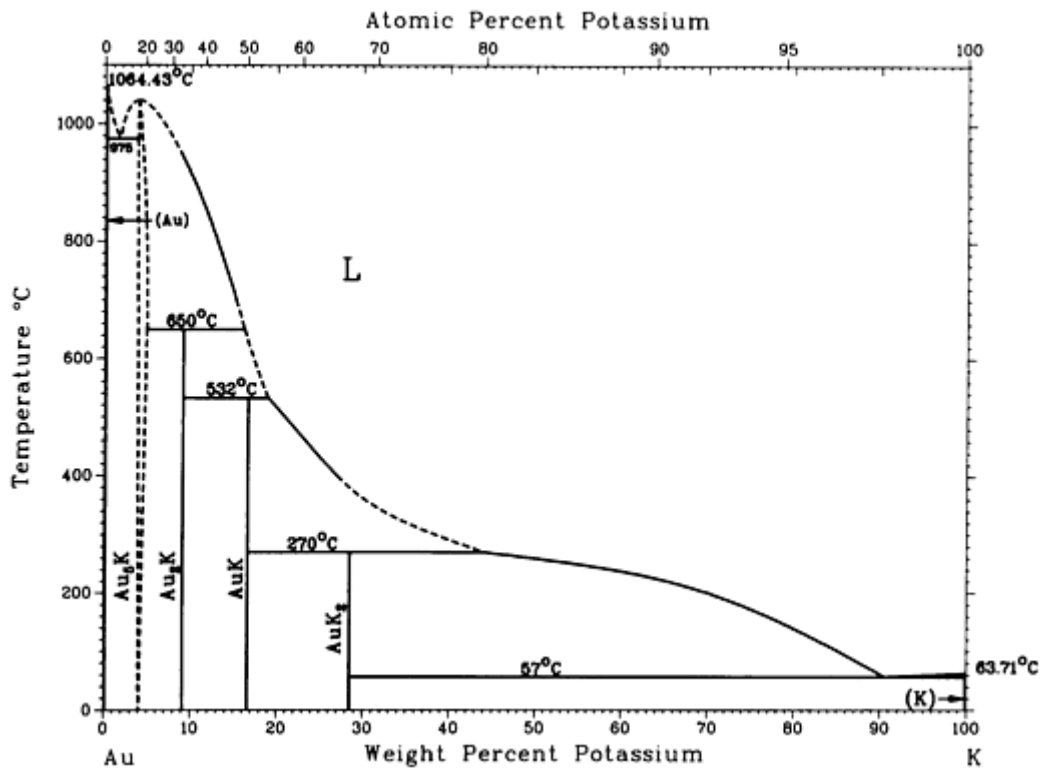

Au-K phase diagram

Au-K crystallographic data

Phase	Composition, wt% K	Pearson symbol	Space group
(Au)	0	<i>cF4</i>	<i>Fm</i> $\bar{3}m$
Au ₅ K	3.8	<i>hP6</i>	<i>P6/mmm</i>
Au ₂ K	9.0
AuK	16.6
AuK ₂	28.5
(K)	100	<i>cI2</i>	<i>Im</i> $\bar{3}m$

Note: At 25 °C

Au-La (Gold - Lanthanum)

K.A. Gschneidner, Jr., F.W. Calderwood, H. Okamoto, and T.B. Massalski, 1987

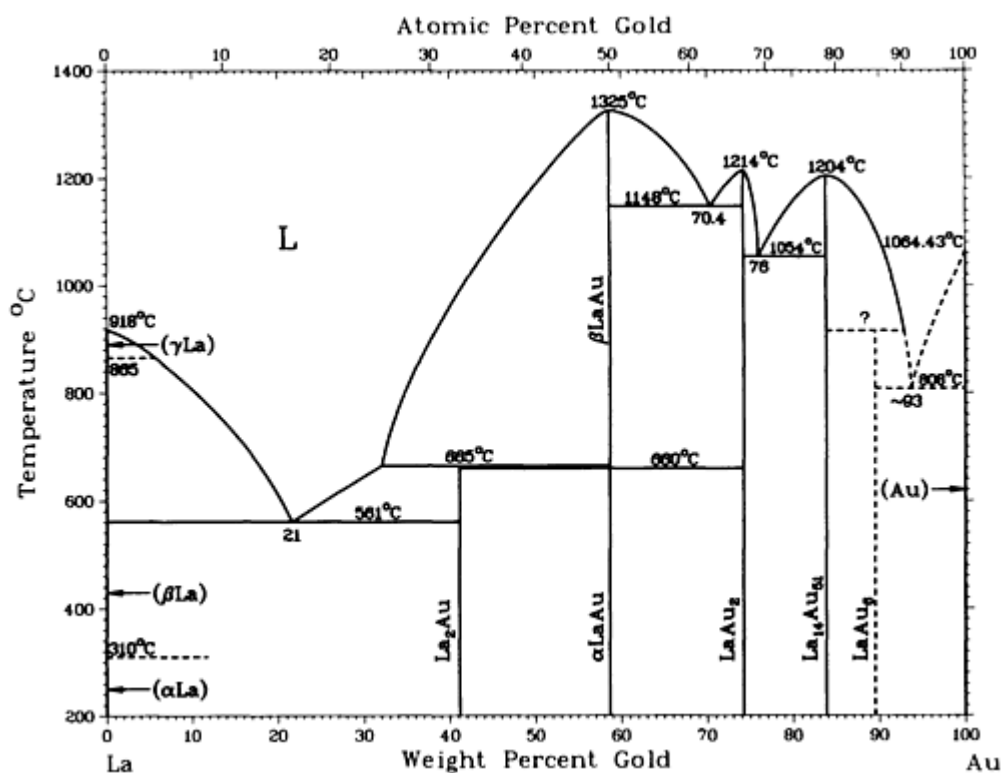

Au-La phase diagram

Au-La crystallographic data

Phase	Composition, wt% Au	Pearson symbol	Space group
(αLa)	0	$hP4$	$P6_3/mmc$
(βLa)	0	$cF4$	$Fm\bar{3}m$
(γLa)	0	$cI2$	$Im\bar{3}m$
La_2Au	41.5	$oP12$	$Pnma$
αLaAu	59	$oP8$	$Pnma$
βLaAu	59	$oC8$	$Cmcm$
LaAu_2	74.0	$oI12$	$Imma$

Au_5Li_4	2.7	(c)	...
β_2	3 to 4	<i>oP2</i>	...
β_1	4 to 4.1	<i>tP2?</i> ^(b)	...
β	4.1 to 4.3	<i>cP2</i>	<i>Pm</i> $\bar{3}m$
$\delta_{2(\text{HT})}$	5.6 to 6.3	<i>hP9</i>	...
$\delta_{1(\text{LT})}$	5.6 to 6.3	(d)	...
AuLi_3	10	<i>cF16</i>	<i>Fm</i> $\bar{3}m$
$\text{Au}_4\text{Li}_{15}$	12	<i>cI76</i>	<i>I</i> $\bar{4}3d$
$(\beta_{\text{Li}})^{\text{(a)}}$	100	<i>cI2</i>	<i>Im</i> $\bar{3}m$
$(\alpha_{\text{Li}})^{\text{(e)}}$	100	<i>hP2</i>	<i>P6</i> $_3/mmc$

(a) At 25 °C.

(b) Complex.

(c) Hexagonal.

(d) Similar to δ_2 .

(e) *T* less than -201 °C

Au-Mg (Gold - Magnesium)

A.A. Nayeb-Hashemi and J.B. Clark, 1988

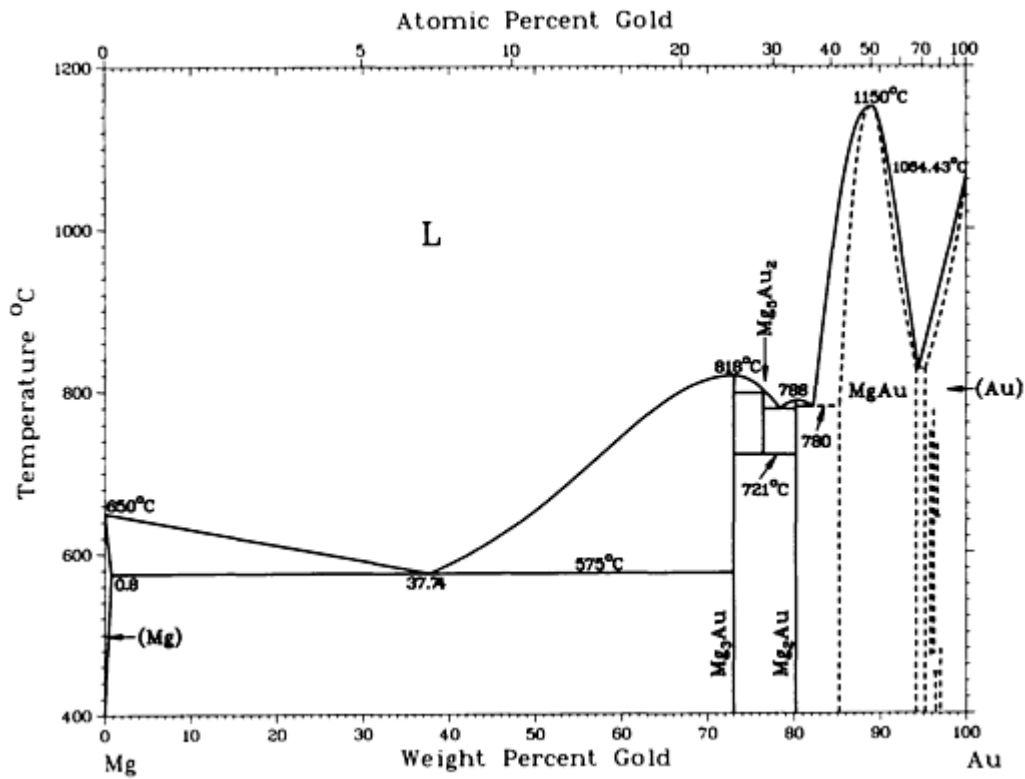

Au-Mg phase diagram

Au-Mg crystallographic data

Phase	Composition, wt% Au	Pearson symbol	Space group
(Mg)	0 to 0.8	<i>hP2</i>	<i>P6₃/mmc</i>
Mg ₃ Au	73	<i>hP8</i>	<i>P6₃/mmc</i> or <i>P$\bar{3}c1$</i>
Mg ₅ Au ₂	76.42
Mg ₂ Au	80.20	...	<i>Pnam</i> or <i>Pna2₁</i>
(MgAu)	89.5	<i>cP2</i>	<i>Pm$\bar{3}m$</i>
Mg ₂₆ Au ₇₄	96	<i>oC160</i>	<i>Cm2m</i>
Mg ₂₄ Au ₇₆	96.3	<i>oC64</i>	<i>Cmcm</i>

$\text{Mg}_{23}\text{Au}_{77}$	96.6	<i>hP108</i>	<i>P6_3/mcm</i>
$\text{Mg}_{22}\text{Au}_{78}$	96.64	<i>tI16</i>	<i>I4/mmm</i>
$\text{Mg}_4\text{Au}_{15}$	96.81	<i>mP38</i>	<i>B2/m</i>
MgAu_4	97	(a)	...
(Au)	100	<i>cF4</i>	<i>Fm\bar{3}m</i>

(a) Structure reportedly is related to that of the "X-phase," $\text{Mg}_4\text{Au}_{15}$.

Au-Mn (Gold - Manganese)

T.B. Massalski and H. Okamoto, 1987

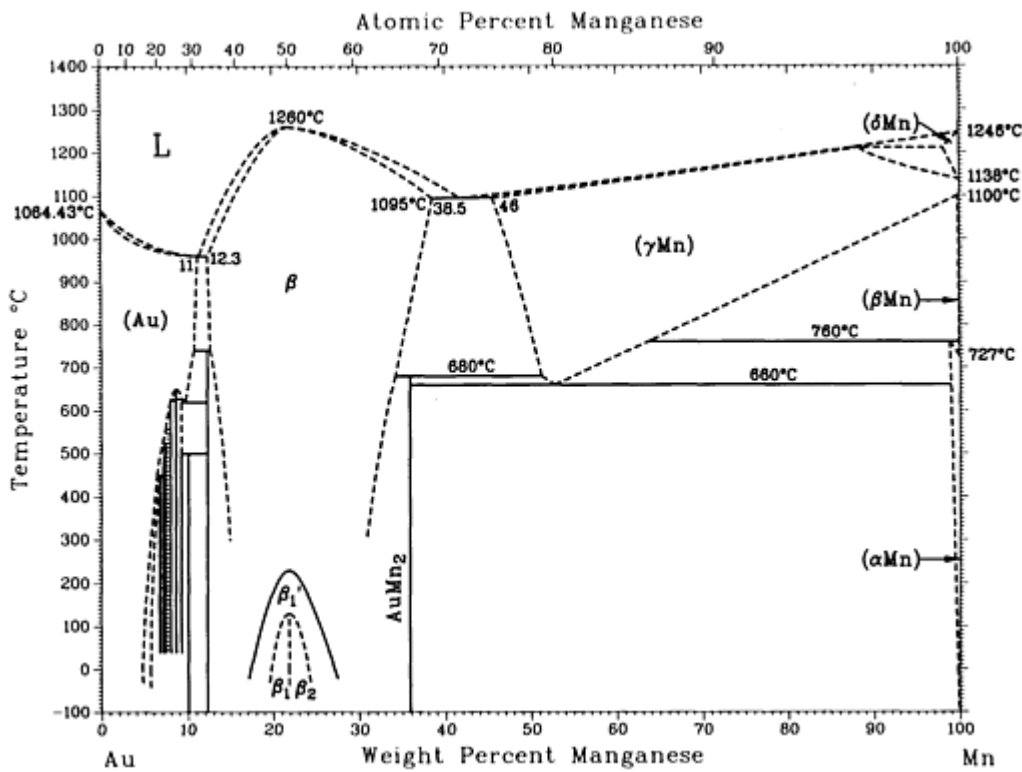

Au-Mn phase diagram

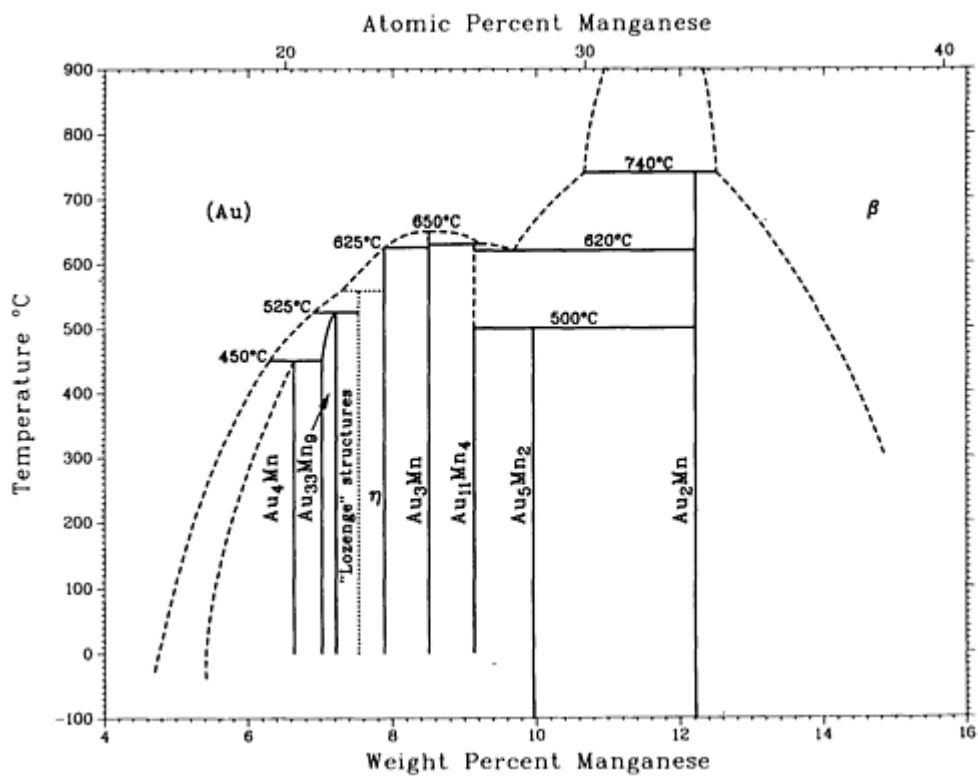

Au-rich region of the Au-Mn phase diagram

Au-Mn crystallographic data

Phase	Composition, wt% Mn	Pearson symbol	Space group
(Au)	0 to 11	<i>cF4</i>	<i>Fm</i> $\bar{3}m$
Au ₄ Mn	5 to 6	<i>tI10</i>	<i>I4/m</i>
Au ₃₃ Mn ₉	7.07	(a)	<i>P2₁/b</i>
Au ₂₂ Mn ₆	7.07	(a)	...
α''	7.0 to 7.2	(b)	<i>Pnmm</i>
Au ₃₁ Mn ₉	7.49	(c)	...
2 <i>d</i> -APS(I)	...	(d)	...
Au ₃₁ Mn ₉	7.49	(b)	...
Au ₇₂ Mn ₂₁	5.52	(a)	...

$\text{Au}_{41}\text{Mn}_{12}$	7.55	(a)	...
$\text{Au}_{167}\text{Mn}_{49}$	7.57	(b)	...
$\text{Au}_{95}\text{Mn}_{28}$	7.59	(a)	...
$\text{Au}_{27}\text{Mn}_8$	7.63	(b)	...
$\text{Au}_{13}\text{Mn}_4$ (<i>II</i>)	7.50	(b)	...
$2d\text{-Au}_3\text{Mn}^{(e)}$	~ 8	<i>oP32</i>	<i>Pnmm</i>
Au_3Mn	7.2 to 10
<i>5H</i>	...	(b)	...
<i>3R</i>	...	(b)	...
<i>M</i> = 1	...	<i>tI8</i>	<i>I4/mmm</i>
<i>6H</i> ₁	...	(b)	...
<i>6H</i> ₂	...	(b)	...
$\text{Au}_3\text{Mn(I)}^{(f)}$	9	(b)	...
<i>X</i> ($\text{Au}_{11}\text{Mn}_4$)	9.21	(a)	...
(f)	~ 9.2	(b)	...
$\text{Au}_{11}\text{Mn}_4\text{I}^{(f)}$	~ 9.2	(a)	...
$\text{Au}_{11}\text{Mn}_4\text{II}^{(f)}$	~ 9.2	(a)	...
$\text{Au}_{11}\text{Mn}_4\text{III}^{(e) (f)}$	~ 9.2	(a)	...
<i>AABB</i> ^(f)	~ 9.2	(g)	...
Au_5Mn_2	10.04	(a)	<i>C2/m</i>

Au ₂ Mn	12.24	<i>tI6</i>	<i>I4/mmm</i>
β	12.3 to 38.5	<i>cP2</i>	<i>Pm\bar{3}m</i>
β_1	16 to 29	^(g)	...
β_1	19 to 22	^(g)	...
β_2	22 to 25 23	^(g) ^(b)
AuMn ₂	36	<i>tI6</i>	<i>I4/mmm</i>
(δ Mn)	100	<i>cI2</i>	<i>Im\bar{3}m</i>
(γ Mn)	46 to 100	<i>cF4</i>	<i>Fm\bar{3}m</i>
(β Mn)	100	<i>cP20</i>	<i>P4₁32</i>
(α Mn)	100	<i>cI58</i>	<i>I\bar{4}3m</i>
(γ Mn1) ^(f)	67 to 100	^(g)	...
(γ Mn2) ^(f)	60.5 to 75.3	^(g)	...
^(f)	73.4	^(b)	...

Note: 2d = two dimensional. APS = antiphase structure.

- (a) Monoclinic.
- (b) Orthorhombic.
- (c) Square island.
- (d) Lozenge island.
- (e) Thin film.

(f) Metastable.

(g) Tetragonal

Au-Na (Gold - Sodium)

A.D. Pelton, 1987

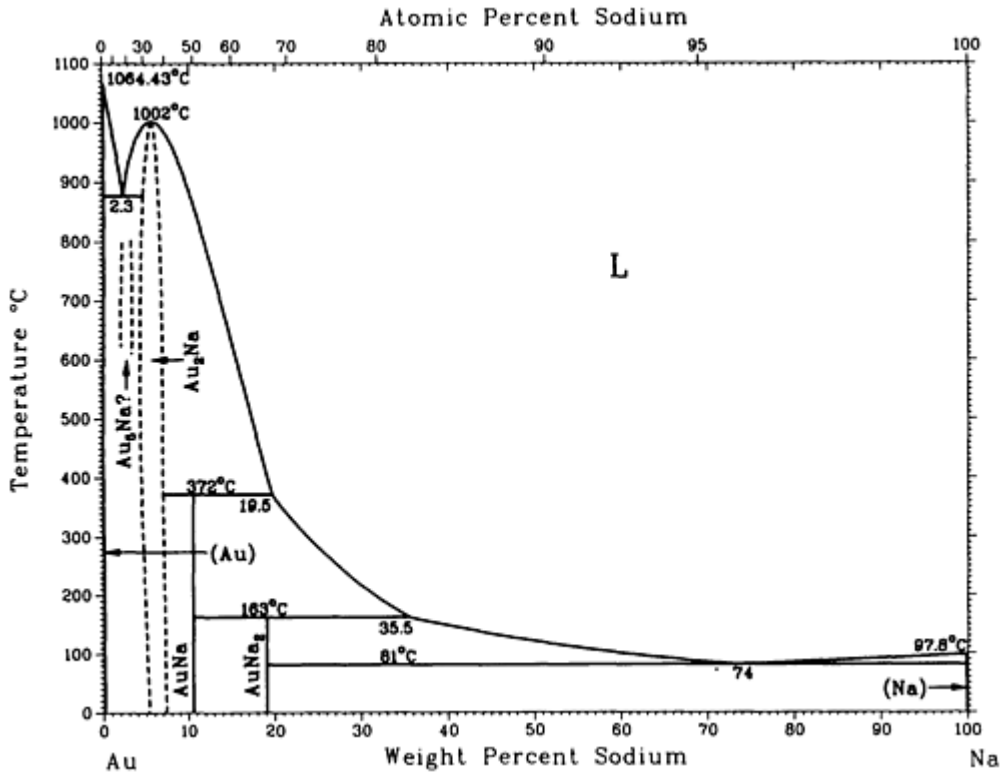

Au-Na phase diagram

Au-Na crystallographic data

Phase	Composition, wt% Na	Pearson symbol	Space group
(Au)	0	<i>cF4</i>	<i>Fm</i> $\bar{3}m$
Au ₅ Na ^(a)	2 to 3
Au ₂ Na	5 to 7	<i>cF24</i>	<i>Fd</i> $\bar{3}m$
AuNa	10	^(b)	...
AuNa ₂	18.9 to 21	<i>tI12</i>	<i>I4/mcm</i>

(Na)	100	$cI2$	$Im\bar{3}m$
(Na) ^(c)	100	$hP2$	$P6_3/mmc$

(a) Existence requires verification; $T = 775\text{ }^\circ\text{C}$.

(b) Complex structure.

(c) T is less than $-237\text{ }^\circ\text{C}$.

Au-Nb (Gold - Niobium)

H. Okamoto and T.B. Massalski, 1987

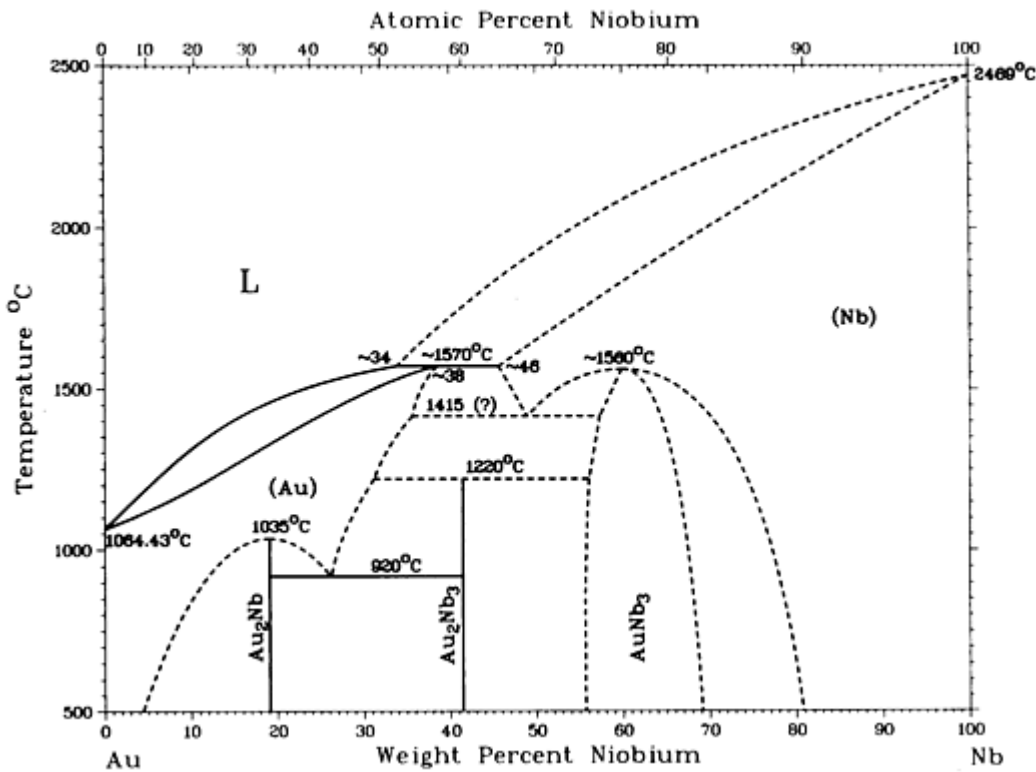

Au-Nb phase diagram

Au-Nb crystallographic data

Phase	Composition, wt% Nb	Pearson symbol	Space group
(Au)	0 to ~ 38	$cF4$	$Fm\bar{3}m$
Au_2Nb	19.1	$hP3$	$P6/mmm$

Au ₂ Nb ₃	41	<i>tI10</i>	<i>I4/mmm</i>
AuNb ₃	56 to 70	<i>cP8</i>	<i>Pm$\bar{3}n$</i>
(Nb)	~46 to 100	<i>cI2</i>	<i>Im$\bar{3}m$</i>

Au-Ni (Gold - Nickel)

H. Okamoto and T.B. Massalski, 1991

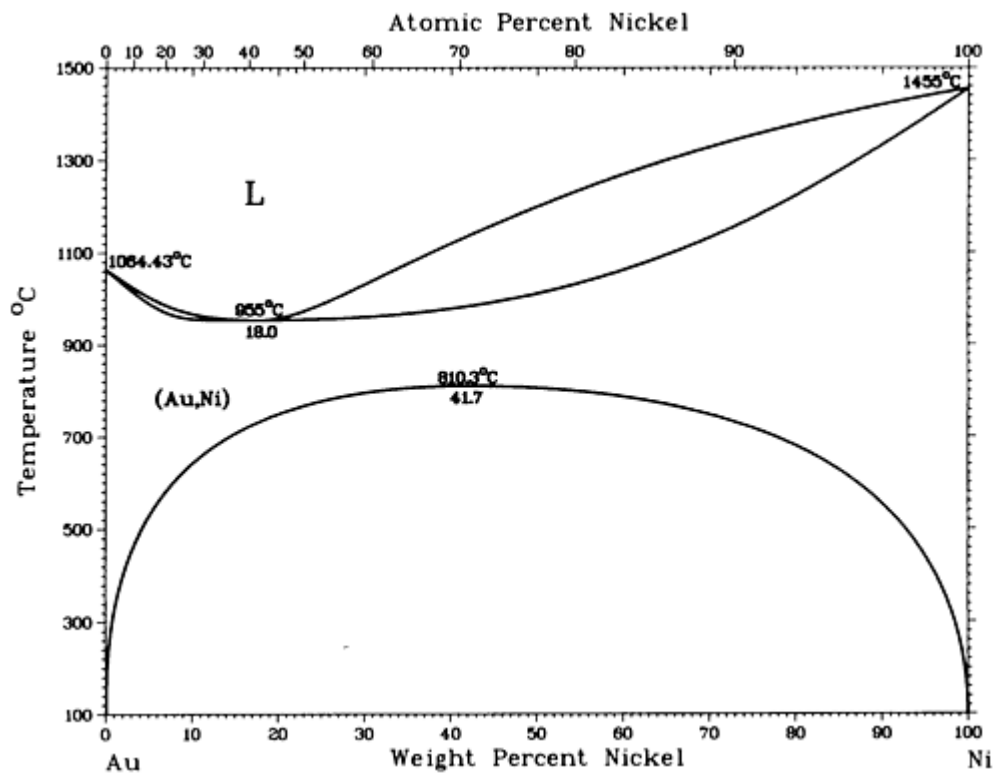

Au-Ni phase diagram

Au-Ni crystallographic data

Phase	Composition, wt% Ni	Pearson symbol	Space group
(Au,Ni)	0 to 100	<i>cF4</i>	<i>Fm$\bar{3}m$</i>

Au-Pb (Gold - Lead)

H. Okamoto and T.B. Massalski, 1987

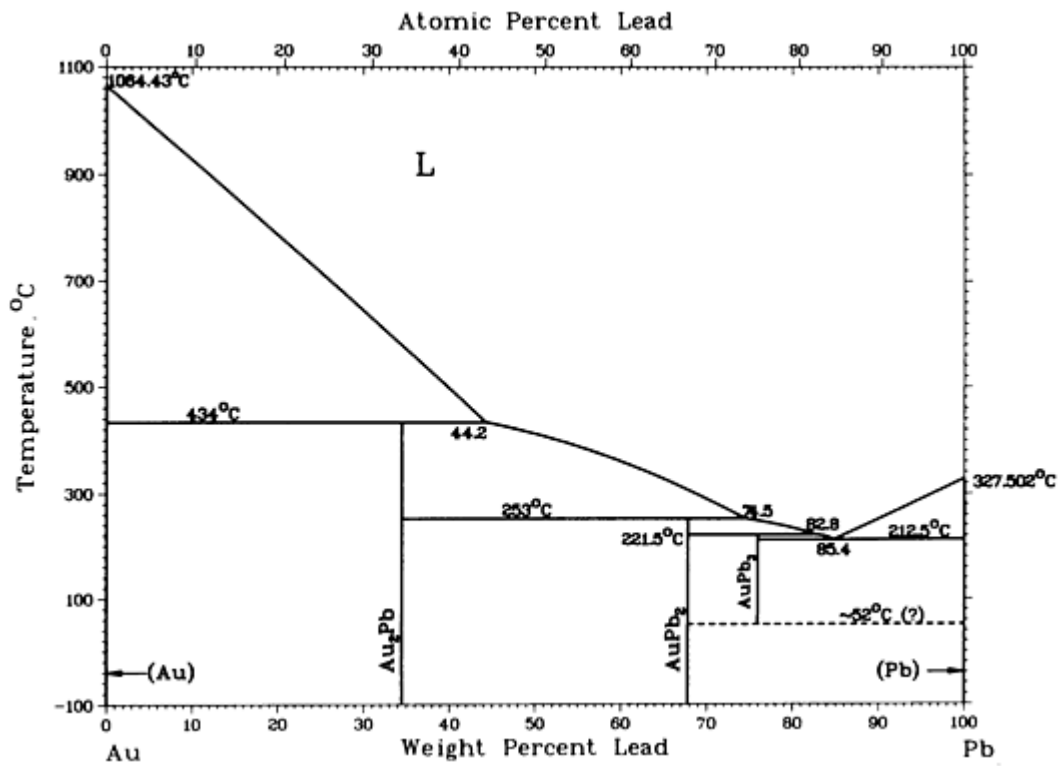

Au-Pb phase diagram

Au-Pb crystallographic data

Phase	Composition, wt% Pb	Pearson symbol	Space group
(Au)	0 to 0.12	<i>cF4</i>	<i>Fm</i> $\bar{3}m$
Au ₂ Pb	34.4	<i>cF24</i>	<i>Fd</i> $\bar{3}m$
AuPb ₂	67.8	<i>tI12</i>	<i>I4/mcm</i>
AuPb ₃	75.9	<i>tI32</i>	<i>I</i> $\bar{4}2m$
(Pb)	99.81 to 100	<i>cF4</i>	<i>Fm</i> $\bar{3}m$

Au-Pd (Gold - Palladium)

H. Okamoto and T.B. Massalski, 1987

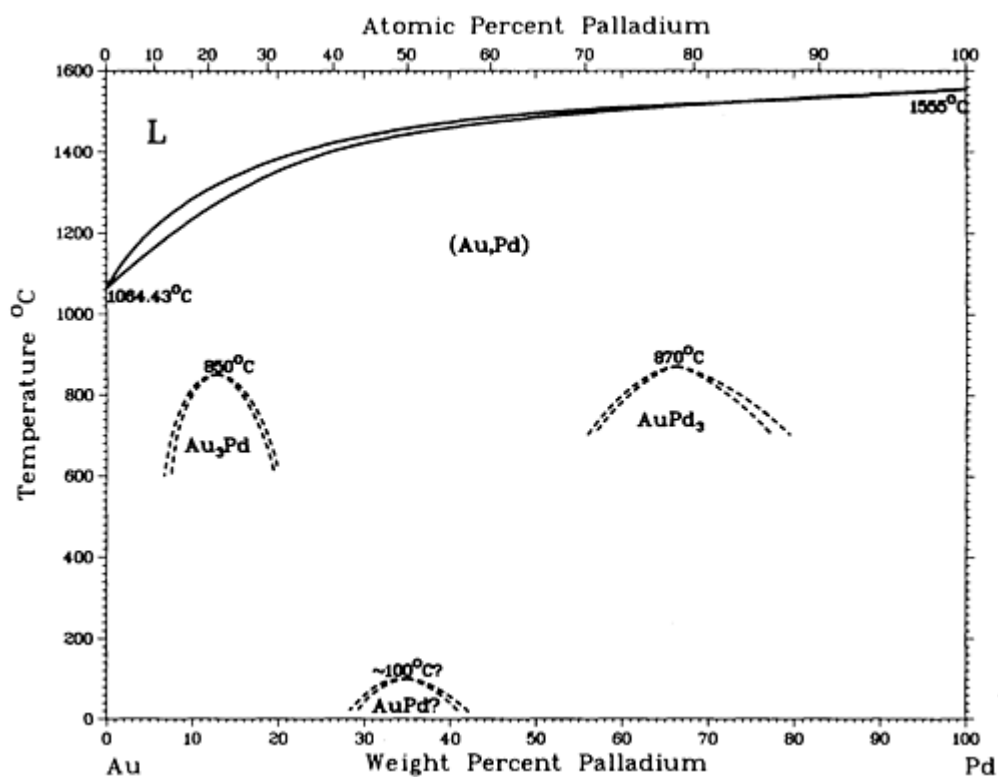

Au-Pd phase diagram

Au-Pd crystallographic data

Phase	Composition, wt% Pd	Pearson symbol	Space group
(Au,Pd)	0 to 100	<i>cF4</i>	<i>Fm</i> $\bar{3}m$
Au ₃ Pd	7 to 20	<i>cP4</i>	<i>Pm</i> $\bar{3}m$
AuPd	?	(a)	...
AuPd ₃	53 to 83	<i>cP4</i> (?)	<i>Pm</i> $\bar{3}m$

(a) Long period?

Au-Pr (Gold - Praseodymium)

K.A. Gschneidner, Jr., F.W. Calderwood, H. Okamoto, and T.B. Massalski, 1987

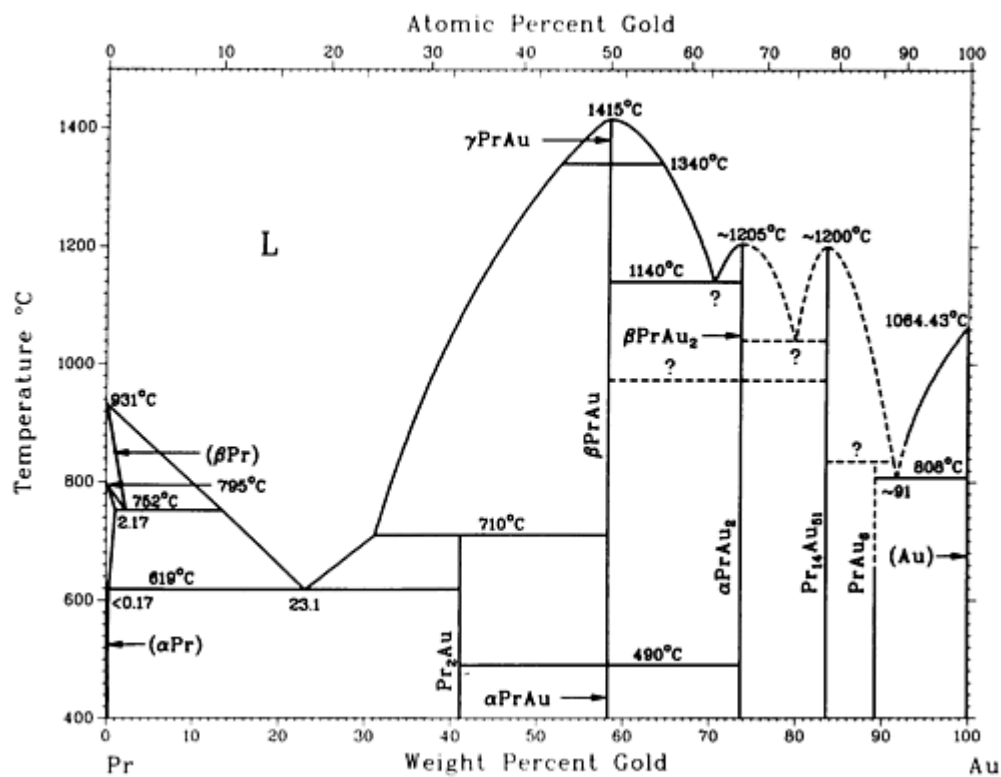

Au-Pr phase diagram

Au-Pr crystallographic data

Phase	Composition, wt% Au	Pearson symbol	Space group
(α Pr)	0 to <0.17	<i>hP4</i>	<i>P6₃/mmc</i>
(β Pr)	0 to 2.17	<i>cI2</i>	<i>Im$\bar{3}m$</i>
Pr ₂ Au	41.1	<i>oP12</i>	<i>Pnma</i>
α PrAu	58	<i>oP8</i>	<i>Pnma</i>
β PrAu	58	<i>oC8</i>	<i>Cmcm</i>
γ PrAu	58	<i>cP2</i>	<i>Pm$\bar{3}m$</i>
α PrAu ₂	73.7	<i>oI12</i>	<i>Imma</i>

β PrAu ₂	73.7	<i>t</i> P108	<i>P4/nmm</i>
Pr ₁₄ Au ₅₁	~81 to ~83.6	<i>h</i> P65	<i>P6/m</i>
PrAu ₆	89.3	<i>m</i> C28	<i>C2/c</i>
(Au)	~99.93 to 100	<i>c</i> F4	<i>Fm</i> $\bar{3}m$

Au-Pt (Gold - Platinum)

H. Okamoto and T.B. Massalski, 1987

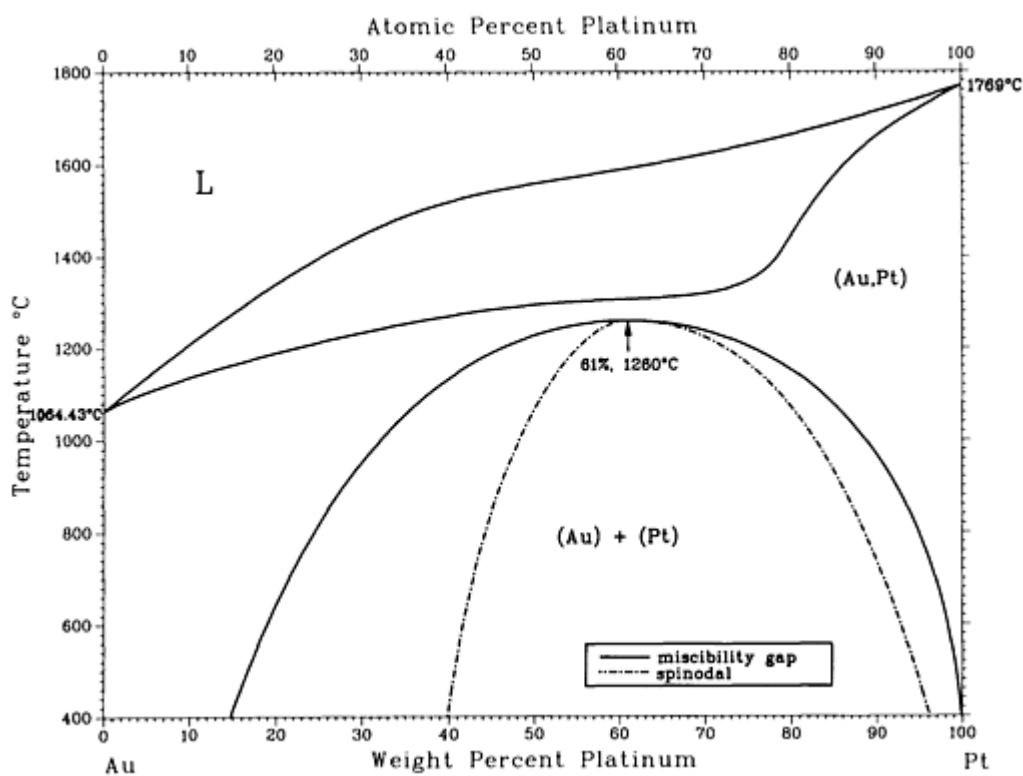

Au-Pt phase diagram

Au-Pt crystallographic data

Phase	Composition, wt% Pt	Pearson symbol	Space group
(Au,Pt)	0 to 100	<i>c</i> F4	<i>Fm</i> $\bar{3}m$
Metastable phases			

Au ₃ Pt	4.9 to 39.8
AuPt	49.8	(a)	...
AuPt ₃	74.8

(a) Tetragonal

Au-Pu (Gold - Plutonium)

H. Okamoto, T.B. Massalski, and D.E. Peterson, 1987

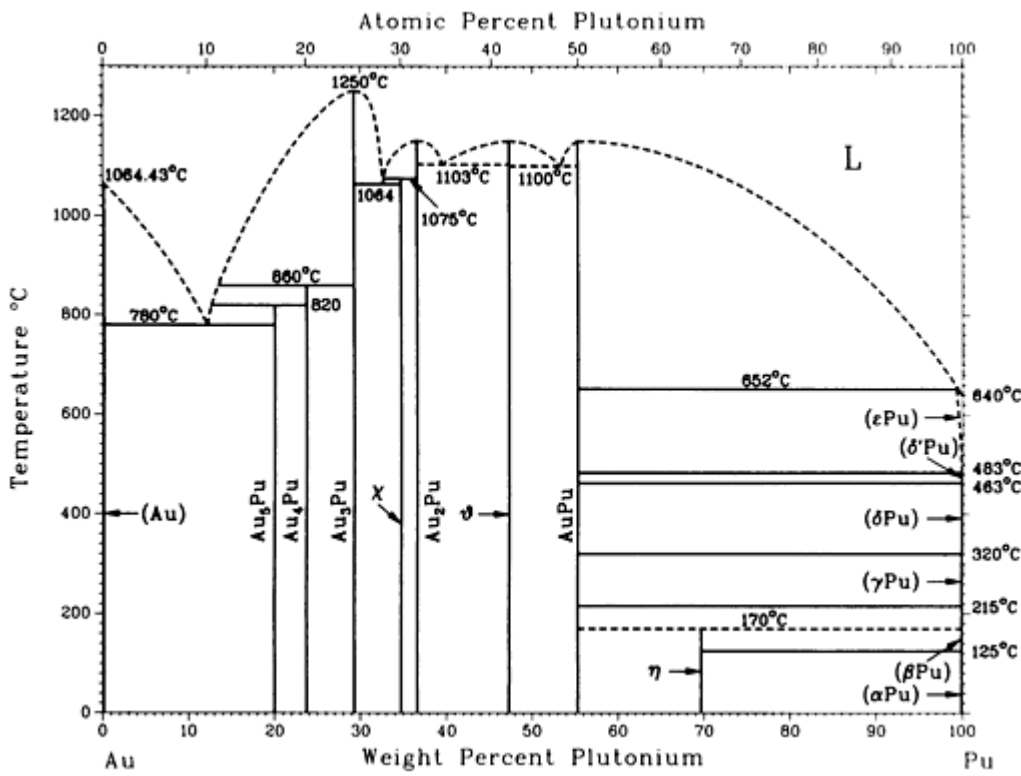

Au-Pu phase diagram

Au-Pu crystallographic data

Phase	Composition, wt% Pu	Pearson symbol	Space group
(Au)	0	<i>cF4</i>	<i>Fm</i> $\bar{3}$ <i>m</i>
Au ₅ Pu (<i>V</i>)	19.9	Unknown	...

$\text{Au}_4\text{Pu} (\mu)$	23.7	Unknown	...
$\text{Au}_3\text{Pu} (\lambda)$	29.2	^(a)	...
χ	35	Unknown	...
$\text{Au}_2\text{Pu} (\iota)$	38.2	Unknown	...
θ	47	Unknown	...?
$\text{AuPu} (\zeta)$	55.3	Unknown	...
η	70	Unknown	...
(ϵPu)	99.2 to 100	<i>cI2</i>	<i>$I\bar{m}\bar{3}m$</i>
$(\delta^*\text{Pu})$	100	<i>tI2</i>	<i>$I4/mmm$</i>
(δPu)	100	<i>cF4</i>	<i>$Fm\bar{3}m$</i>
(γPu)	100	<i>oF8</i>	<i>$Fddd$</i>
(βPu)	100	<i>mC34</i>	<i>$C2/m$</i>
(αPu)	100	<i>$mP16$</i>	<i>$P2_1/m$</i>

(a) Hexagonal

Au-Rb (Gold - Rubidium)

A.D. Pelton, 1987

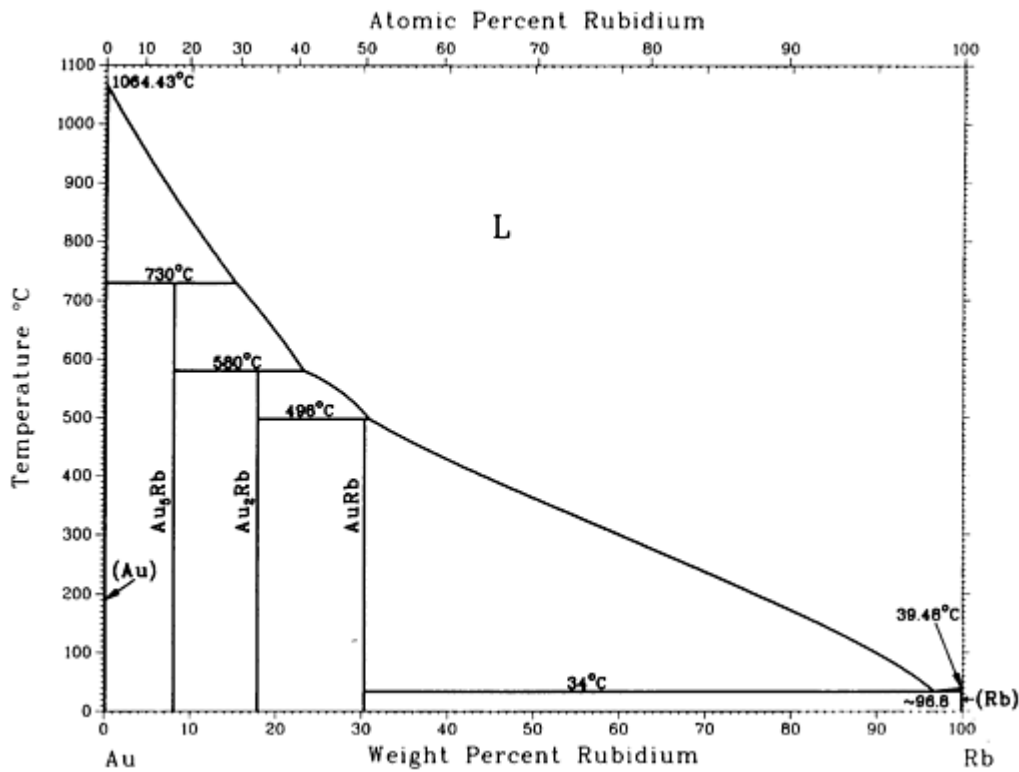

Au-Rb phase diagram

Au-Rb crystallographic data

Phase	Composition, wt% Rb	Pearson symbol	Space group
(Au)	0	<i>cF4</i>	<i>Fm</i> $\bar{3}m$
Au ₅ Rb	8.0	<i>hP6</i>	<i>P6/mmm</i>
Au ₂ Rb	17.8
AuRb	30.3	<i>cP2</i>	<i>Pm</i> $\bar{3}m$
(Rb)	100	<i>cI2</i>	<i>Im</i> $\bar{3}m$

Au-Sb (Gold - Antimony)

H. Okamoto and T.B. Massalski, 1987

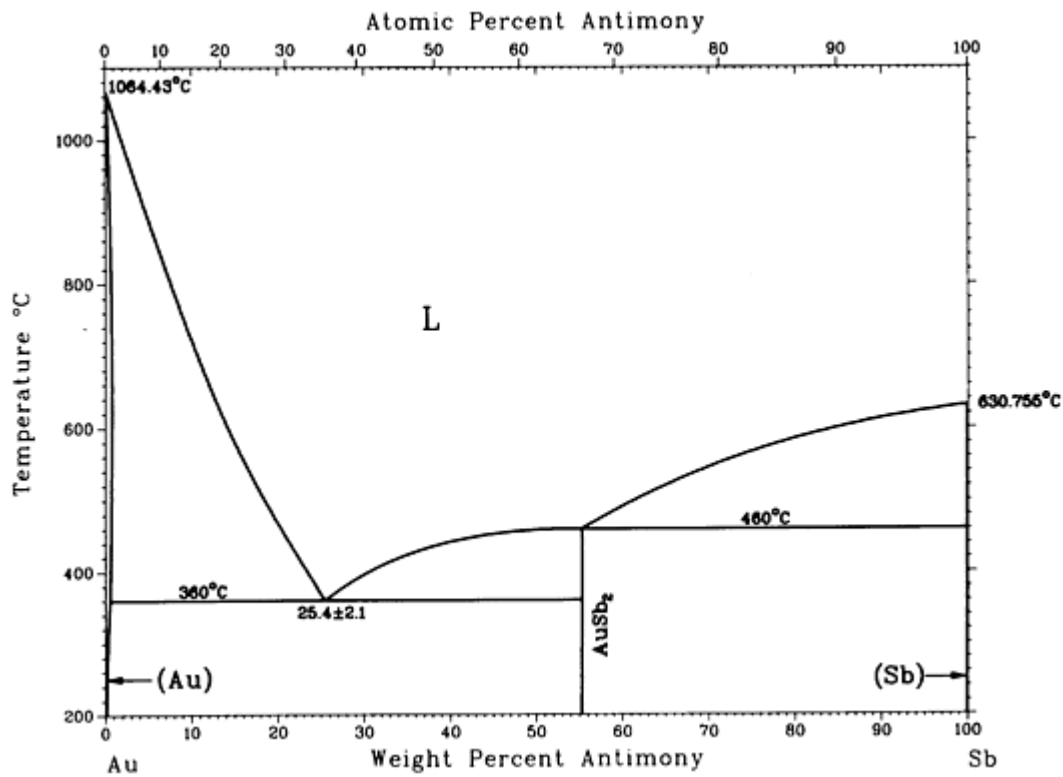

Au-Sb phase diagram

Au-Sb crystallographic data

Phase	Composition, wt% Sb	Pearson symbol	Space group
(Au)	0 to 0.75	<i>cF4</i>	<i>Fm</i> $\bar{3}m$
AuSb ₂	55.3	<i>cP12</i>	<i>Pa</i> 3
(Sb)	100	<i>hR2</i>	<i>R</i> $\bar{3}m$
Metastable phases			
...	8 to 10	<i>hP2</i>	<i>P6</i> ₃ / <i>mmc</i>
...	61 to 76	<i>cP1</i>	<i>Pm</i> $\bar{3}m$

Au-Se (Gold - Selenium)

H. Okamoto and T.B. Massalski, 1987

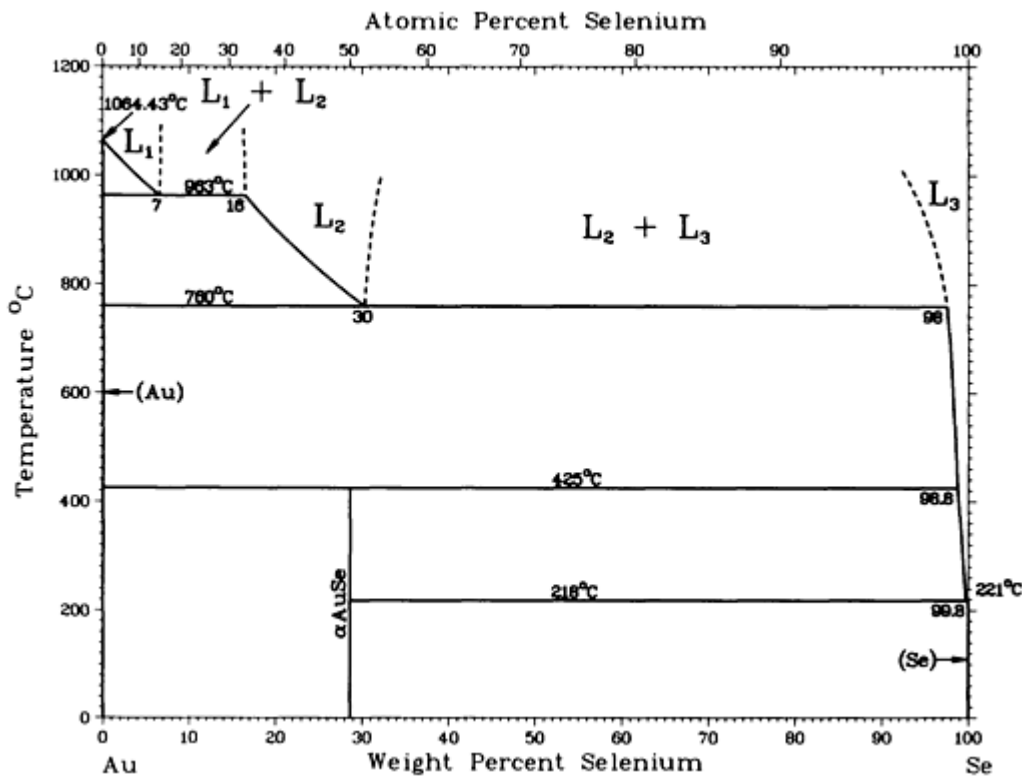

Au-Se phase diagram

Au-Se crystallographic data

Phase	Composition, wt% Se	Pearson symbol	Space group
(Au)	0	<i>cF4</i>	<i>Fm$\bar{3}m$</i>
α AuSe	29	<i>mC24</i>	<i>C2/m</i>
β _{AuSe^(a)}	29	<i>mC12</i>	<i>C2/m</i>
(Se)	100	<i>hP3</i>	<i>P3₁21</i>

(a) Metastable

Au-Si (Gold - Silicon)

H. Okamoto and T.B. Massalski, 1987

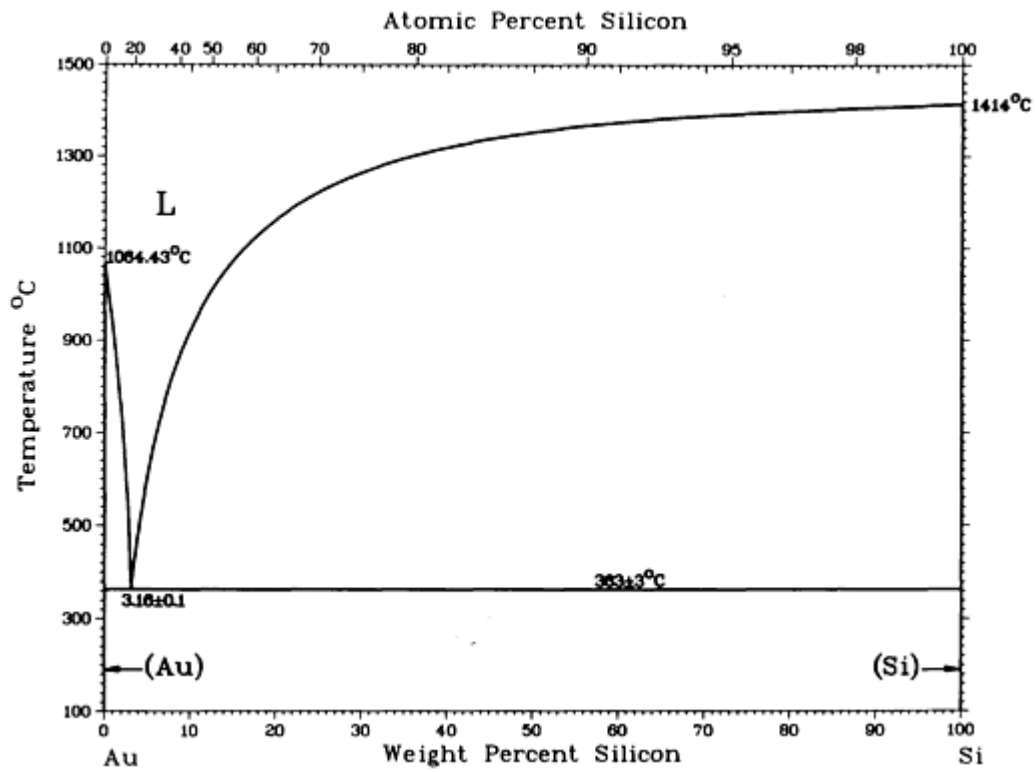

Au-Si phase diagram

Au-Si crystallographic data

Phase	Composition, wt% Si	Pearson symbol	Space group
(Au)	0	$cF4$	$Fm\bar{3}m$
(Si)	100	$cF8$	$Fd\bar{3}m$

Au-Sn (Gold - Tin)

H. Okamoto and T.B. Massalski, 1987

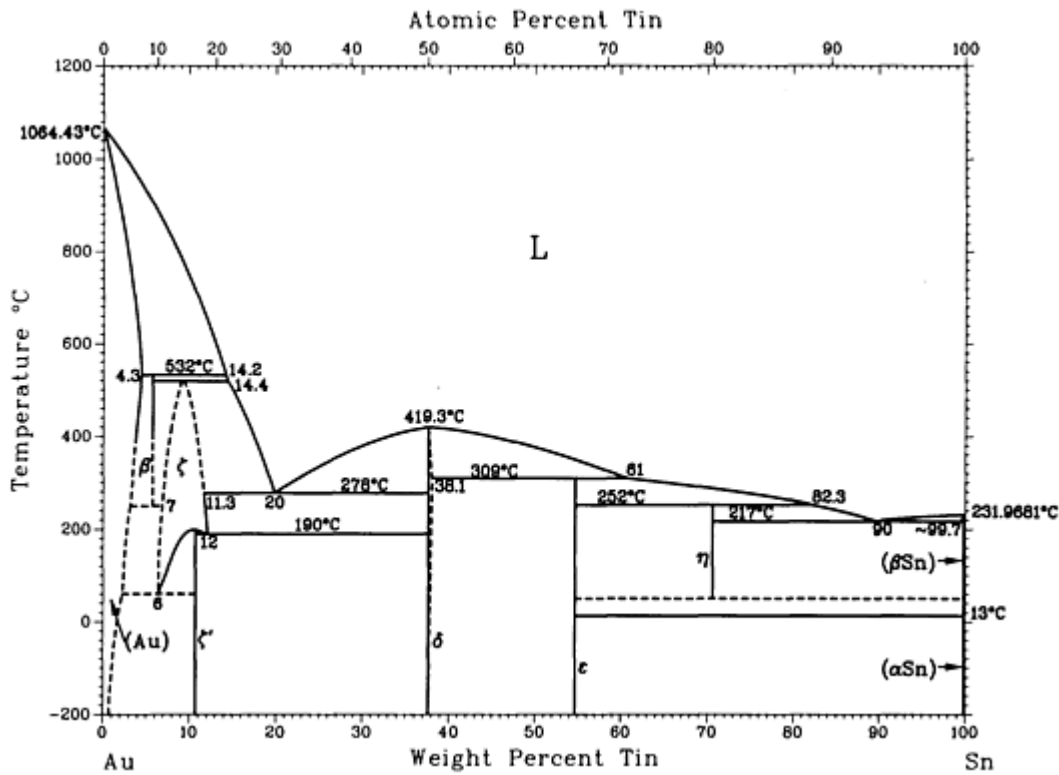

Au-Sn phase diagram

Au-Sn crystallographic data

Phase	Composition, wt% Sn	Pearson symbol	Space group
(Au)	0 to 4.3	<i>cF4</i>	<i>Fm$\bar{3}m$</i>
β or Au ₁₀ Sn	5.7	<i>hP16</i>	<i>P6₃/mmc</i>
ζ	7 to 12	<i>hP2</i>	<i>P6₃/mmc</i>
ζ' or Au ₅ Sn	10.8	(a)	<i>R$\bar{3}$</i>
δ or AuSn	38 to 38.08	<i>hP4</i>	<i>P6₃/mmc</i>
ϵ or AuSn ₂	54.7	(b)	<i>Pbca</i>
η or AuSn ₄	71	<i>oC20</i>	<i>Aba2</i>

(β Sn)	99.7 to 100	<i>tI4</i>	<i>I4₁/amd</i>
(α Sn)	99.990 to 100	<i>cF8</i>	<i>Fm$\bar{3}m$</i>

- (a) Hexagonal.
- (b) Orthorhombic

Au-Sr (Gold - Strontium)

C.B. Alcock, V.P. Itkin, H. Okamoto, and T.B. Massalski, 1987

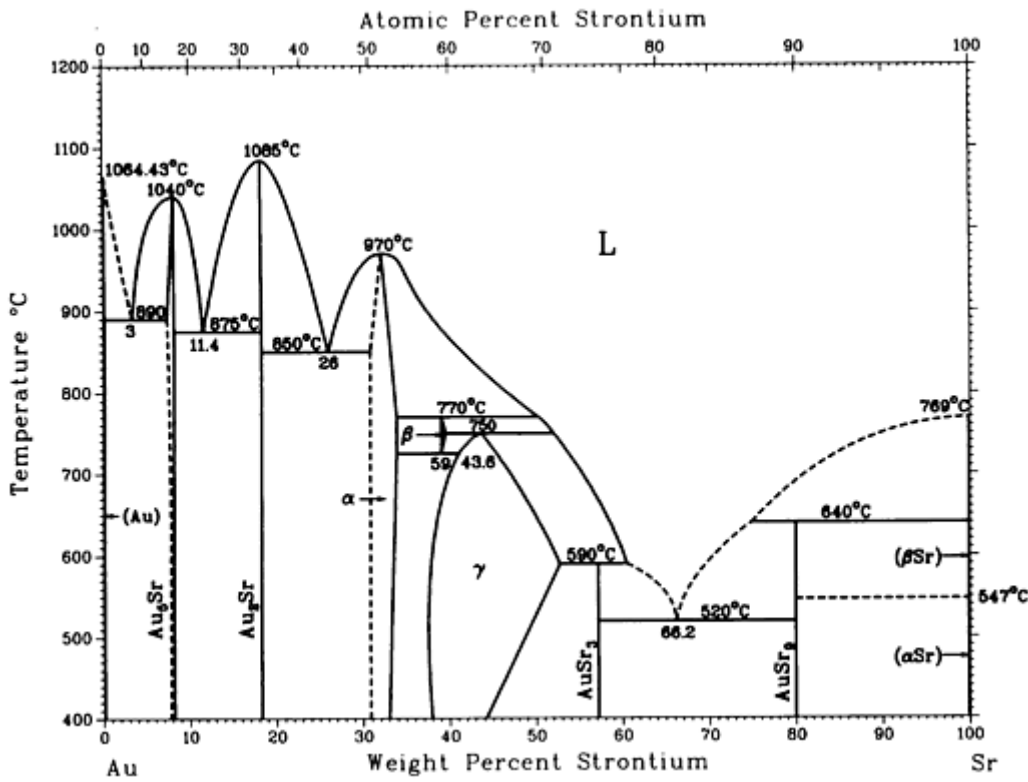

Au-Sr phase diagram

Au-Sr crystallographic data

Phase	Composition, wt% Sr	Pearson symbol	Space group
(Au)	0	<i>cF4</i>	<i>Fm$\bar{3}m$</i>

Au_5Sr	7.7 to 8.2	$hP6$	$P6/mmm$
Au_2Sr	18.2	$oI12$	$Imma$
α	32.1 to 34	?	...
β	39 to 40	?	...
γ	38.5 to 52.7	?	...
AuSr_3	57	$\gamma^{(a)}$...
AuSr_9	80	$\gamma^{(b)}$...
(β_{Sr})	100	$cI2$	$Im\bar{3}m$
(α_{Sr})	100	$cF4$	$Fm\bar{3}m$

(a) Complex.

(b) Hexagonal

Au-Te (Gold - Tellurium)

H. Okamoto and T.B. Massalski, 1987

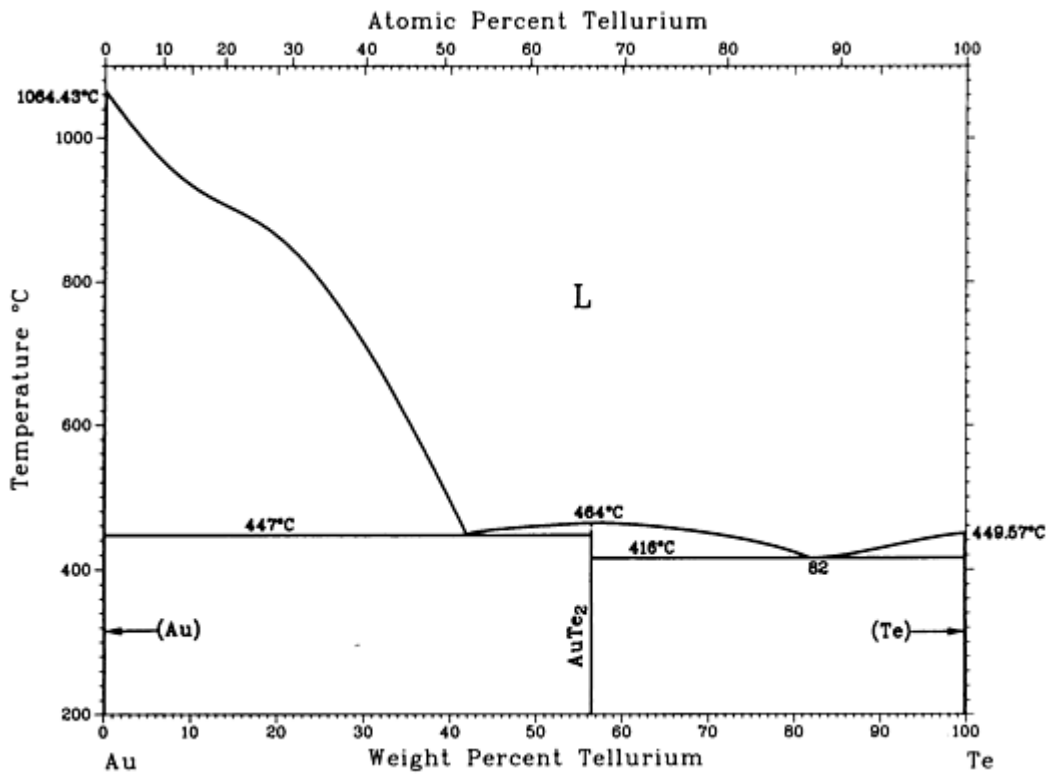

Au-Te phase diagram

Au-Te crystallographic data

Phase	Composition, wt% Te	Pearson symbol	Space group
(Au)	0 to 0.10	<i>cF4</i>	<i>Fm</i> $\bar{3}m$
AuTe ₂ (calaverite)	56.5	<i>mC6</i>	<i>C2/m</i>
(Te)	100	<i>hP3</i>	<i>P3</i> ₁ 21
Metastable phases and other phases			
Petzite ^(a)	24.4
Montbrayite ^(a)	49	<i>aP60</i>	P1

Krennerite ^(a)	56.5	<i>oP24</i>	<i>Pma2</i>
^(b)	48.9 to 79	<i>cP1</i>	<i>Pm$\bar{3}m$</i>
^(c)	91.8	^(d)	...
^(e)	60 to 100	^(f)	...

(a) Natural ore. May be stable only with additional impurities.

(b) Splat cooled at room temperature. Complete decomposition in 10 min at 165 °C (>69.6 at.% Te), 8 min at 260 °C or 10 h at 175 °C (62.5 at.% Te).

(c) Splat cooled at room temperature.

(d) Unidentified structure.

(e) Vapor deposition of Te on Au at room temperature.

(f) Amorphous

Au-Th (Gold - Thorium)

H. Okamoto, T.B. Massalski, and D.E. Peterson, 1991

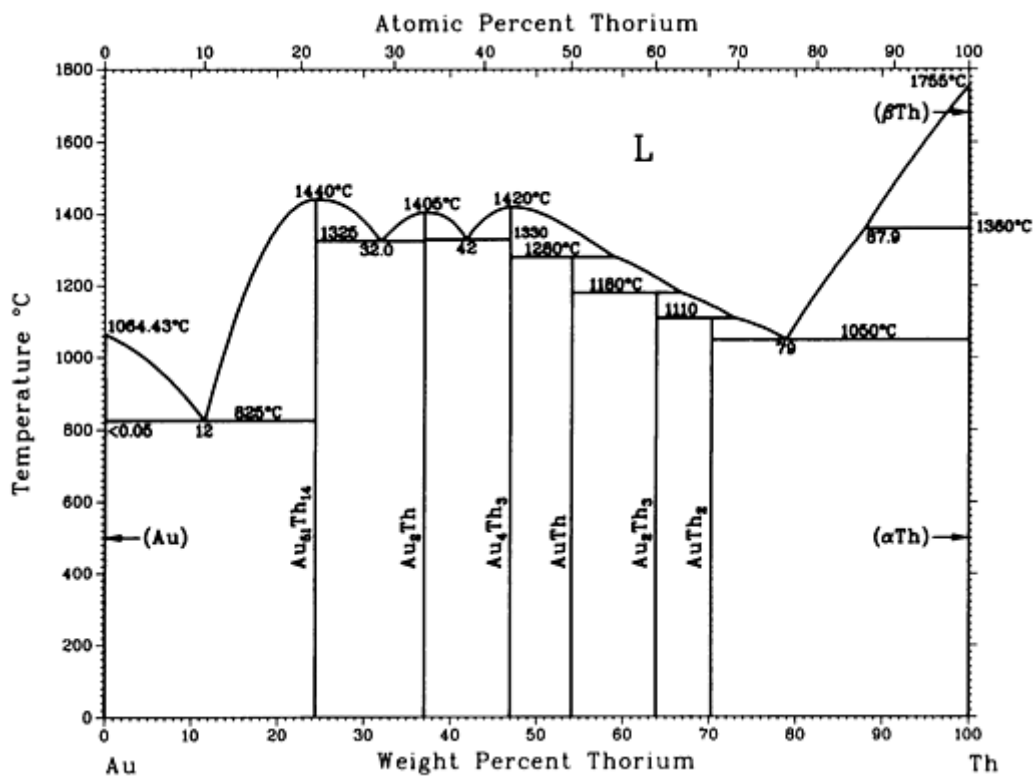

Au-Th phase diagram

Au-Th crystallographic data

Phase	Composition, wt% Th	Pearson symbol	Space group
(Au)	~0	<i>cF4</i>	<i>Fm</i> $\bar{3}m$
Au ₅₁ Th ₁₄	24.44	<i>hP65</i>	<i>P6/m</i>
Au ₂ Th	37.08	<i>hP3</i>	<i>P6/mmm</i>
Au ₄ Th ₃	46.91	<i>hR42</i>	<i>R3</i>
AuTh	54	<i>oC8</i>	<i>Cmcm</i>
Au ₂ Th ₃	64	(a)	...
AuTh ₂	70.21	<i>tI12</i>	<i>I4/mcm</i>
(βTh)	100	<i>cI2</i>	<i>Im</i> $\bar{3}m$

(αTh)	~ 100	$cF4$	$Fm\bar{3}m$
---------------------	------------	-------	--------------

(a) Cubic?

Au-Ti (Gold - Titanium)

J.L. Murray, 1987

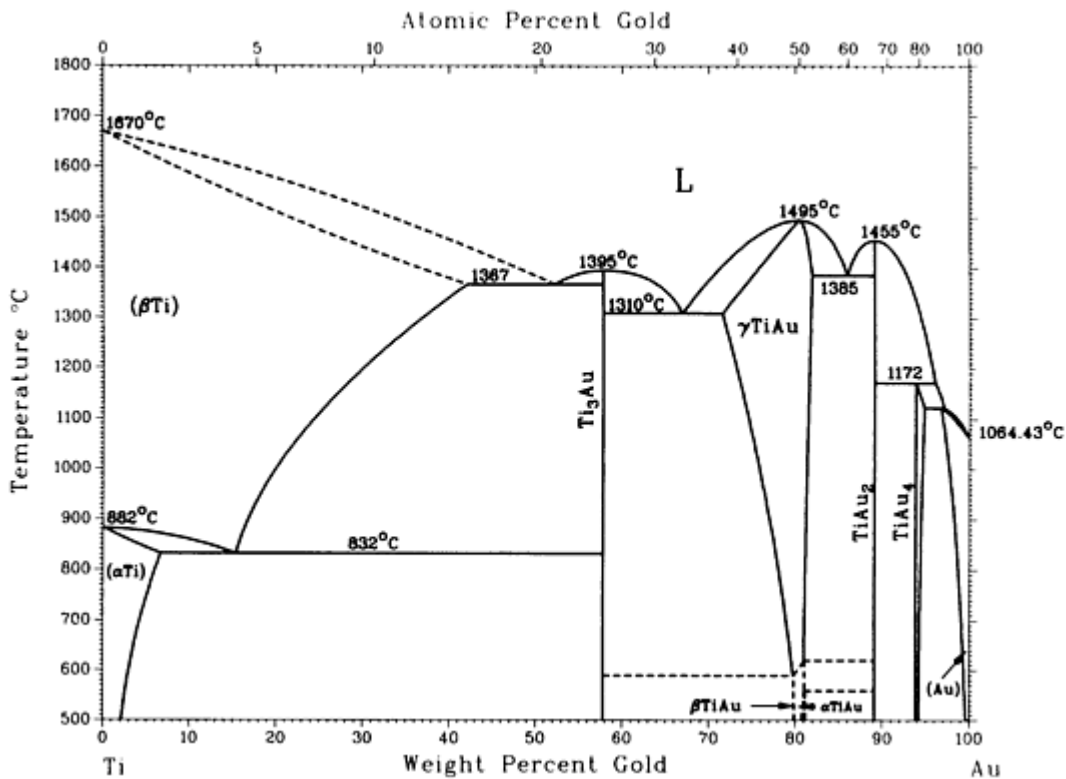

Au-Ti phase diagram

Au-Ti crystallographic data

Phase	Composition, wt% Au	Pearson symbol	Space group
(α Ti)	0 to 6.6	<i>hP2</i>	<i>P6₃/mmc</i>
(β Ti)	0 to 42	<i>cI2</i>	<i>Im$\bar{3}m$</i>
Ti ₃ Au	58	<i>cP8</i>	<i>Pm$\bar{3}n$</i>
γ TiAu	72 to 82	<i>cP2</i>	<i>Pm$\bar{3}m$</i>
β TiAu	80 to 80.4	<i>oP4</i>	<i>Pmma</i>
α TiAu	80.4	<i>tP4</i>	<i>P4/nmm</i>
TiAu ₂	89.2	<i>tI6</i>	<i>I4/mmm</i>
TiAu ₄	94 to 95	<i>tI10</i>	<i>I4/m</i>
(Au)	97 to 100	<i>cF4</i>	<i>Fm$\bar{3}m$</i>

Au-Tl (Gold - Thallium)

H. Okamoto and T.B. Massalski, 1987

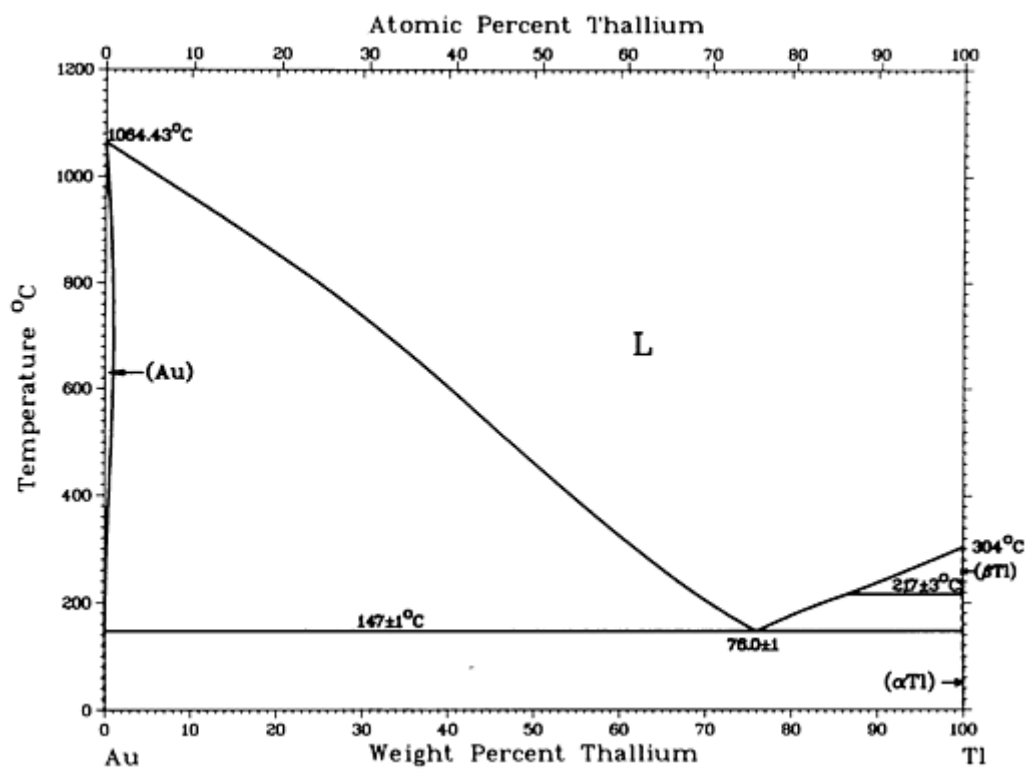

Au-Tl phase diagram

Au-Tl crystallographic data

Phase	Composition, wt% Tl	Pearson symbol	Space group
(Au)	0 to 1.04	<i>cF4</i>	<i>Fm</i> $\bar{3}m$
(α Tl)	100	<i>hP2</i>	<i>P6</i> ₃ <i>/mmc</i>
(β Tl)	100	<i>cI2</i>	<i>Im</i> $\bar{3}m$

Au-U (Gold - Uranium)

H. Okamoto, 1990

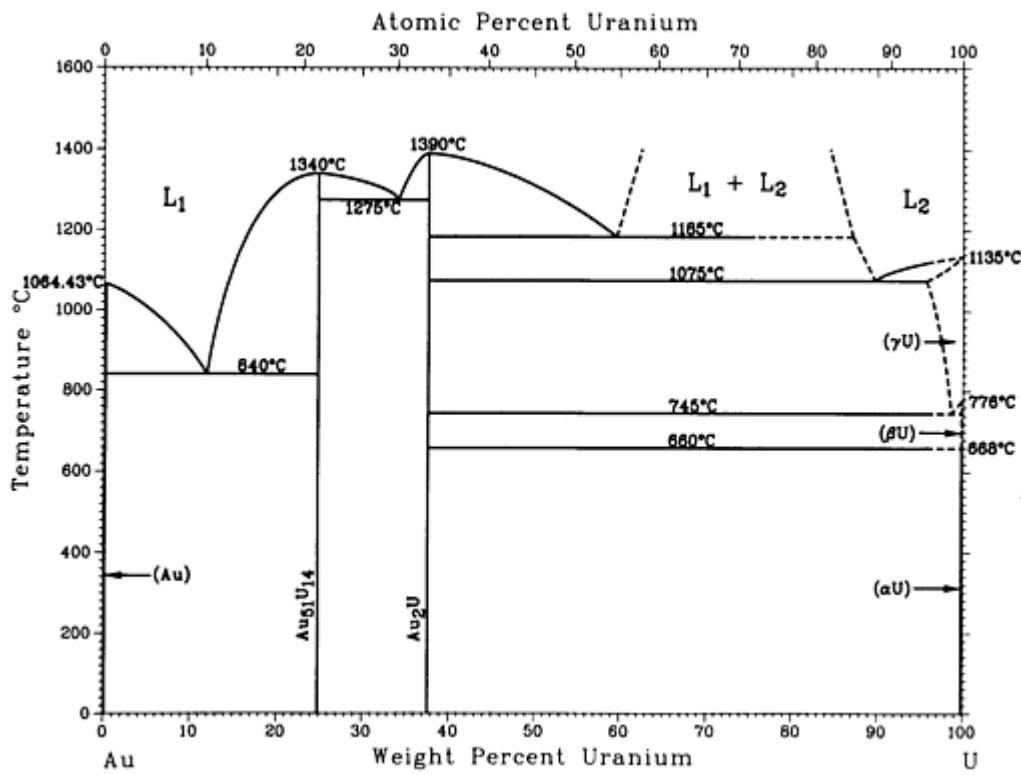

Au-U phase diagram

Au-U crystallographic data

Phase	Composition, wt% U	Pearson symbol	Space group
(Au)	0	<i>cF4</i>	<i>Fm</i> $\bar{3}m$
Au ₅₁ U ₁₄	24.9	<i>hP65</i>	<i>P6/m</i>
Au ₂ U	37.6	<i>hP3</i>	<i>P6/mmm</i>
(γU)	100	<i>cI2</i>	<i>Im</i> $\bar{3}m$
(βU)	100	<i>tP30</i>	<i>P4₂/mnm</i>
(αU)	100	<i>oC4</i>	<i>Cmcm</i>

Au-V (Gold - Vanadium)

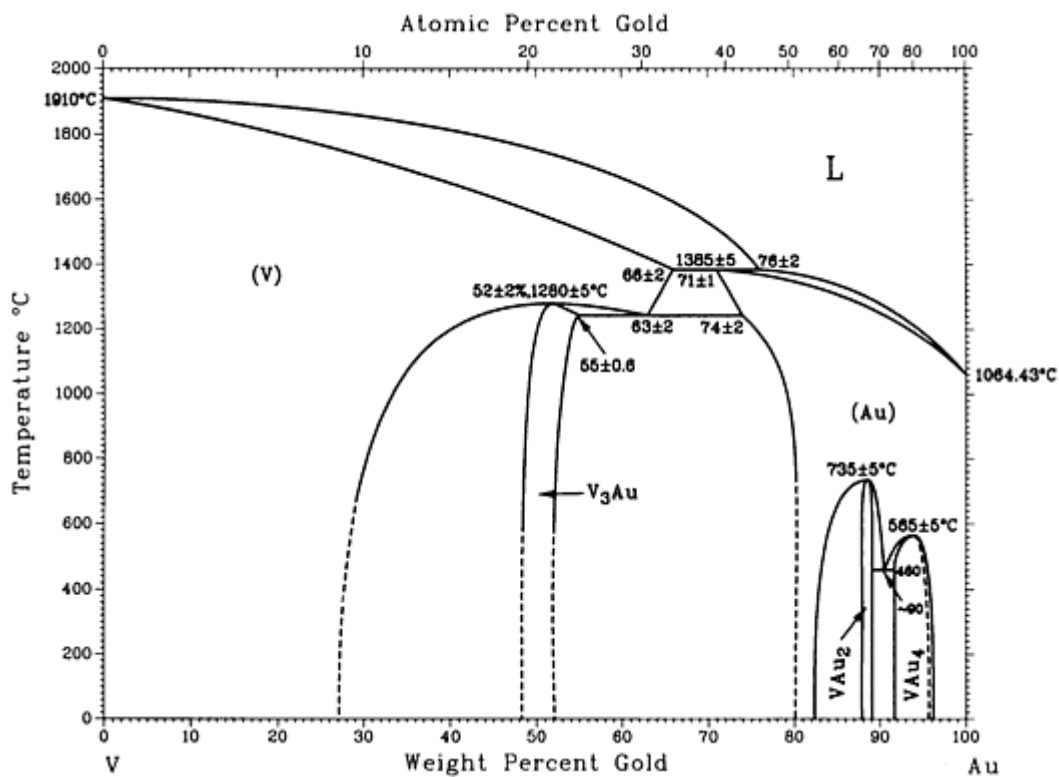

Au-V phase diagram

Au-V crystallographic data

Phase	Composition, wt% Au	Pearson symbol	Space group
(V)	0 to ~66	<i>cI2</i>	<i>Im</i> $\bar{3}m$
V ₃ Au ^(a)	48 to 55	<i>cP8</i>	<i>Pm</i> $\bar{3}n$
VAu ₂	88 to 89	<i>oC12</i>	^(b)
VAu ₄	92 to 96	<i>tI10</i>	<i>I4/m</i>
(Au)	~71 to 100	<i>cF4</i>	<i>Fm</i> $\bar{3}m$

(a) In the presence of small amounts of O or N, a second phase with the Cu₃Au-type structure may co-exist with the Cr₃Si-type structure.

(b) Crystal structure related to the MoSi₂-type structure, but with a unit cell of twice the size.

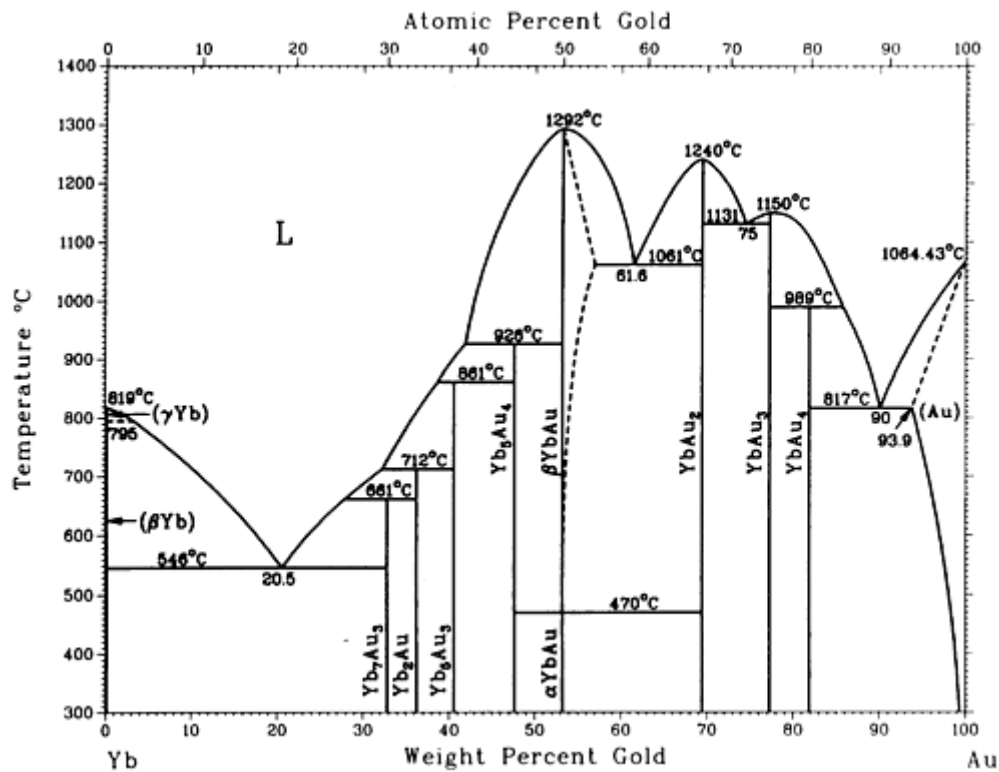

Au-Yb phase diagram

Au-Yb crystallographic data

Phase	Composition, wt% Au	Pearson symbol	Space group
(βYb)	0	cF4	$Fm\bar{3}m$
(γYb)	0	cI2	$Im\bar{3}m$
Yb ₇ Au ₃	33	hP20	$P6_3/mc$
Yb ₂ Au	36.2	oP12	$Pnma$
Yb ₅ Au ₃	40.6	tI32	$I4/mcm$
Tb ₅ Au ₄	47.6	oP36	$Pnma$
αYbAu	53	oP8	$Pnma$
βYbAu	53	cP2	$Pm\bar{3}m$

YbAu ₂	69.5	<i>tI6</i>	<i>I4/mmm</i>
YbAu ₃	77	<i>oP8</i>	<i>Pmmm</i>
YbAu ₄	82	<i>tI10</i>	<i>I4/m</i>
(Au)	93.9 to 100	<i>cF4</i>	<i>Fm$\bar{3}m$</i>

Au-Zn (Gold - Zinc)

H. Okamoto and T.B. Massalski, 1990

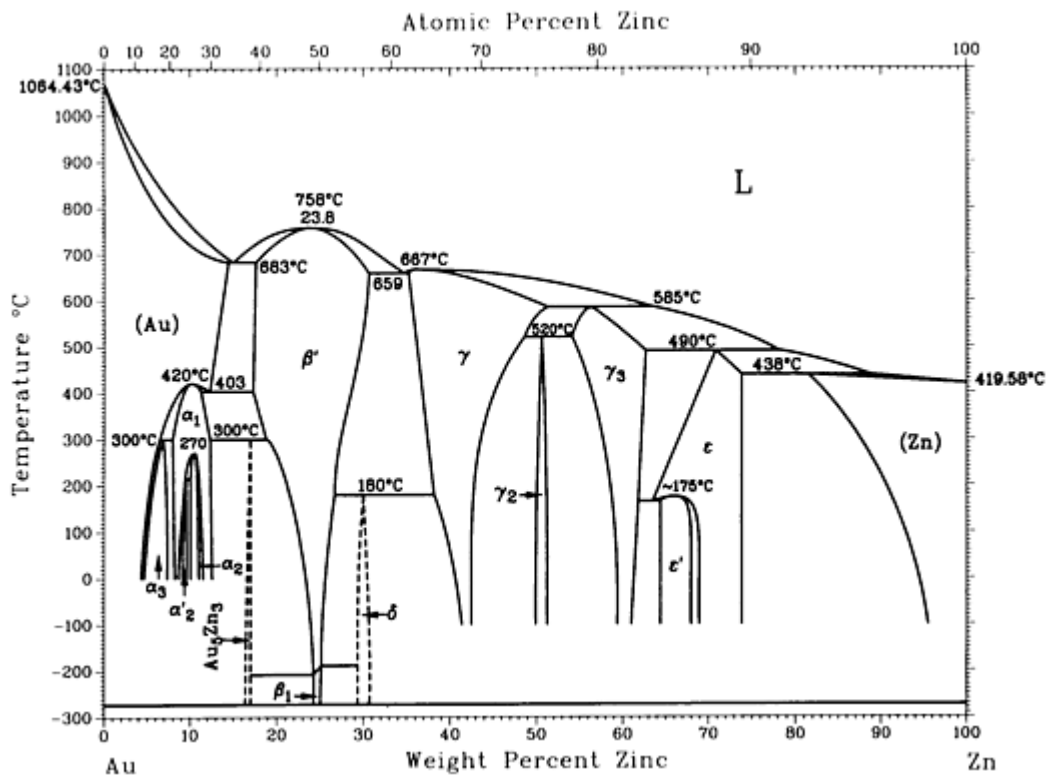

Au-Zn phase diagram

Au-Zn crystallographic data

Phase	Composition, wt% Zn	Pearson symbol	Space group
(Au)	0 to 14	<i>cF4</i>	<i>Fm$\bar{3}m$</i>
α_3	~4 to 7.4	(a)	<i>Pn$\bar{2}n$</i> or <i>Pnmm</i>

α_1	~7.9 to 11.7	^(b)	...
α'_2	9.0 to 9.5	^(b)	$I4_1/acd$
α_2	~9.7 to 10.2	^(a)	$Abam (Cmca)$
Au_5Zn_3	16.6	^(a)	...
β	17 to 31	$cP2$	$Pm\bar{3}m$
β_1	24 to 26	?	...
δ	30	?	...
γ	38 to 51	$cI52$...
γ_2	50 to 51	$cP32$	$Pm\bar{3}m$
γ_3	54 to 62.7	hP^*	$P6/mmm$
ϵ	64 to 73	$hP2$	$P6_3/mmc$
ϵ'	64 to 67	^(c)	...
(Zn)	80.4 to 100	$hP2$	$P6_3/mmc$

(a) Orthorhombic, antiphase domain.

(b) Tetragonal, antiphase domain.

(c) Orthorhombic, pseudocell

Au-Zr (Gold - Zirconium)

T.B. Massalski, H. Okamoto, and J.P. Abriata, 1987

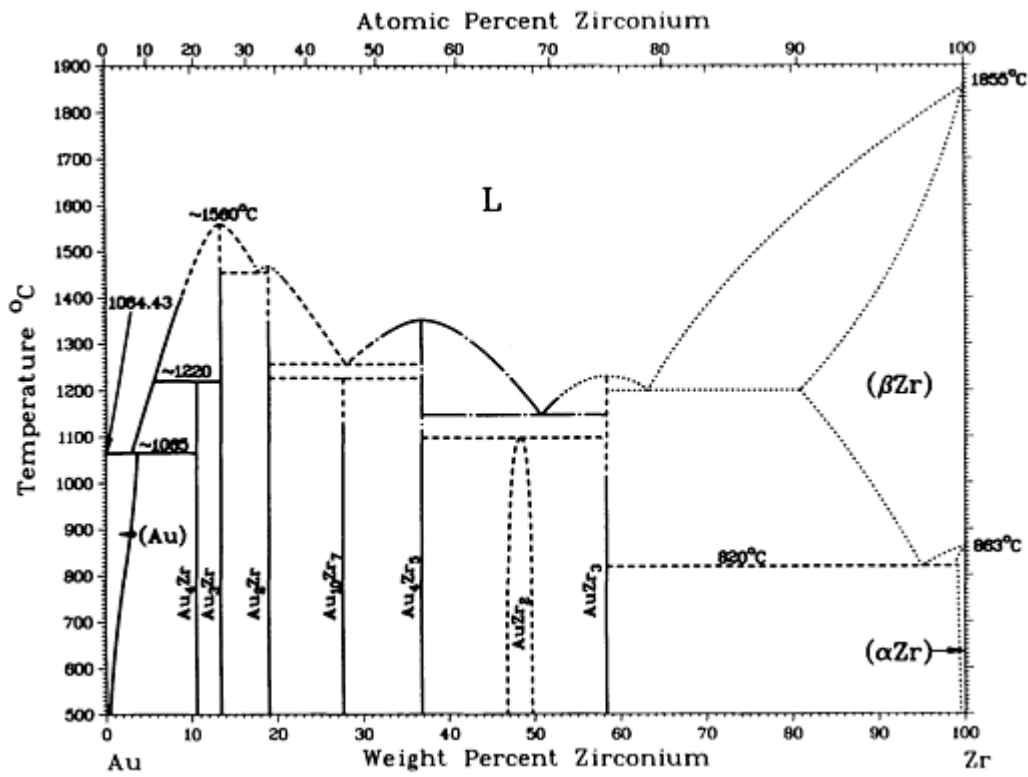

Au-Zr phase diagram

Au-Zr crystallographic data

Phase	Composition, wt% Zr	Pearson symbol	Space group
(Au)	0	<i>cF4</i>	<i>Fm</i> $\bar{3}m$
Au ₄ Zr	10	<i>oP20</i>	<i>Pnma</i>
Au ₃ Zr	13	<i>oP8</i>	<i>Pmmn</i>
Au ₂ Zr	18.8	<i>tI6</i>	<i>I4/mmm</i>
Au ₁₀ Zr ₇	27	<i>tI34</i>	?
Au ₄ Zr ₅	36.7
AuZr ₂	48.1	<i>tI6</i>	<i>I4/mmm</i>
AuZr ₃	58	<i>cP8</i>	<i>Pm</i> $\bar{3}n$

(β_{Zr})	100	$cI2$	$Im\bar{3}m$
(α_{Zr})	100	$hP2$	$P6_3/mmc$

B-C (Boron - Carbon)

H. Okamoto, 1992

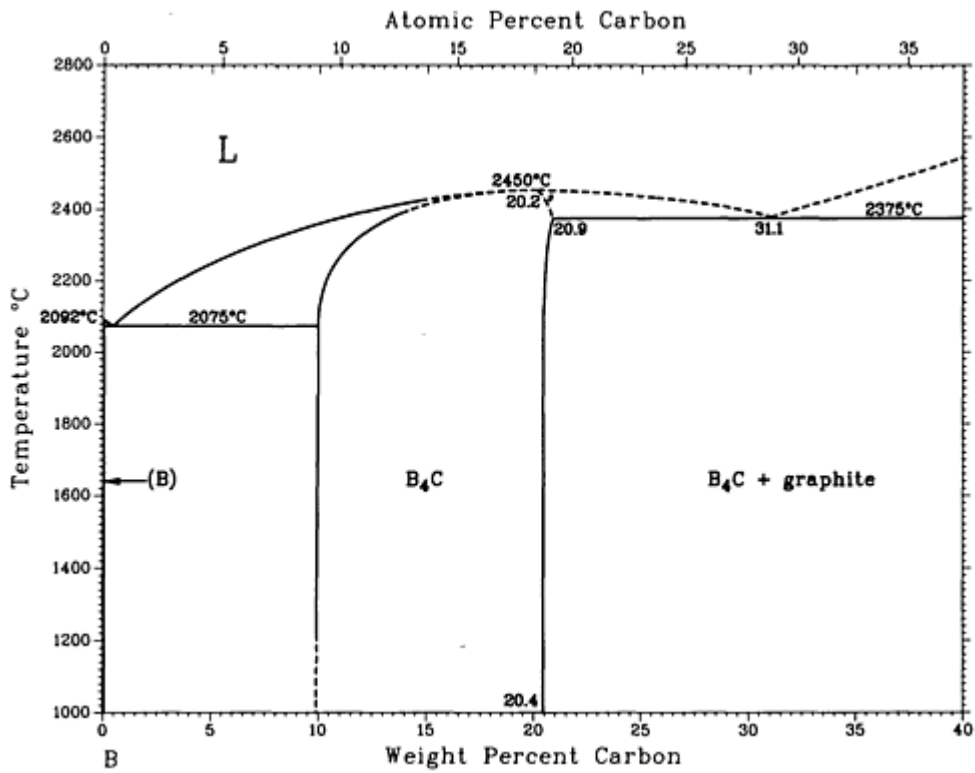

B-C phase diagram

B-C crystallographic data

Phase	Composition, wt% C	Pearson symbol	Space group
(β_B)	0	$hR108$	$R\bar{3}m$
"B ₄ C"	10 to 20.9	$hR15$	$R\bar{3}m$
(C)	100	$hP4$	$P6_3/mmc$

B-Co (Boron - Cobalt)

P.K. Liao and K.E. Spear, 1988

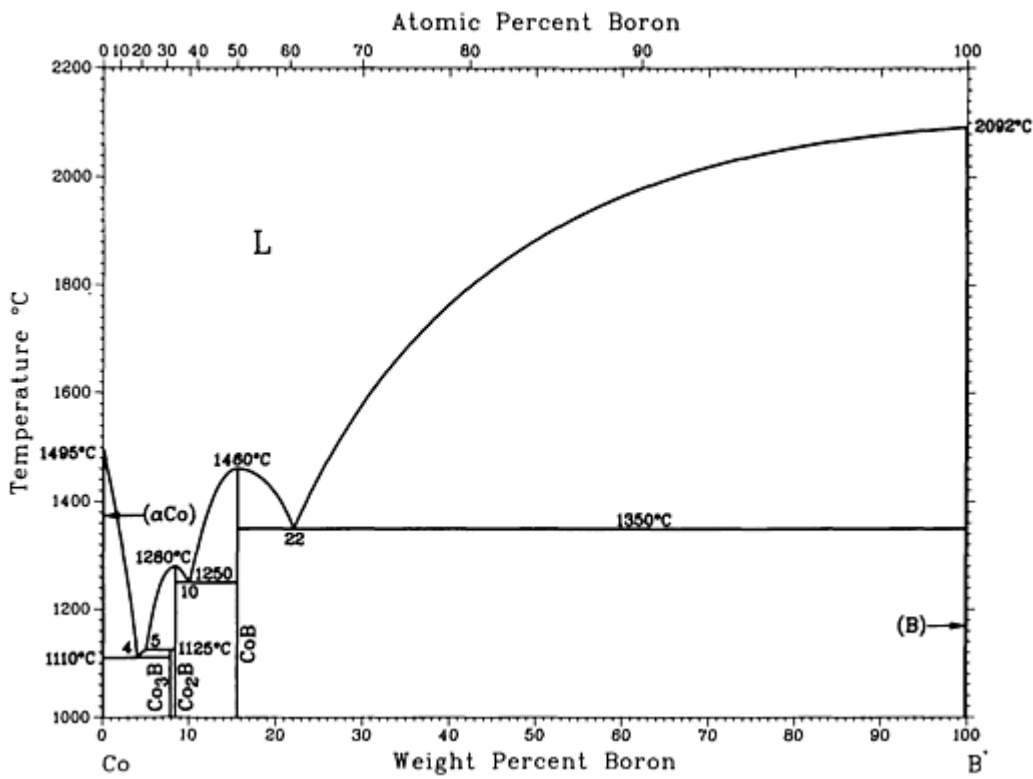

B-Co phase diagram

B-Co crystallographic data

Phase	Composition, wt% B	Pearson symbol	Space group
(αCo)	~0	<i>cF4</i>	<i>Fm$\bar{3}m$</i>
(βCo)	~0	<i>hP2</i>	<i>P6₃/mmc</i>
Co ₃ B	7.8	...	<i>Pbnm</i>
Co ₂ B	8.4	<i>tI12</i>	<i>I4/mcm</i>
CoB	15.5	<i>oP8</i>	<i>Pnma</i>
(βB)	100	<i>hR108</i>	<i>R$\bar{3}m$</i>

B-Cr (Boron - Chromium)

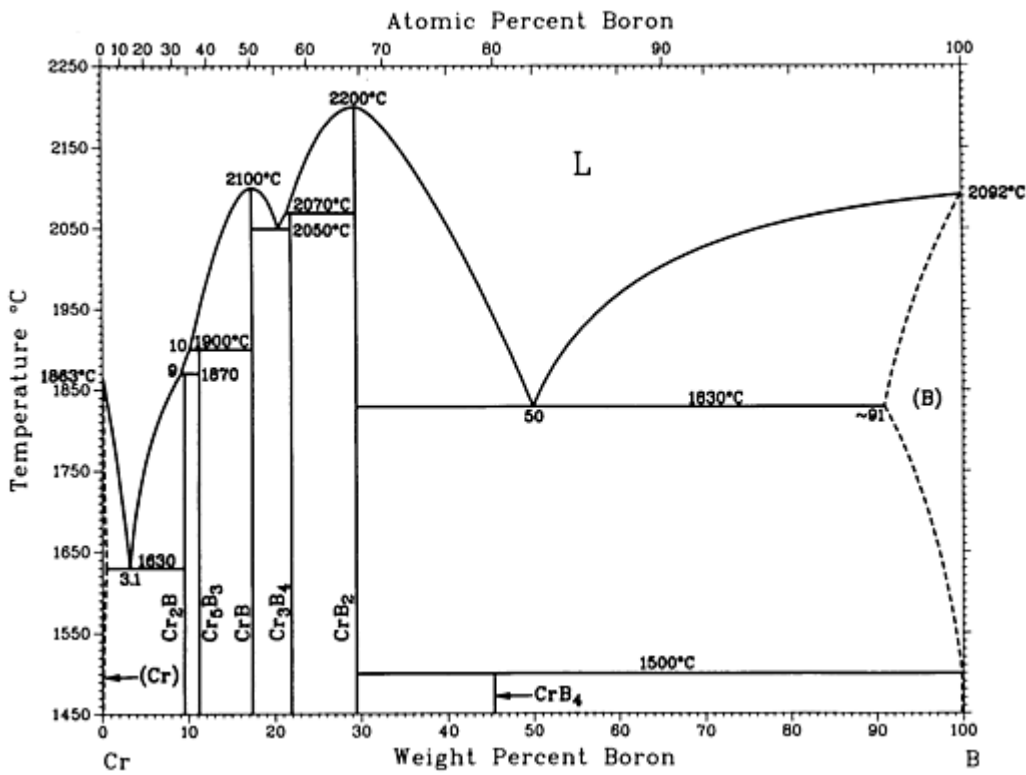

B-Cr phase diagram

B-Cr crystallographic data

Phase	Composition, wt% B	Pearson symbol	Space group
(α Cr)	0 to \sim 0.2	<i>cI2</i>	<i>Im$\bar{3}m$</i>
Cr ₄ B ^(a)	5	<i>oF40</i>	<i>Fddd</i>
Cr ₂ B	9.4	<i>oF40</i>	<i>Fddd</i>
Cr ₂ B ^(a)	9.4	^(b)	<i>Abmm</i>
Cr ₂ B ^(a)	9.4	<i>iI12</i>	<i>I4/mcm</i>
Cr ₅ B ₃	11.1	<i>iI32</i>	<i>I4/mcm</i>
CrB	17.2	<i>oC8</i>	<i>Cmcm</i>
Cr ₃ B ₄	21.7	<i>oI14</i>	<i>Immm</i>
CrB ₂	29.4	<i>hP3</i>	<i>P6/mmm</i>

CrB ₄	45	(b)	...
CrB ₆ ^(a)	55.5	(c)	...
(β _B)	~91 to 100	<i>hR108</i>	<i>R$\bar{3}m$</i>

(a) Unstable or stability is uncertain.

(b) Orthorhombic.

(c) Tetragonal

B-Cu (Boron - Copper)

D.J. Chakrabarti and D.E. Laughlin, 1982

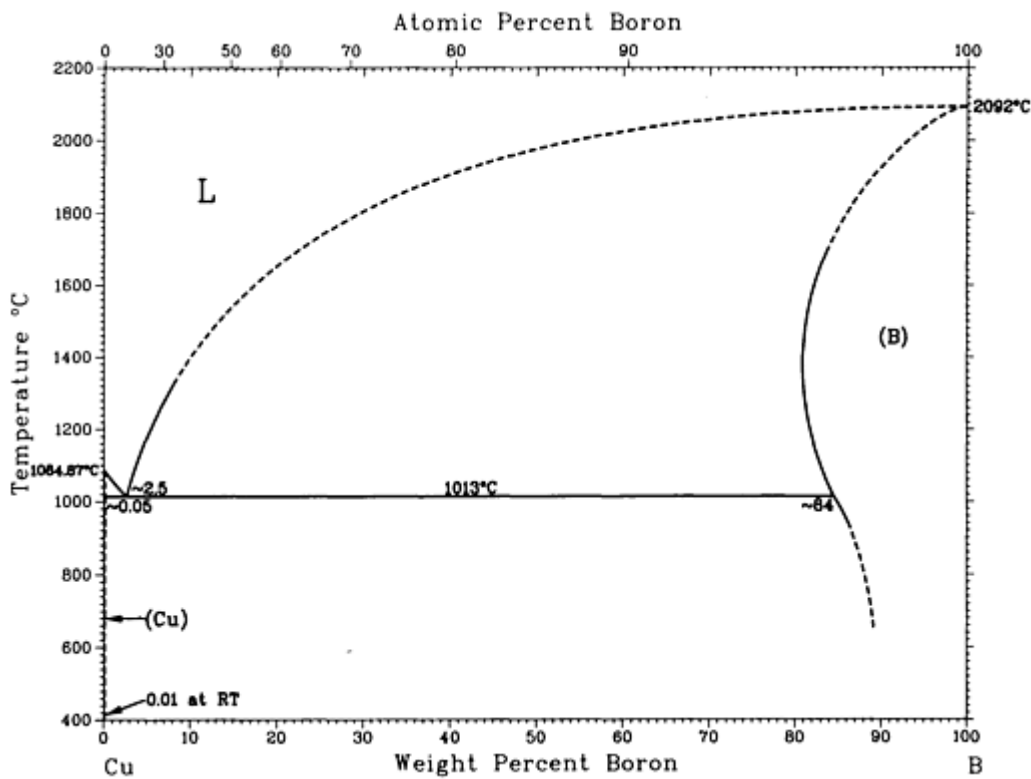

B-Cu phase diagram

B-Cu crystallographic data

Phase	Composition, wt% B	Pearson symbol	Space group

(Cu)	0 to ~ 0.05	$cF4$	$Fm\bar{3}m$
(B)	>80	$tP192$	$P4_12_12$ or $P4_32_12(?)$
(B)	>80	$hR105$	$R\bar{3}m$
(β_B)	100	$hR108$	$R\bar{3}m$
(α_B)	100	$hR12$ $tP192$	$R\bar{3}m$ $P4_12_12$ or $P4_32_12(?)$

B-Fe (Boron - Iron)

P.K. Liao and K.E. Spear, unpublished

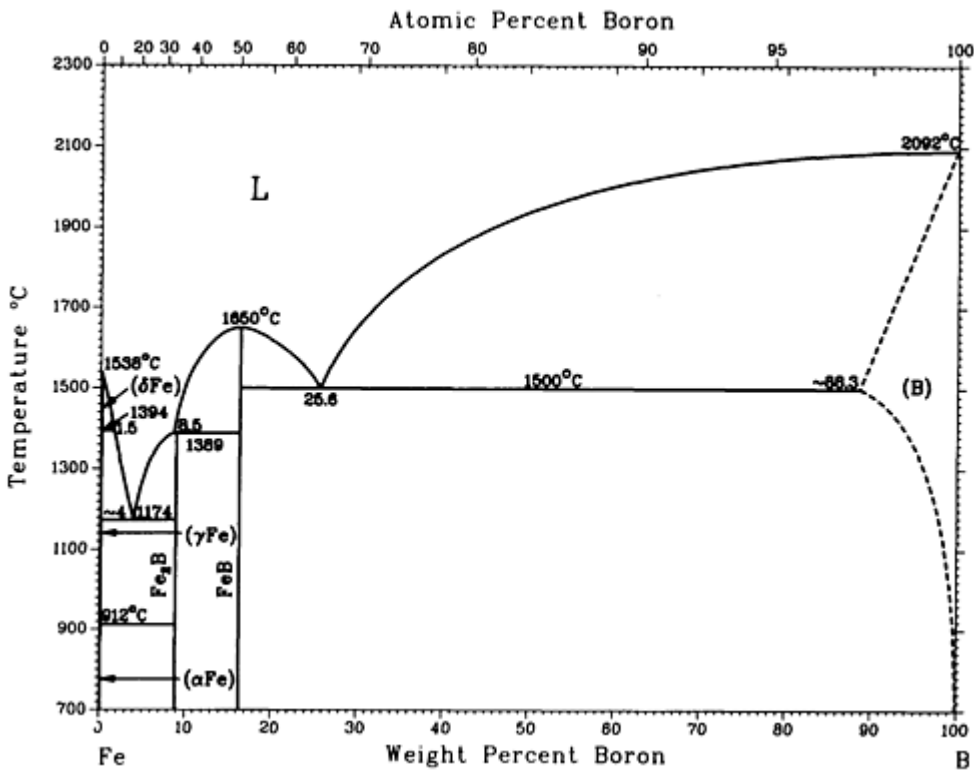

B-Fe phase diagram

B-Fe crystallographic data

Phase	Composition, wt% Fe	Pearson symbol	Space group
-------	---------------------	----------------	-------------

(α Fe)	0	<i>cI2</i>	<i>Im$\bar{3}m$</i>
Fe ₂ B	8.8	<i>tI12</i>	<i>I4/mcm</i>
FeB	16.0 to 16.2	<i>oP8</i>	<i>Pbmn</i>
(β _B)	100	<i>hR108</i>	<i>R$\bar{3}m$</i>
Metastable phases			
Fe ₃ B	~ 6	<i>oP16</i>	<i>Pnma</i>
Fe ₃ B(HT)	~ 6	(a)	...
Fe₃B(LT)	~ 6	(b)	...

(a) bct.

(b) Tetragonal

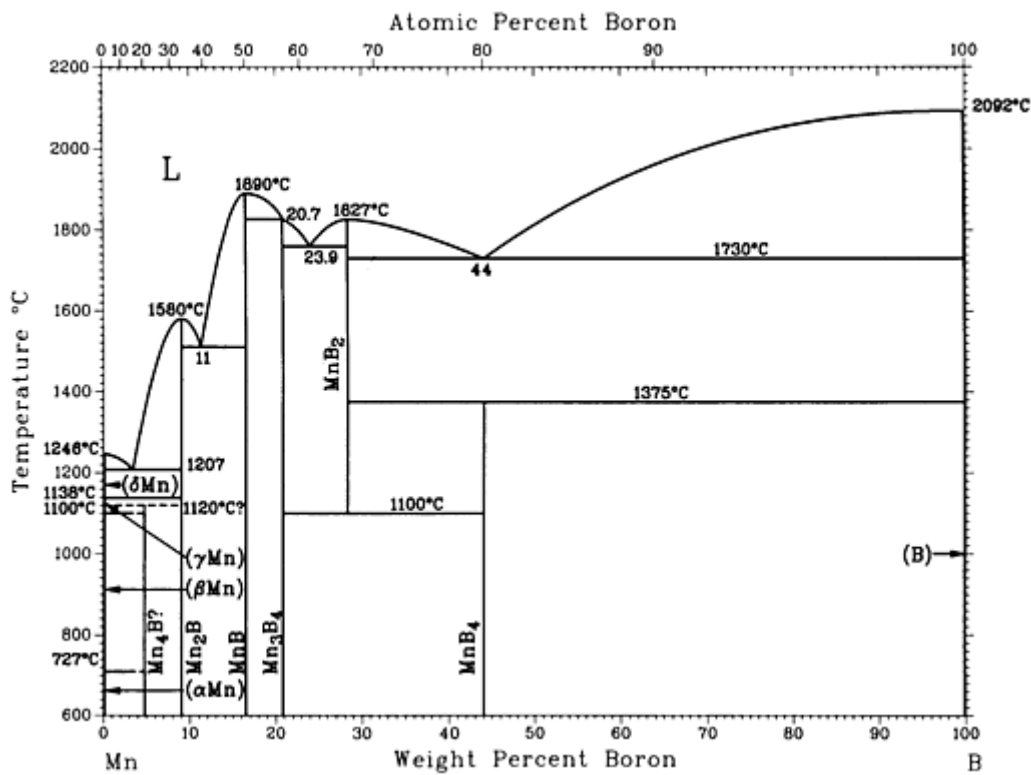

B-Mn phase diagram

B-Mn crystallographic data

Phase	Composition, wt% B	Pearson symbol	Space group
(δMn)	0	<i>cI2</i>	<i>Im$\bar{3}m$</i>
Mn ₄ B ^(a)	5	<i>oF40</i>	<i>Fddd</i>
Mn ₂ B ^(a)	9.0 9.0	^(b) <i>tI12</i>	<i>Fddd</i> <i>I4/mcm</i>
MnB	16	<i>oP</i>	<i>Pnma</i>
Mn ₃ B ₄	20.8	<i>oI14</i>	<i>Immm</i>
MnB ₂	28.3	<i>hP3</i>	<i>P6/mmm</i>
MnB ₄	44	^(c)	<i>C2/m</i>
MnB _{~23} ^(d)	...	<i>hR108</i>	<i>R$\bar{3}m$</i>

(βB)	100	$hR108$	$R\bar{3}m$
-------------------	-----	---------	-------------

- (a) Probably not thermodynamically stable. Also, orthorhombic Mn_4B and Mn_2B may refer to the same phase.
- (b) Orthorhombic.
- (c) Monoclinic.
- (d) Probably the Mn-rich boundary or rhombohedral B

B-Mo (Boron - Molybdenum)

K.E. Spear and P.K. Liao, 1988

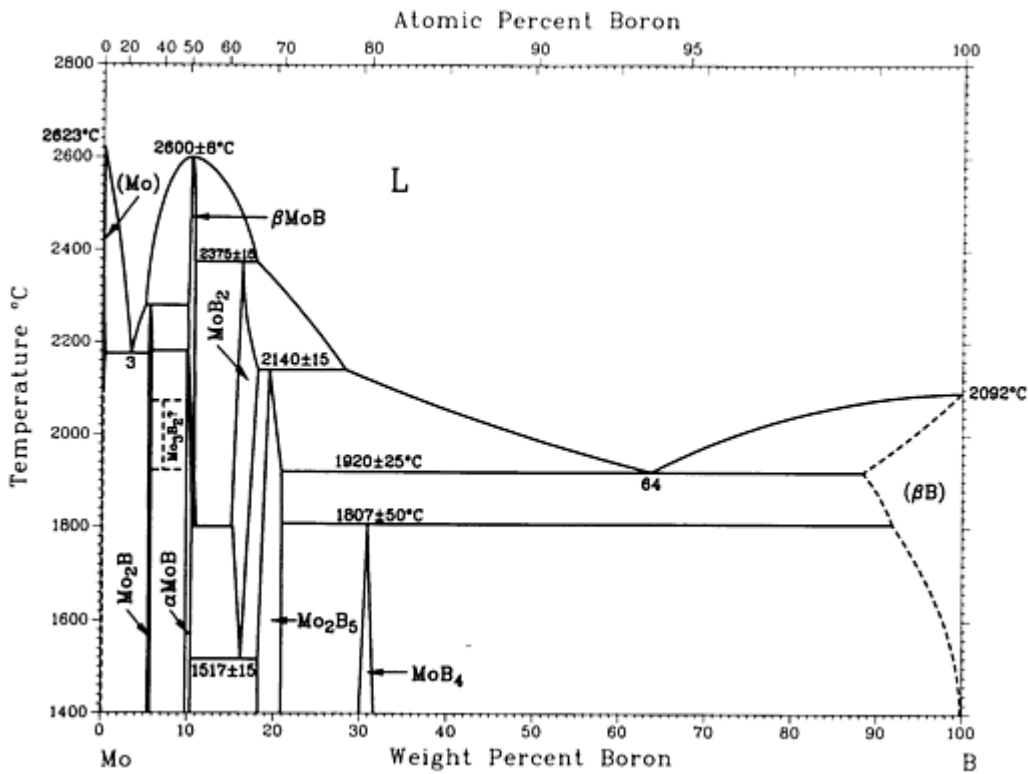

B-Mo phase diagram

B-Mo crystallographic data

Phase	Composition, wt% B	Pearson symbol	Space group
(Mo)	0 to <0.1	$cI2$	$Im\bar{3}m$

Mo ₂ B	~5	<i>tI12</i>	<i>I4/mcm</i>
αMoB	9 to 10	<i>tI16</i>	<i>I4₁/amd</i>
βMoB	9 to 10.4	<i>oC8</i>	<i>Cmcm</i>
MoB ₂	16 to 18	<i>hP3</i>	<i>P6/mmm</i>
Mo ₂ B ₃	18.6 to 20	<i>hR21</i>	<i>R$\bar{3}m$</i>
MoB ₄	~30	<i>hP20</i>	<i>P6₃/mmc</i>
(β _B)	>92 to 100	<i>hR108</i>	<i>R$\bar{3}m$</i>

B-Nb (Boron - Niobium)

H. Okamoto, 1990

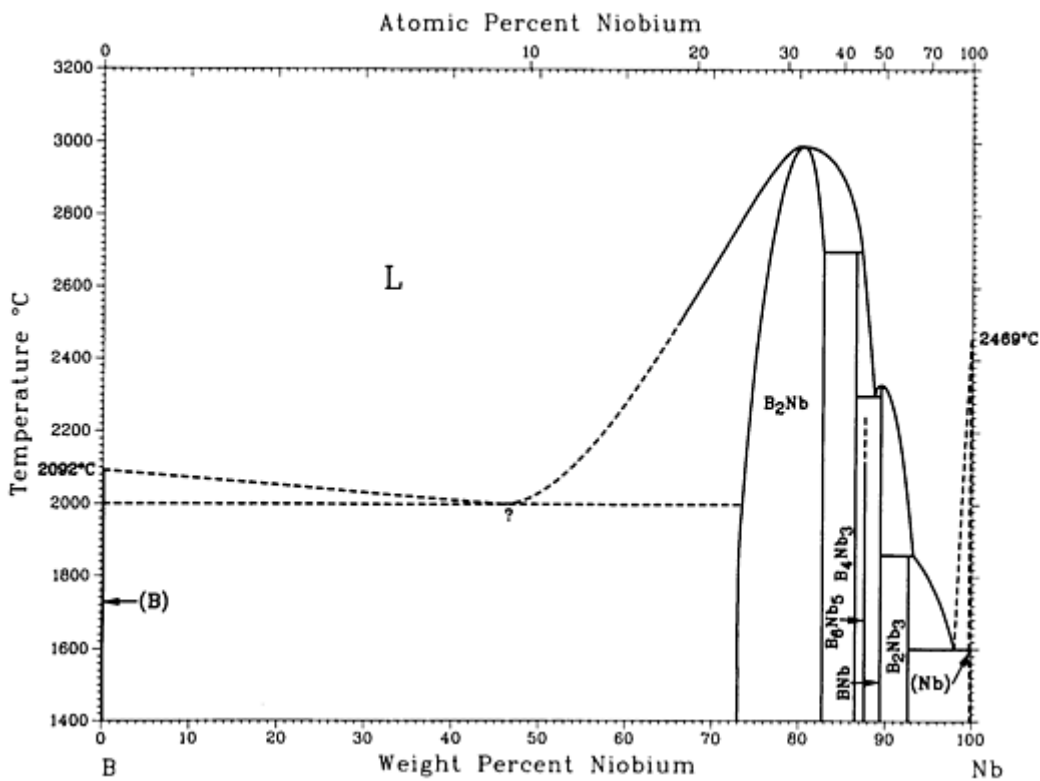

B-Nb phase diagram

B-Nb crystallographic data

Phase	Composition, wt% Nb	Pearson symbol	Space group
(β_B)	0	<i>hR108</i>	$R\bar{3}m$
B_2Nb	73 to 83	<i>hP3</i>	$P6/mmm$
B_4Nb_3	86.6	<i>oI14</i>	$Immm$
B_6Nb_5	87.8	<i>oC*</i>	$Cmmm$
BNb	90	<i>oC8</i>	$Cmcm$
B_2Nb_3	93	<i>tP10</i>	$P4/mbm$
(Nb)	100	<i>cI2</i>	$Im\bar{3}m$

B-Ni (Boron - Nickel)

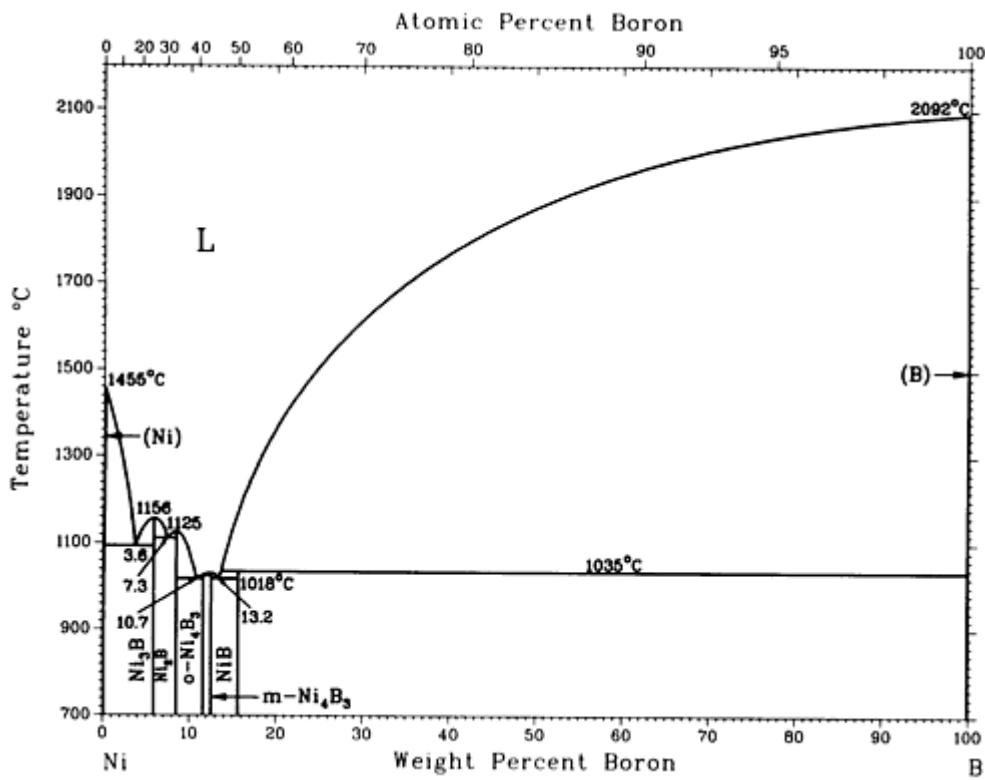

B-Ni phase diagram

B-Ni crystallographic data

Phase	Composition, wt% B	Pearson symbol	Space group
(Ni)	0	<i>cF4</i>	<i>Fm</i> $\bar{3}m$
Ni ₃ B	6	<i>oP6</i>	<i>Pnma</i>
Ni ₂ B	8.4	<i>tI12</i>	<i>I4/mcm</i>
o-Ni ₄ B ₃	11.5	(a)	<i>Pnma</i>
m-Ni ₄ B ₃	12.5	(b)	<i>C2/c</i>
NiB	16	<i>oC8</i>	<i>Cmcm</i>
NiB ₂ ^(c)	26.9	(d)	...
NiB ₁₂ ^(c)	68.8	(d)	...

(βB)	100	$hR108$	$R\bar{3}m$
-------------------	-----	---------	-------------

- (a) Orthorhombic.
- (b) Monoclinic.
- (c) Existence of these compounds has been reported, but is highly unlikely.
- (d) Cubic

B-Pd (Boron - Palladium)

P.K. Liao and K.E. Spear, unpublished

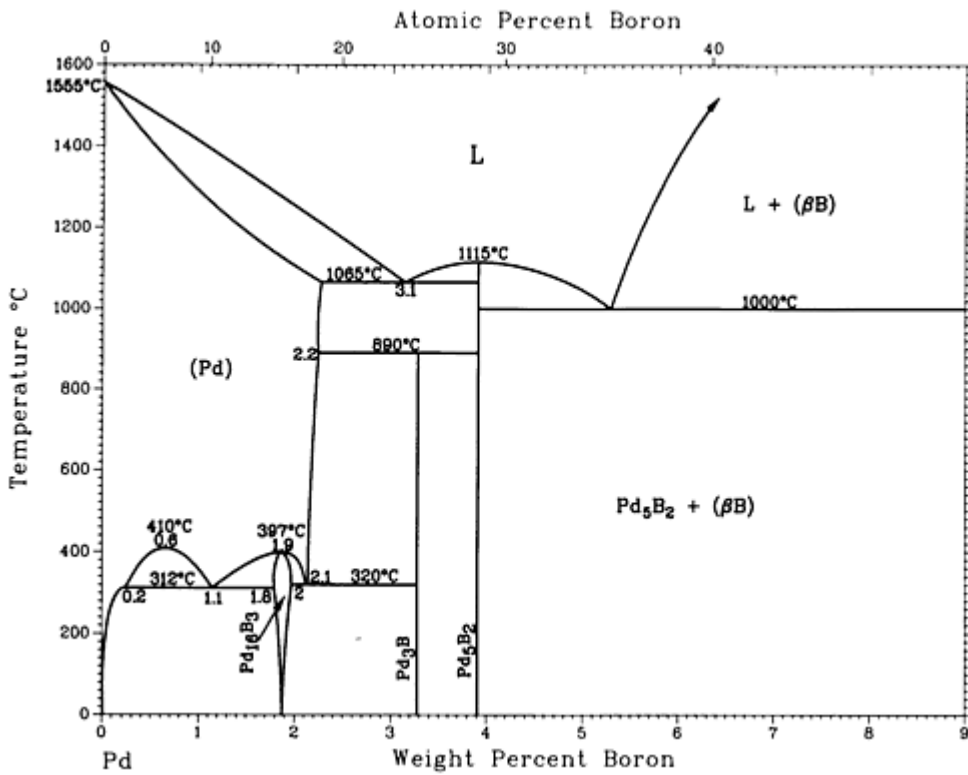

B-Pd phase diagram

B-Pd crystallographic data

Phase	Composition, wt% B	Pearson symbol	Space group
(Pd)	0.00 to 2.2	$cF4$	$Fm\bar{3}m$

Pd ₁₆ B ₃	1.9
Pd ₃ B	3.4	<i>oP16</i>	<i>Pnma</i>
Pd ₅ B ₂	3.9	<i>mC28</i>	<i>C2/c</i>
(β _B)	100	<i>hR105</i>	<i>R$\bar{3}m$</i>

B-Pt (Boron - Platinum)

H. Okamoto, 1990

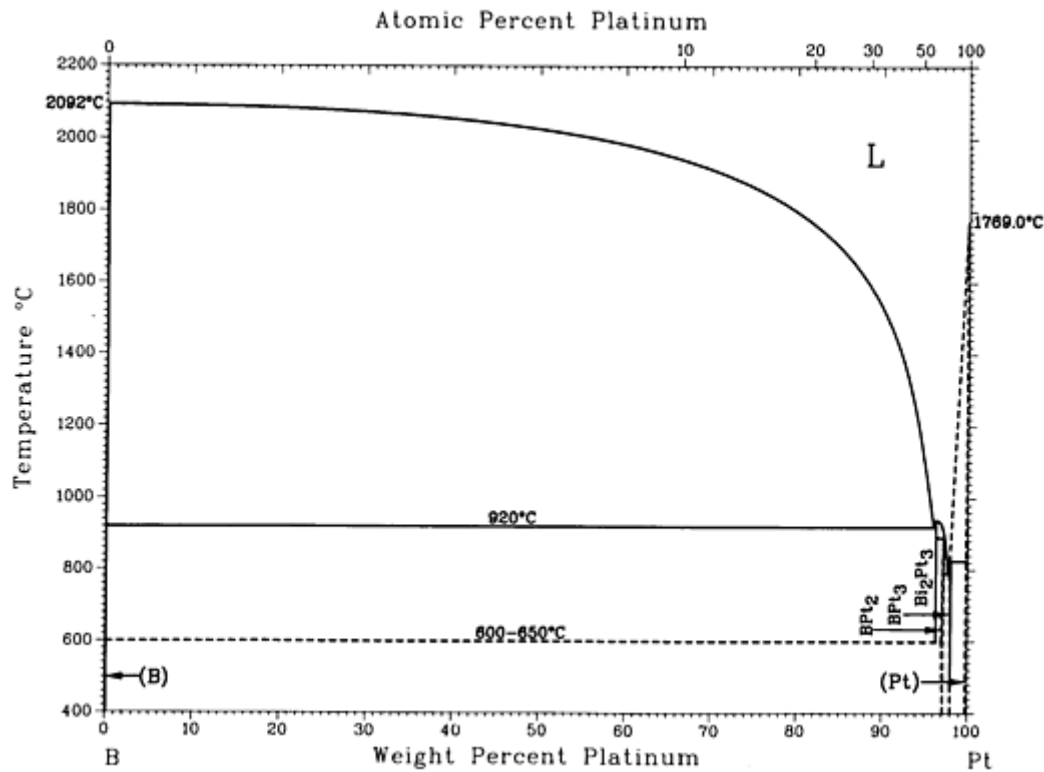

B-Pt phase diagram

B-Pt crystallographic data

Phase	Composition, wt% Pt	Pearson symbol	Space group
(β _B)	0	<i>hR108</i>	<i>R$\bar{3}m$</i>
B ₂ Pt ₃	96

BPt ₂	97.3	<i>hP6</i>	<i>P6₃/mmc</i>
BPt ₃	98	<i>t**</i>	...
(Pt)	100	<i>cF4</i>	<i>Fm$\bar{3}m$</i>

B-Re (Boron - Rhenium)

K.I. Portnoi and V.M. Romashov, 1972

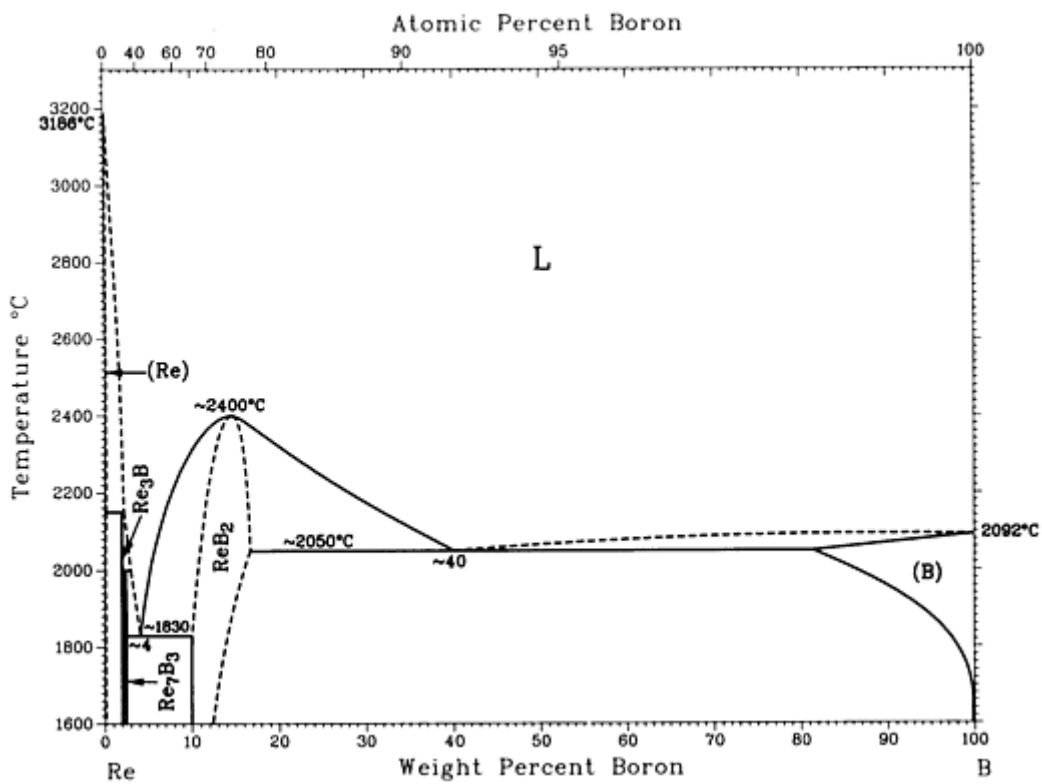

B-Re phase diagram

B-Re crystallographic data

Phase	Composition, wt% B	Pearson symbol	Space group
(Re)	0 to ~0.06	<i>hP2</i>	<i>P6₃/mmc</i>
Re ₃ B	~2	<i>oC16</i>	<i>Cmcm</i>
Re ₇ B ₃	~2.4	<i>hP20</i>	<i>P6₃/mc</i>

ReB ₂	~10 to ~17	<i>hP6</i>	<i>P6₃/mmc</i>
(B)	~85 to 100	<i>hR105</i>	<i>R$\bar{3}m$</i>

B-Ru (Boron - Ruthenium)

W. Obrowski, 1963

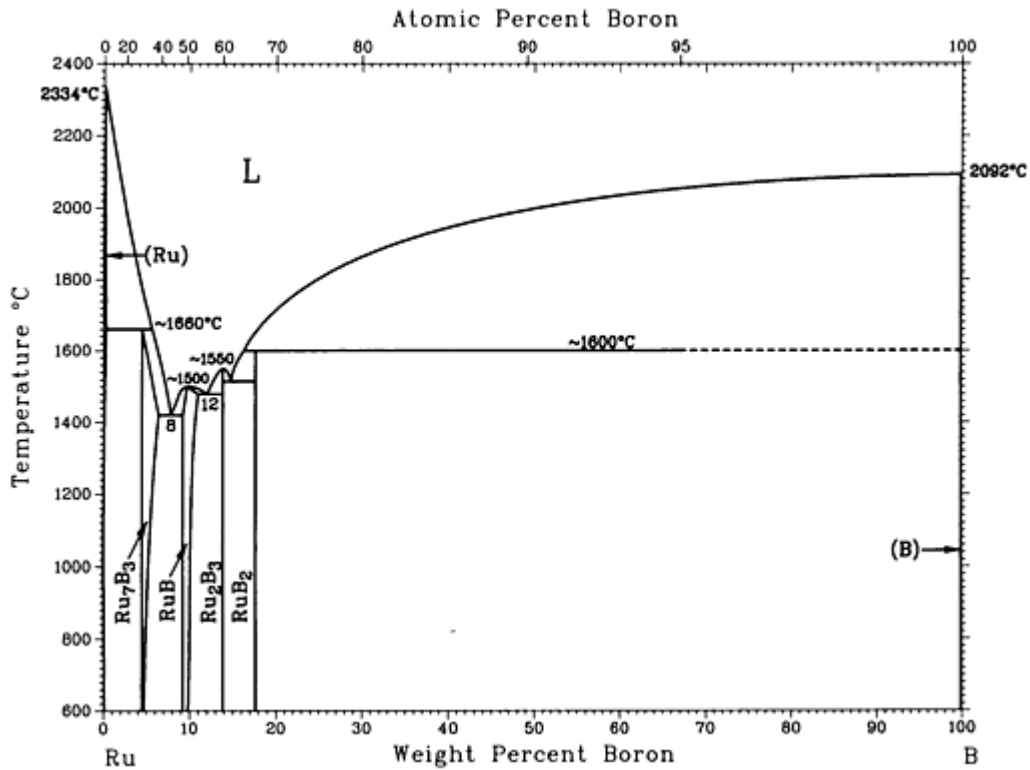

B-Ru phase diagram

B-Ru crystallographic data

Phase	Composition, wt% B	Pearson symbol	Space group
(Ru)	0 to ~0.2	<i>hP2</i>	<i>P6₃/mmc</i>
Ru ₇ B ₃	~4 to 6	<i>hP20</i>	<i>P6₃/mc</i>
RuB	~9 to 11	<i>hP2</i>	<i>P$\bar{6}m2$</i>
Ru ₂ B ₃	14	<i>hP12</i>	<i>P6₃/mmc</i>

RuB ₂	17.6	<i>oP6</i>	<i>Pmmn</i>
(B)	~100	<i>hR105</i>	<i>R$\bar{3}m$</i>

B-Sc (Boron - Scandium)

K.E. Spear and P.K. Liao, 1990

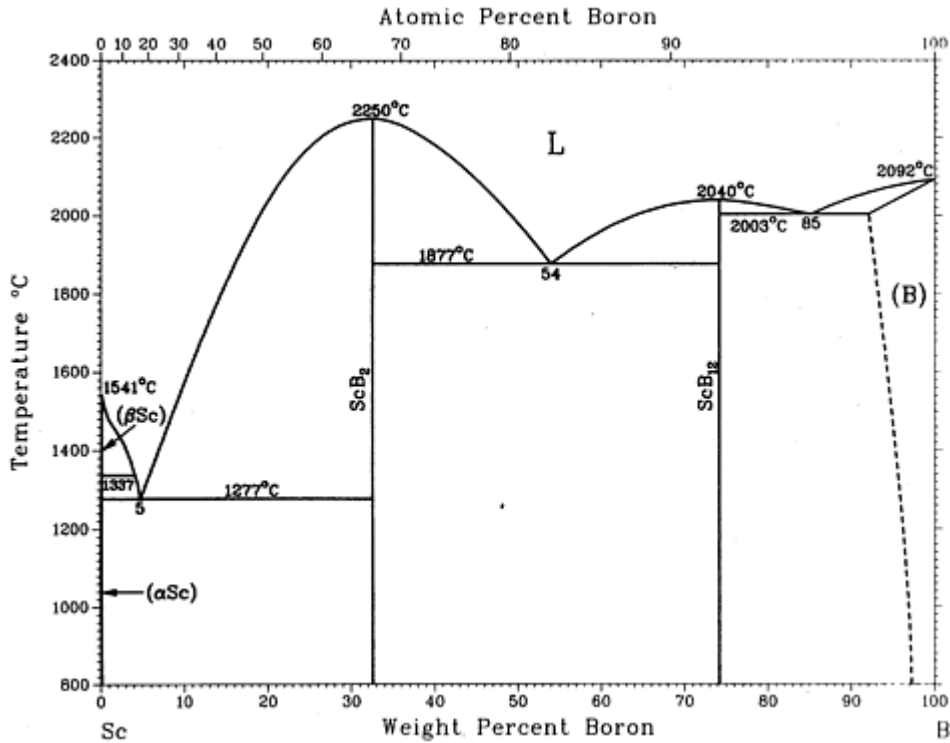

B-Sc phase diagram.

B-Sc crystallographic data

Phase	Composition, wt% B	Pearson symbol	Space group
(αSc)	0	<i>hP2</i>	<i>P6₃/mmc</i>
(βSc)	0	<i>cI2</i>	<i>Im$\bar{3}m$</i>
ScB ₂	33	<i>hP3</i>	<i>P6/mmm</i>
ScB ₁₂	73	<i>tI26</i>	<i>I4/mmm</i>

ScB ₂₀	(a)
(β _B)	100	<i>hR108</i>	<i>R$\bar{3}m$</i>

(a) Metastable, rhombohedral (β_B)

B-Si (Boron - Silicon)

R.W. Olesinski and G.J. Abbaschian, 1984

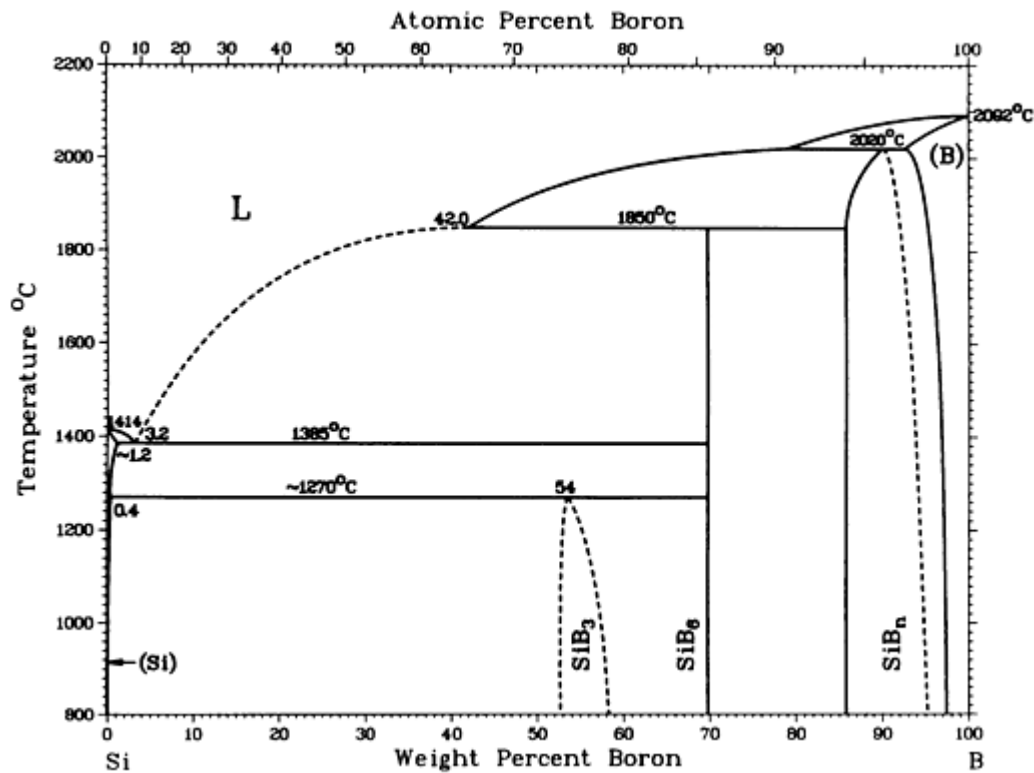

B-Si phase diagram

B-Si crystallographic data

Phase	Composition, wt% B	Pearson symbol	Space group
(αSi)	0 to ~1.2	<i>cF8</i>	<i>Fd$\bar{3}m$</i>
(β _{Si}) (HP)	0	<i>tI4</i>	<i>I4₁/amd</i>
SiB ₃	52.7 to 58.4	<i>hR15</i>	<i>R$\bar{3}m$</i>

SiB ₆	69.8	<i>oP280</i>	<i>Pnmm</i>
SiB _n	84.3 to ~93	<i>hR12</i>	<i>R$\bar{3}m$</i>
(B)	~93 to ~100	<i>hR12</i>	<i>R$\bar{3}m$</i>
(β B) ^(a)	100	<i>hR105</i>	<i>R$\bar{3}m$</i>

(a) Assumed to be the only stable phase of pure B

B-Ta (Boron - Tantalum)

H. Okamoto, 1990

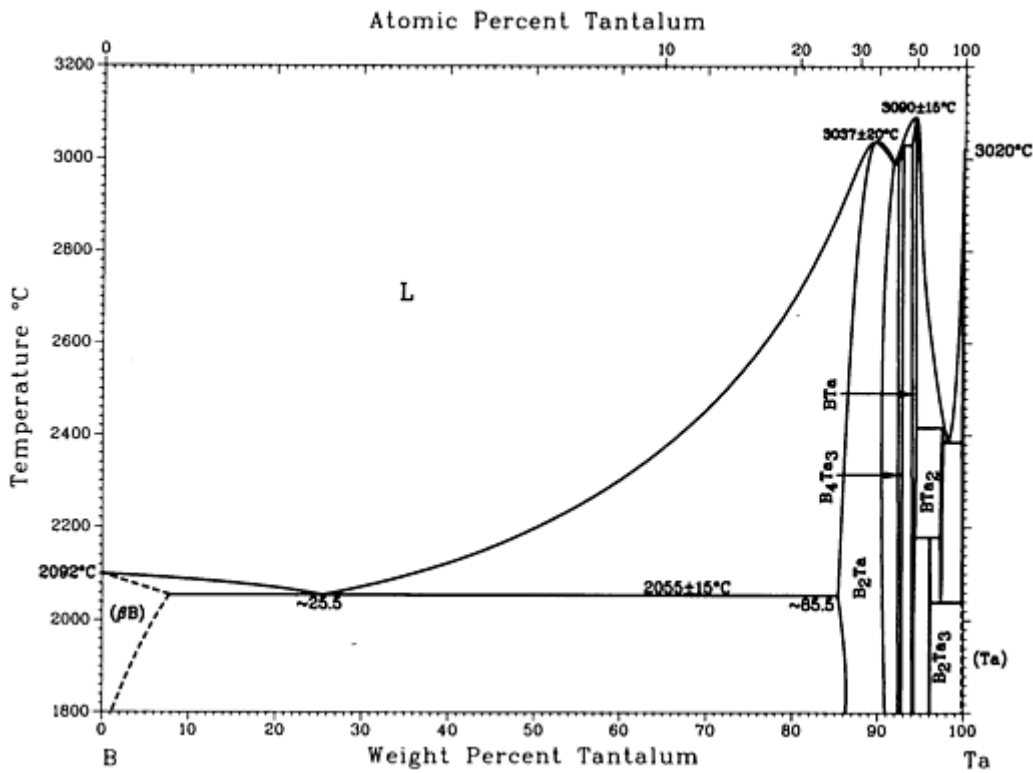

B-Ta phase diagram

B-Ta crystallographic data

Phase	Composition, wt% Ta	Pearson symbol	Space group
(β B)	0 to ~2	<i>hR108</i>	<i>R$\bar{3}m$</i>

B ₂ Ta	~85.5 to 91	<i>hP3</i>	<i>P6/mmm</i>
B ₄ Ta ₃	92.4 to 92.9	<i>oI14</i>	<i>Immm</i>
BTa	94 to 95	<i>oC8</i>	<i>Cmcm</i>
B ₂ Ta ₃	96.0 to 96.3	<i>tP10</i>	<i>P4/mbm</i>
BTa ₂	97.4 to 97.7	<i>tI12</i>	<i>I4/mcm</i>
(Ta)	100	<i>cI2</i>	<i>Im$\bar{3}m$</i>

B-Ti (Boron - Titanium)

J.L. Murray, P.K Liao, and K. E. Spear, 1987

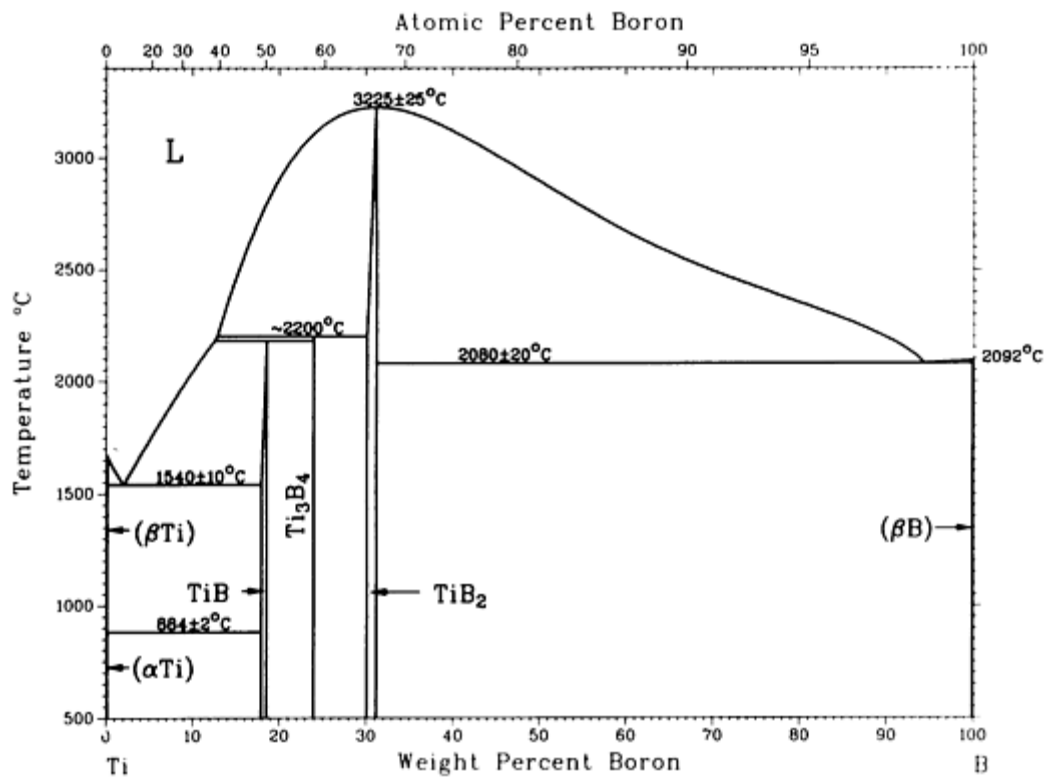

B-Ti phase diagram

B-Ti crystallographic data

Phase	Composition, wt% B	Pearson symbol	Space group
-------	--------------------	----------------	-------------

(α Ti)	0 to <0.05	<i>hP2</i>	<i>P6₃/mmc</i>
(β Ti)	0 to <0.05	<i>cI2</i>	<i>Im$\bar{3}m$</i>
TiB	18 to 18.4	<i>oP8</i>	<i>Pnma</i>
Ti ₃ B ₄	22.4	<i>oI14</i>	<i>Immm</i>
TiB ₂	30.1 to 31.1	<i>hP3</i>	<i>P6/mmm</i>
(β B)	~ 100	<i>hR108</i>	<i>R$\bar{3}m$</i>

B-V (Boron - Vanadium)

K.E. Spear, P.K. Liao, and J.F. Smith, 1991

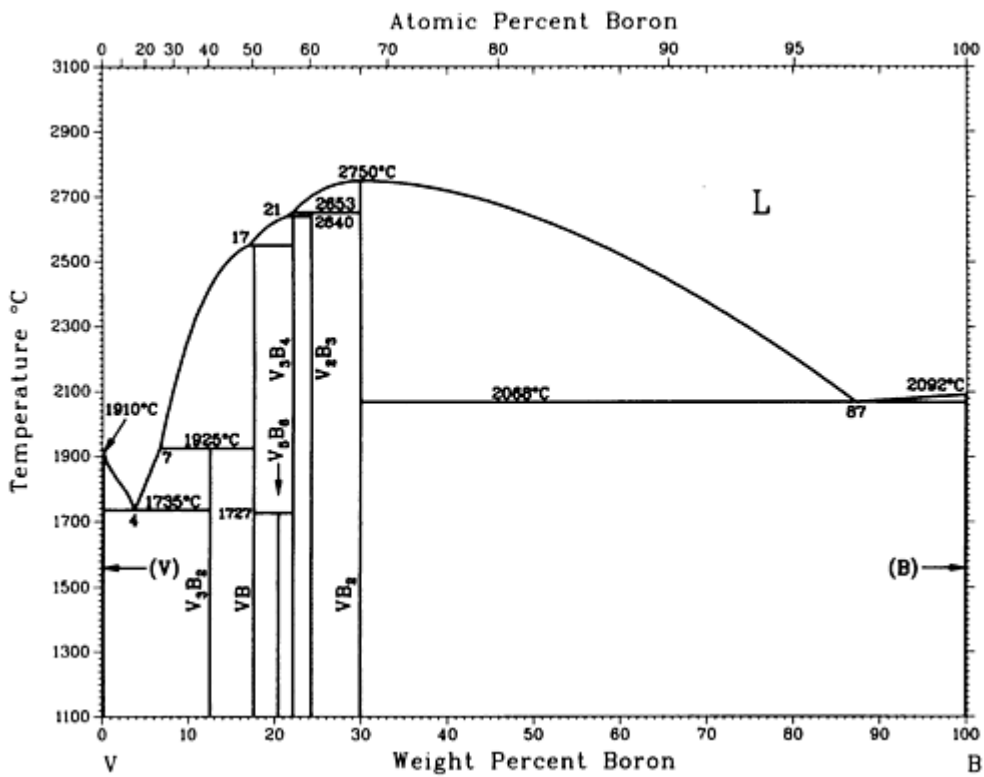

B-V phase diagram

B-V crystallographic data

Phase	Composition, wt% B	Pearson symbol	Space group
(α Ti)	0 to <0.05	<i>hP2</i>	<i>P6₃/mmc</i>
(β Ti)	0 to <0.05	<i>cI2</i>	<i>Im$\bar{3}m$</i>
TiB	18 to 18.4	<i>oP8</i>	<i>Pnma</i>
Ti ₃ B ₄	22.4	<i>oI14</i>	<i>Immm</i>
TiB ₂	30.1 to 31.1	<i>hP3</i>	<i>P6/mmm</i>
(β B)	~ 100	<i>hR108</i>	<i>R$\bar{3}m$</i>

(V)	0	<i>cI2</i>	<i>Im$\bar{3}m$</i>
V ₃ B ₂	12	<i>tP10</i>	<i>P4/mbm</i>
VB	18	<i>oC8</i>	<i>Cmcm</i>
V ₅ B ₆	20.3	^(a)	<i>Ammm</i>
V ₃ B ₄	22	<i>oI14</i>	<i>Immm</i>
V ₂ B ₃	24	^(a)	<i>Cmcm</i>
VB ₂	30	<i>hP3</i>	<i>P6/mmm</i>
(β B)	100	<i>hR108</i>	<i>R$\bar{3}m$</i>

(a) Orthorhombic

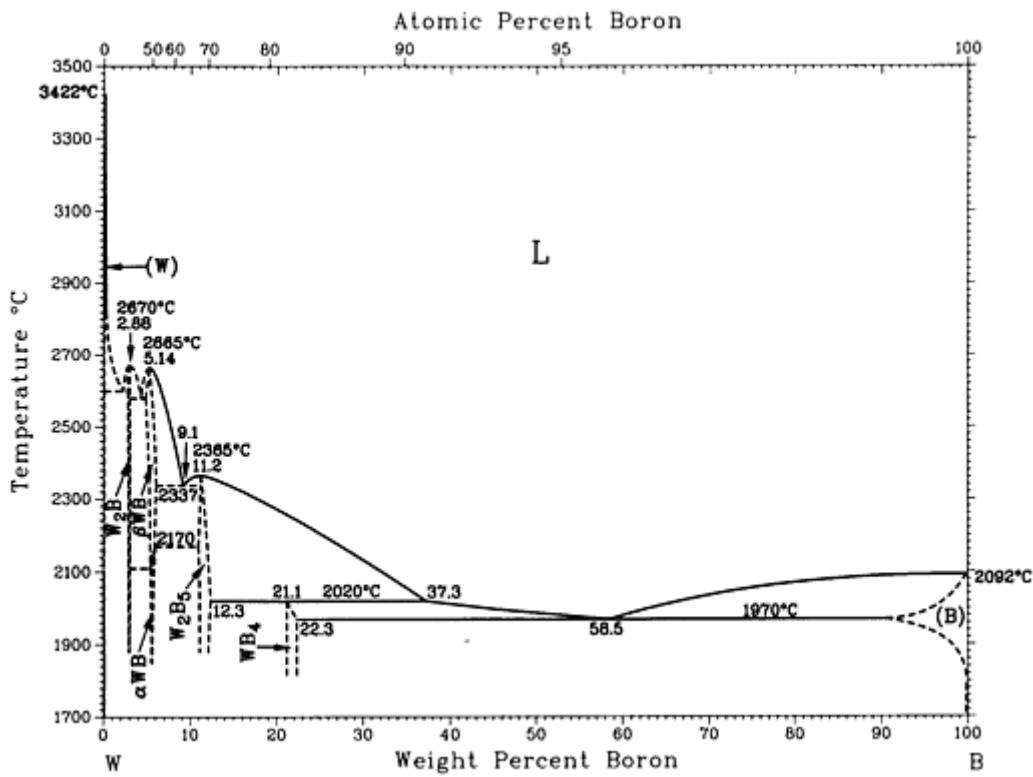

B-W phase diagram

B-W crystallographic data

Phase	Composition, wt% B	Pearson symbol	Space group
(W)	0	$cI2$	$Im\bar{3}m$
W_2B	2.9	$tI12$	$I4/mcm$
β_{WB}	5.2	$oC8$	$Cmcm$
α_{WB}	5.4	$tI16$	$I4_1/amd$
W_2B_5	11.1	$hP14$	$P6_3/mmc$
WB_4	21.1	$hP20$	$P6_3/mmc$
(B)	100	$hR12$ $tP50$	$R\bar{3}m$ $P4_2/nnm$

B-Y (Boron - Yttrium)

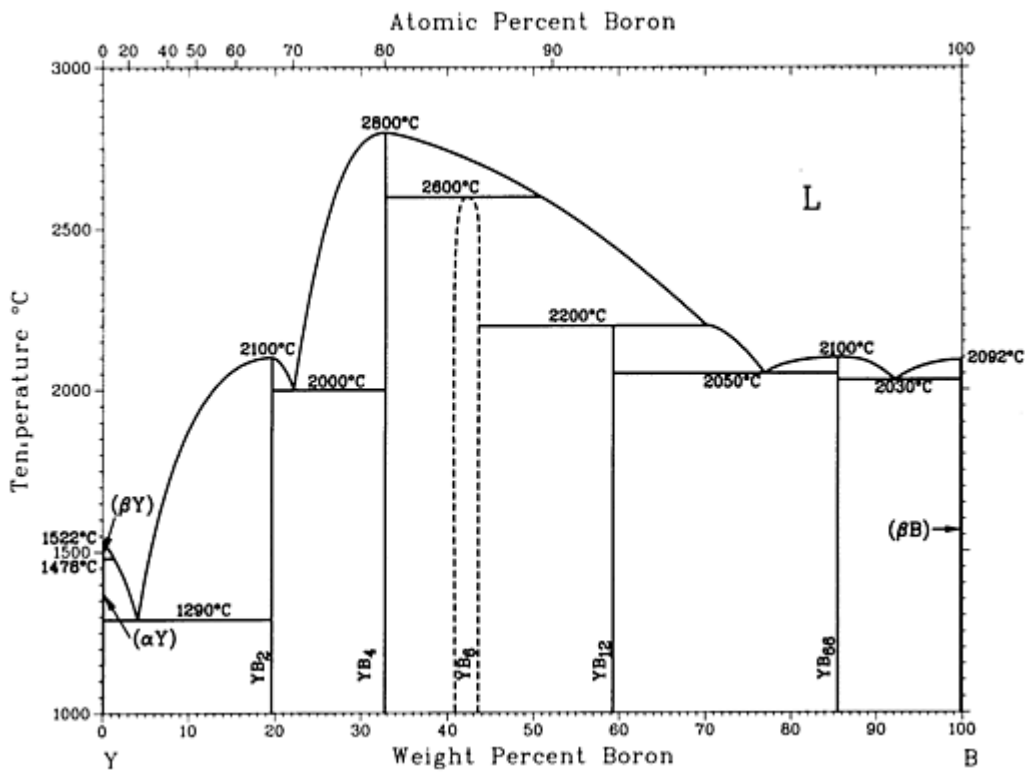

B-Y phase diagram

B-Y crystallographic data

Phase	Composition, wt% B	Pearson symbol	Space group
(β Y)	0	<i>cI2</i>	<i>Im$\bar{3}m$</i>
(α)Y	0	<i>hP2</i>	<i>P6$_3$/mmc</i>
YB ₂	19.6	<i>hP3</i>	<i>P6/mmm</i>
YB ₄	32.7	<i>tP20</i>	<i>P4/mbm</i>
YB ₆	42.2	<i>cP7</i>	<i>Pm$\bar{3}m$</i>
YB ₁₂	59.3	<i>cF52</i>	<i>Fm$\bar{3}m$</i>
YB ₆₆	85.6	...	<i>Fm$\bar{3}c$</i>
(β B)	100	<i>hR108</i>	<i>R$\bar{3}m$</i>

B-Zr (Boron - Zirconium)

From [Zirconium] 21

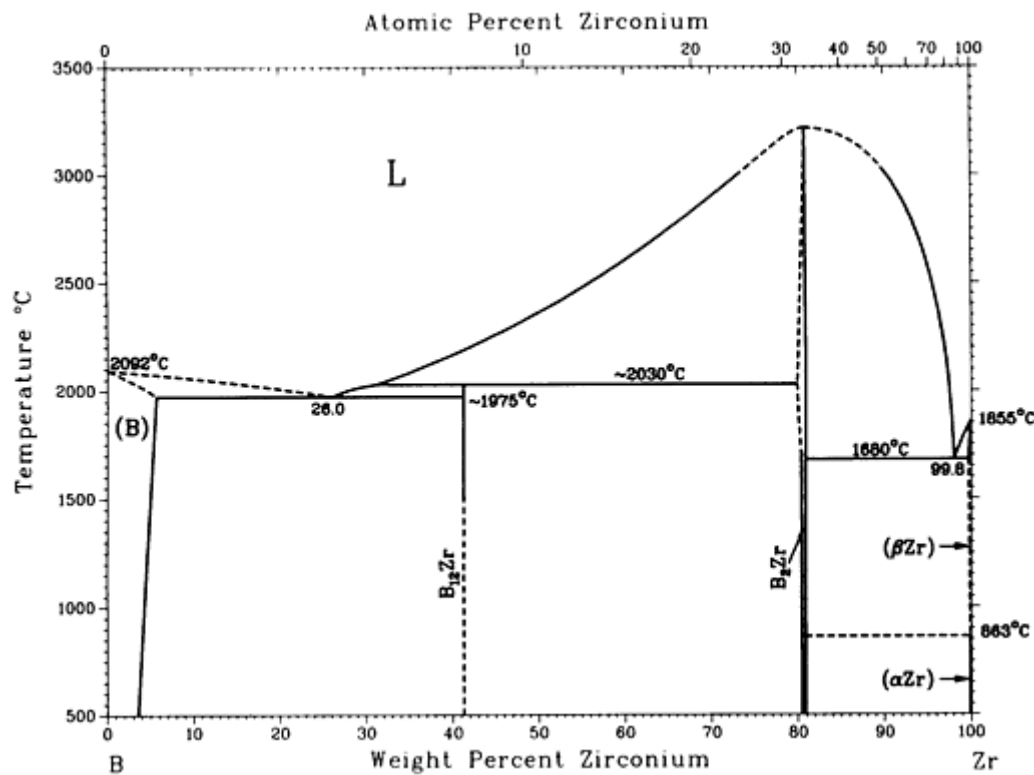

B-Zr phase diagram

B-Zr crystallographic data

Phase	Composition, wt% Zr	Pearson symbol	Space group
(B)	~0	$hR105$	$R\bar{3}m$
$B_{12}Zr$	40.9	$cF52$	$Fm\bar{3}m$
B_2Zr	80 to 83.8	$hP3$	$P6/mmm$
(βZr)	99.8 to 100	$cI2$	$Im\bar{3}m$
(αZr)	~100	$hP2$	$P6_3/mmc$

Reference cited in this section

21. [Zirconium]: C.B. Alcock, K.T. Jacob, S. Zador, O. von Goldbeck, H. Nowotny, K. Seifert, and O. Kubaschewski, *Zirconium: Physico-Chemical Properties of Its Compounds and Alloys*, O. Kubaschewski,

Ba-Ca (Barium - Calcium)

C.B. Alcock and V.P. Itkin, 1986

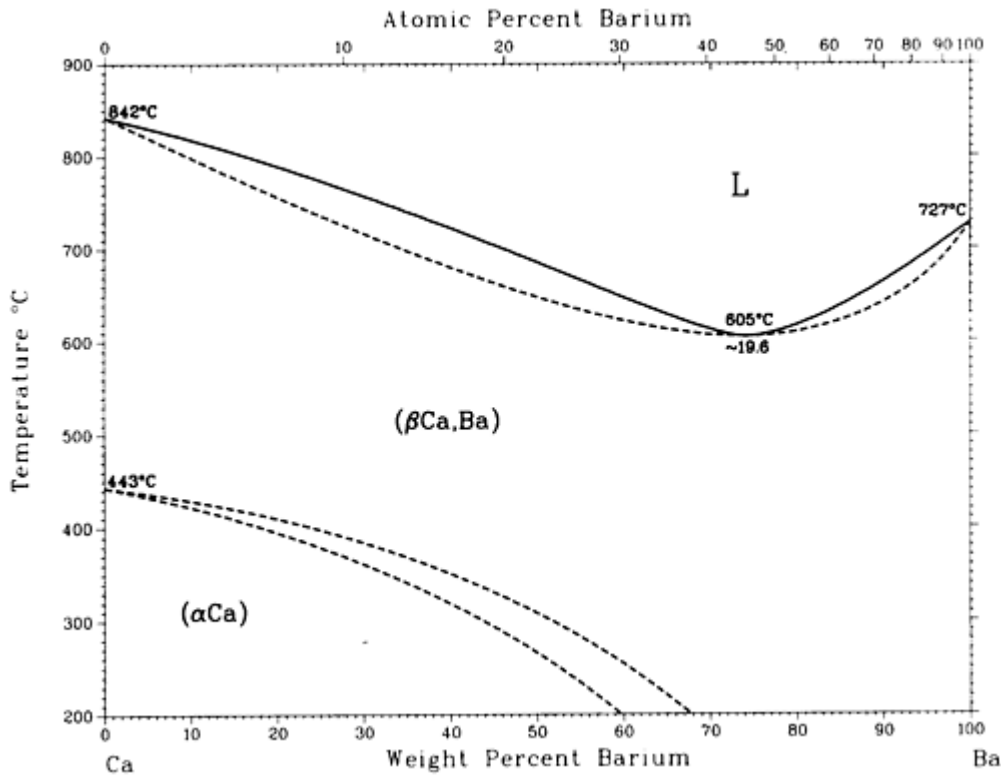

Ba-Ca phase diagram

Ba-Ca crystallographic data

Phase	Composition, wt% Ba	Pearson symbol	Space group
(αCa)	0 to 60	<i>cF4</i>	<i>Fm</i> $\bar{3}m$
(β _{Ca,Ba})	0 to 100	<i>cI2</i>	<i>Im</i> $\bar{3}m$

Ba-Cd (Barium - Cadmium)

H. Okamoto, 1990

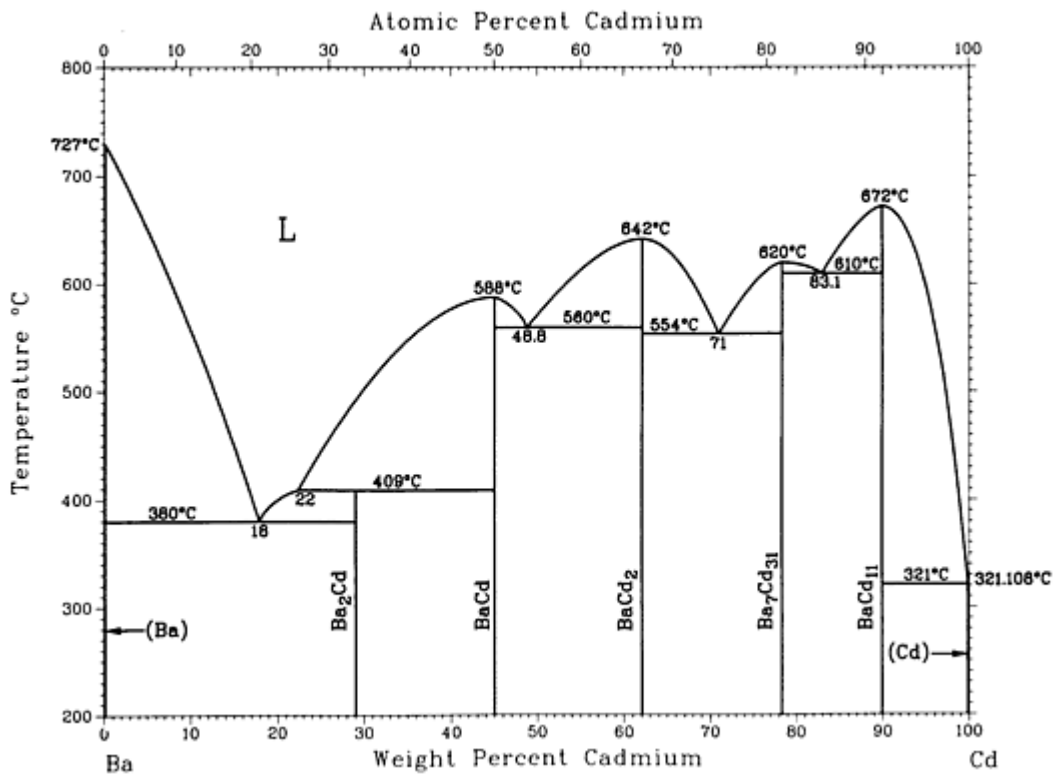

Ba-Cd phase diagram

Ba-Cd crystallographic data

Phase	Composition, wt% Cd	Pearson symbol	Space group
(Ba)	0	<i>cI2</i>	<i>Im</i> $\bar{3}m$
Ba ₂ Cd	29.0	<i>tI6</i>	<i>I4/mmm</i>
BaCd	45	<i>cP2</i>	<i>Pm</i> $\bar{3}m$
BaCd ₂	62.1	<i>oI12</i>	<i>Imma</i>
Ba ₇ Cd ₃₁	78.4	<i>hP41</i>	<i>P6/mmm</i>
BaCd ₁₁	90.0	<i>tI48</i>	<i>I4₁/amd</i>
(Cd)	100	<i>hP2</i>	<i>P6₃/mmc</i>

Ba-Cu (Barium - Copper)

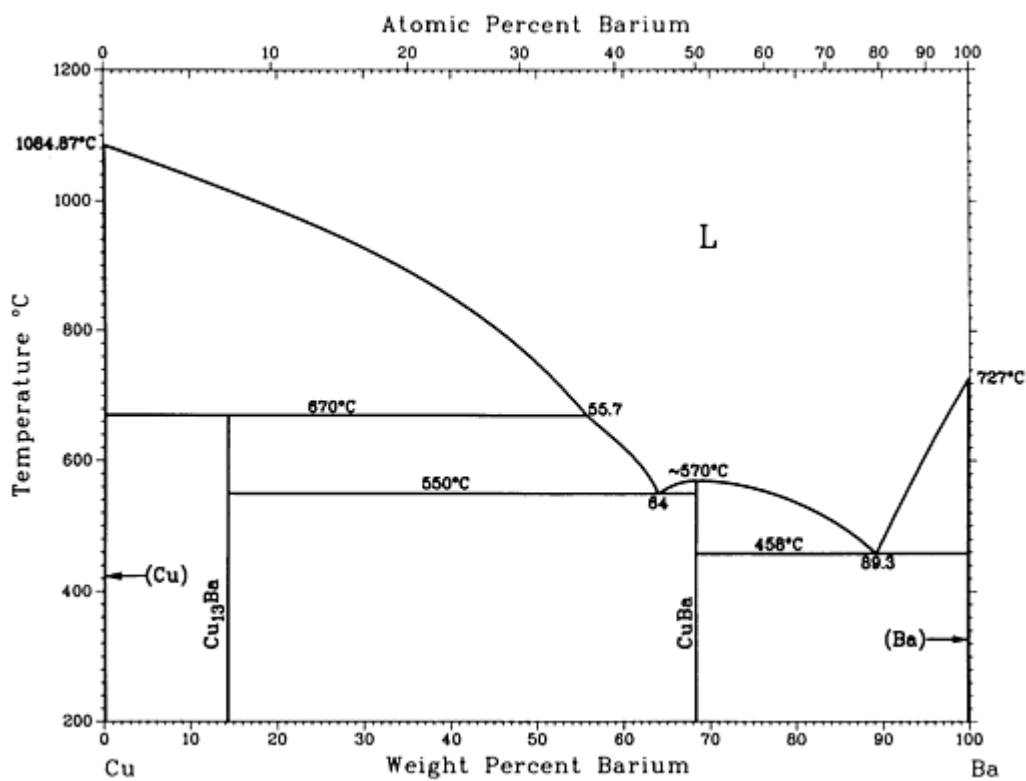

Ba-Cu phase diagram

Ba-Cu crystallographic data

Phase	Composition, wt% Ba	Pearson symbol	Space group
(Cu)	0	<i>cF4</i>	<i>Fm</i> $\bar{3}m$
Cu ₁₃ Ba	14.25	<i>cF112</i>	<i>Fm</i> $\bar{3}c$
CuBa	68.3	<i>hP8</i>	<i>P6</i> ₃ / <i>mmc</i>
(Ba)	100	<i>cI2</i>	<i>Im</i> $\bar{3}m$
Pressure-stabilized phase			
Ba	100	<i>hP2</i>	<i>P6</i> ₃ / <i>mmc</i>

Ba-Ga (Barium - Gallium)

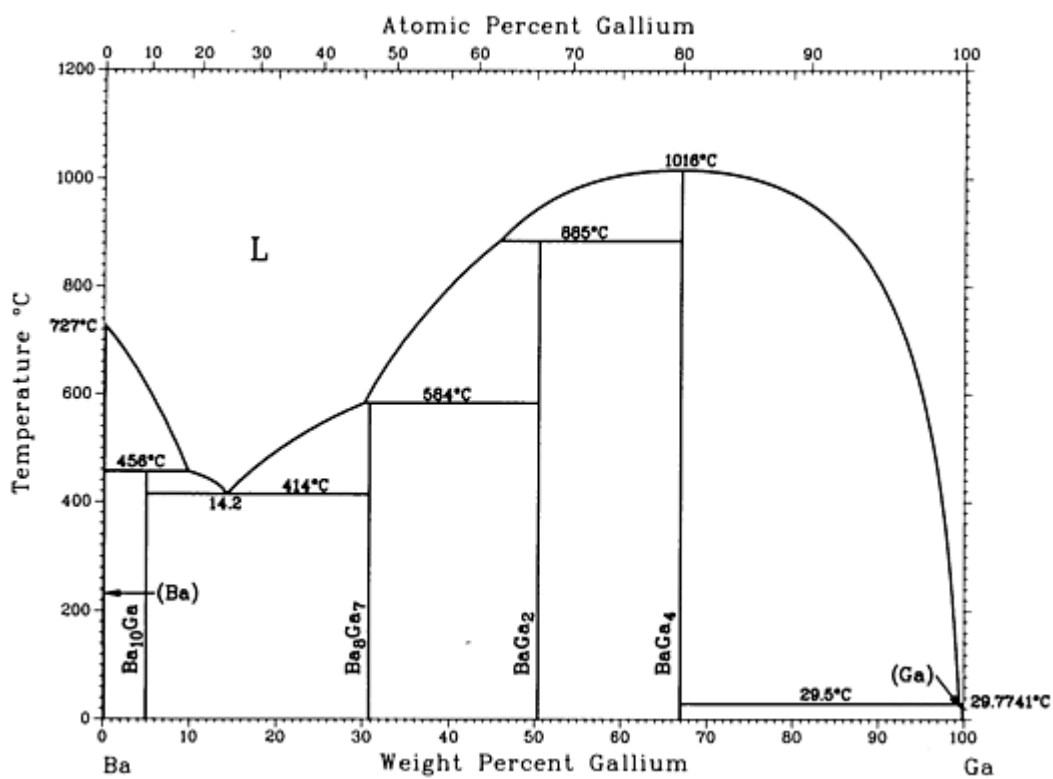

Ba-Ga phase diagram

Ba-Ga crystallographic data

Phase	Composition, wt% Ga	Pearson symbol	Space group
(Ba)	0	<i>cI2</i>	<i>Im$\bar{3}m$</i>
Ba ₁₀ Ga	4.8	<i>cF176</i>	<i>Fd$\bar{3}m$</i>
Ba ₈ Ga ₇	30.8	<i>cP60</i>	<i>P2₁3</i>
BaGa ₂	50.4	<i>hP3</i>	<i>P6/mmm</i>
BaGa ₄	67	<i>tI10</i>	<i>I4/mmm</i>
(Ga)	100	<i>hP2</i>	<i>P6₃/mmc</i>

Ba-Ge (Barium - Germanium)

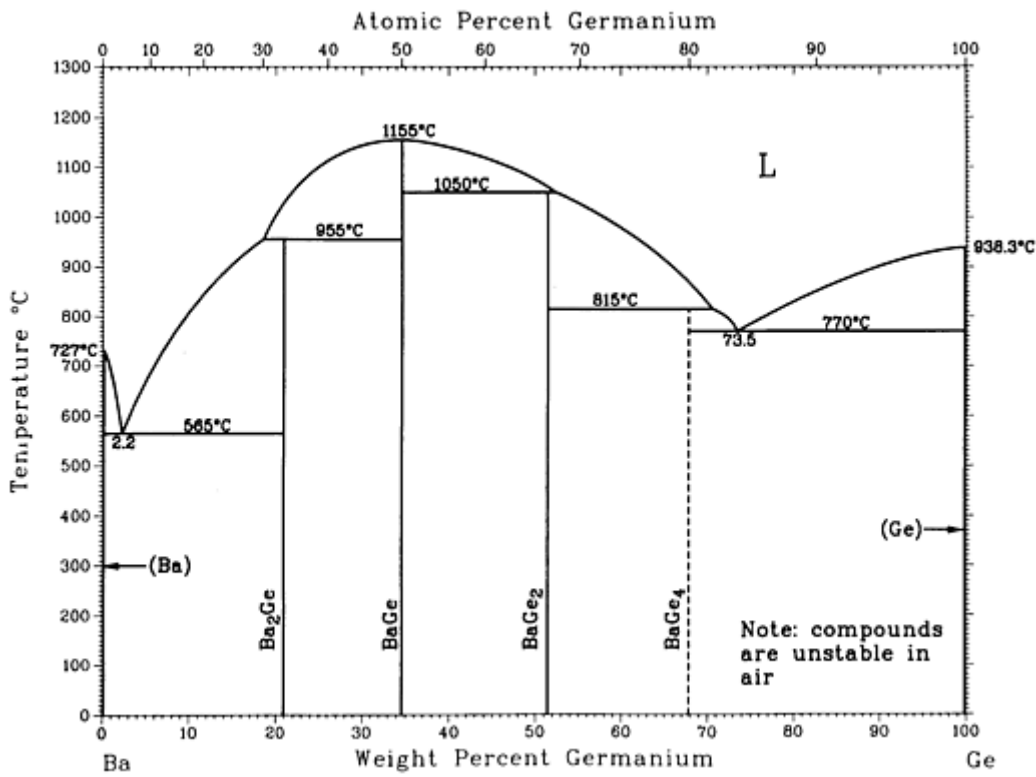

Ba-Ge phase diagram

Ba-Ge crystallographic data

Phase	Composition, wt% Ge	Pearson symbol	Space group
(Ba)	0	<i>cI2</i>	<i>Im</i> $\bar{3}m$
Ba ₂ Ge	20.9	<i>oP12</i>	<i>Pnma</i>
BaGe	35	<i>oC8</i>	<i>Cmcm</i>
BaGe ₂	51.4	<i>cP84</i> <i>oP24</i>	<i>P4</i> ₁ <i>32</i> <i>Pmna</i>
BaGe ₄	68
(Ge)	100	<i>cF8</i>	<i>Fd</i> $\bar{3}m$
High-pressure phase			
BaGe ₂ ^(a)	51.4	<i>tI12</i>	<i>I4</i> ₁ <i>/amd</i>

(a) Prepared at 1000 °C, 40 kbar pressure

Ba-H (Barium - Hydrogen)

D.T. Peterson and M. Indig, 1960

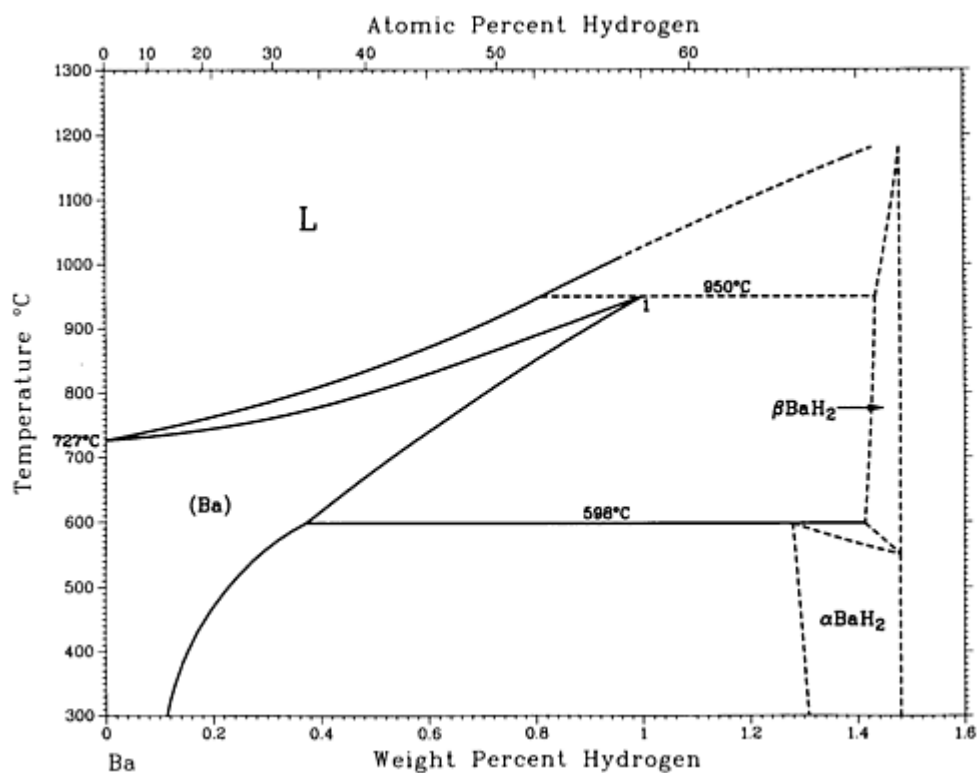

Ba-H phase diagram

Ba-H crystallographic data

Phase	Composition, wt% H	Pearson symbol	Space group
(Ba)	0 to 1	<i>cI2</i>	<i>Im</i> $\bar{3}m$
α BaH ₂	~1.3 to 1.5	<i>oP12</i>	<i>Pnma</i>
β BaH ₂	~1.4 to 1.5	<i>cI*</i>	...

Ba-Hg (Barium - Mercury)

P.R. Subramanian, 1990

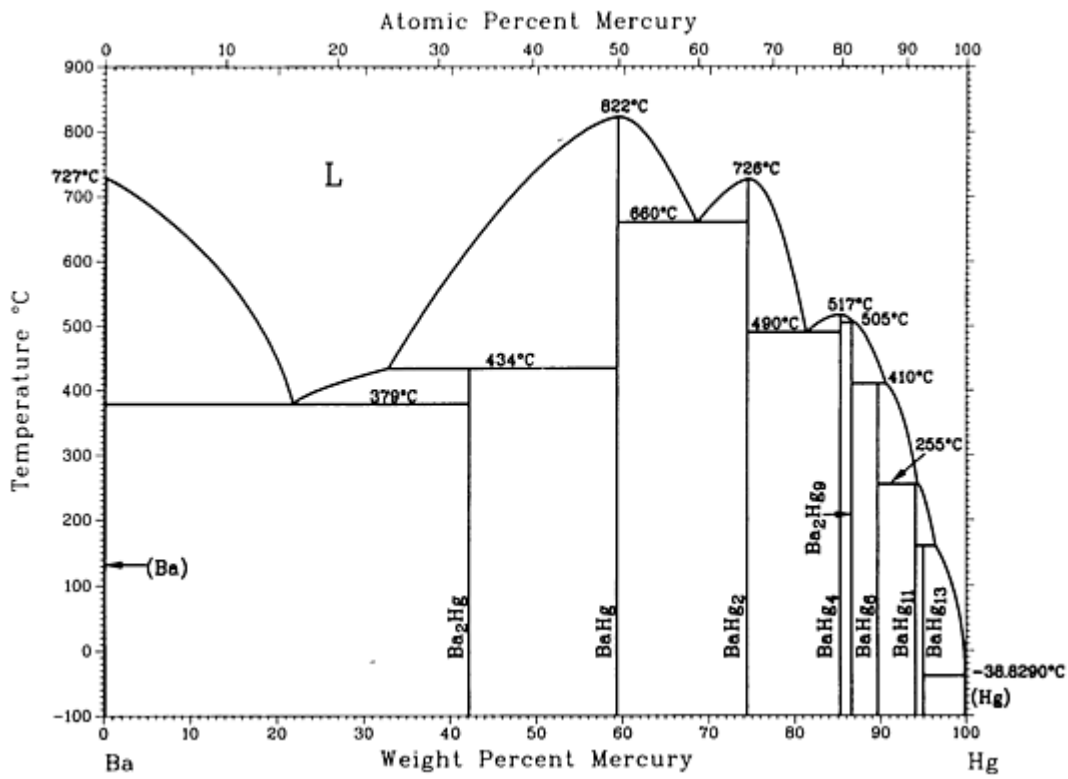

Ba-Hg phase diagram

Ba-Hg crystallographic data

Phase	Composition, wt% Hg	Pearson symbol	Space group
(Ba)	0	<i>cI2</i>	<i>Im</i> $\bar{3}m$
Ba ₂ Hg	42.2	<i>tI6</i>	<i>I4/mmm</i>
BaHg	59	<i>cP2</i>	<i>Pm</i> $\bar{3}m$
BaHg ₂	74.5	<i>oI12</i>	<i>Imma</i>
BaHg ₄	85
Ba ₂ Hg ₉	~86.7	<i>hP38</i>	<i>P6/mmm</i>
BaHg ₆	~89.8
BaHg ₁₁	~94.1	<i>cP36</i>	<i>Pm</i> $\bar{3}m$

BaHg ₁₃	~95
(Hg)	~100	<i>hR1</i>	<i>R$\bar{3}m$</i>

Ba-In (Barium - Indium)

H. Okamoto, 1992

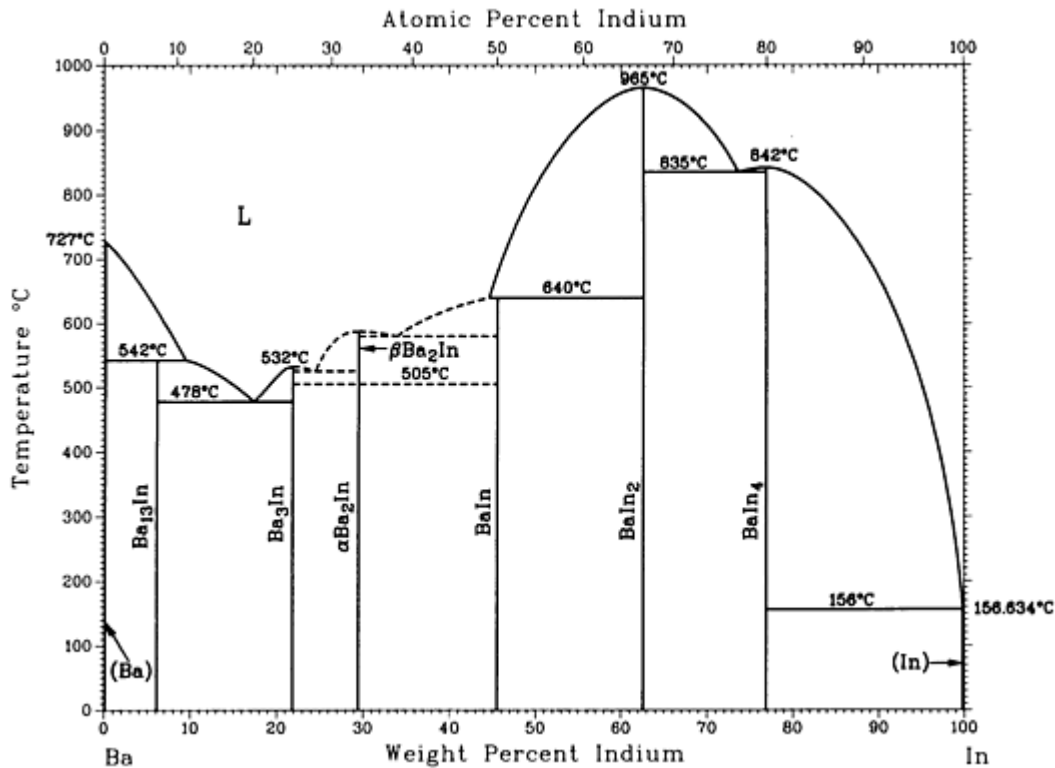

Ba-In phase diagram

Ba-In crystallographic data

Phase	Composition, wt% In	Pearson symbol	Space group
(Ba)	0	<i>cI2</i>	<i>Im$\bar{3}m$</i>
Ba ₁₃ In	6.0
Ba ₃ In	22
β-Ba ₂ In	29.5

$\alpha\text{Ba}_2\text{In}$	29.5
BaIn	46	(a)	...
BaIn ₂	62.6	<i>oI12</i>	<i>Imma</i>
BaIn ₄	77	<i>tI10</i>	<i>I4/mmm</i>
(In)	100	<i>tI2</i>	<i>I4/mmm</i>

(a) Not cubic.

Ba-Li (Barium - Lithium)

A.D. Pelton, 1984

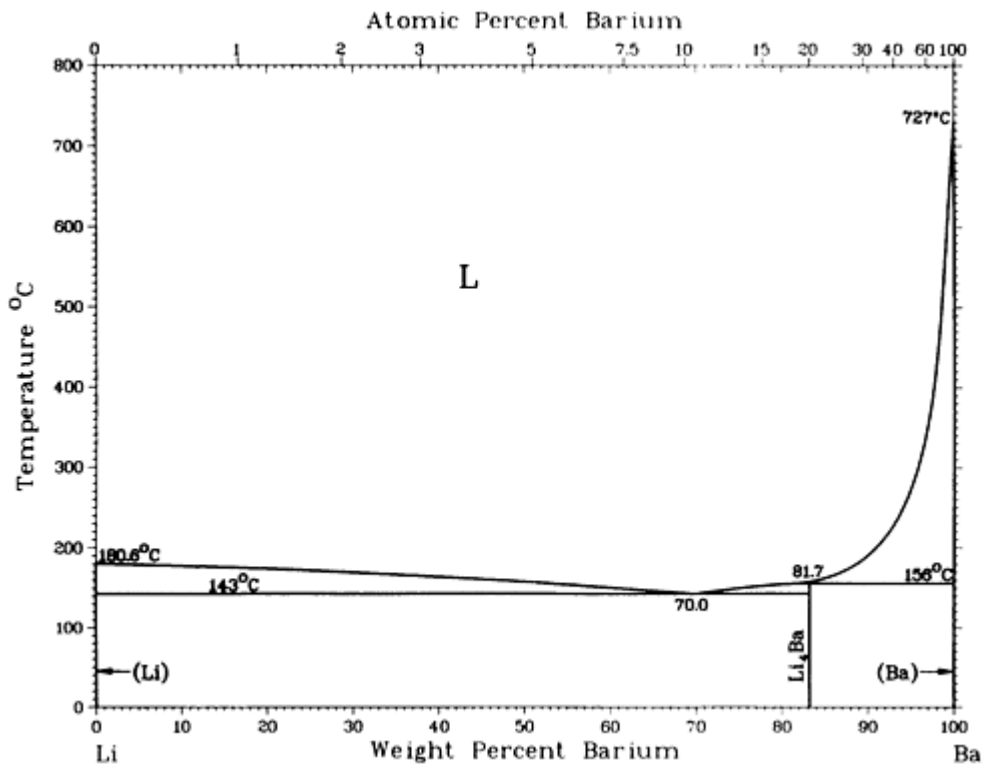

Ba-Li phase diagram

Ba-Li crystallographic data

Phase	Composition, wt% Ba	Pearson symbol	Space group
$\alpha\text{Ba}_2\text{In}$	29.5
BaIn	46	(a)	...
BaIn ₂	62.6	<i>oI12</i>	<i>Imma</i>
BaIn ₄	77	<i>tI10</i>	<i>I4/mmm</i>
(In)	100	<i>tI2</i>	<i>I4/mmm</i>

(β Li)	0	<i>cI2</i>	<i>Im</i> $\bar{3}m$
(α Li) ^(a)	0	<i>hP2</i>	<i>P6</i> $_3/mmc$
Li ₄ Ba	83	<i>hP30</i>	<i>P6</i> $_3/mmc$
(Ba)	100	<i>cI2</i>	<i>Im</i> $\bar{3}m$

(a) Exists below -201 °C

Ba-Mg (Barium - Magnesium)

A.A. Nayeb-Hashemi and J.B. Clark, 1988

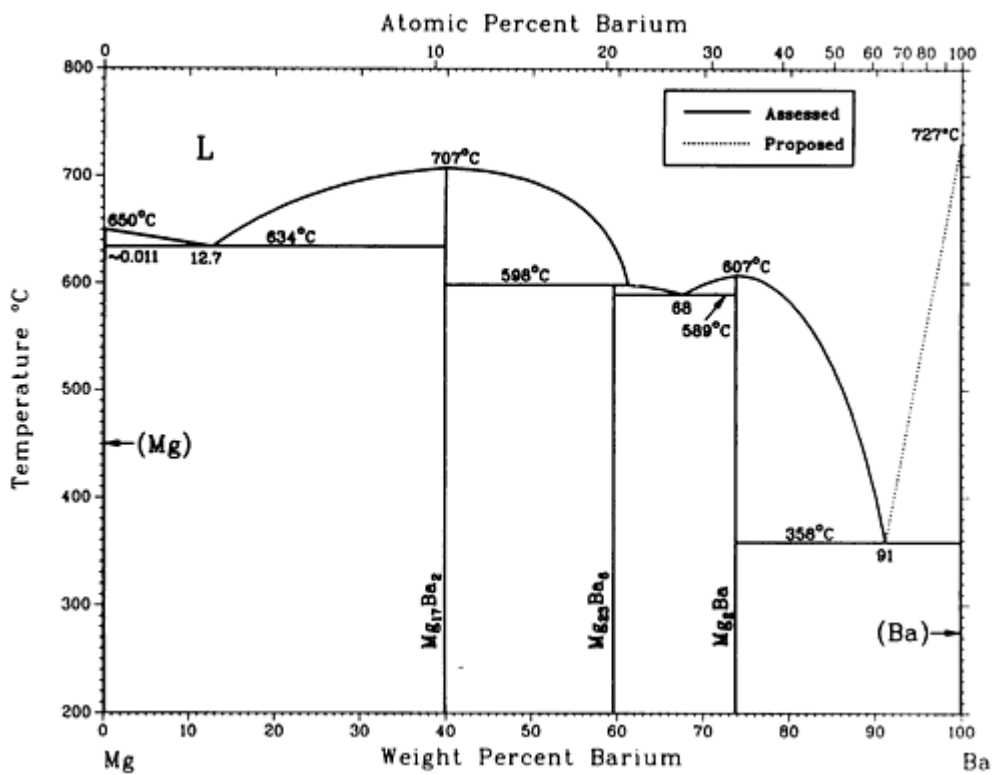

Ba-Mg phase diagram

Ba-Mg crystallographic data

Phase	Composition, wt% Ba	Pearson symbol	Space group
(Mg)	0.0 to ~0.011	<i>hP2</i>	<i>P6</i> $_3/mmc$

Mg ₁₇ Ba ₂	39.94	<i>hR19</i>	<i>R$\bar{3}m$</i>
Mg ₂₃ Ba ₆	59.58	<i>cF116</i>	<i>Fm$\bar{3}m$</i>
Mg ₂ Ba	73.85	<i>hP12</i>	<i>P6₃/mmc</i>
(α Ba)	100	<i>cI2</i>	<i>Im$\bar{3}m$</i>

Ba-Na (Barium - Sodium)

A.D. Pelton, 1985

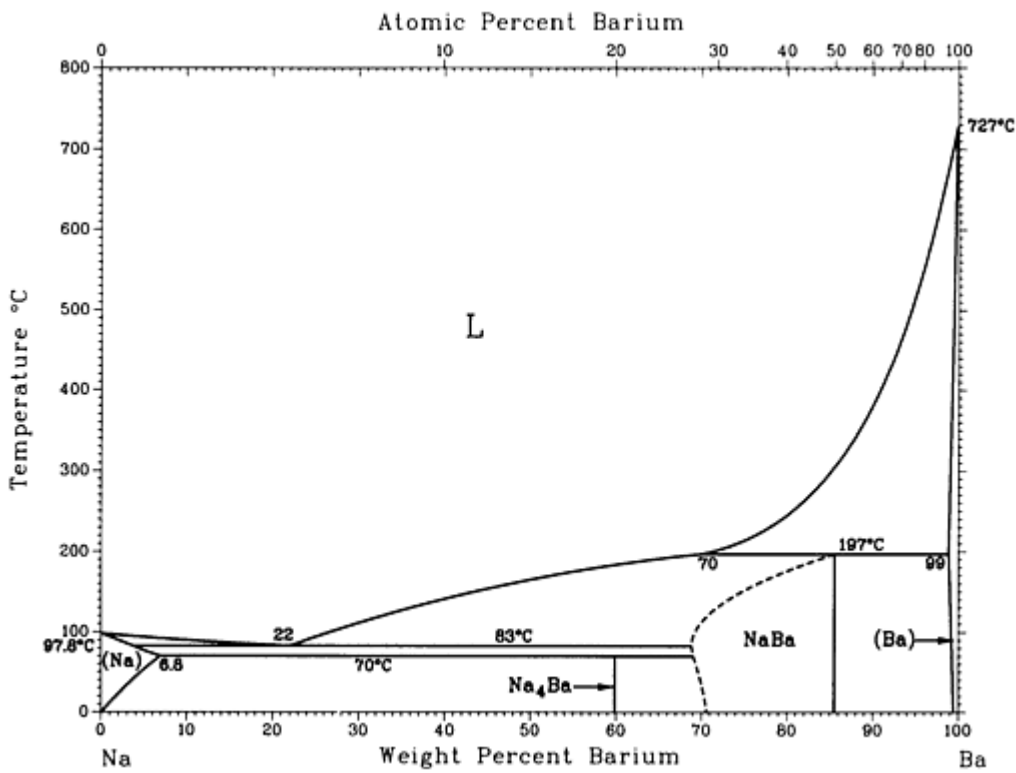

Ba-Na phase diagram

Ba-Na crystallographic data

Phase	Composition, wt% Ba	Pearson symbol	Space group
(α Na)	0	<i>hP2</i>	<i>P6₃/mmc</i>
(β Na)	0 to 6.8	<i>cI2</i>	<i>Im$\bar{3}m$</i>

Na ₄ Ba	60	(a)	...
NaBa	69 to 86	(b)	...
(Ba)	99 to 100	<i>cI2</i>	<i>Im</i> $\bar{3}m$

(a) Tetragonal.

(b) Orthorhombic

Ba-P (Barium - Phosphorus)

P.R. Subramanian, 1990

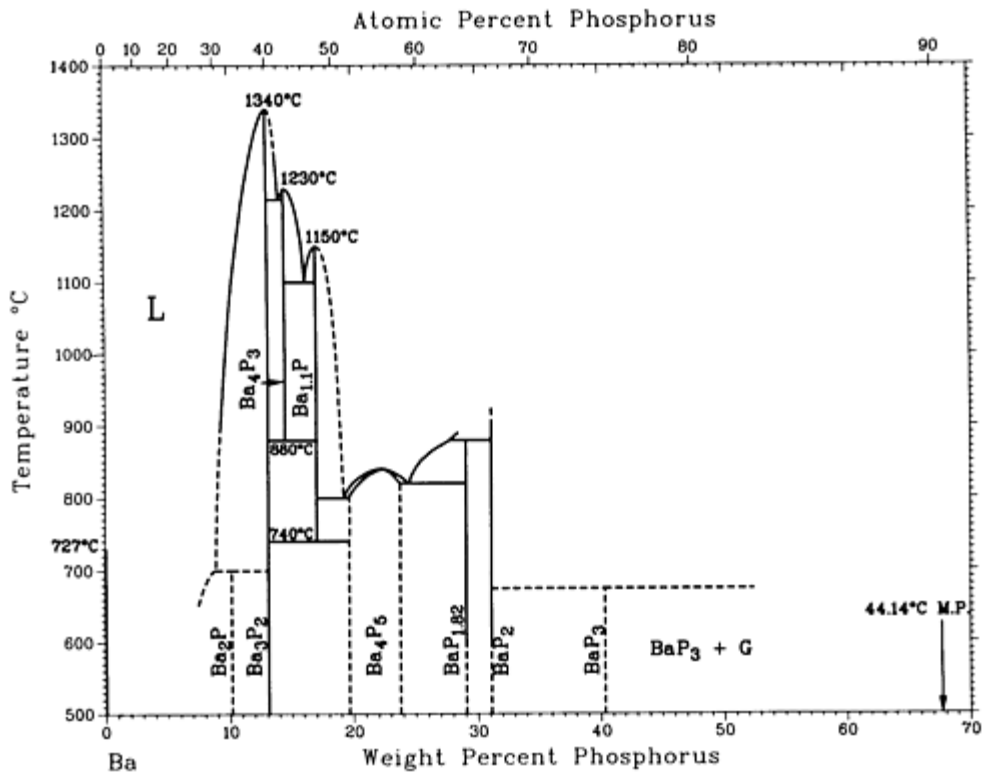

Ba-P phase diagram

Ba-P crystallographic data

Phase	Composition, wt% P	Pearson symbol	Space group
(Ba)	0	<i>cI2</i>	<i>Im</i> $\bar{3}m$

Ba ₂ P	10.1
Ba ₃ P ₂	13	<i>cI28</i>	<i>I43d</i>
Ba ₄ P ₃	~14.5
Ba _{1,1} P	~17.0
Ba ₄ P ₅	~22.0
BaP _{1,82}	~29.0
BaP ₂	31.1
BaP ₃	40	<i>mC16</i>	<i>C2/m</i>
Ba ₃ P ₁₄	~51.3	<i>mP34</i>	<i>P21/a</i>
BaP₁₀	~69.3	<i>oC44</i>	<i>Cmc2₁</i>

Ba-Pb (Barium - Lead)

From [Hansen] 6

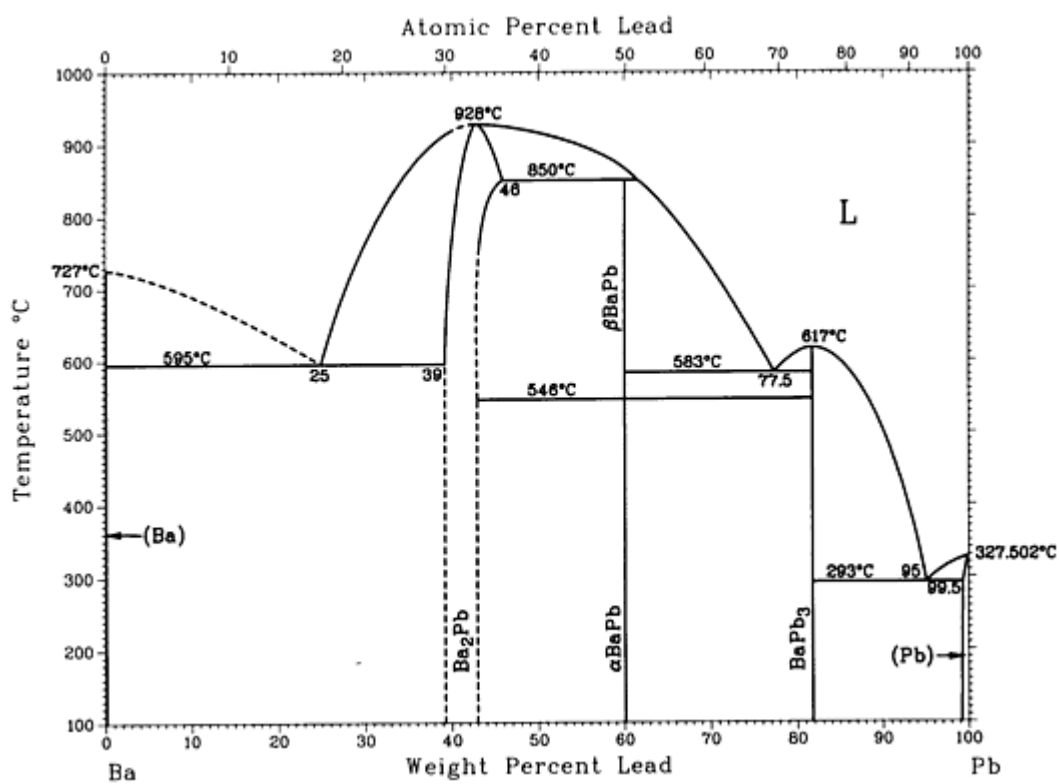

Ba-Pb phase diagram

Ba-Pb crystallographic data

Phase	Composition, wt% Pb	Pearson symbol	Space group
(Ba)	0	<i>cI2</i>	<i>Im</i> $\bar{3}m$
Ba ₂ Pb	~39 to 43.0	<i>oP12</i>	<i>Pnma</i>
β BaPb	60
α BaPb	60	<i>oC8</i>	<i>Cmcm</i>
BaPb ₃	82	<i>hR12</i>	<i>R</i> $\bar{3}m$
(Pb)	99.5 to 100	<i>cF4</i>	<i>Fm</i> $\bar{3}m$

Reference cited in this section

6. [Hansen]: M. Hansen and K. Anderko, *Constitution of Binary Alloys*, McGraw-Hill, New York or General

Ba-Se (Barium - Selenium)

H. Okamoto, 1991

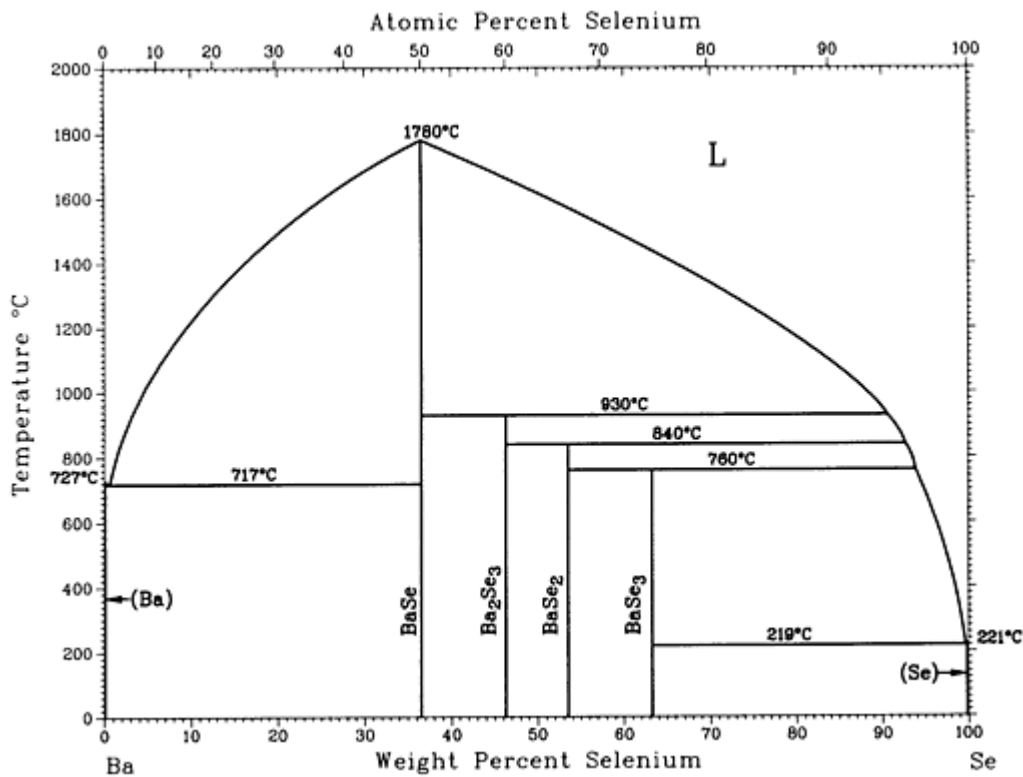

Ba-Se phase diagram

Ba-Se crystallographic data

Phase	Composition, wt% Se	Pearson symbol	Space group
(Ba)	0	<i>cI2</i>	<i>Im</i> $\bar{3}m$
BaSe	37	<i>cF8</i>	<i>Fm</i> $\bar{3}m$
Ba ₂ Se ₃	46
BaSe ₂	53.5	<i>mC12</i>	<i>C2/c</i>
BaSe ₃	63	<i>tP8</i>	<i>P</i> $\bar{4}2_1m$

(Se)	100	hP3	P3 ₁ 21
------	-----	-----	--------------------

Ba-Si (Barium - Silicon)

I. Obinata, Y. Takeuchi, K. Kurihara, and M. Watanabe, 1964

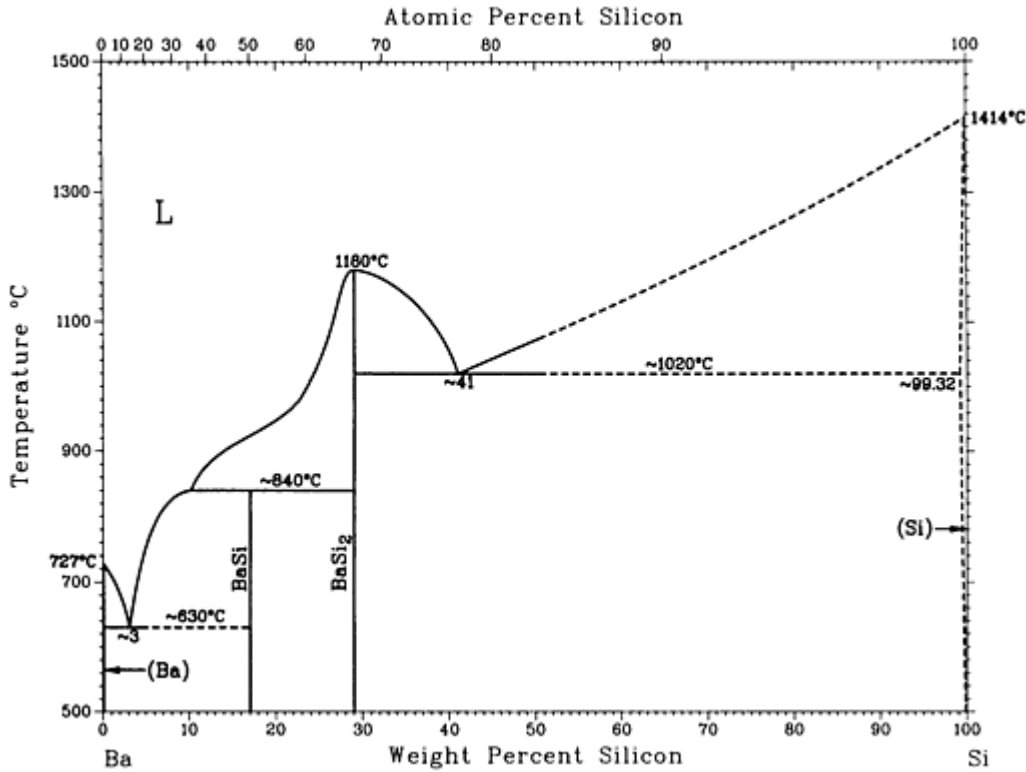

Ba-Si phase diagram

Ba-Si crystallographic data

Phase	Composition, wt% Si	Pearson symbol	Space group
(Ba)	~0	<i>cI2</i>	<i>Im</i> $\bar{3}m$
Ba ₂ Si ^(a)	9.3	<i>oP12</i>	<i>Pnma</i>
Ba ₅ Si ₃ ^(a)	10.9	<i>tP32</i>	<i>P4/ncc</i>
BaSi	17	<i>oC8</i>	<i>Cmcm</i>
Ba ₃ Si ₄	21.4	<i>tP28</i>	<i>P4₂/mnm</i>

BaSi ₂	29.1	<i>oP24</i> <i>hP3</i>	<i>Pnma</i> <i>P6/mmm</i>
(Si)	~100	<i>cF8</i>	<i>Fd3̄m</i>

(a) Found after the diagram was constructed

Ba-Te (Barium - Tellurium)

H. Okamoto, unpublished

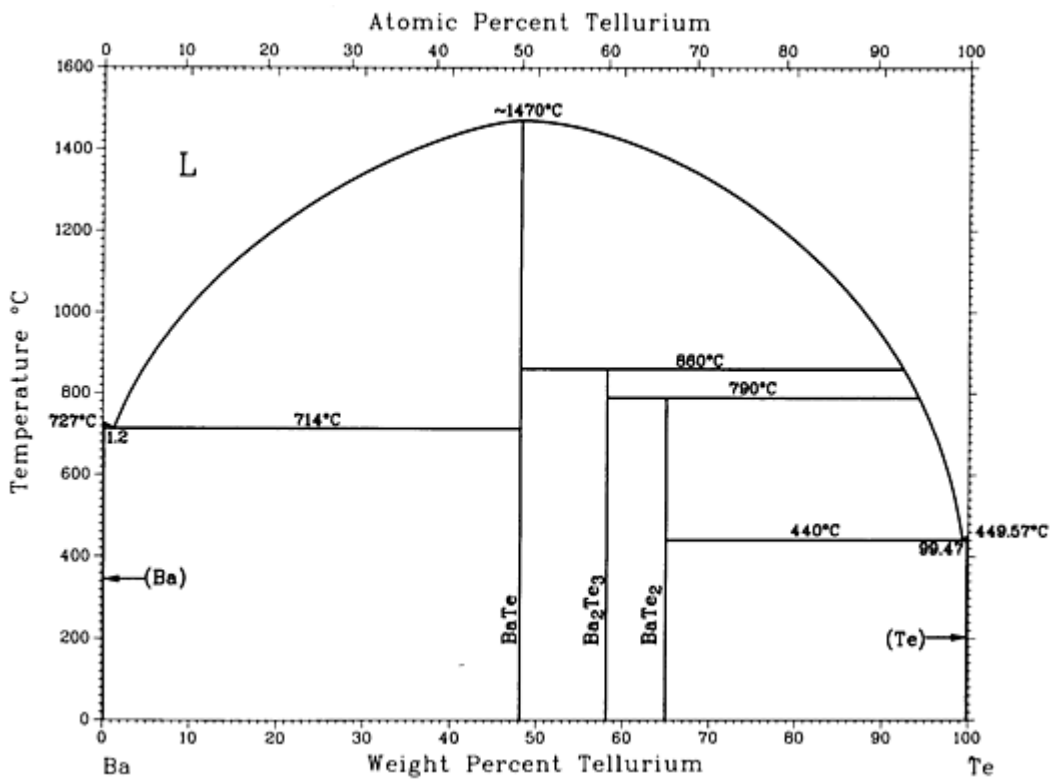

Ba-Te phase diagram

Ba-Te crystallographic data

Phase	Composition, wt% Te	Pearson symbol	Space group
(Ba)	0	<i>cI2</i>	<i>Im3̄m</i>
BaTe	48	<i>cF8</i>	<i>Fm3̄m</i>

Ba ₂ Te ₃	58
BaTe ₂	65.1
(Te)	100	<i>hP3</i>	<i>P3₁21</i>

Ba-Tl (Barium - Thallium)

G. Bruzzone, 1966

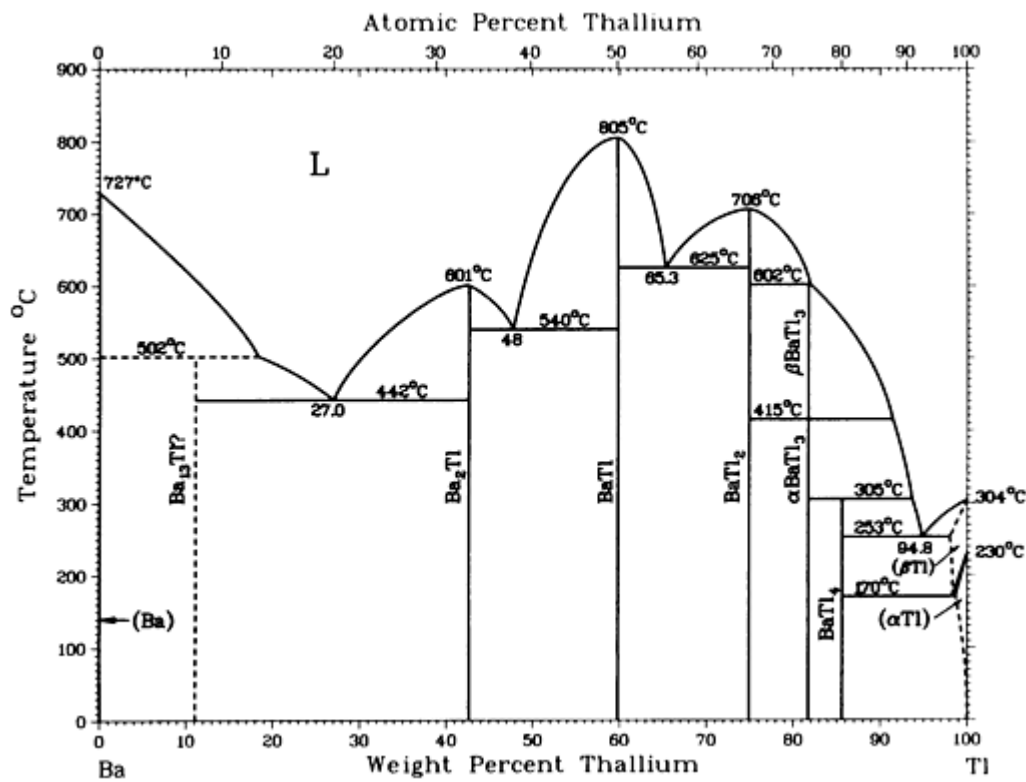

Ba-Tl phase diagram

Ba-Tl crystallographic data

Phase	Composition, wt% Tl	Pearson symbol	Space group
(Ba)	~0	<i>cI2</i>	<i>Im</i> $\bar{3}m$
Ba ₁₃ Tl	~10
Ba ₂ Tl	42.6

BaTl	60
BaTl ₂	74.9	<i>hP6</i>	<i>P6₃/mmc</i>
α BaTl ₃	79
β BaTl ₃	79
BaTl ₄	86
(β Tl)	~ 98 to 100	<i>hP2</i>	<i>P6₃/mmc</i>
(α Tl)	~ 98.7 to 100	<i>cI2</i>	<i>Im$\bar{3}m$</i>

Ba-Zn (Barium - Zinc)

H. Okamoto, 1991

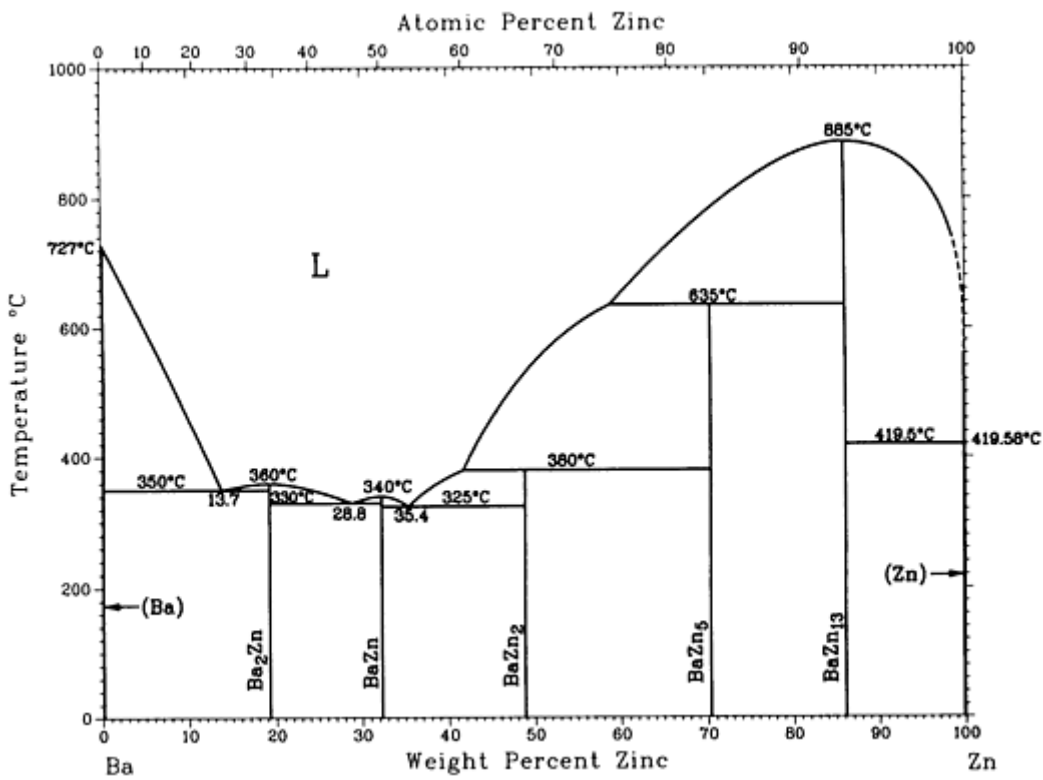

Ba-Zn phase diagram

Ba-Zn crystallographic data

Phase	Composition, wt% Zn	Pearson symbol	Space group
(Ba)	0	<i>cI2</i>	<i>Im$\bar{3}m$</i>
Ba ₂ Zn	19.2	<i>tI6</i>	<i>I4/mmm</i>
BaZn	32	<i>cP2</i>	<i>Pm$\bar{3}m$</i>
BaZn ₂	48.8	<i>oI12</i>	<i>Imma</i>
BaZn ₅	70.4	<i>oC25</i>	<i>Cmcm</i>
BaZn ₁₃	86.2	<i>cF112</i>	<i>Fm$\bar{3}c$</i>
(Zn)	100	<i>hP2</i>	<i>P6₃/mmc</i>

Be (Beryllium) Binary Alloy Phase Diagrams

Introduction

THIS ARTICLE includes systems where beryllium is the first-named element in the binary pair. Additional binary systems that include beryllium are provided in the following locations in this Volume:

- “Ag-Be (Silver - Beryllium)” in the article “Ag (Silver) Binary Alloy Phase Diagrams.”
- “Al-Be (Aluminum - Beryllium)” in the article “Al (Aluminum) Binary Alloy Phase Diagrams.”
- “Au-Be (Gold - Beryllium)” in the article “Au (Gold) Binary Alloy Phase Diagrams.”

Be-Co (Beryllium - Cobalt)

H. Okamoto, L.E. Tanner, and T. Nishizawa, 1988

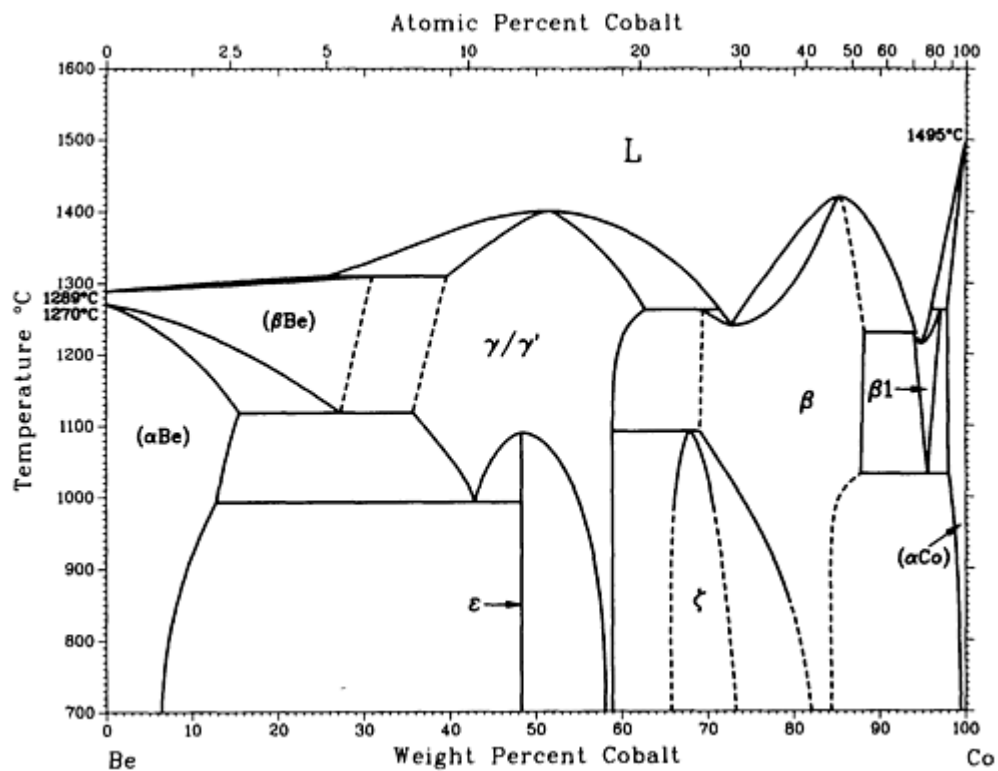

Be-Co phase diagram

Be-Co crystallographic data

Phase	Composition, wt% Co	Pearson symbol	Space group
(β _{Be})	0 to 29	<i>cI2</i>	<i>Im$\bar{3}m$</i>
(α _{Be})	0 to 15.61	<i>hP2</i>	<i>P6₃/mmc</i>
Be ₁₂ Co ^(a)		<i>tI26</i>	<i>I4/mmm</i>
γ	34.7 to ?	<i>cI52</i>	<i>Im$\bar{3}m$</i>
γ'	? to 62	<i>cF416</i>	<i>Fm$\bar{3}m$</i>
ε	~47	<i>hP19</i> <i>hP48</i>	<i>P6m2</i> <i>P6₃/mcm</i>
δ	^(a)	<i>cF24</i>	<i>F4$\bar{3}m$</i>

β .	(a)	$cI2$	$Im\bar{3}m$
ζ .	(a)	(b)	?
ζ	66 to 70	$hP96$	$P6_3/mcm$
β	70 to 88	$cP2$	$Pm\bar{3}m$
β_1	94 to 97	$cI2?$	$Im\bar{3}m$
(α Co)	98 to 100	$cF4$	$Fm\bar{3}m$
(ϵ Co)	99.9 to 100 ^(a)	$hP2$	$P6_3/mmc$
Metastable phases			
...	~ 86.7	(c)	?
...	91 to 97	(d)	?

(a) Not shown in the assessed diagram.

(b) Orthorhombic.

(c) bct.

(d) Tetragonal.

Be-Cr (Beryllium - Chromium)

M. Venkatraman and J.P. Neumann, 1987

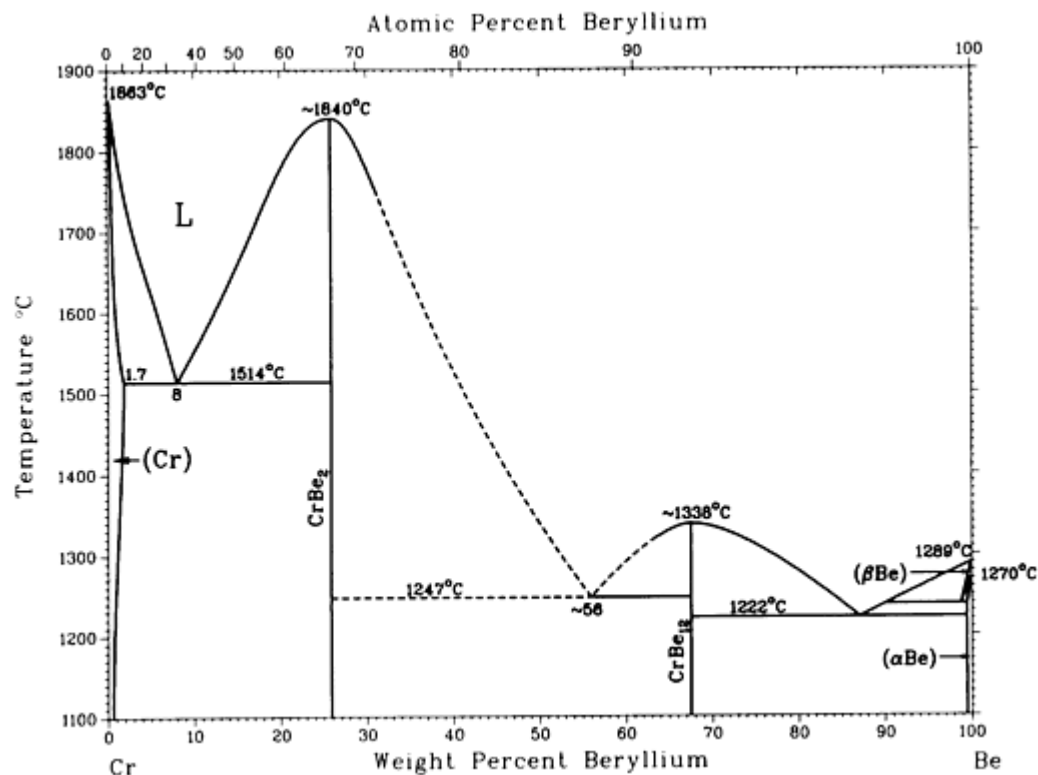

Be-Cr phase diagram

Be-Cr crystallographic data

Phase	Composition, wt% Be	Pearson symbol	Space group
(Cr)	0 to 1.7	<i>cI2</i>	<i>Im</i> $\bar{3}m$
CrBe ₂	25.8 to ~26	<i>hP12</i>	<i>P6₃/mmc</i>
CrBe ₁₂	67.5	<i>tI26</i>	<i>I4/mmm</i>
(β)Be	~98.9 to 100	<i>cI2</i>	<i>Im</i> $\bar{3}m$
(α)Be	~99.54 to 100	<i>hP2</i>	<i>P6₃/mmc</i>

Be-Cu (Beryllium - Copper)

H. Okamoto, 1992

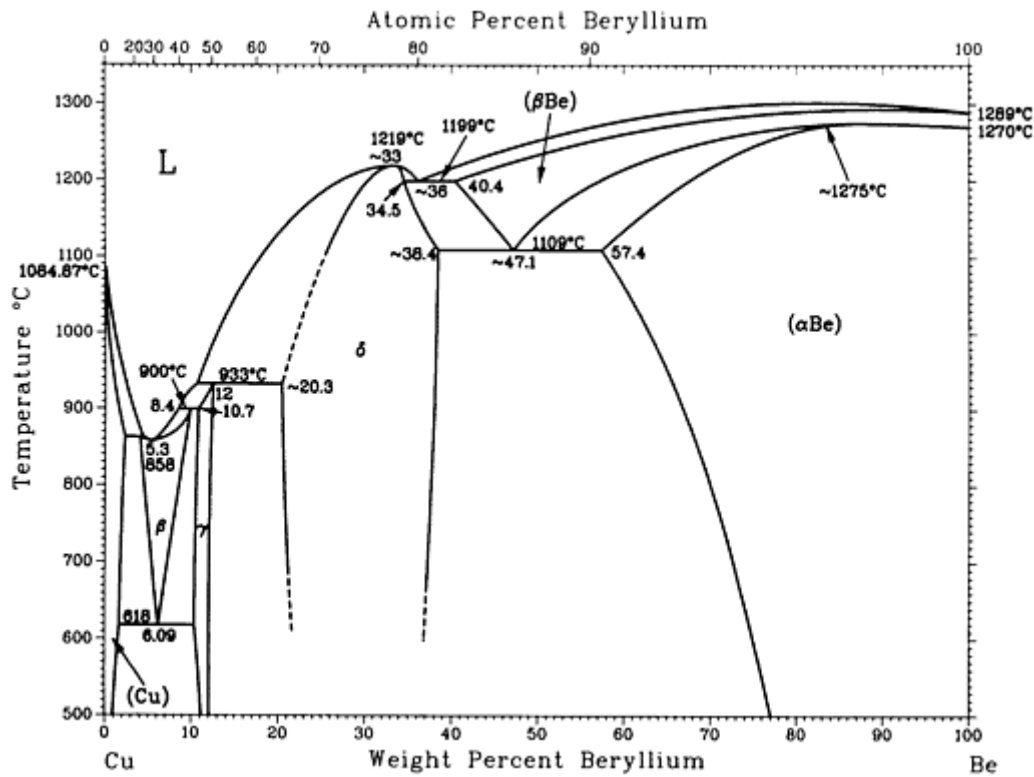

Be-Cu phase diagram

Be-Cu crystallographic data

Phase	Composition, wt% Be	Pearson symbol	Space group
(Cu)	0 to 2.2	<i>cF4</i>	<i>Fm</i> $\bar{3}m$
β	4.3 to 9.8	<i>cI2</i>	<i>Im</i> $\bar{3}m$
γ	10.3 to 12.4	<i>cP2</i>	<i>Pm</i> $\bar{3}m$
δ	~20.4 to ~38.5	<i>cF24</i>	<i>Fd</i> $\bar{3}m$
(β Be)	40.4 to 100	<i>cI2</i>	<i>Im</i> $\bar{3}m$
(α Be)	57.5 to 100	<i>hP2</i>	<i>P6</i> $_3/mmc$

Be-Fe (Beryllium - Iron)

H. Okamoto and L.E. Tanner, 1992

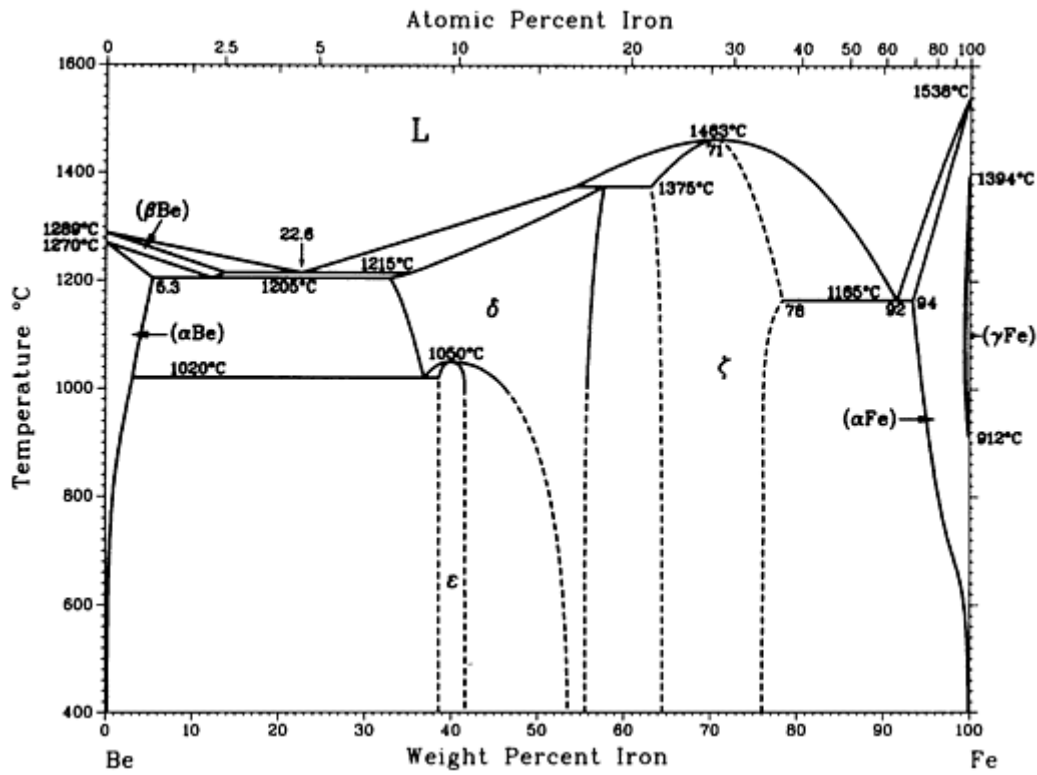

Be-Fe phase diagram

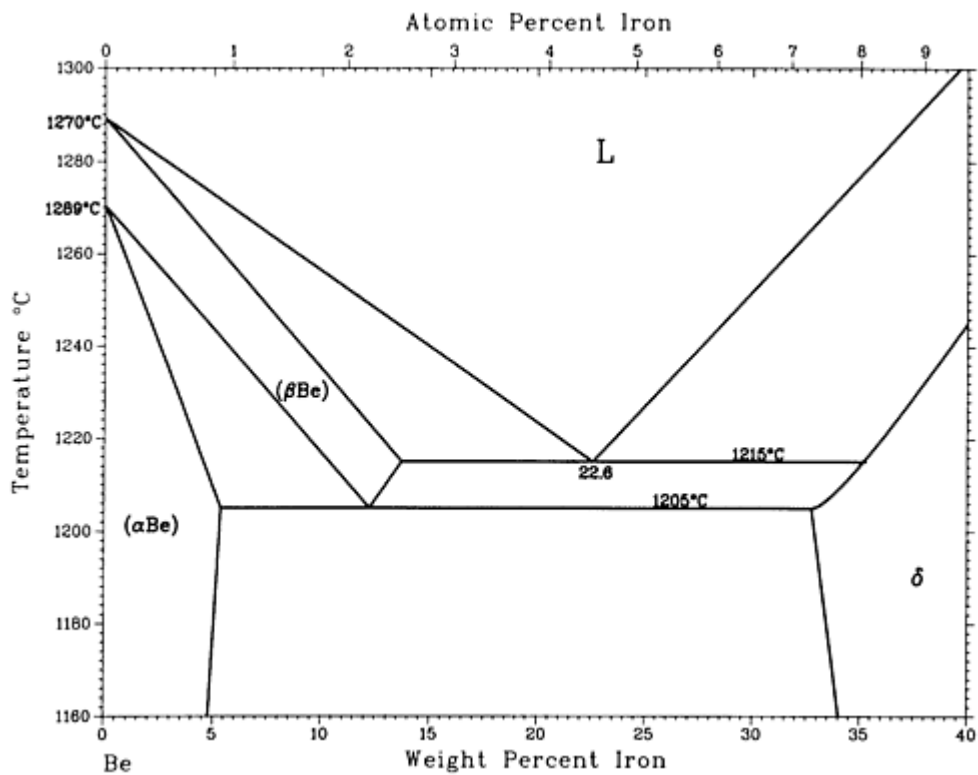

Be-rich portion of the Be-Fe phase diagram.

Be-Fe crystallographic data

Phase	Composition, wt% Fe	Pearson symbol	Space group
(β_{Be})	0 to 11	<i>cI2</i>	<i>Im$\bar{3}m$</i>
(α_{Be})	0 to 5.3	<i>hP2</i>	<i>P6$_3$/mmc</i>
ϵ	\sim 35 to 41	<i>hP19</i> <i>hP48</i>	<i>P6m2</i> <i>P6$_3$/mcm</i>
δ	32 to 58	<i>cF24</i>	<i>Fd$\bar{3}m$</i>
ζ	62 to 78	<i>hP12</i>	<i>P6$_3$/mmc</i>
(γ_{Fe})	99.7 to 100	<i>cF4</i>	<i>Fm$\bar{3}m$</i>
(α_{Fe})	94 to 100	<i>cI2</i>	<i>Im$\bar{3}m$</i>
Metastable phases			
...	\sim 86	<i>cF16</i>	<i>Fd$\bar{3}m$</i>
β	?	<i>cP2</i>	<i>Pm$\bar{3}m$</i>
BeF$_3$	\sim 95	<i>cF16</i>	<i>Fm$\bar{3}m$</i>

Be-Hf (Beryllium - Hafnium)

H. Okamoto and L.E. Tanner, 1987

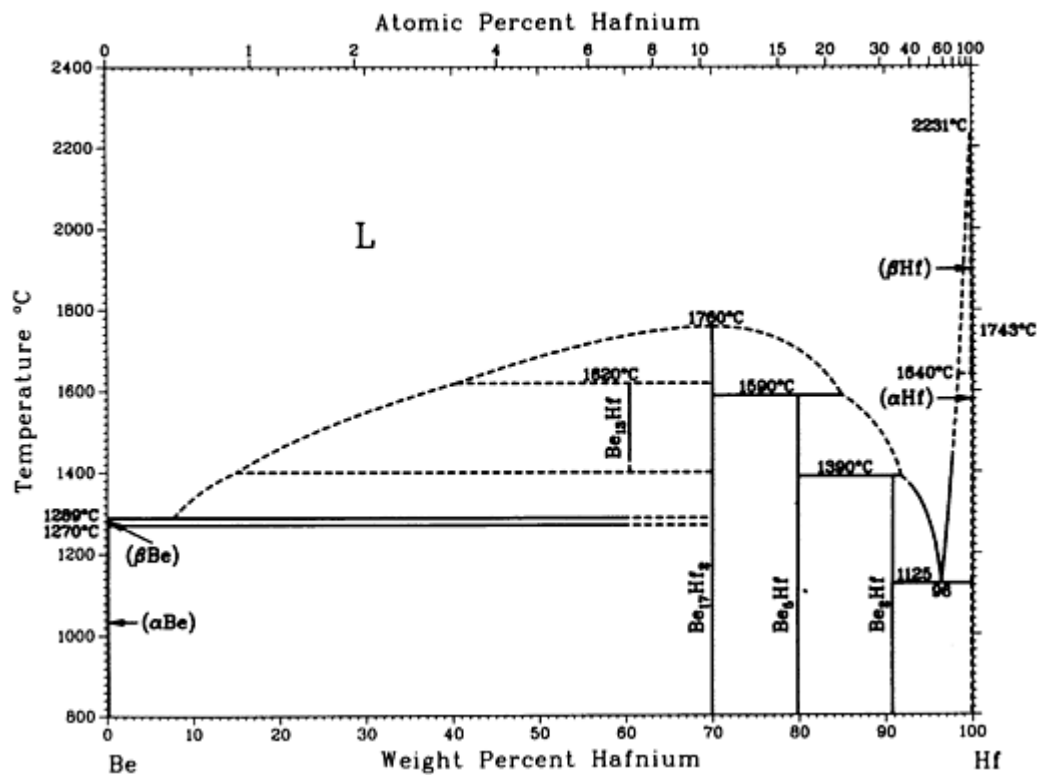

Be-Hf phase diagram

Be-Hf crystallographic data

Phase	Composition, wt% Hf	Pearson symbol	Space group
(βBe)	0	<i>cI2</i>	$Im\bar{3}m$
(αBe)	0	<i>hP2</i>	$P6_3/mmc$
Be_{13}Hf	60.2	<i>cF112</i>	$Fm\bar{3}c$
Be_{17}Hf	69.9	<i>hP*</i>	$P\bar{6}m2$
$(\alpha\text{Be}_{17}\text{Hf}_2)$	^(a)	<i>hR19</i>	$R\bar{3}m$
$(\beta\text{Be}_{17}\text{Hf}_2)$	^(b)	<i>hP38</i>	$P6_3/mmc$
Be_5Hf	79.9	<i>hP6</i>	$P6/mmm$

Be ₂ Hf	90.8	<i>hP3</i>	<i>P6/mmm</i>
(β Hf)	100	<i>cI2</i>	<i>Im\bar{3}m</i>
(α Hf)	100	<i>hP2</i>	<i>P6₃/mmc</i>
Metastable phases			
BeHf	95	<i>oC8</i>	<i>Cmcm</i>
α'	99.7 to 100 ^(c)

- (a) Be-poor side.
- (b) Be-rich side.
- (c) Acicular martensite

Be-Nb (Beryllium - Niobium)

H. Okamoto and L.E. Tanner, 1987

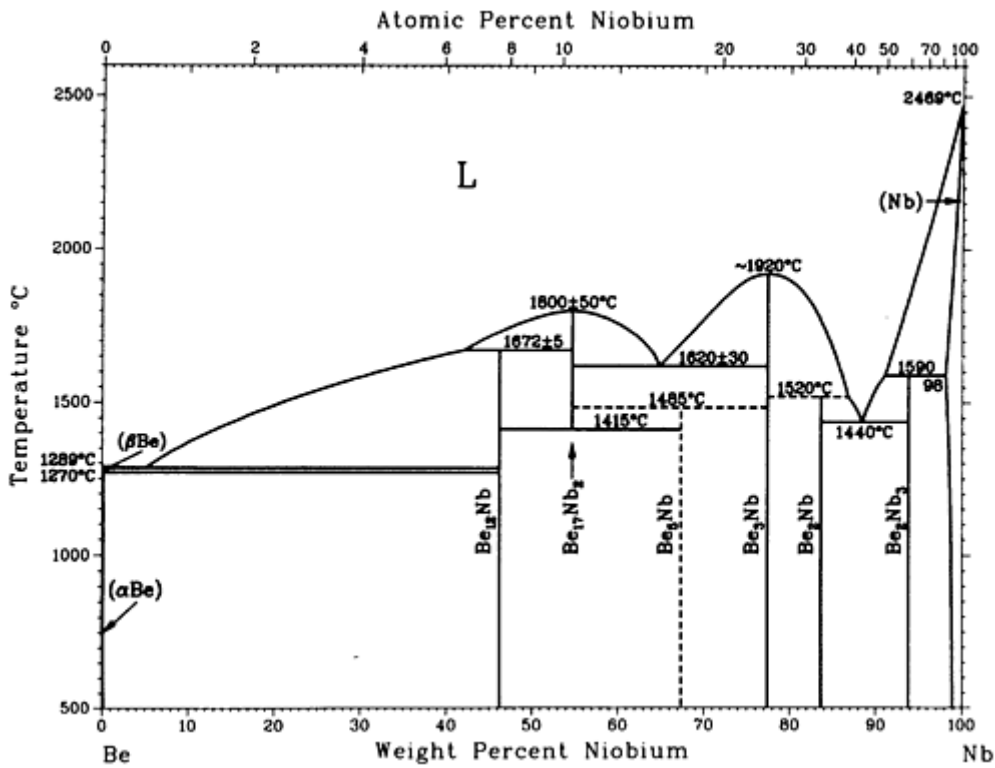

Be-Nb phase diagram

Be-Nb crystallographic data

Phase	Composition, wt% Nb	Pearson symbol	Space group
(β _B)	0	<i>cI2</i>	<i>Im</i> $\bar{3}m$
(α Be)	0	<i>hP2</i>	<i>P6</i> ₃ / <i>mmc</i>
Be ₁₂ Nb	46.2	<i>tI26</i>	<i>I4/mmm</i>
Be ₁₇ Nb ₂	54.7	<i>hR19</i>	<i>R</i> $\bar{3}m$
(a)	56.3	<i>hP*</i>	...
Be ₅ Nb	67.4	<i>hP6</i>	<i>P6/mmm</i>
Be ₃ Nb	77	<i>hR12</i>	<i>R</i> $\bar{3}m$
(b)	83.7	<i>hP*</i>	...
Be ₂ Nb	83.7 83.7 83.73	<i>cF24</i>	<i>Fd</i> $\bar{3}m$
Be ₂ Nb ₃	94	<i>tP10</i>	<i>P4/mbm</i>
(Nb)	98.6 to 100	<i>cI2</i>	<i>Im</i> $\bar{3}m$

(a) Proposed as Be₈Nb.

(b) Reported as Be₂Nb

Be-Ni (Beryllium - Nickel)

H. Okamoto and L.E. Tanner, 1991

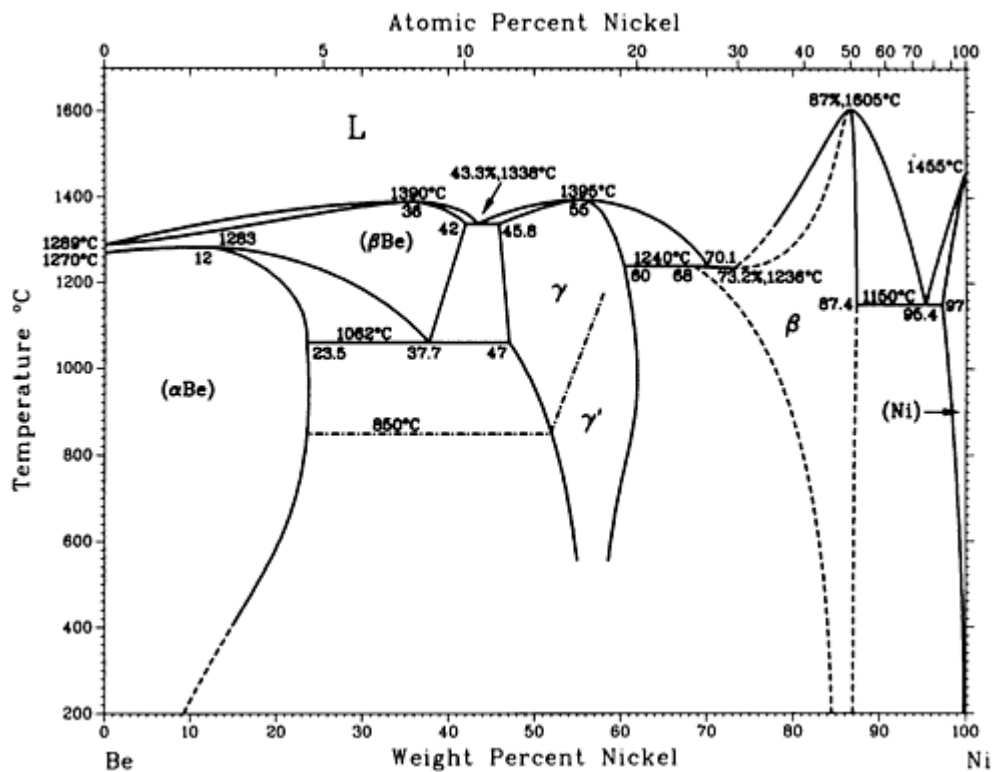

Be-Ni phase diagram

Be-Ni crystallographic data

Phase	Composition, wt% Ni	Pearson symbol	Space group
(β _{Be})	0 to 23.5	cI2	$Im\bar{3}m$
(α _{Be})	0 to 42	hP2	$P6_3/mmc$
γ	45.8 to >51	cI52	$I\bar{4}3m$
γ'	51 to 62	cF416	$F23$
β	68 to 87.4	cP2	$Pm\bar{3}m$
(Ni)	95.4 to 100	cF4	$Fm\bar{3}m$
Metastable phases			

?	92.2 to 93.4	o^{**}	?
β	>87 to <95	tI^*	?
γ 'BeNi ₃	95	?	?

Be-Pd (Beryllium - Palladium)

H. Okamoto and L.E. Tanner, 1987

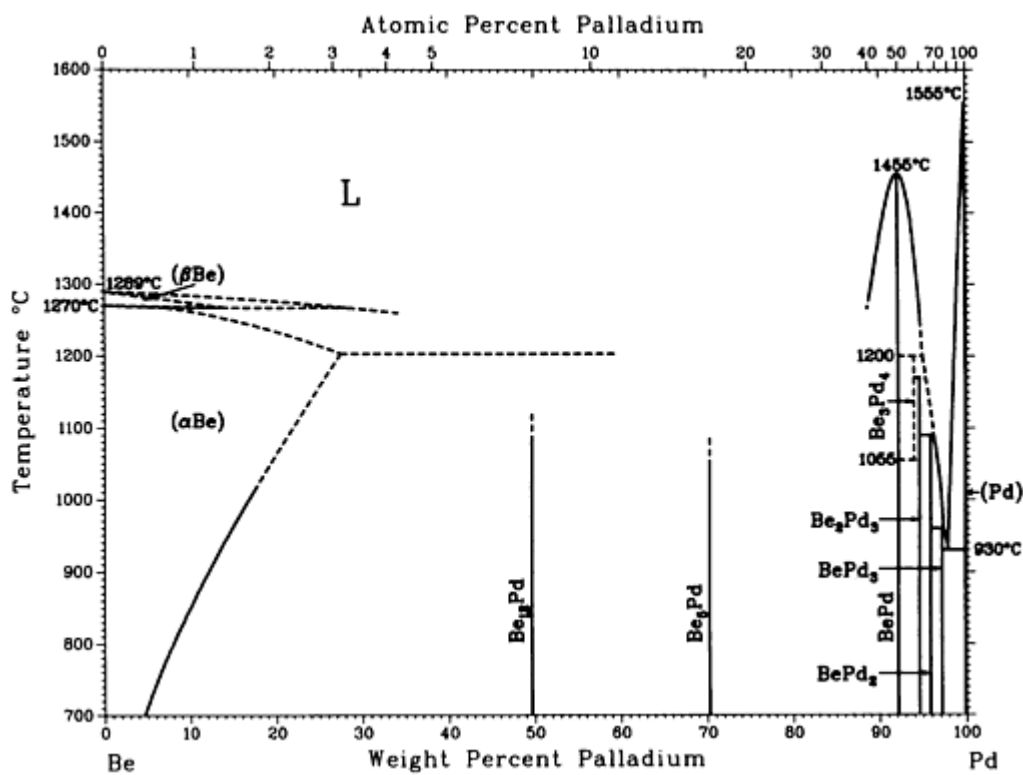

Be-Pd phase diagram

Be-Pd crystallographic data

Phase	Composition, wt% Pd	Pearson symbol	Space group
(β_{Be})	0	$cI2$	$Im\bar{3}m$
(α_{Be})	0 to 38	$hP2$	$P6_3/mmc$
$Be_{12}Pd$	49.6	$tI26$	$I4/mmm$

Be ₅ Pd	70.3	<i>cF24</i>	<i>F$\bar{4}3m$</i>
BePd	92	<i>cP2</i>	<i>Pm$\bar{3}m$</i>
Be ₃ Pd ₄	94.0	?	?
Be ₂ Pd ₃	95	?	?
BePd ₂	95.9	?	?
BePd ₃	97	(a)	?
(Pd)	99.9 to 100	<i>cF4</i>	<i>Fm$\bar{3}m$</i>

(a) Orthorhombic

Be-Si (Beryllium - Silicon)

H. Okamoto and L.E. Tanner, 1987

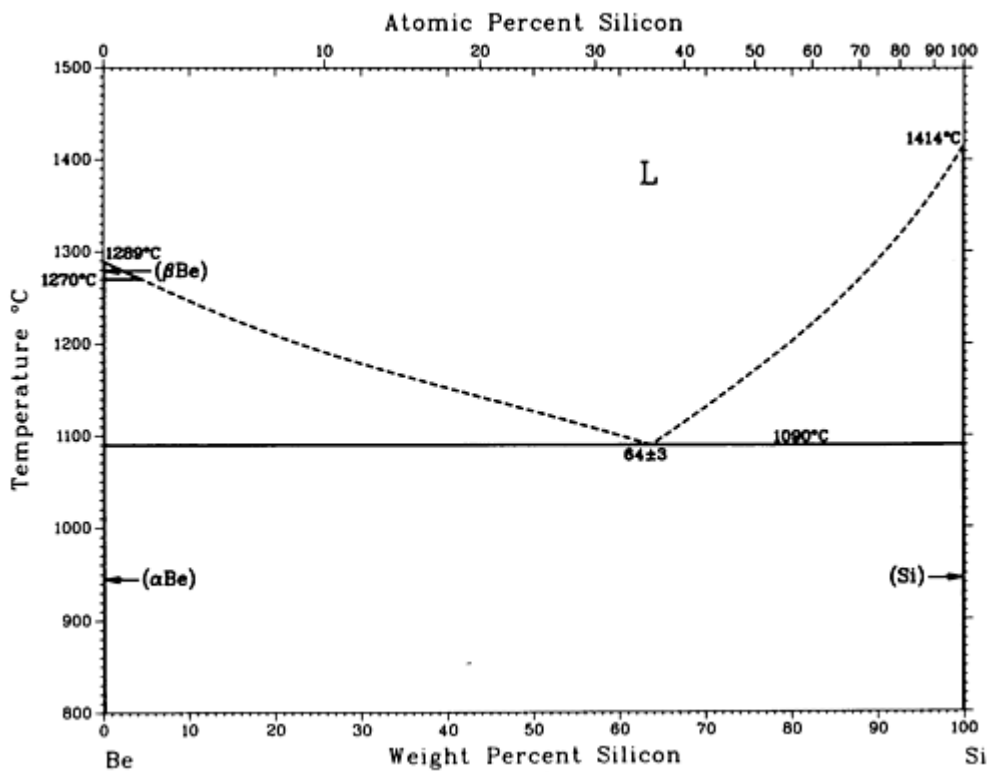

Be-Si phase diagram

Be-Si crystallographic data

Phase	Composition, wt% Si	Pearson symbol	Space group
(β Be)	0	<i>cI2</i>	<i>Im$\bar{3}m$</i>
(α Be)	0	<i>hP2</i>	<i>P6$_3$/mmc</i>
(Si)	100	<i>cF8</i>	<i>Fd$\bar{3}m$</i>

Be-Th (Beryllium - Thorium)

H. Okamoto, L.E. Tanner, and D.E. Peterson, 1987

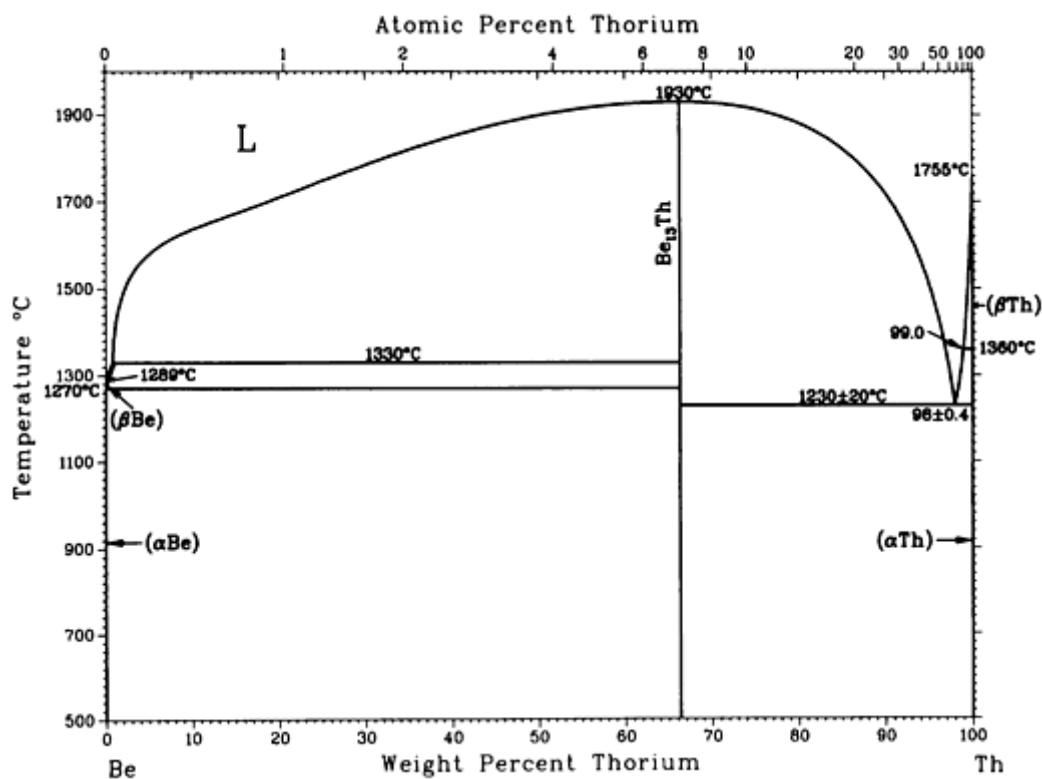

Be-Th phase diagram

Be-Th crystallographic data

Phase	Composition, wt% Th	Pearson symbol	Space group
(β Be)	0	<i>cI2</i>	<i>Im$\bar{3}m$</i>

(α Be)	0	<i>hP2</i>	<i>P6₃/mmc</i>
Be ₁₃ Th	66.44	<i>cF112</i>	<i>Fm$\bar{3}c$</i>
(β Th)	100	<i>cI2</i>	<i>Im$\bar{3}m$</i>
(α Th)	100	<i>cF4</i>	<i>Fm$\bar{3}m$</i>

Be-Ti (Beryllium - Titanium)

J.L. Murray, 1987

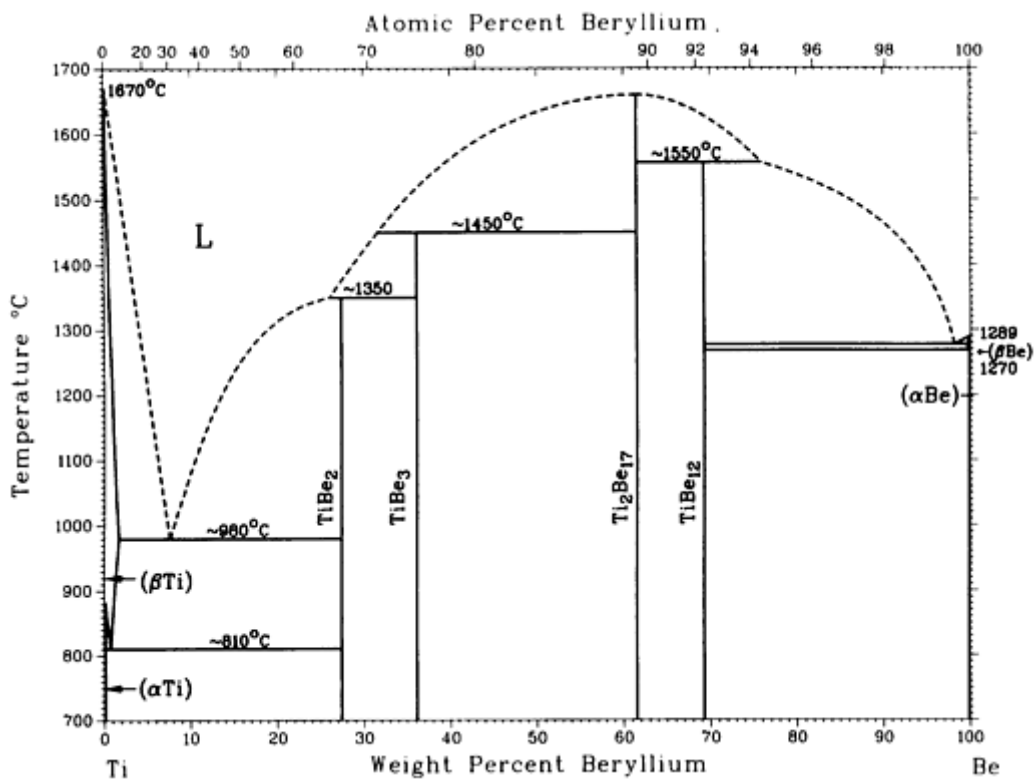

Be-Ti phase diagram

Be-Ti crystallographic data

Phase	Composition, wt% Be	Pearson symbol	Space group
(β Ti)	0 to ~1.5	<i>cI2</i>	<i>Im$\bar{3}m$</i>
(α Ti)	~0	<i>hP2</i>	<i>P6₃/mmc</i>

TiBe ₂	27.4	<i>cF24</i>	<i>Fd$\bar{3}m$</i>
TiBe ₃	36	<i>hR12</i>	<i>R$\bar{3}m$</i>
α Ti ₂ Be ₁₇	61.6	<i>hR19</i>	<i>R$\bar{3}m$</i>
β Ti ₂ Be ₁₇	61.6	<i>hP38</i>	<i>P6₃/mmc</i>
TiBe ₁₂	69.3	<i>tI26</i>	<i>I4/mmm</i>
TiBe ^(a)	~16	<i>cP2</i>	<i>Pm$\bar{3}m$</i>
(β Be)	~100	<i>cI2</i>	<i>Im$\bar{3}m$</i>
(α Be)	~100	<i>hP2</i>	<i>P6₃/mmc</i>

(a) Metastable

Be-W (Beryllium - Tungsten)

H. Okamoto and L.E. Tanner, 1987

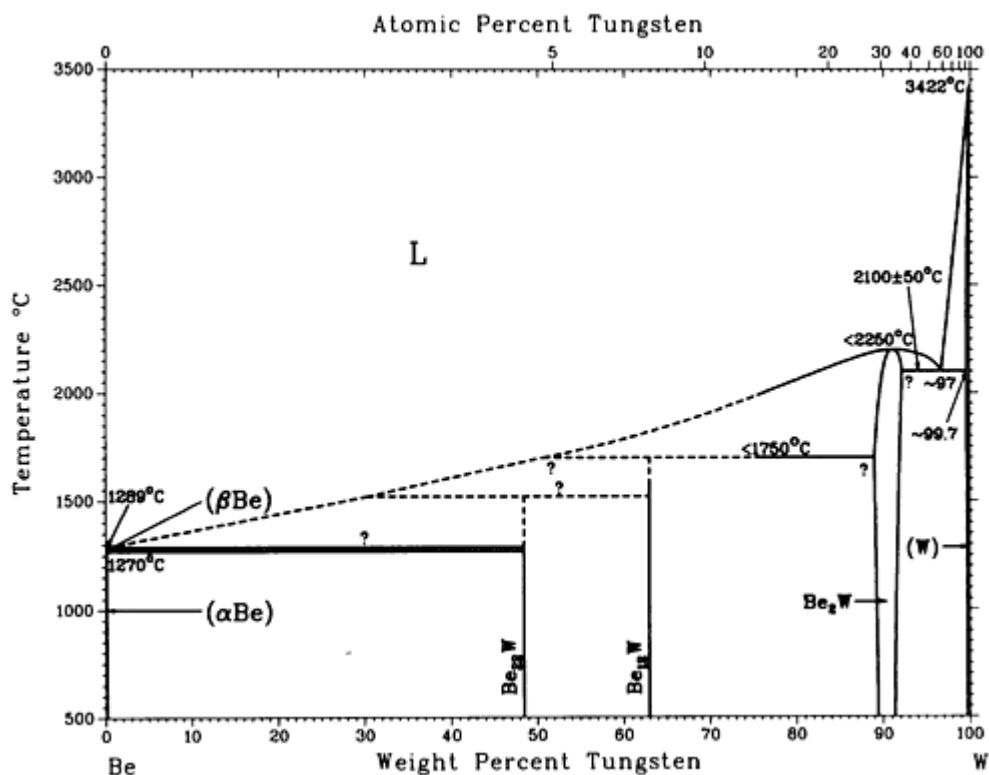

Be-W phase diagram

Be-W crystallographic data

Phase	Composition, wt% W	Pearson symbol	Space group
(βBe)	0	<i>cI2</i>	<i>Im</i> $\bar{3}m$
(αBe)	0	<i>hP2</i>	<i>P6₃/mmc</i>
Be ₂₄ W ^(a)	46	^(b)	...
Be ₂₂ W	47.8	<i>cF184</i>	<i>Fd</i> $\bar{3}m$
Be ₁₂ W	63.0	<i>tI26</i>	<i>I4/mmm</i>
Be ₂ W	~89 to ~92	<i>hP12</i>	<i>P6₃/mmc</i>
(W)	~99.7 to 100	<i>cI2</i>	<i>Im</i> $\bar{3}m$

(a) Not accepted in the assessed phase diagram.

(b) Tetragonal

Be-Zr (Beryllium - Zirconium)

H. Okamoto, L.E. Tanner, and J.P. Abriata, 1987

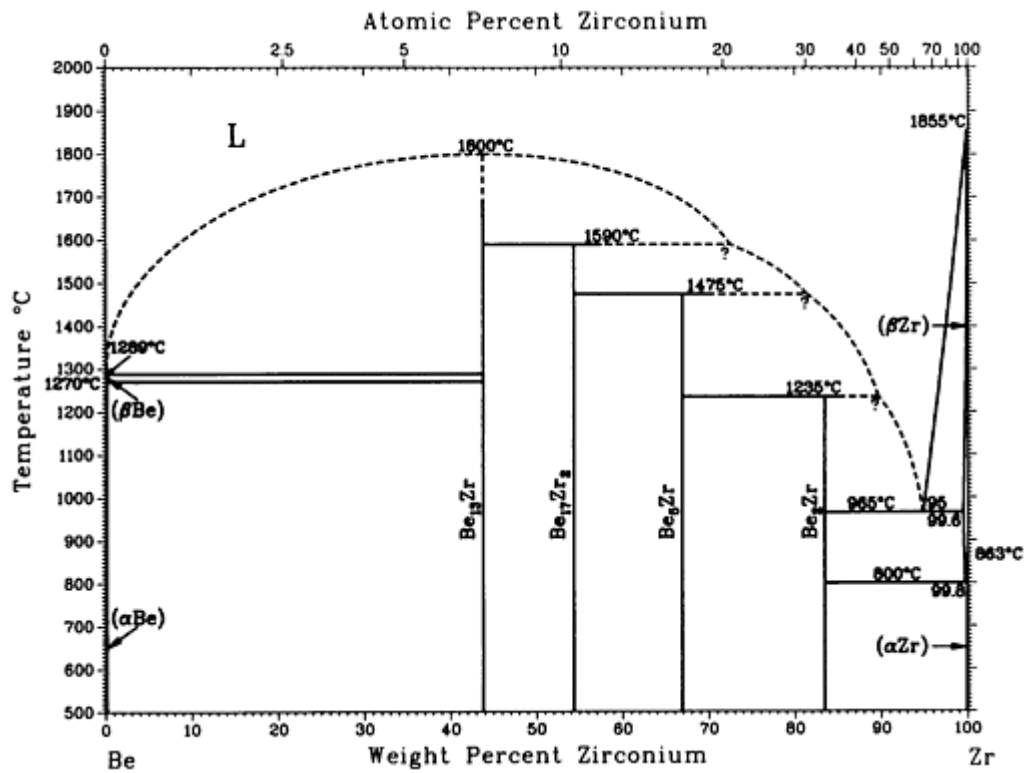

Be-Zr phase diagram

Be-Zr crystallographic data

Phase	Composition, wt% Zr	Pearson symbol	Space group
(βBe)	0	<i>cI2</i>	<i>Im</i> $\bar{3}m$
(αBe)	0	<i>hP2</i>	<i>P6</i> ₃ / <i>mmc</i>
Be ₁₃ Zr	43.6	<i>cF112</i>	<i>Fm</i> $\bar{3}c$
Be ₁₂ Zr ^(a)	43.6	<i>tI*</i>	...

$\text{Be}_{17}\text{Zr}_2$	54.3	<i>hR19</i>	$R\bar{3}m$
Be_5Zr	67.0	<i>hP6</i>	$P6/mmm$
Be_2Zr	83.5	<i>hP3</i>	$P6/mmm$
(β_{Zr})	100	<i>cI2</i>	$Im\bar{3}m$
(α_{Zr})	100	<i>hP2</i>	$P6_3/mmc$
Metastable phases			
BeZr	91	<i>oC8</i>	$Cmcm$
α'	99 to 100	^(b)	...

(a) Not accepted in the assessed diagram.

(b) Acicular martensite

Bi (Bismuth) Binary Alloy Phase Diagrams

Introduction

THIS ARTICLE includes systems where bismuth is the first-named element in the binary pair. Additional binary systems that include bismuth are provided in the following locations in this Volume:

- “Ag-Bi (Silver - Bismuth)” in the article “Ag (Silver) Binary Alloy Phase Diagrams.”
- “Al-Bi (Aluminum - Bismuth)” in the article “Al (Aluminum) Binary Alloy Phase Diagrams.”
- “As-Bi (Arsenic - Bismuth)” in the article “As (Arsenic) Binary Alloy Phase Diagrams.”
- “Au-Bi (Gold - Bismuth)” in the article “Au (Gold) Binary Alloy Phase Diagrams.”

Bi-Ca (Bismuth - Calcium)

H. Okamoto, 1991

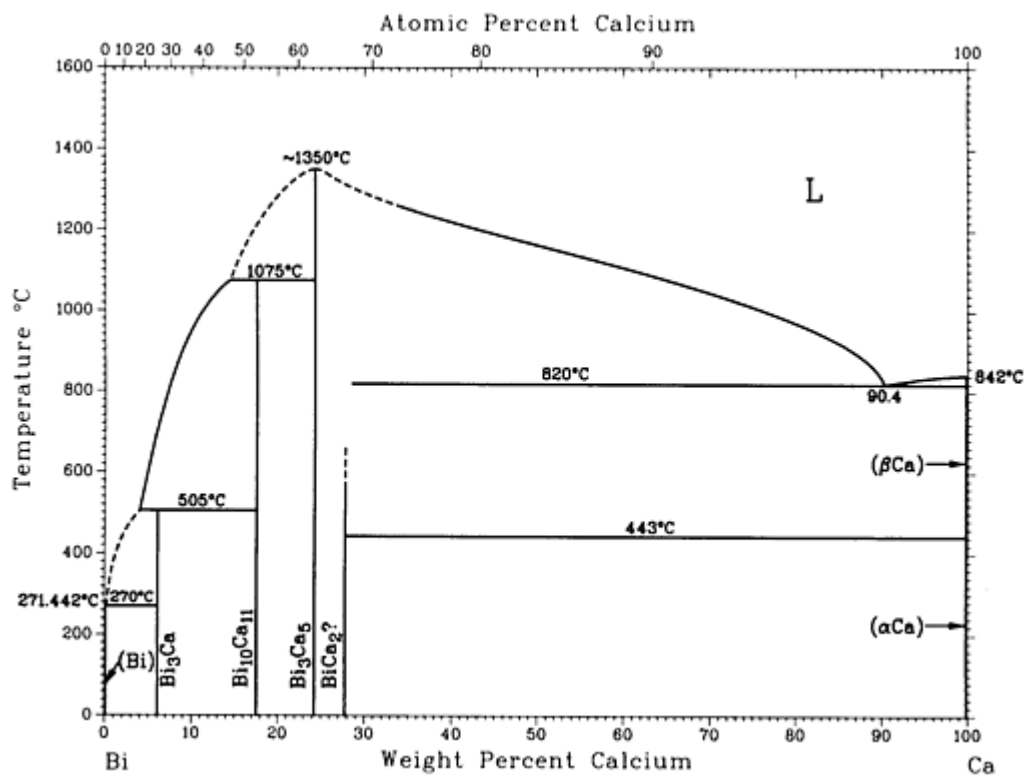

Bi-Ca phase diagram

Bi-Ca crystallographic data

Phase	Composition, wt% Ca	Pearson symbol	Space group
(Bi)	0	<i>hR2</i>	$R\bar{3}m$
Bi ₃ Ca	6
Bi ₁₀ Ca ₁₁	17.4	<i>tI84</i>	<i>I4/mmm</i>
Bi ₃ Ca ₅	24.2	<i>oP32</i>	<i>Pnma</i>
BiCa ₂	27.8	<i>tI12</i>	<i>I4/mmm</i>
(alpha-Ca)	100	<i>cF4</i>	$Fm\bar{3}m$
(beta-Ca)	100	<i>cI2</i>	$Im\bar{3}m$

Bi-Cd (Bismuth - Cadmium)

Z. Moser, J. Dutkiewicz, L. Zabdyr, and J. Salawa, 1988

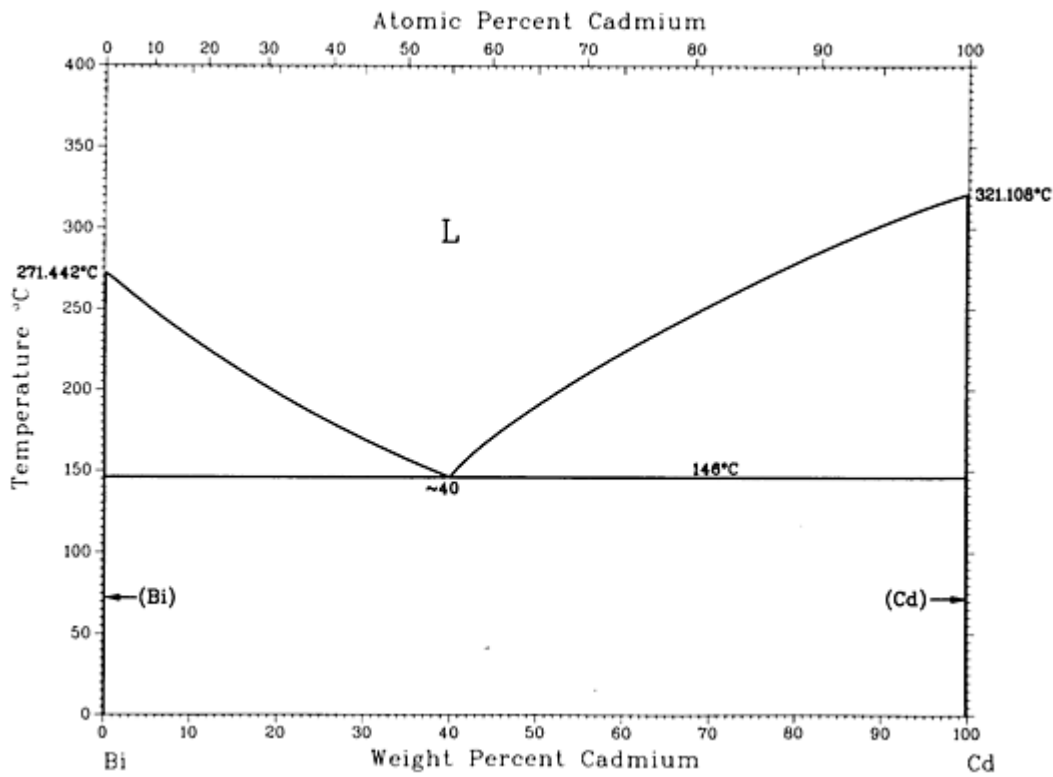

Bi-Cd phase diagram

Bi-Cd crystallographic data

Phase	Composition, wt% Cd	Pearson symbol	Space group
(Bi)	0	<i>hR2</i>	$R\bar{3}m$
(Cd)	100	<i>hP2</i>	$P6_3/mmc$

Bi-Cs (Bismuth - Cesium)

J. Sangster and A.D. Pelton, 1991

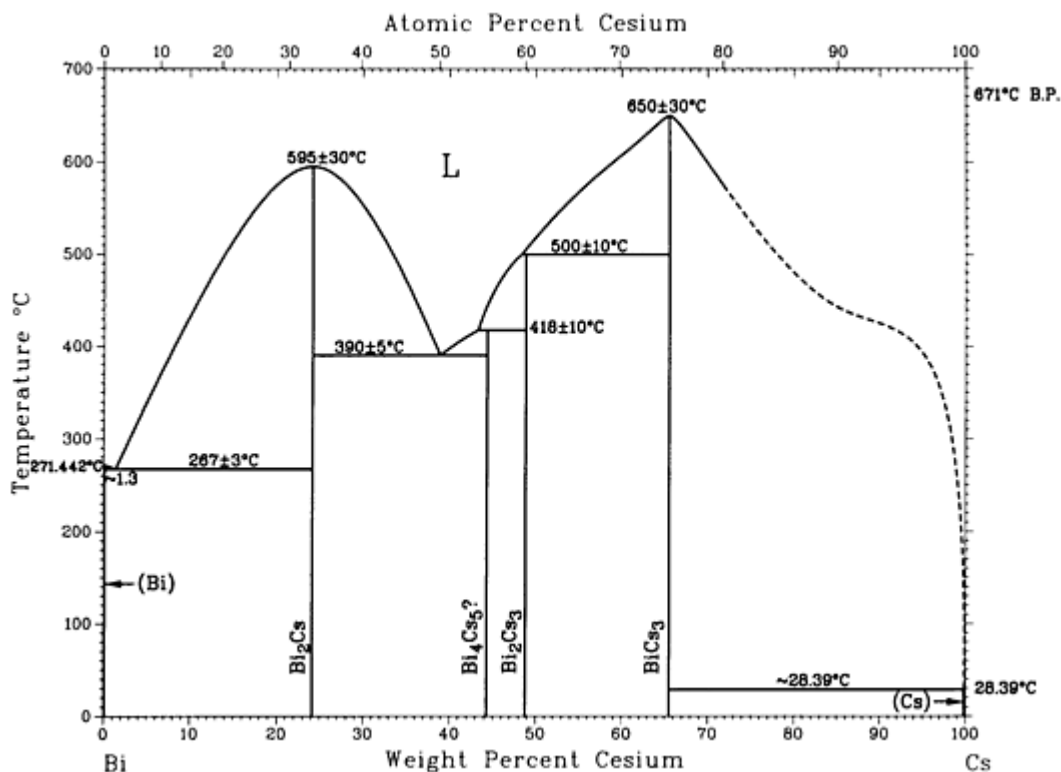

Bi-Cs phase diagram

Bi-Cs crystallographic data

Phase	Composition, wt% Cs	Pearson symbol	Space group
(α Bi)	0	<i>hR2</i>	$R\bar{3}m$
Bi_2Cs	24.1	<i>cF24</i>	$Fd\bar{3}m$
$\text{Bi}_4\text{Cs}_5(?)$	44.3
Bi_2Cs_3	49
BiCs_3	66 66	<i>cF16</i> <i>cF16</i>	$Fd\bar{3}m$ $Fm\bar{3}m$
(Cs)	100	<i>cI2</i>	$Im\bar{3}m$

Bi-Cu (Bismuth - Copper)

D.J. Chakrabarti and D.E. Laughlin, 1984

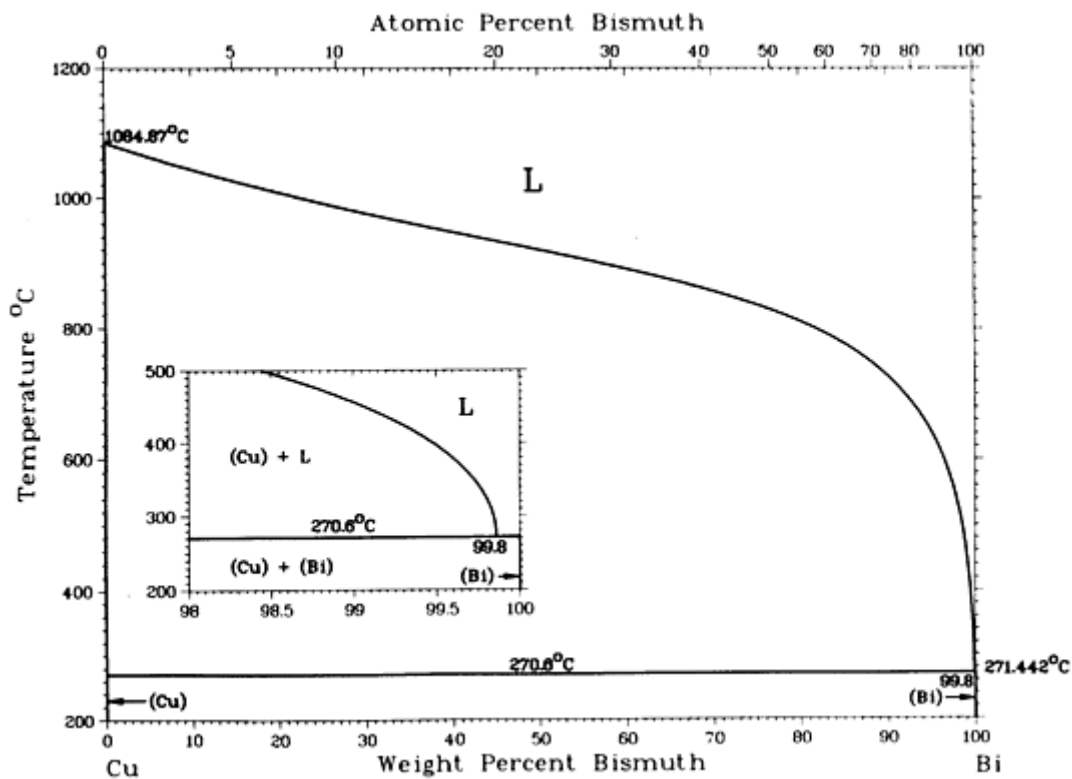

Bi-Cu phase diagram

Bi-Cu crystallographic data

Phase	Composition, wt% Bi	Pearson symbol	Space group
(Cu)	0 to 0.010	$cF4$	$Fm\bar{3}m$
(Bi)	100	$hR2$	$R\bar{3}m$
Metastable phase			
Cu_5Bi_2	57

Bi-Ga (Bismuth - Gallium)

H. Okamoto, 1990

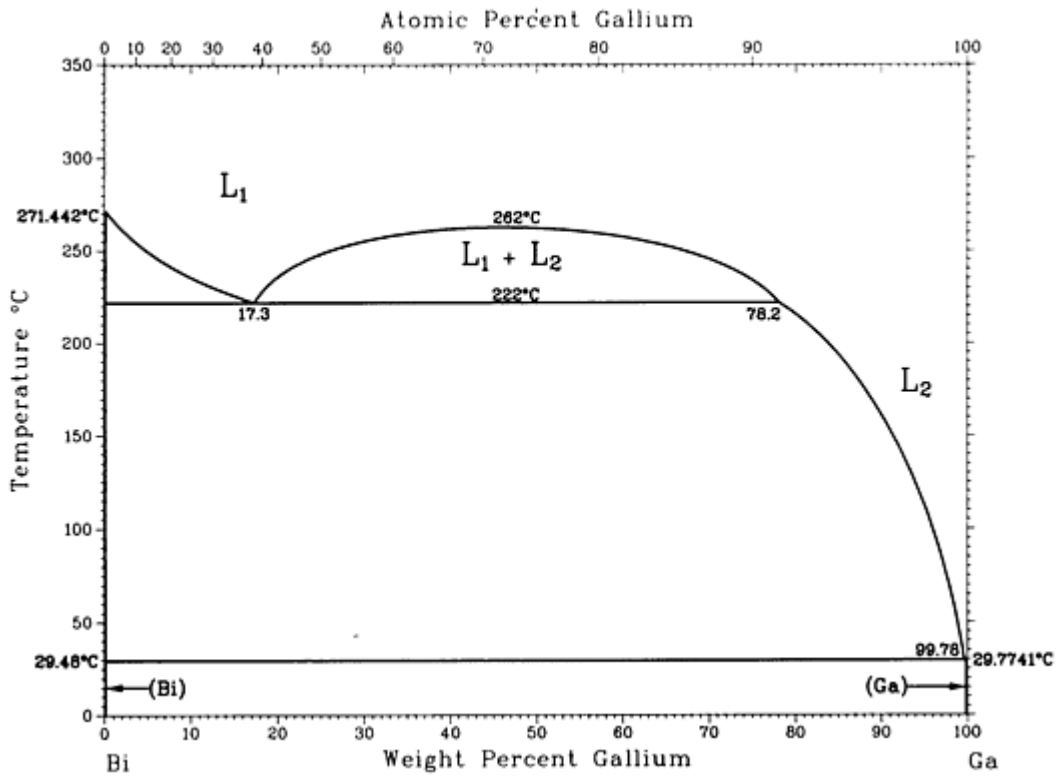

Bi-Ga phase diagram

Bi-Ga crystallographic data

Phase	Composition, wt% Ga	Pearson symbol	Space group
(Bi)	~0	<i>hR2</i>	$R\bar{3}m$
(Ga)	~100	<i>oC8</i>	<i>Cmca</i>

Bi-Ge (Bismuth - Germanium)

R.W. Olesinski and G.J. Abbaschian, 1986

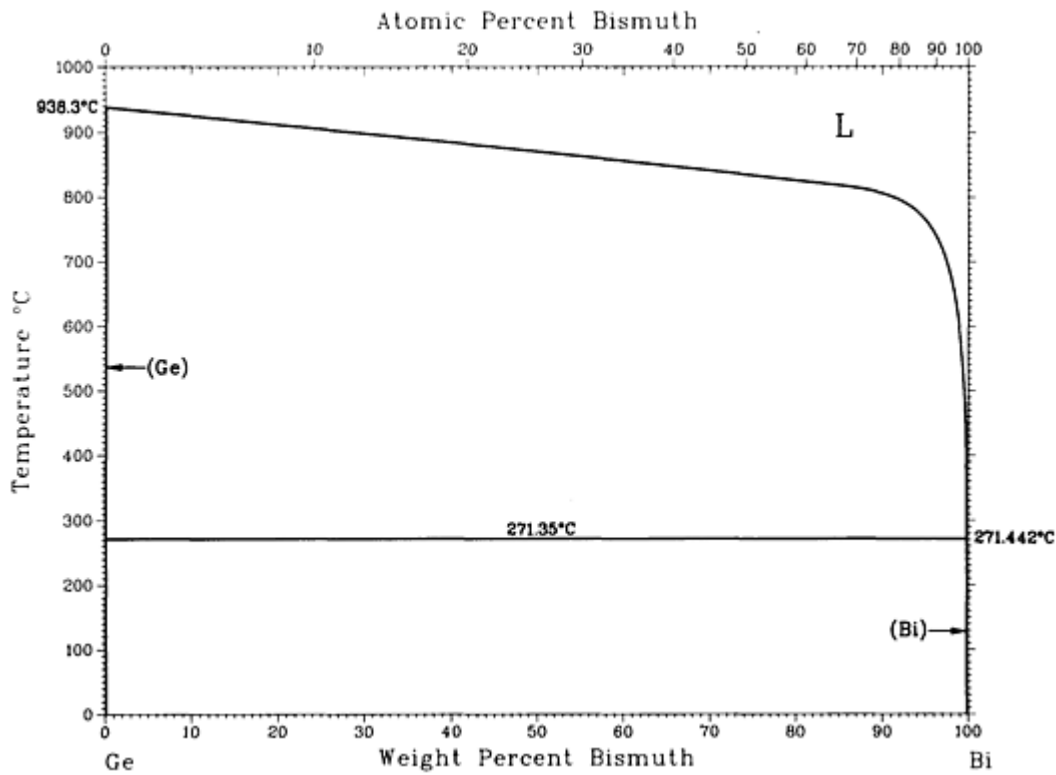

Bi-Ge phase diagram

Bi-Ge crystallographic data

Phase	Composition, wt% Bi	Pearson symbol	Space group
(Ge)	0	<i>cF8</i>	$Fd\bar{3}m$
(GeII)(HP)	0	<i>tI4</i>	$I4_1/amd$
(Bi)	100	<i>hR2</i>	$R\bar{3}m$

Bi-Hg (Bismuth - Mercury)

L. Zabdyr and C. Guminski, unpublished

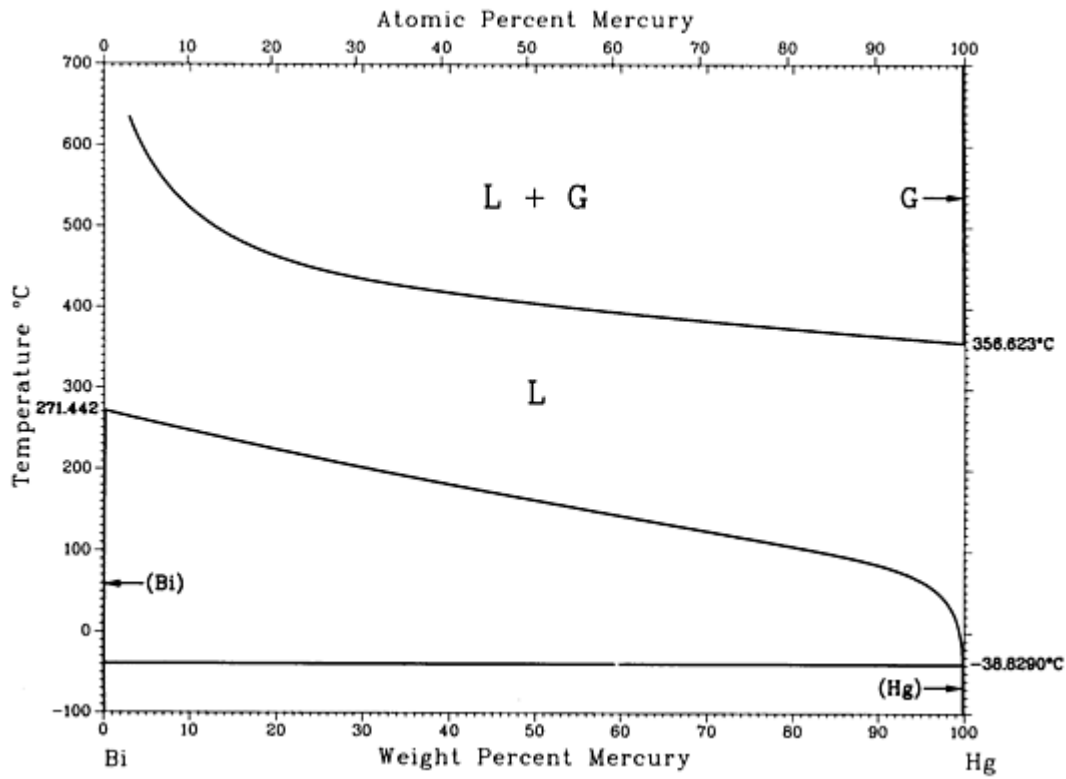

Bi-Hg phase diagram

Bi-Hg crystallographic data

Phase	Composition, wt% Hg	Pearson symbol	Space group
(Bi)	0	<i>hR2</i>	$R\bar{3}m$
(Hg)	100	<i>hR1</i>	$R\bar{3}m$

Bi-In (Bismuth - Indium)

H. Okamoto, 1992

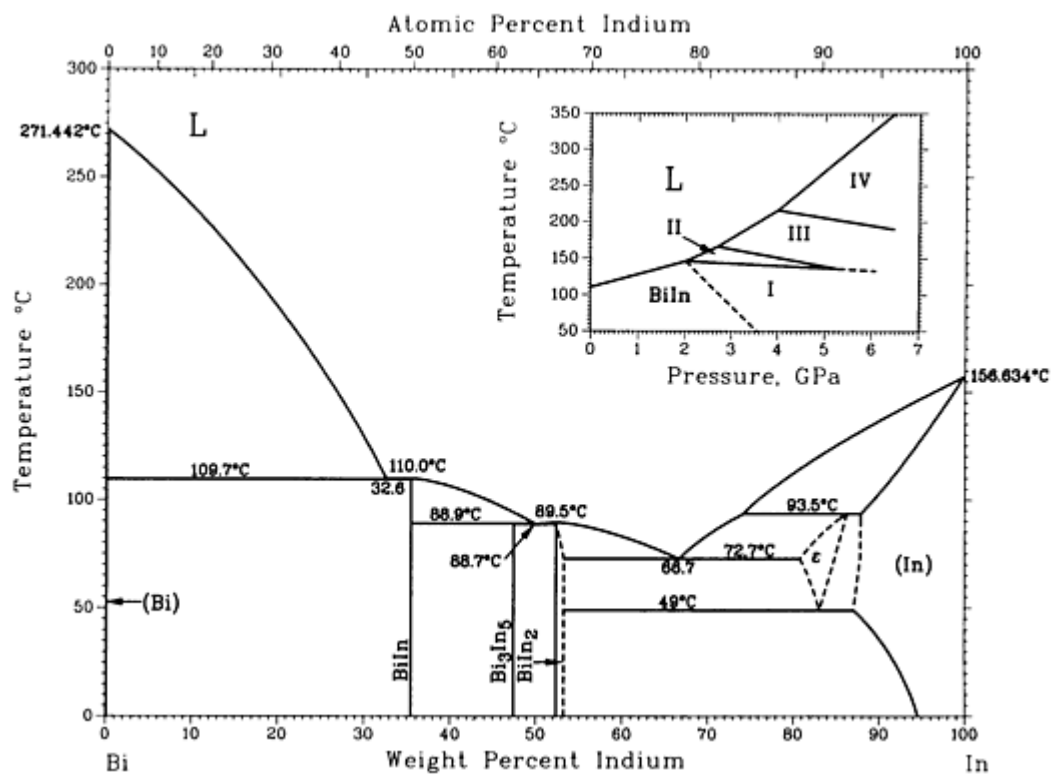

Bi-In phase diagram

Bi-In crystallographic data

Phase	Composition, wt% In	Pearson symbol	Space group
Stable phases			
(α Bi)	0 to 0.005	<i>hR2</i>	$R\bar{3}m$
BiIn	35.4	<i>tP4</i>	<i>P4/nmm</i>
Bi ₃ In ₅	47.5 to 47.97	<i>tI32</i>	<i>I4/mcm</i>
BiIn ₂	52.5 to 53.5	<i>hP6</i>	<i>P6₃/mmc</i>
ϵ	80 to 86	<i>tI2</i>	...
(In)	~86 to 100	<i>tI2</i>	<i>I4/mmm</i>

High-pressure/metastable phases			
(γ_{Bi})	0	$mP4$	$P2_1/m$
(β_{Bi})	0	$mC4$	$C2/m$
Bi_4In	12	$tI4$	$I4_1/amd$
Bi_3In	~ 15	oI^*	$Immb$
γ	12 to 42	$hP1$	$P6/mmm$
γ_1	21 to 35.4	oI^*	...
γ_2	21 to 35.4	oI^*	...
X	21 to 35.4	oI^*	...
BiIn'	35.4	$tP4$	$P4/nmm$
α_2	45 to 51	$cI2$	$Im\bar{3}m$
$\text{Bi}_2\text{In}_3^{(a)}$	45	hP^*	...
BiIn_3	62	t^{**}	...
α_1	~ 59 to 76	$tI2$	$I4/mmm$

(a) Thin film. Probably Bi_3In_5

Bi-K (Bismuth - Potassium)

A. Petric and A.D. Pelton, 1991

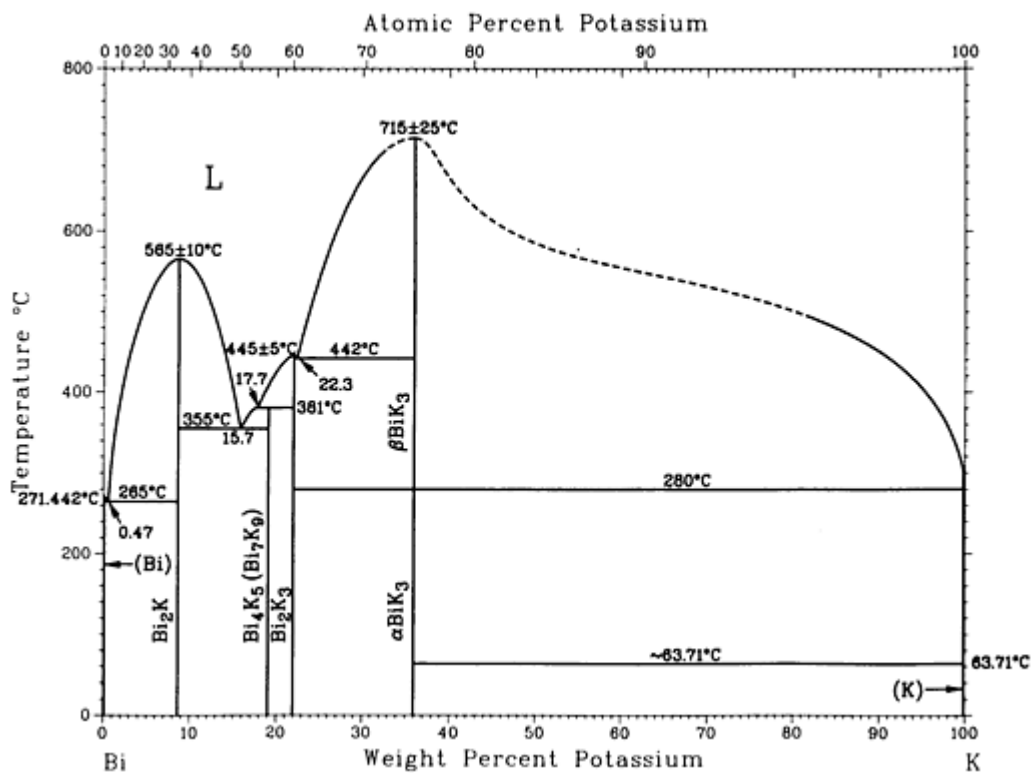

Bi-K phase diagram

Bi-K crystallographic data

Phase	Composition, wt% K	Pearson symbol	Space group
(Bi)	0	<i>hR2</i>	$R\bar{3}m$
Bi ₂ K	8.5	<i>cF24</i>	$Fd\bar{3}m$
BiK ₅ ^(a)	19.0
Bi ₂ K ₃	22
αBiK ₃ ^(b)	36	<i>hP8</i>	$P6_3/mmc$
βBiK ₃ ^(c)	36	<i>cF16</i>	$Fm\bar{3}m$
(K)	100	<i>cI2</i>	$Im\bar{3}m$

- (a) Might be Bi_7K_9 .
- (b) Stable below 280 °C.
- (c) Stable above 280 °C

Bi-La (Bismuth - Lanthanum)

K.A. Gschneidner, Jr. and F.W. Calderwood, 1989

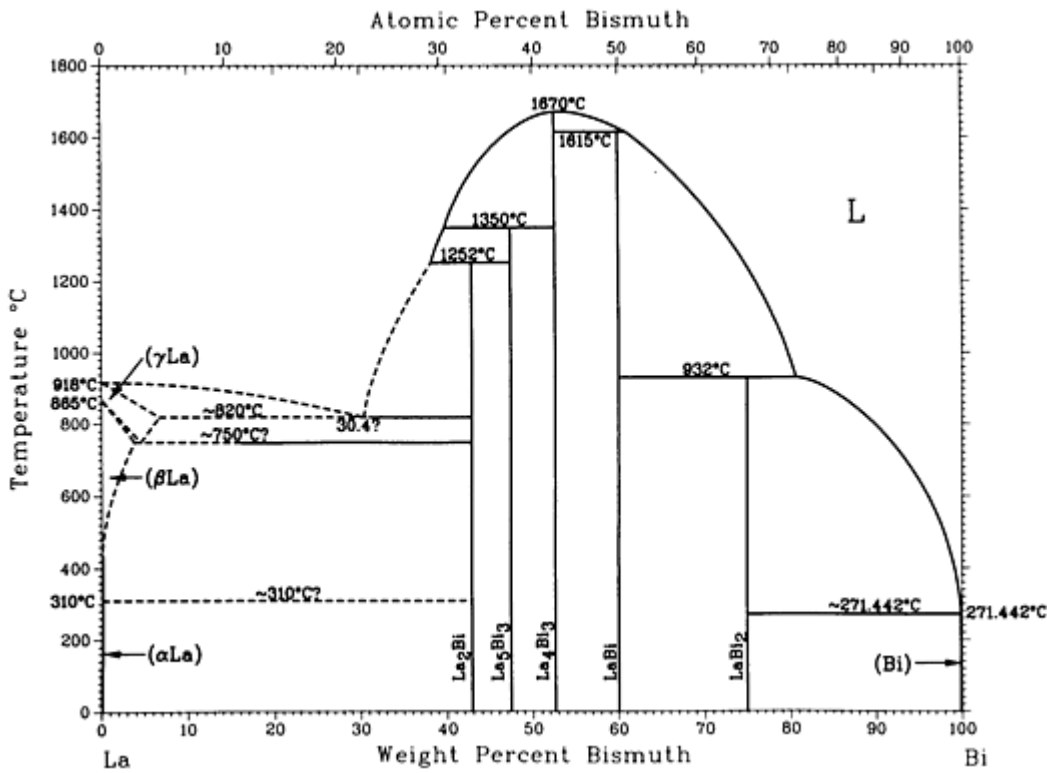

Bi-La phase diagram

Bi-La crystallographic data

Phase	Composition, wt% Bi	Pearson symbol	Space group
(γLa)	0 to?	<i>cI2</i>	$Im\bar{3}m$
(βLa)	0 to?	<i>cF4</i>	$Fm\bar{3}m$
(αLa)	0	<i>hP4</i>	$P6_3/mmc$

La ₂ Bi	42.9	<i>tI12</i>	<i>I4/mmm</i>
La ₅ Bi ₃	47.4	<i>hP16</i>	<i>P6₃/mcm</i>
La ₄ Bi ₃	53.1	<i>cI28</i>	<i>I4⁻3d</i>
LaBi	60.1	<i>cF8</i>	<i>Fm3⁻m</i>
LaBi ₂ ^(a)	75.1	<i>o?12</i>	...
LaBi ₂ ^(a)	75.1	<i>aP27(?)</i>	<i>P1</i> or <i>P1⁻</i>
(αBi)	100	<i>hR2</i>	<i>R3⁻m</i>

(a) Conflicting reports regarding LaBi₂ structure

Bi-Li (Bismuth - Lithium)

J. Sangster and A.D. Pelton, 1991

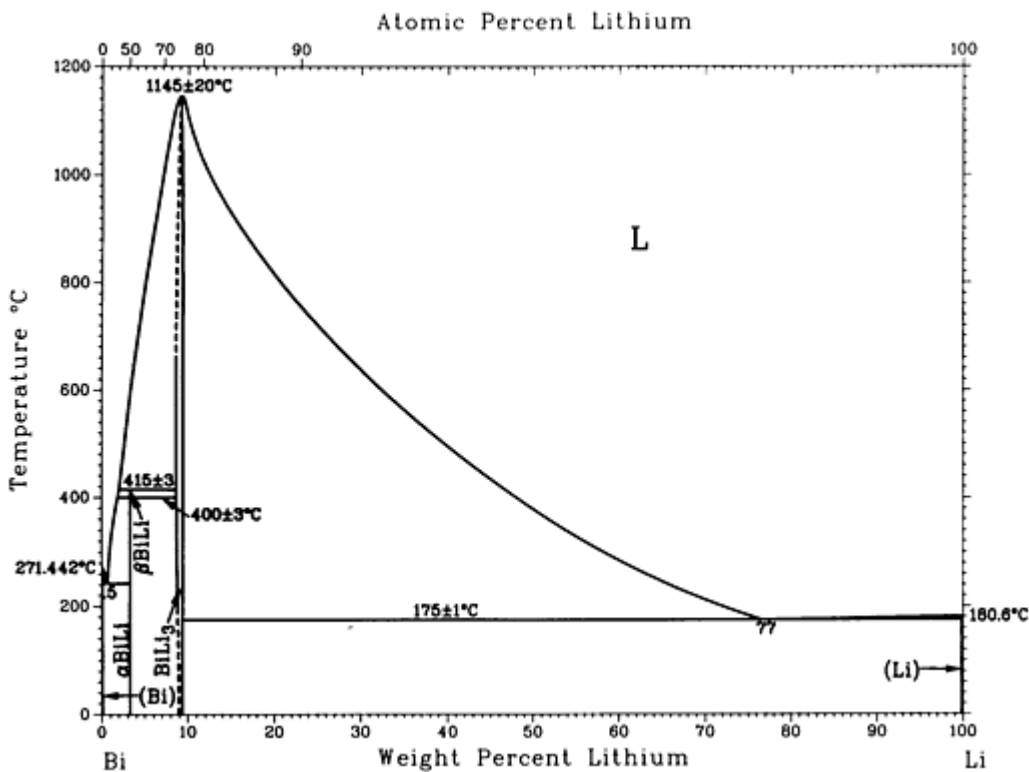

Bi-Li phase diagram

Bi-Li crystallographic data

Phase	Composition, wt% Li	Pearson symbol	Space group
(α Li)	0	<i>hR2</i>	$R\bar{3}m$
α BiLi ^(a)	3.2	<i>tP4</i>	<i>P4/mmm</i>
β BiLi	3.2
BiLi ₃	8.6 to 9.2 ^(b)	<i>cF16</i>	<i>Fm\bar{3}m</i>
(α Li) ^(c)	100	<i>hP2</i>	<i>P6₃/mmc</i>
(β Li)	100	<i>cI2</i>	<i>Im\bar{3}m</i>

(a) Below 415 °C.

(b) At 380 °C.

(c) Below -201 °C

Bi-Mg (Bismuth - Magnesium)

A.A. Nayeb-Hashemi and J.B. Clark, 1988

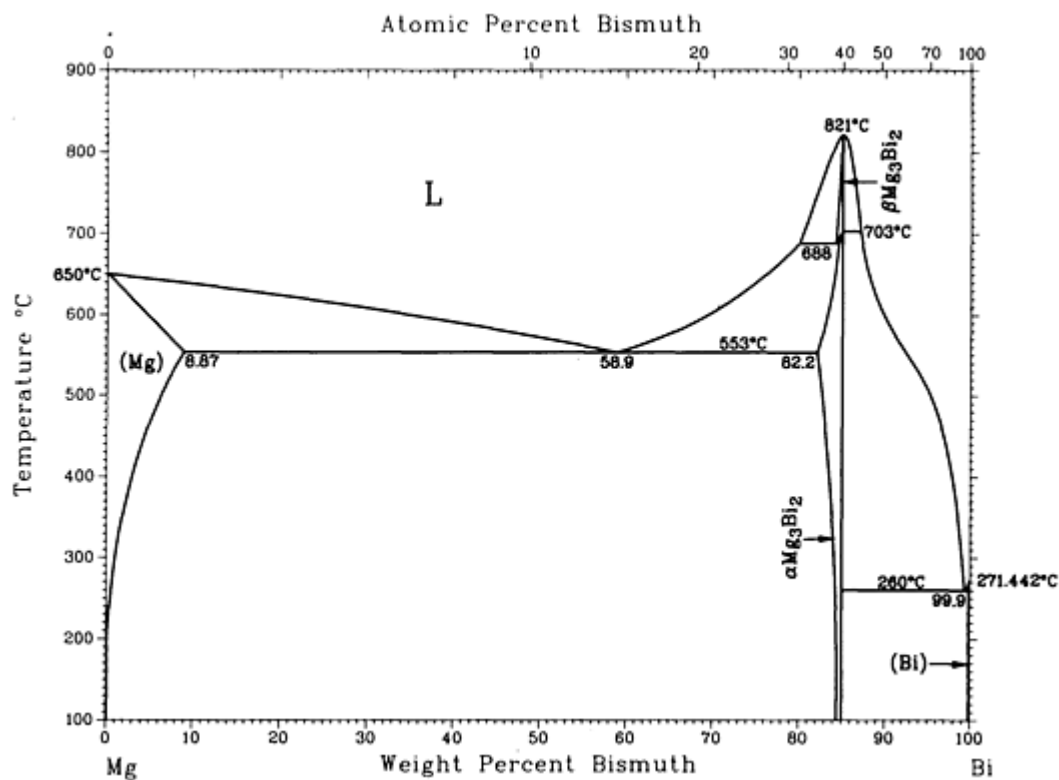

Bi-Mg phase diagram

Bi-Mg crystallographic data

Phase	Composition, wt% Bi	Pearson symbol	Space group
(Mg)	0 to 8.87	$hP2$	$P6_3/mmc$
Mg_3Bi_2 (LT) or $\alpha\text{Mg}_3\text{Bi}_2$	82.2 to 85	$hP5$	$P\bar{3}m1$
Mg_3Bi_2 (HT) or $\beta\text{Mg}_3\text{Bi}_2$	85	(a)	...
(Bi)	100	$hR2$	$R\bar{3}m$

(a) The structure of the high-temperature Mg_3Bi_2 is unknown.

Bi-Mn (Bismuth - Manganese)

H. Okamoto, 1990

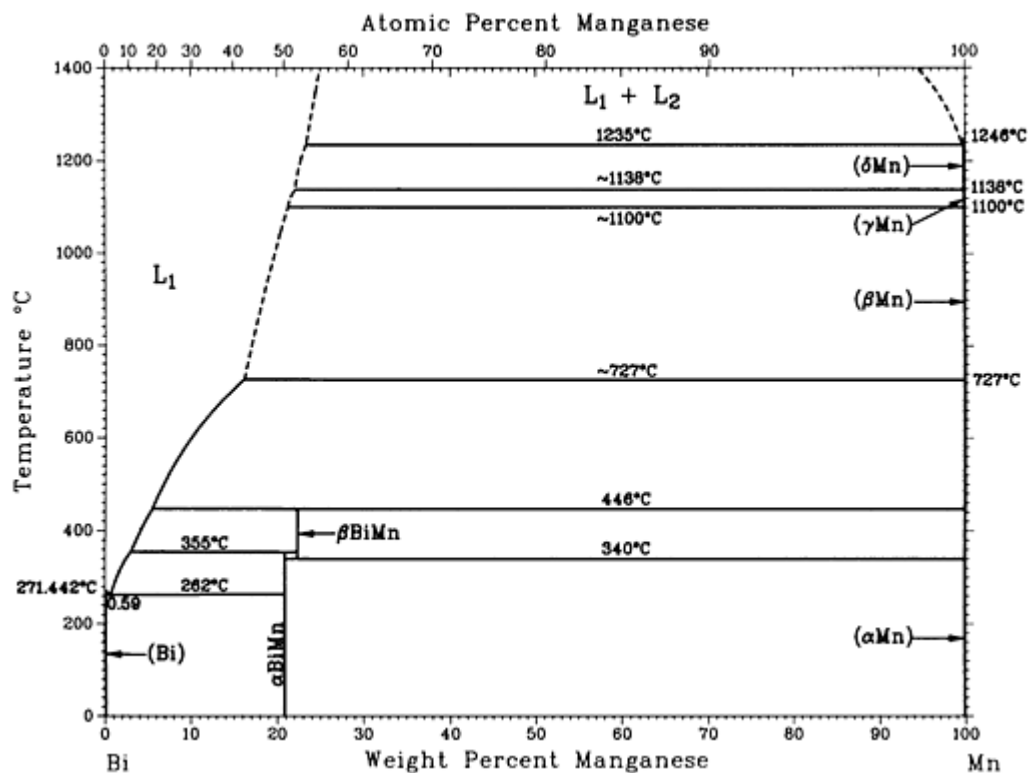

Bi-Mn phase diagram

Bi-Mn crystallographic data

Phase	Composition, wt% Mn	Pearson symbol	Space group
(Bi)	0	<i>hR2</i>	$R\bar{3}m$
β_{BiMn}	22.1	<i>o*32</i>	...
α_{BiMn}	20.8	<i>hP4</i>	$P6_3/mmc$
(δ_{Mn})	100	<i>cI2</i>	$Im\bar{3}m$
(γ_{Mn})	100	<i>cF4</i>	$Fm\bar{3}m$
(β_{Mn})	100	<i>cP20</i>	$P4_132$
(α_{Mn})	100	<i>cI58</i>	$I43m$

Bi-Na (Bismuth - Sodium)

J. Sangster and A.D. Pelton, 1991

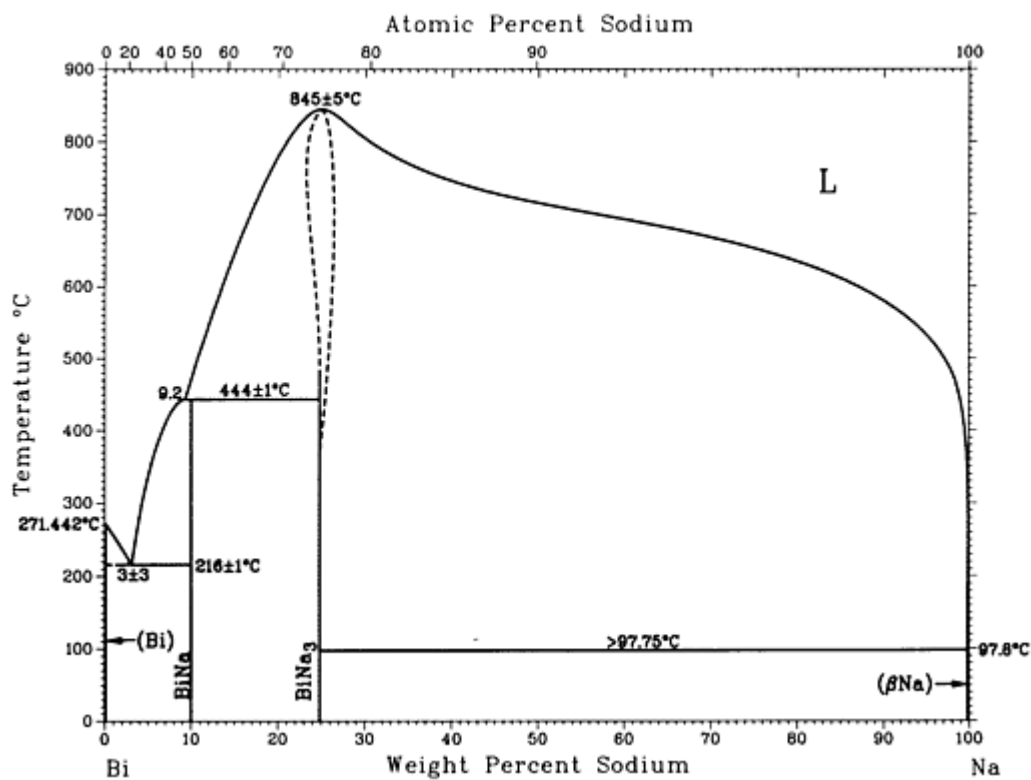

Bi-Na phase diagram

Bi-Na crystallographic data

Phase	Composition, wt% Na	Pearson symbol	Space group
(α Bi)	0	<i>hR2</i>	$R\bar{3}m$
BiNa	10.1	<i>tP4</i>	$P4/mmm$
BiNa ₃ ^(a)	23.4 to 27.5 ^(b)	<i>hP8</i>	$P6_3/mmc$
(α Na) ^(c)	100	<i>hP2</i>	$P6_3/mmc$
(β Na)	100	<i>cI2</i>	$Im\bar{3}m$

(a) Might be *hP24*, Cu₃As prototype.

(b) At 800 °C.

(c) Below -237 °C

Bi-Nd (Bismuth - Neodymium)

K.A. Gschneidner, Jr. and F.W. Calderwood, 1989

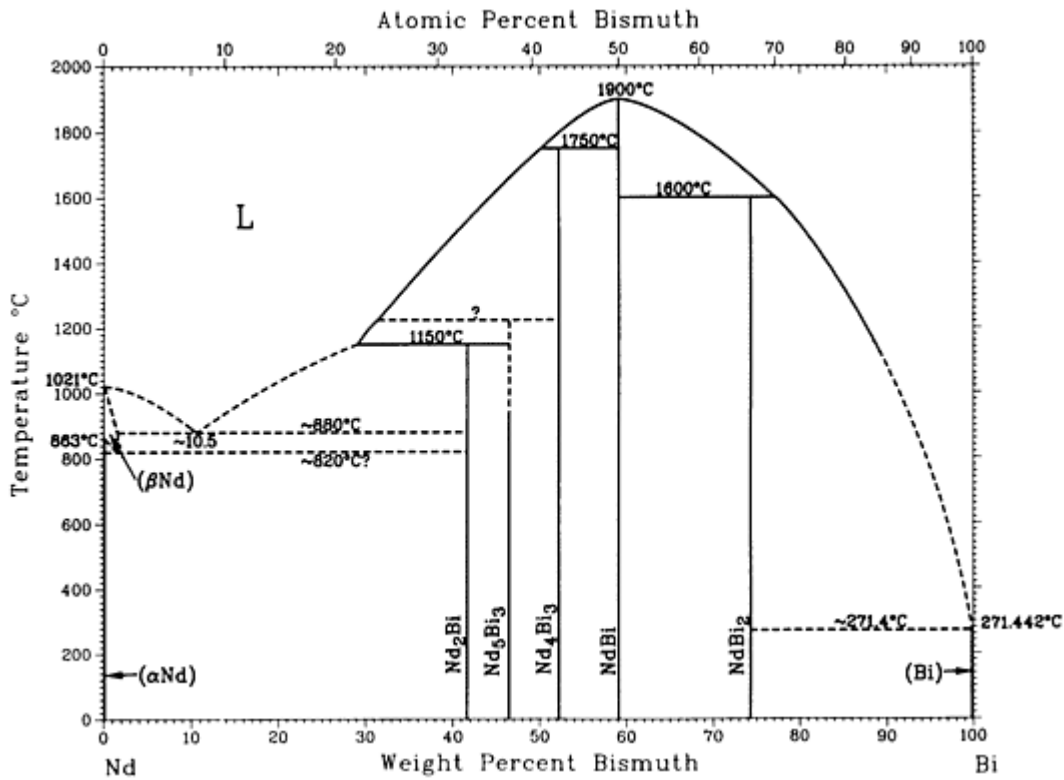

Bi-Nd phase diagram

Bi-Nd crystallographic data

Phase	Composition, wt% Bi	Pearson symbol	Space group
(αNd)	0	<i>hP4</i>	<i>P6₃/mmc</i>
Nd_2Bi	42.0	<i>tI12</i>	<i>I4/mmm</i>
Nd_3Bi_3	46.5	<i>hP16</i>	<i>P6₃/mcm</i>
Nd_4Bi_3	52.1	<i>cI28</i>	<i>I43d</i>
NdBi	59.1	<i>cF8</i>	<i>Fm3m</i>

NdBi ₂	74.4	<i>aP27(?)</i>	<i>P1</i> or <i>P$\bar{1}$</i>
(α Bi)	100	<i>hR2</i>	<i>R$\bar{3}m$</i>

Bi-Ni (Bismuth - Nickel)

P. Nash, 1991

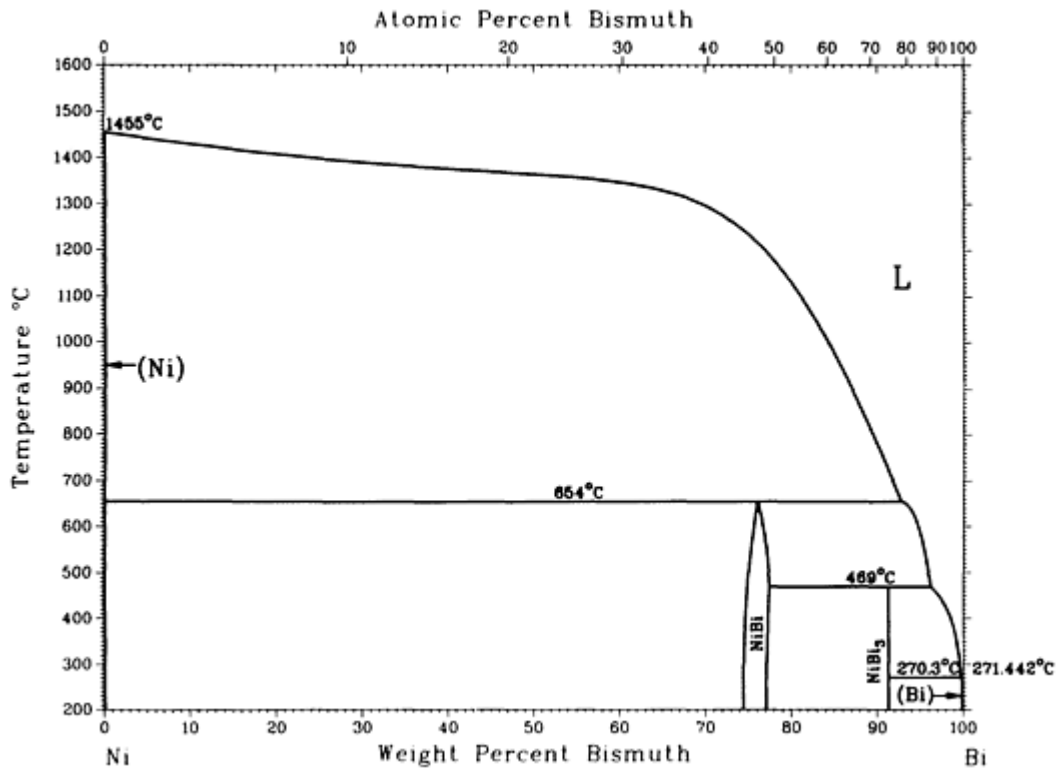

Bi-Ni phase diagram

Bi-Ni crystallographic data

Phase	Composition, wt% Bi	Pearson symbol	Space group
(Ni)	0	<i>cF4</i>	<i>Fm$\bar{3}m$</i>
NiBi	74 to 77	<i>hP4</i>	<i>P6₃/mmc</i>
NiBi ₃	91
(Bi)	100	<i>hR2</i>	<i>R$\bar{3}m$</i>

Bi-Pb (Bismuth - Lead)

N.A. Gokcen, 1992

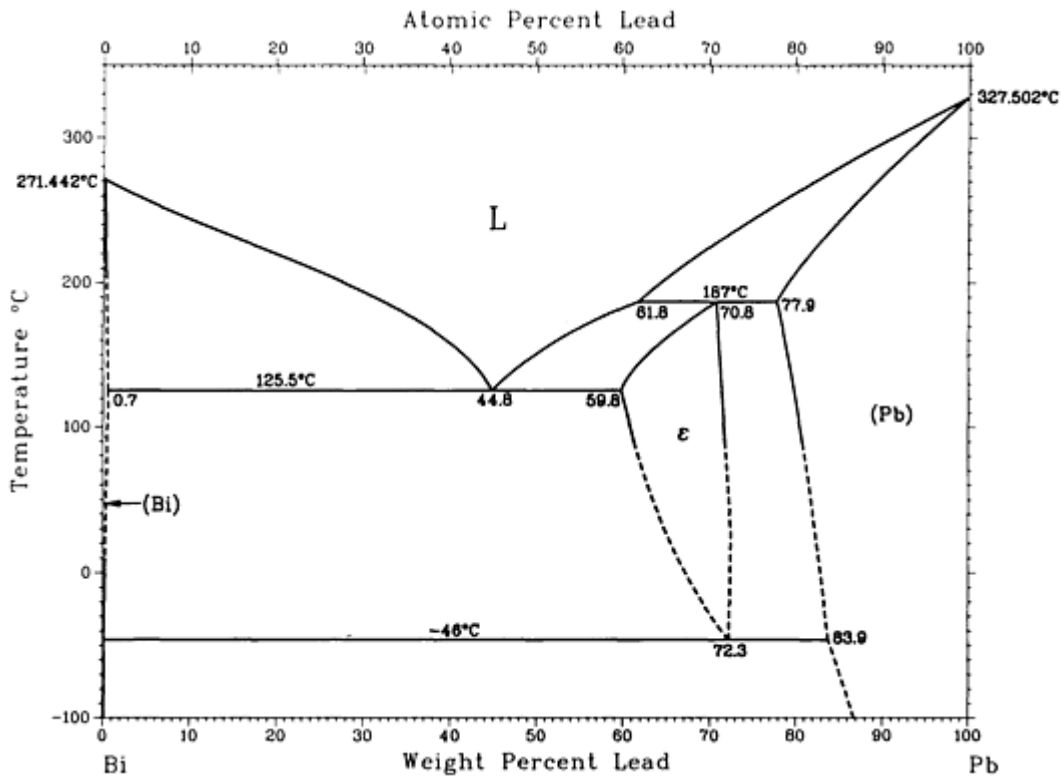

Bi-Pb phase diagram

Bi-Pb crystallographic data

Phase	Composition, wt% Pb	Pearson symbol	Space group
(Bi)	0 to 0.7	<i>hR2</i>	$R\bar{3}m$
ε	59.8 to 73	<i>hP2</i>	$P6_3/mmc$
(Pb)	77.9 to 100	<i>cF4</i>	$Fm\bar{3}m$

Bi-Pd (Bismuth - Palladium)

H. Okamoto, unpublished

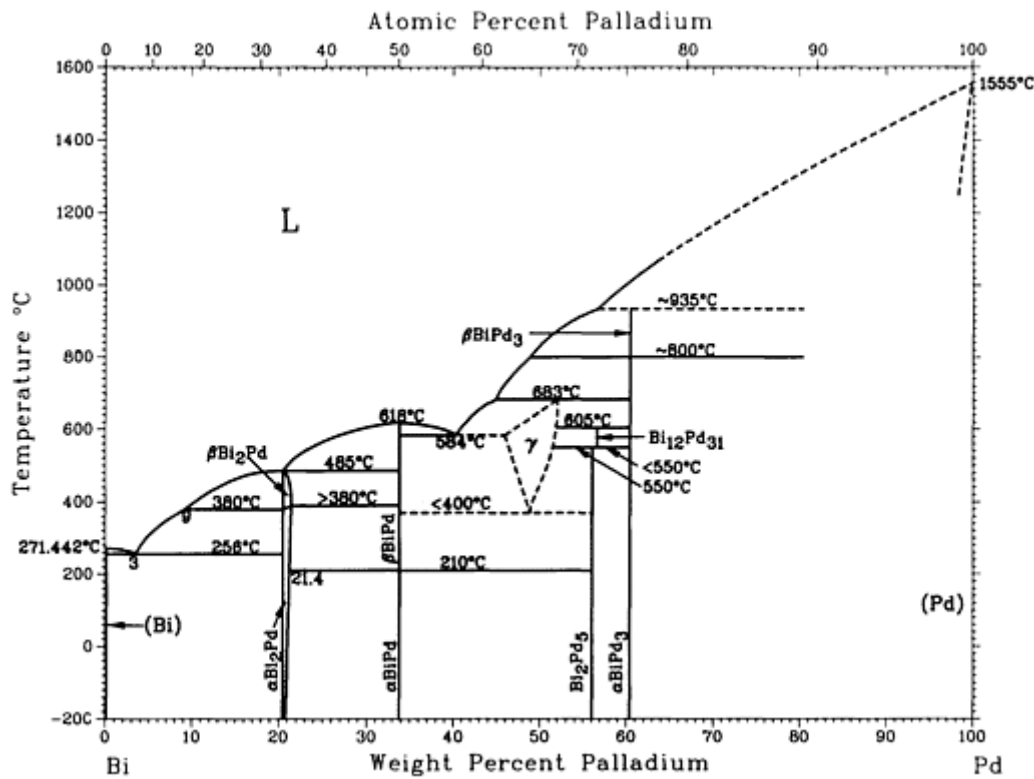

Bi-Pd phase diagram

Bi-Pd crystallographic data

Phase	Composition, wt% Pd	Pearson symbol	Space group
(αBi)	0	<i>hR2</i>	$R\bar{3}m$
β _{Bi₂Pd}	20.3	<i>tI6</i>	<i>I4/mmm</i>
α _{Bi₂Pd}	20.3	<i>mC12</i>	<i>C2/m</i>
β _{BiPd}	33.7	<i>oC32</i>	<i>Cmc2₁</i>
α _{BiPd}	33.7	<i>mP32</i>	<i>P2₁</i>
γ ^(a)	45.9	<i>hP16</i>	...

Bi_2Pd_5	56.0	<i>mC28</i>	<i>C2/m</i>
$\text{Bi}_{12}\text{Pd}_{31}$	56.8	<i>hR44</i>	<i>R3</i>
βBiPd_3	60
αBiPd_3	60	<i>oP16</i>	<i>Pmma</i>
(Pd)	100	<i>cF4</i>	<i>Fm\bar{3}m</i>

(a) Superlattice of NiAs type

Bi-Pt (Bismuth - Platinum)

H. Okamoto, 1991

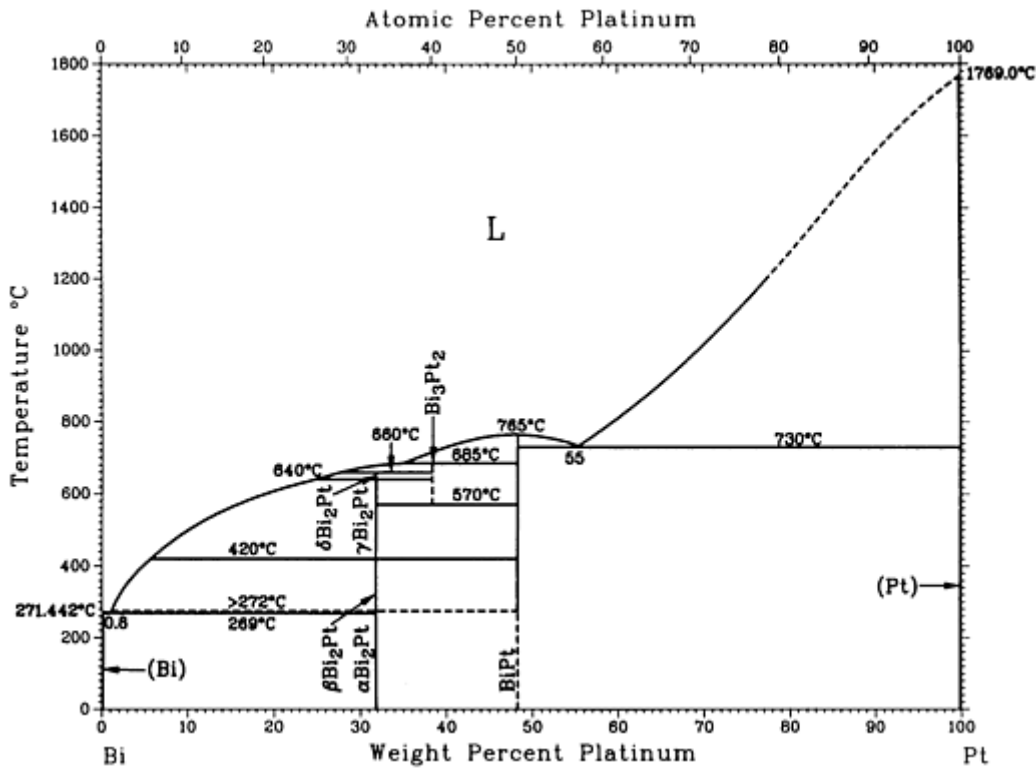

Bi-Pt phase diagram

Bi-Pt crystallographic data

Phase	Composition, wt% Pt	Pearson symbol	Space group

(α Bi)	0	$hR2$	$R\bar{3}m$
δ_{Bi_2Pt}	31.8	$oP6$	$Pnmm$
γ_{Bi_2Pt}	31.8	$hP9$	$P\bar{3}$
β_{Bi_2Pt}	31.8	$cP12$	$Pa3$
α_{Bi_2Pt}	31.8	$oP24$	$Pbca$
Bi_3Pt_2	38	o^{**} $hP4$	$P6_3/mmc$
BiPt	48.2	$hP4$	$P6_3/mmc$
(Pt)	100	$cF4$	$Fm\bar{3}m$

Bi-Rb (Bismuth - Rubidium)

A.D. Pelton and A. Petric, unpublished

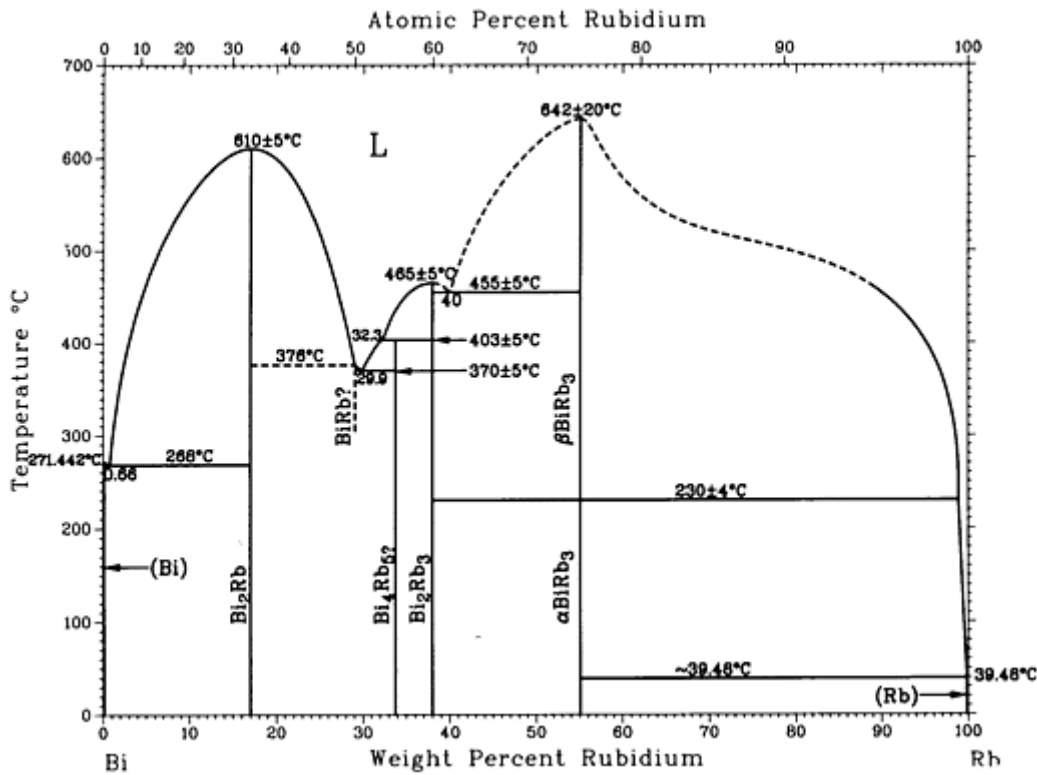

Bi-Rb phase diagram

Bi-Rb crystallographic data

Phase	Composition, wt% Rb	Pearson symbol	Space group
(Bi)	0	<i>hR2</i>	<i>R$\bar{3}m$</i>
Bi ₂ Rb	17.0	<i>cF24</i>	<i>Fd$\bar{3}m$</i>
BiRb(?)	29.0
Bi ₄ Rb ₅	33.9
Bi ₂ Rb ₃	38
α BiRb ₃ ^(a)	55	<i>hP8</i>	<i>P6₃/mmc</i>
β BiRb ₃ ^(b)	55	<i>cF16</i>	<i>Fm$\bar{3}m$</i>
(Rb)	100	<i>cI2</i>	<i>Im$\bar{3}m$</i>

(a) Stable below 230 °C.

(b) Stable above 230 °C

Bi-S (Bismuth - Sulfur)

J.-C. Lin, R.C. Sharma, and Y.A. Chang, unpublished

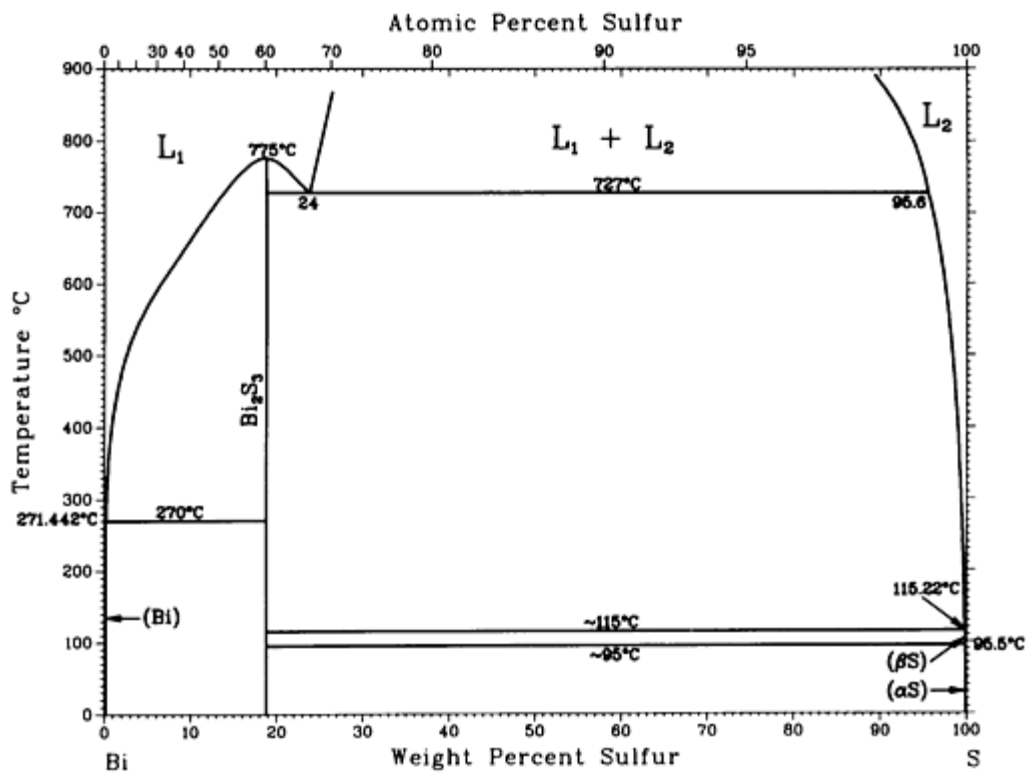

Bi-S phase diagram

Bi-S crystallographic data

Phase	Composition, wt% S	Pearson symbol	Space group
(αBi)	0	$hR2$	$R\bar{3}m$
Bi_2S_3	19	$oP20$	$Pnma$
(αS)	100	$oF128$	$Fddd$
(βS)	100	mP^*	$P2_1/c$

Bi-Sb (Bismuth - Antimony)

H. Okamoto, unpublished

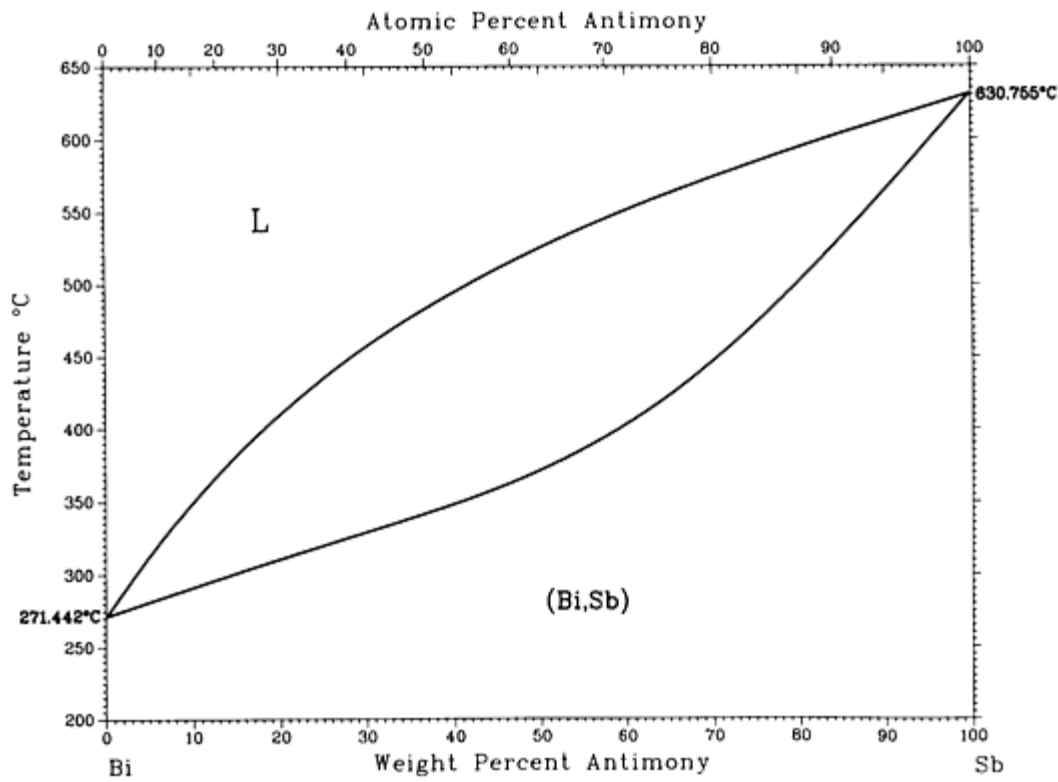

Bi-Sb phase diagram

Bi-Sb crystallographic data

Phase	Composition, wt% Sb	Pearson symbol	Space group
(Bi,Sb)	0 to 100	<i>hR2</i>	$R\bar{3}m$
High-pressure phases			
(BiII)	0 to 2.1	<i>mC4</i>	<i>C2/m</i>
(Bi,SbIII)	0 to 100	<i>mP4</i>	<i>P2₁/m</i>
(BiIII)	0 to ?

(BiIV)	0 to ?	$m\bar{8}$...
(BiV)	0 to ?	$cI2$	$Im\bar{3}m$
(SbII)	70 to 100	$cP1$	$Pm\bar{3}m$
(SbIII)	? to 100	$hP2$	$P6_3/mmc$

(a) (a) At room temperature.

(b) (b) High-temperature, high-pressure phase

Bi-Se (Bismuth - Selenium)

H. Okamoto, unpublished

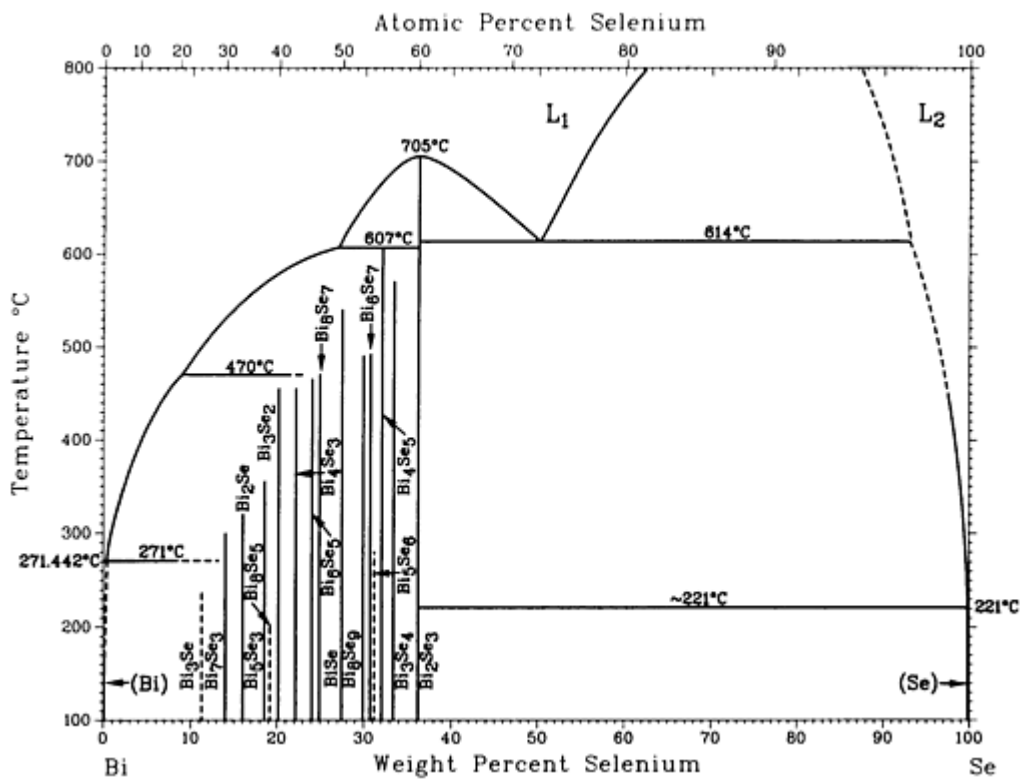

Bi-Se phase diagram

Bi-Se crystallographic data

Phase	Composition, wt% Se	Pearson symbol	Space group
-------	---------------------	----------------	-------------

(α Bi)	0	$hR2$	$R\bar{3}m$
Bi_7Se_3	14	$hR20$	$R\bar{3}m$
Bi_2Se	15.9	$hP9$	$P\bar{3}m1$
$\text{Bi}_5\text{Se}_3^{(a)}$	18.5	$hP48$	$P\bar{3}m1$
Bi_3Se_2	20	$hP30$	$P\bar{3}m1$
Bi_4Se_3	22.1	$hR7$	$R\bar{3}m$
Bi_6Se_5	24.0	$hP33$	$P\bar{3}m1$
Bi_8Se_7	24.8	$hP45$	$P\bar{3}m1$
BiSe	27.4	$hP12$	$P\bar{3}m1$
Bi_8Se_9	29.8	$hP17$	$R\bar{3}m$
Bi_6Se_7	30.6	$hP39$	$P\bar{3}m1$
Bi_4Se_5	32.1	$hP27$	$P\bar{3}m1$
Bi_3Se_4	33.5	$hP42$	$P\bar{3}m1$
Bi_2Se_3	36	$hR5$	$R\bar{3}m$
(Se)	100	$hP3$	$P\bar{3}_121$
Metastable phases			
$\text{BiSe}^{(b)}$	27.4	$cF8$	$Fm\bar{3}m$
$\text{Bi}_2\text{Se}_3\text{IIIa}$	36	c^{**}	...
High-pressure phases			

$\text{Bi}_2\text{Se}_3\text{II}^{(c)}$	36	<i>oP20</i>	<i>Pnma</i>
$\text{Bi}_2\text{Se}_3\text{III}$	36	<i>tP40</i>	<i>P4₂/nmc</i>
BiSe₂	43.1

- (a) Laitakarite.
- (b) Thin film.
- (c) Bismuthite

Bi-Sm (Bismuth - Samarium)

H. Okamoto, 1990

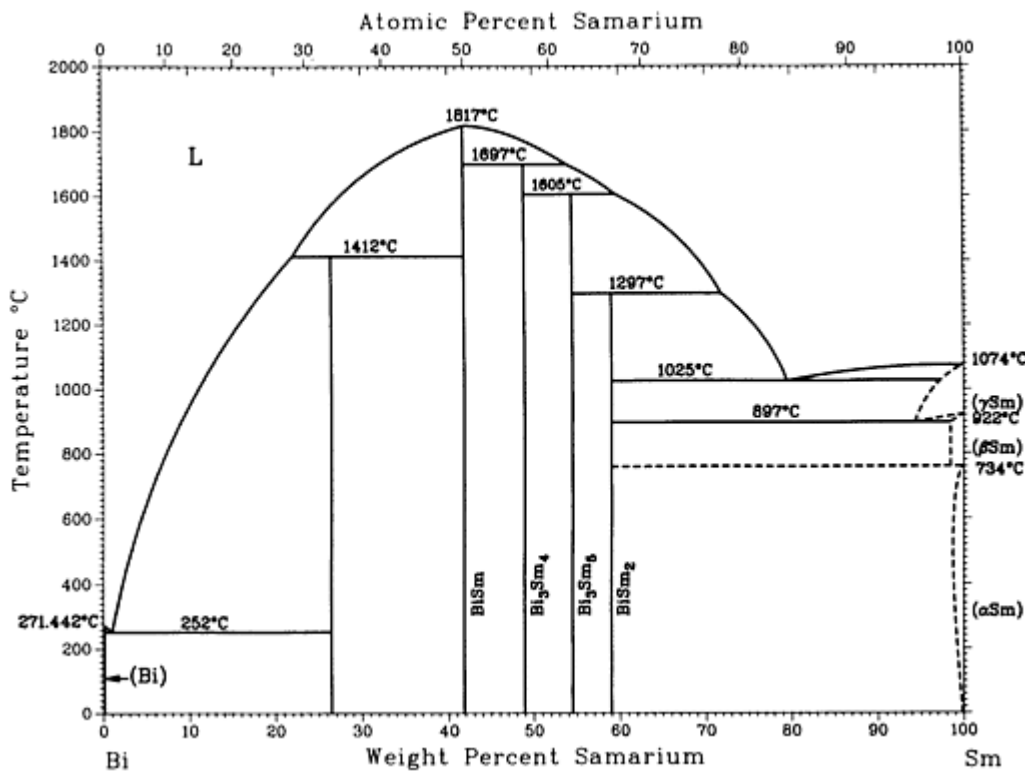

Bi-Sm phase diagram

Bi-Sm crystallographic data

Phase	Composition, wt% Sm	Pearson symbol	Space group

(α Bi)	0	<i>hR2</i>	<i>R$\bar{3}m$</i>
Bi ₂ Sm	26.5	<i>oP12</i>	<i>Pmmm</i>
BiSm	42.8	<i>cF8</i>	<i>Fm$\bar{3}m$</i>
Bi ₃ Sm ₄	48.9	<i>cI28</i>	<i>I$\bar{4}3d$</i>
Bi ₃ Sm ₅	54.5	<i>hP16</i>	<i>P6₃/mcm</i>
BiSm ₂	59.0	<i>tI6</i>	<i>I4/mmm</i>
(γ Sm)	100	<i>cI2</i>	<i>Im$\bar{3}m$</i>
(β Sm)	100	<i>hP2</i>	<i>P6₃/mmc</i>
(α Sm)	100	<i>hR3</i>	<i>Rm$\bar{3}m$</i>

Bi-Sn (Bismuth - Tin)

H. Okamoto, 1990

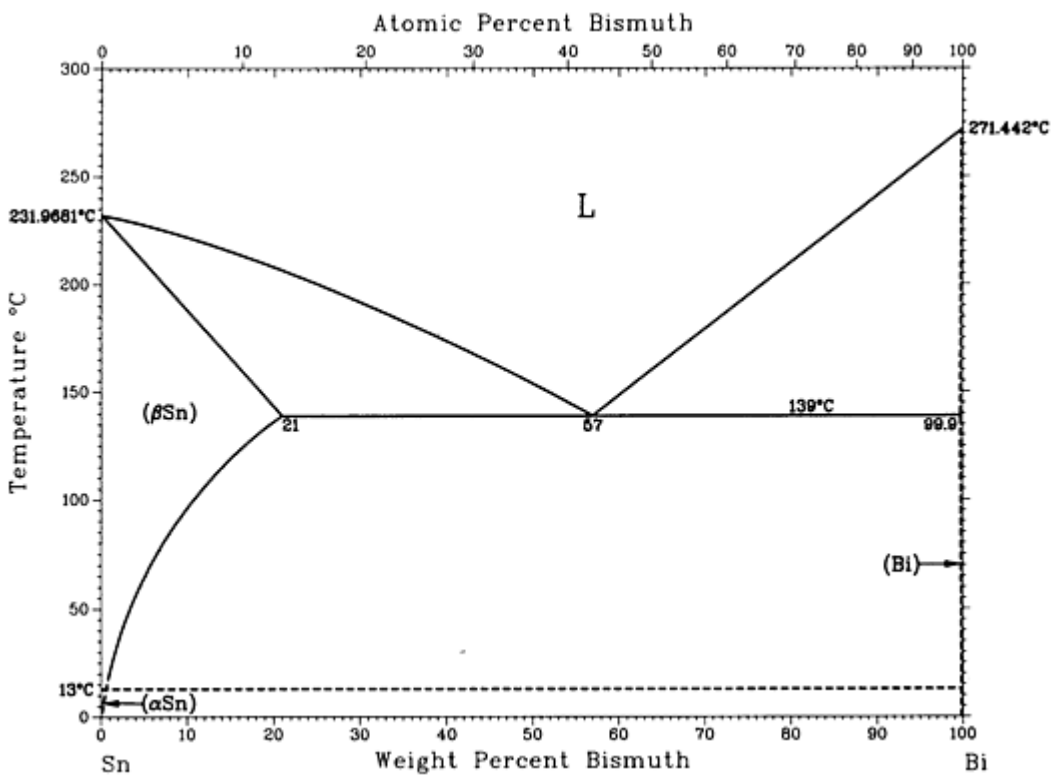

Bi-Sn phase diagram

Bi-Sn crystallographic data

Phase	Composition, wt% Bi	Pearson symbol	Space group
(β Sn)	0 to 21	<i>tI4</i>	<i>I4₁amd</i>
(α Sn)	0 to ?	<i>cF8</i>	<i>Fd$\bar{3}m$</i>
(Bi)	99.9 to 100	<i>hR2</i>	<i>R$\bar{3}m$</i>

Bi-Sr (Bismuth - Strontium)

From [Elliott] 4

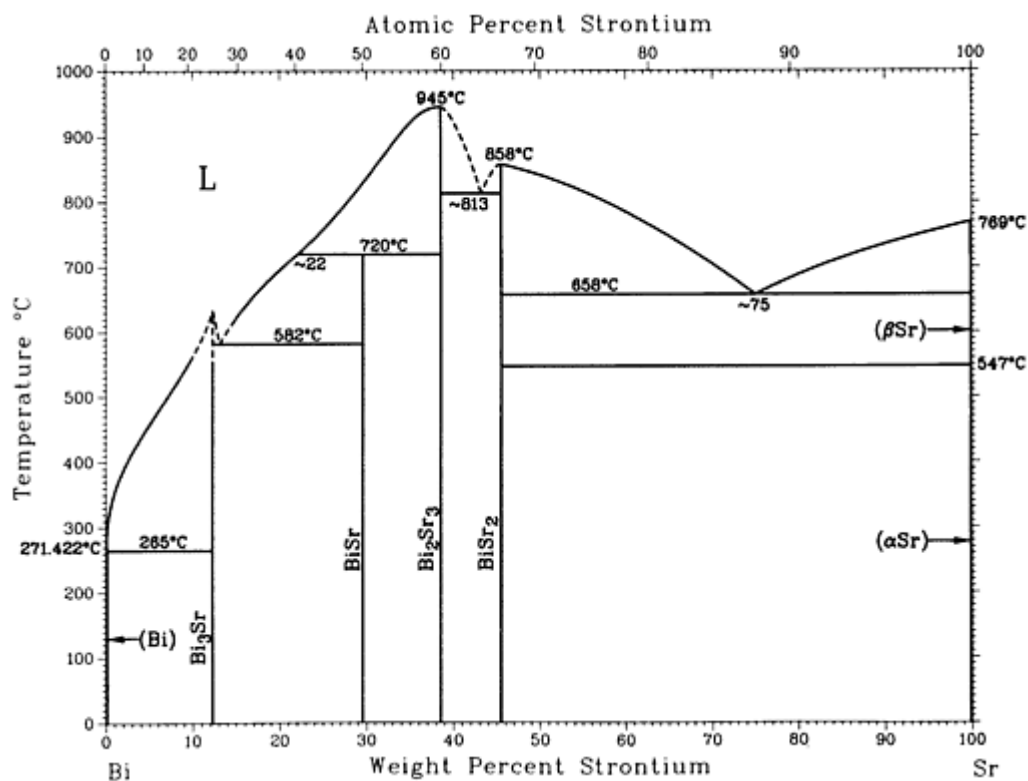

Bi-Sr phase diagram

Bi-Sr crystallographic data

Phase	Composition, wt% Sr	Pearson symbol	Space group

(Bi)	0	$hR2$	$R\bar{3}m$
Bi ₃ Sr	12	$cP4$	$Pm\bar{3}m$
BiSr	29.5
Bi ₂ Sr ₃	39
BiSr ₂	45.7	$tI12$	$I4/mmm$
(βSr)	100	$cI2$	$Im\bar{3}m$
(αSr)	100	cF	$Fm\bar{3}m$

Reference cited in this section

4. [Elliott]: R.P. Elliott, *Constitution of Binary Alloys, First Supplement*, McGraw-Hill, New York or General Electric Co., Business Growth Services, Schenectady, New York (1965).

Bi-Te (Bismuth - Tellurium)

H. Okamoto and L.E. Tanner, unpublished

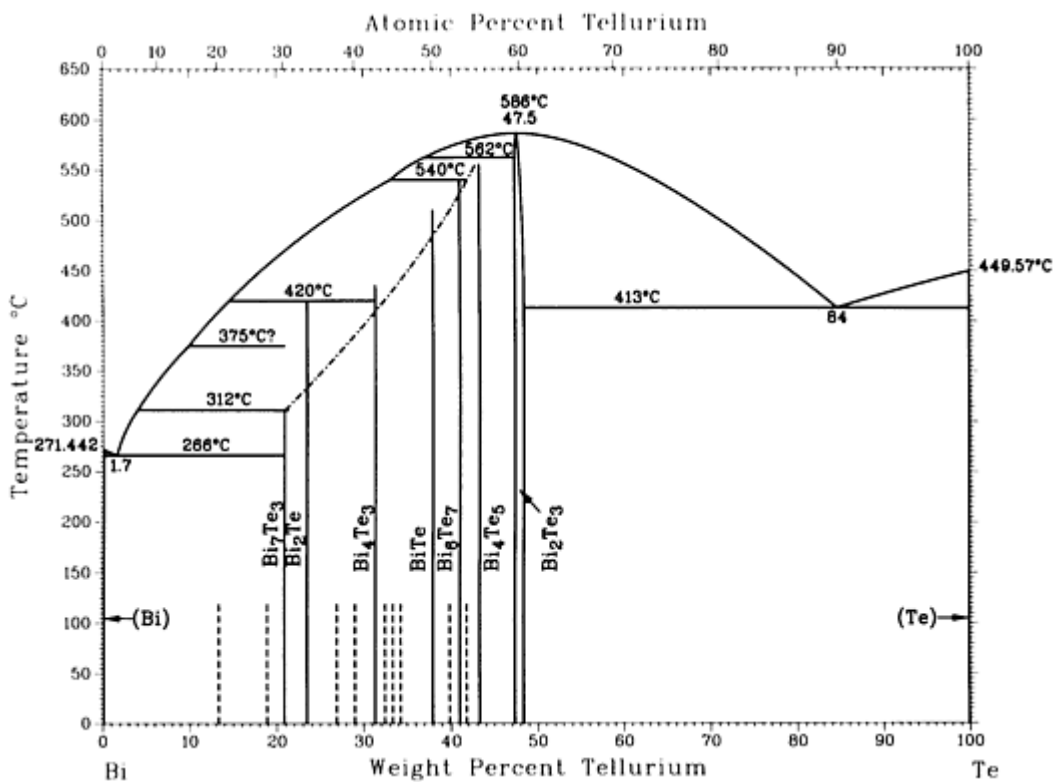

Bi-Te phase diagram

Bi-Te crystallographic data

Phase	Composition, wt% Te	Pearson symbol	Space group
(α Bi)	0 to ?	<i>hR2</i>	$R\bar{3}m$
Bi ₂ Te ₃	47.5 to 48.0	<i>hR5</i>	$R\bar{3}m$
(α Te)	99.992 to 100	<i>hP3</i>	$P3_121$
Stacking variants			
Bi ₇ Te ₃	21	<i>hR20</i>	$R\bar{3}m$
Bi ₂ Te	23.4	...	$P\bar{3}m1$
Bi ₄ Te ₃	31.5	<i>hR7</i>	$R\bar{3}m$
BiTe	37.9	<i>hP12</i>	$P\bar{3}m1$
Bi ₆ Te ₇	41.6	<i>hP39</i>	$P\bar{3}m1$
Bi ₄ Te ₅	43.3	<i>hP27</i>	$P\bar{3}m1$
Metastable phases			
BiTe ^(a)	37.9	<i>cF8</i>	$Fm\bar{3}m$
Bi ₂ Te ₅	60.4
High-pressure phase			
Bi ₂ Te ₃ II	48	<i>hR5</i>	$R\bar{3}m$

(a) Thin film

Bi-Tl (Bismuth - Thallium)

H. Okamoto, unpublished

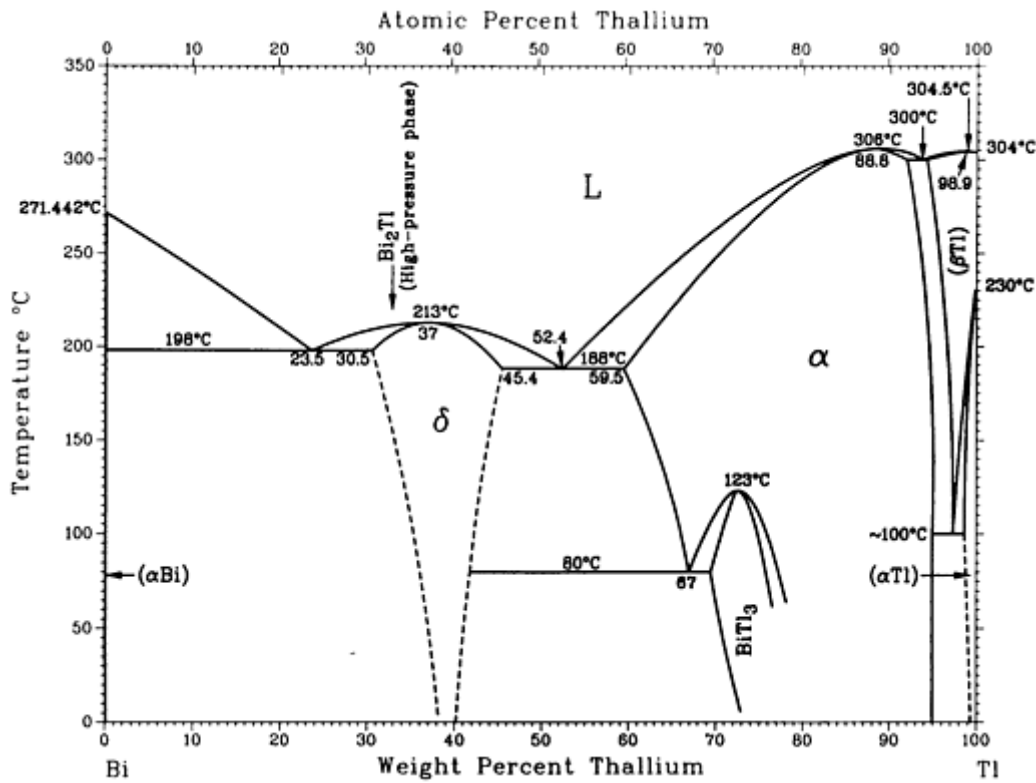

Bi-Tl phase diagram

Bi-Tl crystallographic data

Phase	Composition, wt% Tl	Pearson symbol	Space group
$(\gamma_{\text{Bi}})^{(a)}$	0	<i>mP4</i>	<i>P2₁/m</i>
$(\beta_{\text{Bi}})^{(a)}$	0	<i>mC4</i>	<i>C2/m</i>
(α_{Bi})	0	<i>hR2</i>	<i>R$\bar{3}m$</i>
$\text{Bi}_2\text{Tl}^{(a)}$	33.8
δ	30.5 to 45.4	<i>hP3</i>	<i>P6/mmm</i>
$\text{BiTl}^{(b)}$...	<i>cP2</i>	<i>Pm$\bar{3}m$</i>

α	59.5 to 94.9	<i>cF4</i>	<i>Fm$\bar{3}m$</i>
BiTl ₃	69.5 to 76.6	<i>hP2</i> <i>hP8</i>	<i>P6₃/mmc</i> <i>P6₃/mmc</i>
BiTl ₃ I ^(c)	~74.6	<i>cP4</i>	<i>Pm$\bar{3}m$</i>
BiTl ₇ ^(a)	87.3
(γ Tl) ^(a)	100	<i>cF4</i>	<i>Fm$\bar{3}m$</i>
(β Tl)	94.9 to 100	<i>cI2</i>	<i>Im$\bar{3}m$</i>
(α Tl)	98.98 to 100	<i>hP2</i>	<i>P6₃/mmc</i>

Note: Not all high-pressure phases of Bi are listed.

(a) High-pressure phase.

(b) Not accepted in the assessed diagram.

(c) Metastable?

Bi-U (Bismuth - Uranium)

From [Chiotti] 3

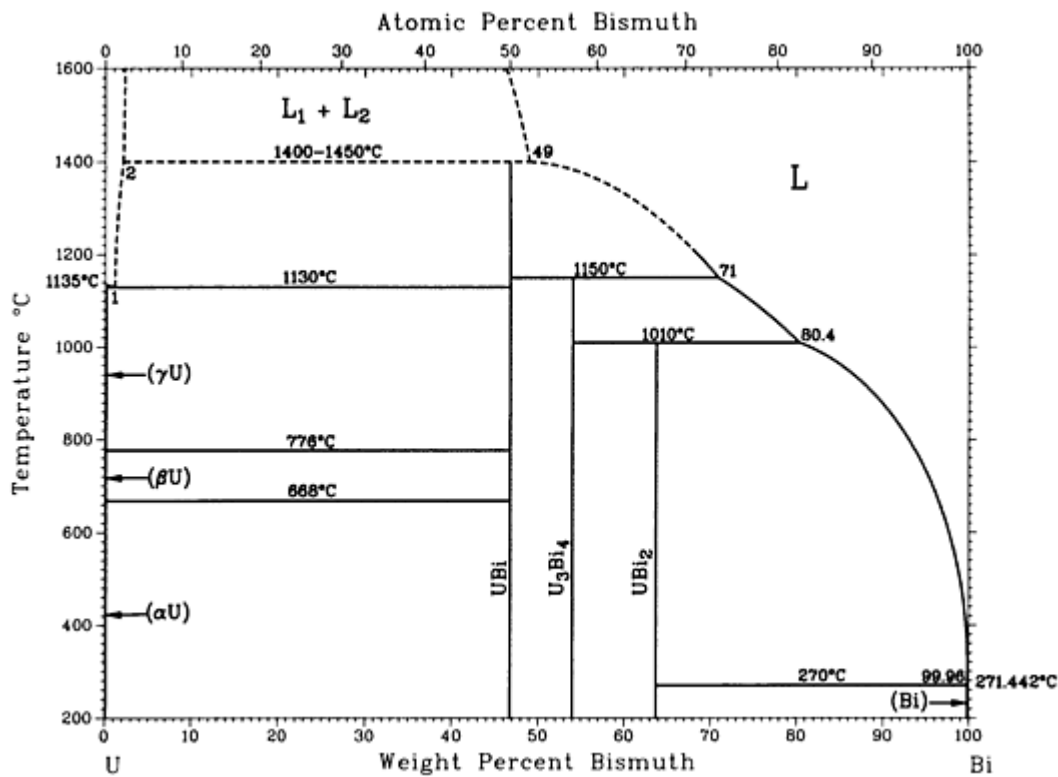

Bi-U phase diagram

Bi-U crystallographic data

Phase	Composition, wt% Bi	Pearson symbol	Space group
(γU)	0	<i>cI2</i>	$Im\bar{3}m$
(βU)	0	<i>tP30</i>	$P4_2/mnm$
(αU)	0	<i>oC4</i>	$Cmcm$
UBi	46.7	<i>cF8</i>	$Fm\bar{3}m$
U_3Bi_4	53.9	<i>cI28</i>	$I\bar{4}3d$

UBi ₂	63.8	<i>tP6</i>	<i>P4/nmm</i>
(Bi)	100	<i>hR2</i>	<i>R$\bar{3}m$</i>

Reference cited in this section

3. [Chiotti]: P. Chiotti, V.V. Akhachinskij, and I. Ansara, *The Chemical Thermodynamics of Actinide Elements and Compounds*, Part 5: The Actinide Binary Alloys, V. Medvedev, M.H. Rand, E.F. Westrum, Jr., and F.L. Oetting, Ed., International Atomic Energy Agency, Vienna (1981).

Bi-Y (Bismuth - Yttrium)

K.A. Gschneidner, Jr. and F.W. Calderwood, 1989

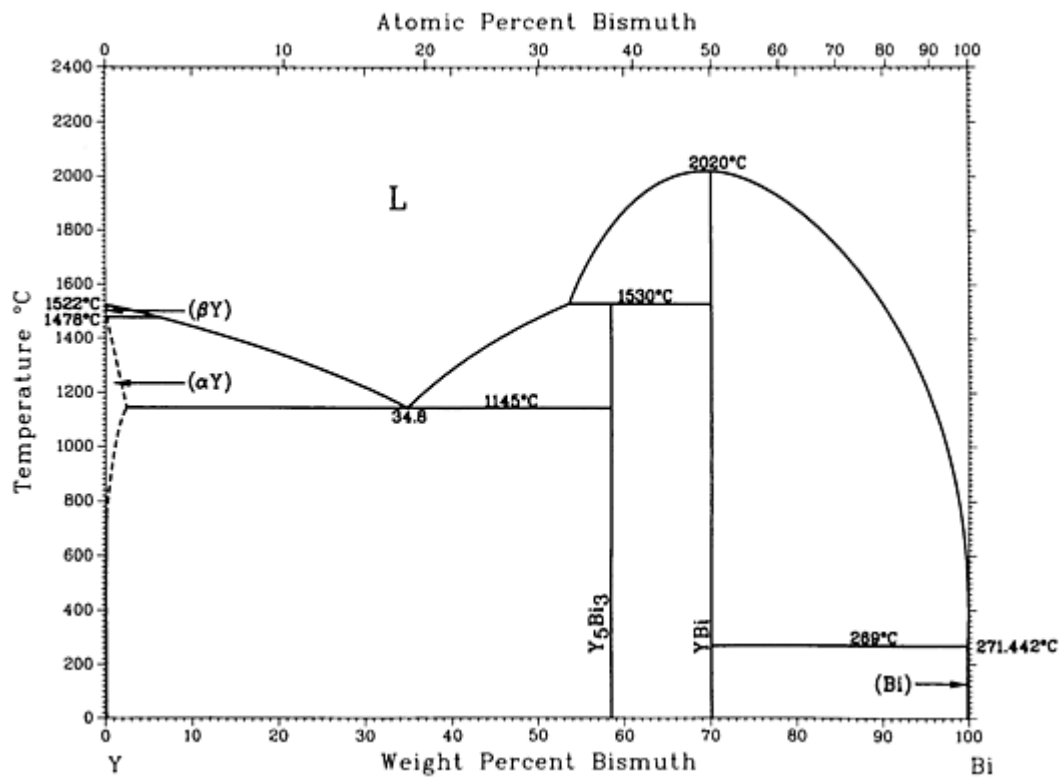

Bi-Y phase diagram

Bi-Y crystallographic data

Phase	Composition, wt% Bi	Pearson symbol	Space group
(αY)	0	<i>hP2</i>	<i>P6₃/mmc</i>
Y ₅ Bi ₃	58.5	<i>oP32</i>	<i>Pnma</i>

YBi	70.1	<i>cF8</i>	<i>Fm</i> $\bar{3}m$
(α Bi)	100	<i>hR2</i>	<i>R</i> $\bar{3}m$

Bi-Yb (Bismuth - Ytterbium)

H. Okamoto, 1990

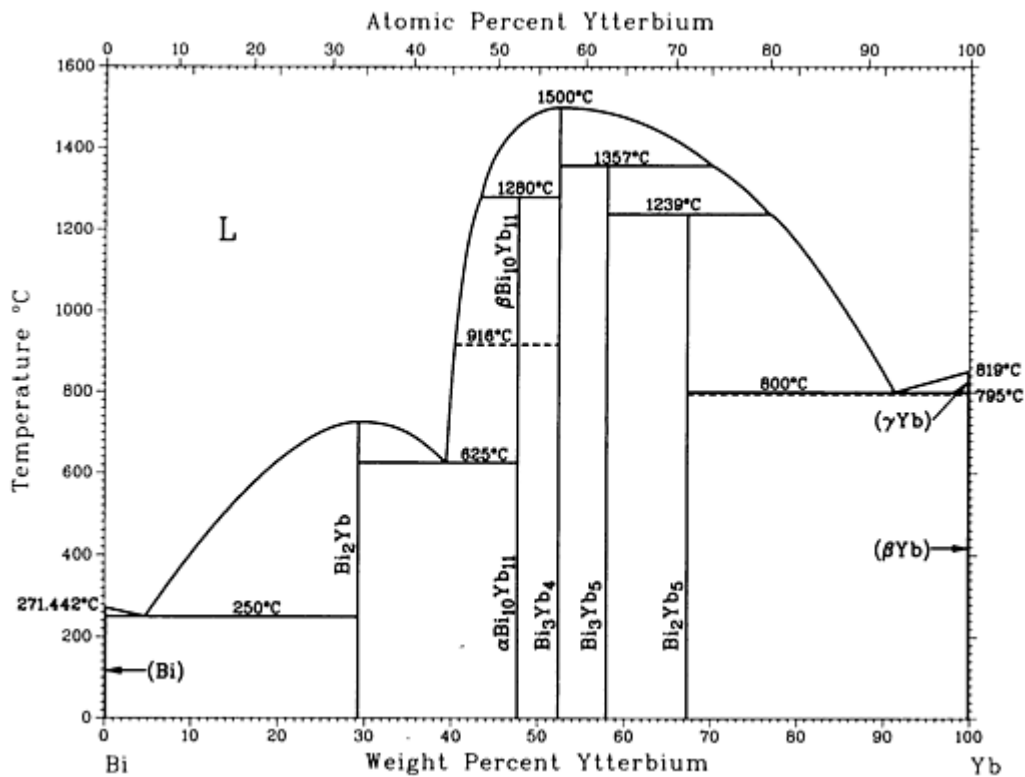

Bi-Yb phase diagram

Bi-Yb crystallographic data

Phase	Composition, wt% Yb	Pearson symbol	Space group
(α Bi)	0	<i>hR2</i>	<i>R</i> $\bar{3}m$
Bi ₂ Yb	29.3	<i>oC12</i>	<i>Cmcm</i>
β -Bi ₁₀ Yb ₁₁	47.7	<i>tI84</i>	<i>I4/mmm</i>
α -Bi ₁₀ Yb ₁₁	47.7

Bi ₃ Yb ₄	52.4	<i>cI28</i>	<i>I</i> $\bar{4}3d$
Bi ₃ Yb ₅	58	<i>oP32</i>	<i>Pnma</i>
Bi ₂ Yb ₅	67.4	<i>oP*</i>	<i>Pn2₁a</i>
(γ Yb)	100	<i>cI2</i>	<i>Im</i> $\bar{3}m$
(β Yb)	100	<i>cF4</i>	<i>Fm</i> $\bar{3}m$
(α Yb)	100	<i>hP2</i>	<i>P6₃/mmc</i>

Bi-Zn (Bismuth - Zinc)

H. Okamoto, 1990

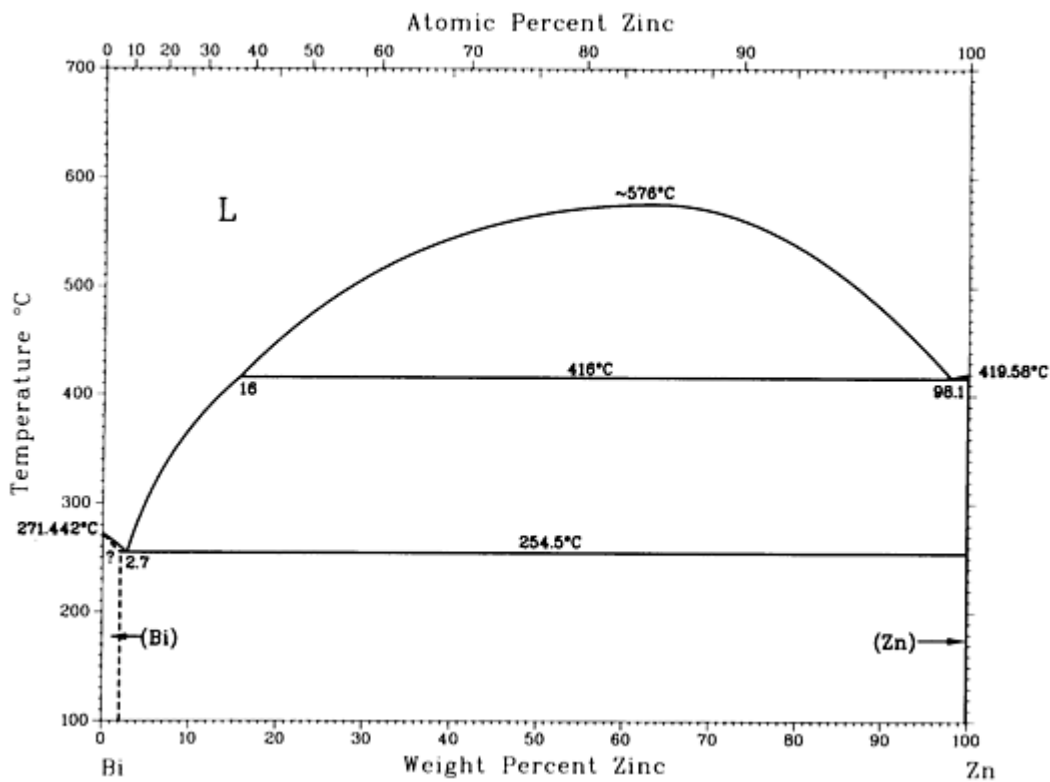

Bi-Zn phase diagram

Bi-Zn crystallographic data

Phase	Composition, wt% Zn	Pearson symbol	Space group

(Bi)	0 to ?	<i>hR2</i>	$R\bar{3}m$
(Zn)	~100	<i>hP2</i>	$P6_3/mmc$

Bi-Zr (Bismuth - Zirconium)

H. Okamoto, 1990

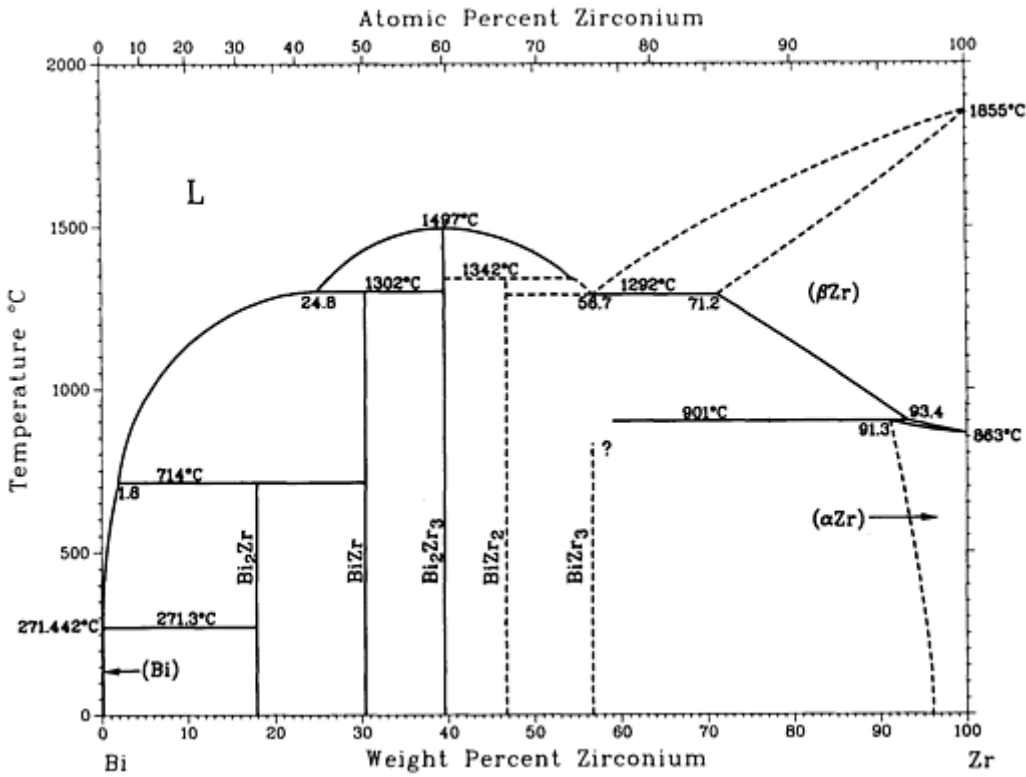

Bi-Zr phase diagram

Bi-Zr crystallographic data

Phase	Composition, wt% Zr	Pearson symbol	Space group
(αBi)	0	<i>hR2</i>	$R\bar{3}m$
Bi ₂ Zr	17.9	<i>oP24</i>	$Pn\bar{m}$
BiZr	30.4

Bi_2Zr_3	39.6
BiZr_2	46.7
BiZr_3	56.7	$tI32$	$I\bar{4}$
(β_{Zr})	71.2 to 100	$cI2$	$Im\bar{3}m$
(α_{Zr})	91.3 to 100	$hP2$	$P6_3/mmc$

C (Carbon) Binary Alloy Phase Diagrams

Introduction

THIS ARTICLE includes systems where carbon is the first-named element in the binary pair. Additional binary systems that include carbon are provided in the following location in this Volume:

- “B-C (Boron - Carbon)” in the article “B (Boron) Binary Alloy Phase Diagrams.”

C-Co (Carbon - Cobalt)

K. Ishida and T. Nishizawa, 1991

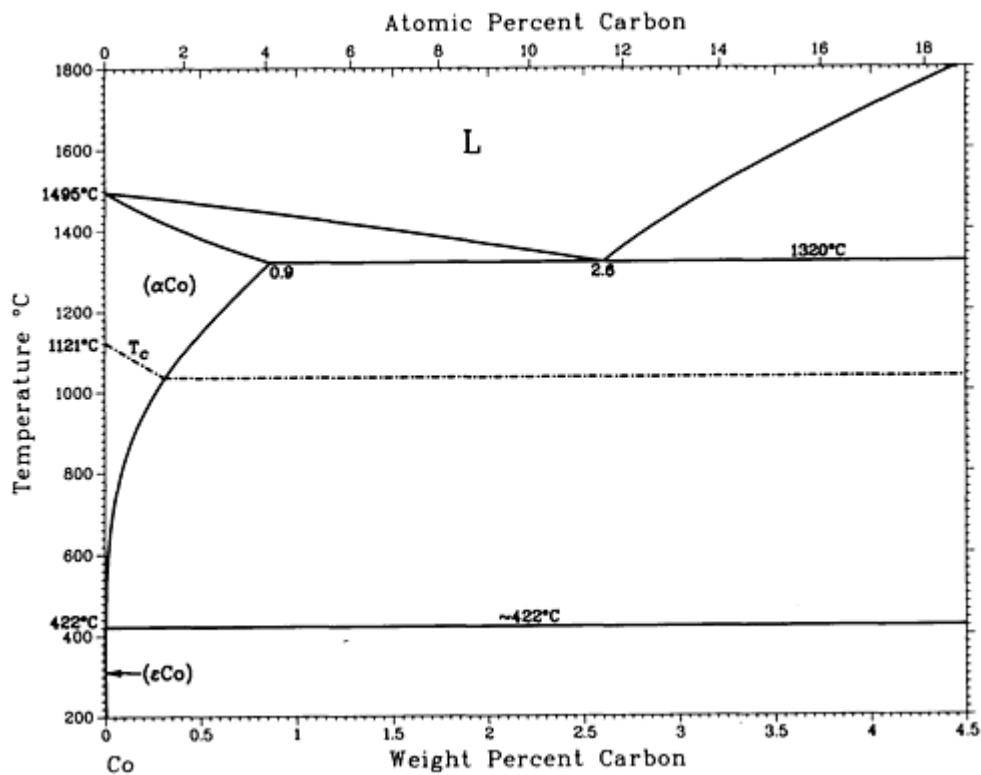

C-Co phase diagram

C-Co crystallographic data

Phase	Composition, wt% C	Pearson symbol	Space group
(α Co)	0 to 0.9	<i>cF4</i>	<i>Fm$\bar{3}m$</i>
(ϵ Co)	~ 0	<i>hP2</i>	<i>P6$_3$/mmc</i>
C	~ 100	<i>hP4</i>	<i>P6$_3$/mmc</i>
Metastable phases			
(ϵ' Co)	~ 0.3 to ~ 0.4	^(a)	...
Co ₃ C	6	<i>oP6</i>	<i>Pnma</i>
Co ₂ C	9	<i>oP6</i>	<i>Pnmm</i>

(a) Hexagonal

C-Cr (Carbon - Chromium)

M. Venkatraman and J.P. Neumann, 1990

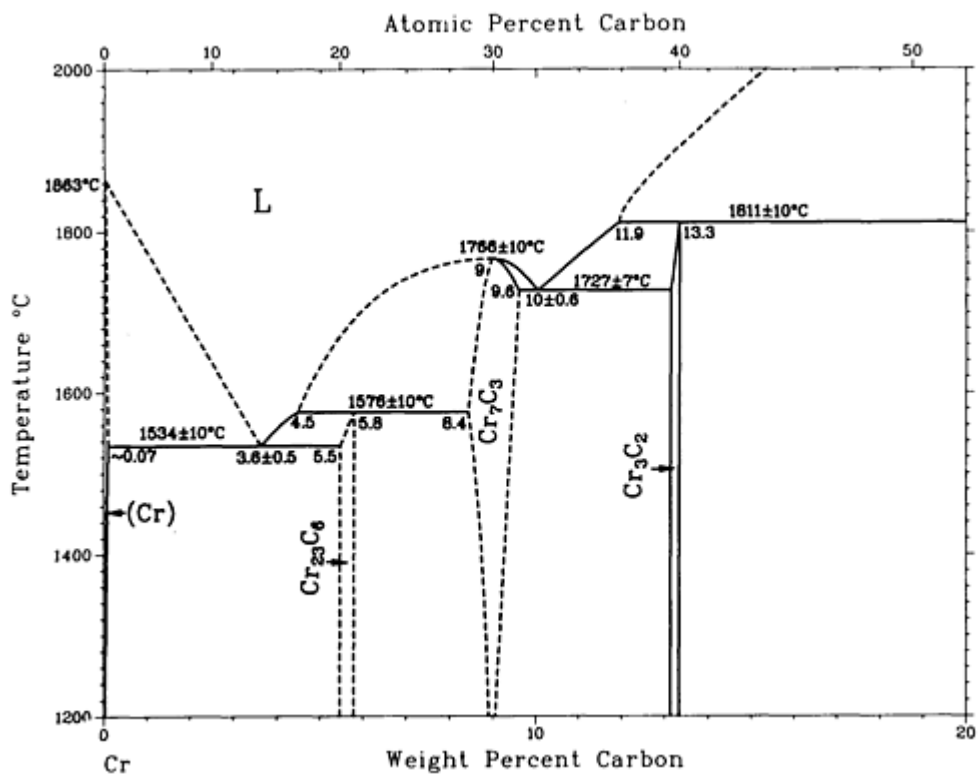

C-Cr phase diagram

C-Cr crystallographic data

Phase	Composition, wt% C	Pearson symbol	Space group
(Cr)	0 to ~0.07	<i>cI2</i>	<i>Im</i> $\bar{3}m$
Cr ₂₃ C ₆	5.5 to 5.8	<i>cF116</i>	<i>Fm</i> $\bar{3}m$
Cr ₃ C ^(a)	~7	<i>oP16</i>	<i>Pnma</i>
Cr ₇ C ₃	~9	<i>oP40</i>	<i>Pnma</i>
Cr ₃ C ₂	~13	<i>oP20</i>	<i>Pnma</i>
CrC(?)	~19
(C)	~100	<i>hP4</i>	<i>P6₃/mmc</i>

(a) Metastable

C-Cu (Carbon - Copper)

P.R. Subramanian and D.E. Laughlin, unpublished

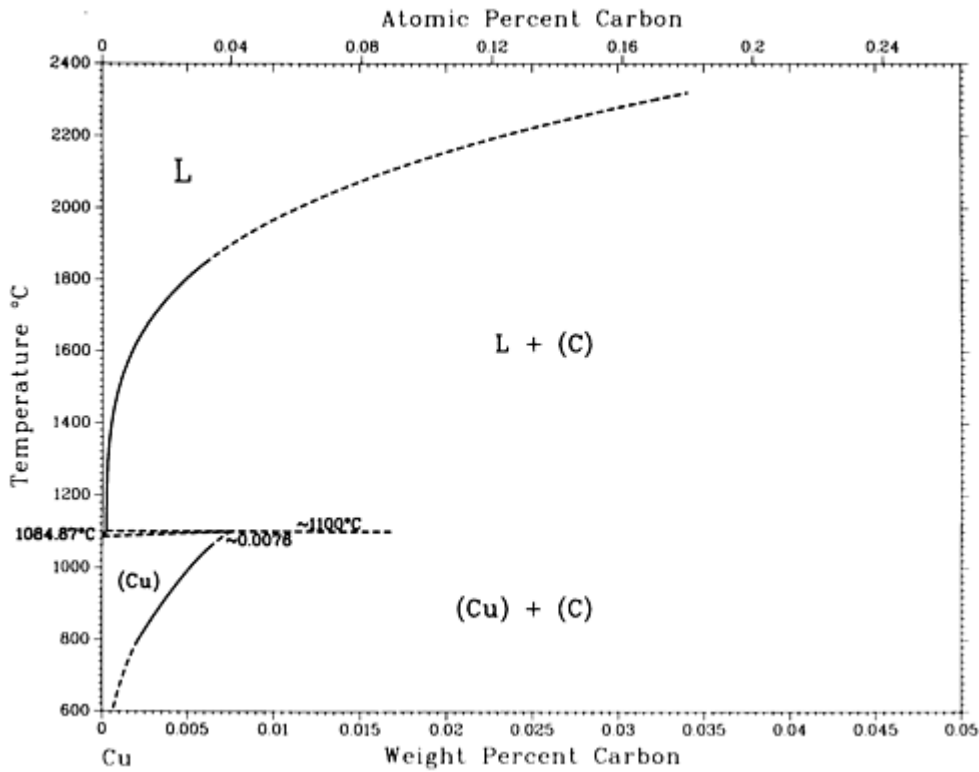

C-Cu phase diagram

C-Cu crystallographic data

Phase	Composition, wt% C	Pearson symbol	Space group
(Cu)	0 to 0.01	<i>cF4</i>	<i>Fm$\bar{3}m$</i>
(C)	100	<i>hP4</i>	<i>P6₃/mmc</i>

C-Fe (Carbon - Iron)

H. Okamoto, 1992

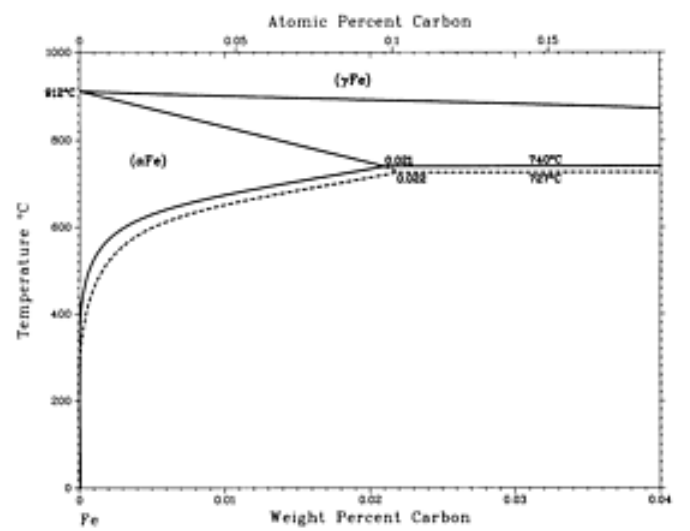
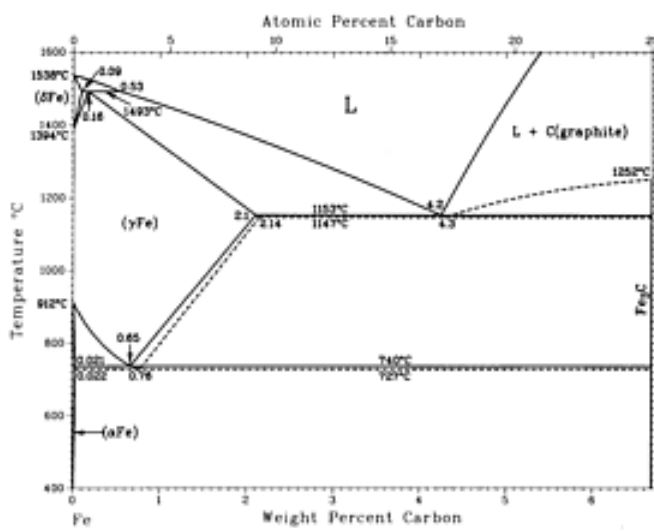
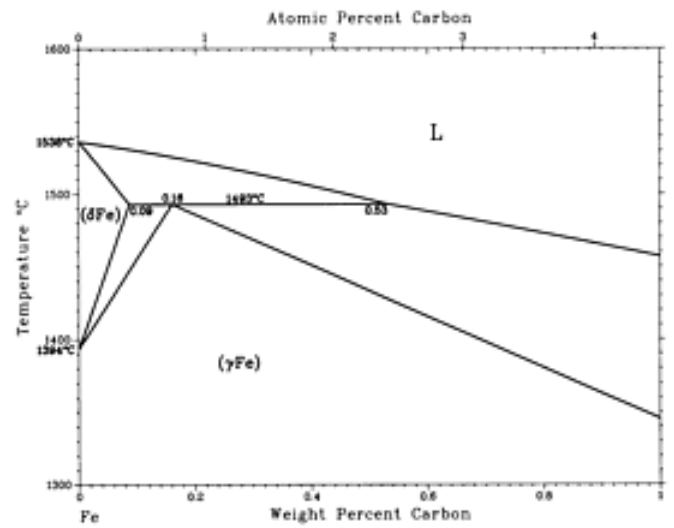
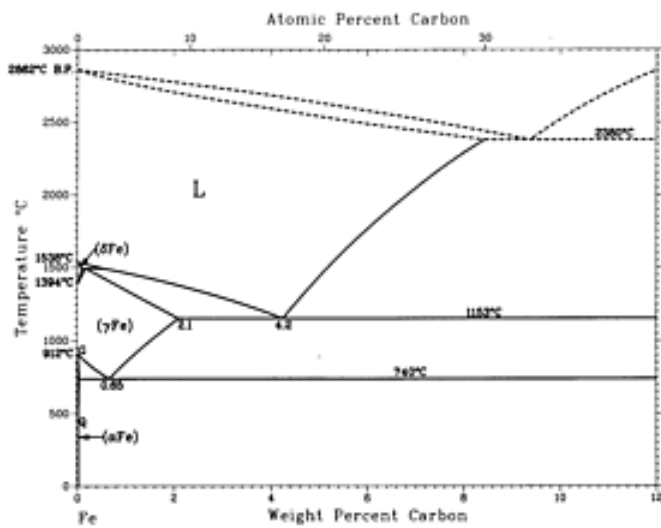

C-Fe phase diagram

C-Fe crystallographic data

Phase	Composition, wt% C	Pearson symbol	Space group
(δ Fe)	0 to 0.09	<i>cI2</i>	<i>Im</i> $\bar{3}m$
(γ Fe)	0 to 2.1	<i>cF4</i>	<i>Fm</i> $\bar{3}m$
(α Fe)	0 to 0.021	<i>cI2</i>	<i>Im</i> $\bar{3}m$
(C)	100	<i>hP4</i>	<i>P6</i> $\bar{3}/mmc$
Metastable/high-pressure phases			

(ϵ Fe)	0	<i>hP2</i>	<i>P6₃/mmc</i>
Martensite	<2.1	<i>tI4</i>	<i>I4/mmm</i>
Fe ₄ C	5.1	<i>cP5</i>	<i>P$\bar{4}$3m</i>
Fe ₃ C (θ)	6.7	<i>oP16</i>	<i>Pnma</i>
Fe ₅ C ₂ (χ)	7.9	<i>mC28</i>	<i>C2/c</i>
Fe ₇ C ₃	8.4	<i>hP20</i>	<i>P6₃mc</i>
Fe ₇ C ₃	8.4	<i>oP40</i>	<i>Pnma</i>
Fe ₂ C (η)	9.7	<i>oP6</i>	<i>Pnmm</i>
Fe ₂ C (ϵ)	9.7	<i>hP*</i>	<i>P6₃22</i>
Fe ₂ C	9.7	<i>hP*</i>	<i>P$\bar{3}$m1</i>
(C)	100	<i>cF8</i>	<i>Fd$\bar{3}$m</i>

C-Hf (Carbon - Hafnium)

H. Okamoto, 1990

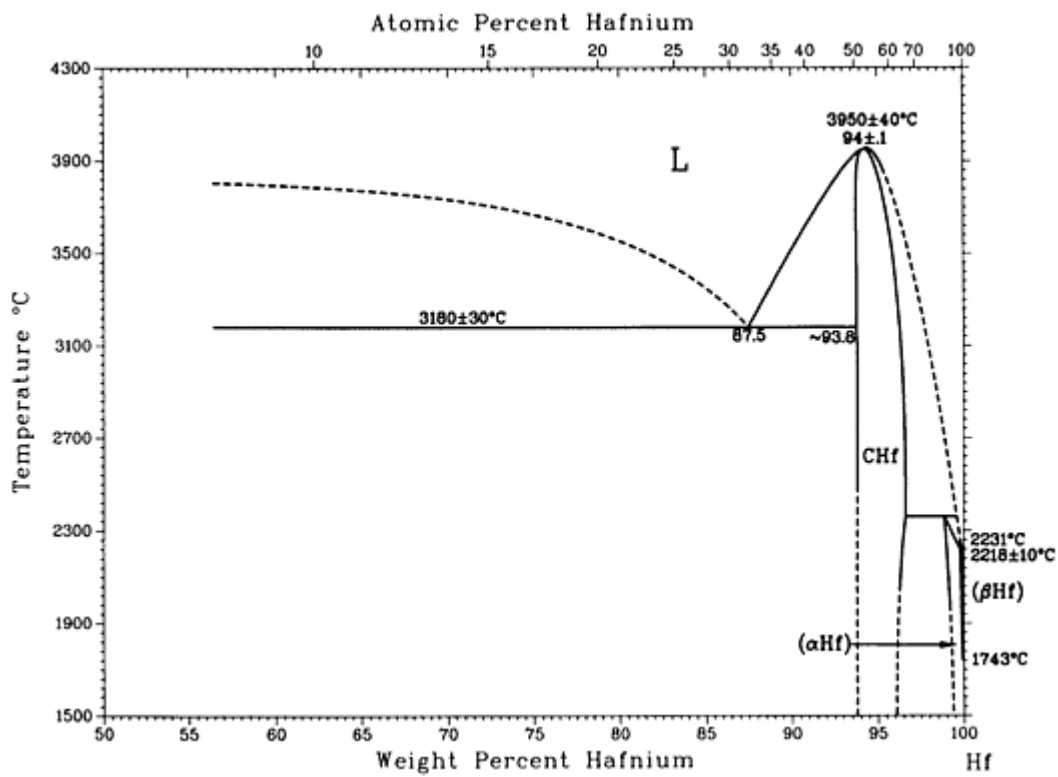

C-Hf phase diagram

C-Hf crystallographic data

Phase	Composition, wt% Hf	Pearson symbol	Space group
(C)	0	<i>hP4</i>	<i>P6₃/mmc</i>
CHf	~93.8 to 96.6	<i>cF8</i>	<i>Fm$\bar{3}m$</i>
(β Hf)	99.9 to 100	<i>cI2</i>	<i>Im$\bar{3}m$</i>
(α Hf)	98.9 to 100	<i>hP2</i>	<i>P6₃/mmc</i>

C-La (Carbon - Lanthanum)

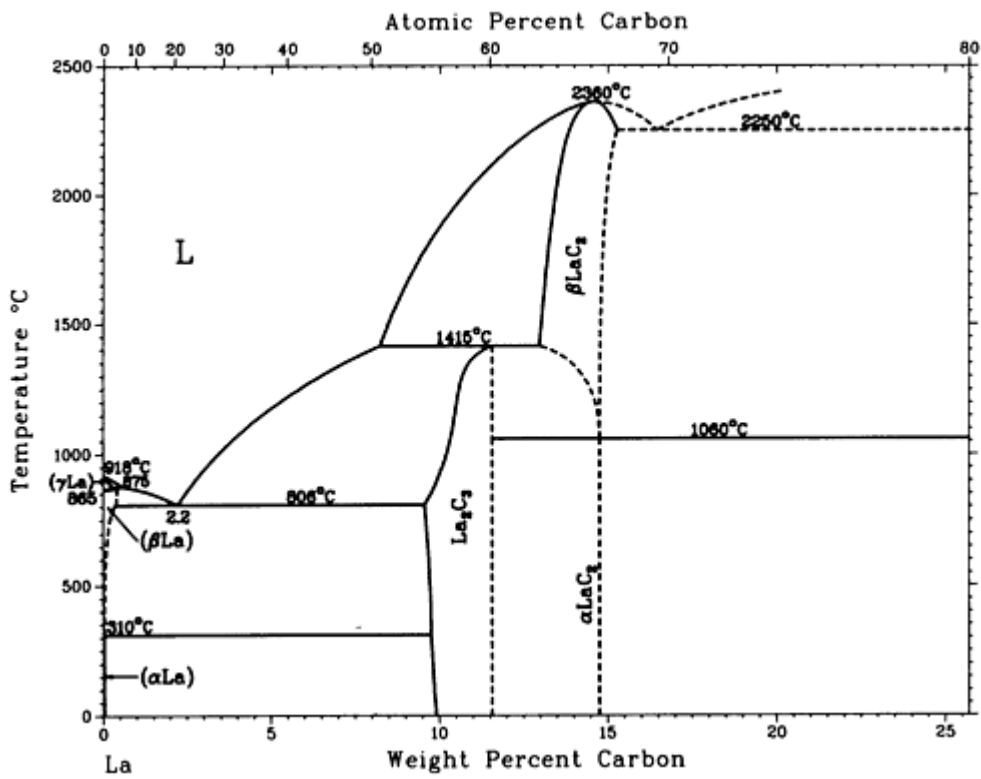

C-La phase diagram

C-La crystallographic data

Phase	Composition, wt% C	Pearson symbol	Space group
(αLa)	0	<i>hP4</i>	<i>P6₃/mmc</i>
(β _{La})	0 to ~0.3	<i>cF4</i>	<i>Fm$\bar{3}m$</i>
(γ _{La})	0 to ~0.2	<i>cI2</i>	<i>Im$\bar{3}m$</i>
La ₂ C ₃	~9 to ~11	<i>cI40</i>	<i>I$\bar{4}3d$</i>
αLaC ₂	~15	<i>tI6</i>	<i>I4/mmm</i>
β _{LaC₂}	~13 to ~15	<i>cF12</i>	<i>Fm$\bar{3}m$</i>
(C)	100	<i>hP4</i>	<i>P6₃/mmc</i>

C-Mn (Carbon - Manganese)

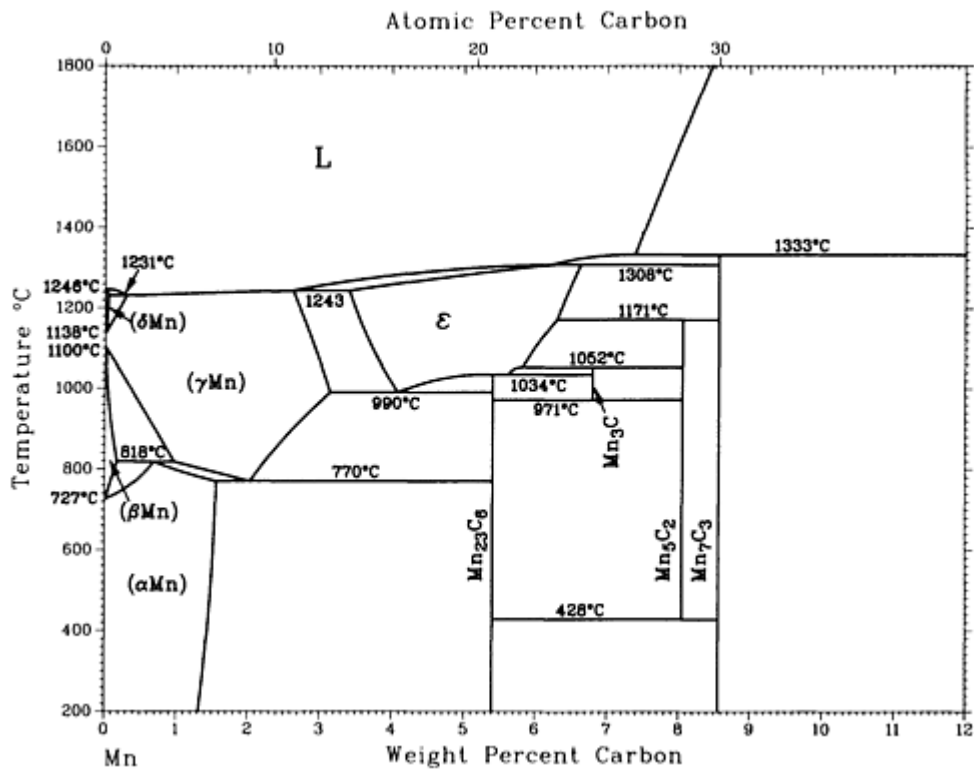

C-Mn phase diagram

C-Mn crystallographic data

Phase	Composition, wt% C	Pearson symbol	Space group
(δ Mn)	0 to 0.02	<i>cI2</i>	<i>Im$\bar{3}m$</i>
(γ Mn)	0 to 3	<i>cF4</i>	<i>Fm$\bar{3}m$</i>
(β Mn)	0 to 0.1	<i>cP20</i>	<i>P4₁32</i>
(α Mn)	0 to 1.5	<i>cI58</i>	<i>I$\bar{4}3m$</i>
ϵ	3.3 to 6.6
Mn ₂₃ C ₆	5.4	<i>cF116</i>	<i>Fm$\bar{3}m$</i>
Mn ₃ C	6.8	<i>oP16</i>	<i>Pnma</i>
Mn ₅ C ₂	8.1	<i>mC28</i>	<i>C2/c</i>

Mn ₇ C ₃	8.6	<i>oP40</i>	<i>Pnma</i>
(C)	100	<i>hP4</i>	<i>P6₃/mmc</i>

C-Mo (Carbon - Molybdenum)

H. Okamoto, 1990

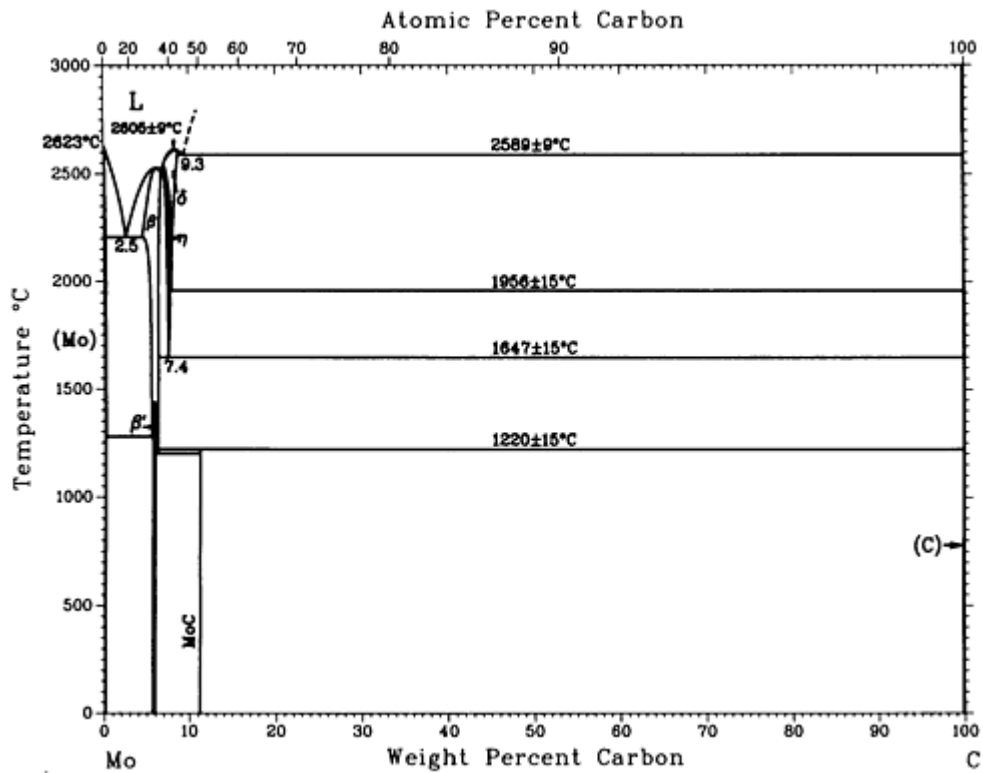

C-Mo phase diagram

C-Mo crystallographic data

Phase	Composition, wt% C	Pearson symbol	Space group
(Mo)	0 to 0.14	<i>cI2</i>	<i>Im$\bar{3}m$</i>
β	4.4 to 6.6	<i>hP3</i>	<i>P6₃/mmc</i>
β'	~5.7	<i>oP12</i>	<i>Pbcn</i>
β''	~5.9

η	6.8 to 7.7	<i>hP8</i>	<i>P6₃/mmc</i>
δ	6.8 to 8.6	<i>oF8</i>	<i>Fm$\bar{3}m$</i>
MoC	11	<i>hP2</i>	<i>P$\bar{6}m2$</i>
(C)	100	<i>hP4</i>	<i>P6₃/mmc</i>

C-Ni (Carbon - Nickel)

M.F. Singleton and P. Nash, 1991

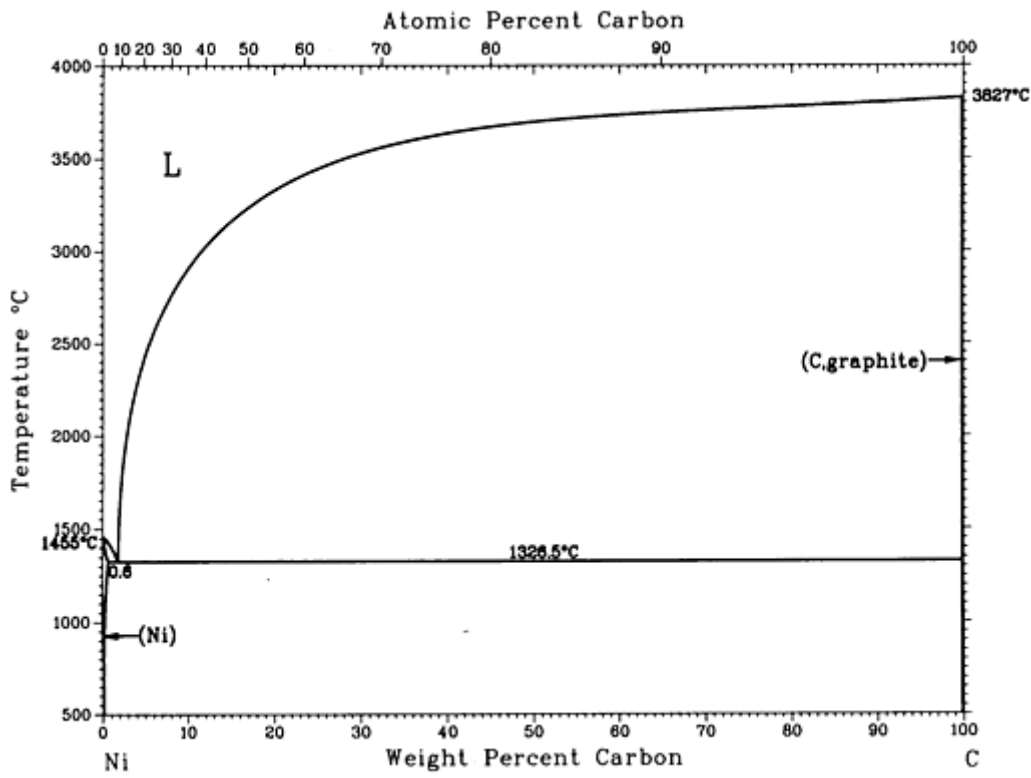

C-Ni phase diagram

C-Ni crystallographic data

Phase	Composition, wt% C	Pearson symbol	Space group
(Ni)	0 to 0.6 ^(a)	<i>cF4</i>	<i>Fm$\bar{3}m$</i>
(C, graphite)	~100	<i>hP4</i>	<i>P6₃/mmc</i>

Metastable phase			
Ni ₃ C	...	<i>oP16</i>	<i>Pnma</i>

(a) Can be extended to 1.6 wt% C at 1314 °C

C-Pr (Carbon - Praseodymium)

H. Okamoto, 1990

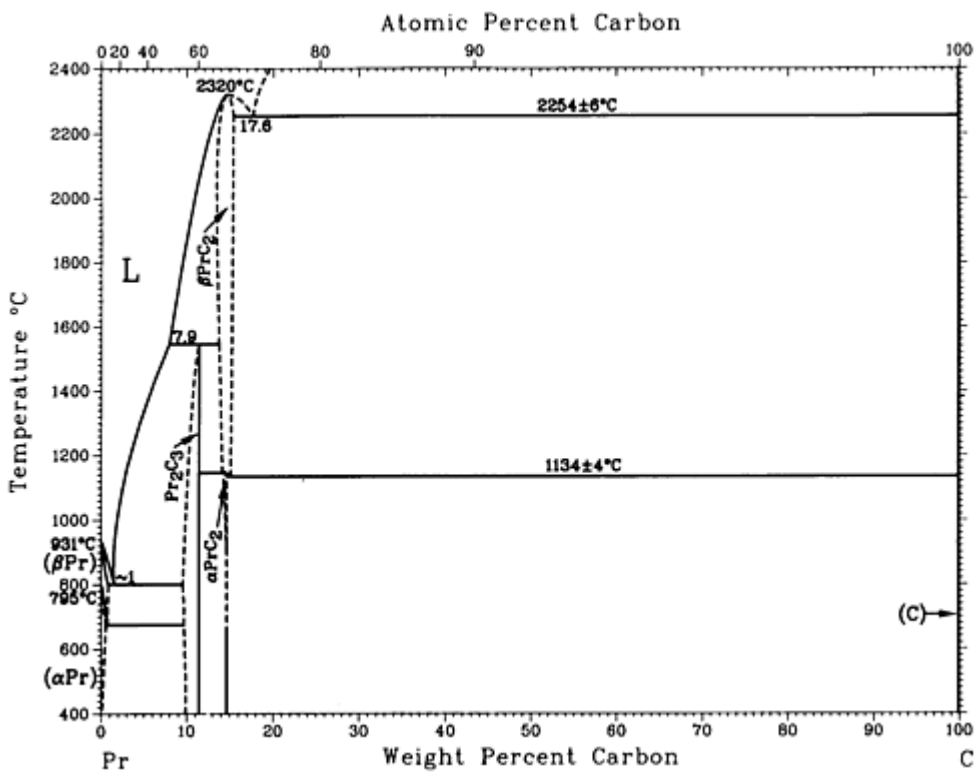

C-Pr phase diagram

C-Pr crystallographic data

Phase	Composition, wt% C	Pearson symbol	Space group
(αPr)	0 to ?	<i>hP4</i>	<i>P6₃/mmc</i>
(βPr)	0 to ?	<i>cI2</i>	<i>Im$\bar{3}m$</i>
Pr ₂ C ₃	~9 to ~11	<i>cI40</i>	<i>I$\bar{4}3d$</i>

αPrC_2	~ 14.6	<i>tI6</i>	<i>I4/mmm</i>
βPrC_2	...	<i>c**</i>	...
(C)	100	<i>hP4</i>	<i>P6₃/mmc</i>

C-Sc (Carbon - Scandium)

O.V. Gordiichuk, 1987

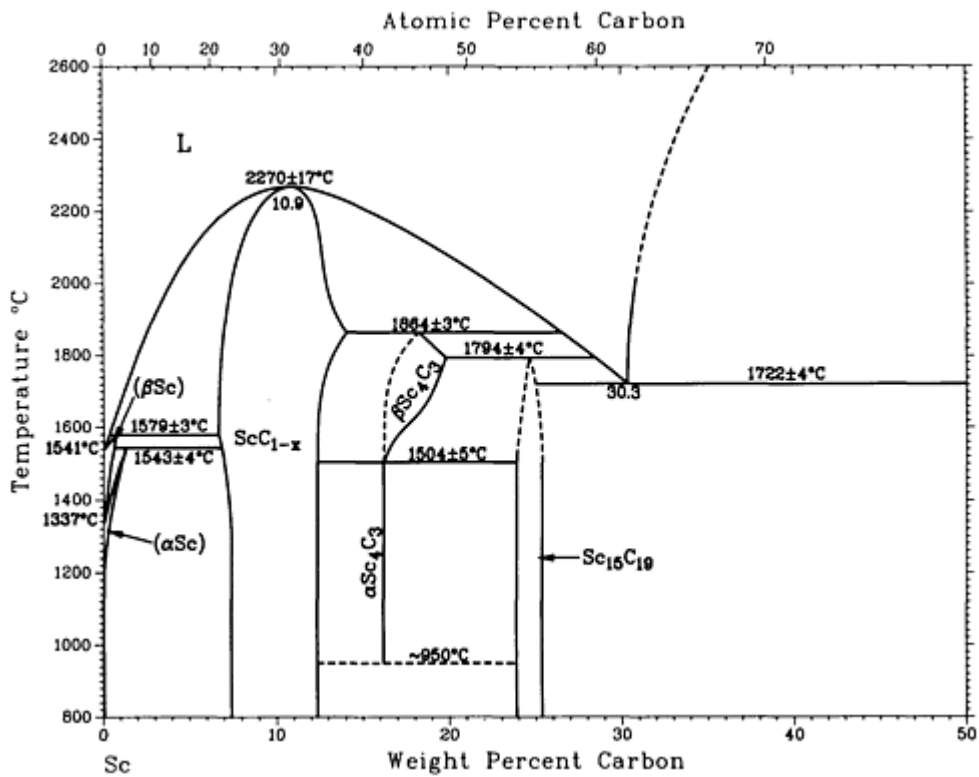

C-Sc phase diagram

C-Sc crystallographic data

Phase	Composition, wt% C	Pearson symbol	Space group
(α Sc)	0	<i>hP2</i>	<i>P6₃/mmc</i>
(β Sc)	0	<i>cI2</i>	<i>Im$\bar{3}m$</i>
Sc_2C	~ 12	<i>hR3</i>	<i>R$\bar{3}m$</i>

Sc ₄ C ₃	16.7	cI28	$I\bar{4}3d$
Sc ₁₃ C ₁₀	17.1	c**	...
Sc ₁₅ C ₁₉	25.3	tP68	$P\bar{4}2_1c$
(C)	100	hP4	$P6_3/mmc$

C-Si (Carbon - Silicon)

R.W. Olesinski and G.J. Abbaschian, 1984

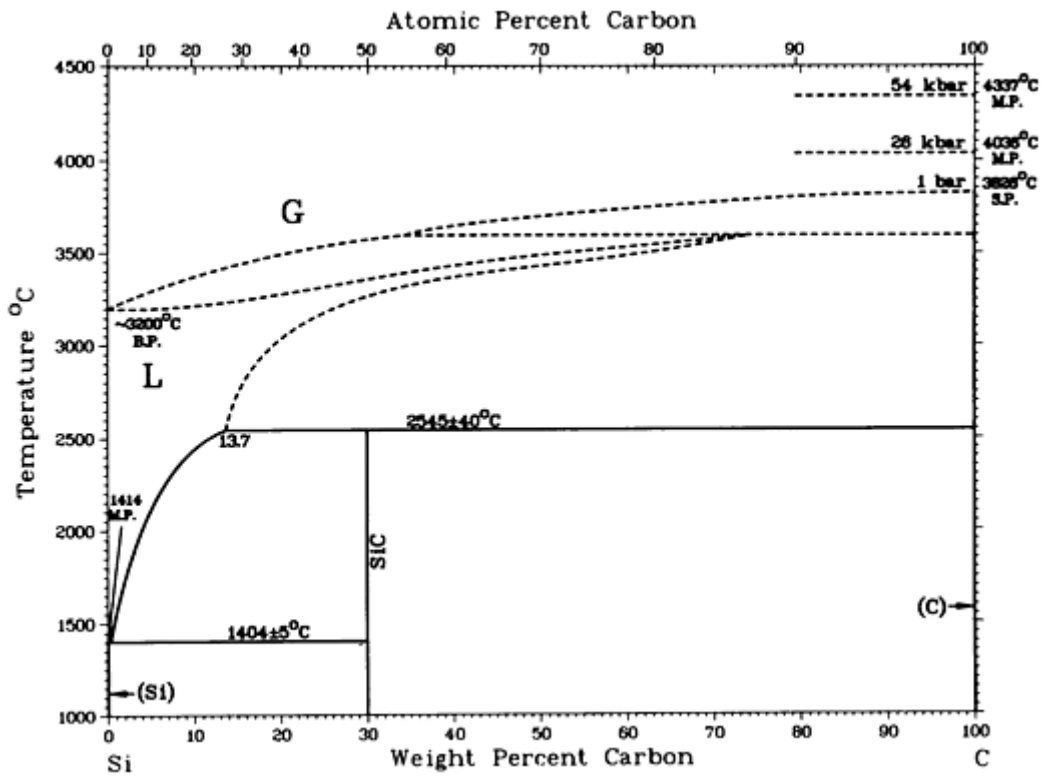

C-Si phase diagram

C-Si crystallographic data

Phase	Composition, wt% C	Pearson symbol	Space group
(Si)	0	cF8	$Fd\bar{3}m$
SiC or β SiC	30	cF8	$F\bar{4}3m$

(C)	100	<i>hP4</i>	<i>P6₃/mmc</i>
Metastable			
α SiC ^(a)	30	(b)	...
Amorphous	22 to 40
High pressure			
SiC II	...	<i>tI4</i>	<i>I4₁/amd</i>

(a) Other SiC polytypes have been reported.

(b) Hexagonal

C-Ta (Carbon - Tantalum)

O.M. Barabash and Yu. N. Koval, 1986

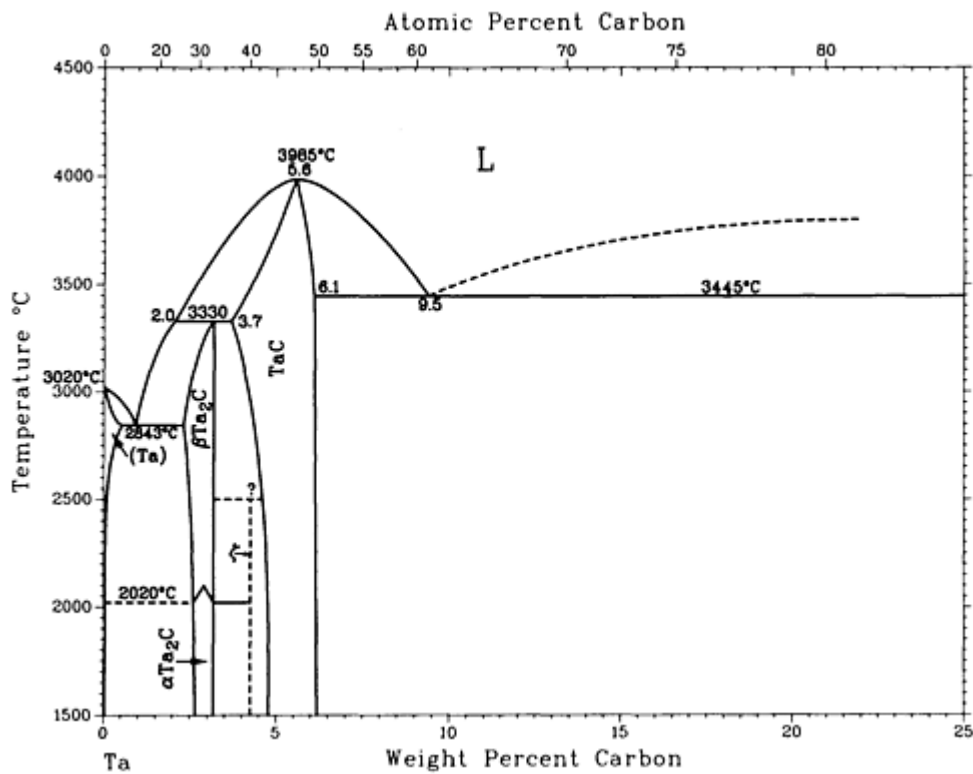

C-Ta phase diagram

C-Ta crystallographic data

Phase	Composition, wt% C	Pearson symbol	Space group
(Ta)	0 to 0.5	<i>cI2</i>	<i>Im</i> $\bar{3}m$
α Ta ₂ C	2.6 to 3.2	<i>hP3</i>	<i>P</i> $\bar{3}m1$
β Ta ₂ C	2.3 to 3.2	<i>hP3</i>	<i>P6</i> ₃ / <i>mmc</i>
ζ	~4.2	<i>hR20</i>	<i>R</i> $\bar{3}m$
TaC	3.7 to 6.1	<i>cF8</i>	<i>Fm</i> $\bar{3}m$
(C)	100	<i>hP4</i>	<i>P6</i> ₃ / <i>mmc</i>

C-Th (Carbon - Thorium)

R. Benz and P.L. Stone, 1969

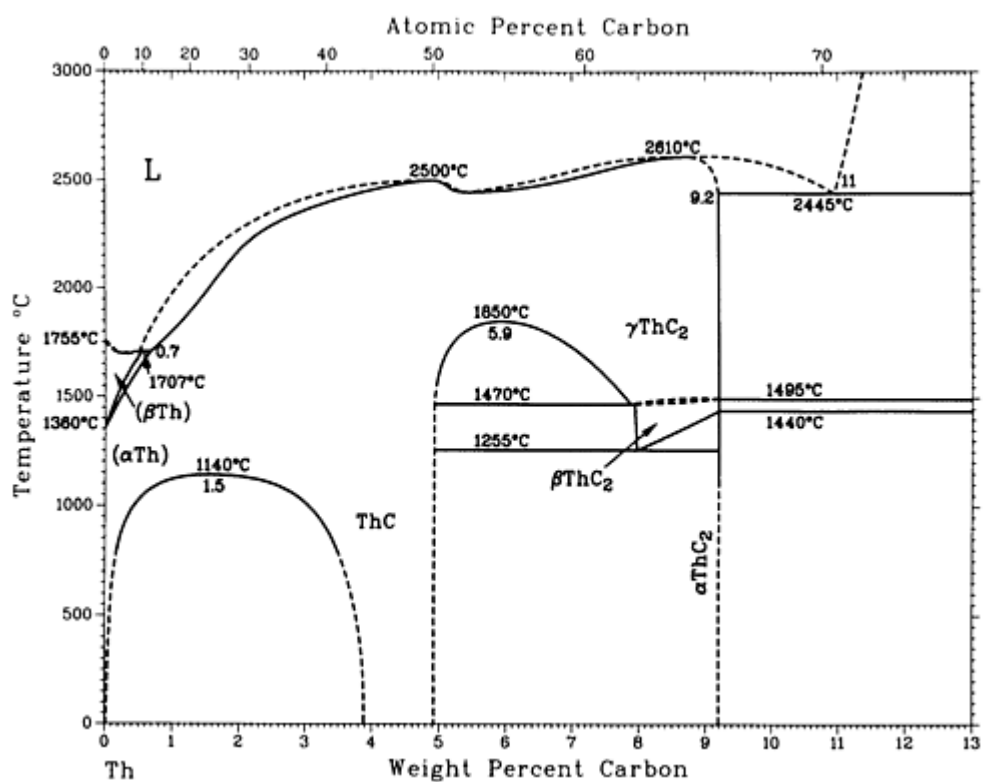

C-Th phase diagram

C-Th crystallographic data

Phase	Composition, wt% C	Pearson symbol	Space group
(β_{Th})	0 to 0.3	$cI2$	$Im\bar{3}m$
(α_{Th})	0 to ?	$cF4$	$Fm\bar{3}m$
ThC	?	$cF8$	$Fm\bar{3}m$
γ_{ThC_2}	? to 9.2	$cP12$	$Pa\bar{3}$
β_{ThC_2}	~ 8.1 to 9.1	$tP6$	$P4_2/mmc$
α_{ThC_2}	~ 9.1	$mC12$	$C2/c$

C-Ti (Carbon - Titanium)

J.L. Murray, 1987

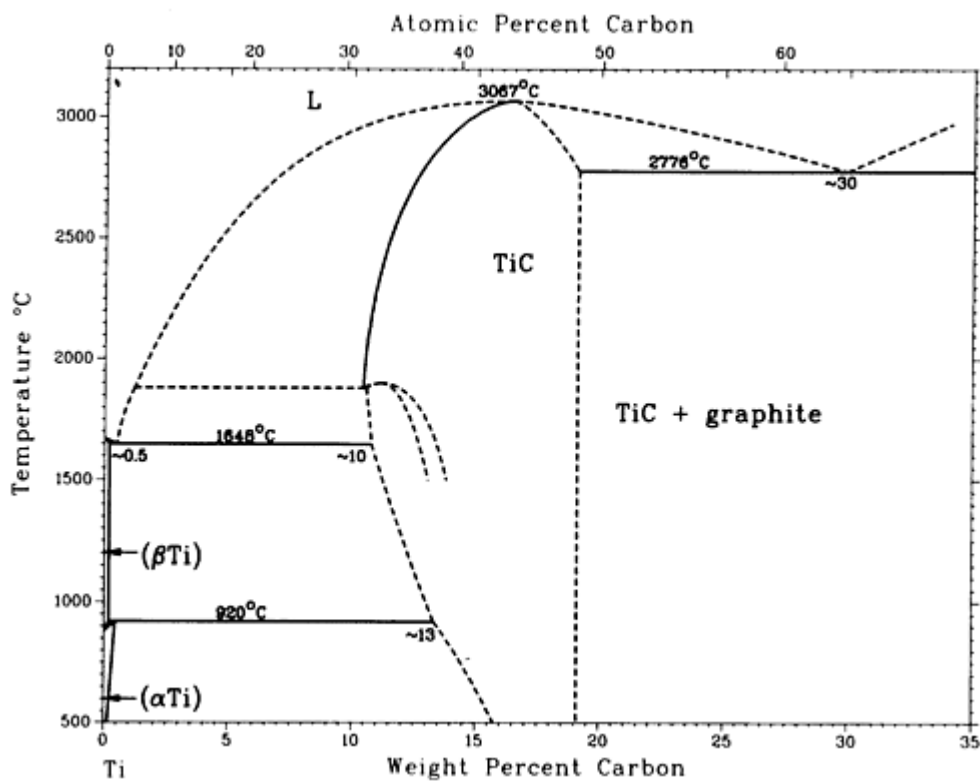

C-Ti phase diagram

C-Ti crystallographic data

Phase	Composition, wt% C	Pearson symbol	Space group
(β Ti)	0 to 0.2	<i>cI2</i>	<i>Im$\bar{3}m$</i>
(α Ti)	0 to 0.4	<i>hP2</i>	<i>P6$_3$/mmc</i>
TiC	~10 to 19.3	<i>cF8</i>	<i>Fm$\bar{3}m$</i>
Ti ₂ C	~10 to 12.4	<i>cF48</i>	<i>Fd$\bar{3}m$</i>
(C)	100	<i>hP4</i>	<i>P6$_3$/mmc</i>

C-U (Carbon - Uranium)

E.K. Storms, 1967; and R. Benz, 1969

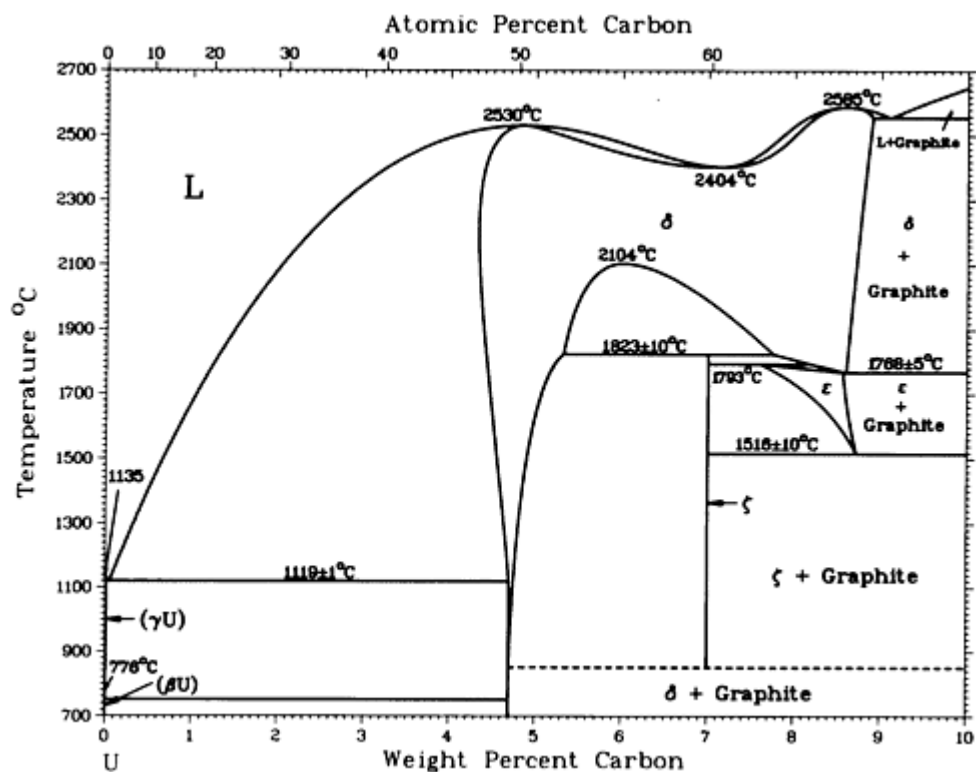

C-U phase diagram

C-U crystallographic data

Phase	Composition, wt% C	Pearson symbol	Space group
(γ_U)	0	<i>cI2</i>	$Im\bar{3}m$
(β_U)	0	<i>tP30</i>	$P4_2/mnm$
δ	~4.3 to 8.9	<i>cF8</i>	$Fm\bar{3}m$
ϵ	~7.6 to 8.7	<i>tI6</i>	$I4/mmm$
ζ	7.0	<i>cI40</i>	$I\bar{4}3d$

C-V (Carbon - Vanadium)

H. Okamoto, 1991

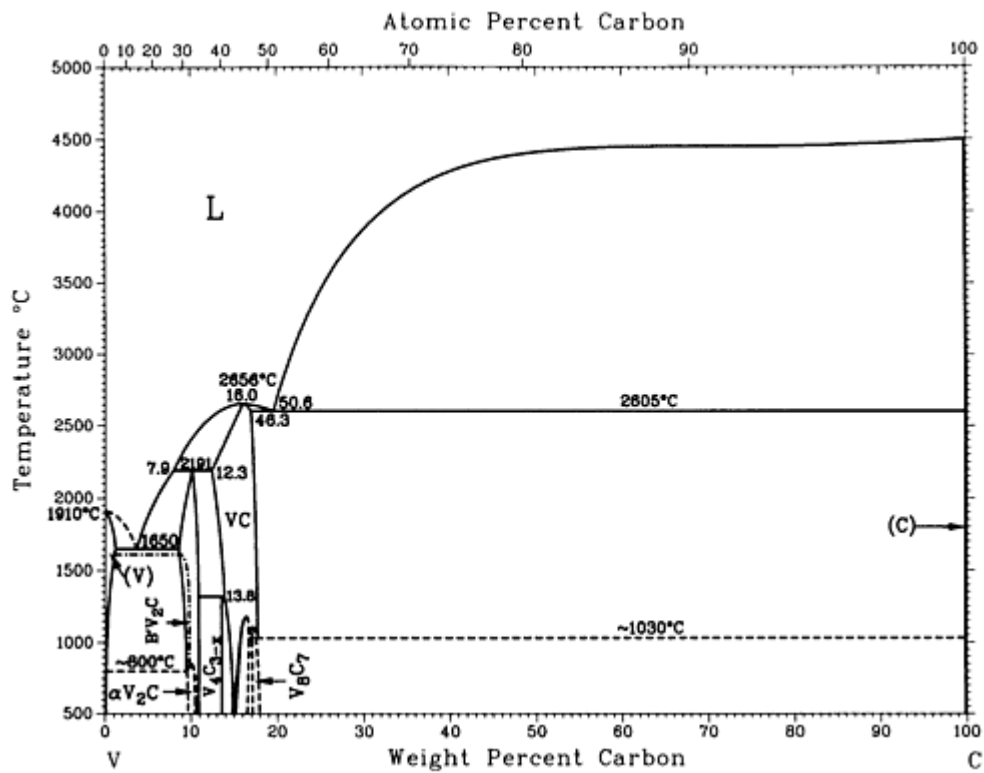

C-V phase diagram

C-V crystallographic data

Phase	Composition, wt% C	Pearson symbol	Space group

(V)	0 to 1.0	<i>cI2</i>	<i>Im</i> $\bar{3}m$
α V ₂ C	9.6 to 10.4	<i>oP12</i>	<i>Pbcn</i>
β V ₂ C	8.5 to 10.8	<i>hP3</i>	<i>P6₃/mmc</i> ^(b)
β V ₂ C ^(a)	~8.6 to 9.9	<i>hP9</i>	<i>P</i> $\bar{3}1m$ ^(b)
V ₄ C _{3-x}	~13.6	<i>hR20</i>	<i>R</i> $\bar{3}m$
VC ^(b)	12.3 to 17.9	<i>cF8</i>	<i>Fm</i> $\bar{3}m$
V ₆ C ₅ ^(c)	15.1 to 16.7	<i>mC44</i>	<i>B2</i>
V ₈ C ₇	16.7 to 17.9	<i>cP60</i>	<i>P4₁32</i> <i>P4₃32</i>
(C)	100	<i>hP4</i>	<i>P6₃/mmc</i>

(a) High-temperature form.

(b) Either one or the other of these two space groups is in error, or the postulated transition in the diagram is in error, with the transition being first order, requiring a two-phase region between the ordered and disordered structures.

(c) Enantiomorphic and twinned forms have been described with other lattice parameters and/or space groups.

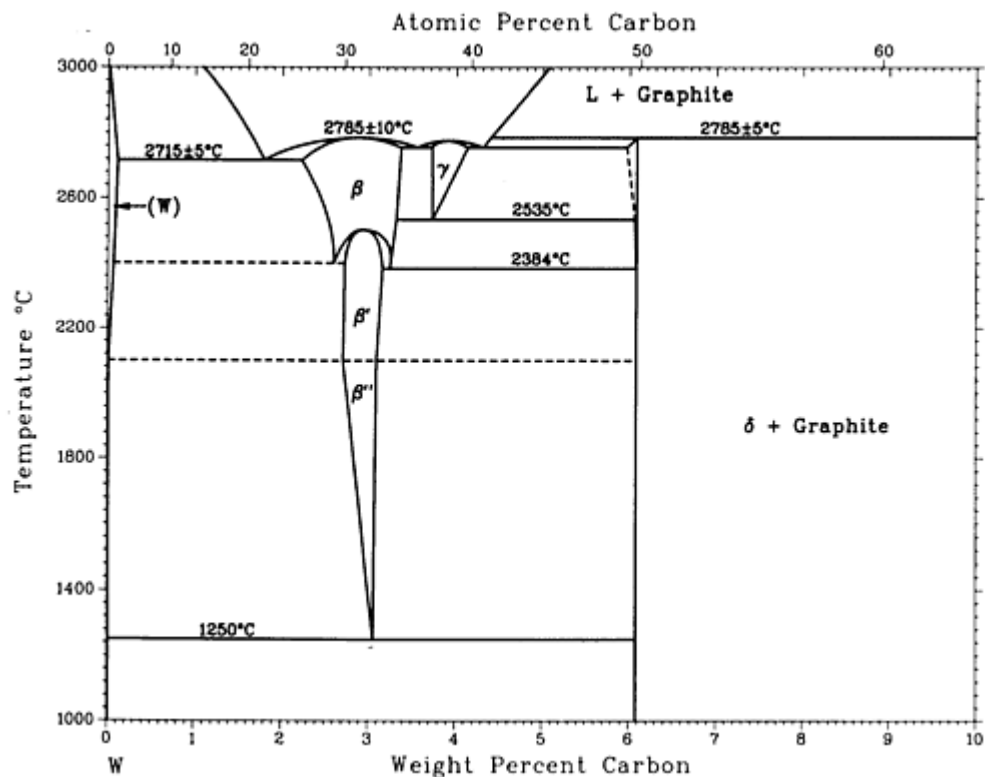

C-W phase diagram

C-W crystallographic data

Phase	Composition, wt% C	Pearson symbol	Space group
(W)	0	<i>cI2</i>	<i>Im$\bar{3}m$</i>
β	~2.2 to 3.3
β'	~2.7 to 3.1	<i>hP3</i>	<i>P6$_3$/mmc</i>
β''	~2.7 to 3.05	<i>hP3</i>	<i>P$\bar{3}m1$</i>
γ	~3.7 to 4.1	<i>cF8</i>	<i>Fm$\bar{3}m$</i>
δ	6.1	<i>hP2</i>	<i>P$\bar{6}m2$</i>

C-Y (Carbon - Yttrium)

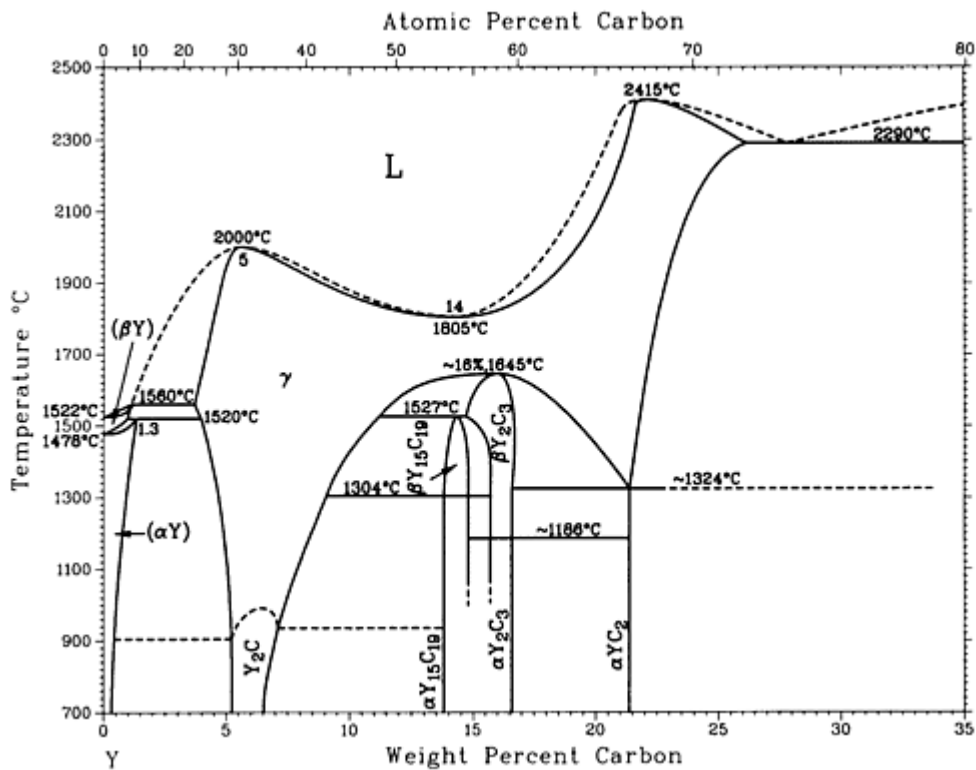

C-Y phase diagram

C-Y crystallographic data

Phase	Composition, wt% C	Pearson symbol	Space group
(αY)	0 to 1.3	<i>hP2</i>	<i>P6₃/mmc</i>
(βY)	0 to 1.0	<i>cI2</i>	<i>Im$\bar{3}m$</i>
Y ₂ C	~6.2	<i>hR3</i>	<i>R$\bar{3}m$</i>
γ	~3.7 to 25.8	<i>cF5</i>	<i>Fm$\bar{3}m$</i>
αY ₁₅ C ₁₉	14.6	<i>tP68</i>	<i>P$\bar{4}2_1c$</i>
Y ₂ C ₃ ^(a)	~17	<i>cI40</i>	<i>I$\bar{4}3d$</i>
αYC ₂	~21.3	<i>tI6</i>	<i>I4/mmm</i>

" β_{YC_2 "	~ 21.3	$cF12$	$Fm\bar{3}m$
(C)	100	$hP4$	$P6_3/mmc$

(a) Metastable form produced under pressure at high temperature

C-Zr (Carbon - Zirconium)

H. Okamoto, 1990

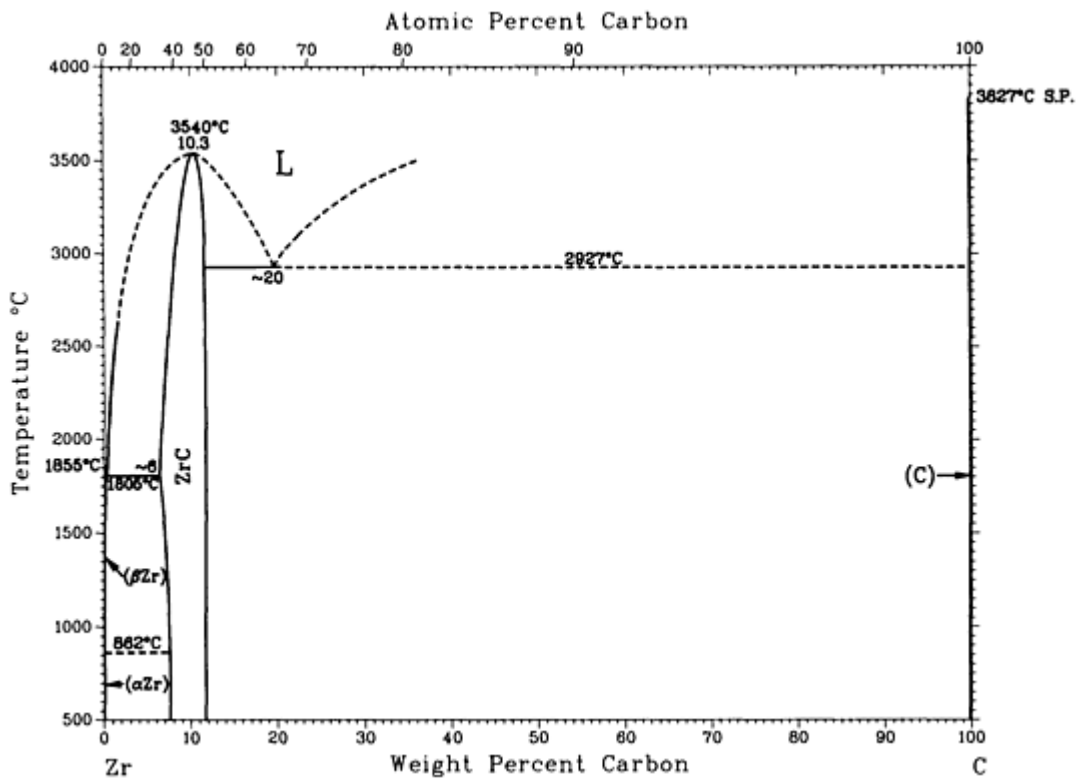

C-Zr phase diagram

C-Zr crystallographic data

Phase	Composition, wt% C	Pearson symbol	Space group
(β_{Zr})	0	$cI2$	$Im\bar{3}m$
(α_{Zr})	0	$hP2$	$P6_3/mmc$

ZrC	~6 to 12	<i>cF8</i>	<i>Fm$\bar{3}m$</i>
(C)	0	<i>hP4</i>	<i>P6$_3$/mmc</i>

Ca (Calcium) Binary Alloy Phase Diagrams

Introduction

THIS ARTICLE includes systems where calcium is the first-named element in the binary pair. Additional binary systems that include calcium are provided in the following locations in this Volume:

- “Ag-Ca (Silver - Calcium)” in the article “Ag (Silver) Binary Alloy Phase Diagrams.”
- “Al-Ca (Aluminum - Calcium)” in the article “Al (Aluminum) Binary Alloy Phase Diagrams.”
- “Au-Ca (Gold - Calcium)” in the article “Au (Gold) Binary Alloy Phase Diagrams.”
- “Ba-Ca (Barium - Calcium)” in the article “Ba (Barium) Binary Alloy Phase Diagrams.”
- “Bi-Ca (Bismuth - Calcium)” in the article “Bi (Bismuth) Binary Alloy Phase Diagrams.”

Ca-Cd (Calcium - Cadmium)

P.R. Subramanian, 1990

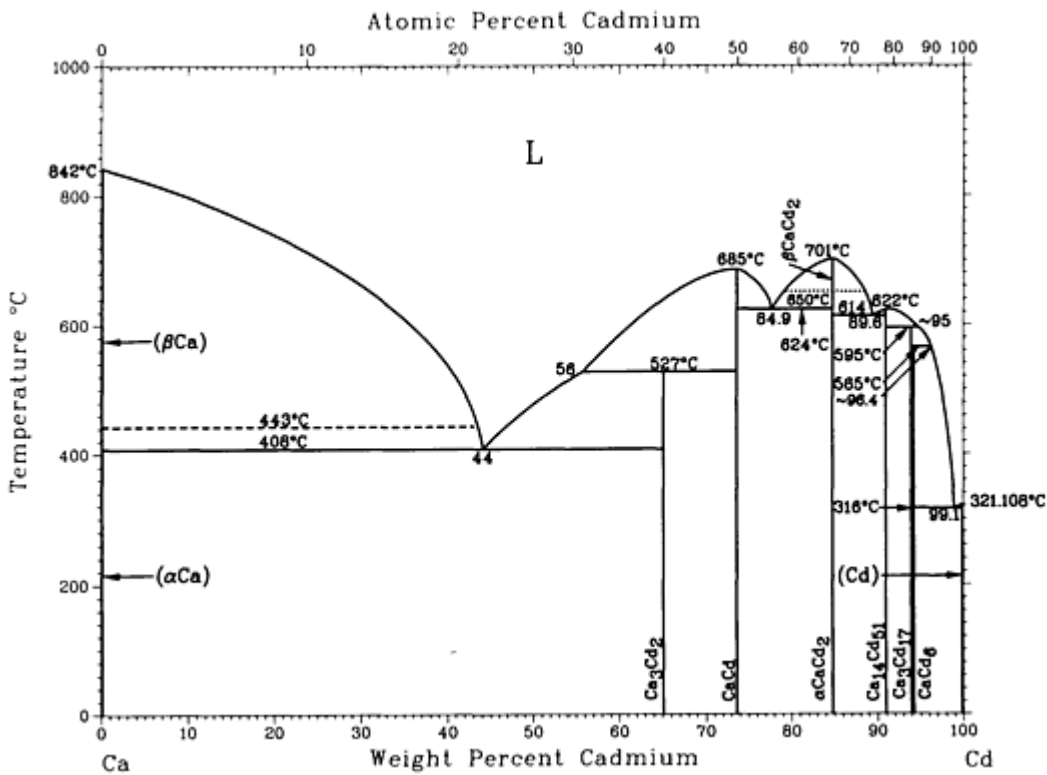

Ca-Cd phase diagram

Ca-Cd crystallographic data

Phase	Composition, wt% Cd	Pearson symbol	Space group
$(\alpha\text{Ca})^{(a)}$	0	<i>cF4</i>	<i>Fm</i> $\bar{3}m$
$(\beta\text{Ca})^{(b)}$	0	<i>cI2</i>	<i>Im</i> $\bar{3}m$
Ca_3Cd_2	65	<i>tP20</i>	<i>P4</i> $_2nm$
CaCd	73.7	<i>cP2</i>	<i>Pm</i> $\bar{3}m$
$\alpha\text{CaCd}_2^{(c)}$	84.9	<i>hP12</i>	<i>P6</i> $_3/mmc$
βCaCd_2	84.9	<i>oI12</i>	<i>Imma</i>
$\text{Ca}_{14}\text{Cd}_{51}$	91.1	<i>hP68</i>	<i>P6/m</i>
$\text{Ca}_3\text{Cd}_{17}$	94
CaCd_6	94.4	<i>cI184</i>	<i>Im</i> $\bar{3}$
(Cd)	100	<i>hP2</i>	<i>P6</i>$_3/mmc$

(a) Below 443 °C.

(b) From 443 to 842 °C.

(c) From 0 to 650 °C.

(d) From 650 to 701 °C

Ca-Cu (Calcium - Copper)

D.J. Chakrabarti and D.E. Laughlin, 1984

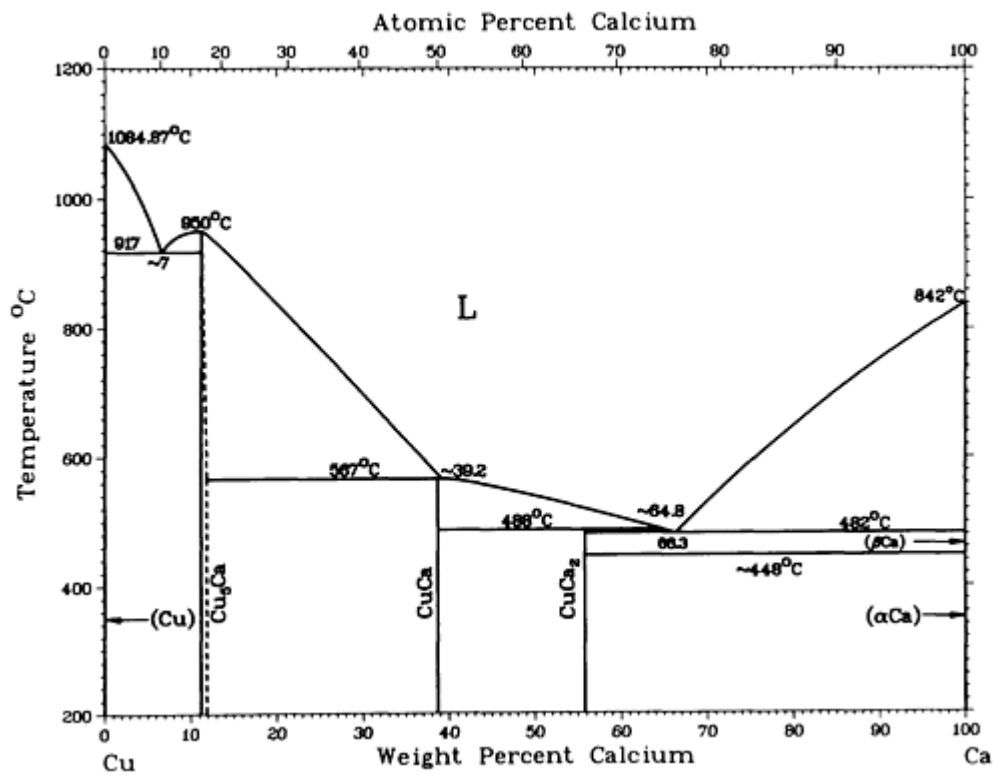

Ca-Cu phase diagram

Ca-Cu crystallographic data

Phase	Composition, wt% Ca	Pearson symbol	Space group
(Cu)	0	<i>cF4</i>	<i>Fm</i> $\bar{3}m$
Cu ₅ Ca	10.7 to 11.4	<i>hP6</i>	<i>P6/mmm</i>
αCuCa ^(b)	38.7	<i>mP20</i>	<i>P2₁/c</i>
βCuCa ^(c)	38.7	<i>oP40</i>	<i>Pnma</i>
CuCa ₂	55.8	<i>oP12</i>	<i>Pnma</i>
(αCa)	100	<i>cF4</i>	<i>Fm</i> $\bar{3}m$
(βCa)	100	<i>cI2</i>	<i>Im</i> $\bar{3}m$

- (a) A much wider homogeneity range (approximately 14.1 to 20 at.% Ca) indicated.
- (b) High temperature; 94.3° interaxial angle.
- (c) Low temperature

Ca-Ga (Calcium - Gallium)

V.P. Itkin and C.B. Alcock, 1992

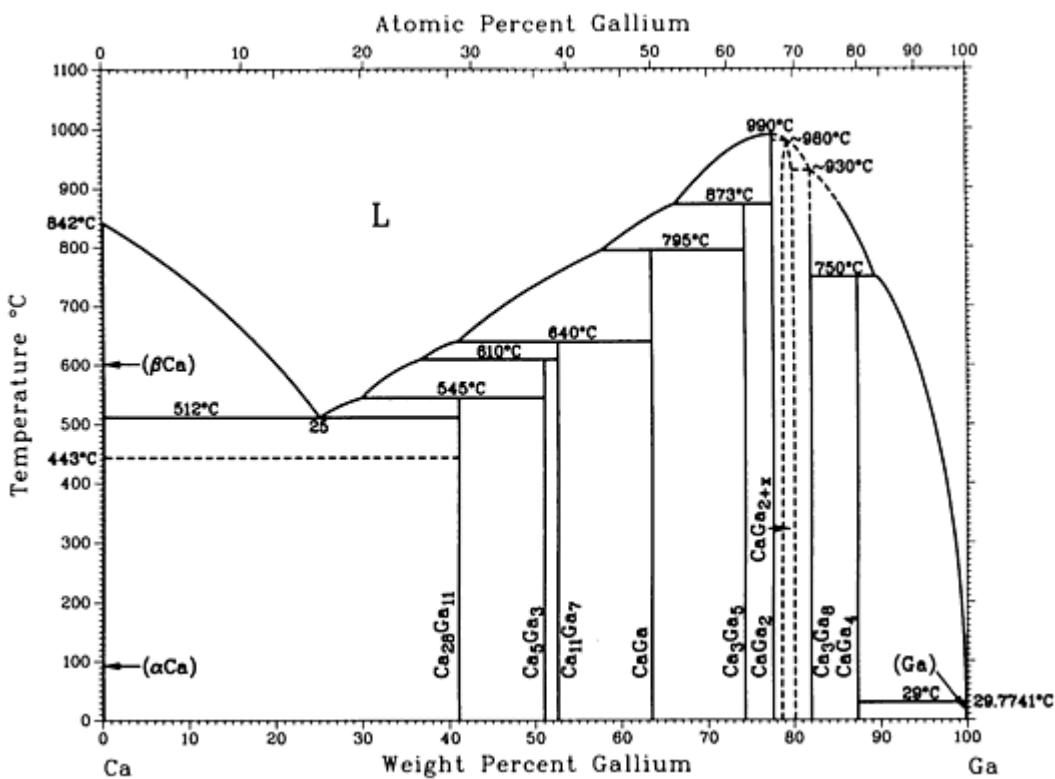

Ca-Ga phase diagram

Ca-Ga crystallographic data

Phase	Composition, wt% Ga	Pearson symbol	Space group
(αCa) ^(a)	0	<i>cF4</i>	<i>Fm</i> $\bar{3}m$
(βCa) ^(b)	0	<i>cI2</i>	<i>Im</i> $\bar{3}m$

$\text{Ca}_{28}\text{Ga}_{11}$	40.6	<i>oI78</i>	<i>Imm2</i>
Ca_5Ga_3	51.1	<i>tI32</i>	<i>I4/mcm</i>
$\text{Ca}_{11}\text{Ga}_7$	52.6	<i>cF144</i>	<i>Fm\bar{3}m</i>
CaGa	63.5	<i>oC8</i>	<i>Cmcm</i>
Ca_3Ga_5	72.4	<i>oC32</i>	<i>Cmcm</i>
CaGa_2	77.7	<i>hP6</i>	<i>P6_3/mmc</i>
CaGa_{2+x}	78.5 to 80.7	<i>hP3</i>	<i>P6/mmc</i>
Ca_3Ga_8	82.2	<i>oI22</i>	<i>Immm</i>
CaGa_4	87	<i>mC10</i>	<i>C2/m</i>
(Ga)	100	<i>oC8</i>	<i>Cmca</i>

(a) <443 °C.

(b) From 443 to 842 °C

Ca-Ge (Calcium - Germanium)

H. Okamoto, 1990

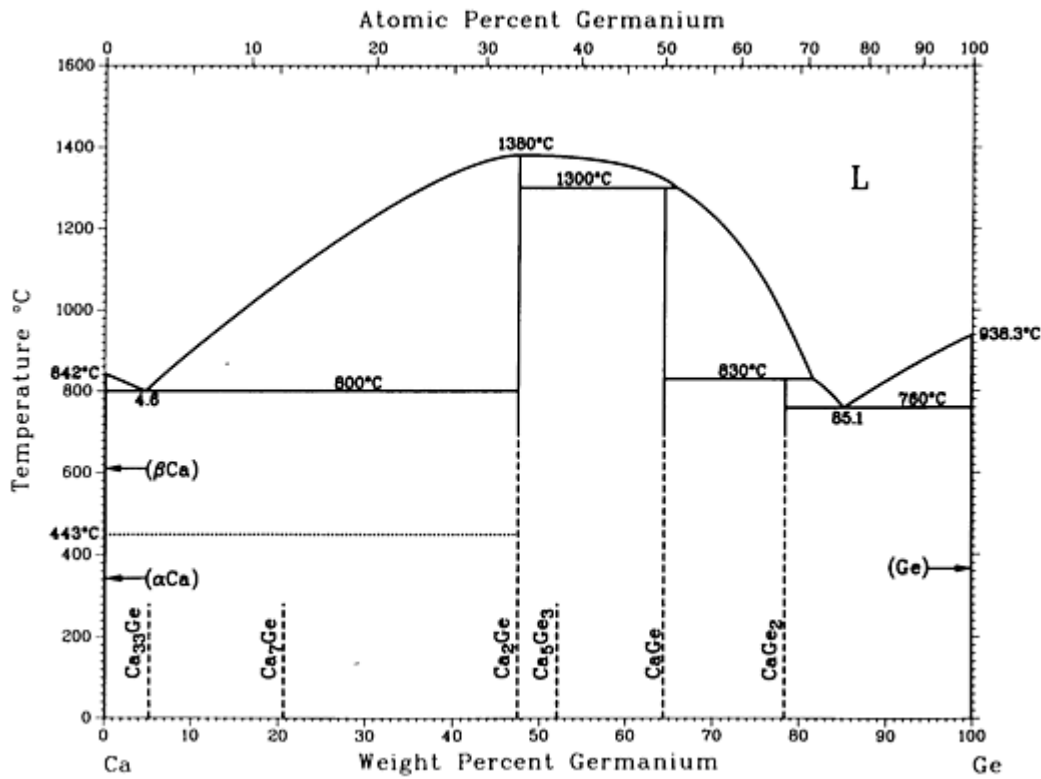

Ca-Ge phase diagram

Ca-Ge crystallographic data

Phase	Composition, wt% Ge	Pearson symbol	Space group
(βCa)	0	<i>cI2</i>	<i>Im</i> $\bar{3}m$
(αCa)	0	<i>cF4</i>	<i>Fm</i> $\bar{3}m$
Ca ₃₃ Ge	5.1	<i>cF48</i>	<i>Fd</i> $\bar{3}m$
Ca ₇ Ge	20.6	<i>cF32</i>	<i>Fm</i> $\bar{3}m$
Ca ₂ Ge	47.5	<i>oP12</i>	<i>Pnma</i>
Ca ₅ Ge ₃	52.1	<i>tI32</i>	<i>I4/mcm</i>

CaGe	64.4	<i>oC8</i>	<i>Cmcm</i>
CaGe ₂	78.4	<i>hR6</i>	<i>R$\bar{3}m$</i>
(Ge)	100	<i>cF8</i>	<i>Fm$\bar{3}m$</i>

Ca-Hg (Calcium - Mercury)

P.R. Subramanian, 1990

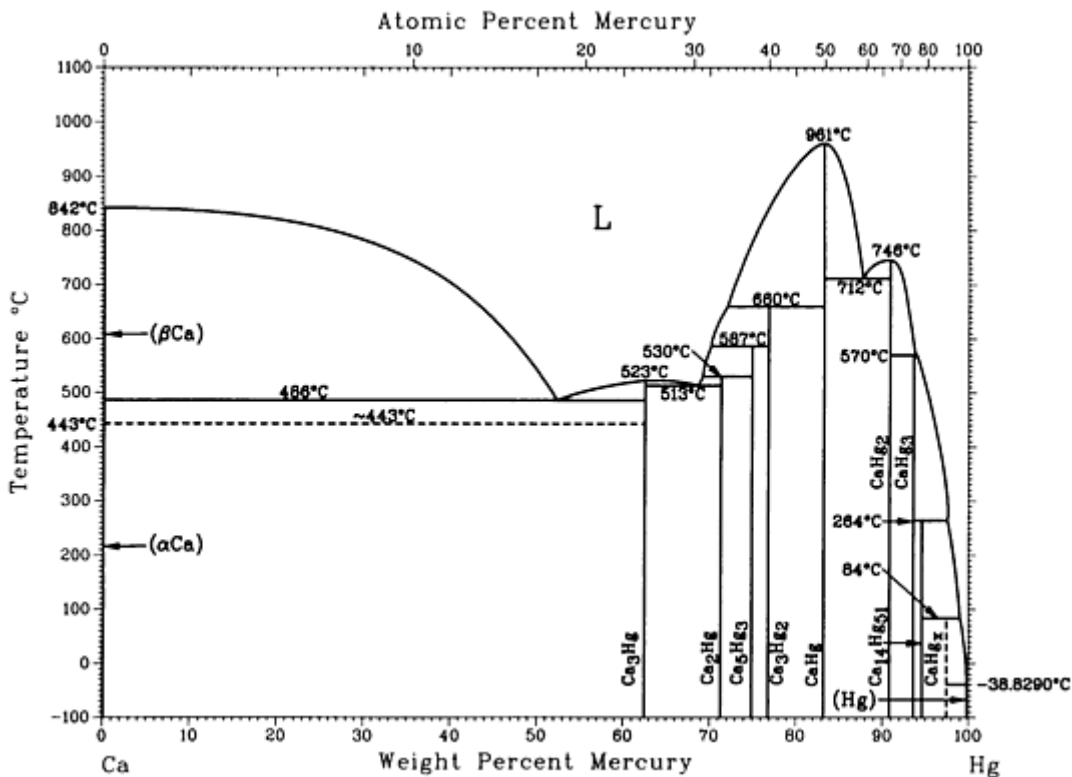

Ca-Hg phase diagram

Ca-Hg crystallographic data

Phase	Composition, wt% Hg	Pearson symbol	Space group
$(\alpha\text{Ca})^{(a)}$	0	<i>cF4</i>	<i>Fm$\bar{3}m$</i>
$(\beta\text{Ca})^{(b)}$	0	<i>cI2</i>	<i>Im$\bar{3}m$</i>
Ca_3Hg	63	<i>oP16</i>	<i>Pnma</i>

		<i>cI32</i>	<i>I43m</i>
Ca ₂ Hg	71.4	<i>oP12</i>	<i>Pnma</i>
Ca ₅ Hg ₃	75.0	<i>tI32</i>	<i>I4/mcm</i>
Ca ₃ Hg ₂	77	<i>tP10</i>	<i>P4/mbm</i>
CaHg	83.3	<i>cP2</i>	<i>Pm3̄m</i>
CaHg ₂	90.9	<i>hP3</i> <i>hP3</i>	<i>P3̄m1</i> <i>P6/mmm</i>
CaHg ₃	94	<i>hP8</i>	<i>P6₃/mmc</i>
Ca ₁₄ Hg ₅₁	94.8	<i>hP68</i>	<i>P6/m</i>
CaHg _x	~98
(Hg)	100	<i>hR1</i>	<i>R3̄m</i>

(a) Below 443 °C.

(b) From 443 to 842 °C

Ca-In (Calcium - Indium)

H. Okamoto, V.P. Itkin, and C.B. Alcock, 1992

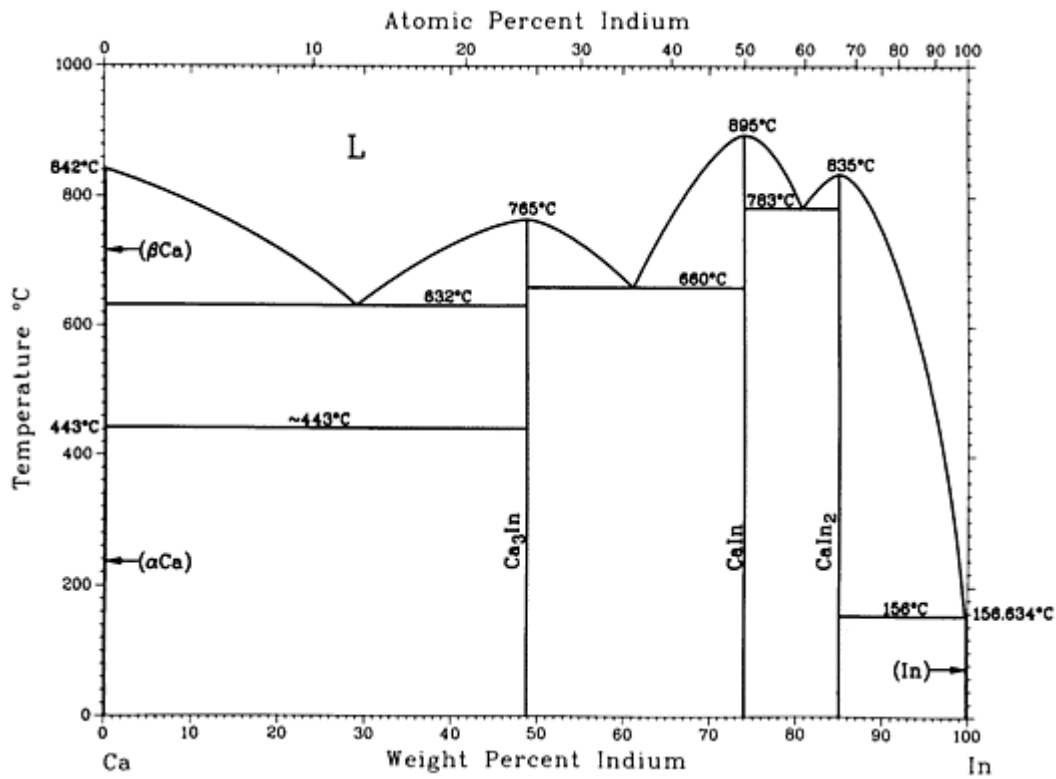

Ca-In phase diagram

Ca-In crystallographic data

Phase	Composition, wt% In	Pearson symbol	Space group
(βCa)	0	<i>cI2</i>	<i>Im</i> $\bar{3}m$
(αCa)	0	<i>cF4</i>	<i>Fm</i> $\bar{3}m$
Ca ₃ In	49	<i>cF16</i>	<i>Fm</i> $\bar{3}m$
CaIn	74.1	<i>cP2</i>	<i>Pm</i> $\bar{3}m$
CaIn ₂	85.2	<i>hP6</i>	<i>P6₃/mmc</i>
(In)	100	<i>tI2</i>	<i>I4/mmm</i>

Ca-Li (Calcium - Lithium)

C.W. Bale and A.D. Pelton, 1987

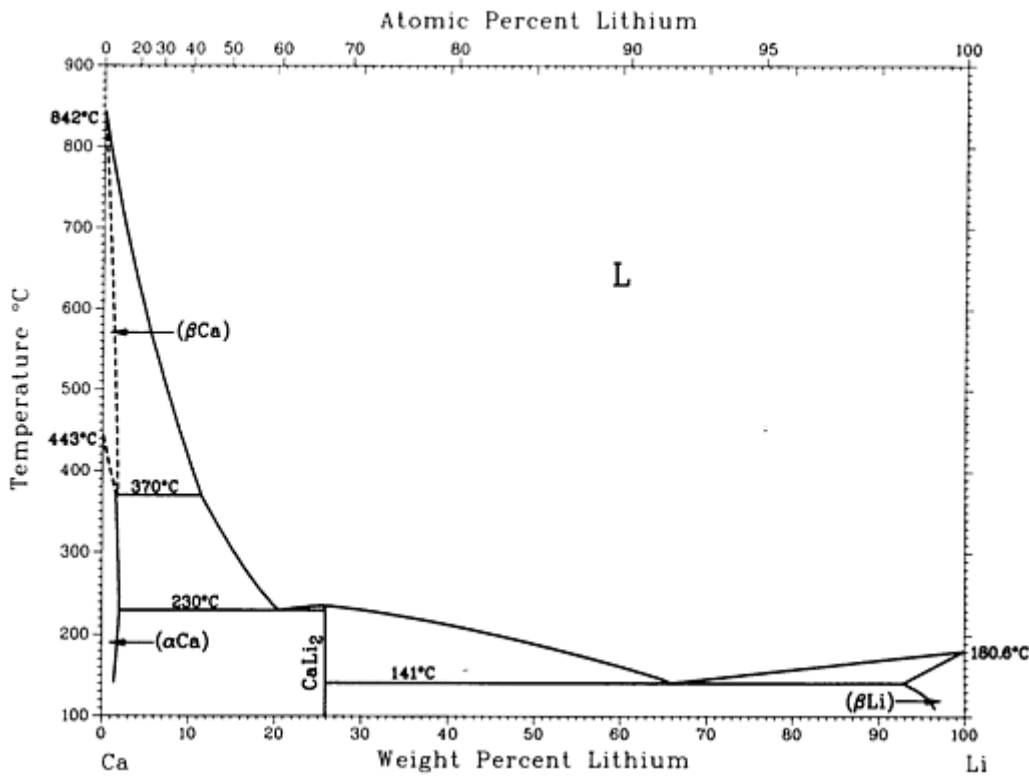

Ca-Li phase diagram

Ca-Li crystallographic data

Phase	Composition, wt% Li	Pearson symbol	Space group
(αCa)	0	<i>cF4</i>	<i>Fm</i> $\bar{3}m$
(βCa)	0	<i>cI2</i>	<i>Im</i> $\bar{3}m$
CaLi ₂	87.4	<i>hP12</i>	<i>P6</i> ₃ <i>/mmc</i>
(αLi)	100	<i>hP2</i>	<i>P6</i> ₃ <i>/mmc</i>
(βLi)	100	<i>cI2</i>	<i>Im</i> $\bar{3}m$

Ca-Mg (Calcium - Magnesium)

A.A. Nayeb-Hashemi and J.B. Clark, 1988

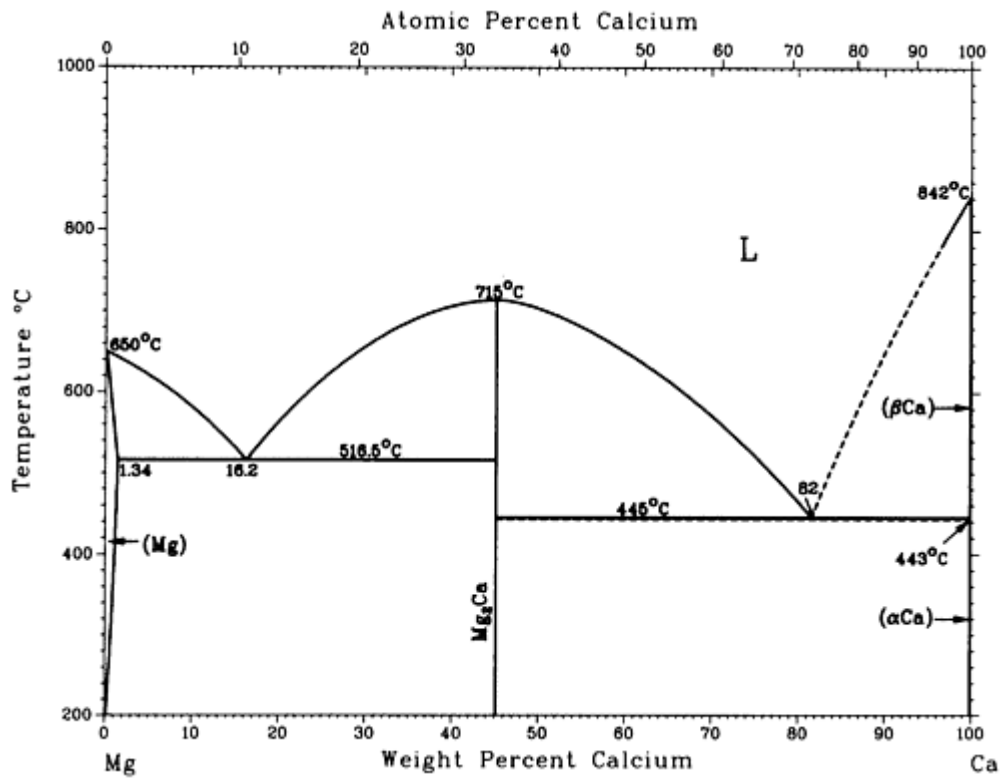

Ca-Mg phase diagram

Ca-Mg crystallographic data

Phase	Composition, wt% Ca	Pearson symbol	Space group
(Mg)	0	<i>hP2</i>	<i>P6₃/mmc</i>
Mg ₂ Ca	45.2	<i>hP12</i>	<i>P6₃/mmc</i>
(βCa)	100	<i>cI2</i>	<i>Im$\bar{3}m$</i>
(αCa)	100	<i>cF4</i>	<i>Fm$\bar{3}m$</i>

Ca-Na (Calcium - Sodium)

A.D. Pelton, 1985

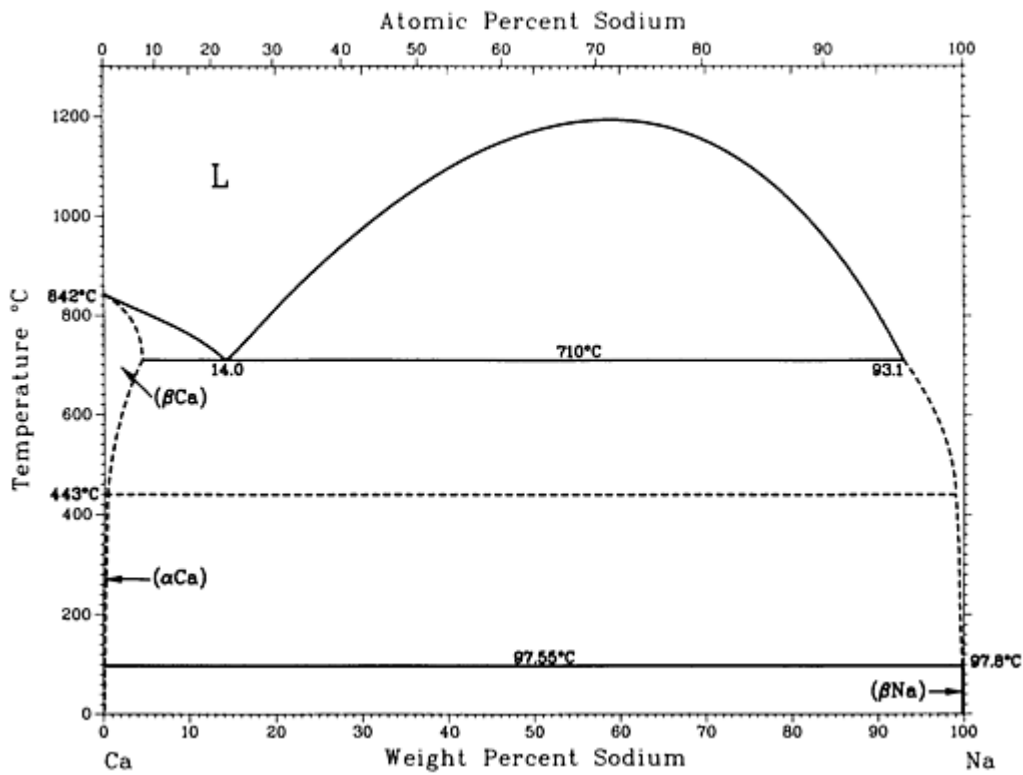

Ca-Na phase diagram

Ca-Na crystallographic data

Phase	Composition, wt% Na	Pearson symbol	Space group
(α Ca)	0	<i>cF4</i>	<i>Fm</i> $\bar{3}m$
(β Ca)	0 to ~4.4	<i>cI2</i>	<i>Im</i> $\bar{3}m$
(β Na)	100	<i>cI2</i>	<i>Im</i> $\bar{3}m$
(α Na)	100	<i>hP2</i>	<i>P6</i> ₃ / <i>mmc</i>

Ca-Nd (Calcium - Neodymium)

K.A. Gschneidner, Jr. and F.W. Calderwood, 1987

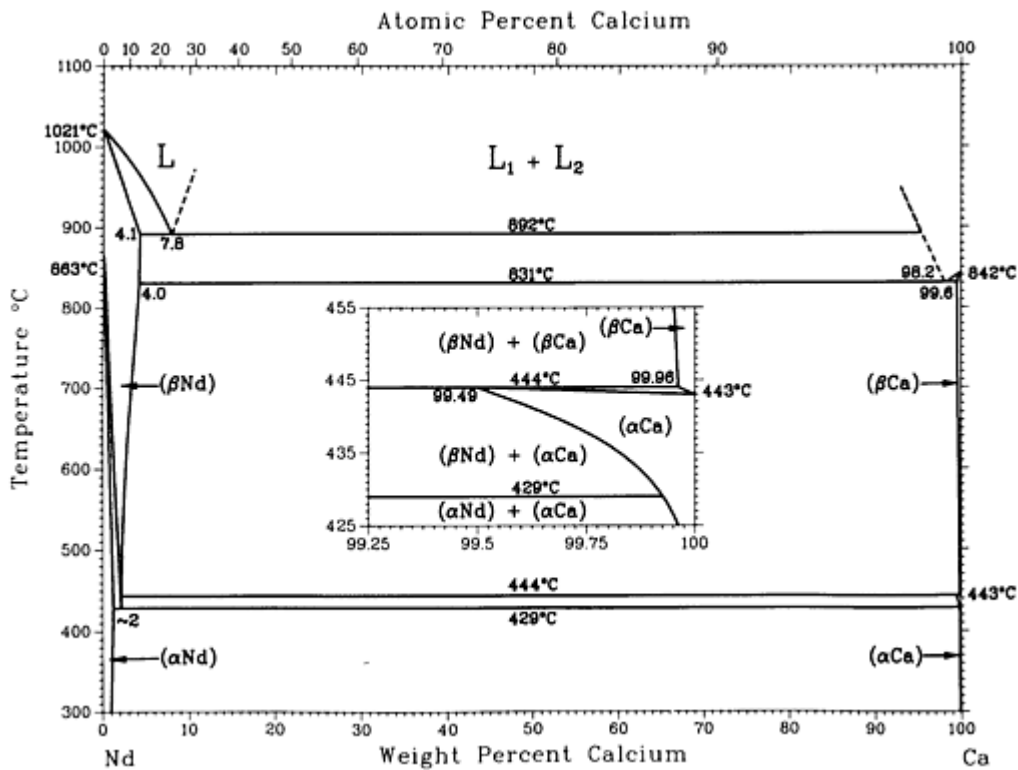

Ca-Nd phase diagram

Ca-Nd crystallographic data

Phase	Composition, wt% Ca	Pearson symbol	Space group
(αNd)	0	<i>hP4</i>	<i>P6₃/mmc</i>
(βNd)	0	<i>cI2</i>	<i>Im$\bar{3}m$</i>
(αCa)	99.5 to 100	<i>cF4</i>	<i>Fm$\bar{3}m$</i>
(βCa)	99.6 to 100	<i>cI2</i>	<i>Im$\bar{3}m$</i>

Ca-Ni (Calcium - Nickel)

H. Okamoto, 1991

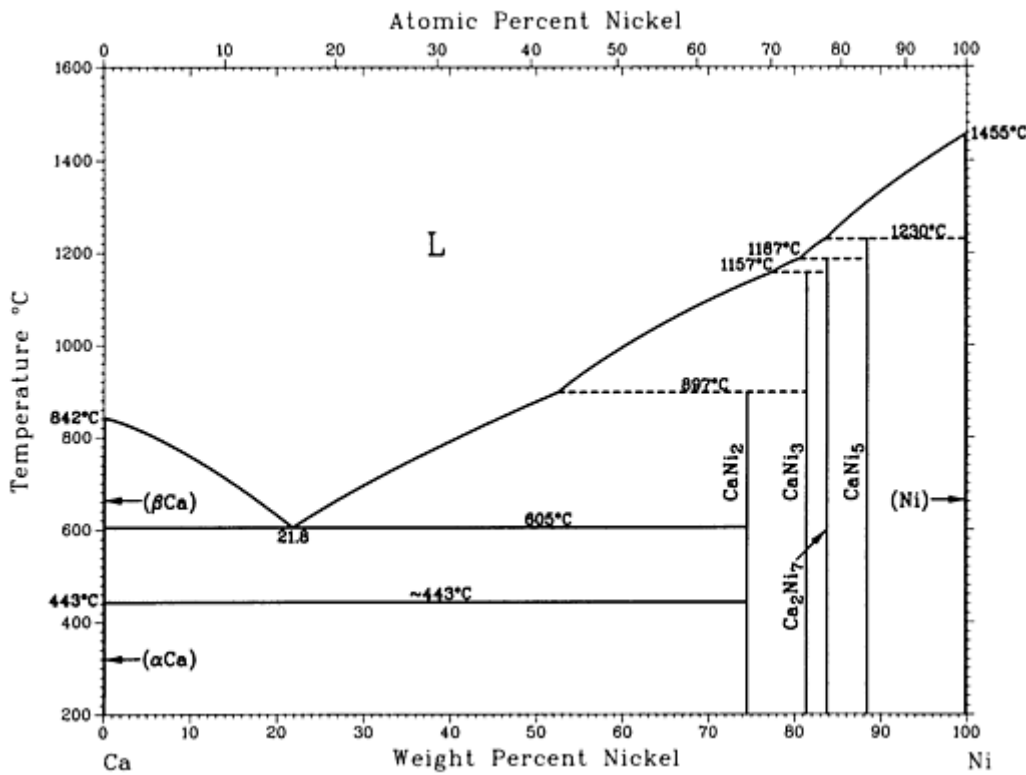

Ca-Ni phase diagram

Ca-Ni crystallographic data

Phase	Composition, wt% Ni	Pearson symbol	Space group
(βCa)	0	<i>cI2</i>	<i>Im</i> $\bar{3}m$
(αCa)	0	<i>cF4</i>	<i>Fm</i> $\bar{3}m$
CaNi ₂	74.6	<i>cF24</i>	<i>Fd</i> $\bar{3}m$
Ca ₂ Ni ₅ ^(a)	78.5	<i>hP*</i>	?
CaNi ₃	82	<i>hR12</i>	<i>R</i> $\bar{3}m$
Ca ₂ Ni ₇	83.7	<i>hR18</i>	<i>R</i> $\bar{3}m$

CaNi ₅	88.0	<i>hP6</i>	<i>P6/mmm</i>
(Ni)	100	<i>cF4</i>	<i>Fm$\bar{3}m$</i>

(a) Not shown on diagram

Ca-O (Calcium - Oxygen)

H.A. Wriedt, 1985

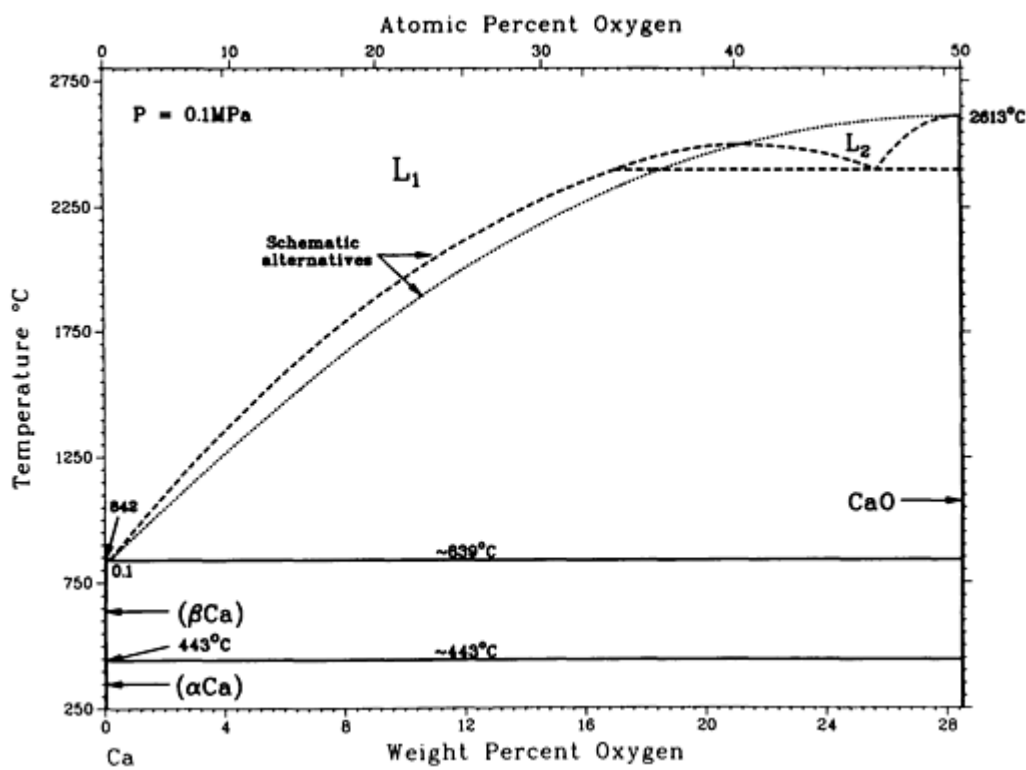

Ca-O (condensed system) phase diagram

Ca-O crystallographic data

Phase	Composition, wt% O	Pearson symbol	Space group
(αCa)	0	<i>cF4</i>	<i>Fm$\bar{3}m$</i>
(βCa)	0	<i>cI2</i>	<i>Im$\bar{3}m$</i>
CaO	28.5	<i>cF8</i>	<i>Fm$\bar{3}m$</i>

CaO ₂	44.4	<i>I</i> 6	<i>I4/mmm</i>
CaO ₄	62
CaO ₆	66.6

Ca-Pb (Calcium - Lead)

V.P. Itkin and C.B. Alcock, 1992

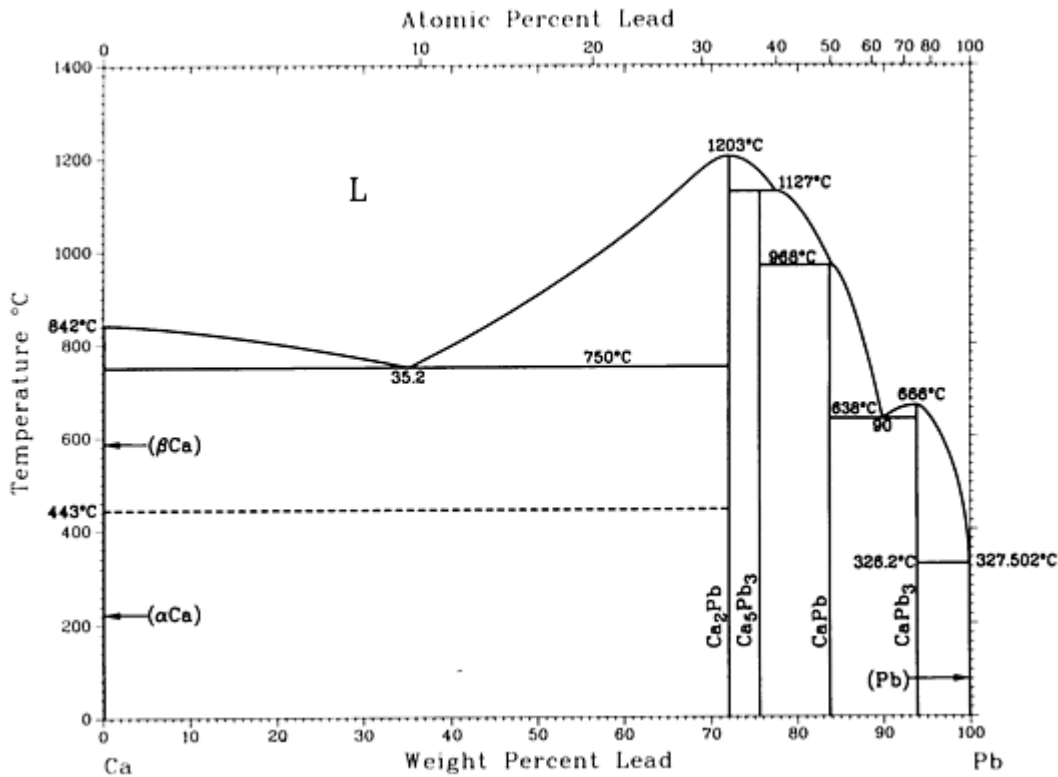

Ca-Pb phase diagram

Ca-Pb crystallographic data

Phase	Composition, wt% Pb	Pearson symbol	Space group
(αCa)	0	<i>cF4</i>	<i>Fm</i> $\bar{3}m$
(βCa)	0	<i>cI2</i>	<i>Im</i> $\bar{3}m$
Ca ₂ Pb	72.1	<i>oP12</i>	<i>Pnma</i>

Ca ₅ Pb ₃	75.6	<i>hP48</i>	<i>P6₃/mc</i>
CaPb	83.8	<i>tP4</i>	<i>P4/mmm</i>
CaPb ₃	94	<i>cP4</i>	<i>Pm$\bar{3}m$</i>
(Pb)	99.9 to 100	<i>cF4</i>	<i>Fm$\bar{3}m$</i>

Ca-Pd (Calcium - Palladium)

H. Okamoto, 1992

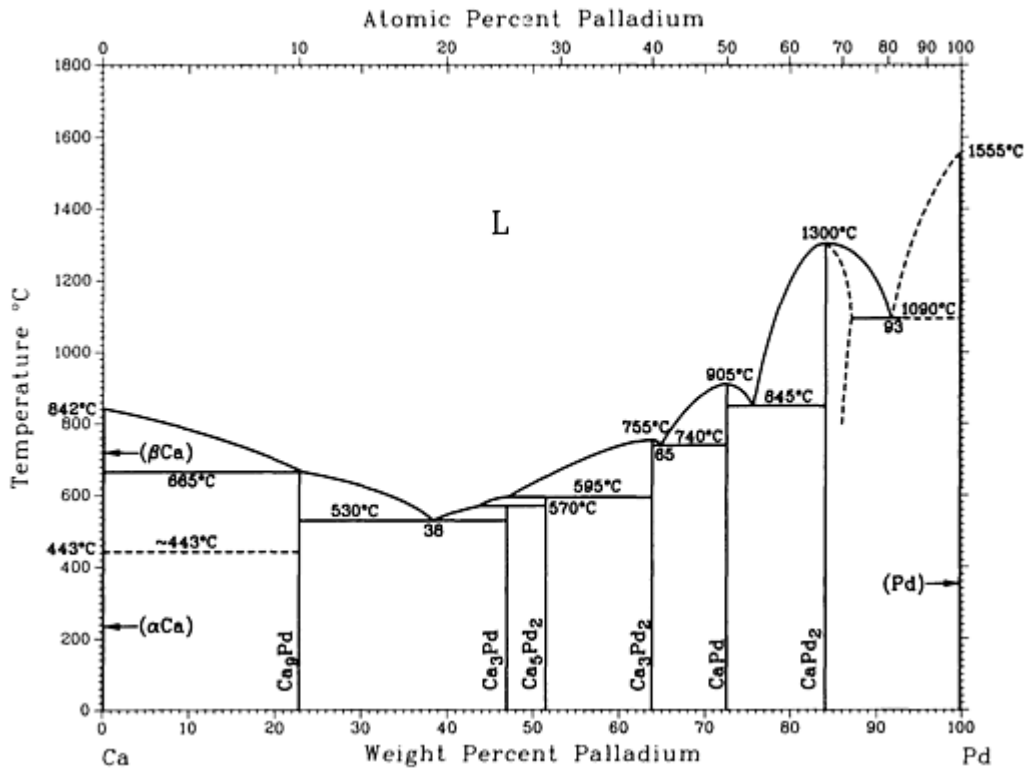

Ca-Pd phase diagram

Ca-Pd crystallographic data

Phase	Composition, wt% Pd	Pearson symbol	Space group
(βCa)	0	<i>cI2</i>	<i>Im$\bar{3}m$</i>
(αCa)	0	<i>cF4</i>	<i>Fm$\bar{3}m$</i>

Ca ₉ Pd	~23
Ca ₃ Pd	47	<i>oP16</i>	<i>Pnma</i>
Ca ₅ Pd ₂	51.5	<i>mC28</i>	<i>C2/c</i>
Ca ₃ Pd ₂	64	<i>hR45</i>	$R\bar{3}$
CaPd	72.6	<i>cP2</i>	<i>Pm\bar{3}m</i>
CaPd ₂	84.2	<i>cF24</i>	<i>Fd\bar{3}m</i>
CaPd ₅	93.2	<i>hP6</i>	<i>P6/mmm</i>
(Pd)	100	<i>cF4</i>	<i>Fm\bar{3}m</i>

Ca-Pt (Calcium - Platinum)

P.R. Subramanian, 1990

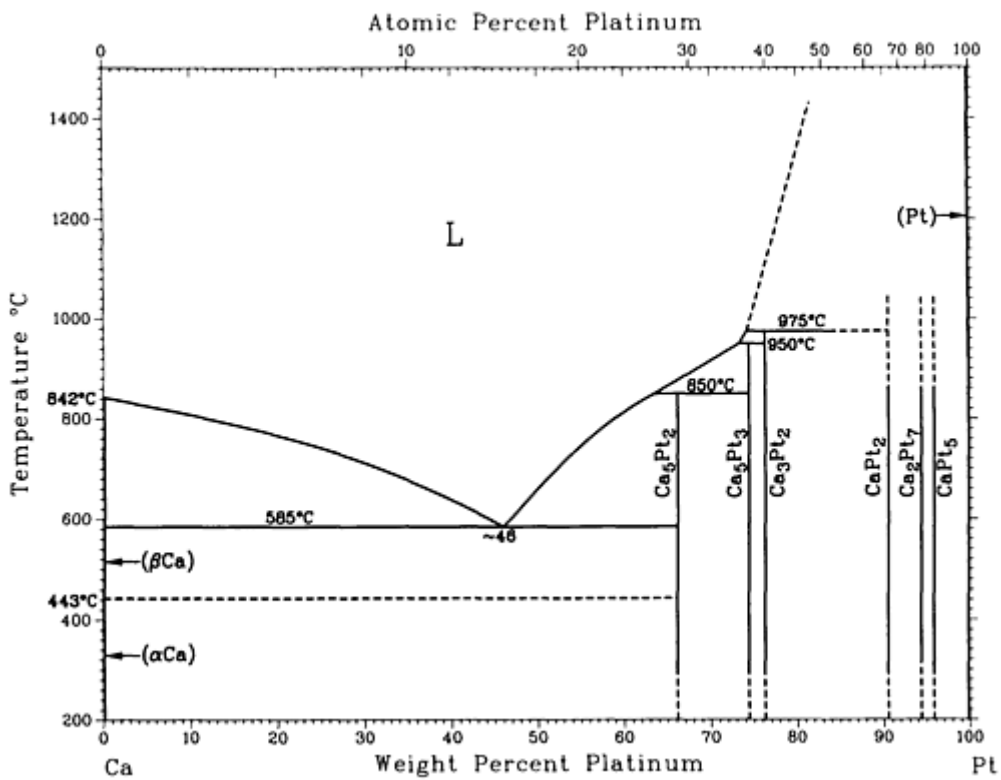

Ca-Pt phase diagram

Ca-Pt crystallographic data

Phase	Composition, wt% Pt	Pearson symbol	Space group
(α Ca)	0	<i>cF4</i>	<i>Fm$\bar{3}m$</i>
(β Ca)	0	<i>cI2</i>	<i>Im$\bar{3}m$</i>
Ca ₅ Pt ₂	66.1	<i>mC28</i>	<i>C2/c</i>
Ca ₅ Pt ₃	74.5	<i>tI32</i>	<i>I4/mcm</i>
Ca ₃ Pt ₂	76	<i>hR45</i>	<i>R$\bar{3}$</i>
CaPt ₂	~90.7	<i>cF24</i>	<i>Fd$\bar{3}m$</i>
Ca ₂ Pt ₇	~94.5	<i>hP36</i>	<i>P6₃/mmc</i>
CaPt ₅	96.0	<i>hP6</i>	<i>P6/mmm</i>
(Pt)	100	<i>cF4</i>	<i>Fm$\bar{3}m$</i>

Ca-Sb (Calcium - Antimony)

P.R. Subramanian, 1990

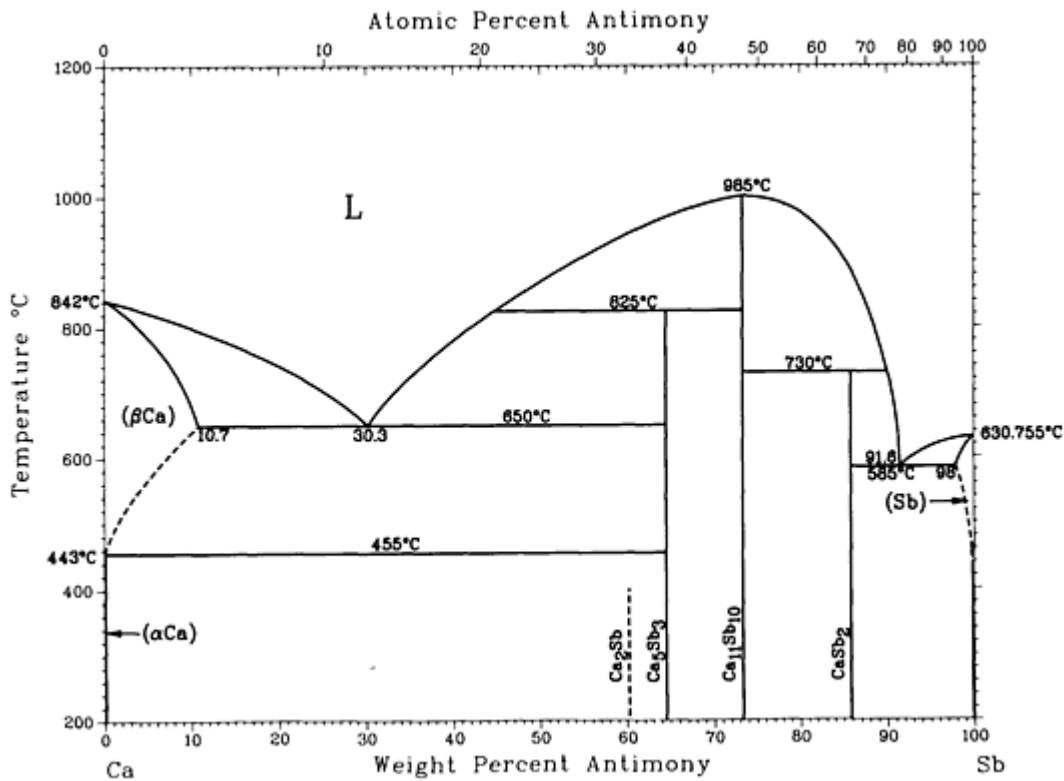

Ca-Sb phase diagram

Ca-Sb crystallographic data

Phase	Composition, wt% Sb	Pearson symbol	Space group
(αCa)	0	<i>cF4</i>	<i>Fm</i> $\bar{3}m$
(βCa)	0 to 10.7	<i>cI2</i>	<i>Im</i> $\bar{3}m$
Ca ₂ Sb	~60.3	<i>iI12</i> <i>iI14</i> ^(b)	<i>I4/mmm</i> <i>I4/mmm</i>
αCa ₅ Sb ₃ ^(a)	~64.6	<i>oP32</i>	<i>Pnma</i>
βCa ₅ Sb ₃ ^(b)	~64.6	<i>hP16</i>	<i>P6₃/mcm</i>
Ca ₁₁ Sb ₁₀	~73.4	<i>iI84</i>	<i>I4/mmm</i>

CaSb ^(c)	75	cF8	$F\bar{4}3m$
CaSb ₂	~85.9	mP6	$P2_1/m$
(Sb)	98.0 to 100	hR2	$R\bar{3}m$

- (a) Room temperature modification.
- (b) High-temperature modification; allotropic transformation temperature unknown.
- (c) Not shown on diagram

Ca-Si (Calcium - Silicon)

P.R. Subramanian, 1990

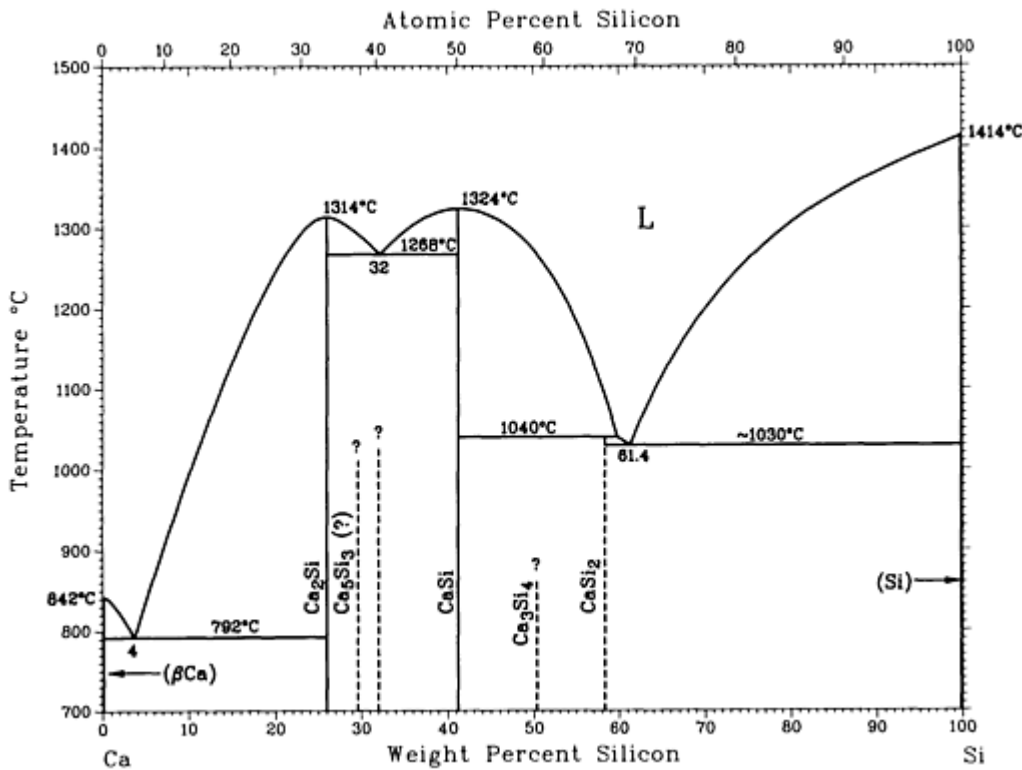

Ca-Si phase diagram

Ca-Si crystallographic data

Phase	Composition,	Pearson	Space
-------	--------------	---------	-------

	wt% Si	symbol	group
(α Ca)	0	<i>cF4</i>	<i>Fm$\bar{3}m$</i>
(β Ca)	0	<i>cI2</i>	<i>Im$\bar{3}m$</i>
Ca ₂ Si	25.9	<i>oP12</i>	<i>Pnma</i>
Ca ₅ Si ₃	29.6	<i>tI32</i>	<i>I4/mcm</i>
CaSi	41.2	<i>oC8</i>	<i>Cmcm</i>
Ca ₃ Si ₄	~48.3
CaSi ₂	58.4	<i>hR6</i>	<i>R$\bar{3}m$</i>
(Si)	100	<i>cF8</i>	<i>Fd$\bar{3}m$</i>
High-pressure phase			
CaSi ₂ ^(a)	58.4	<i>tI12</i>	<i>I4₁/amd</i>

(a) Prepared by high-temperature/high-pressure treatment of rhombohedral CaSi₂ at 1000 to 1500 °C and 40 kbar, followed by quenching to ambient conditions

Ca-Sr (Calcium - Strontium)

C.B. Alcock and V.P. Itkin, 1986

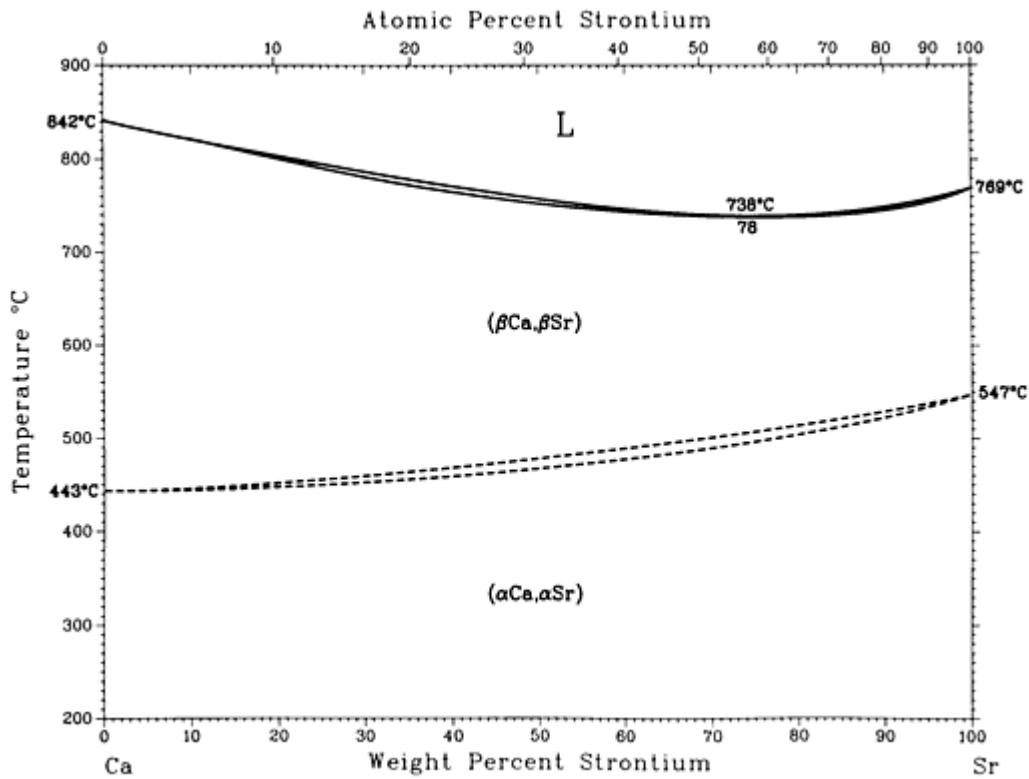

Ca-Sr phase diagram

Ca-Sr crystallographic data

Phase	Composition, wt% Sr	Pearson symbol	Space group
(α Ca, α Sr)	0 to 100	<i>cF4</i>	<i>Fm</i> $\bar{3}m$
(β Ca, β Sr)	0 to 100	<i>cI2</i>	<i>Im</i> $\bar{3}m$

Ca-Tl (Calcium - Thallium)

P.R. Subramanian, 1990

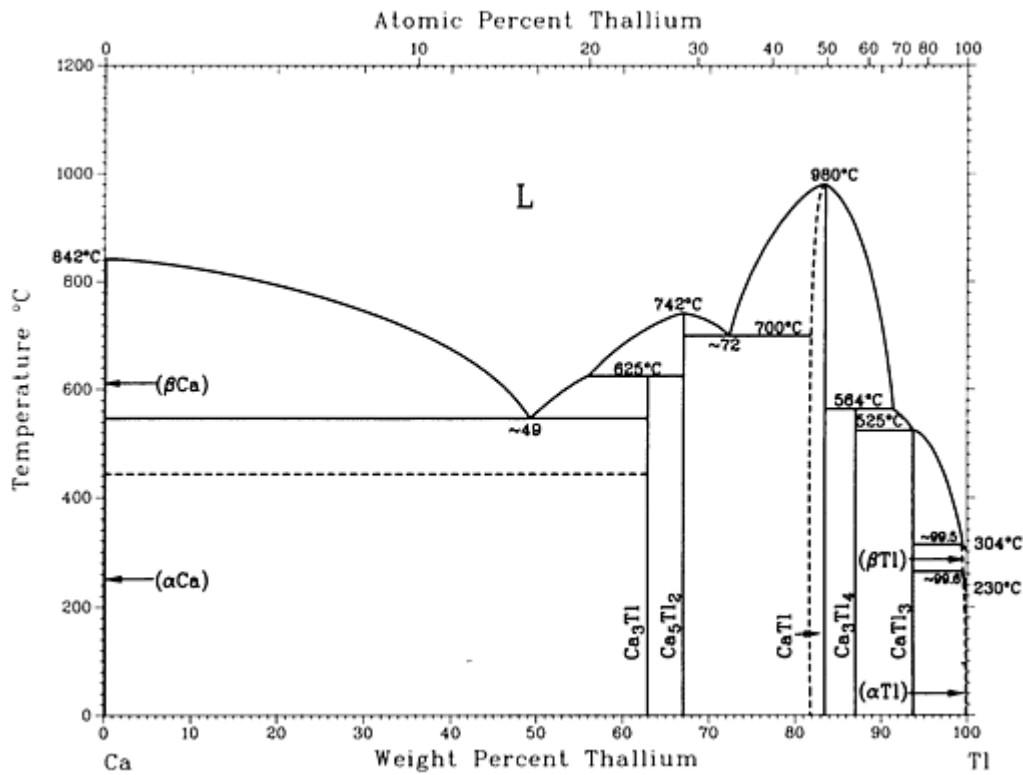

Ca-Tl phase diagram

Ca-Tl crystallographic data

Phase	Composition, wt% Tl	Pearson symbol	Space group
(αCa)	0	<i>cF4</i>	<i>Fm</i> $\bar{3}m$
(βCa)	0	<i>cI2</i>	<i>Im</i> $\bar{3}m$
Ca ₃ Tl	63	<i>cF16</i>	<i>Fm</i> $\bar{3}m$
Ca ₅ Tl ₂	~67.1
CaTl	83.6	<i>cP2</i>	<i>Pm</i> $\bar{3}m$
Ca ₃ Tl ₄	~87.2
CaTl ₃	94	<i>cP4</i>	<i>Pm</i> $\bar{3}m$

(α_{Ti})	~ 99.6	$hP2$	$P6_3/mmc$
(β_{Ti})	~ 99.5	$cI2$	$Im\bar{3}m$

Ca-Yb (Calcium - Ytterbium)

K.A. Gschneidner, Jr. and F.W. Calderwood, 1987

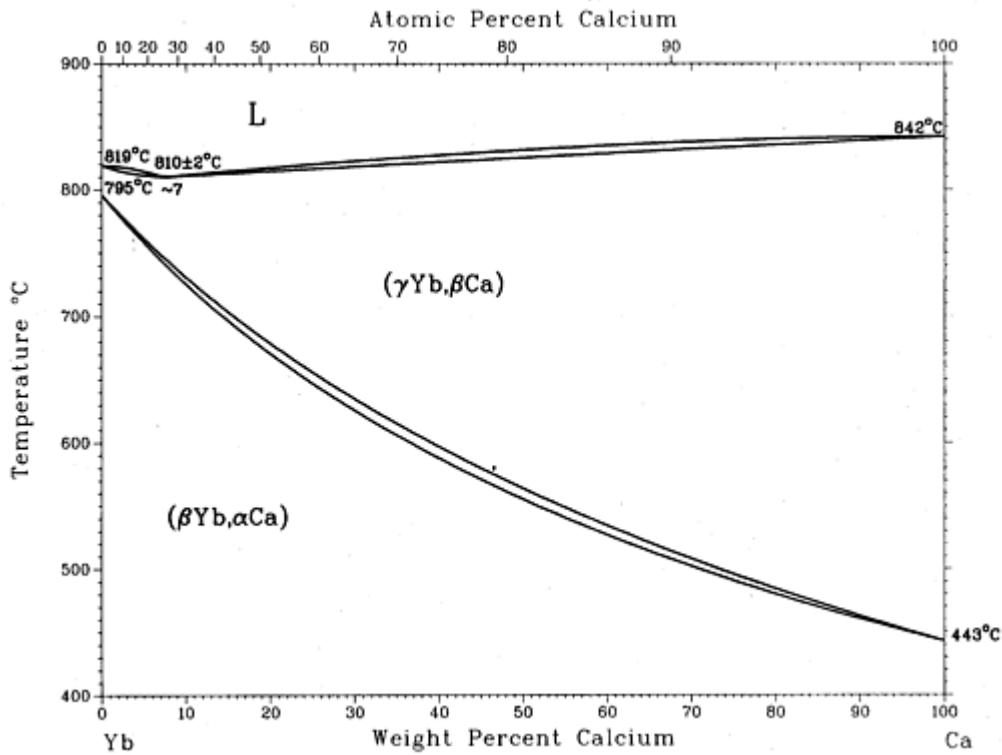

Ca-Yb phase diagram

Ca-Yb crystallographic data

Phase	Composition, wt% Ca	Pearson symbol	Space group
(α_{Yb})	0	$hP2$	$P6_3/mmc$
(β_{Yb})	0	$cF4$	$Fm\bar{3}m$
(γ_{Yb})	0	$cI2$	$Im\bar{3}m$
(α_{Ca})	100	$cF4$	$Fm\bar{3}m$

(β_{Ca})	100	$cI2$	$Im\bar{3}m$
----------------	-----	-------	--------------

Ca-Zn (Calcium - Zinc)

V.P. Itkin and C.B. Alcock, 1990

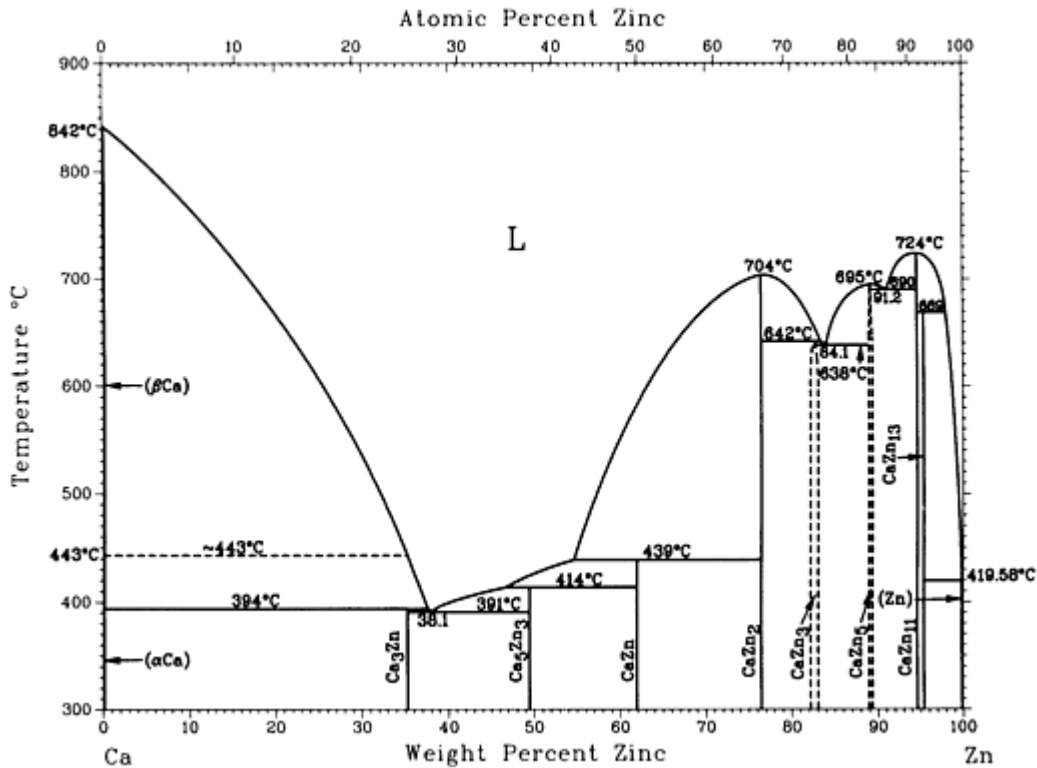

Ca-Zn phase diagram

Ca-Zn crystallographic data

Phase	Composition, wt% Zn	Pearson symbol	Space group
(β_{Ca})	0	$cI2$	$Im\bar{3}m$
(α_{Ca})	0	$cF4$	$Fm\bar{3}m$
Ca_3Zn	35	$oC16$	$Cmcm$
Ca_5Zn_3	46.5	$tI32$	$I4/mcm$
$CaZn$	62.0	$oC8$	$Cmcm$

CaZn ₂	76.6	<i>oI12</i>	<i>Imma</i>
CaZn ₃	82 to 83	<i>hP32</i>	<i>P6₃/mmc</i>
CaZn ₅	81.7 to 89.5	<i>hP6</i>	<i>P6/mmm</i>
CaZn ₁₁	94.7	<i>tI48</i>	<i>I4₁/amd</i>
CaZn ₁₃	95.5	<i>cF112</i>	<i>Fm$\bar{3}c$</i>
(Zn)	100	<i>hP2</i>	<i>P6₃/mmc</i>

Cd (Cadmium) Binary Alloy Phase Diagrams

Introduction

THIS ARTICLE includes systems where cadmium is the first-named element in the binary pair. Additional binary systems that include cadmium are provided in the following locations in this Volume:

- “Ag-Cd (Silver - Cadmium)” in the article “Ag (Silver) Binary Alloy Phase Diagrams.”
- “Al-Cd (Aluminum - Cadmium)” in the article “Al (Aluminum) Binary Alloy Phase Diagrams.”
- “As-Cd (Arsenic - Cadmium)” in the article “As (Arsenic) Binary Alloy Phase Diagrams.”
- “Au-Cd (Gold - Cadmium)” in the article “Au (Gold) Binary Alloy Phase Diagrams.”
- “Ba-Cd (Barium - Cadmium)” in the article “Ba (Barium) Binary Alloy Phase Diagrams.”
- “Bi-Cd (Bismuth - Cadmium)” in the article “Bi (Bismuth) Binary Alloy Phase Diagrams.”
- “Ca-Cd (Calcium - Cadmium)” in the article “Ca (Calcium) Binary Alloy Phase Diagrams.”

Cd-Cu (Cadmium - Copper)

P.R. Subramanian and D.E. Laughlin, 1990

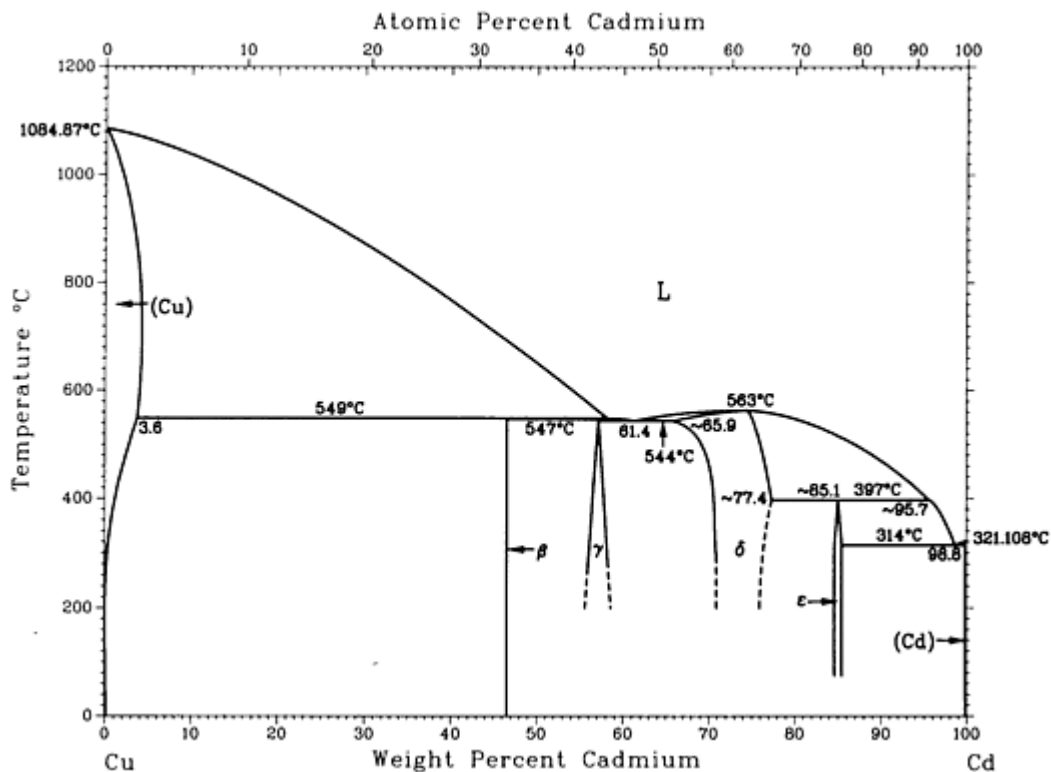

Cd-Cu phase diagram

Cd-Cu crystallographic data

Phase	Composition, wt% Cd	Pearson symbol	Space group
(Cu)	0 to 3.6	<i>cF4</i>	<i>Fm</i> $\bar{3}m$
β	46.9	<i>hP24</i>	<i>P6</i> ₃ / <i>mmc</i>
γ	56.0 to 58.3 ^(a)	<i>cF1124</i>	<i>F</i> $\bar{4}$ <i>3m</i>
δ	65.9 to 77	<i>cI52</i>	...
ϵ	84.6 to 85.9	<i>hP28</i>	<i>P6</i> ₃ / <i>mmc</i>
(Cd)	~99.9 to 100	<i>hP2</i>	<i>P6</i> ₃ / <i>mmc</i>

(a) At 300 °C

Cd-Eu (Cadmium - Europium)

K.A. Gschneidner, Jr. and F.W. Calderwood, 1988

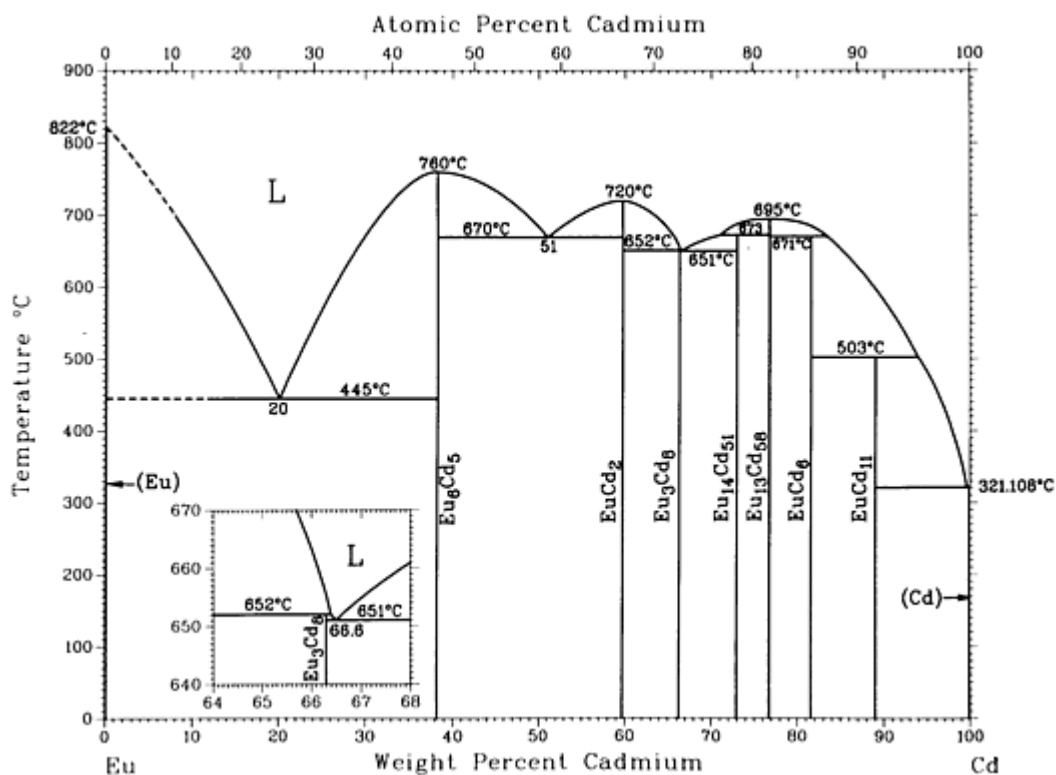

Cd-Eu phase diagram

Cd-Eu crystallographic data

Phase	Composition, wt% Cd	Pearson symbol	Space group
(Eu)	0	$cI2$	$Im\bar{3}m$
$\text{EuCd}^{(a)}$	38.2	$cP2$	$Pm\bar{3}m$
EuCd_2	59.7	$oI12$	$Imma$
Eu_3Cd_8	66.3	^(b)	...
$\text{Eu}_{14}\text{Cd}_{51}$	73.0	$hP65$	$P6/m$
$\text{Eu}_{13}\text{Cd}_{58}$	76.8	$hP142$	$P6_3/mmc$
EuCd_6	81.6	$cI168$	$Im\bar{3}$

EuCd₁₁	88.8 to 89.1	<i>tI48</i>	<i>I4/amd</i>
(Cd)	100	<i>hP2</i>	<i>P6₃/mmc</i>

(a) Defect structure reported as
Eu₆Cd₅.

(b) Structure not known

Cd-Ga (Cadmium - Gallium)

Z. Moser, J. Dutkiewicz, W. Gasior, and J. Salawa, unpublished

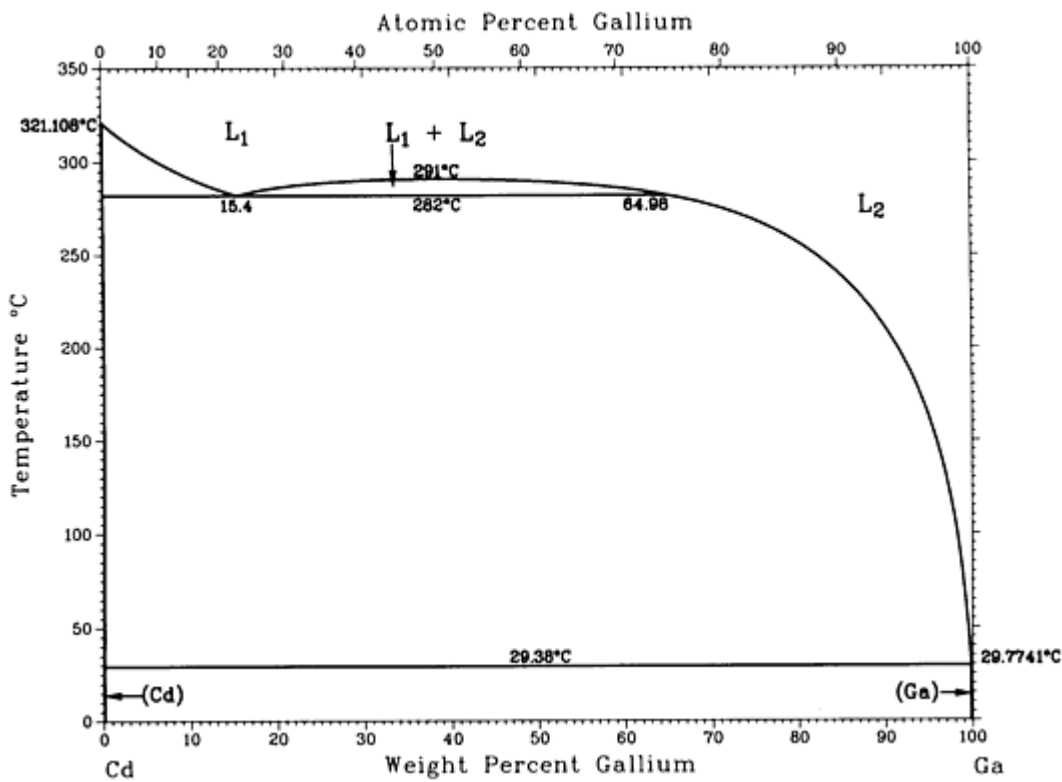

Cd-Ga phase diagram

Cd-Ga crystallographic data

Phase	Composition, wt% Ga	Pearson symbol	Space group
(Cd)	0	<i>hP2</i>	<i>P6₃/mmc</i>
(Ga)	100	<i>oC8</i>	<i>Cmca</i>

Cd-Gd (Cadmium - Gadolinium)

K.A. Gschneidner, Jr. and F.W. Calderwood, 1988

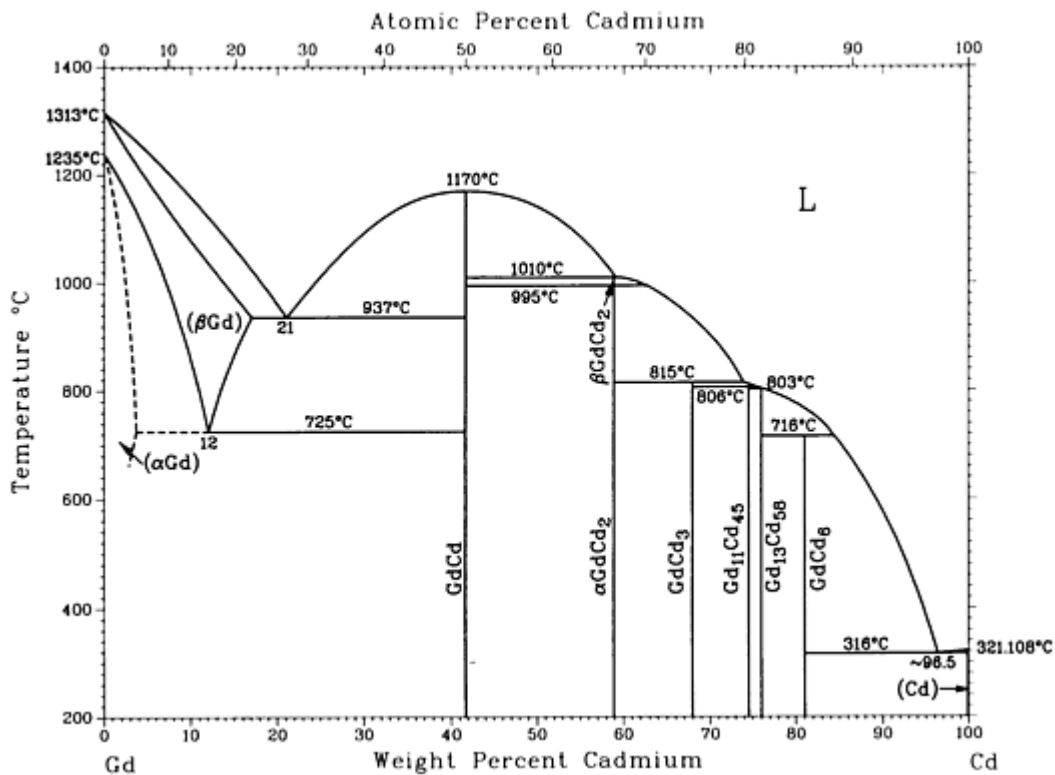

Cd-Gd phase diagram

Cd-Gd crystallographic data

Phase	Composition, wt% Cd	Pearson symbol	Space group
(αGd)	0 to ~3.6	<i>hP2</i>	<i>P6₃/mmc</i>
(βGd)	0 to ~17	<i>cI2</i>	<i>Im$\bar{3}m$</i>
GdCd	41.7	<i>cP2</i>	<i>Pm$\bar{3}m$</i>
GdCd ₂	58.9	<i>hP3</i>	<i>P3m1</i>
GdCd ₃	68	<i>hP8</i>	<i>P6₃/mmc</i>
Gd ₁₁ Cd ₄₅	74.6	<i>cF448</i>	<i>F$\bar{4}3m$</i>

$\text{Gd}_{13}\text{Cd}_{58}$	76.1	<i>hP142</i>	<i>P6_3/mmc</i>
GdCd_6	81.1	<i>cI168</i>	<i>Im\bar{3}</i>
(Cd)	100	<i>hP2</i>	<i>P6_3/mmc</i>

Cd-Ge (Cadmium - Germanium)

R.W. Olesinski and G.J. Abbaschian, 1986

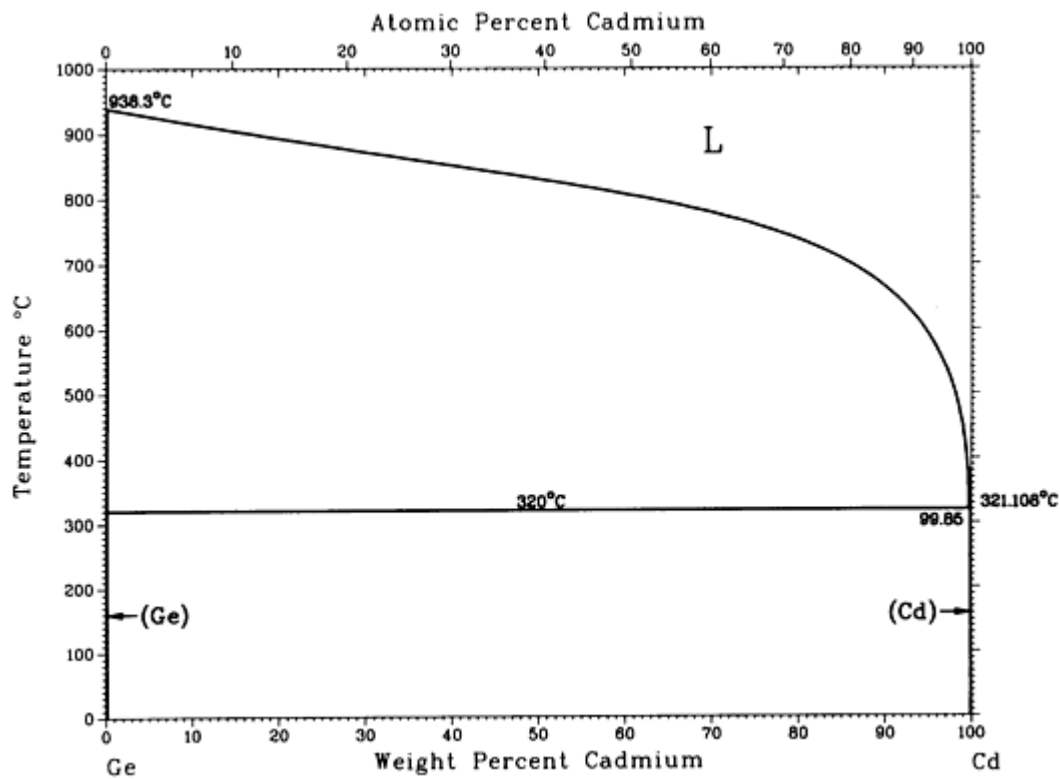

Cd-Ge phase diagram

Cd-Ge crystallographic data

Phase	Composition, wt% Cd	Pearson symbol	Space group
(Ge)	0.0	<i>cF8</i>	<i>Fd\bar{3}m</i>
GeII(HP)	0.0	<i>tI4</i>	<i>I4_1/amd</i>
(Cd)	100	<i>hP2</i>	<i>P6_3/mmc</i>

Cd-Hg (Cadmium - Mercury)

C. Guminski and L.A. Zabdyr, 1992

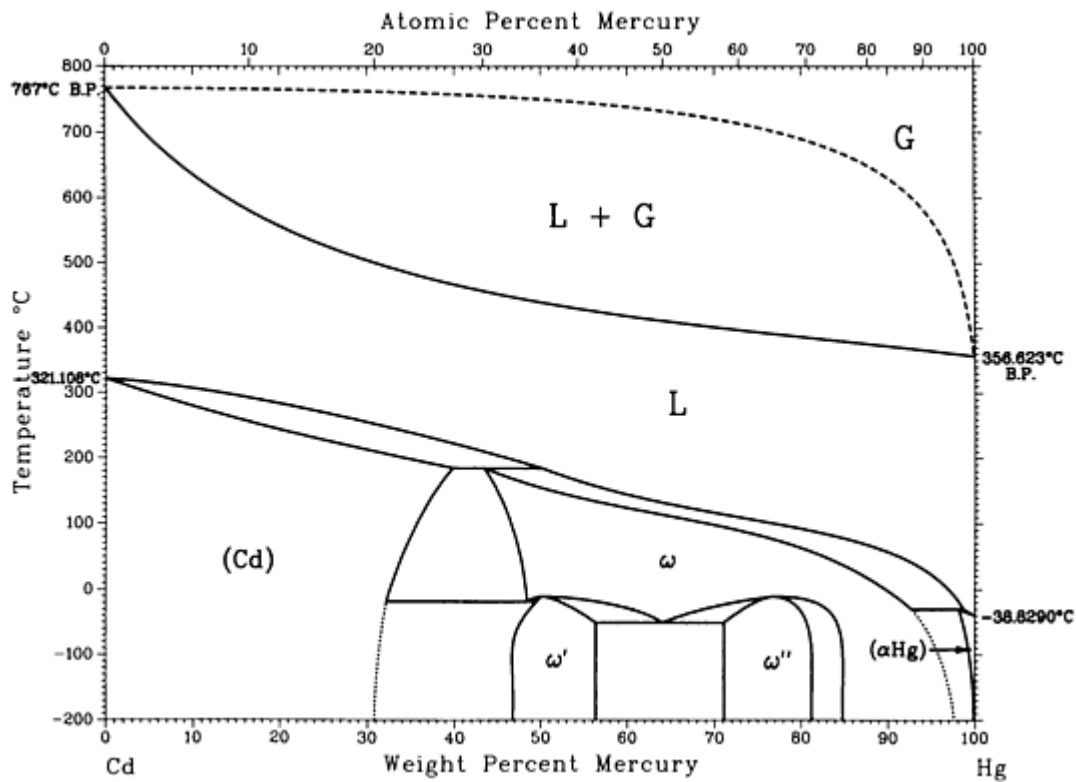

Cd-Hg phase diagram

Cd-Hg crystallographic data

Phase	Composition wt% Hg	Pearson symbol	Space group
(Cd)	0 to 37	<i>hP2</i>	<i>P6₃/mmc</i>
ω	42 to 94	<i>tI2</i>	<i>I4/mmm</i>
ω'	47 to 56	<i>tI6</i>	<i>I4/mmm</i>
ω''	71 to 81	<i>tI6</i>	<i>I4/mmm</i>
(α Hg) ^(a)	98 to 100	<i>hR1</i>	<i>R$\bar{3}m$</i>
(β Hg) ^(b)	~100	<i>tI2</i>	<i>I4/mmm</i>

(a) From -38.8290 to -193 °C at

100 wt% Hg.

(b) Below -193 °C

Cd-In (Cadmium - Indium)

J. Dutkiewicz, L.A. Zabdyr, W. Zakulski, Z. Moser, J. Salawa, P.J. Horrocks, F.H. Hayes, and M.H. Rand, 1992

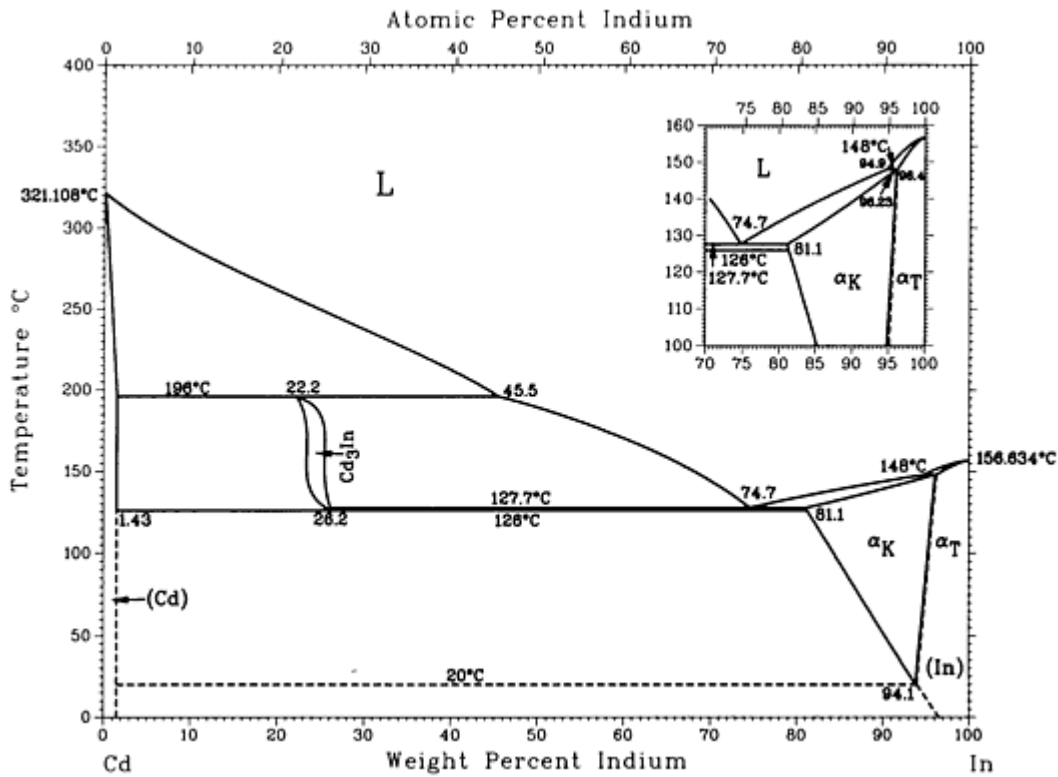

Cd-In phase diagram

Cd-In crystallographic data

Phase	Composition wt% In	Pearson symbol	Space group
(Cd)	0 to 1.4	<i>hP2</i>	<i>P6₃/mmc</i>
Cd₃In	22.2 to 26.2	<i>cP4</i>	<i>Pm</i> $\bar{3}$ <i>m</i>
α_K	81.1 to 94	<i>cF4</i>	<i>Fm</i> $\bar{3}$ <i>m</i>
(In)(α_T)	94 to 100	<i>tI2</i>	<i>I4/mmm</i>

Cd-La (Cadmium - Lanthanum)

K.A. Gschneidner, Jr. and F.W. Calderwood, 1988

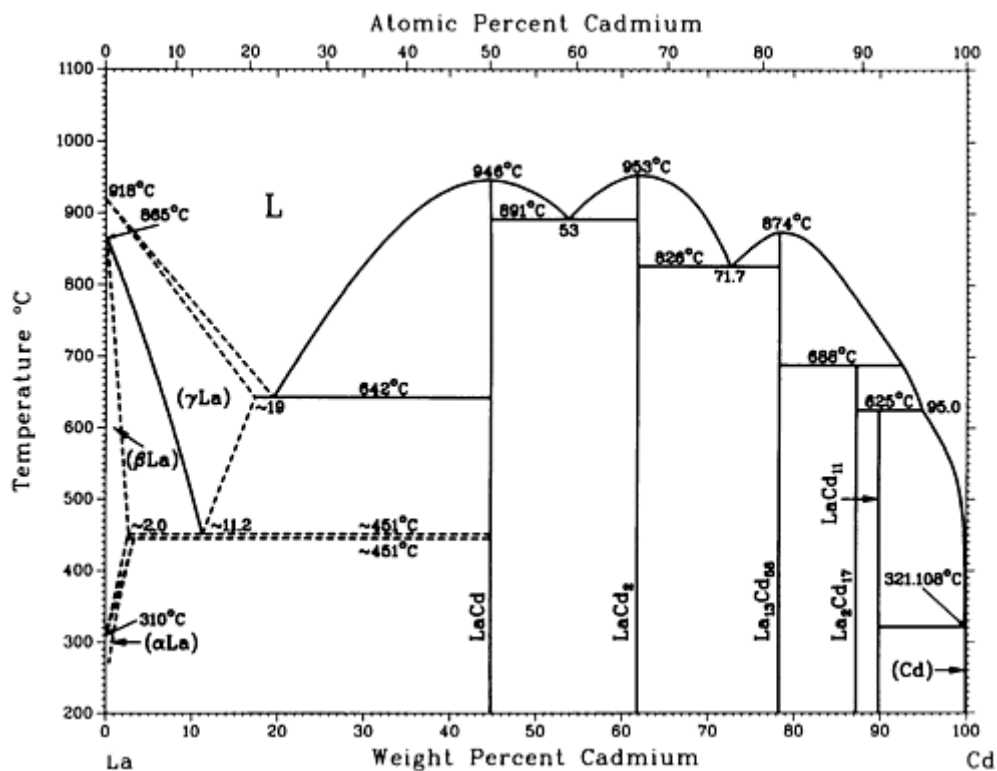

Cd-La phase diagram

Cd-La crystallographic data

Phase	Composition wt% Cd	Pearson symbol	Space group
(αLa)	0	<i>hP4</i>	<i>P6₃/mmc</i>
(βLa)	0 to ~2.0	<i>cF4</i>	<i>Fm$\bar{3}$m</i>
(γLa)	0 to ~18	<i>cI2</i>	<i>Im$\bar{3}$m</i>
LaCd	44.7	<i>cP2</i>	<i>Pm$\bar{3}$m</i>
LaCd ₂	61.8	<i>hP3</i>	<i>P3m1</i>
La ₁₃ Cd ₅₈	78.3	<i>hP142</i>	<i>P6₃/mmc</i>
La ₂ Cd ₁₇	85.8	<i>hP38</i>	<i>P6₃/mmc</i>

LaCd ₁₁	89.9	cP36	Pm $\bar{3}m$
(Cd)	100	hP2	P6 ₃ /mmc

Cd-Li (Cadmium - Lithium)

A.D. Pelton, 1988

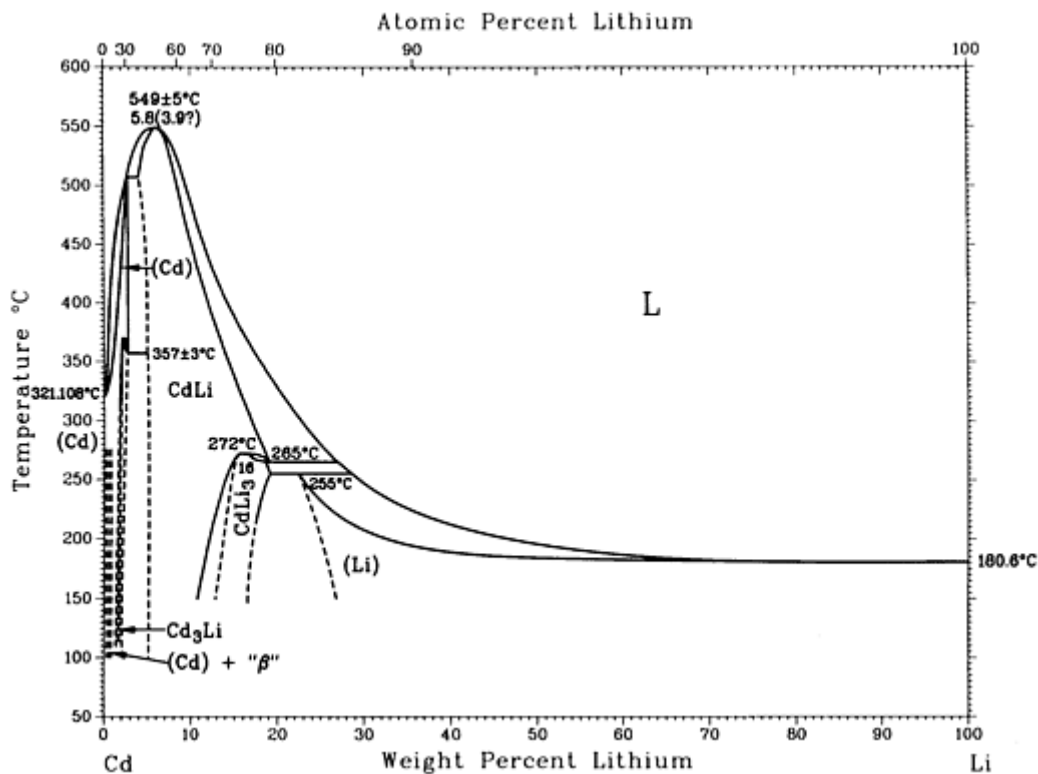

Cd-Li phase diagram

Cd-Li crystallographic data

Phase	Composition wt% Li	Pearson symbol	Space group
(Cd)	0 to 2.6	hP2	P6 ₃ /mmc
Cd ₃ Li	2? to 2.5	hP2	P6 ₃ /mmc
CdLi	3.6 to 18	cF16	Fd $\bar{3}m$
CdLi ₃	10? to 18	cF4	Fm $\bar{3}m$

(βLi)	22 to 100	$cI2$	$Im\bar{3}m$
$(\alpha\text{Li})^{(a)}$	100	$hP2$	$P6_3/mmc$

(a) Below -193 °C

Cd-Mg (Cadmium - Magnesium)

Z. Moser, W. Gasior, J. Wypartowicz, and L. Zabdyr, 1984

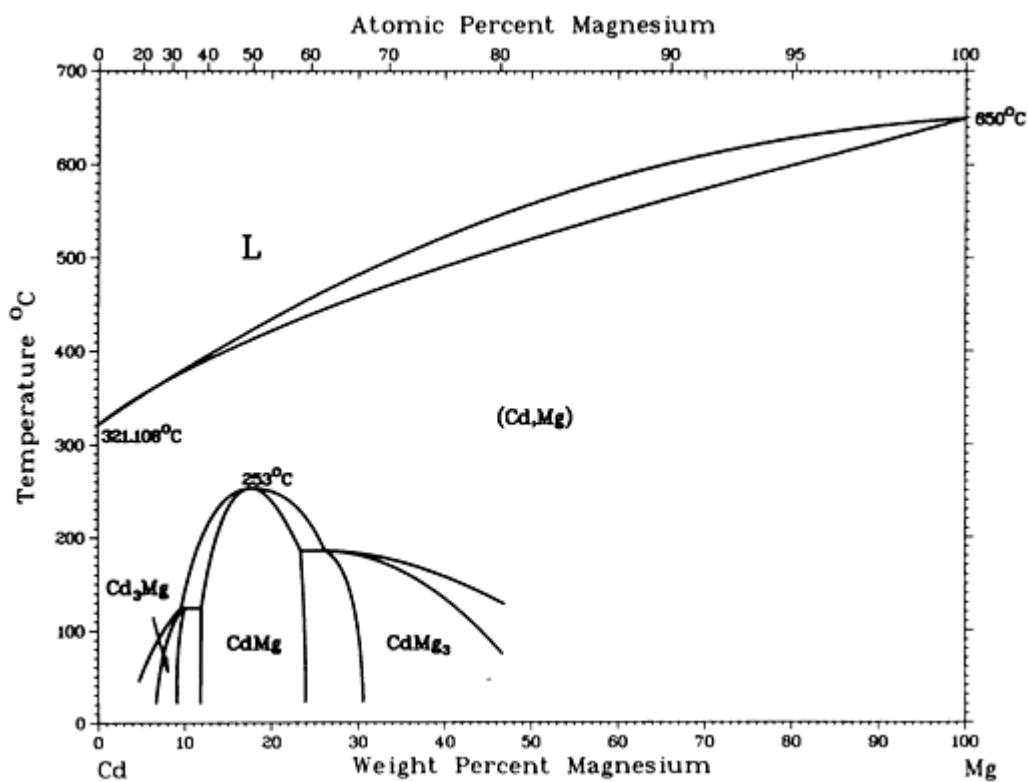

Cd-Mg phase diagram

Cd-Mg crystallographic data

Phase	Composition wt% Mg	Pearson symbol	Space group
(Cd, Mg)	0 to 100	$hP2$	$P6_3/mmc$
α' or Cd ₃ Mg	7 to 9	$hP8$	$P6_3/mmc$
α'' or CdMg	12 to 25	$oP4$	$Pmma$

α''' or CdMg_3 29 to 50 *hP8* $P6_3/mmc$

Cd-Na (Cadmium - Sodium)

A.D. Pelton, 1988

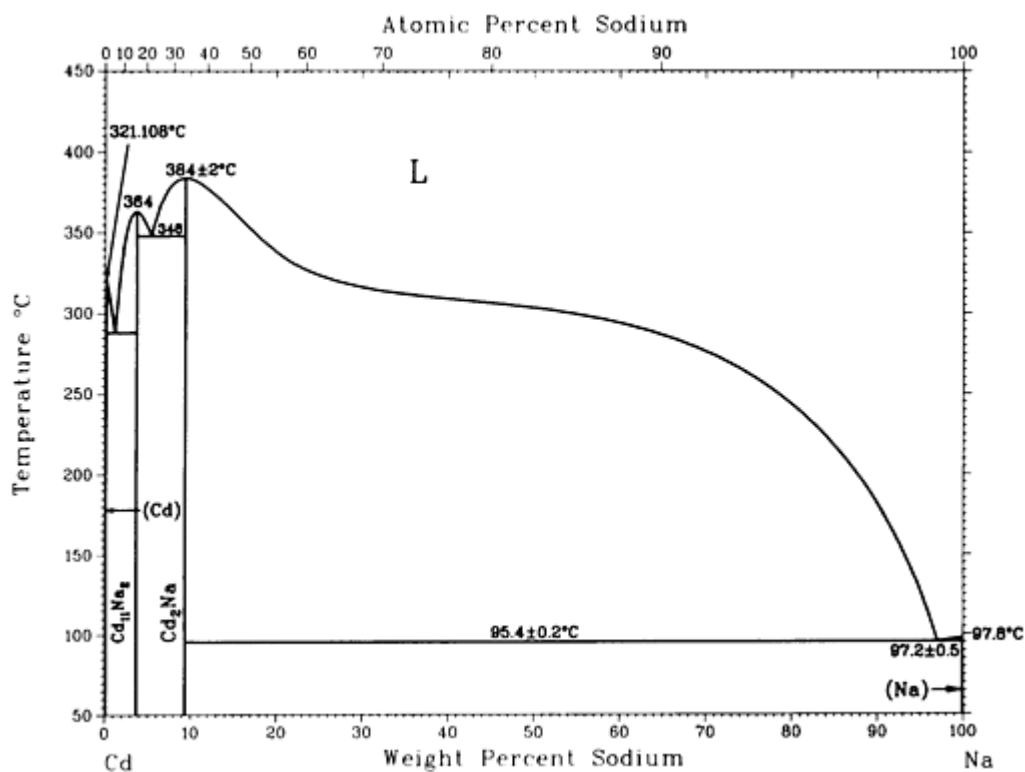

Cd-Na phase diagram

Cd-Na crystallographic data

Phase	Composition wt% Na	Pearson symbol	Space group
(Cd)	0	<i>hP2</i>	$P6_3/mmc$
$\text{Cd}_{11}\text{Na}_2$	3.9	<i>cP39</i>	$Pm\bar{3}$
$\text{Cd}_2\text{Na}^{(a)}$	9.3	<i>cF1192</i>	...
(β Na)	100	<i>cI2</i>	$Im\bar{3}m$
(α Na) ^(b)	100	<i>hP2</i>	$P6_3/mmc$

(a) Complex cubic structure that corresponds to the formula $Cd_{1.92}Ni$ at 0.070 wt% Ni.

(b) Below $-237\text{ }^{\circ}C$

Cd-Ni (Cadmium - Nickel)

F.A. Shunk and P. Nash, 1991

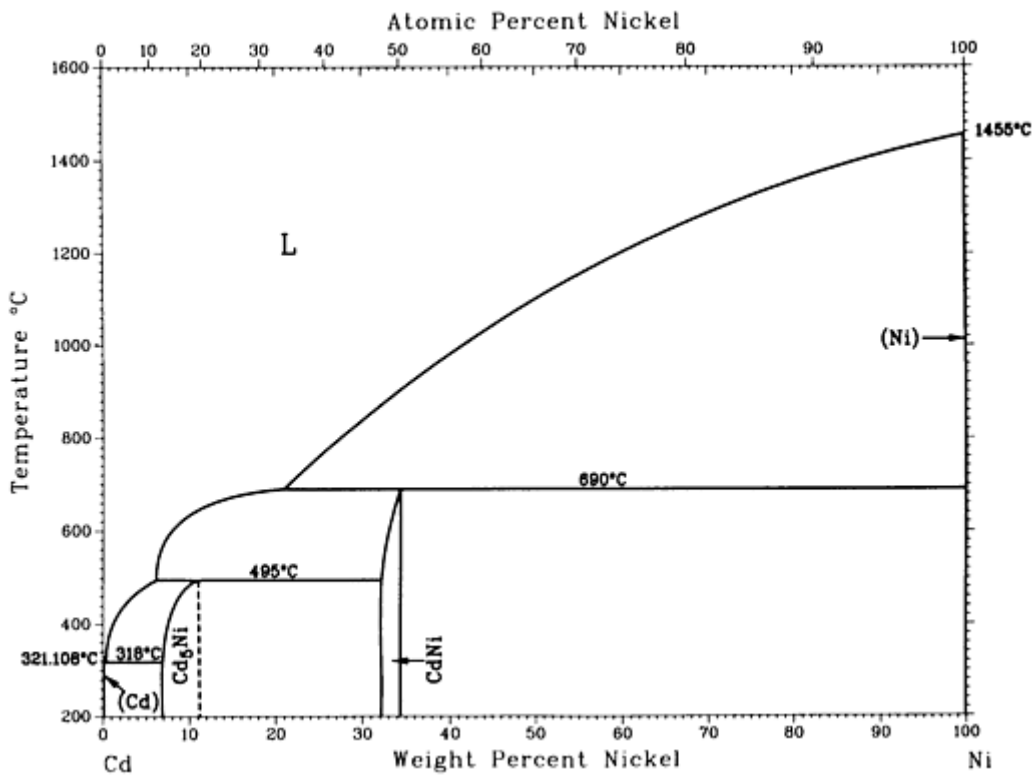

Cd-Ni phase diagram

Cd-Ni crystallographic data

Phase	Composition, wt% Ni	Pearson symbol	Space group
(Cd)	0	<i>hP2</i>	$P6_3/mmc$
Cd_5Ni	9 to 10.6	<i>cP52</i>	$P\bar{4}3m$
$CdNi$	31.9 to 34.3	<i>cF112</i>	$Fd\bar{3}m$
(Ni)	100	<i>cF4</i>	$Fm\bar{3}m$

Cd-P (Cadmium - Phosphorus)

H. Okamoto, 1990

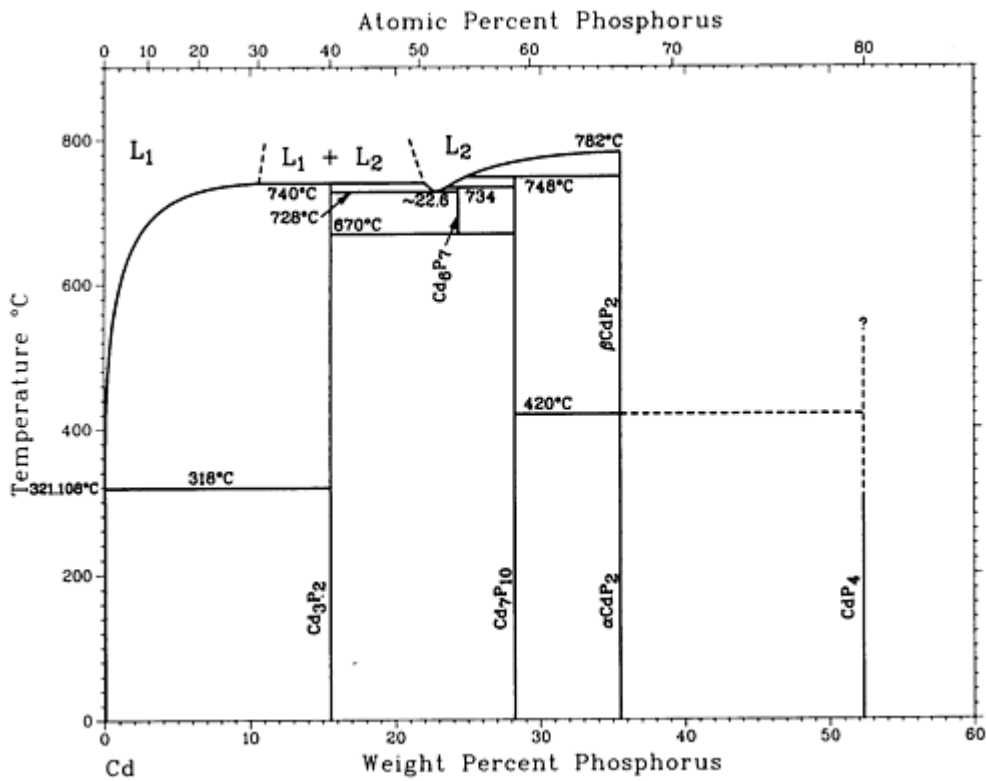

Cd-P phase diagram

Cd-P crystallographic data

Phase	Composition, wt% P	Pearson symbol	Space group
(Cd)	0	<i>hP2</i>	<i>P6₃/mmc</i>
Cd_3P_2	16	<i>tI40</i>	<i>P4₂/nmc</i>
Cd_6P_7	24.3	<i>c*52</i>	...
Cd_7P_{10}	24.3	<i>oF136</i>	<i>Fdd2</i>
$\beta-CdP_2$	55.6	<i>tP24</i>	<i>P4₃2₁2</i>
$\alpha-CdP_2$	35.6	<i>oP12</i>	<i>Pna2₁</i>

CdP₄ 52.4 *mP10* *P2₁/c*

Cd-Pb (Cadmium - Lead)

J. Dutkiewicz, Z. Moser, and W. Zakulski, 1988

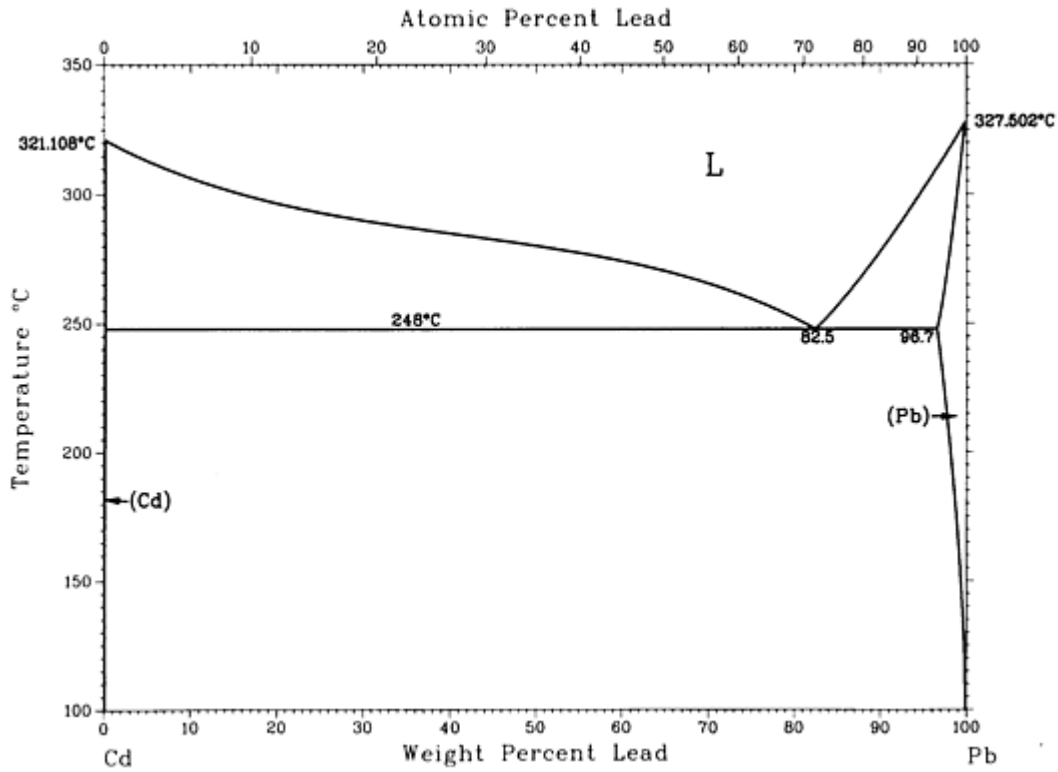

Cd-Pb phase diagram

Cd-Pb crystallographic data

Phase	Composition, wt% Pb	Pearson symbol	Space group
(Cd)	0	<i>hP2</i>	<i>P6₃/mmc</i>
(Pb)	96.7 to 100	<i>cF4</i>	<i>Fm$\bar{3}$m</i>

Cd-Sb (Cadmium - Antimony)

H. Okamoto, 1990

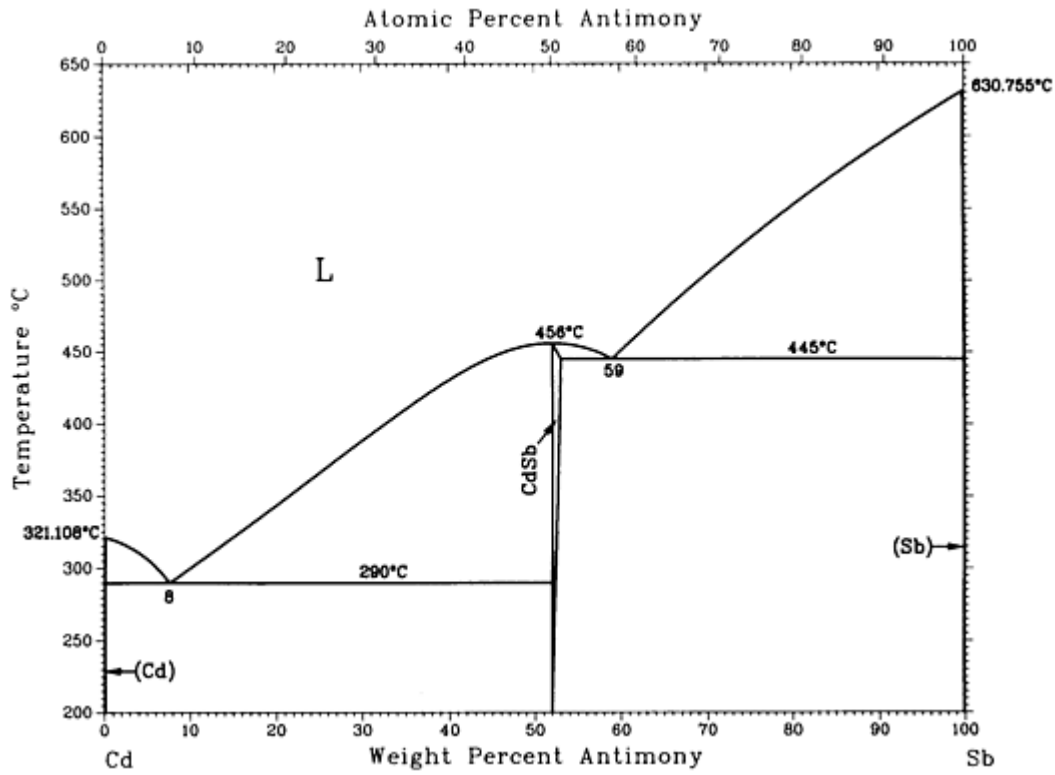

Cd-Sb phase diagram

Cd-Sb crystallographic data

Phase	Composition, wt% Sb	Pearson symbol	Space group
(Cd)	0	<i>hP2</i>	<i>P6₃/mmc</i>
CdSb	52.0 to 53	<i>oP16</i>	<i>Pbca</i>
(Sb)	100	<i>hR2</i>	<i>R$\bar{3}m$</i>
Metastable phases			
Cd₃Sb₂	42	<i>m*20</i>	...
Cd₄Sb₃	44.9	<i>hR*</i>	...

Cd-Se (Cadmium - Selenium)

R.C. Sharma and Y.A. Chang, unpublished

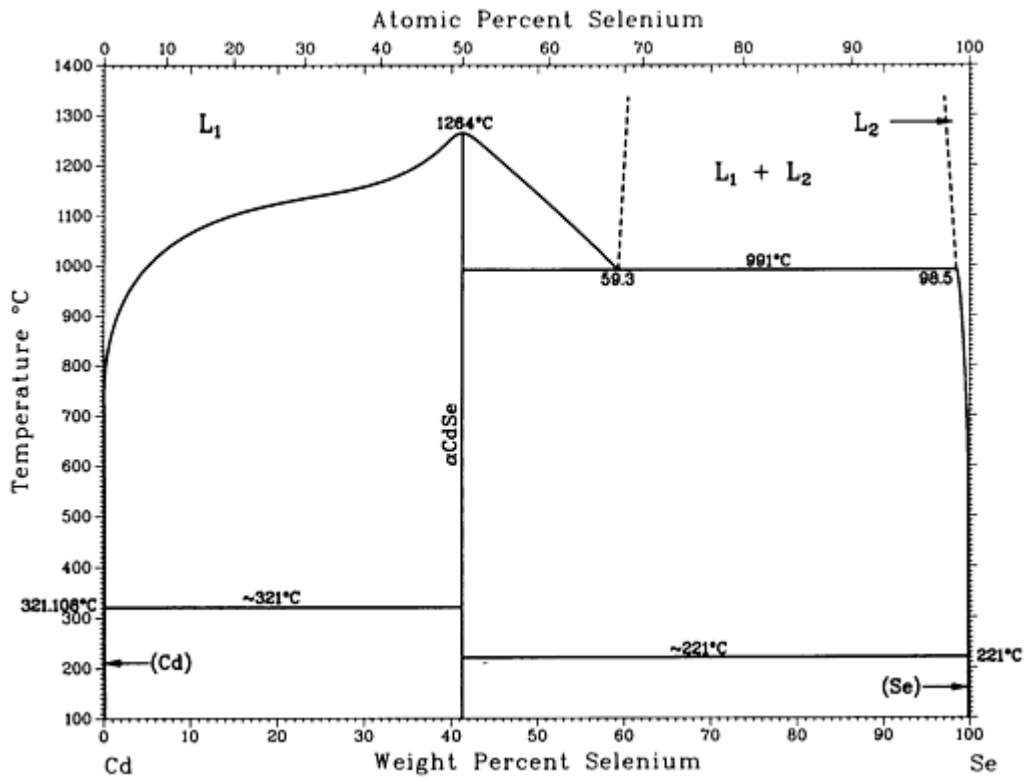

Cd-Se phase diagram

Cd-Se crystallographic data

Phase	Composition, wt% Se	Pearson symbol	Space group
(Cd)	0	<i>hP2</i>	<i>P6₃/mmc</i>
αCdSe	41.3	<i>hP4</i>	<i>P6₃mc</i>
$\beta\text{CdSe}^{(a)}$	41.3	<i>cF8</i>	<i>Fm$\bar{3}m$</i>
(Se)	100	<i>hP3</i>	<i>P3₁21</i>

(a) High-pressure phase

Cd-Sm (Cadmium - Samarium)

K.A. Gschneidner, Jr. and F.W. Calderwood, 1988

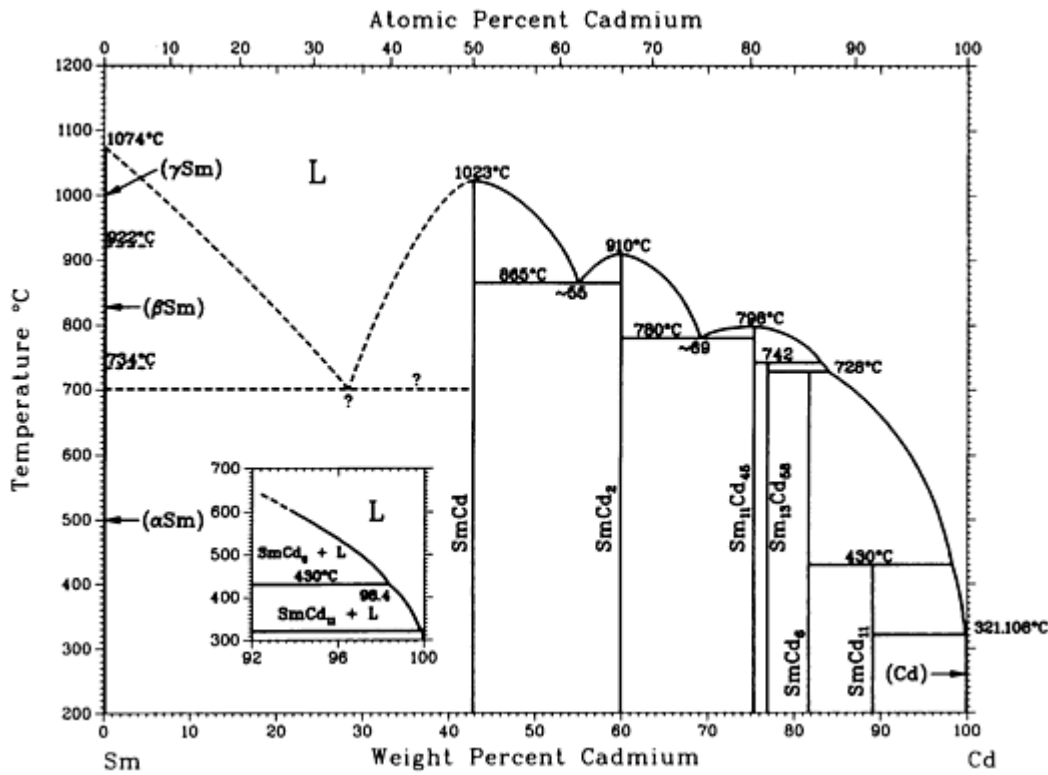

Cd-Sm phase diagram

Cd-Sm crystallographic data

Phase	Composition, wt% Cd	Pearson symbol	Space group
(αSm)	0	<i>hR3</i>	$R\bar{3}m$
(βSm)	0	<i>hP2</i>	$P6_3/mmc$
(γSm)	0	<i>cI2</i>	$Im\bar{3}m$
SmCd	42.8	<i>cP2</i>	$Pm\bar{3}m$
SmCd ₂	60.0	<i>hP3</i>	$P3m1$
Sm ₁₁ Cd ₄₅	75.4	<i>cF448</i>	$F\bar{4}3m$
Sm ₁₃ Cd ₅₈	76.9	<i>hP142</i>	$P6_3/mmc$

SmCd_6	81.8	$cI168$	$Im\bar{3}$
SmCd_{11}	89.2	$cP36$	$Pm\bar{3}m$
(Cd)	100	$hP2$	$P6_3/mmc$

Cd-Sn (Cadmium - Tin)

J. Dutkiewicz, L.A. Zabdyr, Z. Moser, and J. Salawa, 1989

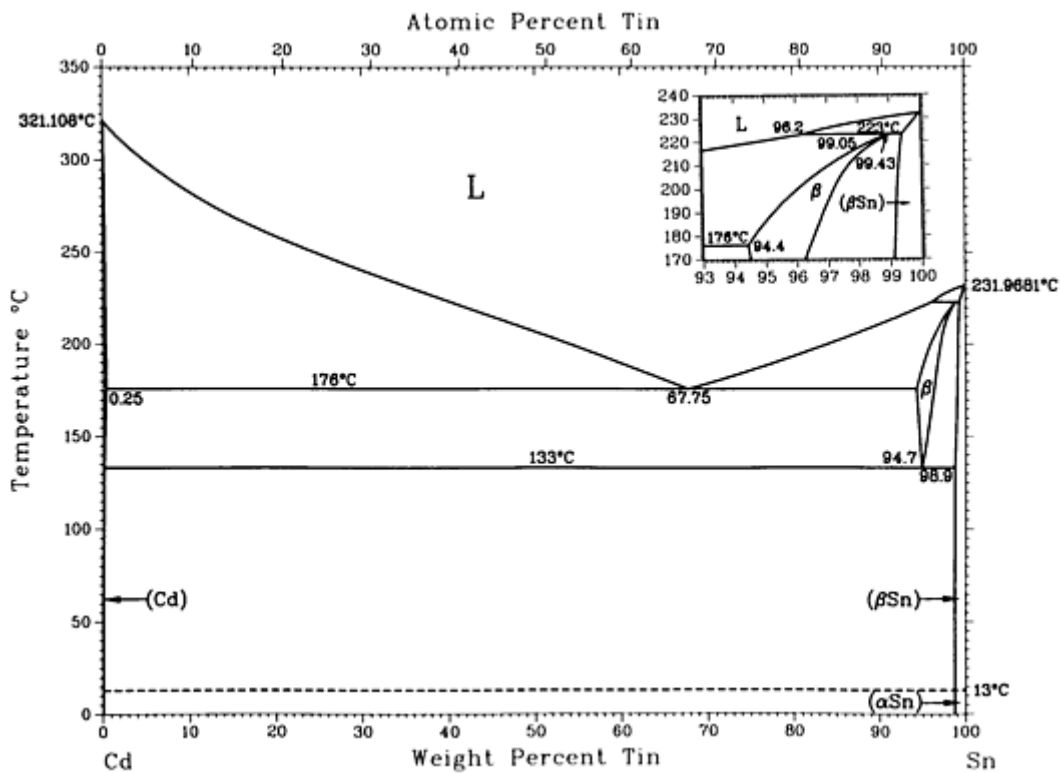

Cd-Sn phase diagram

Cd-Sn crystallographic data

Phase	Composition, wt% Sn	Pearson symbol	Space group
(Cd)	0 to 0.25	$hP2$	$P6_3/mmc$
β	94.3 to 99.1	$hP2$	$P6_3/mmc$
(Sn)	98.9 to 100	$tI4$	$I4_1/amd$

Cd-Sr (Cadmium - Strontium)

H. Okamoto, 1990

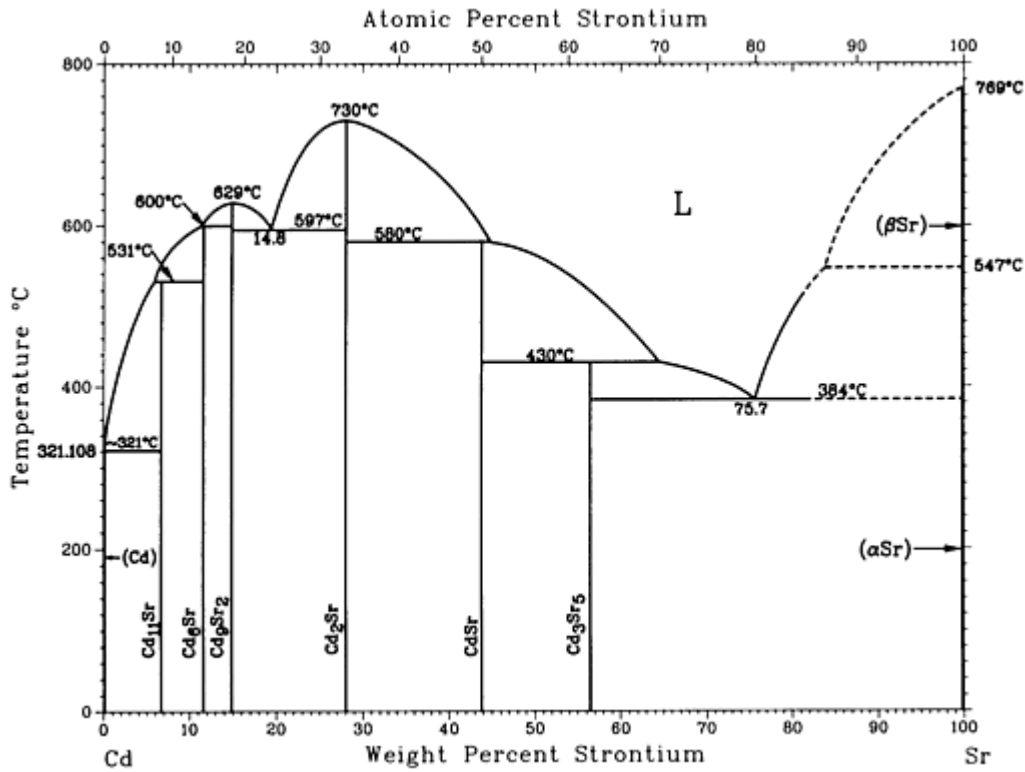

Cd-Sr phase diagram

Cd-Sr crystallographic data

Phase	Composition, wt% Sr	Pearson symbol	Space group
(Cd)	0	<i>hP2</i>	<i>P6₃/mmc</i>
Cd ₁₁ Sr	6.6	<i>tI48</i>	<i>I4₁/amd</i>
Cd ₆ Sr	11.5
Cd ₉ Sr ₂	14.8
Cd ₂ Sr	28.0	<i>oI12</i>	<i>Imma</i>
CdSr	43.8	<i>cP2</i>	<i>Pm$\bar{3}$m</i>
Cd ₃ Sr ₅	56.5	<i>tI32</i>	<i>I4/mcm</i>

(βSr)	100	$cI2$	$Im\bar{3}m$
(αSr)	100	$cF4$	$Fm\bar{3}m$

Cd-Te (Cadmium - Tellurium)

R.C. Sharma and Y.A. Chang, 1989

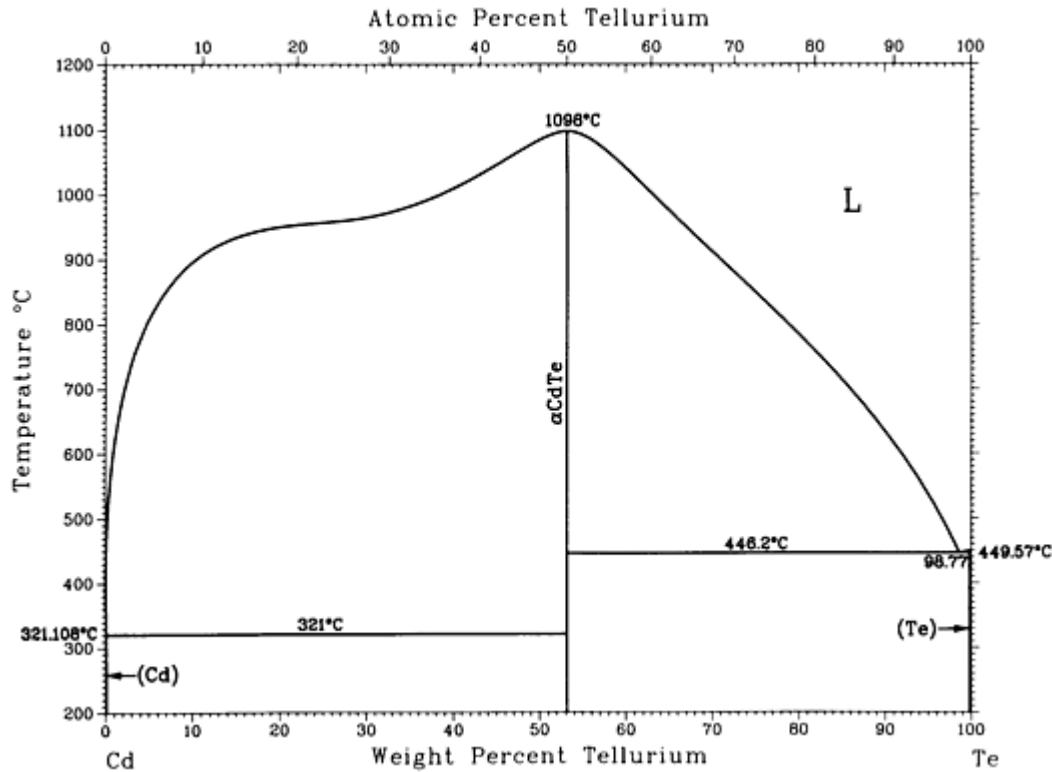

Cd-Te phase diagram

Cd-Te crystallographic data

Phase	Composition, wt% Te	Pearson symbol	Space group
(Cd)	0	$hP2$	$P6_3/mmc$
αCdTe	53.2	$cF8$	$F\bar{4}3m$
$\beta\text{CdTe}^{(a)}$	53.2	$cF8$	$Fm\bar{3}m$
$\gamma\text{CdTe}^{(a)}$	53.2	$tI4$	$I4_1/amd$

(Te) 100 *hP3* *P3₁21*

(a) High-pressure phase

Cd-Th (Cadmium - Thorium)

J. Dutkiewicz, unpublished

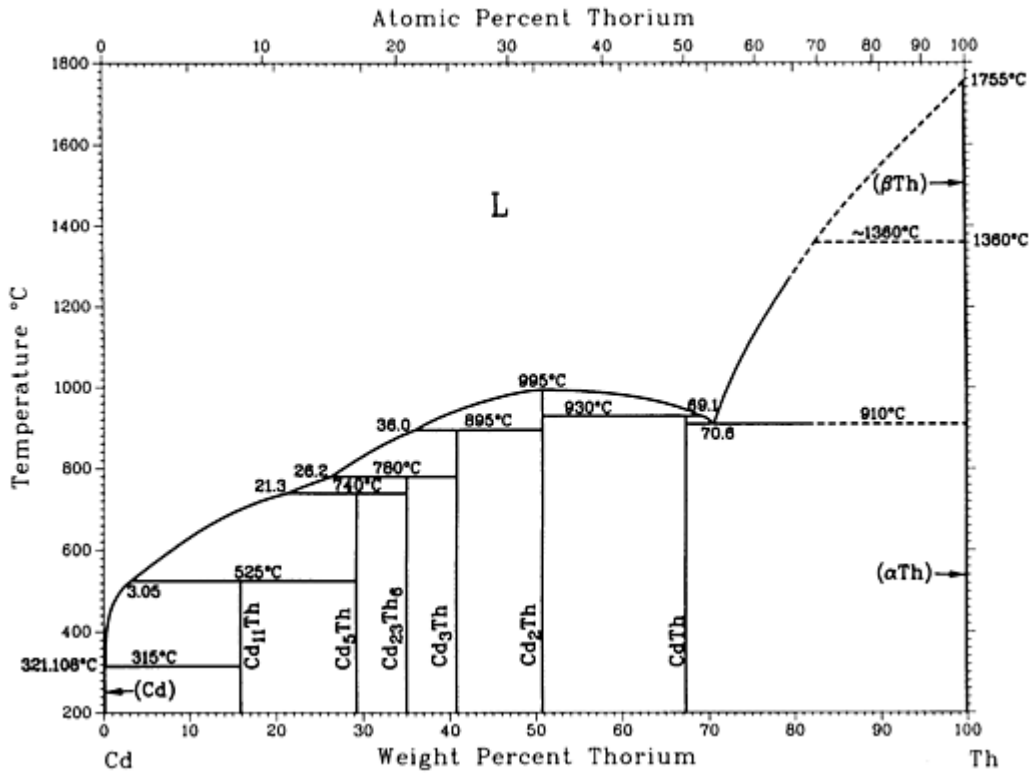

Cd-Th phase diagram

Cd-Th crystallographic data

Phase	Composition, wt% Th	Pearson symbol	Space group
(Cd)	0	<i>hP2</i>	<i>P6₃/mmc</i>
Cd₁₁Th	15.79	<i>cP36</i>	<i>Pm</i> $\bar{3}$ <i>m</i>
Cd₅Th	29.21	<i>hP36</i>	<i>P6₃/mmc</i>
Cd₂₃Th₆	35.00	<i>cF116</i>	<i>Fm</i> $\bar{3}$ <i>m</i>

Cd_3Th	41	<i>hP8</i>	<i>P6_3/mmc</i>
Cd_2Th	50.79	<i>hP3</i>	<i>P6/mmm</i>
CdTh	67.4	<i>oP24</i>	...
(αTh)	100	<i>cF4</i>	<i>Fm\bar{3}m</i>
(βTh)	100	<i>cI2</i>	<i>Im\bar{3}m</i>

Cd-Tl (Cadmium - Thallium)

H. Okamoto, 1990

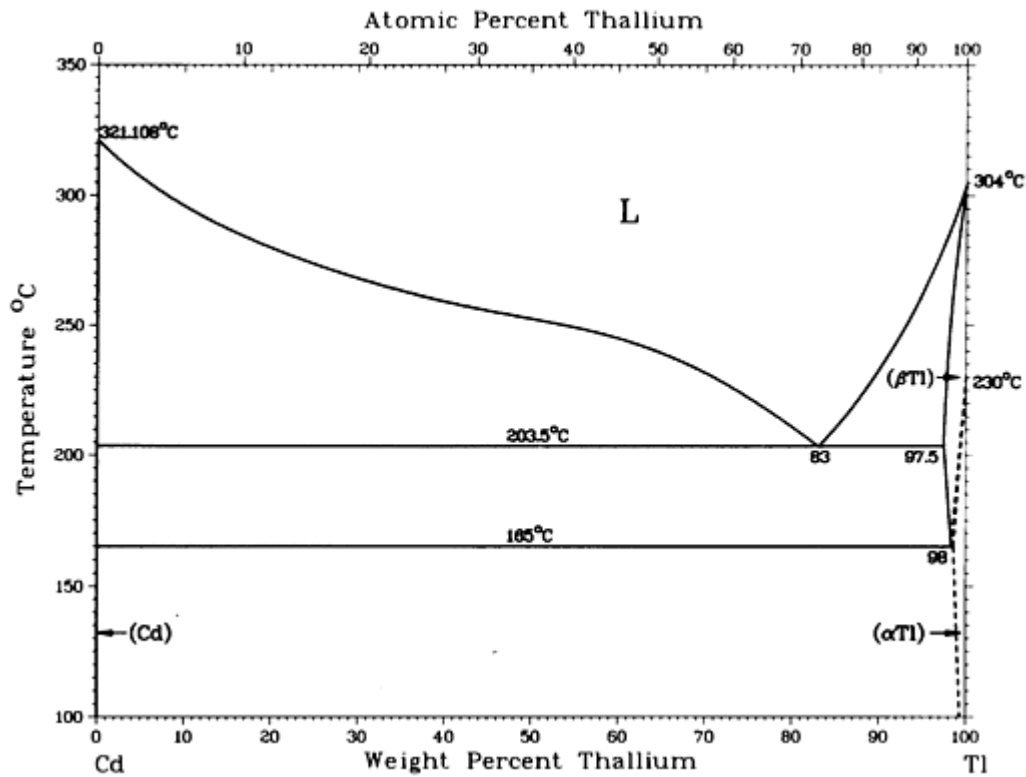

Cd-Tl phase diagram

Cd-Tl crystallographic data

Phase	Composition, wt% Tl	Pearson symbol	Space group
(Cd)	0	<i>hP2</i>	<i>P6_3/mmc</i>

(βTl)	97.5 to 100	$cI2$	$Im\bar{3}m$
(αTl)	~ 98 to 100	$hP2$	$P6_3/mmc$

Cd-Y (Cadmium - Yttrium)

K.A. Gschneidner, Jr. and F.W. Calderwood, 1988

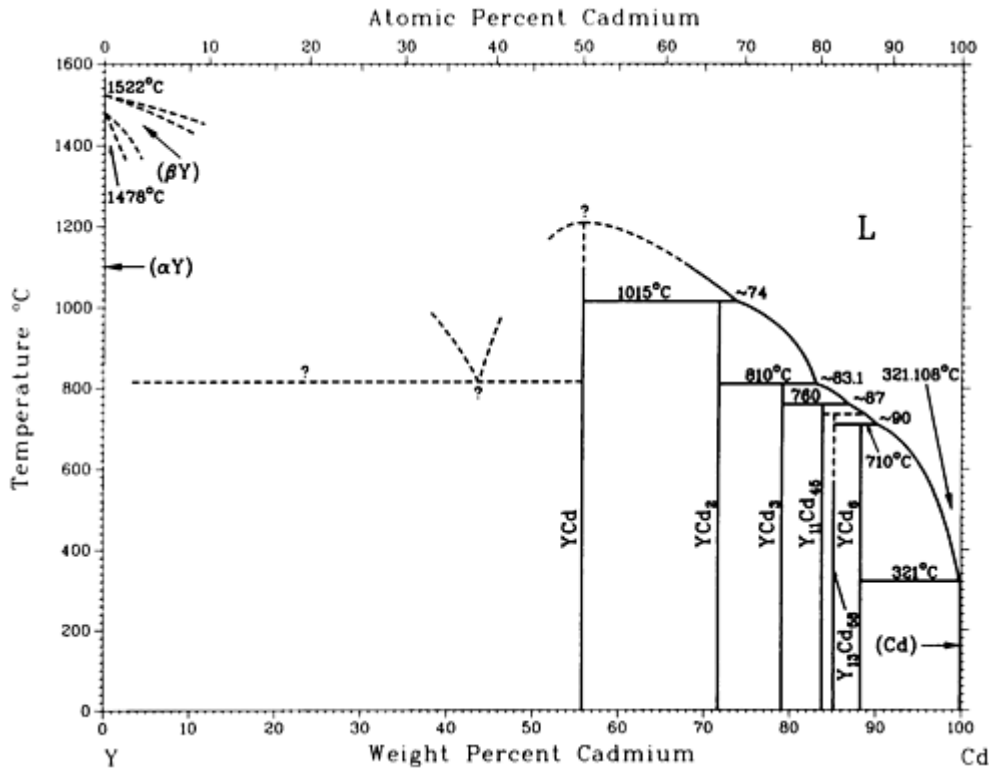

Cd-Y phase diagram

Cd-Y crystallographic data

Phase	Composition, wt% Cd	Pearson symbol	Space group
(αY)	0	$hP2$	$P6_3/mmc$
(βY)	0	$cI2$	$Im\bar{3}m$
YCd	55.8	$cP2$	$Pm\bar{3}m$
YCd ₂	71.7	$hP3$	$P3m1$
YCd ₃	79	$oC16$	$Cmcm$

$Y_{11}Cd_{45}$	83.8	<i>cF448</i>	$F\bar{4}3m$
$Y_{13}Cd_{58}$	85.0	<i>hP142</i>	$P6_3/mmc$
YCd_6	88.3	<i>cI168</i>	$Im\bar{3}$
(Cd)	100	<i>hP2</i>	$P6_3/mmc$

Cd-Yb (Cadmium - Ytterbium)

K.A. Gschneidner, Jr. and F.W. Calderwood, 1988

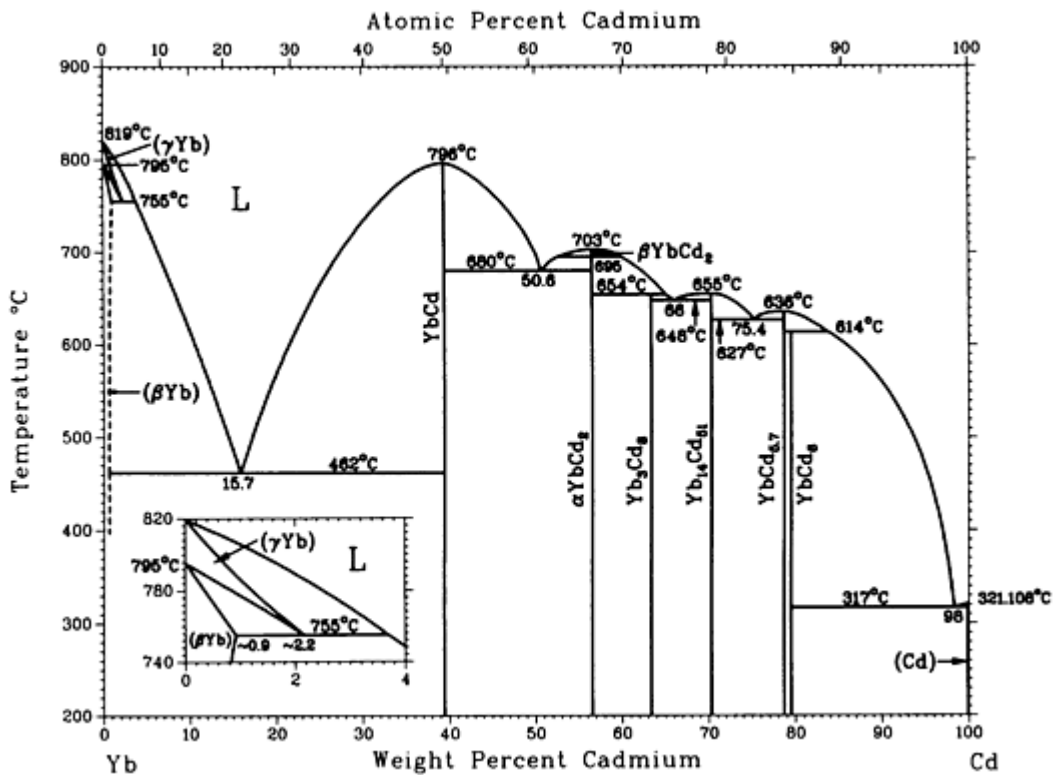

Cd-Yb phase diagram

Cd-Yb crystallographic data

Phase	Composition, wt% Cd	Pearson symbol	Space group
(β Yb)	0 to ~0.91	<i>cF4</i>	$Fm\bar{3}m$
(γ Yb)	0 to ~2.2	<i>cI2</i>	$Im\bar{3}m$

YbCd	39.4	<i>cP2</i>	<i>Pm</i> $\bar{3}m$
YbCd₂	56.5	<i>hP12</i>	<i>P6₃/mmc</i>
Yb₃Cd₈	63.4
Yb₁₄Cd₅₁	70.3	<i>hP65</i>	<i>P6/m</i>
YbCd_{5.7}	78.8
YbCd₆	79.6	<i>cI168</i>	<i>Im</i> $\bar{3}$
(Cd)	100	<i>hP2</i>	<i>P6₃/mmc</i>

Cd-Zn (Cadmium - Zinc)

J. Dutkiewicz and W. Zakulski, 1984

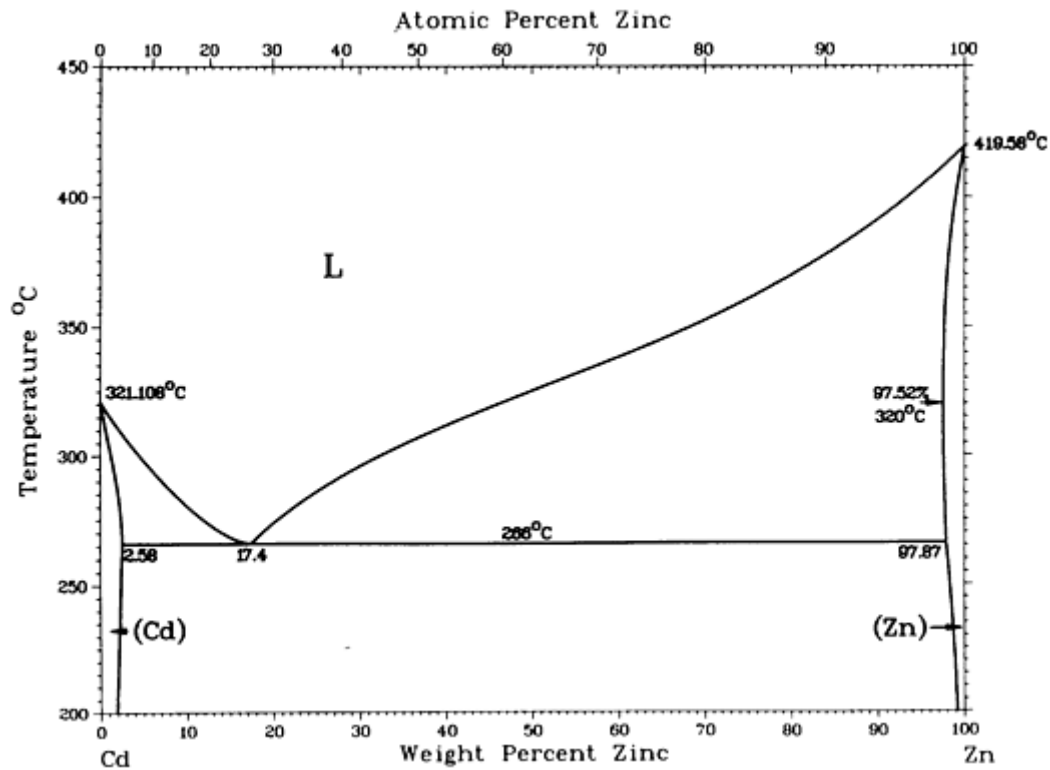

Cd-Zn phase diagram

Cd-Zn crystallographic data

Phase	Composition, wt% Zn	Pearson symbol	Space group
(Cd)	0 to 2.58	<i>hP2</i>	<i>P6₃/mmc</i>
(Zn)	97.52 to 100	<i>hP2</i>	<i>P6₃/mmc</i>

Ce (Cerium) Binary Alloy Phase Diagrams

Introduction

THIS ARTICLE includes systems where cerium is the first-named element in the binary pair. Additional binary systems that include cerium are provided in the following locations in this Volume:

- “Ag-Ce (Silver - Cerium)” in the article “Ag (Silver) Binary Alloy Phase Diagrams.”
- “Al-Ce (Aluminum - Cerium)” in the article “Al (Aluminum) Binary Alloy Phase Diagrams.”
- “Au-Ce (Gold - Cerium)” in the article “Au (Gold) Binary Alloy Phase Diagrams.”

Ce-Co (Cerium - Cobalt)

K.A. Gschneidner, Jr. and M.E. Verkade, 1974

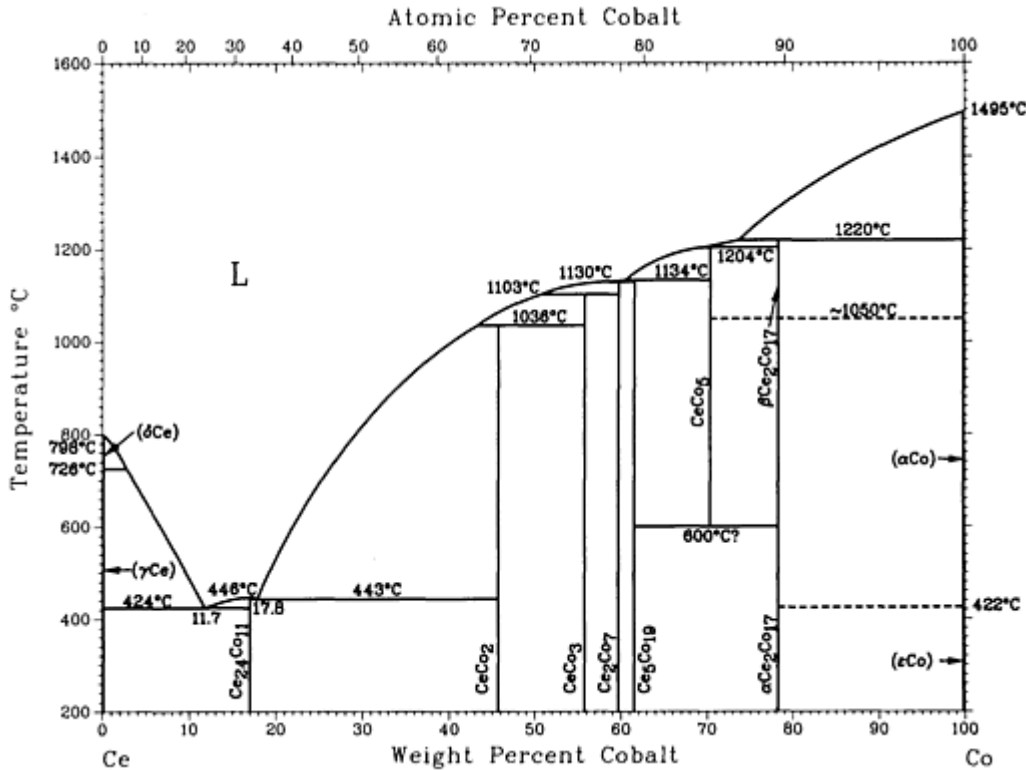

Ce-Co phase diagram

Ce-Co crystallographic data

Phase	Composition, wt% Co	Pearson symbol	Space group
(δ Ce)	0	<i>cI2</i>	<i>Im</i> $\bar{3}m$
(γ Ce)	0	<i>cF4</i>	<i>Fm</i> $\bar{3}m$
Ce₂₄Co₁₁	16.1	<i>hP70</i>	<i>P6₃/mc</i>
CeCo₂	45.7	<i>cF24</i>	<i>Fd</i> $\bar{3}m$
CeCo₃	56	<i>hR12</i>	<i>R</i> $\bar{3}m$
Ce₂Co₇	59.6	<i>hP36</i>	<i>P6₃/mmc</i>
Ce₅Co₁₉	61.1	<i>hR24</i>	<i>R</i> $\bar{3}m$
CeCo₅	67.7	<i>hP6</i>	<i>P6/mmm</i>
β Ce₂Co₁₇	78.2	<i>hP38</i>	<i>P6₃/mmc</i>
α Ce₂Co₁₇	78.2	<i>hR19</i>	<i>R</i> $\bar{3}m$
(α Co)	100	<i>cF4</i>	<i>Fm</i> $\bar{3}m$
(ϵ Co)	100	<i>hP2</i>	<i>P6₃/mmc</i>

Ce-Cu (Cerium - Copper)

P.R. Subramanian and D.E. Laughlin, 1988

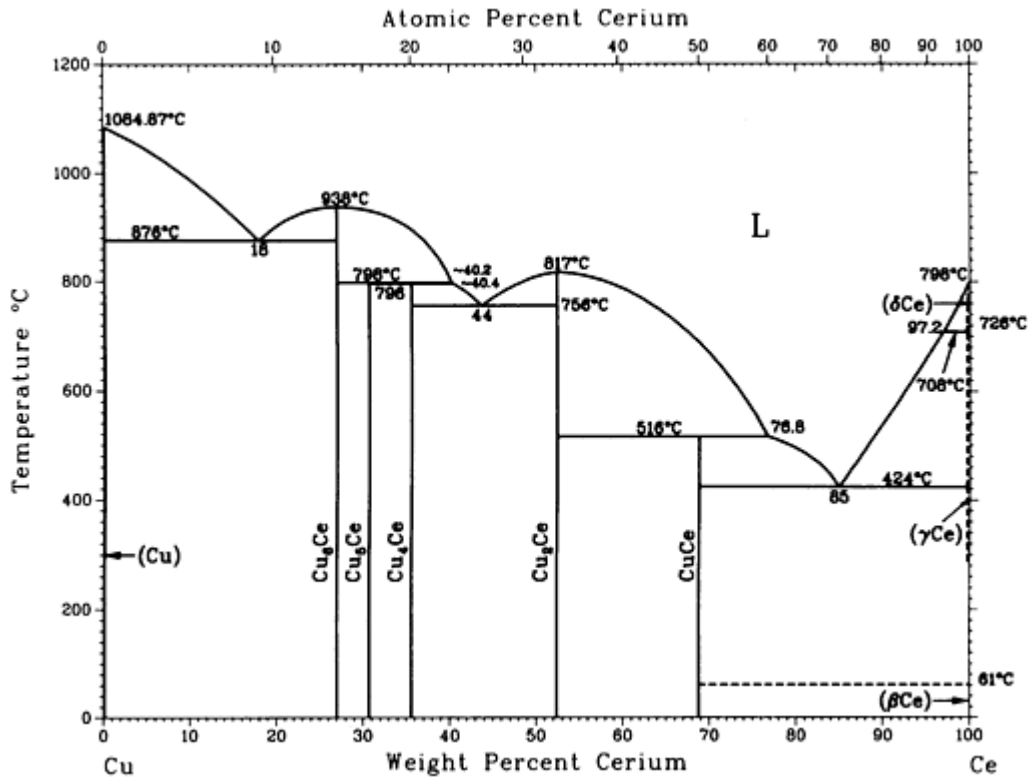

Ce-Cu phase diagram

Ce-Cu crystallographic data

Phase	Composition, wt% Ce	Pearson symbol	Space group
(Cu)	0	$cF4$	$Fm\bar{3}m$
Cu_6Ce	~26.88	$oP28$	$Pnma$
Cu_5Ce	~30.61	$hP6$	$P6/mmm$
Cu_4Ce	~35.5	$oP20$	$Pnmm$

Cu_2Ce	~ 52.4	$oI12$	$Imma$
CuCe	~ 68.8	$oP8$	$Pnma$
(δCe)	100	$cI2$	$Im\bar{3}m$
(γCe)	100	$cF4$	$Fm\bar{3}m$
(βCe)	100	$hP2$	$P6_3/mmc$
(αCe)	100	$cF4$	$Fm\bar{3}m$

Ce-Fe (Cerium - Iron)

W. Zhang, G. Liu, and K. Han, 1992

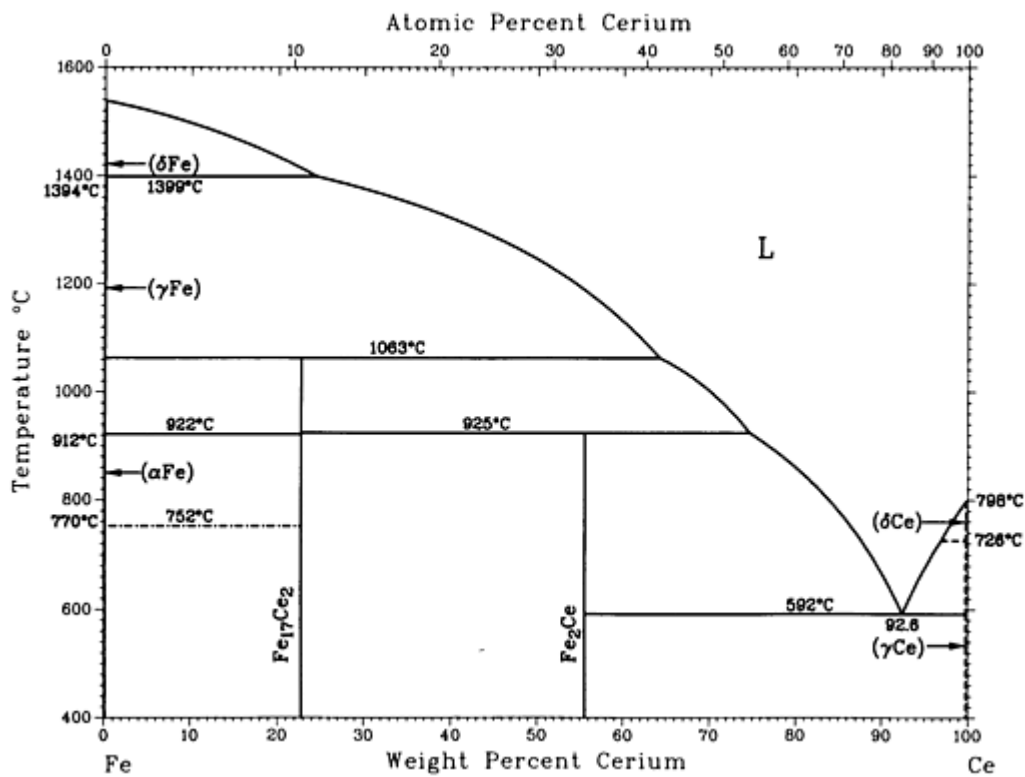

Ce-Fe phase diagram

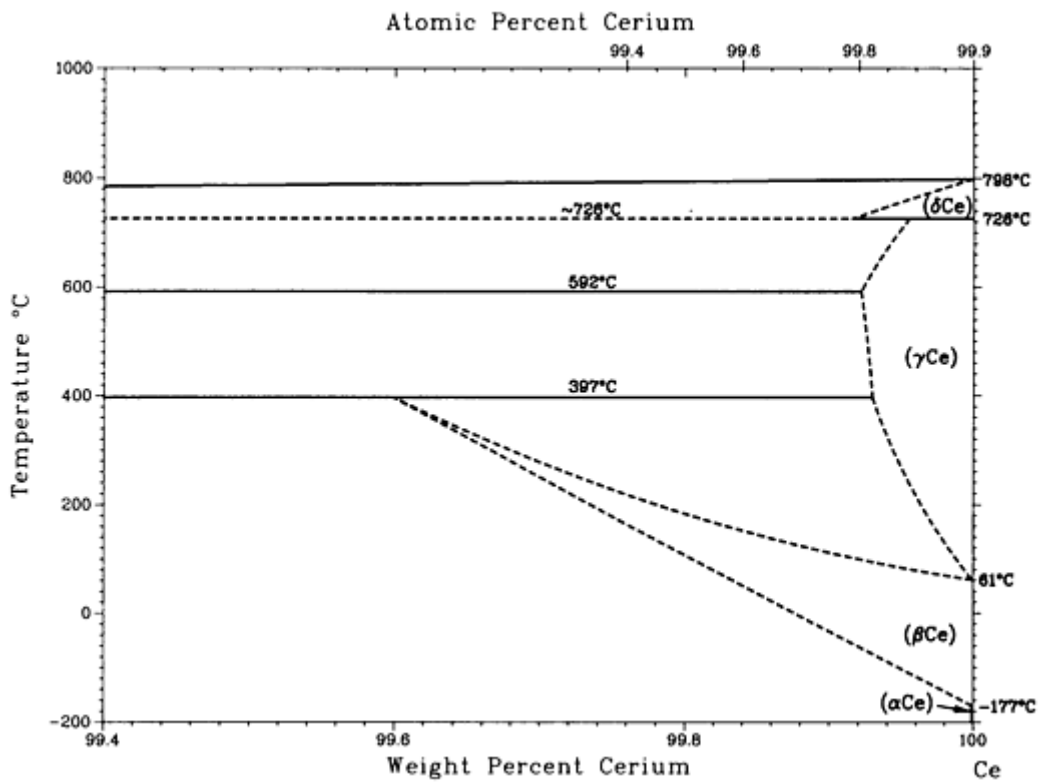

Enlargement of the Ce-rich portion of the Fe-Ce phase diagram.

Ce-Fe crystallographic data

Phase	Composition, wt% Ce	Pearson symbol	Space group
(δFe)	0	<i>cI2</i>	$Im\bar{3}m$
(γFe)	0	<i>cF4</i>	$Fm\bar{3}m$
(αFe)	0	<i>cI2</i>	$Im\bar{3}m$
$\alpha\text{Fe}_{17}\text{Ce}_2$	22.7	<i>hP38</i>	$P6/mmm$
$\beta\text{Fe}_{17}\text{Ce}_2$	22.7	<i>hR19</i>	$R\bar{3}m$
Fe_2Ce	55.6	<i>cF24</i>	$Fd\bar{3}m$
(δCe)	100	<i>cF4</i>	$Fm\bar{3}m$
(βCe)	100	<i>hP2</i>	$P6_3/mmc$

(α Ce) 100 $cF4$ $Fm\bar{3}m$

Ce-Ga (Cerium - Gallium)

H. Okamoto, 1990

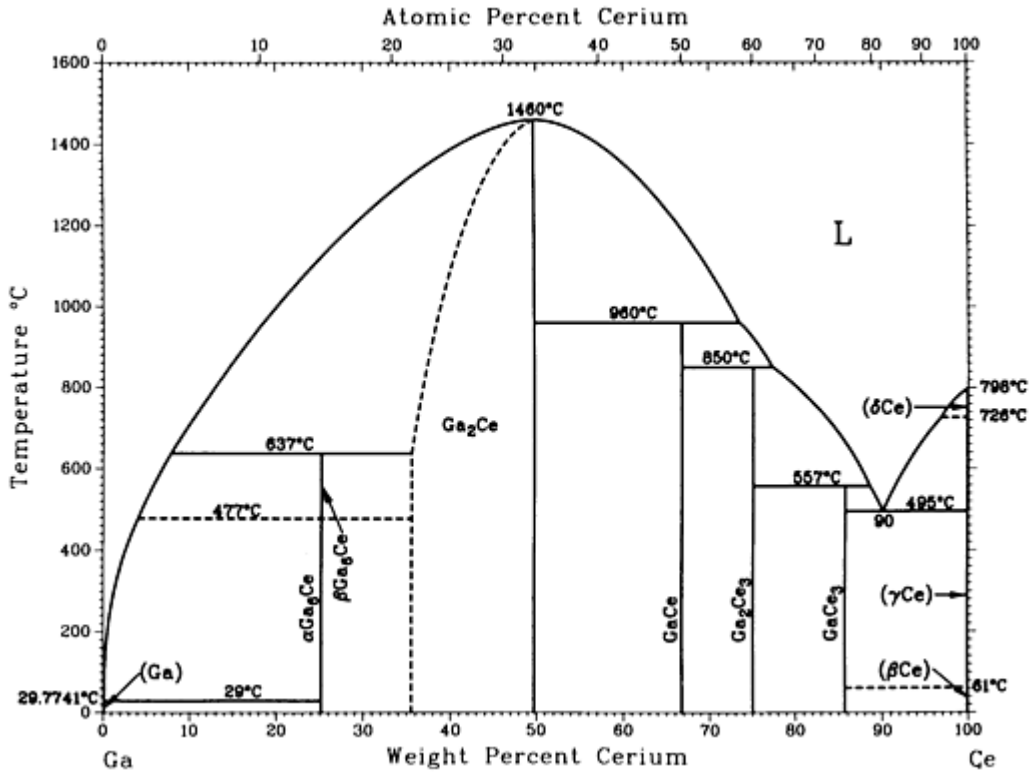

Ce-Ga phase diagram

Ce-Ga crystallographic data

Phase	Composition, wt% Ce	Pearson symbol	Space group
(Ga)	0	<i>oC8</i>	<i>Cmca</i>
βGa_6Ce	21.1
αGa_6Ce	21.1	<i>tI14</i>	<i>P4/nbm</i>
Ga_2Ce	? to 44.6	<i>hP3</i>	<i>P6/mmm</i>
$GaCe$	61.7	<i>oC8</i>	<i>Cmcm</i>

Ga_2Ce_3	71	$tP20$	$P4_2/mmm$
$\text{Ga}_3\text{Ce}_5^{(a)}$	73	$tI32$	$I4/mcm$
GaCe_3	83	$cP4$	$Pm\bar{3}m$
(δCe)	100	$cI2$	$Im\bar{3}m$
(γCe)	100	$cF4$	$Fm\bar{3}m$
(βCe)	100	$hP4$	$P6_3/mmc$

(a) Not shown in the diagram

Ce-Ge (Cerium - Germanium)

A.B. Gokhale and G.J. Abbaschian, 1989

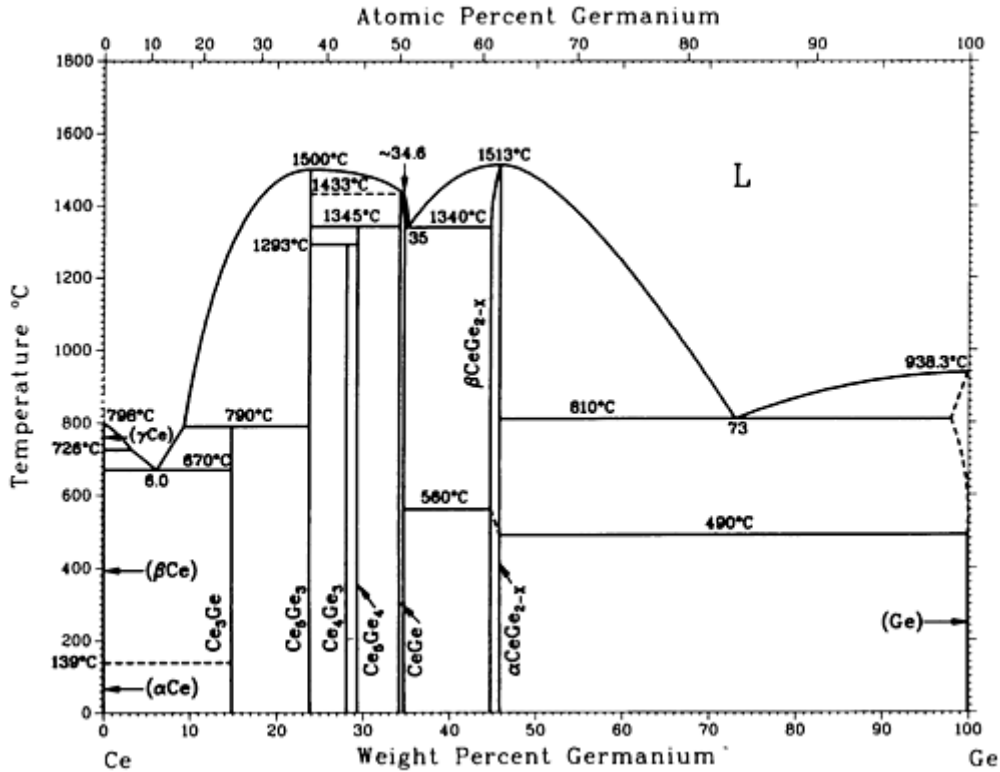

Ce-Ge phase diagram

Ce-Ge crystallographic data

Phase	Composition, wt% Ge	Pearson symbol	Space group
$(\delta\text{Ce})^{(a)}$	0	<i>cI2</i>	<i>Im\bar{3}m</i>
$(\gamma\text{Ce})^{(b)}$	0	<i>cF4</i>	<i>Fm\bar{3}m</i>
$(\beta\text{Ce})^{(c)}$	0	<i>hP4</i>	<i>P6₃/mmc</i>
$(\alpha\text{Ce})^{(d)}$	0	<i>cF4</i>	<i>Fm\bar{3}m</i>
Ce₃Ge	15
Ce₅Ge₃	23.7	<i>hP16</i>	<i>P6₃/mcm</i>
Ce₄Ge₃	28.0	<i>cI28</i>	<i>I\bar{4}3d</i>
Ce₅Ge₄	29.4	...	<i>Pnma</i>
CeGe	34.1	<i>oP8</i>	<i>Pnma</i>
αCeGe_{2-x}	44.9 to 45.94	^(e)	<i>Imma</i>
βCeGe_{2-x}	44.9 to 45.94	<i>tI12</i>	<i>I4₁/amd</i>
(Ge)	100	<i>cF8</i>	<i>Fd\bar{3}m</i>

(a) From 798 to 726 °C.

(b) From 726 to 61 °C (139 °C on heating, 16 °C on cooling).

(c) From 61 to -177 °C.

(d) Below -177 °C.

(e) Orthorhombic

Ce-In (Cerium - Indium)

H. Okamoto, 1992

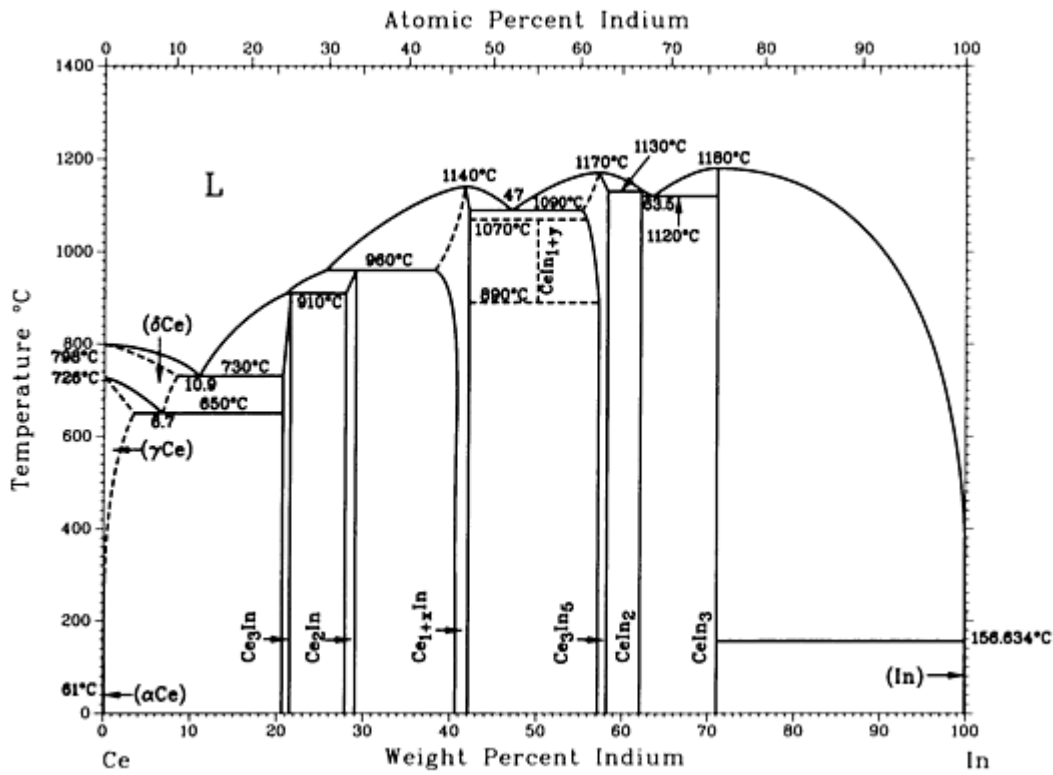

Ce-In phase diagram

Ce-In crystallographic data

Phase	Composition, wt% In	Pearson symbol	Space group
δ Ce	0 to 8	<i>cI2</i>	<i>Im</i> $\bar{3}m$
γ Ce	0 to 3	<i>cF4</i>	<i>Fm</i> $\bar{3}m$
β Ce	0	<i>hp4</i>	<i>P6</i> $_3/mmc$
α Ce	0	<i>cF4</i>	<i>Fm</i> $\bar{3}m$
β Ce ₃ In	22	<i>cF4</i>	<i>Fm</i> $\bar{3}m$
α Ce ₃ In	21 to 22	<i>cP4</i>	<i>Pm</i> $\bar{3}m$

Ce_2In	28 to 29.0	<i>hP6</i>	<i>P6_3/mmc</i>
Ce_{1+x}In	38 to 42
CeIn_{1+y}
Ce_3In_5	55 to 58	<i>oC32</i>	<i>Cmcm</i>
CeIn_2	62.1	<i>oI12</i>	<i>Imma</i>
CeIn_3	71	<i>cP4</i>	<i>Pm\bar{3}m</i>
(In)	100	<i>tI2</i>	<i>I4/mmm</i>

Ce-Ir (Cerium - Iridium)

H. Okamoto, 1991

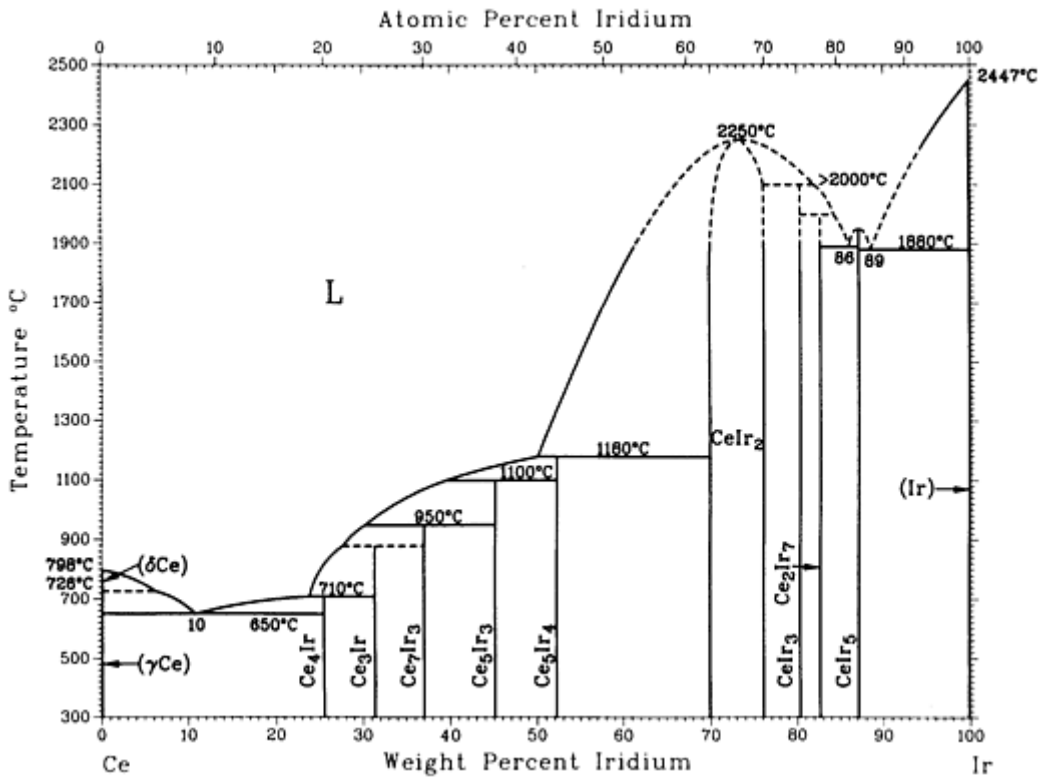

Ce-Ir phase diagram

Ce-Ir crystallographic data

Phase	Composition, wt% Ir	Pearson symbol	Space group
(δ Ce)	0	<i>cI2</i>	<i>Im</i> $\bar{3}m$
(γ Ce)	0	<i>cF4</i>	<i>Fm</i> $\bar{3}m$
(β Ce)	0	<i>hP4</i>	<i>P6₃/mmc</i>
(α Ce)	0	<i>cF4</i>	<i>Fm</i> $\bar{3}m$
Ce₄Ir	26
Ce₃Ir	31
Ce₇Ir₃	37	<i>hP20</i>	<i>P6₃mc</i>
Ce₅Ir₃	45.1	<i>tP32</i>	<i>P4/ncc</i>
Ce₅Ir₄	52.3	<i>oP36</i>	<i>Pnma</i>
CeIr₂	70 to 76	<i>cF24</i>	<i>Fd</i> $\bar{3}m$
CeIr₃	81	<i>hR12</i>	<i>R</i> $\bar{3}m$
Ce₂Ir₇	82.8	<i>hR18</i>	<i>R</i> $\bar{3}m$
CeIr₅	87.2	<i>cF24</i>	<i>F4</i> $\bar{3}m$
(Ir)	100	<i>cF4</i>	<i>Fm</i> $\bar{3}m$

Ce-Mg (Cerium - Magnesium)

A.A. Nayeb-Hashemi and J.B. Clark, 1988

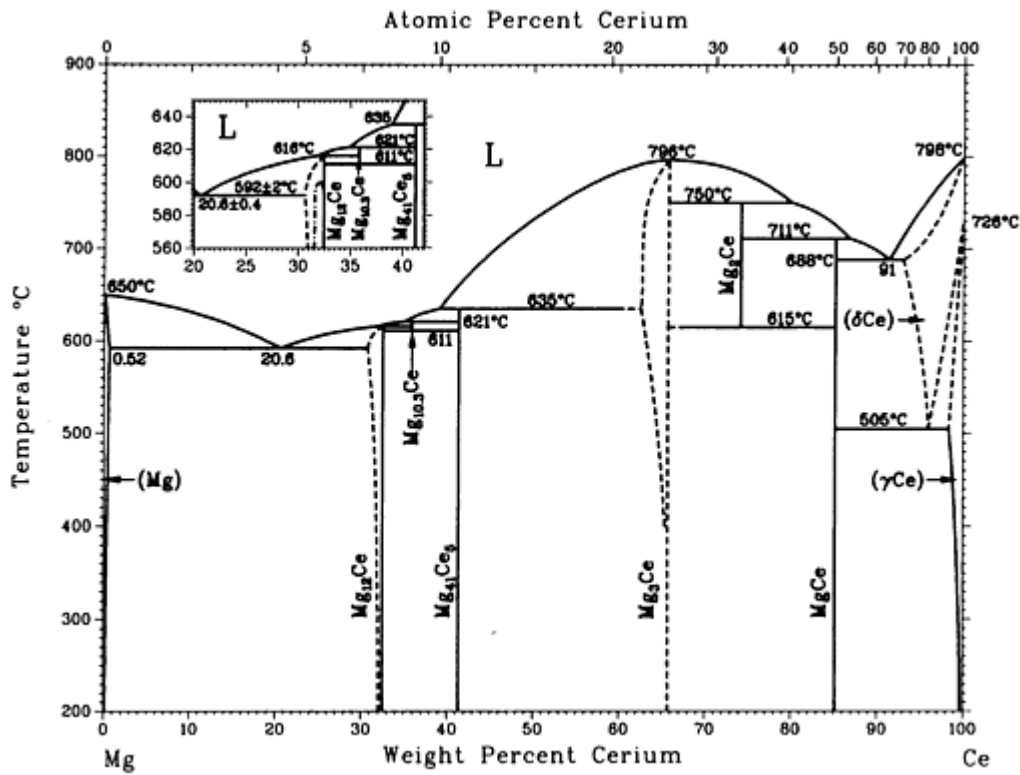

Ce-Mg phase diagram

Ce-Mg crystallographic data

Phase	Composition, wt% Ce	Pearson symbol	Space group
(Mg)	0 to 0.52	<i>hP2</i>	<i>P6₃/mmc</i>
Mg ₁₂ Ce(I)	32.44 ^(a) , ^(b)	<i>tI26</i>	<i>I4/mmm</i>
Mg ₁₂ Ce(II)	32.44 ^(b)	<i>oI338</i>	<i>(Immm)</i>
Mg _{10.3} Ce	35.89 ^(a)	<i>hP38</i>	<i>P6₃/mmc</i>

Mg_3Ce	? to 66	$cF16$	$Fm\bar{3}m$
Mg_2Ce	74.24 ^(a)	$cF24$	$Fd\bar{3}m$
MgCe	85.22	$cP2$	$Pm\bar{3}m$
(δCe)	? to 100	$cI2$	$Im\bar{3}m$
(γCe)	98.5 to 100	$cF4$	$Fm\bar{3}m$

(a) Appears to be a line compound. The composition range, if any, is unknown.

(b) Composition has not been established with certainty.

(c) The $\text{Ni}_{17}\text{Th}_2$ structure type is taken from the homologous Mg-Nd system. In the Mg-Ce system, the $\text{Ni}_{17}\text{Th}_2$ structure has not yet been found.

Ce-Mn (Cerium - Manganese)

A. Palenzona and S. Cirafici, unpublished

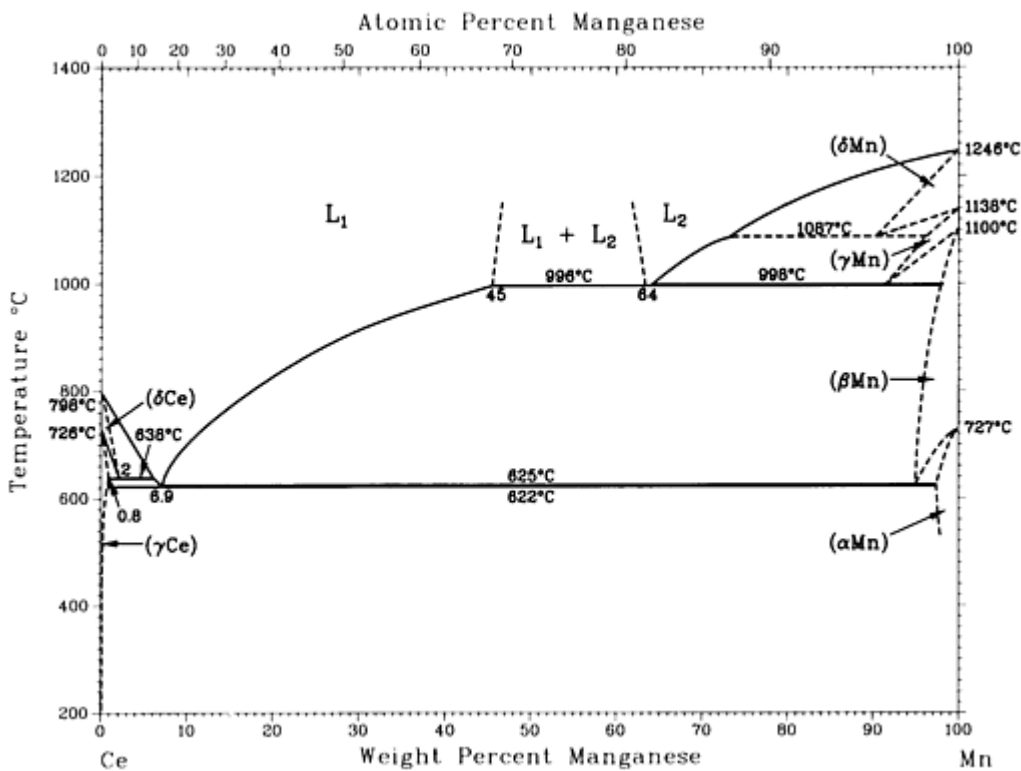

Ce-Mn phase diagram

Ce-Mn crystallographic data

Phase	Composition, wt% Mn	Pearson symbol	Space group
(δ Ce)	0 to 2	<i>cI2</i>	<i>Im</i> $\bar{3}m$
(γ Ce)	0 to 0.8	<i>cF4</i>	<i>Fm</i> $\bar{3}m$
(β Ce)	0	<i>hP4</i>	<i>P6₃/mmc</i>
(α Ce)	0	<i>cF4</i>	<i>Fm</i> $\bar{3}m$
(δ Mn)	~ 100	<i>cI2</i>	<i>Im</i> $\bar{3}m$
(γ Mn)	~ 100	<i>cF4</i>	<i>Fm</i> $\bar{3}m$
(β Mn)	~ 100	<i>cP20</i>	<i>P4₁32</i>
(α Mn)	~ 100	<i>cI58</i>	<i>I</i> $\bar{4}3m$

Ce-Ni (Cerium - Nickel)

P. Nash and C.H. Tung, 1991

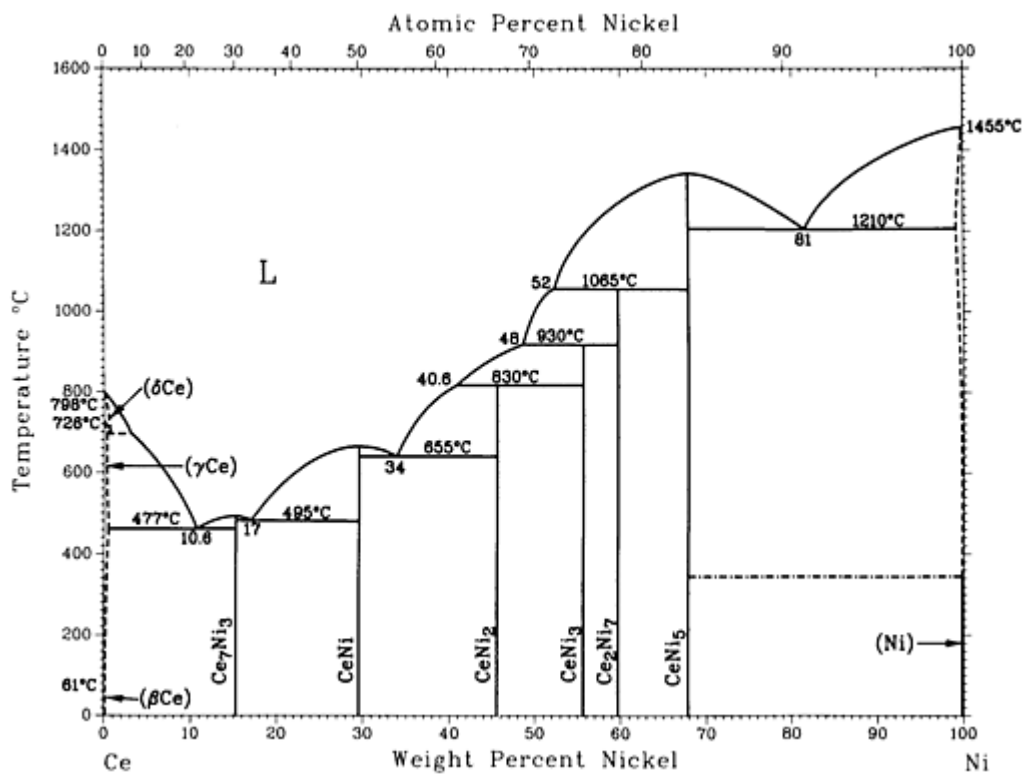

Ce-Ni phase diagram

Ce-Ni crystallographic data

Phase	Composition, wt% Ni	Pearson symbol	Space group
(γCe)	~0	<i>cF4</i>	<i>Fm</i> $\bar{3}m$
(δCe)	~0	<i>cI2</i>	<i>Im</i> $\bar{3}m$
Ce ₇ Ni ₃	15	<i>hP20</i>	<i>P6</i> ₃ <i>mc</i>
CeNi	29.5	<i>oC8</i>	<i>Cmcm</i>
CeNi ₂	45.6	<i>cF24</i>	<i>Fd</i> $\bar{3}m$
CeNi ₃	55.7	(a)	<i>P6</i> ₃ <i>/mmc</i>
Ce ₂ Ni ₇	59.5	(b)	<i>P6</i> ₃ <i>/mmc</i>
CeNi ₅	67.6	<i>hP6</i>	<i>P6/mmm</i>

(Ni)^(c) 99.90 to 100 cF4 $Fm\bar{3}m$

(a) Hexagonal.

(b) Solubility of Ce in Ni is 0.05 at.% Ce at 1200 °C and 0.04 at.% Ce at room temperature.

(c) Data were obtained from pure Ni.

Ce-O (Cerium - Oxygen)

P.R. Subramanian, 1990

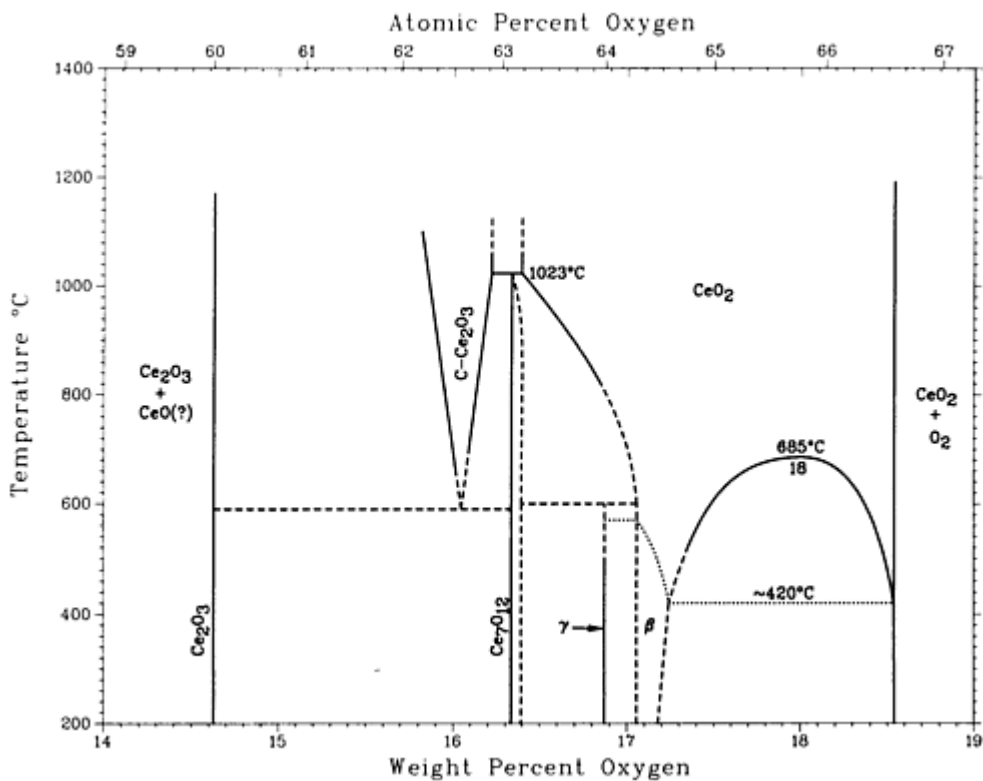

Ce-O phase diagram

Ce-O crystallographic data

Phase	Composition, wt% O	Pearson symbol	Space group
$(\alpha\text{Ce})^{(a)}$	~ 0	<i>cF4</i>	$Fm\bar{3}m$
$(\beta\text{Ce})^{(b)}$	~ 0	<i>hP4</i>	$P6_3/mmc$
$(\gamma\text{Ce})^{(c)}$	~ 0	<i>cF4</i>	$Fm\bar{3}m$
$(\delta\text{Ce})^{(d)}$	~ 0	<i>cI2</i>	$Im\bar{3}m$
CeO	~ 10.2	<i>cF8</i>	$Fm\bar{3}m$
Ce₂O₃	~ 15	<i>hP5</i>	$P\bar{3}m1$
"C-C ₂ O ₃ " ^{(e), (g)}	15.86 to 16.16	<i>cI80</i>	$Ia\bar{3}$
Ce₇O₁₂	16.3 to 16.43	<i>hR22</i>	$R\bar{3}$
$\gamma^{(f)}$	~ 16.90	<i>hR?</i>	...
$\beta^{(g)}$	~ 17.1 to 17.2	<i>hR?</i>	...
Ce₆O₁₁ ^(h)	~ 17.3	<i>mP?</i>	$P2_1/n$
CeO₂	~ 18.6	<i>cF12</i>	$Fm\bar{3}m$
CeO₂ ⁽ⁱ⁾	~ 18.6	<i>hP48</i>	...
High-pressure phase			
CeO ^(j)	~ 10.2	<i>cF?</i>	...

(a) Below room temperature.

- (b) Up to 61 °C.
- (c) From 61 to 726 °C.
- (d) From 726 to 798 °C.
- (e) High-temperature phase; stable above ~ 590 °C.
- (f) Reported to be γ form of Ce_2O_3 , perhaps a compound with stoichiometry Ce_9O_{16} , with monoclinic or lower symmetry.
- (g) Reported to be β form of Ce_2O_3 , perhaps a compound with stoichiometry $\text{Ce}_{10}\text{O}_{18}$, with monoclinic or lower symmetry.
- (h) High-temperature phase; reported to be stable between 790 and 850 °C.
- (i) Reported to be high-temperature phase, observed at 1340 °C.
- (j) High-pressure phase, formed by reaction of Ce and CeO_2 at 700 °C and 15 kbar pressure

Ce-Pd (Cerium - Palladium)

H. Okamoto, 1991

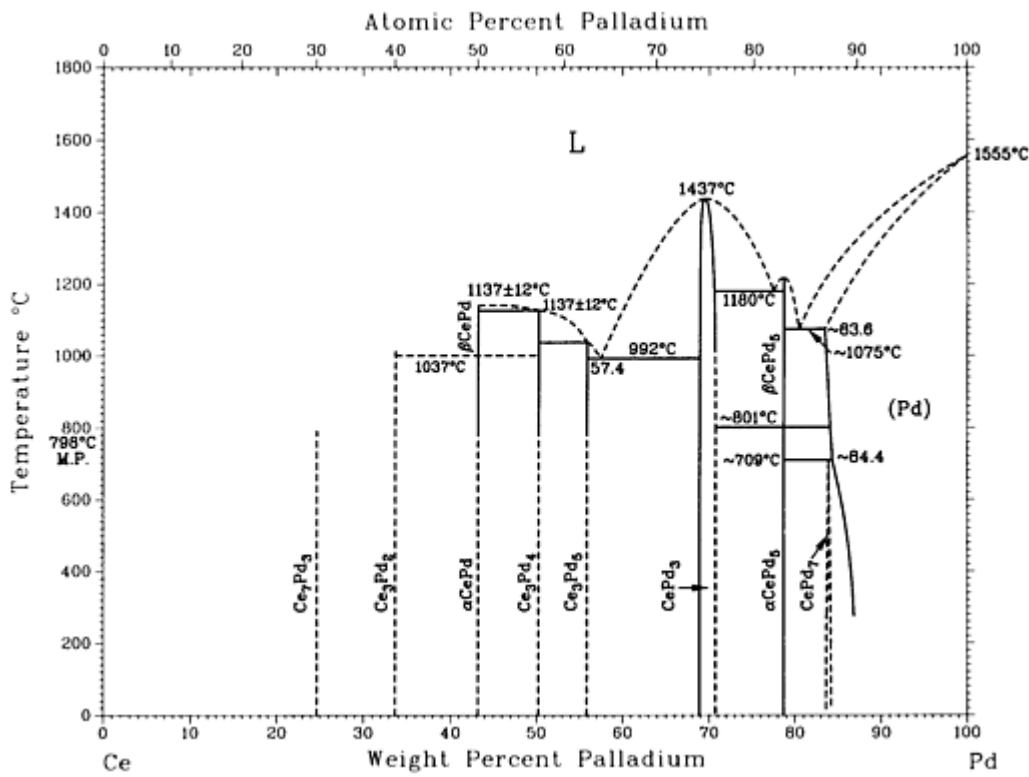

Ce-Pd phase diagram

Ce-Pd crystallographic data

Phase	Composition, wt% Pd	Pearson symbol	Space group
(δ Ce)	0	<i>cI2</i>	<i>Im$\bar{3}m$</i>
(γ Ce)	0	<i>cF4</i>	<i>Fm$\bar{3}m$</i>
(β Ce)	0	<i>hP4</i>	<i>P6₃/mmc</i>
(α Ce)	0	<i>cF4</i>	<i>Fm$\bar{3}m$</i>
Ce₇Pd₃	25	<i>hP20</i>	<i>P6₃mc</i>
Ce₃Pd₂	34
βCePd	43.2	<i>oP8</i>	<i>Pnma</i>
αCePd	43.2	<i>oC8</i>	<i>Cmcm</i>

Ce₃Pd₄	50.3	<i>hR14</i>	<i>R$\bar{3}$m</i>
Ce₃Pd₅	55.9	<i>hP8</i>	<i>P$\bar{6}$2m</i>
CePd₃	69.3 to 70.9	<i>cP4</i>	<i>Pm$\bar{3}$m</i>
<i>β</i> CePd₅	79.1	<i>hR*</i>	...
<i>α</i> CePd₅	79.1	<i>cF*</i>	...
CePd₇	84.2	<i>cF*</i>	<i>Fm$\bar{3}$m</i>
(Pd)	84 to 100	<i>cF4</i>	<i>Fm$\bar{3}$m</i>

Ce-Pu (Cerium - Plutonium)

J.E. Selle and D.E. Etter, 1964

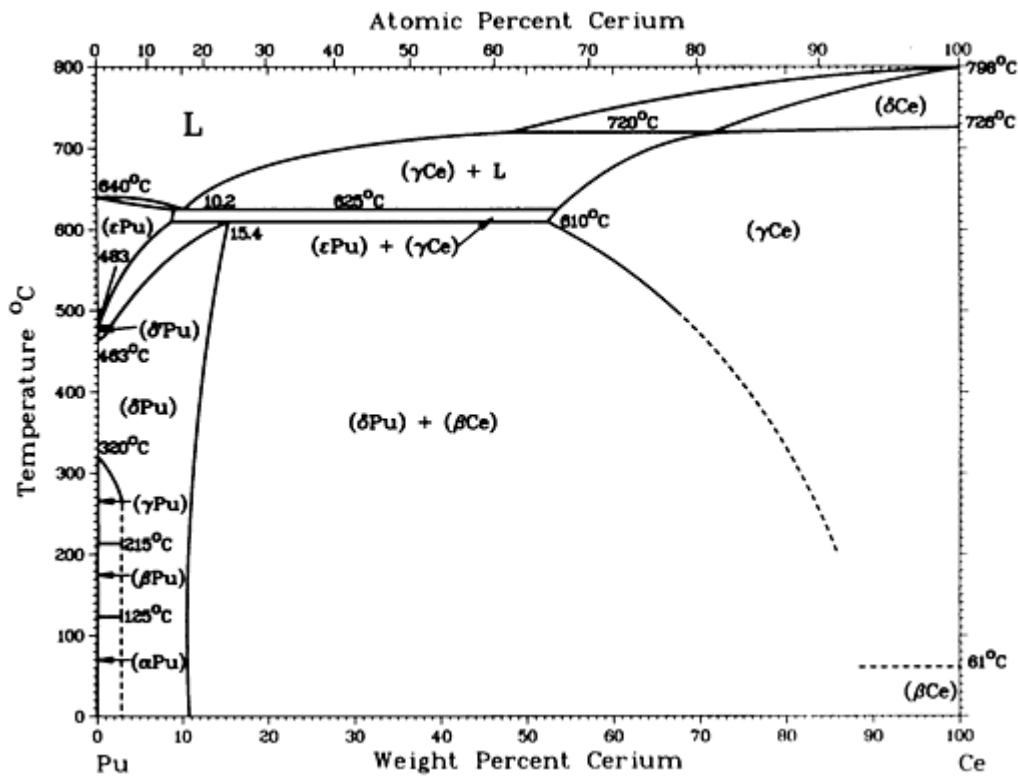

Ce-Pu phase diagram

Ce-Pu crystallographic data

Phase	Composition, wt% Ce	Pearson symbol	Space group
(εPu)	0 to 9	<i>cI2</i>	<i>Im</i> $\bar{3}m$
(δ'Pu)	0	<i>tI2</i>	<i>I4/mmm</i>
(δPu)	0 to 15.4	<i>cF4</i>	<i>Fm</i> $\bar{3}m$
(γPu)	0	<i>oF8</i>	<i>Fddd</i>
(βPu)	0	<i>mC34</i>	<i>I2/m</i>
(αPu)	0	<i>mP16</i>	<i>P2₁/m</i>
(δCe)	72 to 100	<i>cI2</i>	<i>Im</i> $\bar{3}m$
(γCe)	53 to 100	<i>cF4</i>	<i>Fm</i> $\bar{3}m$

(βCe)	100	$hP4$	$P6_3/mmc$
(αCe)	100	$cF4$	$Fm\bar{3}m$

Ce-S (Cerium - Sulfur)

K.A. Gschneidner, Jr. and M.E. Verkade, 1974

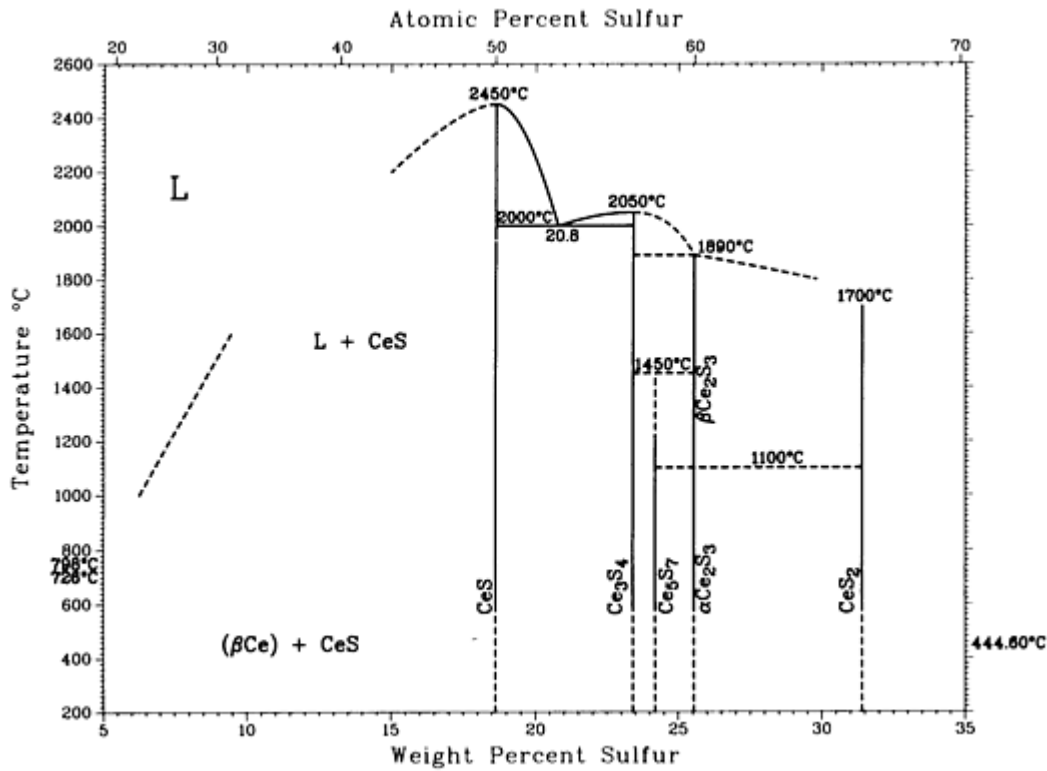

Ce-S phase diagram

Ce-S crystallographic data

Phase	Composition, wt% S	Pearson symbol	Space group
(γCe)	0	$cF4$	$Fm\bar{3}m$
CeS	18.6	$cF8$	$Fm\bar{3}m$
Ce_3S_4	23.3
Ce_5S_7	24.2	$tI92$	$I4_1/acd$

$\beta\text{Ce}_2\text{S}_3$	26	<i>cI28</i>	$I\bar{4}3d$
$\alpha\text{Ce}_2\text{S}_3$	26	<i>oP20</i>	<i>Pnma</i>
CeS_2	31.4	<i>tP24</i>	<i>P4/nmm</i>

Ce-Si (Cerium - Silicon)

A. Munitz, A.B. Gokhale, and G.J. Abbaschian, 1989

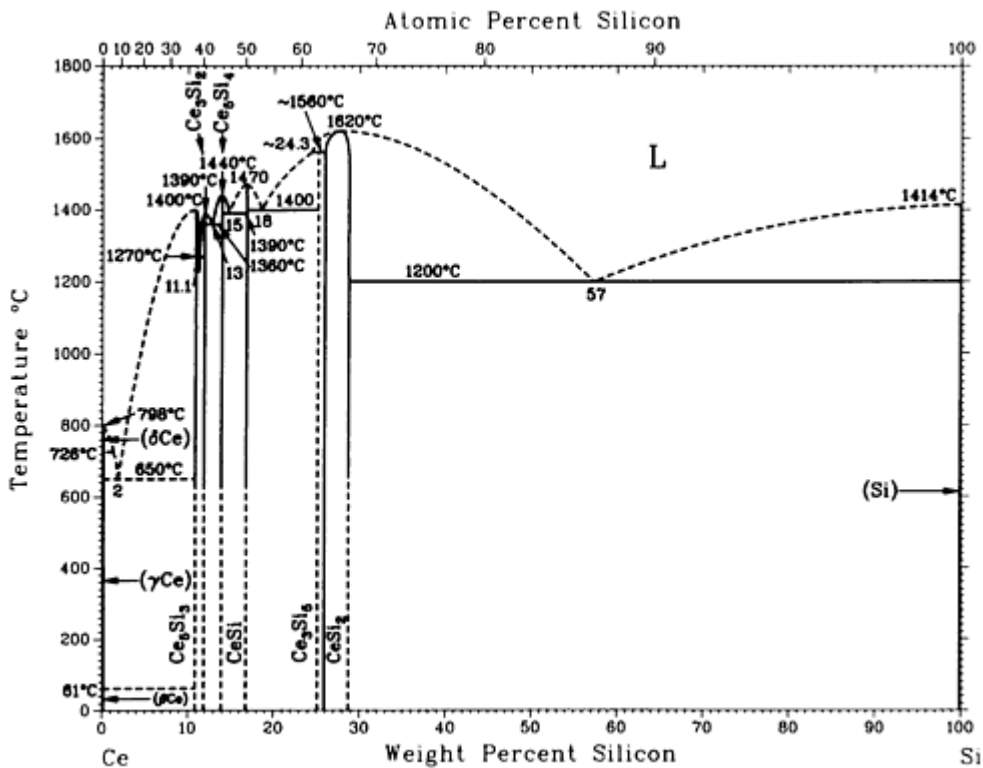

Ce-Si phase diagram

Ce-Si crystallographic data

Phase	Composition, wt% Si	Pearson symbol	Space group
$\delta\text{Ce}^{(a)}$	0	<i>cI2</i>	$Im\bar{3}m$
$\gamma\text{Ce}^{(b)}$	0	<i>cF4</i>	$Fm\bar{3}m$
$\beta\text{Ce}^{(c)}$	0	<i>hP4</i>	$P6_3/mmc$

$\alpha\text{Ce}^{(d)}$	0	<i>cF4</i>	<i>Fm</i> $\bar{3}m$
Ce_5Si_3	10.7	<i>tI32</i>	<i>I4/mcm</i>
Ce_3Si_2	12	<i>tP10</i>	<i>P4/mbm</i>
Ce_5Si_4	13.8	^(e)	...
CeSi	16.7	<i>oP8</i>	<i>Pnma</i>
Ce_3Si_5	25.0	^(f)	<i>Imma</i>
CeSi_2	26 to 28.62	<i>tI12</i>	<i>I4_1/amd</i>
Si	100	<i>cF8</i>	<i>Fd</i> $\bar{3}m$
SiII(H.P.)	100	<i>tI4</i>	<i>I4_1/amd</i>

(a) From 798 to >726 °C.

(b) From 726 to >61 °C
(139 °C on heating,
16 °C on cooling).

(c) From 61 °C to ?

(d) <177 °C.

(e) Tetragonal.

(f) Orthorhombic

Ce-Sn (Cerium - Tin)

H. Okamoto, 1990

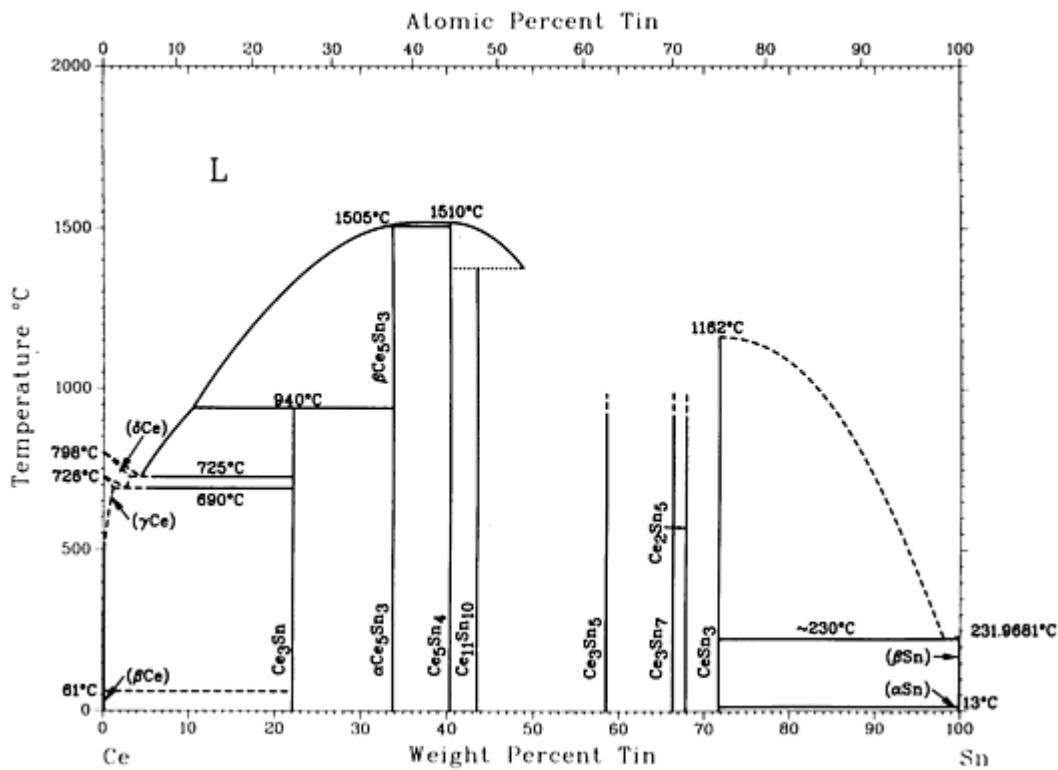

Ce-Sn phase diagram

Ce-Sn crystallographic data

Phase	Composition, wt% Sn	Pearson symbol	Space group
(δ Ce)	0 to ?	<i>cI2</i>	<i>Im$\bar{3}m$</i>
(γ Ce)	0 to ?	<i>cF4</i>	<i>Fm$\bar{3}m$</i>
(β Ce)	0	<i>hP4</i>	<i>P6</i> ₃ / <i>mmc</i>
(α Ce)	0	<i>cF4</i>	<i>Fm$\bar{3}m$</i>
Ce ₃ Sn	22	<i>cP4</i>	<i>Pm$\bar{3}m$</i>
β Ce ₅ Sn ₃	33.7	<i>hP16</i>	<i>P6</i> ₃ / <i>mcm</i>
α Ce ₅ Sn ₃	33.7	<i>tI32</i>	<i>I4/mcm</i>
Ce ₅ Sn ₄	40.4	<i>oP36</i>	<i>Pnma</i>

$Ce_{11}Sn_{10}$	43.5	$I\bar{4}$	$I4/mmm$
Ce_3Sn_5	58.5	$oC32$	$Cmcm$
Ce_3Sn_7	66	o^{**}	...
Ce_2Sn_5	67.9	o^{**}	...
$CeSn_3$	72	$cP4$	$Pm\bar{3}m$
(βSn)	100	$I\bar{4}$	$I4_1/amd$
(αSn)	100	$cF8$	$Fm\bar{3}m$

Ce-Te (Cerium - Tellurium)

H. Okamoto, 1990

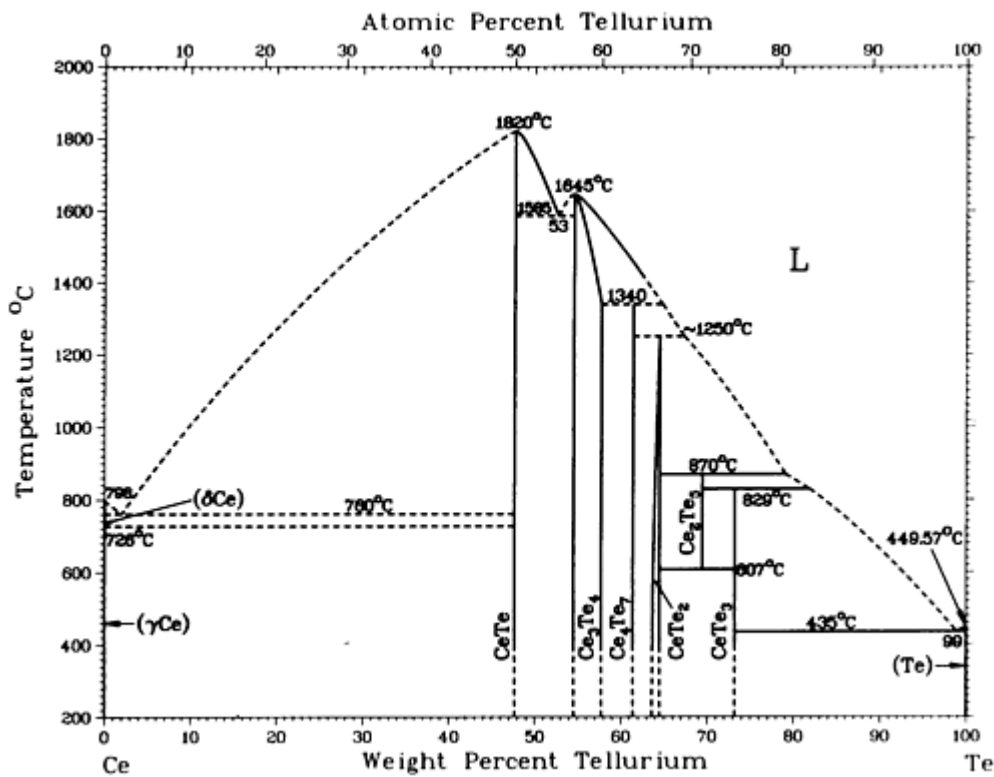

Ce-Te phase diagram

Ce-Te crystallographic data

Phase	Composition, wt% Te	Pearson symbol	Space group
(δ Ce)	0	<i>cI2</i>	<i>Im$\bar{3}m$</i>
(γ Ce)	0	<i>cF4</i>	<i>Fm$\bar{3}m$</i>
(β Ce)	0	<i>hP4</i>	<i>P6₃/mmc</i>
CeTe	47.7	<i>cF8</i>	<i>Fm$\bar{3}m$</i>
Ce₃Te₄	54.8 to 58	<i>cI28</i>	<i>I$\bar{4}$_{3d}</i>
Ce₄Te₇	61.1	<i>tP*</i>	...
CeTe₂	64.6	<i>tP6</i>	<i>P4/nmm</i>
Ce₂Te₅	69.5	<i>oC28</i>	<i>Cmcm</i>
CeTe₃	73	<i>oC16</i>	<i>Cmcm</i>
(Te)	100	<i>hP3</i>	<i>P3₁21</i>

Ce-Ti (Cerium - Titanium)

J.L. Murray, 1987

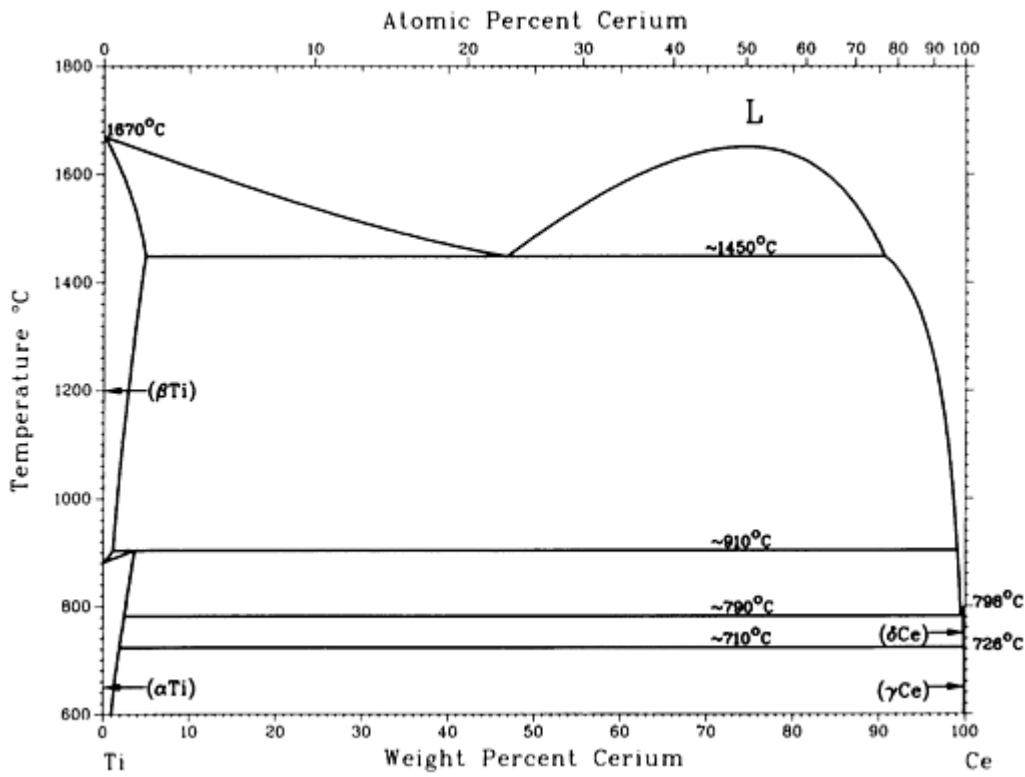

Ce-Ti phase diagram

Ce-Ti crystallographic data

Phase	Composition, wt% Ce	Pearson symbol	Space group
(αTi)	0 to 3.4	<i>hP2</i>	<i>P6₃/mmc</i>
(βTi)	0 to 4.8	<i>cI2</i>	<i>Im$\bar{3}m$</i>
(δCe)	99.9 to 100	<i>cI2</i>	<i>Im$\bar{3}m$</i>
(γCe)	100	<i>cF4</i>	<i>Fm$\bar{3}m$</i>
(βCe)	100	<i>hP4</i>	<i>P6₃/mmc</i>

Ce-Tl (Cerium - Thallium)

S. Delfino, A. Saccone, A. Palenzona, and R. Ferro, unpublished

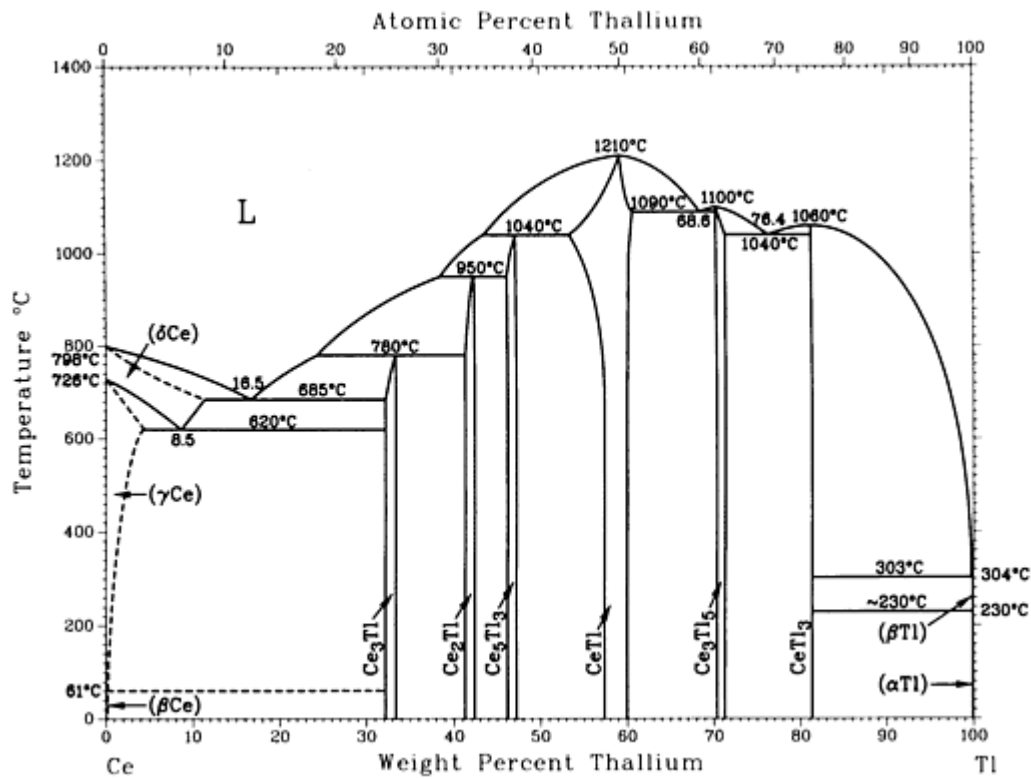

Ce-Tl phase diagram

Ce-Tl crystallographic data

Phase	Composition, wt% Tl	Pearson symbol	Space group
(α Ce)	0	<i>cF4</i>	<i>Fm</i> $\bar{3}m$
(β Ce)	0	<i>hP4</i>	<i>P6₃/mmc</i>
(γ Ce)	0 to 4	<i>cF4</i>	<i>Fm</i> $\bar{3}m$
(δ Ce)	0 to 13	<i>cI2</i>	<i>Im</i> $\bar{3}m$
Ce ₃ Tl ^(a)	~32.1 to ~33.3 ~33	<i>cP4</i> <i>cF4</i>	<i>Pm</i> $\bar{3}m$ <i>Fm</i> $\bar{3}m$
Ce ₂ Tl	~42

Ce_5Tl_3	~ 46 to ~ 47	$tI32$	$I4/mcm$
$\text{CeTi}^{(b)}$	~ 53 to ~ 60	$cP2$ (or $cI2$)	$Pm\bar{3}m$ $Im\bar{3}m$
$\text{CeTi}^{(c)}$	~ 53 to ~ 60	$tP2$	$P4/mmm$
Ce_3Tl_5	~ 70 to ~ 71	$oC32$	$Cmcm$
CeTi_3	81	$cP4$	$Pm\bar{3}m$
$(\beta\text{-Ti})$	100	$cI2$	$Im\bar{3}m$
$(\alpha\text{-Ti})$	100	$hP2$	$P6_3/mmc$

(a) A $cP4$ - $cF4$ order-disorder transformation in this phase has been suggested.

(b) Cubic structure presumed to be room- and high-temperature phases.

(c) Tetragonal structure presumed to be low-temperature phase

Ce-Zn (Cerium - Zinc)

H. Okamoto, 1990

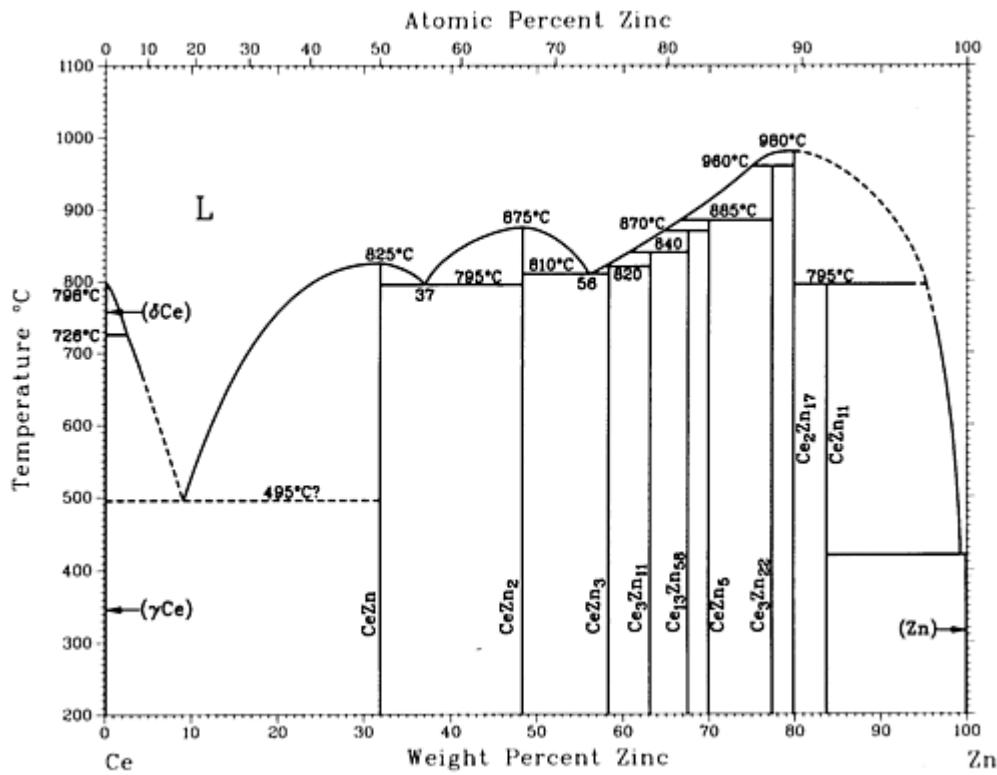

Ce-Zn phase diagram

Ce-Zn crystallographic data

Phase	Composition, wt% Zn	Pearson symbol	Space group
(δCe)	0	<i>cI2</i>	<i>Im</i> $\bar{3}m$
(γCe)	0	<i>cF4</i>	<i>Fm</i> $\bar{3}m$
(βCe)	0	<i>hP4</i>	<i>P6</i> ₃ / <i>mmc</i>
(αCe)	0	<i>cF4</i>	<i>Fm</i> $\bar{3}m$
CeZn	31.8	<i>cP2</i>	<i>Pm</i> $\bar{3}m$
CeZn₂	48.3	<i>oI12</i>	<i>Imma</i>
CeZn₃	58	<i>oC16</i>	<i>Cmcm</i>

$\text{Ce}_3\text{Zn}_{11}$	63.2	<i>oI28</i>	<i>Immm</i>
$\text{Ce}_{13}\text{Zn}_{58}$	67.6	<i>hP142</i>	<i>P6_3mc</i>
CeZn_5	70.0	<i>hP6</i>	<i>P6/mmm</i>
$\text{Ce}_3\text{Zn}_{22}$	77	<i>tI100</i>	<i>I4_1/amd</i>
$\text{Ce}_2\text{Zn}_{17}$	79.9	<i>hR19</i>	$R\bar{3}m$
CeZn_{11}	83.8	<i>tI48</i>	<i>I4_1/amd</i>
(Zn)	100	<i>hP2</i>	<i>P6_3/mmc</i>

Cl (Chlorine) Binary Alloy Phase Diagrams

Introduction

THIS ARTICLE includes systems where chlorine is the first-named element in the binary pair.

Cl-Cs (Chlorine - Cesium)

H. Okamoto, 1990

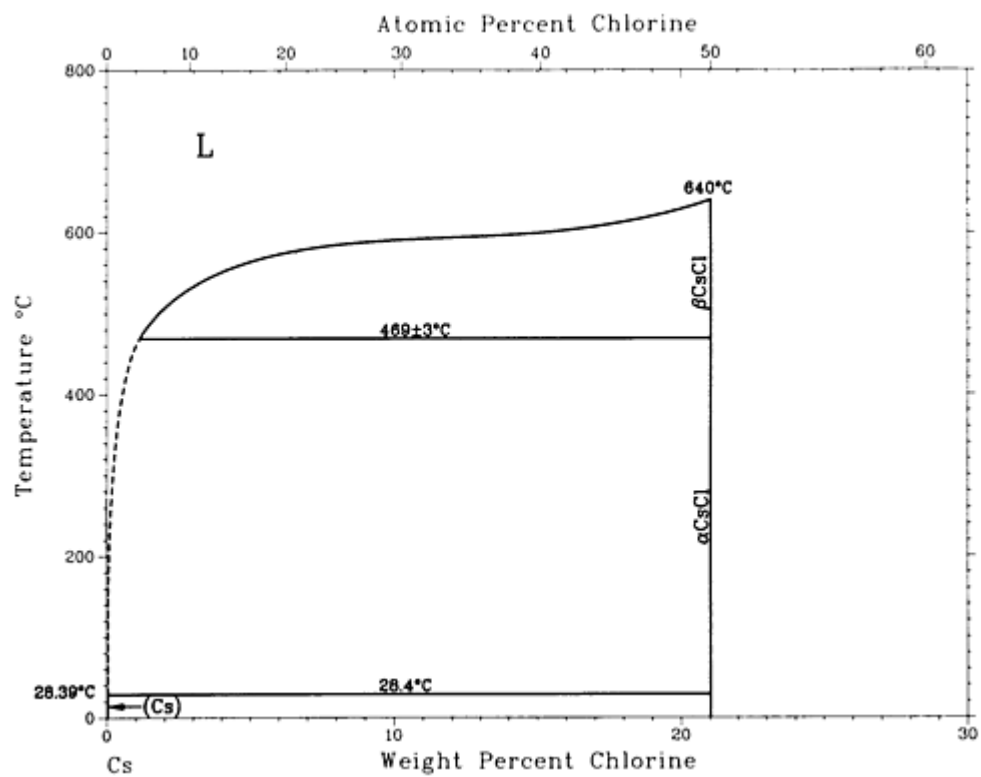

Cl-Cs phase diagram

Cl-Cs crystallographic data

Phase	Composition, wt% Cl	Pearson symbol	Space group
(Cs)	0	<i>cI2</i>	$Im\bar{3}m$
β -CsCl	21.1	<i>cF8</i>	$Fm\bar{3}m$
α -CsCl	21.1	<i>cP2</i>	$Pm\bar{3}m$
(Cl)	100	<i>oC8</i>	<i>Cmca</i>

Cl-Ga (Chlorine - Gallium)

H. Okamoto, 1990

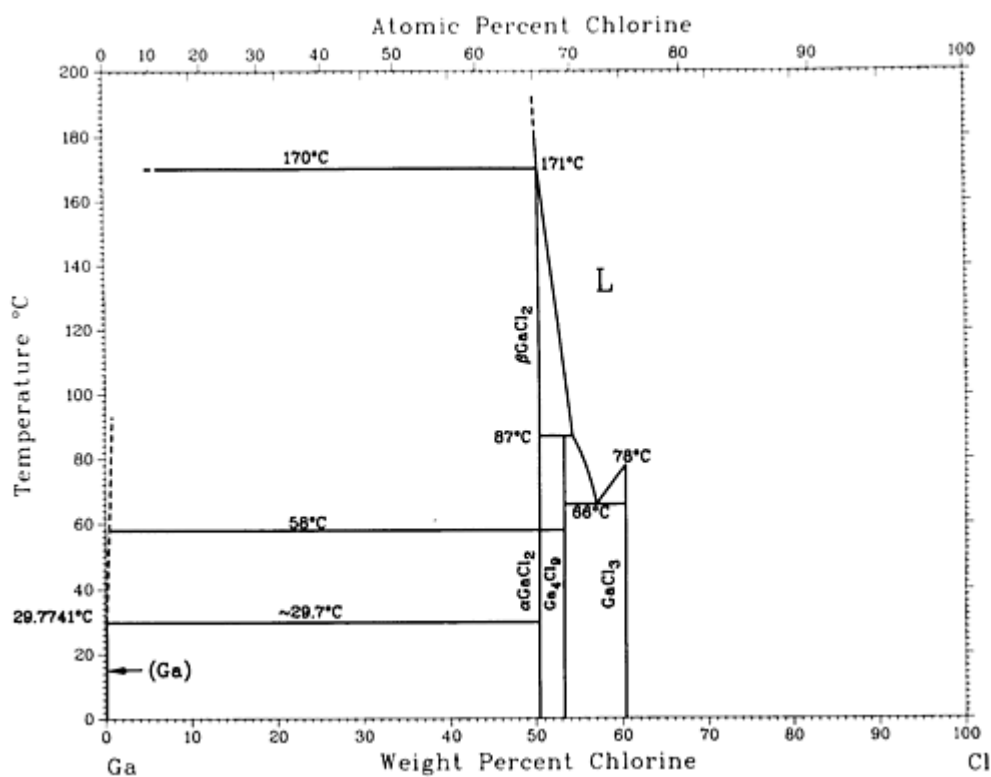

Cl-Ga phase diagram

Cl-Ga crystallographic data

Phase	Composition, wt% Cl	Pearson symbol	Space group
(Ga)	0	<i>oC8</i>	<i>Cmca</i>
β GaCl ₂	50.5	<i>tP24</i>	<i>Pnma</i>
α GaCl ₂	50.5
Ga ₄ Cl ₉	53.3
GaCl ₃	60	<i>aP8</i>	$P\bar{1}$
(Cl)	100	<i>oC8</i>	<i>Cmca</i>

Cl-Hg (Chlorine - Mercury)

H. Okamoto, 1990

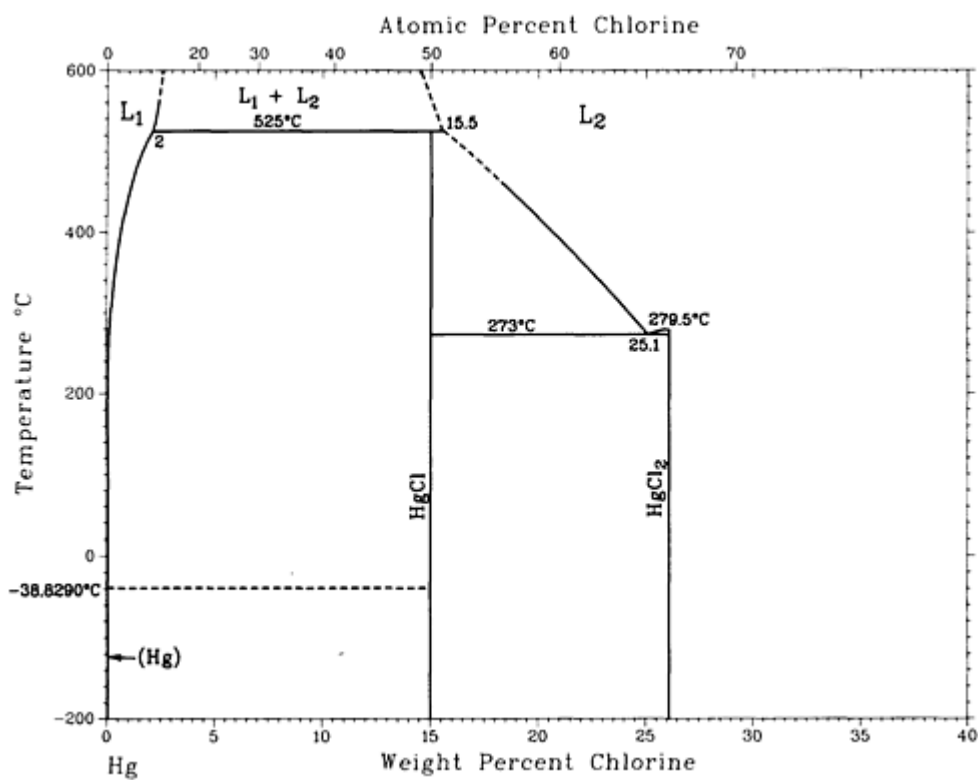

Cl-Hg phase diagram

Cl-Hg crystallographic data

Phase	Composition, wt% Cl	Pearson symbol	Space group
(α Hg)	0	<i>hR1</i>	$R\bar{3}m$
HgCl	15.0	<i>tI8</i>	<i>I4/mmm</i>
HgCl ₂	26.1	<i>oP12</i>	<i>Pmnb</i>
(Cl)	100	<i>oC8</i>	<i>Cmca</i>

Cl-In (Chlorine - Indium)

H. Okamoto, 1992

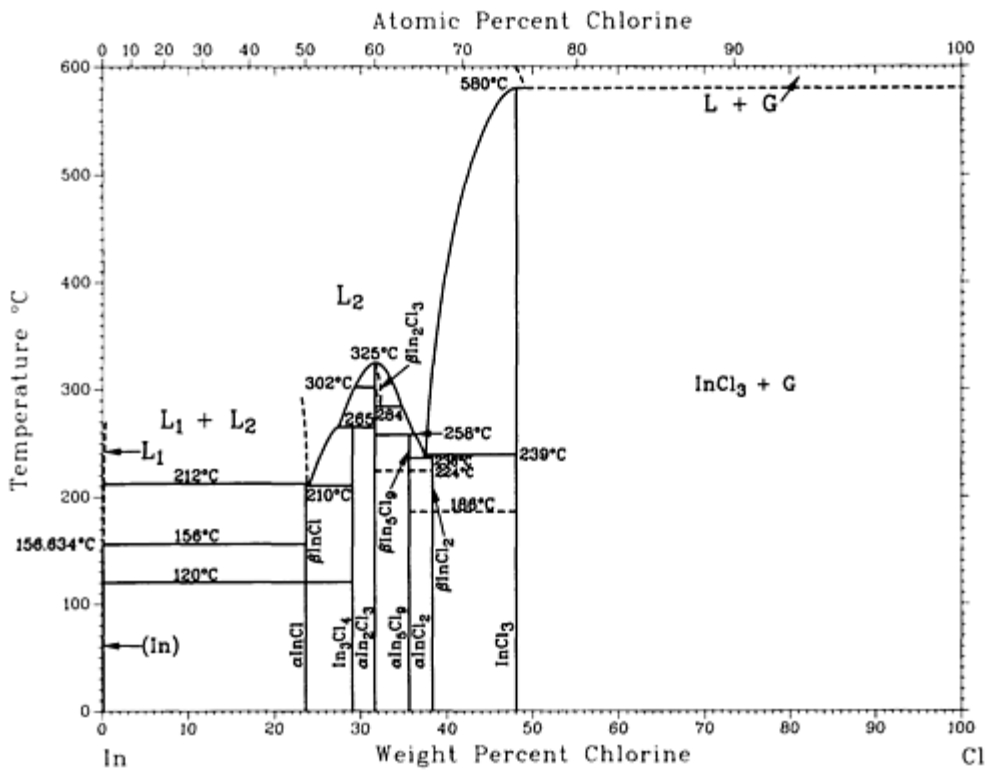

Cl-In phase diagram

Cl-In crystallographic data

Phase	Composition, wt% Cl	Pearson symbol	Space group
(In)	0	<i>tI2</i>	<i>I4/mmm</i>

β InCl	23.6	<i>oC8</i>	<i>Cmcm</i>
α InCl	23.6	<i>cP64</i>	<i>P2₁3</i>
In ₃ Cl ₄	29.1
In ₂ Cl ₃ (I)	32	<i>o*30</i>	...
In ₂ Cl ₃ (II)	32	<i>t*45</i>	...
In ₂ Cl ₃ (III)	32	<i>hP*</i>	...
β In ₅ Cl ₉ ^(a)	35.7
α In ₅ Cl ₉ ^(a)	35.7
β InCl ₂	38.2	<i>oP24</i>	<i>Pnna</i>
α InCl ₂	38.2	<i>m**</i>	...
InCl ₃	48	<i>mC16</i>	<i>C2/m</i>
(Cl)	100	<i>oC8</i>	<i>Cmca</i>

(a) Or In₄Cl₇

Cl-Na (Chlorine - Sodium)

H. Okamoto, 1990

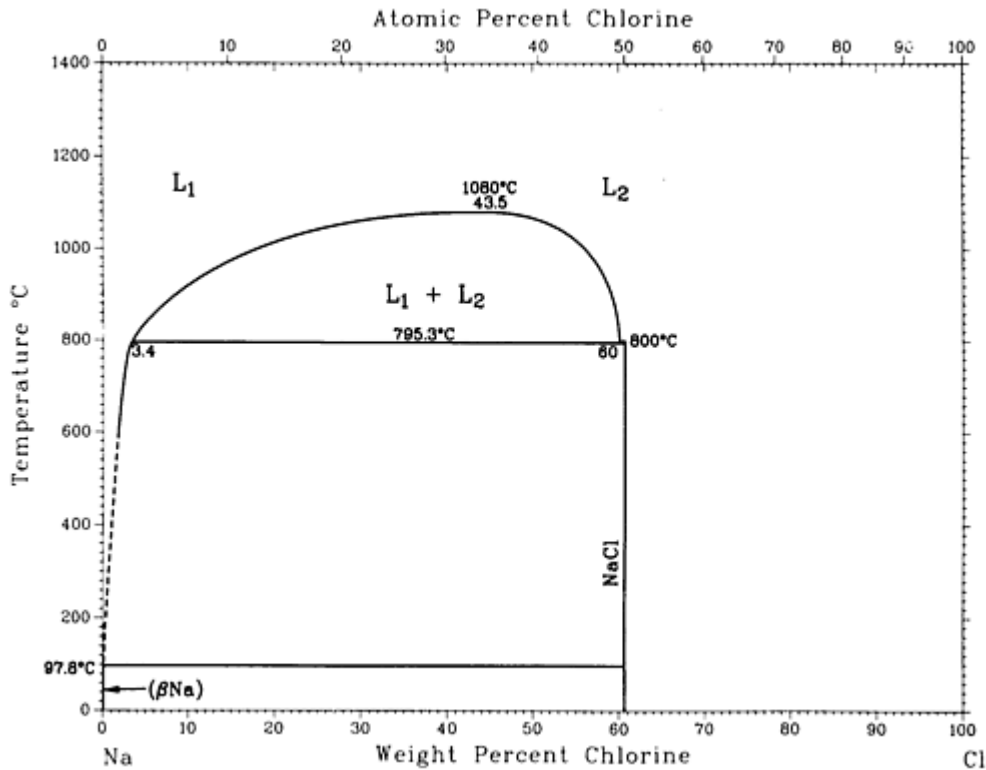

Cl-Na phase diagram

Cl-Na crystallographic data

Phase	Composition, wt% Cl	Pearson symbol	Space group
(Na)	0	<i>cI2</i>	$Im\bar{3}m$
NaCl	60.7	<i>cF8</i>	$Fm\bar{3}m$
(Cl)	100	<i>oC8</i>	<i>Cmca</i>

Co (Cobalt) Binary Alloy Phase Diagrams

Introduction

THIS ARTICLE includes systems where cobalt is the first-named element in the binary pair. Additional binary systems that include cobalt are provided in the following locations in this Volume:

- “Ag-Co (Silver - Cobalt)” in the article “Ag (Silver) Binary Alloy Phase Diagrams.”
- “Al-Co (Aluminum - Cobalt)” in the article “Al (Aluminum) Binary Alloy Phase Diagrams.”

- “As-Co (Arsenic - Cobalt)” in the article “As (Arsenic) Binary Alloy Phase Diagrams.”
- “Au-Co (Gold - Cobalt)” in the article “Au (Gold) Binary Alloy Phase Diagrams.”
- “B-Co (Boron - Cobalt)” in the article “B (Boron) Binary Alloy Phase Diagrams.”
- “Be-Co (Beryllium - Cobalt)” in the article “Be (Beryllium) Binary Alloy Phase Diagrams.”
- “C-Co (Carbon - Cobalt)” in the article “C (Carbon) Binary Alloy Phase Diagrams.”
- “Ce-Co (Cerium - Cobalt)” in the article “Ce (Cerium) Binary Alloy Phase Diagrams.”

Co-Cr (Cobalt - Chromium)

K. Ishida and T. Nishizawa, 1990

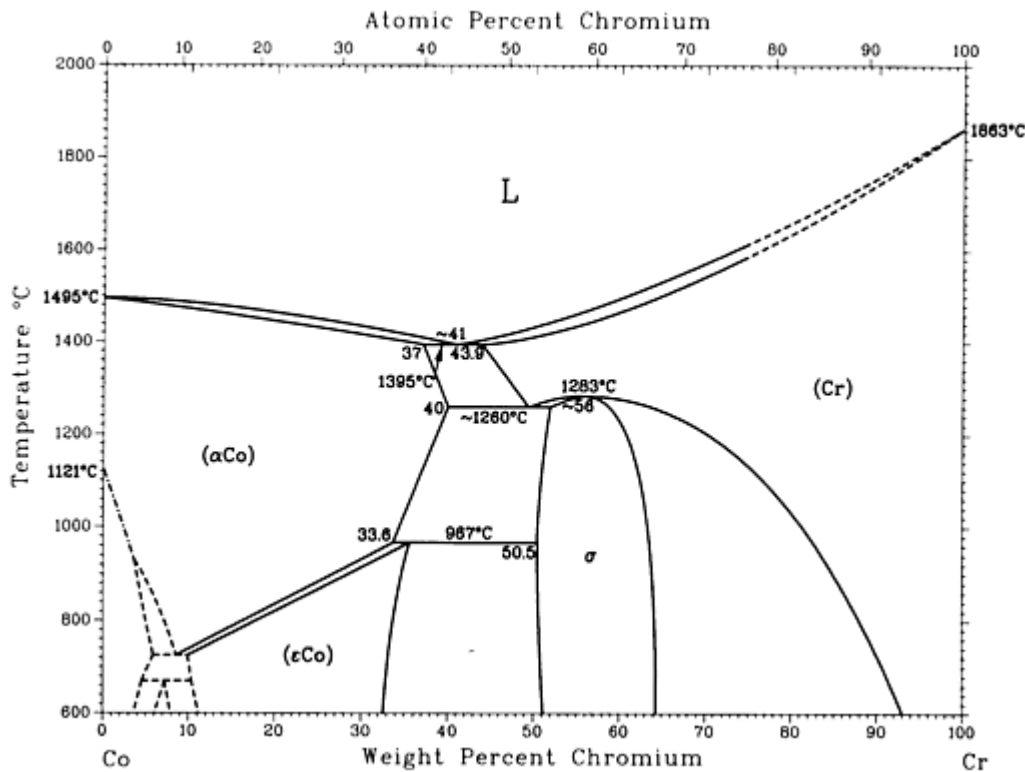

Co-Cr phase diagram

Co-Cr crystallographic data

Phase	Composition, wt% Cr	Pearson symbol	Space group
(αCo)	0 to 40	<i>cF4</i>	<i>Fm</i> $\bar{3}m$
(εCo)	0 to 36	<i>hP2</i>	<i>P6</i> ₃ / <i>mmc</i>
(αCr)	43.9 to 100	<i>cI2</i>	<i>Im</i> $\bar{3}m$
σ	50.5 to 63	<i>tP30</i>	<i>P4</i> ₂ / <i>mmm</i>

Metastable phases			
(α Cr)	~ 16	<i>cI2</i>	$Im\bar{3}m$
(α Co)	40 to 62.9	<i>cF4</i>	$Fm\bar{3}m$
(δ Cr)	54 to 100	<i>cP8</i>	$Pm\bar{3}n$
Co ₃ Cr?	23	<i>hP8</i>	$P6_3/mmc$

Co-Cu (Cobalt - Copper)

T. Nishizawa and K. Ishida, 1984

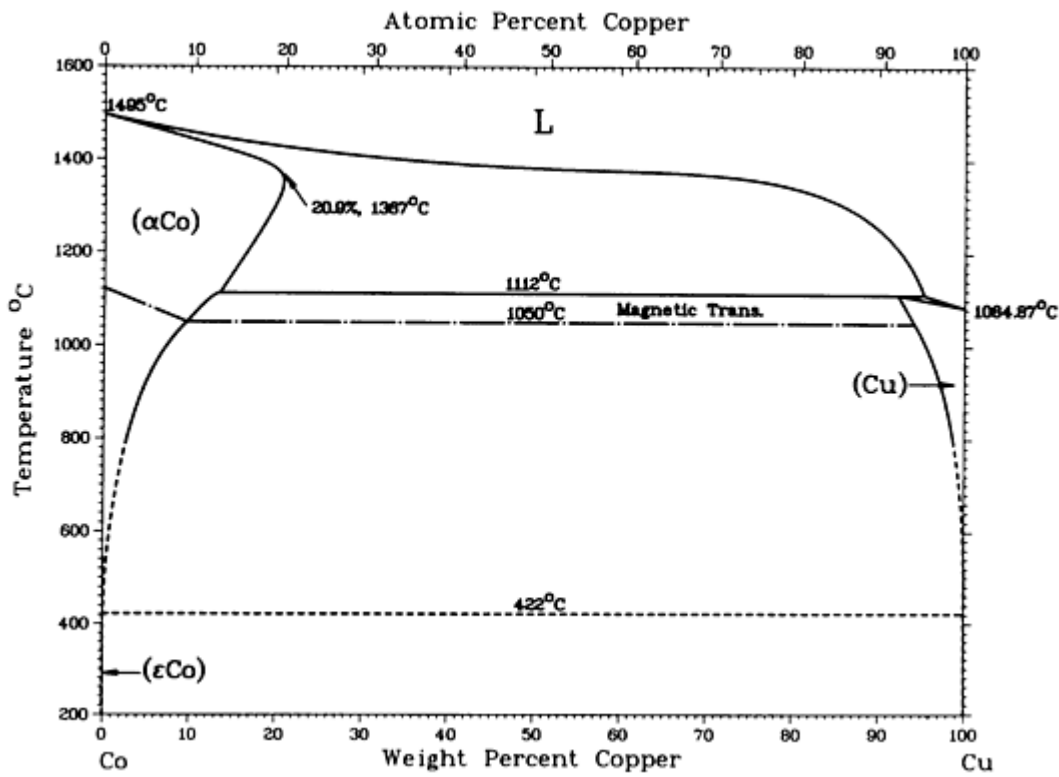

Co-Cu phase diagram

Co-Cu crystallographic data

Phase	Composition, wt% Cu	Pearson symbol	Space group
(α Co)	0 to 20.9	<i>cF4</i>	$Fm\bar{3}m$

(ϵ Co)	0 to 9 ^(a)	<i>hp2</i>	$P6_3/mmc$
(Cu)	93 to 100	<i>cF4</i>	$Fm\bar{3}m$
Metastable phase			
ϵ'	9 to 10	<i>hR1</i>	$R\bar{3}m$

(a) The composition of (ϵ Co) is between 0 and 0.3 wt% Cu in equilibrium, but is 0 to 9 wt% Cu in the metastable state, which is obtained by quenching from high temperatures.

Co-Dy (Cobalt - Dysprosium)

H. Okamoto, 1990

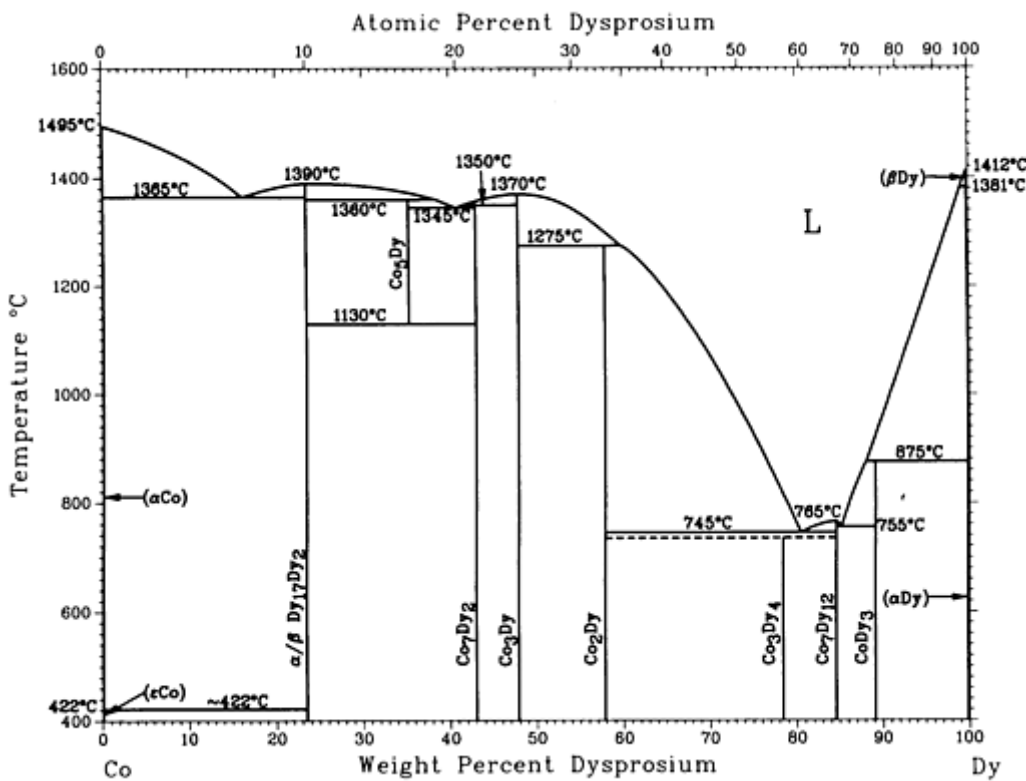

Co-Dy phase diagram

Co-Dy crystallographic data

Phase	Composition, wt% Dy	Pearson symbol	Space group

(αCo)	~ 0	$cF4$	$Fm\bar{3}m$
(ϵCo)	~ 0	$hP2$	$P6_3/mmc$
$\beta\text{Co}_{17}\text{Dy}_2$	24.4	$hP38$	$P6_3/mmc$
$\alpha\text{Co}_{17}\text{Dy}_2$	24.4	$hR19$	$R\bar{3}m$
Co_5Dy	35.6	$hP6$	$P6/mmm$
Co_7Dy_2	44.0	$hR18$	$R\bar{3}m$
Co_3Dy	48	$hR12$	$R\bar{3}m$
Co_2Dy	57.9	$cF24$	$Fd\bar{3}m$
Co_3Dy_4	78.6	$hP22$	$P6_3/m$
$\text{Co}_7\text{Dy}_{12}$	82.6	$mP38$	$P2_1/c$
CoDy_3	89	$oP16$	$Pnma$
(βDy)	~ 100	$cI2$	$Im\bar{3}m$
(αDy)	~ 100	$hP2$	$P6_3/mmc$

Co-Er (Cobalt - Erbium)

H. Okamoto, 1990

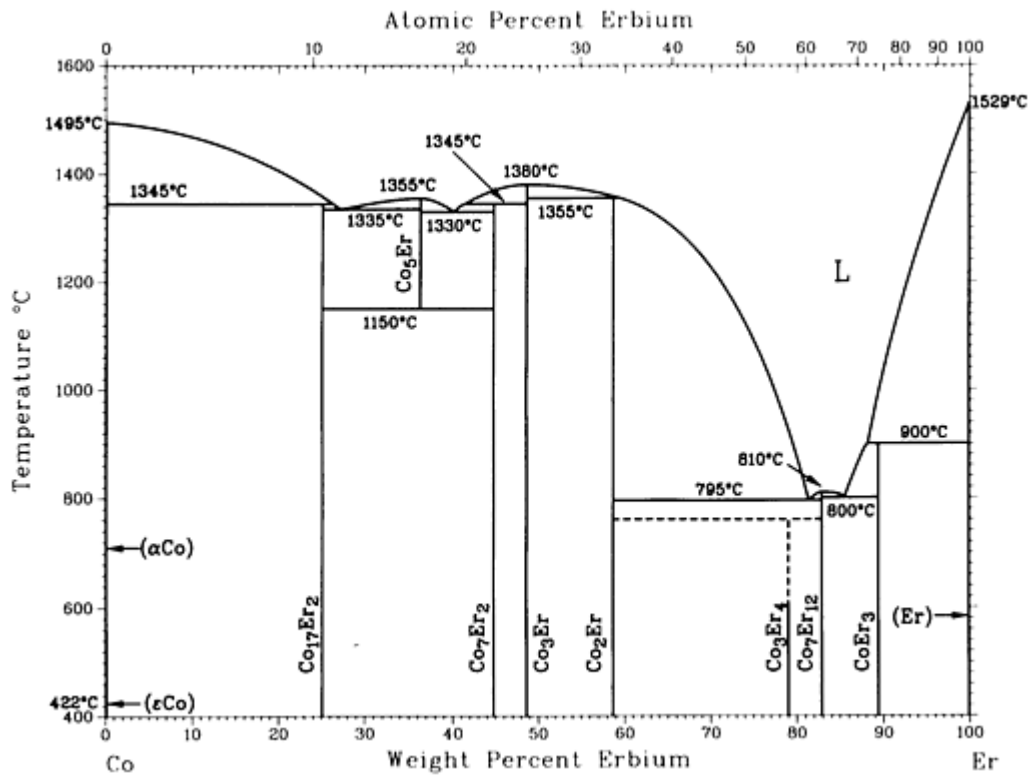

Co-Er phase diagram

Co-Er crystallographic data

Phase	Composition, wt% Er	Pearson symbol	Space group
(αCo)	~ 0	$cF4$	$Fm\bar{3}m$
$\text{Co}_{17}\text{Er}_2$	25.0	$hP38$	$P6_3/mmc$
Co_5Er	36.3	$hP6$	$P6/mmm$
Co_7Er_2	44.7	$hR18$	$R\bar{3}m$
Co_3Er	49	$hR12$	$R\bar{3}m$
Co_2Er	58.6	$cF24$	$Fd\bar{3}m$
Co_3Er_4	79.1	$hP22$	$P6_3/m$

$\text{Co}_7\text{Er}_{12}$	83.0	<i>mP38</i>	$P2_1/c$
CoEr_3	99.5	<i>oP16</i>	$Pnma$
(Er)	~100	<i>hP2</i>	$P6_3/mmc$

Co-Fe (Cobalt - Iron)

T. Nishizawa and K. Ishida, 1984

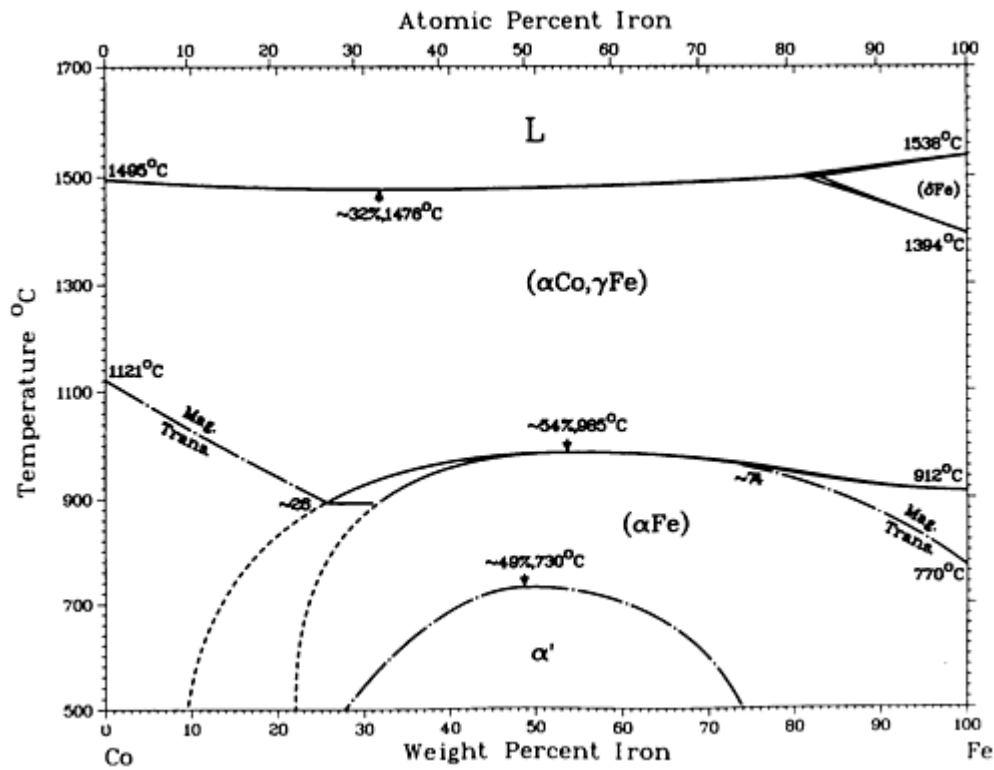

Co-Fe phase diagram

Co-Fe crystallographic data

Phase	Composition, wt% Fe	Pearson symbol	Space group
(αCo, γFe)	0 to 100	<i>cF4</i>	$Fm\bar{3}m$
α'	~28 to ~74	<i>cP2</i>	$Pm\bar{3}m$
(αFe)	~22 to 100	<i>cI2</i>	$Im\bar{3}m$

(δFe)	82 to 100	$cI2$	$Im\bar{3}m$
Metastable phase			
η	0.5 to 5.7	$hP4$	$P6_3/mmc$

Co-Ga (Cobalt - Gallium)

H. Okamoto, 1990

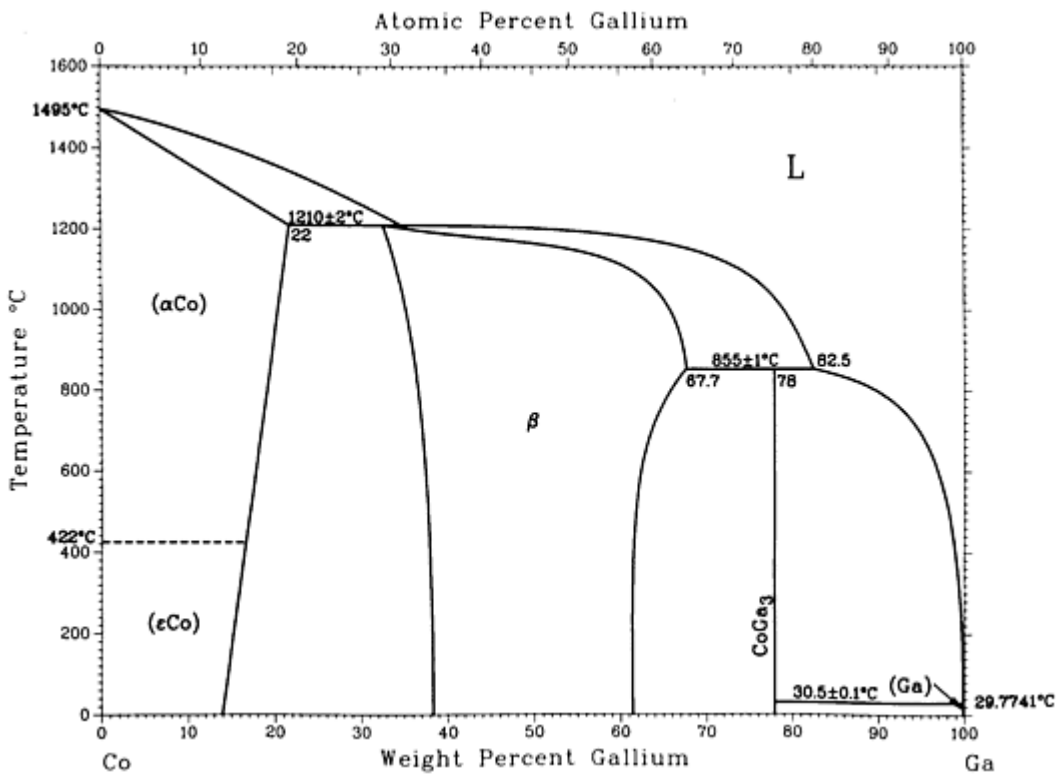

Co-Ga phase diagram

Co-Ga crystallographic data

Phase	Composition, wt% Ga	Pearson symbol	Space group
(αCo)	0 to 22	$cF4$	$Fm\bar{3}m$
(εCo)	0 to 17	$hP2$	$P6_3/mmc$
β	33 to 67.7	$cP2$	$Pm\bar{3}m$

CoGa₃	78	<i>tP</i> 16	$P\bar{4}_1n2$
(Ga)	100	<i>oC</i> 8	<i>Cmca</i>

Co-Gd (Cobalt - Gadolinium)

H. Okamoto, 1990

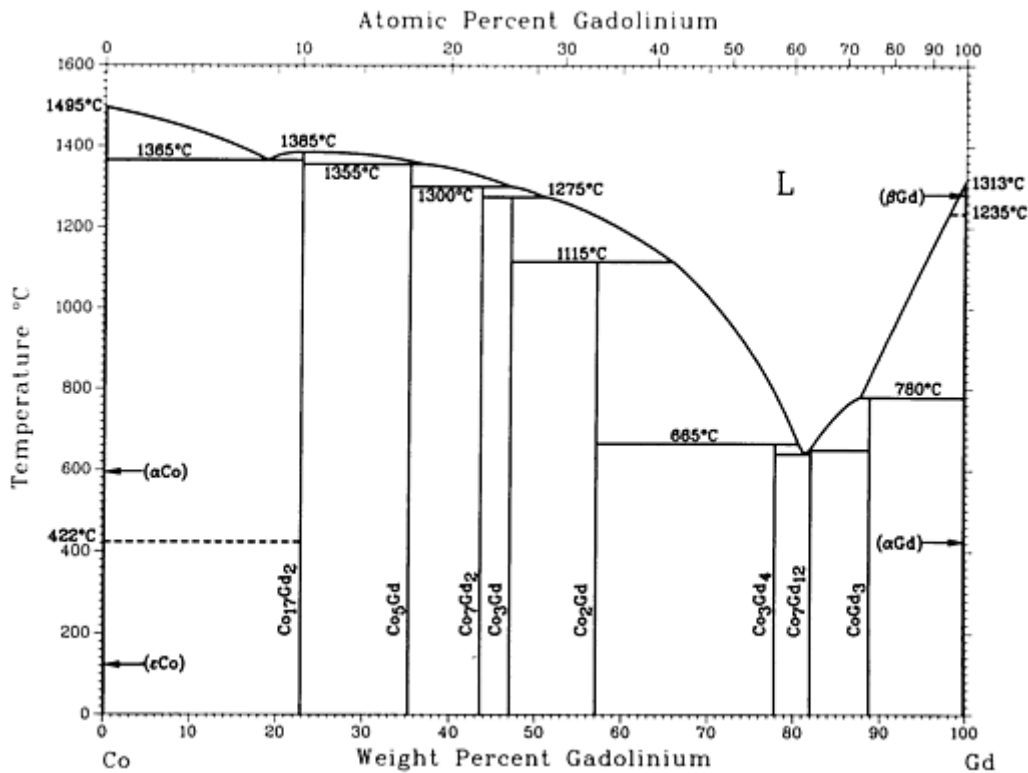

Co-Gd phase diagram

Co-Gd crystallographic data

Phase	Composition, wt% Gd	Pearson symbol	Space group
(α Co)	~0	<i>cF</i> 4	$Fm\bar{3}m$
(ϵ Co)	~0	<i>hP</i> 2	$P6_3/mmc$
Co₁₇Gd₂	~23.8	<i>hP</i> 38 <i>hR</i> 19	$P6_3/mmc$ $R\bar{3}m$
Co₅Gd	~34.9	<i>hP</i> 6	$P6/mmm$

Co₇Gd₂	~43.2	<i>hR18</i> <i>hP36</i>	$R\bar{3}m$ <i>P6₃/mmc</i>
Co₃Gd	47	<i>hR12</i>	$R\bar{3}m$
Co₂Gd	57.1	<i>cF24</i>	<i>Fd</i> $\bar{3}m$
Co₃Gd₄	78.0	<i>hP22</i>	<i>P6₃/m</i>
Co₇Gd₁₂	~82.1	<i>mP38</i>	<i>P2₁/c</i>
CoGd₃	89	<i>oP16</i>	<i>Pnma</i>
(βGd)	~100	<i>cI2</i>	<i>Im</i> $\bar{3}m$
(αGd)	100	<i>hP2</i>	<i>P6₃/mmc</i>
Other reported phases			
Co₈Gd	~25.0	<i>hP8</i>	<i>P6/mmm</i>
CoGd	72.7	<i>oP8</i>	<i>Pnma</i>
Co₃Gd₇	86	<i>o*</i>	...
CoGd₉	96	<i>o*</i>	...

Co-Ge (Cobalt - Germanium)

K. Ishida and T. Nishizawa, 1991

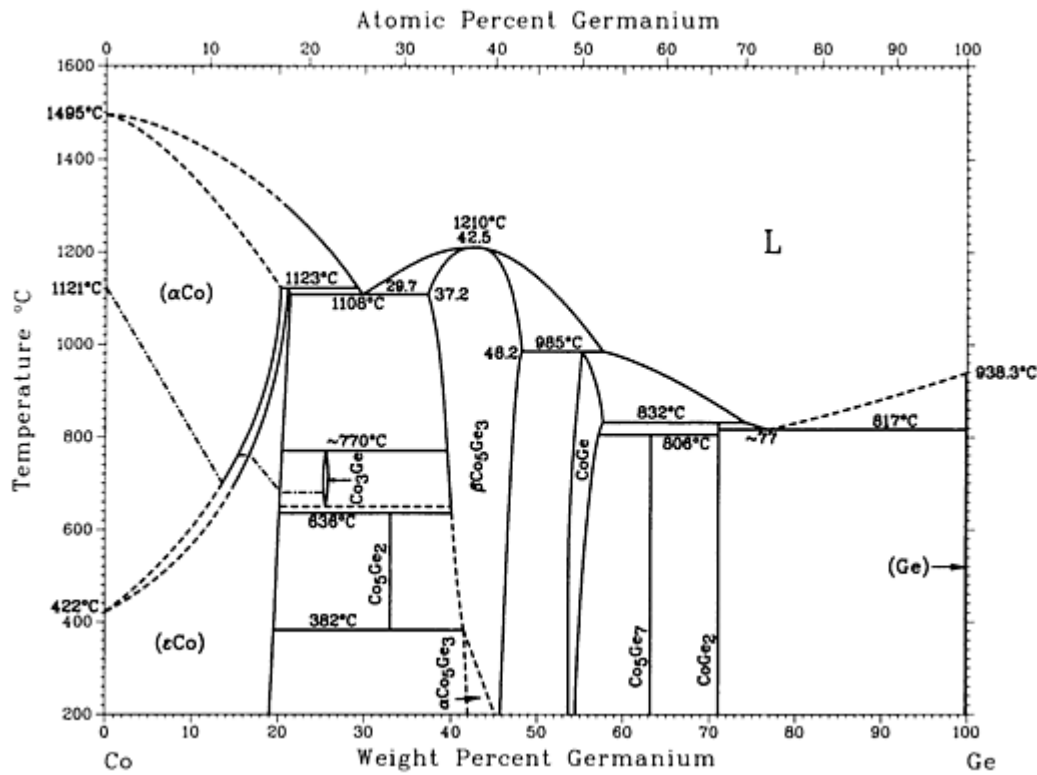

Co-Ge phase diagram

Co-Ge crystallographic data

Phase	Composition, wt% Ge	Pearson symbol	Space group
(αCo)	0 to 20.7	<i>cF4</i>	<i>Fm</i> $\bar{3}m$
(εCo)	0 to 21	<i>hP2</i>	<i>P6</i> ₃ / <i>mmc</i>
Co ₃ Ge	25.2 to 26	<i>cP8</i>	<i>Pm</i> $\bar{3}n$?
Co ₅ Ge ₂	33.0
αCo ₅ Ge ₃	~41.5 to ~45	...	<i>Pbnm</i> ?
βCo ₅ Ge ₃	37.2 to 48.2	<i>hP6</i>	<i>P6</i> ₃ / <i>mmc</i>
CoGe	53.7 to 57.7	<i>mC16</i>	<i>C2/m</i>

		<i>cP8</i>	<i>P2₁3</i>
Co₅Ge₇	63.3	<i>tI24</i>	<i>I4mm</i>
CoGe₂	71.2	<i>oC24</i>	<i>Aba2</i>
(Ge)	~100	<i>cF8</i>	<i>Fd3̄m</i>

Co-Hf (Cobalt - Hafnium)

K. Ishida and T. Nishizawa, 1991

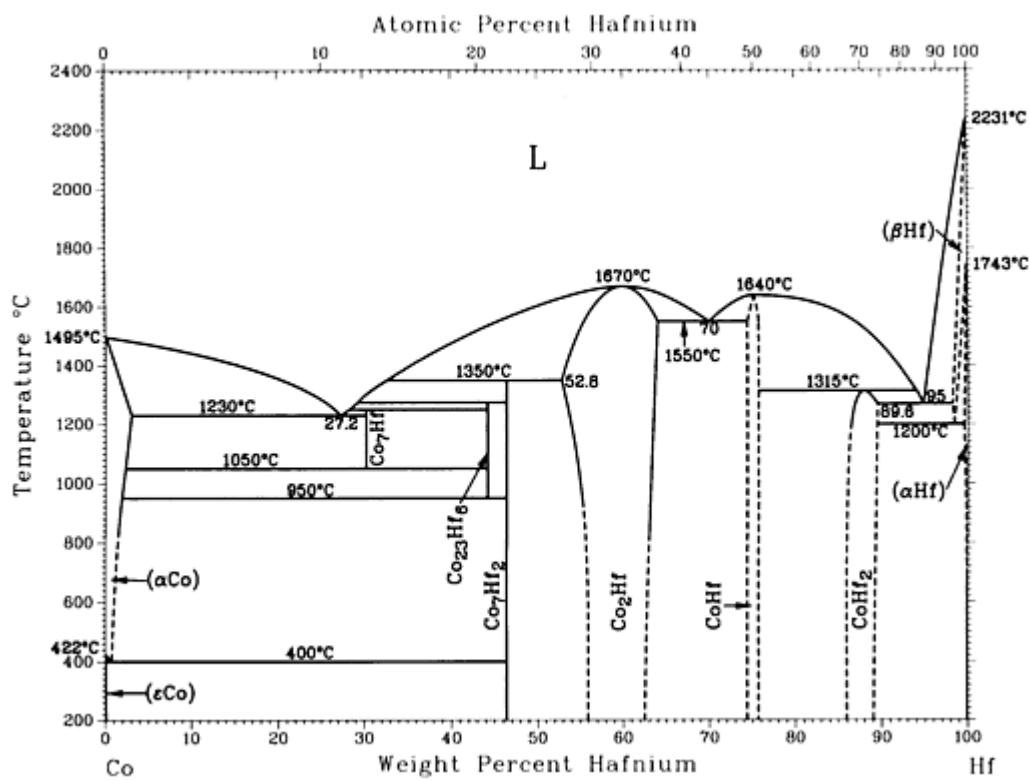

Co-Hf phase diagram

Co-Hf crystallographic data

Phase	Composition, wt% Hf	Pearson symbol	Space group
(αCo)	0 to ~6	<i>cF4</i>	<i>Fm3̄m</i>
(εCo)	0 to ~1.5	<i>hP2</i>	<i>P6₃/mmc</i>

Co_7Hf	30.2	<i>tP32</i>	...
$\text{Co}_{23}\text{Hf}_6$	44.2	<i>cF116</i>	$Fm\bar{3}m$
Co_7Hf_2	46.4	<i>o^{**}</i>	...
Co_2Hf	52.8 to ~ 63	<i>cF24</i>	$Fd\bar{3}m$
CoHf	~ 74 to ~ 76	<i>cP2</i>	$Pm\bar{3}m$
CoHf_2	~ 86 to 89.6	<i>cF112</i>	$Fd3m$
(βHf)	~ 98 to 100	<i>cI2</i>	$Im\bar{3}m$
(αHf)	~ 99 to 100	<i>hP2</i>	$P6_3/mmc$

Co-Ho (Cobalt - Holmium)

H. Okamoto, 1990

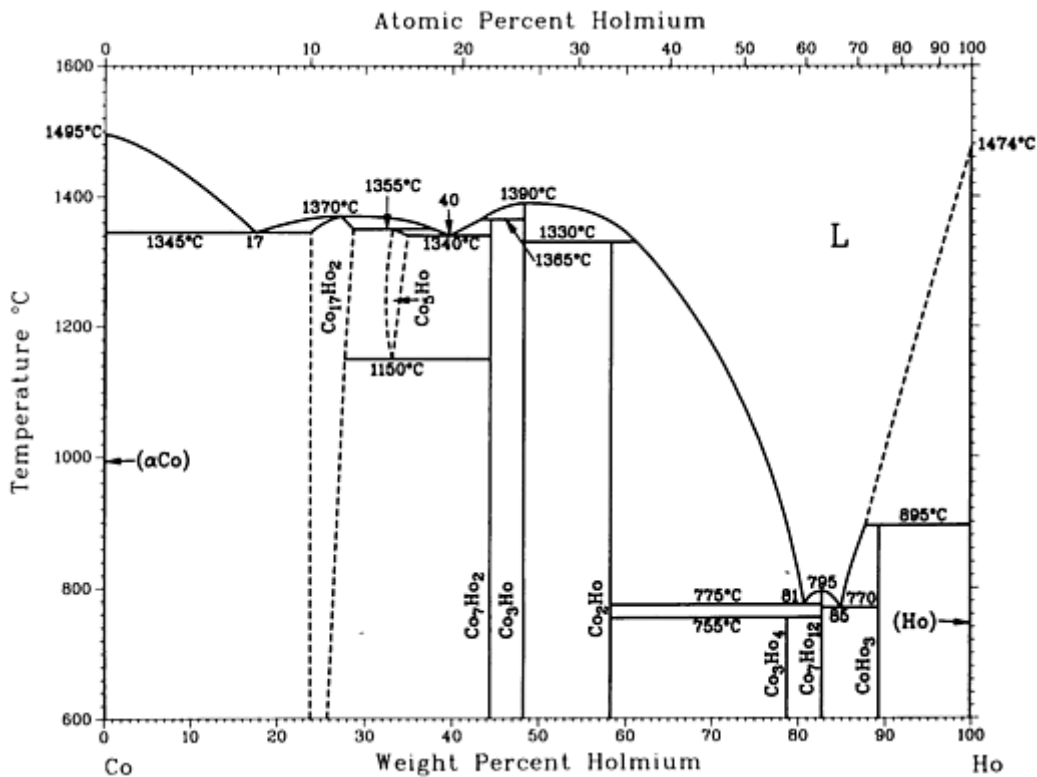

Co-Ho phase diagram

Co-Ho crystallographic data

Phase	Composition, wt% Ho	Pearson symbol	Space group
(α Co)	~ 0	<i>cF4</i>	<i>Fm$\bar{3}m$</i>
(ϵ Co)	~ 0	<i>hP2</i>	<i>P6₃/mmc</i>
Co₁₇Ho₂	24.7	<i>hR19</i> <i>hP38</i> <i>hP52</i>	<i>R$\bar{3}m$</i> <i>P6₃/mmc</i> <i>P6₃/mmc</i>
Co₅Ho	35.9	<i>hP6</i>	<i>P6/mmm</i>
Co₇Ho₂	44.4	<i>hR18</i>	<i>R$\bar{3}m$</i>
Co₃Ho	48	<i>hR12</i>	<i>R$\bar{3}m$</i>
Co₂Ho	58.3	<i>cF24</i>	<i>Fd$\bar{3}m$</i>
Co₃Ho₄	78.8	<i>hP22</i>	<i>P6₃/m</i>
Co₇Ho₁₂	82.8	<i>mP38</i>	<i>P2₁/c</i>
CoHo₃	89	<i>oP16</i>	<i>Pnma</i>
(Ho)	~ 100	<i>hP2</i>	<i>P6₃/mmc</i>

Co-Mn (Cobalt - Manganese)

K. Ishida and T. Nishizawa, 1990

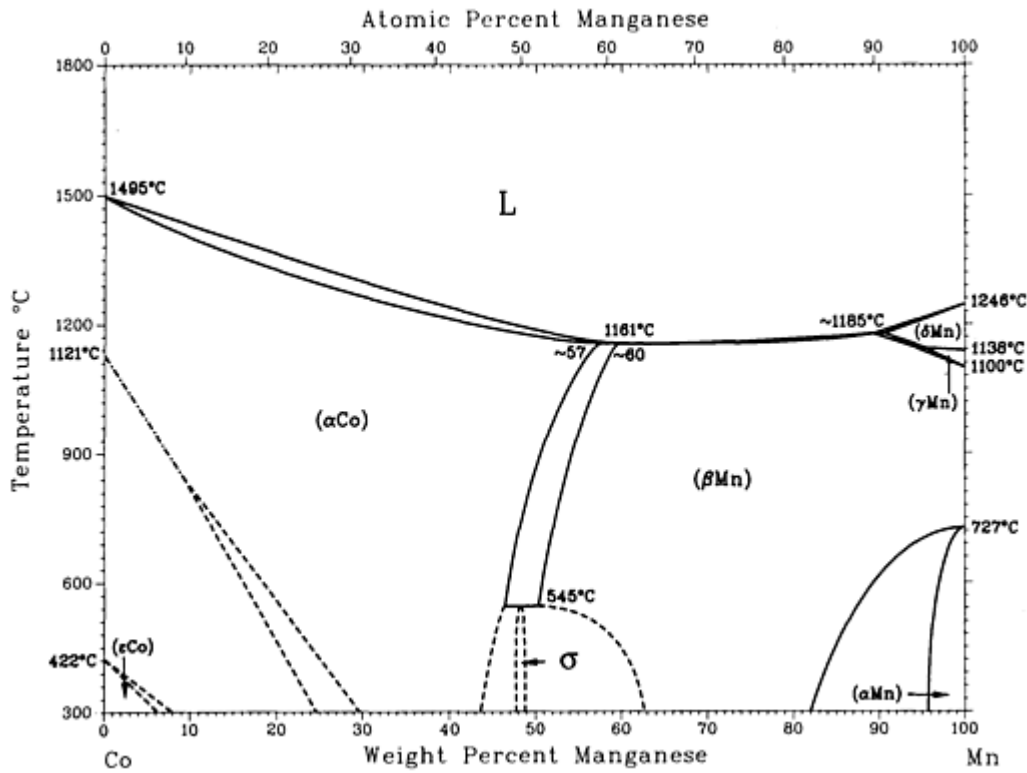

Co-Mn phase diagram

Co-Mn crystallographic data

Phase	Composition, wt% Mn	Pearson symbol	Space group
(εCo)	0 to ~19	<i>hP2</i>	<i>P6₃/mmc</i>
(αCo)	0 to ~57	<i>cF4</i>	<i>Fm$\bar{3}$m</i>
σ	~48	<i>tP30</i>	<i>P4₂/mnm</i>
(αMn)	97 to 100	<i>cI58</i>	<i>I$\bar{4}$₃m</i>
(βMn)	49 to 100	<i>cP20</i>	<i>P4₁32</i>
(γMn)	95 to 100	<i>cF4</i>	<i>Fm$\bar{3}$m</i>
(δMn)	90 to 100	<i>cI2</i>	<i>Im$\bar{3}$m</i>

$(\gamma, \text{Mn})^{(a)}$ 90 to 100 $tI2$ $I4/mmm$

(a) Splat quenched from the liquid state or rapid quenched from the high-temperature solid field

Co-Mo (Cobalt - Molybdenum)

From [Molybdenum] 12

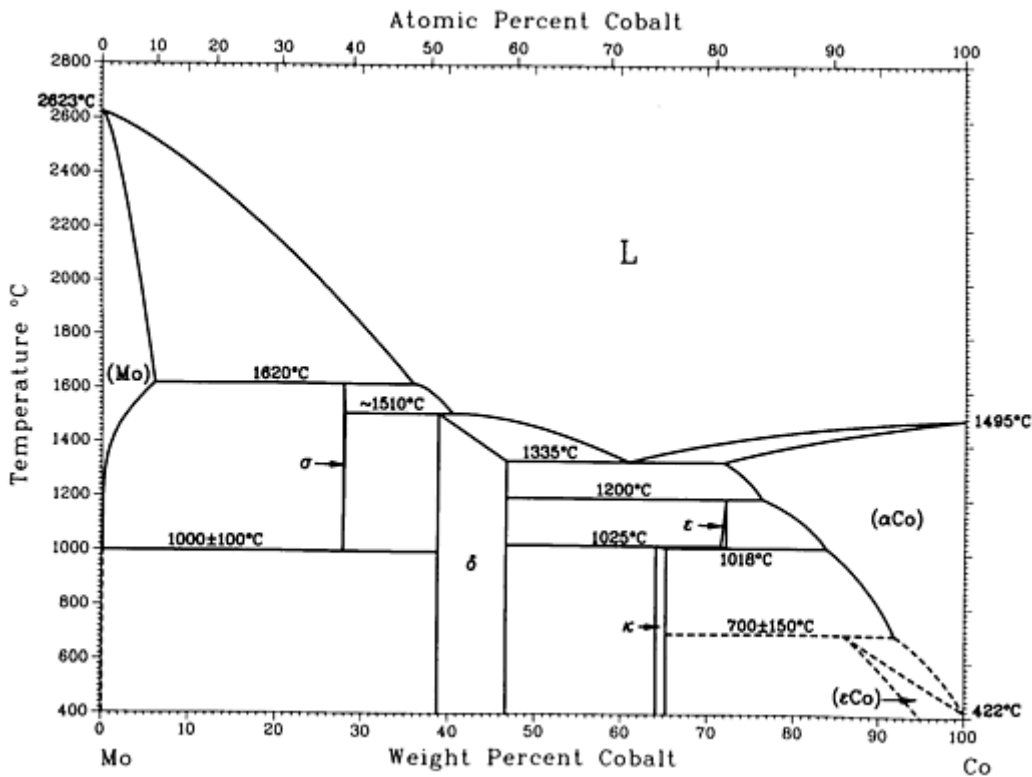

Co-Mo phase diagram

Co-Mo crystallographic data

Phase	Composition, wt% Co	Pearson symbol	Space group
(Mo)	0 to ~6	$cI2$	$Im\bar{3}m$
σ	~27.8 to 28	$tP30$	$P4_2/mmm$
ϵ	~38.8 to ~46.7	$hR13$	$R\bar{3}m$

κ	~61.2 to ~65.4	<i>hP8</i>	<i>P6₃/mmc</i>
<i>cph</i>	~72	<i>hP2</i>	<i>P6₃/mmc</i>
(α Co)	~72 to 100	<i>cF4</i>	<i>Fm$\bar{3}m$</i>
(ϵ Co)	~86 to 100	<i>hP2</i>	<i>P6₃/mmc</i>

Reference cited in this section

12. [**Molybdenum**]: L. Brewer, *Molybdenum: Physico-Chemical Properties of Its Compounds and Alloys*, O. Kubaschewski, Ed., Atomic Energy Review Special Issue No.7, International Atomic Energy Agency, Vienna (1980).

Co-Nb (Cobalt - Niobium)

J.K. Pargeter and W. Hume-Rothery, 1967

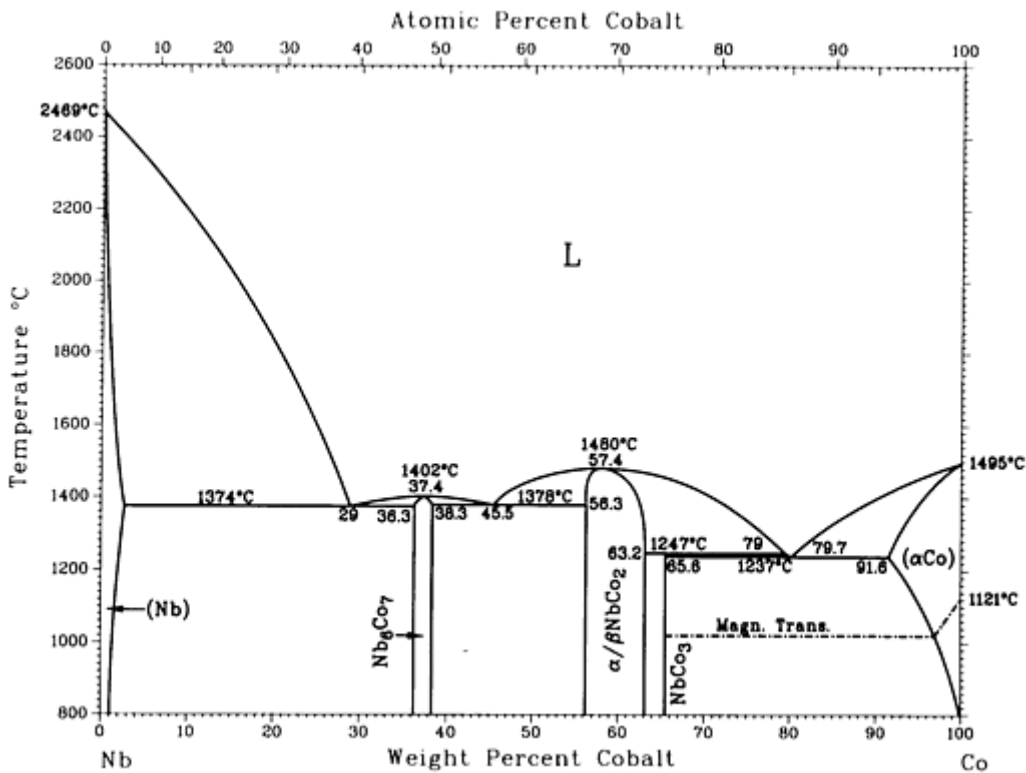

Co-Nb phase diagram

Co-Nb crystallographic data

Phase	Composition, wt% Co	Pearson symbol	Space group
-------	---------------------	----------------	-------------

(Nb)	0 to ~3	<i>cI2</i>	$Im\bar{3}m$
Nb ₆ Co ₇	36.3 to 38.3	<i>hR13</i>	$R\bar{3}m$
βNbCo ₂ ^(a)	56.3 to ?	<i>hP12</i>	$P6_3/mmc$
αNbCo ₂	56.3 to 63.2	<i>cF24</i>	$Fd\bar{3}m$
NbCo ₃	65.3	<i>hP24</i>	$P6_3/mmc$
(αCo)	91.6 to 100	<i>cF4</i>	$Fm\bar{3}m$

(a) βNbCo₂ is stable above ~1200 °C.

Co-Nd (Cobalt - Neodymium)

A.E. Ray, 1974

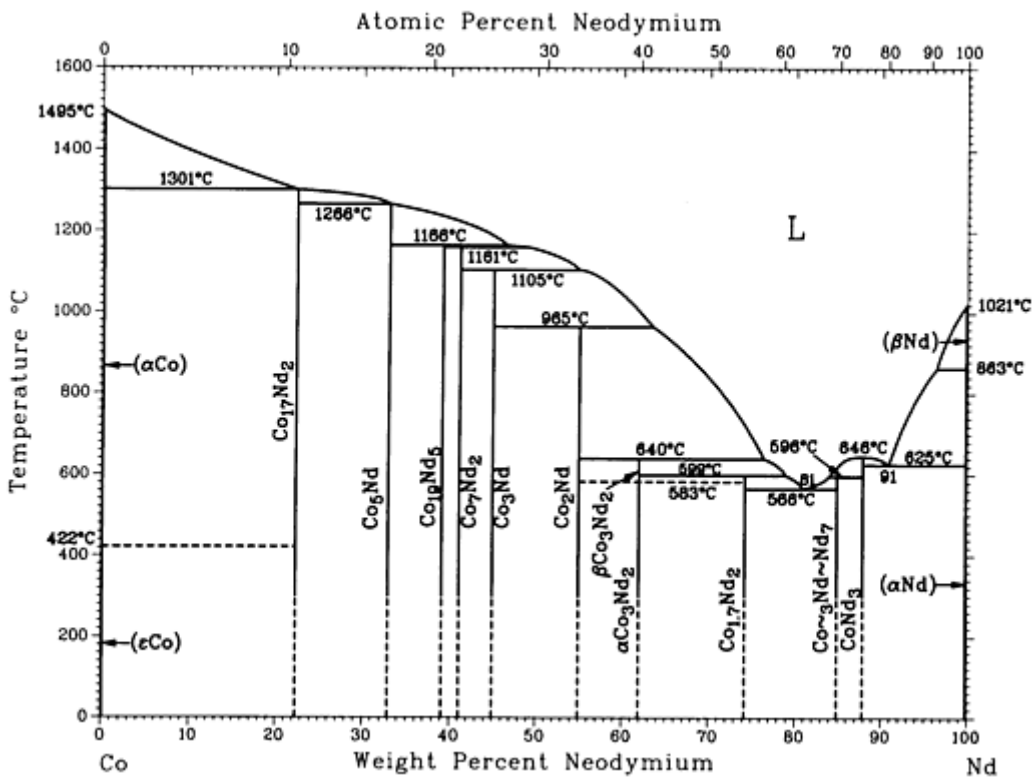

Co-Nd phase diagram

Co-Nd crystallographic data

Phase	Composition, wt% Nd	Pearson symbol	Space group
(α Co)	~ 0	<i>cF4</i>	<i>Fm</i> $\bar{3}m$
(ϵ Co)	~ 0	<i>hP2</i>	<i>P6₃/mmc</i>
Co ₁₇ Nd ₂	~ 22.3	<i>hR19</i>	<i>R</i> $\bar{3}m$
Co ₅ Nd	~ 32.9	<i>hP6</i>	<i>P6/mmm</i>
Co ₁₉ Nd ₅	~ 39.1	<i>hR24</i>	<i>R</i> $\bar{3}m$
β Co ₇ Nd ₂	~ 41.1	<i>hR18</i>	<i>R</i> $\bar{3}m$
α Co ₇ Nd ₂	~ 41.1	<i>hP36</i>	<i>P6₃/mmc</i>
Co ₃ Nd	45	<i>hR12</i>	<i>R</i> $\bar{3}m$
Co ₂ Nd	55.0	<i>cF24</i>	<i>Fd</i> $\bar{3}m$
Co ₃ Nd ₂	62	<i>o**</i>	...
Co ₁₇ Nd ₂	~ 74.3	<i>h**</i>	...
Co ~ 3 Nd ~ 7	~ 85	<i>hP20</i>	<i>P6₃mc</i>
CoNd ₃	88	<i>oP16</i>	<i>Pnma</i>
(β Nd)	~ 100	<i>cI2</i>	<i>Im</i> $\bar{3}m$
(α Nd)	~ 100	<i>hP4</i>	<i>P6₃/mmc</i>
Other reported phases			
Co ₃ Nd ₄	~ 76.5	<i>hP7</i>	<i>P</i> $\bar{6}$
Co ₁₁ Nd ₂₄	~ 84.2	<i>hP70</i>	<i>P6₃mc</i>

Co₂Nd₅

~85.9

mC28

C2/c

Co-Ni (Cobalt - Nickel)

T. Nishizawa and K. Ishida, 1991

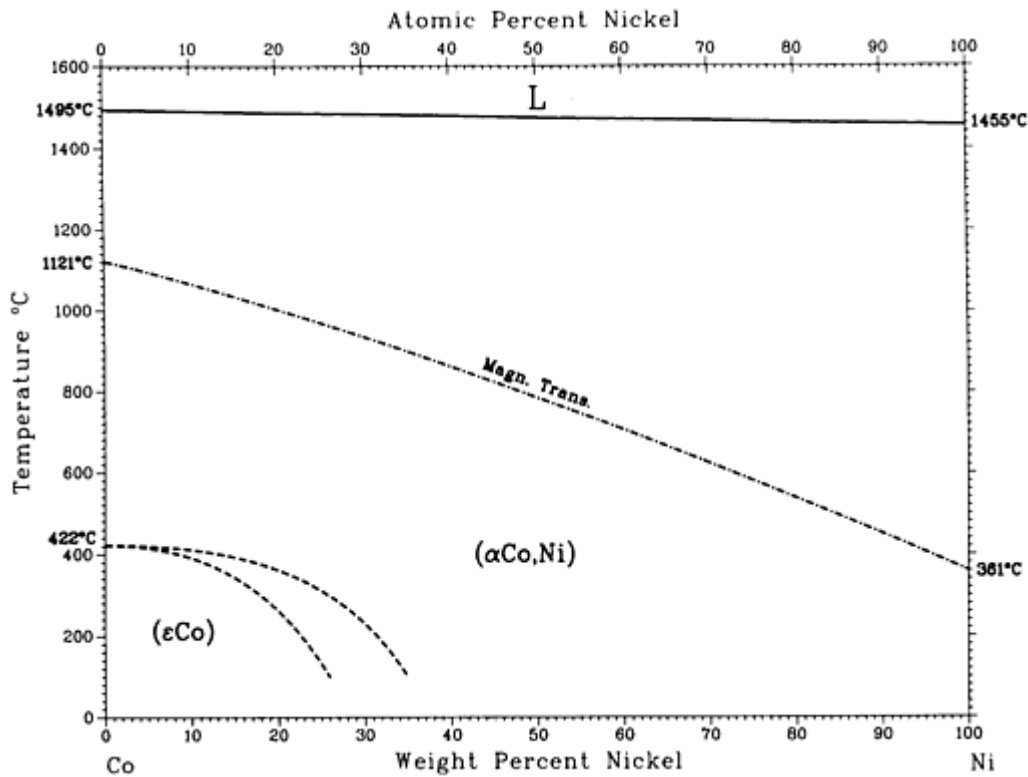

Co-Ni phase diagram

Co-Ni crystallographic data

Phase	Composition, wt% Ni	Pearson symbol	Space group
(αCo,Ni)	0 to 100	cF4	$Fm\bar{3}m$
(εCo)	0 to 35	hP2	$P6_3/mmc$

Co-P (Cobalt - Phosphorus)

K. Ishida and T. Nishizawa, 1990

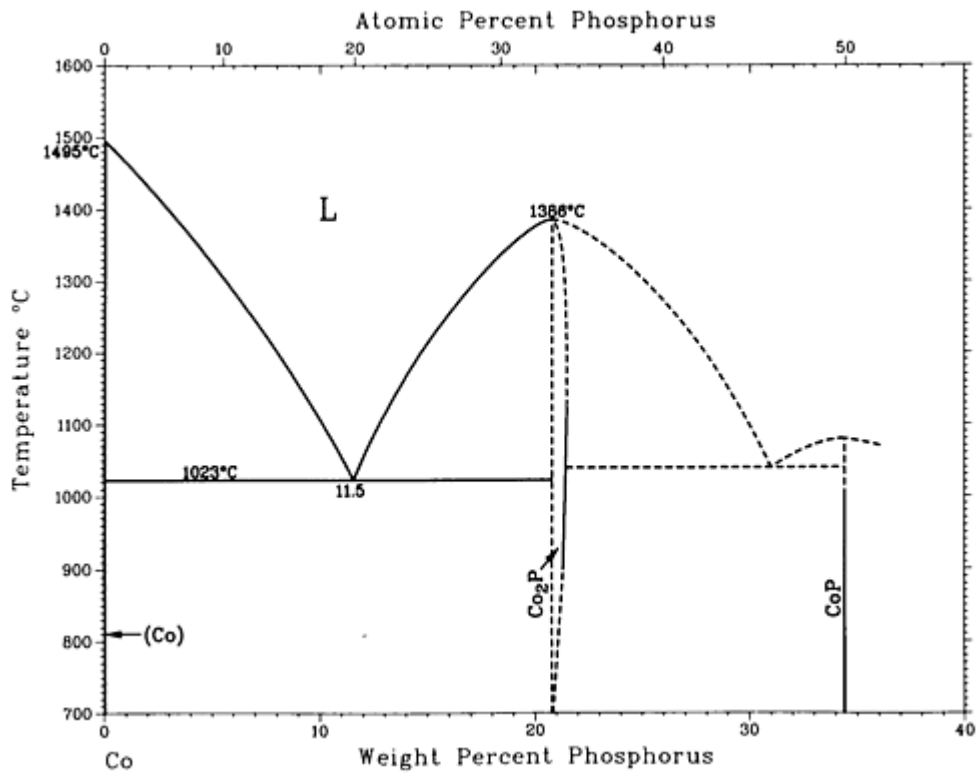

Co-P phase diagram

Co-P crystallographic data

Phase	Composition, wt% P	Pearson symbol	Space group
(α Co)	~0	<i>cF4</i>	<i>Fm</i> $\bar{3}m$
(ϵ Co)	~0.	<i>hP2</i>	<i>P6</i> ₃ / <i>mmc</i>
Co ₂ P	~20.6 to 21.3	<i>oP12</i>	<i>Pnma</i>
CoP	34.5	<i>oP8</i>	<i>Pnma</i>
CoP ₂	51.3	(a)	...
CoP ₃	61	<i>cI32</i>	<i>Im</i> $\bar{3}m$
Red (P)	100	(b)	...

White (P)	100	(b)	...
Black (P)	100	<i>oC8</i>	<i>Cmca</i>

(a) Monoclinic.

(b) Cubic

Co-Pd (Cobalt - Palladium)

K. Ishida and T. Nishizawa, 1991

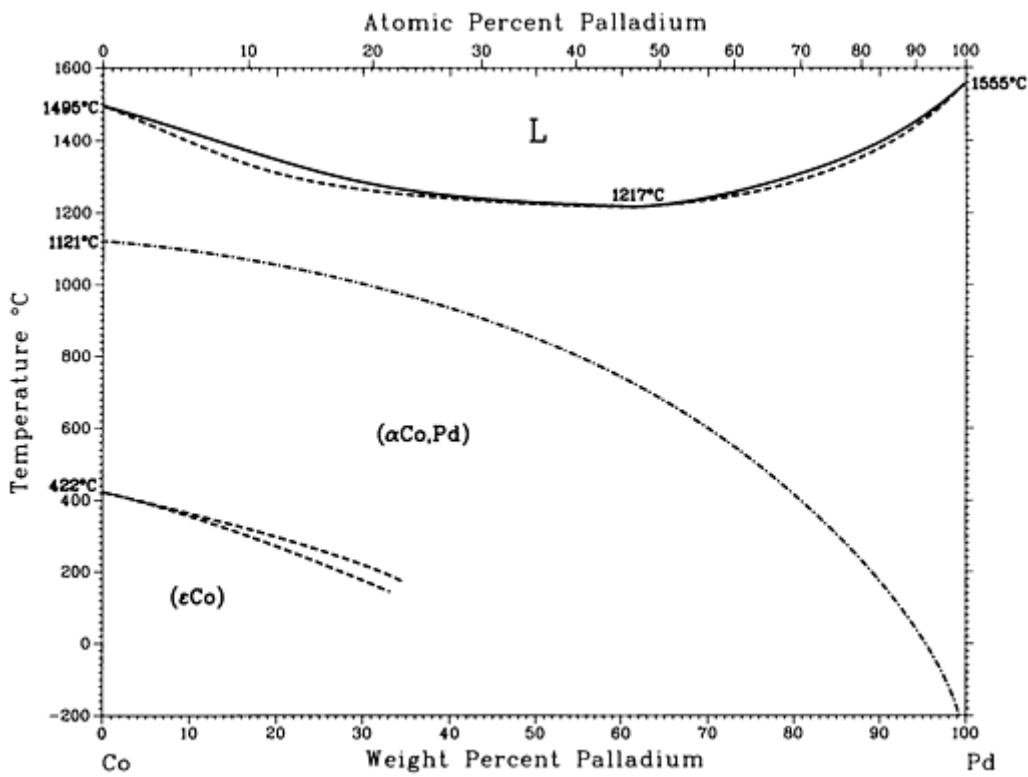

Co-Pd phase diagram

Co-Pd crystallographic data

Phase	Composition, wt% Pd	Pearson symbol	Space group
(α Co,Pd)	0 to 100	<i>cF4</i>	$Fm\bar{3}m$
(ϵ Co)	0 to \sim 31	<i>hR2</i>	$P6_3/mmc$

Metastable phases			
α''	~63 to ~66	<i>tP4</i>	<i>P4/mmm</i>
α'	73 to 94	<i>cP4</i>	<i>Pm$\bar{3}m$</i>

Co-Pr (Cobalt - Praseodymium)

A.E. Ray, 1874

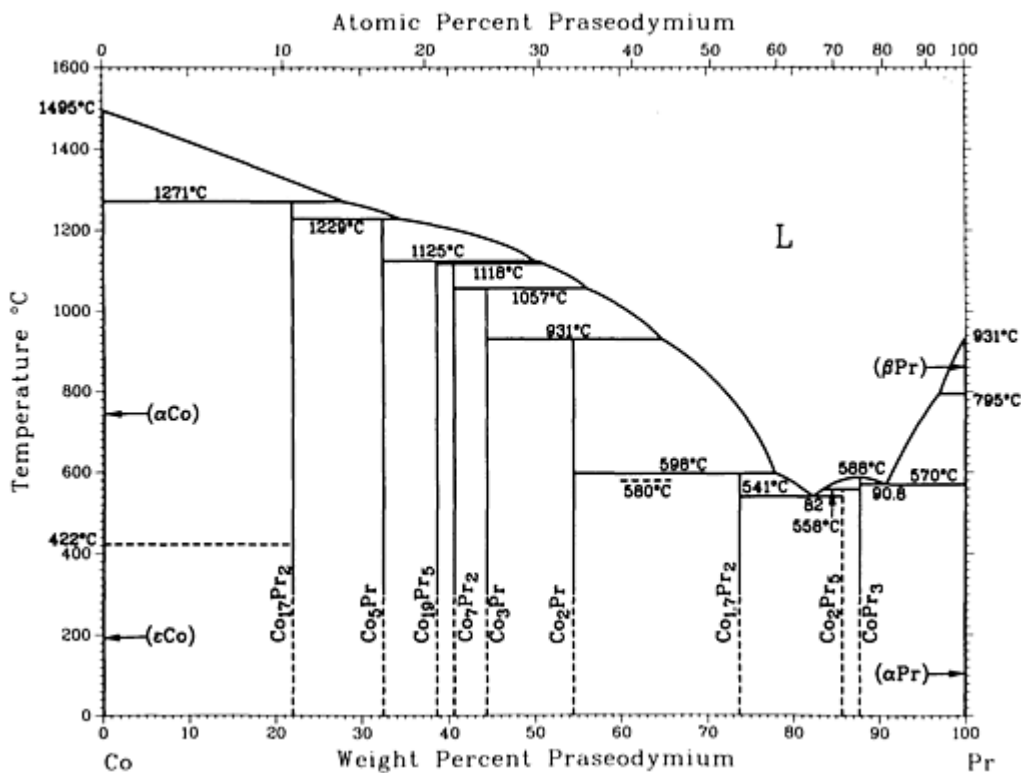

Co-Pr phase diagram

Co-Pr crystallographic data

Phase	Composition, wt% Pr	Pearson symbol	Space group
(αCo)	~0	<i>cF4</i>	<i>Fm$\bar{3}m$</i>
(ϵCo)	~0	<i>hP2</i>	<i>P6$_2$/mmc</i>
$\text{Co}_{17}\text{Pr}_2$	21.9	<i>hR19</i>	<i>R$\bar{3}m$</i>

Co₃Pr	32.4	<i>hP6</i>	<i>P6/mmm</i>
Co₁₉Pr₅	38.6	<i>hR24</i>	<i>R$\bar{3}m$</i>
<i>β</i> Co₇Pr₂	40.6	<i>hR18</i>	<i>R$\bar{3}m$</i>
<i>α</i> Co₇Pr₂	40.6	<i>hP36</i>	<i>P6₃/mmc</i>
Co₃Pr	44	<i>hR12</i>	<i>R$\bar{3}m$</i>
Co₂Pr	54.4	<i>cF24</i>	<i>Fd$\bar{3}m$</i>
Co_{1.7}Pr₂	~ 73.8	<i>hP*</i>	...
Co₂Pr₅	~ 85.7	<i>mC28</i>	<i>C2/c</i>
CoPr₃	88	<i>oP16</i>	<i>Pnma</i>
<i>(βPr)</i>	~ 100	<i>cI2</i>	<i>Im$\bar{3}m$</i>
<i>(αPr)</i>	~ 100	<i>hP4</i>	<i>P6₃/mmc</i>

Co-Pt (Cobalt - Platinum)

H. Okamoto, 1990

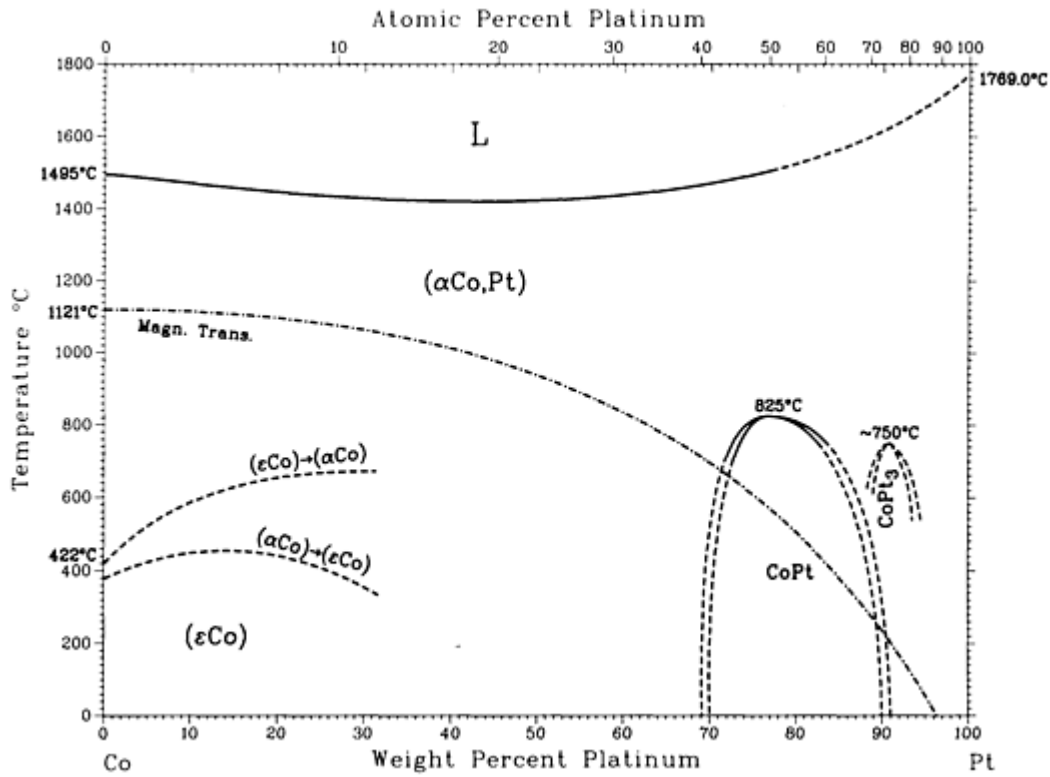

Co-Pt phase diagram

Co-Pt crystallographic data

Phase	Composition, wt% Pt	Pearson symbol	Space group
(αCo, Pt)	0 to 100	<i>cF4</i>	<i>Fm</i> $\bar{3}m$
(εCo)	0 to ?	<i>hP2</i>	<i>P6₃/mmc</i>
CoPt	~76.8	<i>tP4</i>	<i>P4/mmm</i>
CoPt ₃	~91	<i>cP4</i>	<i>Pm</i> $\bar{3}m$

Co-Pu (Cobalt - Plutonium)

D.M. Poole, M.G. Bale, P.G. Mardon, J.A.C. Marples, and J.L. Nichols, 1961

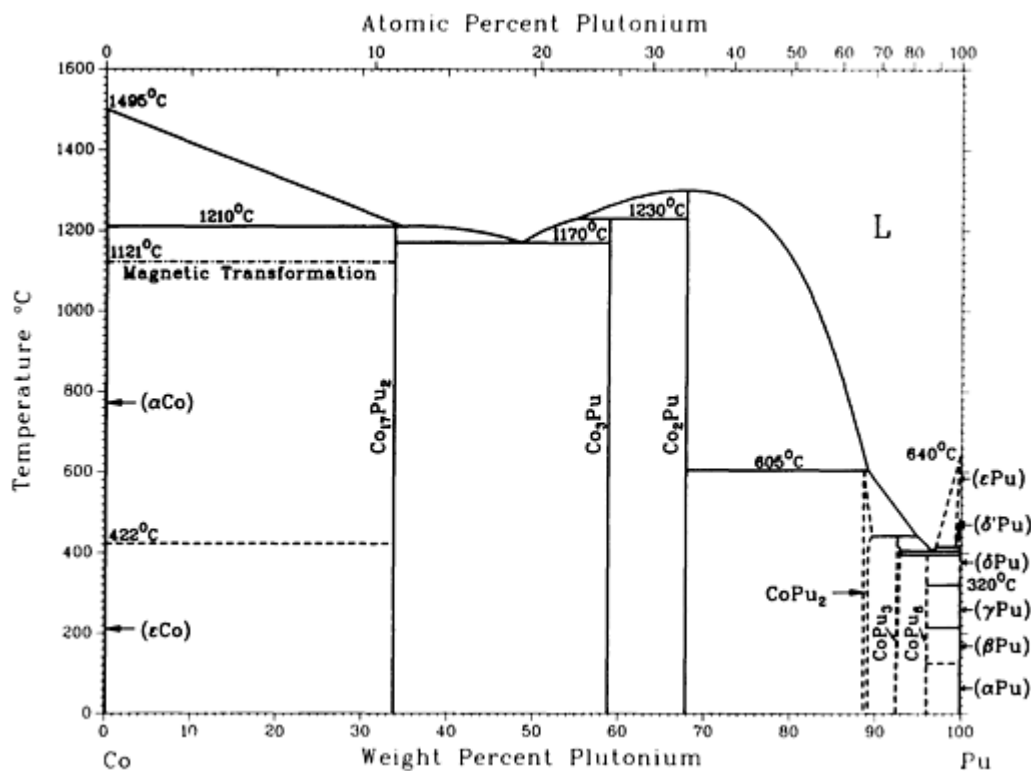

Co-Pu phase diagram

Co-Pu crystallographic data

Phase	Composition, wt% Pu	Pearson symbol	Space group
(αCo)	~0	<i>cF4</i>	<i>Fm</i> $\bar{3}m$
(εCo)	~0	<i>hP2</i>	<i>P6</i> ₃ / <i>mmc</i>
Co ₁₇ Pu ₂	34	<i>hP38</i>	<i>P6</i> ₃ / <i>mmc</i>
Co ₃ Pu	~58.9	<i>hR12</i>	<i>R</i> $\bar{3}m$
Co ₂ Pu	~67.4	<i>cF24</i>	<i>Fd</i> $\bar{3}m$
CoPu ₂	~88.7 to 90	<i>hP9</i>	<i>P6</i> ₃ / <i>mmc</i>
CoPu ₃	~92.6 to 93	<i>oC16</i>	<i>Cmcm</i>

CoPu_6	96.1	$tI28$	$I4/mcm$
(ϵPu)	~ 99.5 to 100	$cI2$	$Im\bar{3}m$
$(\delta'\text{Pu})$	~ 100	$tI2$	$I4/mmm$
(δPu)	~ 100	$cF4$	$Fm\bar{3}m$
(γPu)	~ 100	$oF8$	$Fddd$
(βPu)	~ 100	$mC34$	$C2/m$
(αPu)	~ 100	$mP16$	$P2_1/m$

Co-Re (Cobalt - Rhenium)

H. Okamoto, 1990

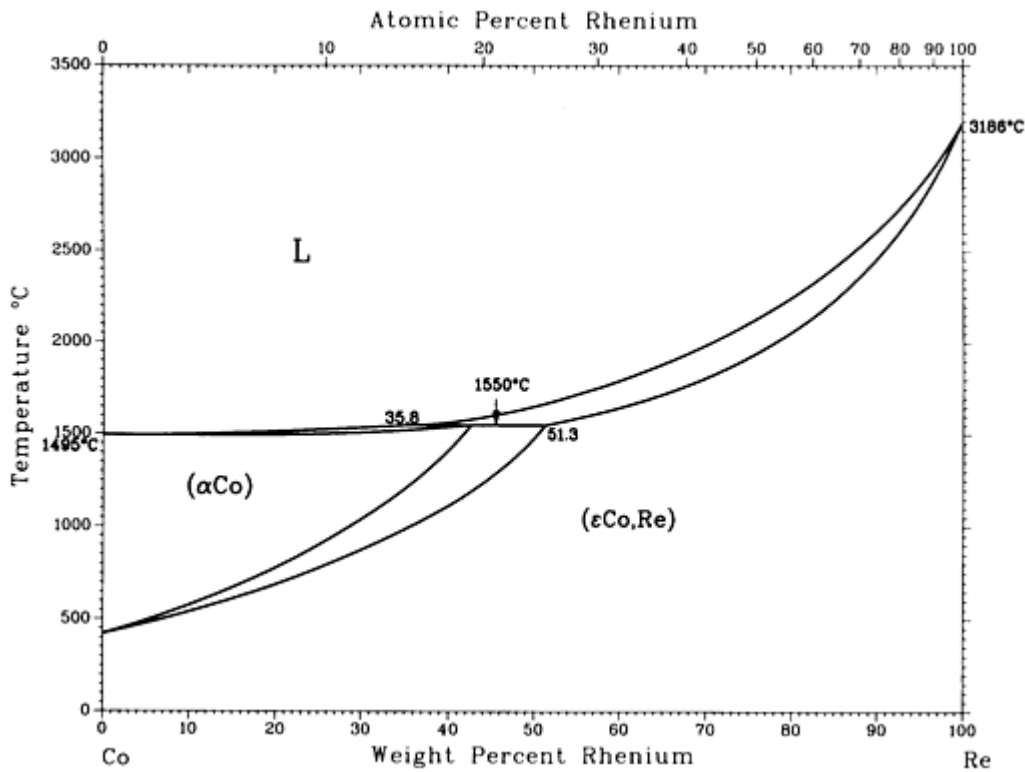

Co-Re phase diagram

Co-Re crystallographic data

Phase	Composition, wt% Re	Pearson symbol	Space group
(α Co)	0 to 43	<i>cF4</i>	$Fm\bar{3}m$
(ϵ Co,Re)	0 to 100	<i>hP2</i>	$P6_3/mmc$

Co-S (Cobalt - Sulfur)

K. Friedrich, 1908

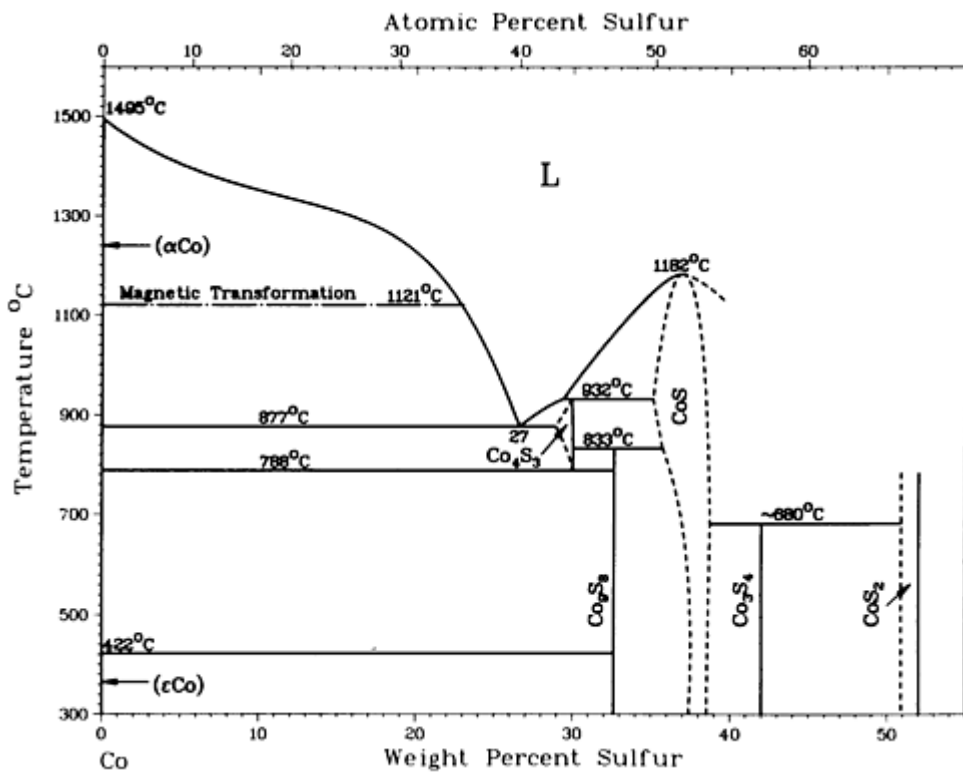

Co-S phase diagram

Co-S crystallographic data

Phase	Composition, wt% S	Pearson symbol	Space group
(α Co)	0	<i>cF4</i>	$Fm\bar{3}m$
(ϵ Co)	0	<i>hP2</i>	$P6_3/mmc$
Co_4S_3	~29.0

Co ₉ S ₈	32.6	cF68	Fm $\bar{3}m$
CoS	35.2 to 40	hP4	P6 ₃ /mmc
Co ₃ S ₄	42.0	cF56	Fd $\bar{3}m$
CoS ₂	52.1	cP12	Pa $\bar{3}$
(S)	100	oF128	Fddd

Co-Sb (Cobalt - Antimony)

H. Okamoto, 1991

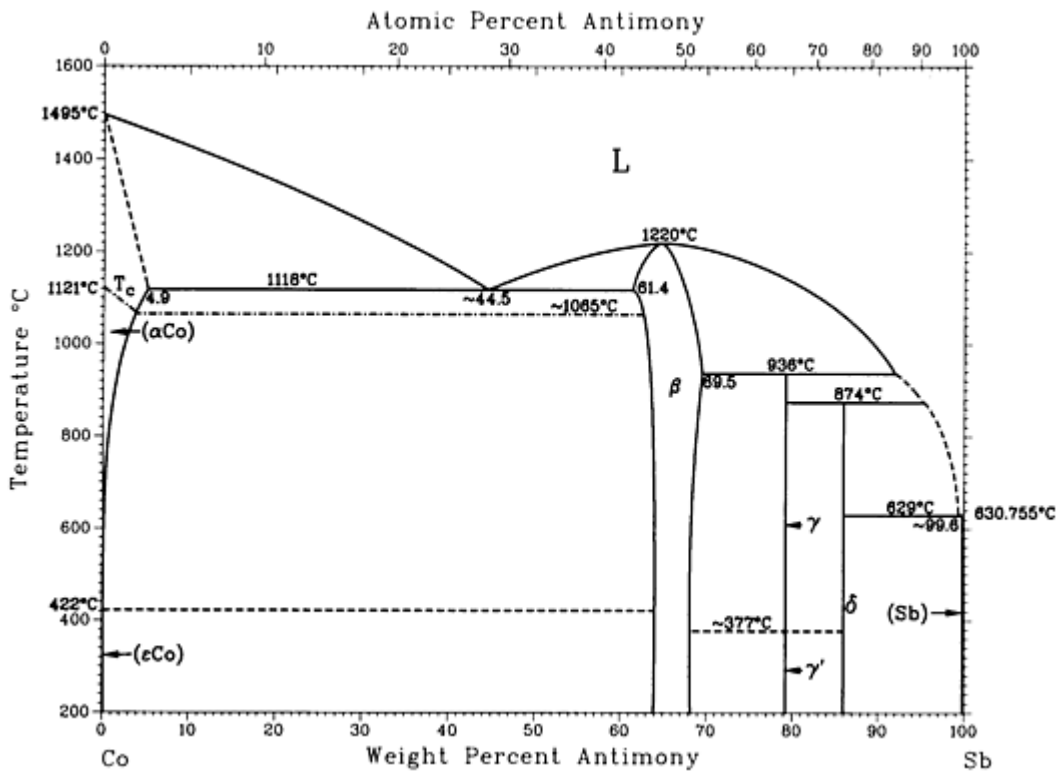

Co-Sb phase diagram

Co-Sb crystallographic data

Phase	Composition, wt% Sb	Pearson symbol	Space group
(αCo)	0 to ~5.0	cF4	Fm $\bar{3}m$

(ϵ Co)	0	<i>hP2</i>	<i>P6₃/mmc</i>
β	61.4 to \sim 69	<i>hP4</i>	<i>P6₃/mmc</i>
γ	79	<i>oP6</i>	<i>Pnmm</i>
γ'	79	<i>mP12</i>	<i>P2₁/c</i>
δ	\sim 86	<i>cI32</i>	<i>Im$\bar{3}$</i>
(Sb)	\sim 100	<i>hR2</i>	<i>R$\bar{3}m$</i>

Co-Se (Cobalt - Selenium)

H. Okamoto, 1990

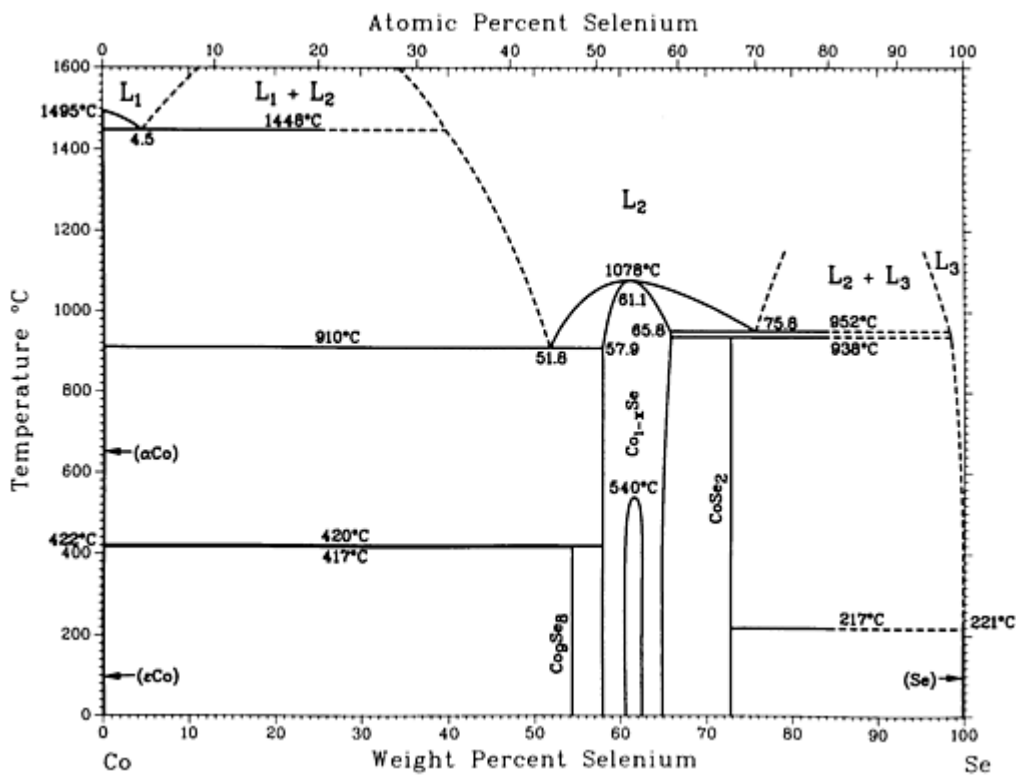

Co-Se phase diagram

Co-Se crystallographic data

Phase	Composition, wt% Se	Pearson symbol	Space group
(ϵ Co)	0	<i>hP2</i>	<i>P6₃/mmc</i>
β	61.4 to \sim 69	<i>hP4</i>	<i>P6₃/mmc</i>
γ	79	<i>oP6</i>	<i>Pnmm</i>
γ'	79	<i>mP12</i>	<i>P2₁/c</i>
δ	\sim 86	<i>cI32</i>	<i>Im$\bar{3}$</i>
(Sb)	\sim 100	<i>hR2</i>	<i>R$\bar{3}m$</i>

(α Co)	0	<i>cF4</i>	<i>Fm</i> $\bar{3}m$
(ϵ Co)	0	<i>hP2</i>	<i>P6</i> $_3/mmc$
Co ₉ Se ₈	54.4	<i>cF68</i>	<i>Fm</i> $\bar{3}m$
Co _{1-x} Se	57.9 to 65.8	<i>m</i> **	...
CoSe ₂	72.9	<i>cP12</i>	<i>Pa</i> $\bar{3}$
(Se)	100	<i>oC8</i>	<i>Cmca</i>

Co-Si (Cobalt - Silicon)

K. Ishida and T. Nishizawa, 1991

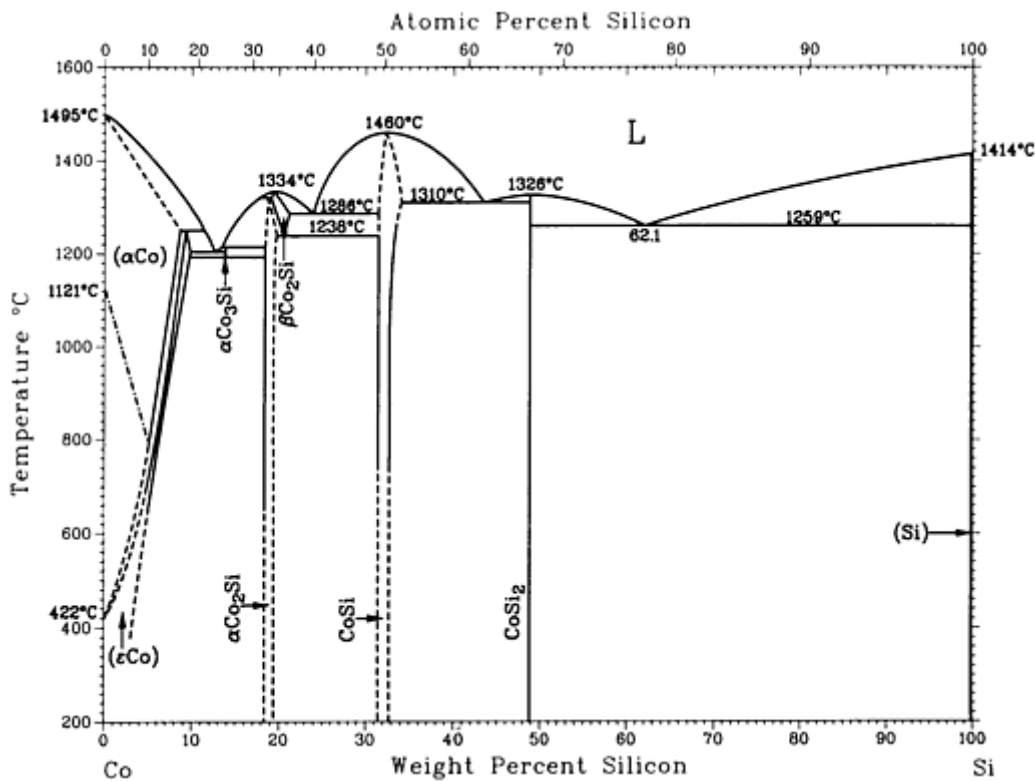

Co-Si phase diagram

Co-Si crystallographic data

Phase	Composition, wt% Si	Pearson symbol	Space group
(α Co)	0	<i>cF4</i>	<i>Fm</i> $\bar{3}m$
(ϵ Co)	0	<i>hP2</i>	<i>P6</i> $_3/mmc$
Co ₉ Se ₈	54.4	<i>cF68</i>	<i>Fm</i> $\bar{3}m$
Co _{1-x} Se	57.9 to 65.8	<i>m</i> **	...
CoSe ₂	72.9	<i>cP12</i>	<i>Pa</i> $\bar{3}$
(Se)	100	<i>oC8</i>	<i>Cmca</i>

(αCo)	0 to 8.5	$cF4$	$Fm\bar{3}m$
(ϵCo)	0 to 9.7	$hP2$	$P6_3/mmc$
Co_3Si	14	t^{**}	...
$\alpha\text{Co}_2\text{Si}$	~ 18 to ~ 20	$oP12$	$Pnma$
$\beta\text{Co}_2\text{Si}$	~ 18 to 21.0
CoSi	31 to ~ 34	$cP8$	$P2_13$
CoSi_2	48.8	$cF12$	$Fm\bar{3}m$
(Si)	~ 100	$cF8$	$Fd\bar{3}m$
Metastable phases			
Co_3Si	~ 4 to 14	$hP8$	$P6_3/mmc$
Co_4Si	~ 11
$\gamma\text{Co}_2\text{Si}^{(a)}$	~ 14	o^{**}	...
Co_2Si_3	42	$tP20$	$P\bar{4}c2$

(a) Formed by massive transformation

Co-Sm (Cobalt - Samarium)

From [Moffatt] 11

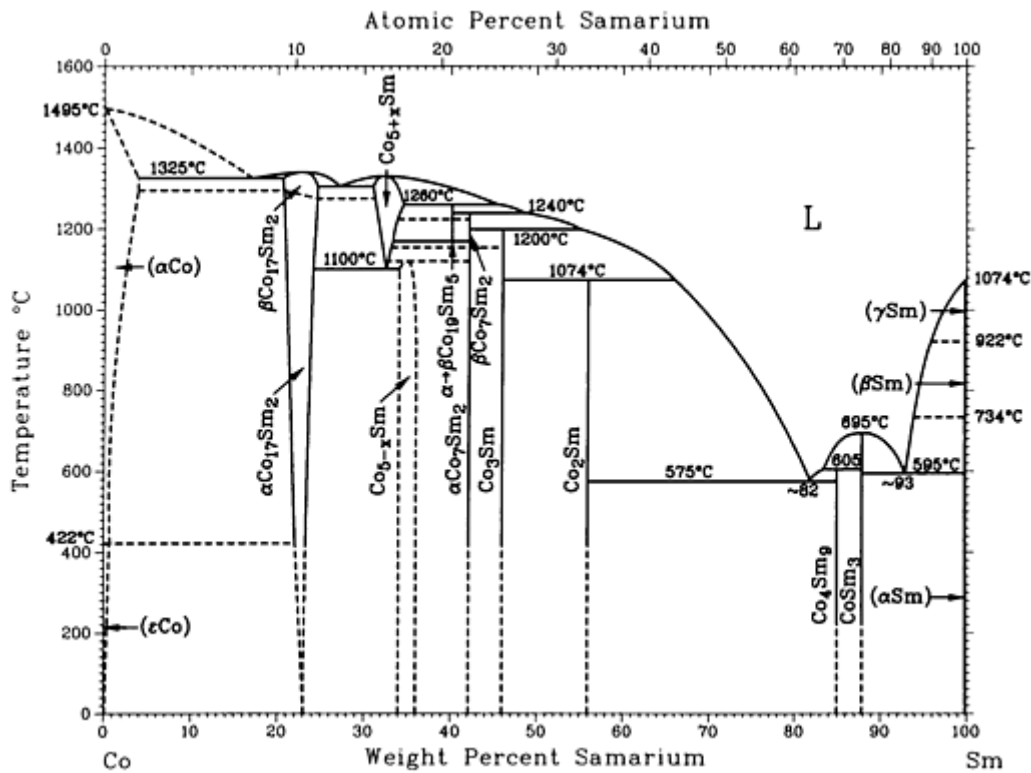

Co-Sm phase diagram

Co-Sm crystallographic data

Phase	Composition, wt% Sm	Pearson symbol	Space group
(αCo)	0 to ~3.7	cF4	$Fm\bar{3}m$
(εCo)	~0	hP2	$P6_3/mmc$
βCo ₁₇ Sm ₂	~23.0	hP38	$P6_3/mmc$
αCo ₁₇ Sm ₂	~23.0	hR19 hP8	$R\bar{3}m$ $P6/mmm$
Co _{5+x} Sm	~33 to 34
Co _{5-x} Sm	~34 to 35
Co ₁₉ Sm ₅	~40.1	hR24	$R\bar{3}m$

		<i>hP48</i>	<i>P6₃/mmc</i>
α Co ₇ Sm ₂	~42.1	<i>hR18</i>	<i>R$\bar{3}m$</i>
β Co ₇ Sm ₂	~42.1	<i>hP36</i>	<i>P6₃/mmc</i>
Co ₃ Sm	46	<i>hR12</i>	<i>R$\bar{3}m$</i>
Co ₂ Sm	56.0	<i>hR4</i> <i>cF24</i>	<i>R$\bar{3}m$</i> <i>Fd$\bar{3}m$</i>
Co ₄ Sm ₉	~85.1	<i>o**</i>	...
CoSm ₃	88	<i>oP16</i>	<i>Pnma</i>
(γ Sm)	~100	<i>cI2</i>	<i>Im$\bar{3}m$</i>
(β Sm)	~100	<i>hP2</i>	<i>P6₃/mmc</i>
(α Sm)	~100	<i>hR3</i>	<i>R$\bar{3}m$</i>
Other reported phases			
Co ₅ Sm	~33.8	<i>hP6</i> <i>hP*</i>	<i>P6/mmm</i> ...
Co ₂ Sm ₅	~86.4	<i>mC28</i>	<i>C2/c</i>

Reference cited in this section

- [Moffatt]: W.G. Moffatt, Ed., *Handbook of Binary Phase Diagrams*, Business Growth Services, General Electric Co., Schenectady, NY (1976).

Co-Sn (Cobalt - Tin)

K. Ishida and T. Nishizawa, 1991

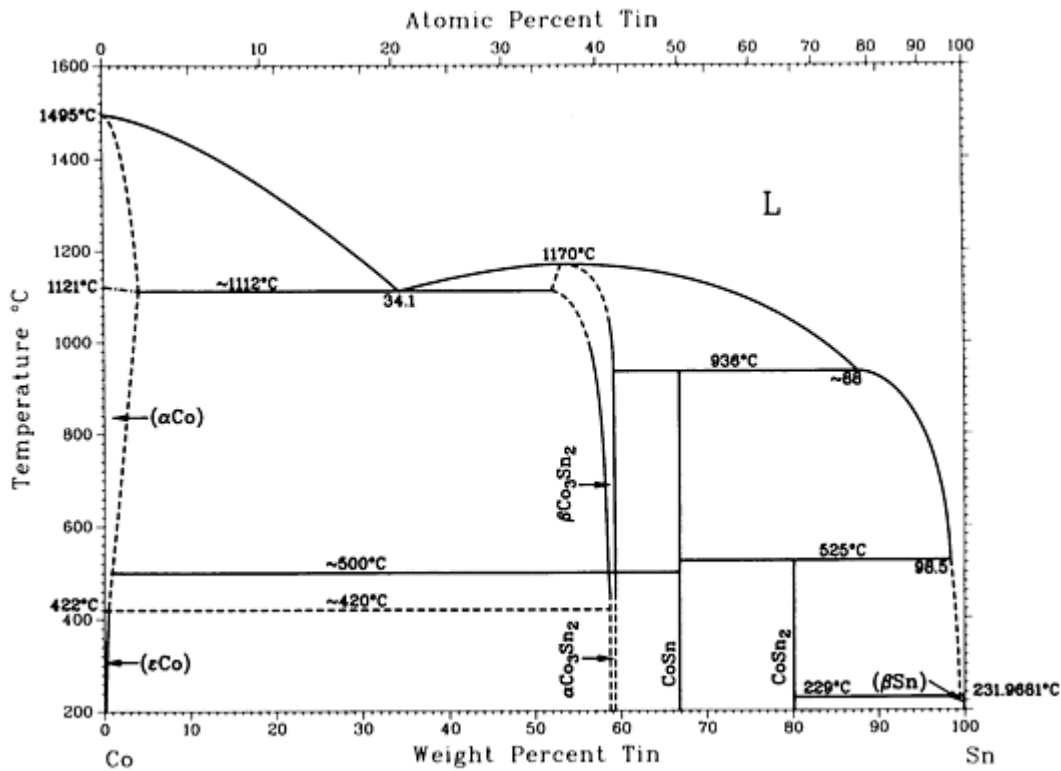

Co-Sn phase diagram

Co-Sn crystallographic data

Phase	Composition, wt% Sn	Pearson symbol	Space group
(αCo)	0 to ~4	cF4	$Fm\bar{3}m$
(εCo)	0 to ~0.4	hP2	$P6_3/mmc$
βCo ₃ Sn ₂	~52 to ~59	hP4	$P6_3/mmc$
αCo ₃ Sn ₂	~58 to ~59	oP20	$Pnma$
CoSn	66.8	hP6	$P6/mmm$
CoSn ₂	80.1	tI12	$I4/m$
(βSn)	~100	tI4	$I4_1/amd$

Metastable phases			
(ϵ' Co)	3.0 to 15.1	...	$R\bar{3}m$
Co_3Sn	40.2	$cI2$ $cP2$	$Im\bar{3}m$ $Pm\bar{3}m$

Co-Ta (Cobalt - Tantalum)

H. Okamoto, 1991

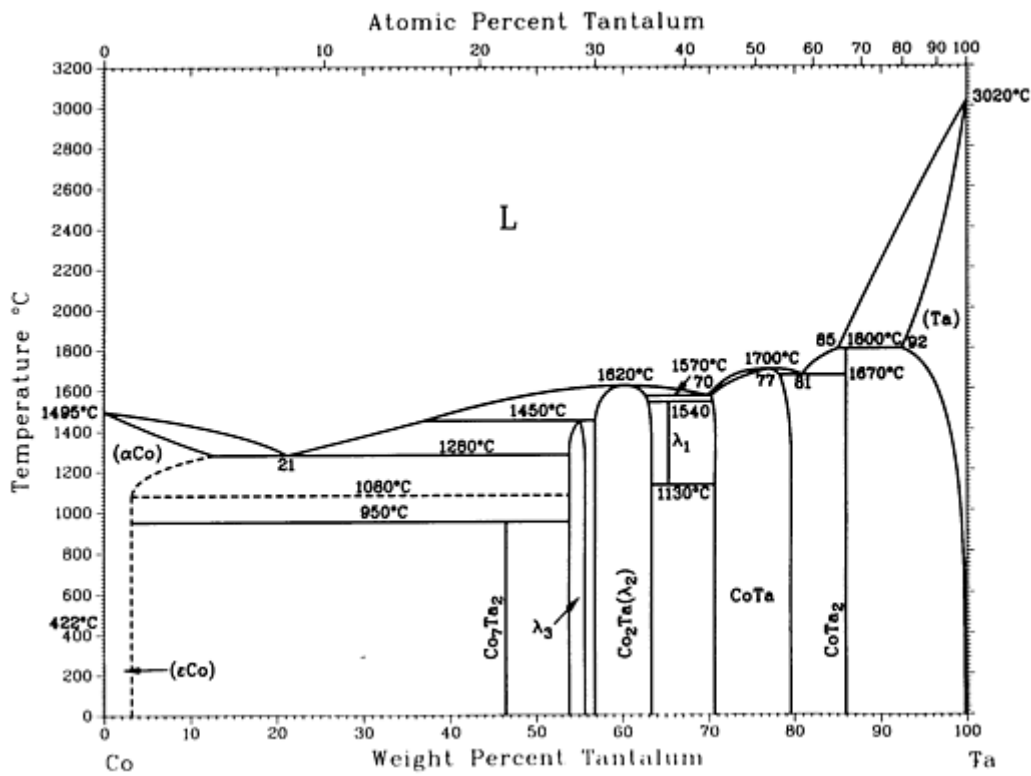

Co-Ta phase diagram

Co-Ta crystallographic data

Phase	Composition, wt% Ta	Pearson symbol	Space group
(α Co)	0 to 11	$cF4$	$Fm\bar{3}m$
Co_7Ta_2	46.7

λ_3	53.81 to 56	<i>hP</i> 24	<i>P</i> 6 ₃ / <i>mmc</i>
λ_2	56.2 to 63	<i>cF</i> 24	<i>Fd</i> $\bar{3}m$
λ_1	~64	<i>hP</i> 12	<i>P</i> 6 ₃ / <i>mmc</i>
Co₆Ta₇	71 to 80	<i>hR</i> 13	<i>R</i> $\bar{3}m$
CoTa₂	86.0	<i>tI</i> 12	<i>I</i> 4/ <i>mcm</i>
(Ta)	92 to 100	<i>cI</i> 2	<i>Im</i> $\bar{3}m$

Co-Tb (Cobalt - Terbium)

H. Okamoto, 1990

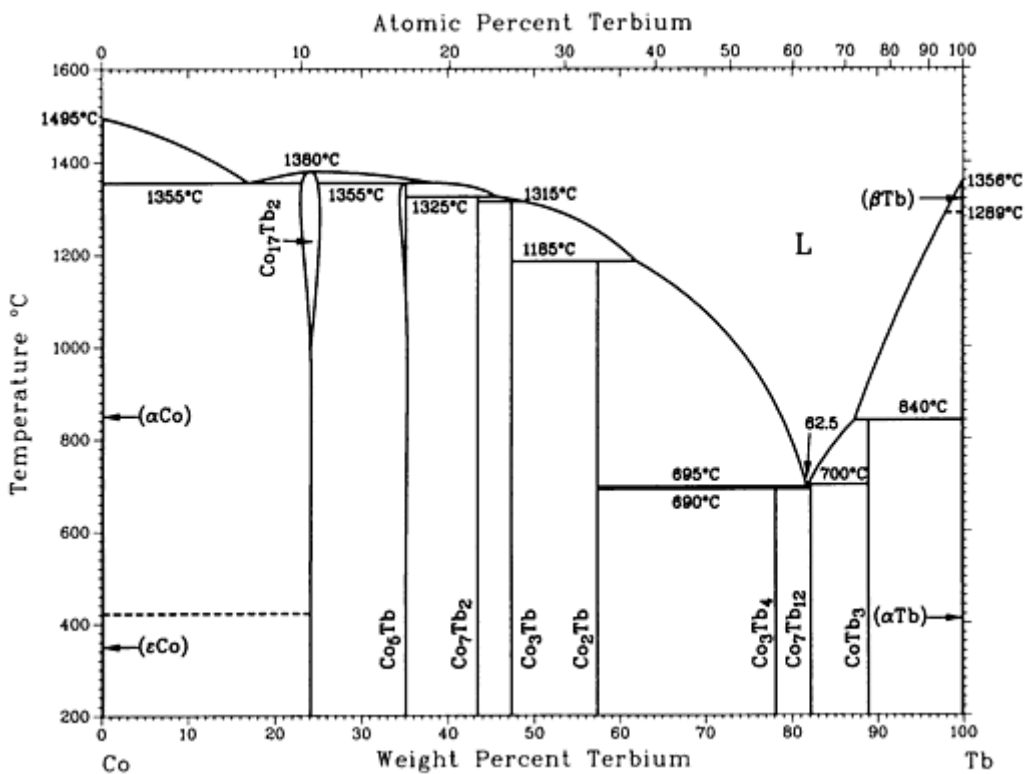

Co-Tb phase diagram

Co-Tb crystallographic data

Phase	Composition, wt% Tb	Pearson symbol	Space group
-------	---------------------	----------------	-------------

(αCo)	0	$cF4$	$Fm\bar{3}m$
(ϵCo)	0	$hP2$	$P6_3/mmc$
$\beta\text{Co}_{17}\text{Tb}_2$	24.0	$hP38$	$P6_3/mmc$
$\alpha\text{Co}_{17}\text{Tb}_2$	24.0	$hR19$	$R\bar{3}m$
Co_5Tb	35.1	$hP6$	$P6/mmm$
Co_7Tb_2	43.5	$hR18$	$R\bar{3}m$
Co_3Tb	47	$hR12$	$R\bar{3}m$
Co_2Tb	57.4	$cF24$	$Fd3m$
Co_3Tb_4	78.2	$hP22$	$P6_3/m$
$\text{Co}_7\text{Tb}_{12}$	82.2	$mP38$	$P2_1/c$
CoTb_3	89	$oP16$	$Pnma$
(Tb)	100	$hP2$	$P6_3/mmc$

Co-Te (Cobalt - Tellurium)

K. Ishida and T. Nishizawa, unpublished

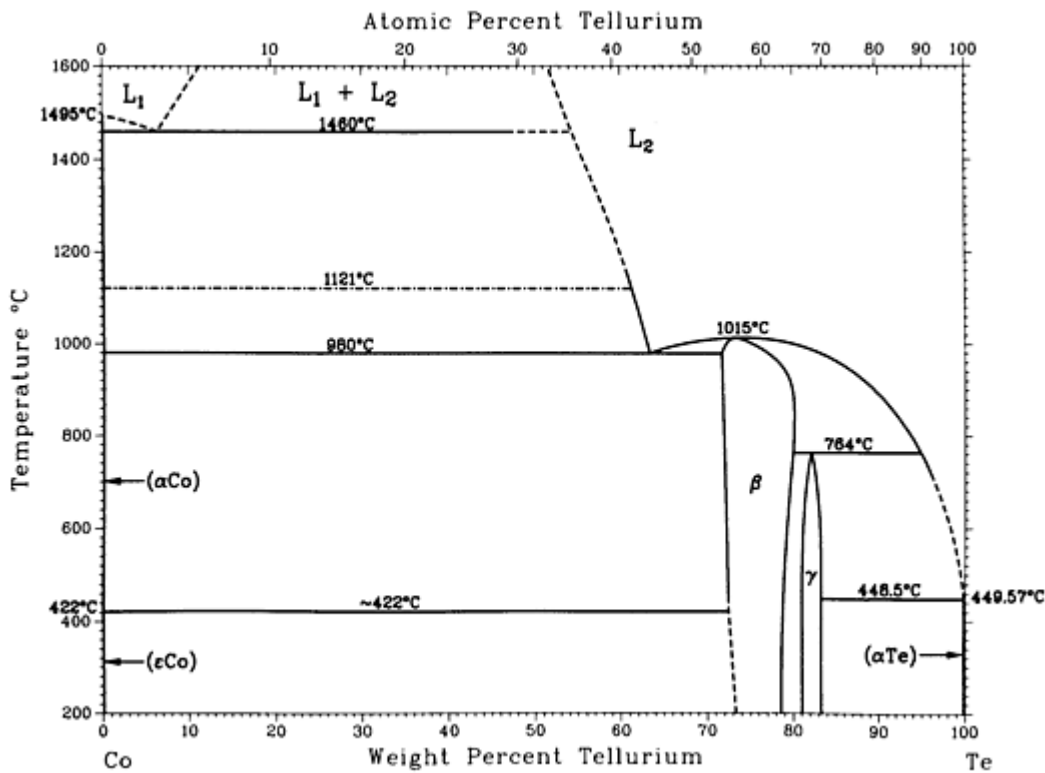

Co-Te phase diagram

Co-Te crystallographic data

Phase	Composition, wt% Te	Pearson symbol	Space group
(αCo)	~0	<i>cF4</i>	<i>Fm</i> $\bar{3}m$
(ϵCo)	~0	<i>hP2</i>	<i>P6</i> ₃ / <i>mmc</i>
β (Co ₂ Te ₃)	73 to 80	<i>hP4</i>	<i>P6</i> ₃ / <i>mmc</i>
γ (CoTe ₂)	81.1 to 83.3	<i>oP6</i>	<i>Pnn2</i>
CoTe ₂ ^(a)	81.3	<i>hP3</i>	<i>P</i> $\bar{3}m1$
CoTe ₂ ^(b)	81.3	<i>cP12</i>	<i>Pa</i> $\bar{3}$
(αTe)	~100	<i>hP3</i>	<i>P3</i> ₁ 21

(a) Metastable?

(b) Under high pressure

Co-Th (Cobalt - Thorium)

K. Ishida, T. Nishizawa, and H. Okamoto, unpublished

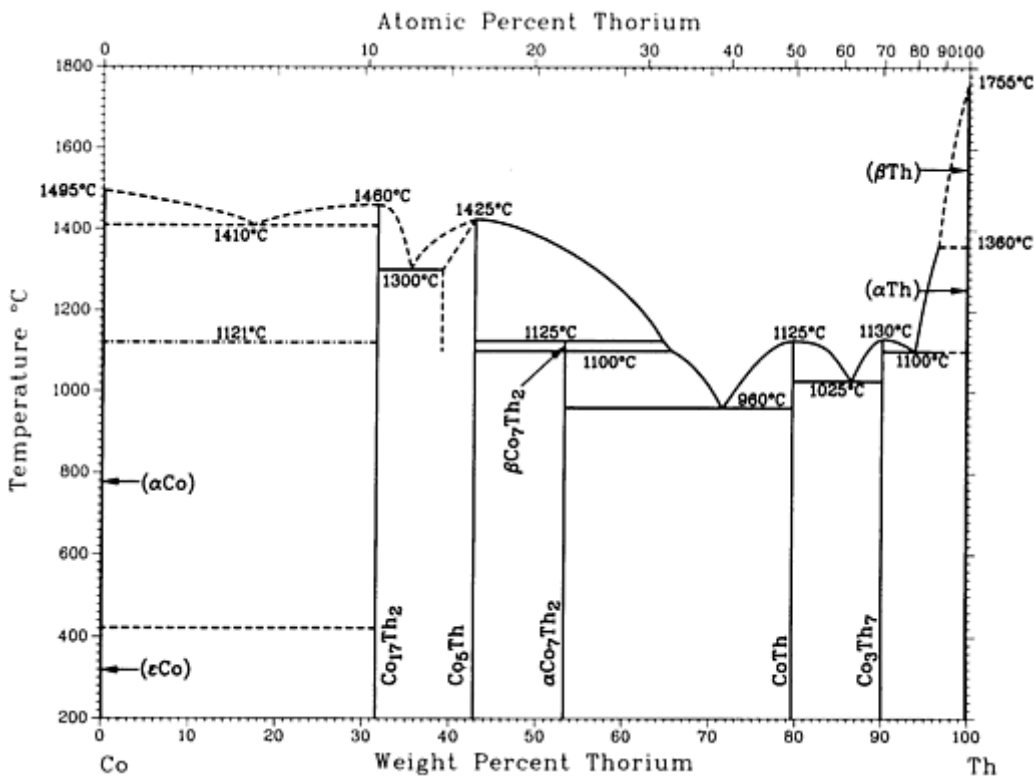

Co-Th phase diagram

Co-Th crystallographic data

Phase	Composition, wt% Th	Pearson symbol	Space group
(αCo)	~0	<i>cF4</i>	<i>Fm</i> $\bar{3}m$
(εCo)	~0	<i>hP2</i>	<i>P6</i> ₃ / <i>mmc</i>
Co ₁₇ Th ₂	31.6	<i>hR19</i>	<i>R</i> $\bar{3}m$
Co ₅ Th	44.1	<i>hP6</i>	<i>P6</i> / <i>mmm</i>

$\alpha\text{Co}_7\text{Th}_2$	52.9	<i>hP36</i>	$P6_3/mmc$
$\beta\text{Co}_7\text{Th}_2$	52.9	<i>hR18</i>	$R\bar{3}m$
CoTh	79.7	<i>oC8</i>	$Cmcm$
Co_3Th_7	90	<i>hP20</i>	$P6_3/mc$
(βTh)	~ 100	<i>cI2</i>	$Im\bar{3}m$
(αTh)	~ 100	<i>cF4</i>	$Fm\bar{3}m$

Co-Ti (Cobalt - Titanium)

J.L. Murray, 1987

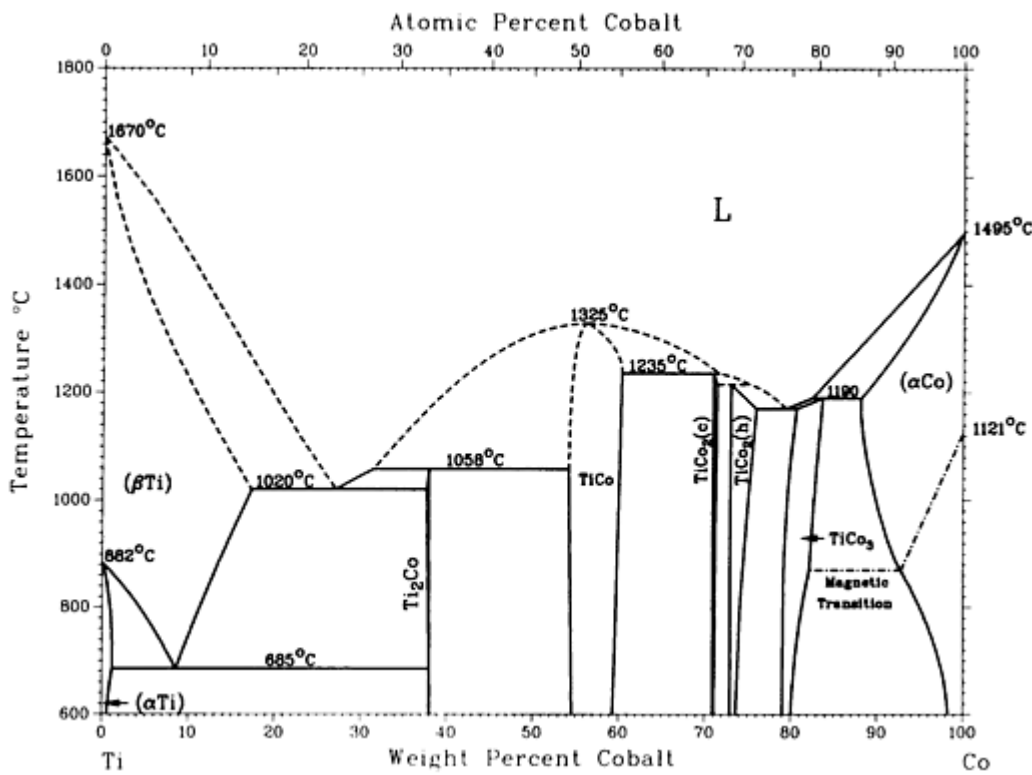

Co-Ti phase diagram

Co-Ti crystallographic data

Phase	Composition, wt% Co	Pearson symbol	Space group
-------	---------------------	----------------	-------------

(αTi)	0 to 1.0	$hP2$	$P6_3/mmc$
(βTi)	0 to 17.3	$cI2$	$Im\bar{3}m$
Ti_2Co	37.6 to 38.1	$cF96$	$Fd\bar{3}m$
TiCo	54 to 60	$cP2$	$Pm\bar{3}m$
TiCo_2 (cubic)	71.0 to 71	$cF24$	$Fd\bar{3}m$
TiCo_2 (hexagonal)	73.0 to 76	$hP24$	$P6_3/mmc$
TiCo_3	79.1 to 83.7	$cP4$	$Pm\bar{3}m$
(ϵCo)	~ 99.2 to 100	$hP2$	$P6_3/mmc$
(αCo)	88.0 to 100	$cF4$	$Fm\bar{3}m$
Metastable phases			
ω	...	(a)	$P6/mmm$
$(\alpha''\text{Co})$...	(b)	...

(a) The "ideal" ω structure is hexagonal, but a distorted trigonal form has also been observed in some Ti systems. The structure of ω in Ti-Co has not been definitively established.

(b) Rhombohedral

Co-V (Cobalt - Vanadium)

J.F. Smith, 1989

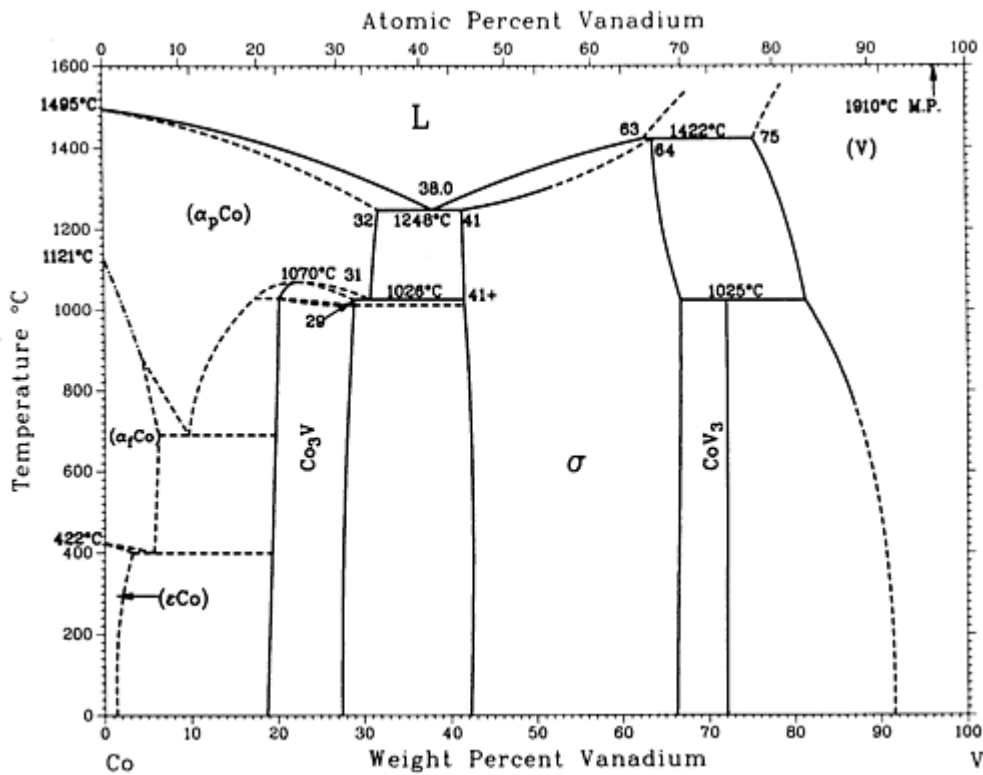

Co-V phase diagram

Co-V crystallographic data

Phase	Composition, wt% V	Pearson symbol	Space group
(αCo)	0 to 32	<i>cF4</i>	$Fm\bar{3}m$
(ϵCo)	0 to ?	<i>hP2</i>	$P6_3/mmc$
$\text{Co}_3\text{V}(\text{hex})$	~21 to 29	<i>hP24</i>	$P\bar{6}m2$
$\text{Co}_3\text{V}(\text{fcc})$	~19 to 28	<i>cP4</i>	$Pm\bar{3}m$
σ	41 to ~67	<i>tP30</i>	$P4_2/mnm$
CoV_3	~72	<i>cP8</i>	$Pm\bar{3}n$
(V)	75 to 100	<i>cI2</i>	$Im\bar{3}m$

Co-W (Cobalt - Tungsten)

S.V. Nagender Naidu, A.M. Sriramamurthy, and P. Rama Rao, 1986

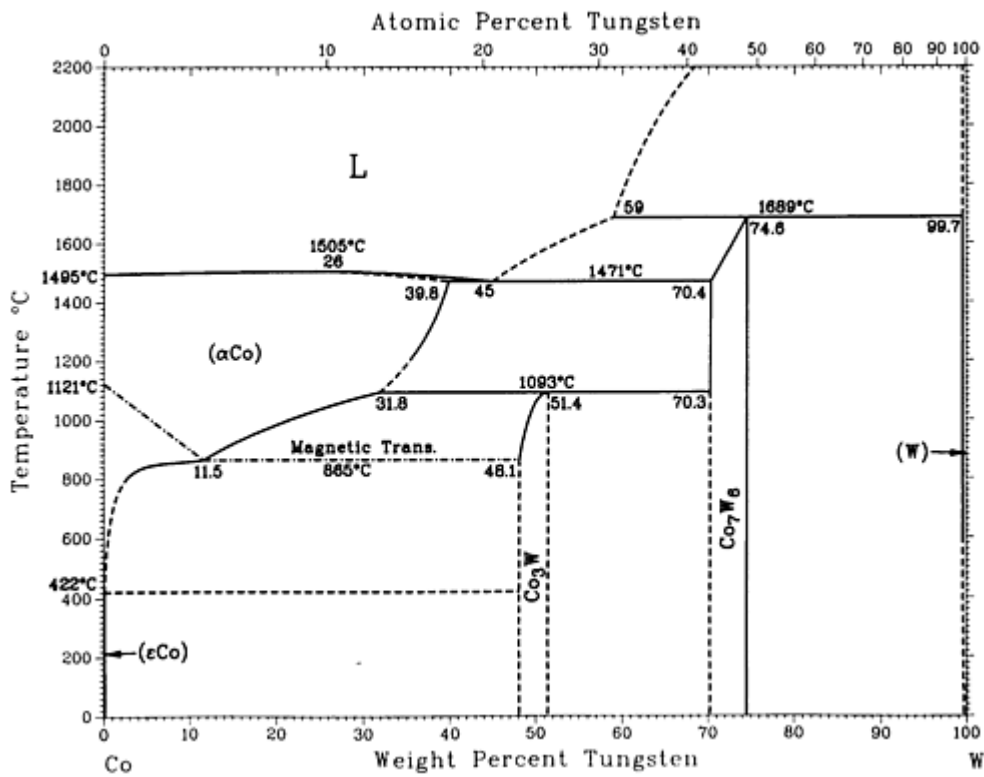

Co-W phase diagram

Co-W crystallographic data

Phase	Composition, wt% W	Pearson symbol	Space group
(αCo)	0 to 39.8	cF4	$Fm\bar{3}m$
(εCo)	0	hP2	$P6_3/mmc$
Co ₃ W	48.1 to 51.4	hP8	$P6_3/mmc$
Co ₇ W ₆	70.3 to 74.6	hR13	$R\bar{3}m$
(W)	99.7 to 100	cI2	$Im\bar{3}m$

Co-Y (Cobalt - Yttrium)

H. Okamoto, 1992

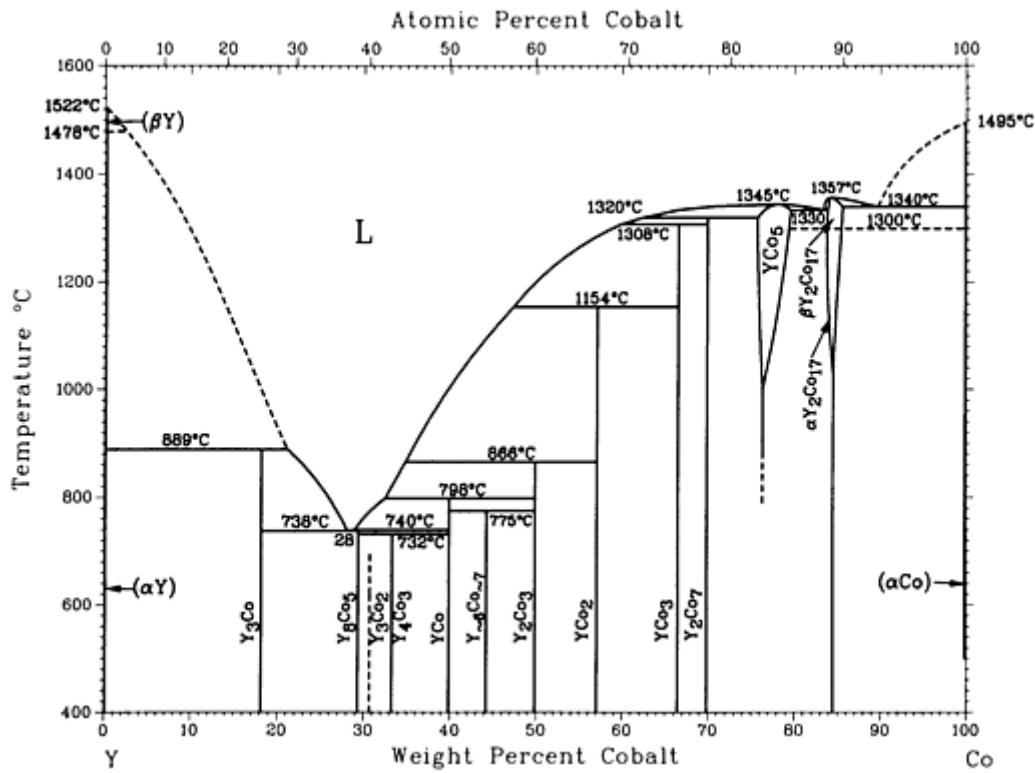

Co-Y phase diagram

Co-Y crystallographic data

Phase	Composition, wt% Co	Pearson symbol	Space group
(βY)	0	<i>cI2</i>	$Im\bar{3}m$
(αY)	0	<i>hP2</i>	$P6_3/mmc$
Y_3Co	18	<i>oP16</i>	$Pnma$
Y_8Co_5	29.3	<i>mP52</i>	$P2_1/c$
Y_4Co_3	33.2	<i>hP22</i>	$P6_3/m$
YCo	39.9	<i>oC8</i>	$Cmcm$
Y_6Co_7	44.4

Y_2Co_3	49.9	cP^*	...
YCo_2	57.0	$cF24$	$Fd\bar{3}m$
YCo_3	67	$hR12$ $hP24$	$R\bar{3}m$ $P6_3/mmc$
Y_2Co_7	69.9	$hR18$	$R\bar{3}m$
YCo_5	75.8 to 80	$hP6$	$P6/mmm$
$\beta\text{Y}_2\text{Co}_{17}$	84 to 86	$hP38$	$P6_3/mmc$
$\alpha\text{Y}_2\text{Co}_{17}$	~ 84	$hP19$	$R\bar{3}m$
(αCo)	100	$cF4$	$Fm\bar{3}m$
(ϵCo)	100	$hP2$	$P6_3/mmc$
Metastable phase			
Y_3Co_2	31	$oP20$	$Pnmm$

Co-Zn (Cobalt - Zinc)

H. Okamoto, 1990

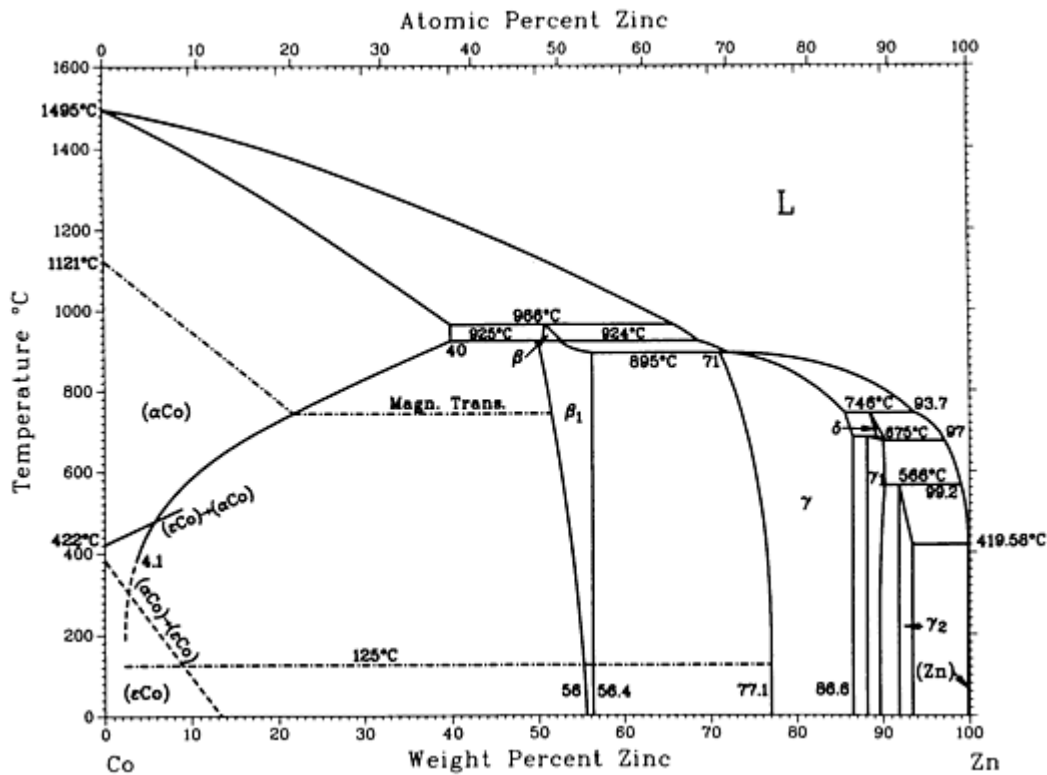

Co-Zn phase diagram

Co-Zn crystallographic data

Phase	Composition, wt% Zn	Pearson symbol	Space group
(αCo)	0 to 40	<i>cF4</i>	<i>Fm</i> $\bar{3}m$
(εCo)	0 to ?	<i>hP2</i>	<i>P6₃/mmc</i>
β	~52 to 54	<i>cI2?</i>	<i>Im</i> $\bar{3}m$
β ₁	50.5 to 59.0	<i>cP20</i>	<i>P4₁32</i>
γ	71 to 86.6	<i>cP52</i>	<i>P</i> $\bar{4}3m$
γ ₁	88.5 to 89.6
δ	~89 to <91

γ_2	92 to 93.5	<i>mC28</i>	<i>C2/m</i>
(Zn)	~100	<i>hP2</i>	<i>P6₃/mmc</i>

Cr (Chromium) Binary Alloy Phase Diagrams

Introduction

THIS ARTICLE includes systems where chromium is the first-named element in the binary pair. Additional binary systems that include chromium are provided in the following locations in this Volume:

- “Al-Cr (Aluminum - Chromium)” in the article “Al (Aluminum) Binary Alloy Phase Diagrams.”
- “Au-Cr (Gold - Chromium)” in the article “Au (Gold) Binary Alloy Phase Diagrams.”
- “B-Cr (Boron - Chromium)” in the article “B (Boron) Binary Alloy Phase Diagrams.”
- “Be-Cr (Beryllium - Chromium)” in the article “Be (Beryllium) Binary Alloy Phase Diagrams.”
- “C-Cr (Carbon - Chromium)” in the article “C (Carbon) Binary Alloy Phase Diagrams.”
- “Co-Cr (Cobalt - Chromium)” in the article “Co (Cobalt) Binary Alloy Phase Diagrams.”

Cr-Cu (Chromium - Copper)

D.J. Chakrabarti and D.E Laughlin, 1984

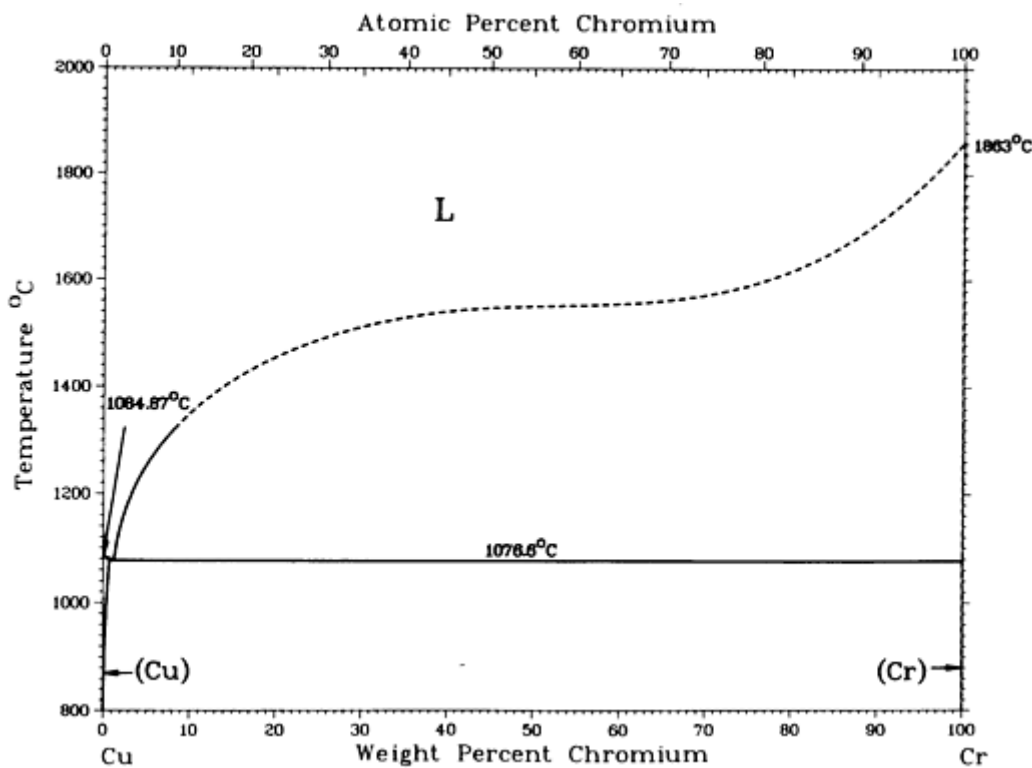

Cr-Cu phase diagram

Cr-Cu crystallographic data

Phase	Composition, wt% Cr	Pearson symbol	Space group
(Cu)	0 to 0.73	<i>cF4</i>	<i>Fm</i> $\bar{3}m$
(Cr)	99.8 to 100	<i>cI2</i>	<i>Im</i> $\bar{3}m$

Cr-Fe (Chromium - Iron)

H. Okamoto, 1990

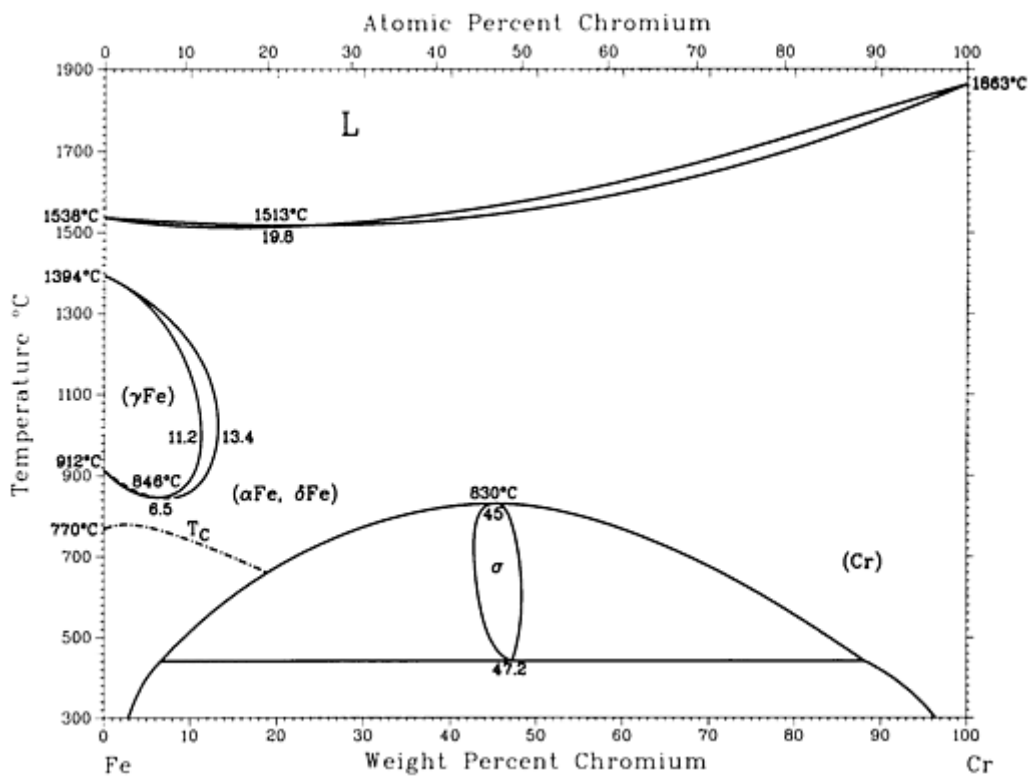

Cr-Fe phase diagram

Cr-Fe crystallographic data

Phase	Composition, wt% Cr	Pearson symbol	Space group
(αFe,Cr)	0 to 100	<i>cI2</i>	<i>Im</i> $\bar{3}m$
(γFe)	0 to 11.2	<i>cF4</i>	<i>Fm</i> $\bar{3}m$
σ	42.7 to 48.2	<i>tP30</i>	<i>P4</i> ₂ / <i>mnm</i>

Cr-Ga (Chromium - Gallium)

J.-D. Bornand and P. Feschotte, 1972

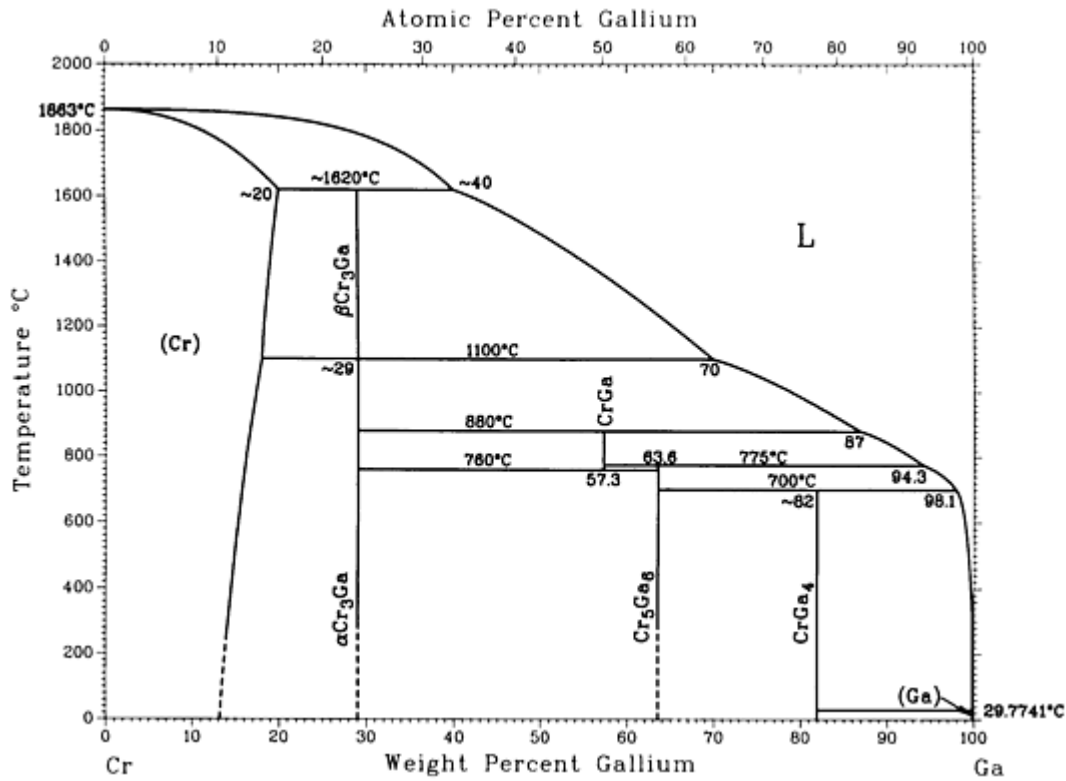

Cr-Ga phase diagram

Cr-Ga crystallographic data

Phase	Composition, wt% Ga	Pearson symbol	Space group
(Cr)	0 to ~20	<i>cI2</i>	$Im\bar{3}m$
$\beta\text{Cr}_3\text{Ga}$	~29
$\alpha\text{Cr}_3\text{Ga}$	~29	<i>cP8</i>	$Pm\bar{3}n$
CrGa	57.3	<i>hR26</i>	$R\bar{3}m$
Cr_5Ga_6	63.6
CrGa ₄	~82	<i>cI10</i>	<i>I432</i>
(Ga)	~100	<i>oC8</i>	<i>Cmca</i>

Cr-Ge (Chromium - Germanium)

A.B. Gokhale and G.J. Abbaschian, 1986

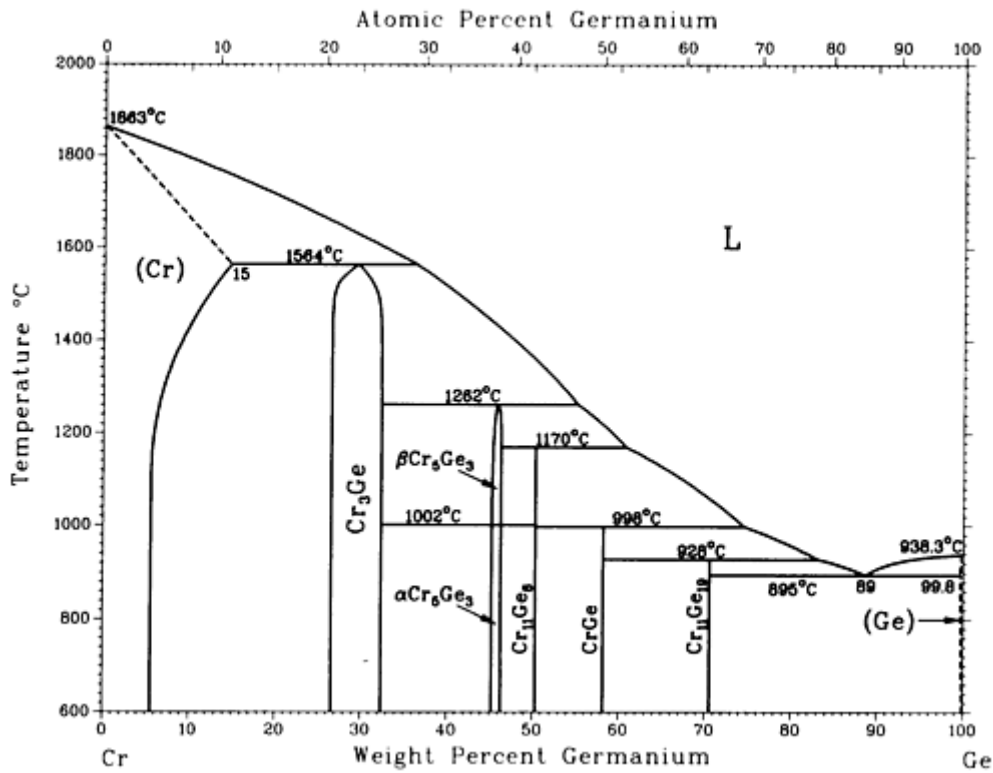

Cr-Ge phase diagram

Cr-Ge crystallographic data

Phase	Composition, wt% Ge	Pearson symbol	Space group
(Cr)	0 to 15	<i>cI2</i>	$Im\bar{3}m$
Cr_3Ge	26.5 to 31.9	<i>cP8</i>	$Pm\bar{3}n$
Cr_5Ge_3	45.5 to 46.3	<i>hP16</i>	$I4/mcm$
$Cr_{11}Ge_8$	50.4	<i>oP76</i>	<i>Pnam</i>
CrGe	58.3	<i>cP8</i>	$P2_13$
$Cr_{11}Ge_{19}$	70.7	^(a)	$P\bar{4}n2$
(Ge)	100	<i>cF8</i>	$Fd\bar{3}m$

(a) Tetragonal

Cr-Hf (Chromium - Hafnium)

M. Venkatraman and J.P. Neumann, 1986

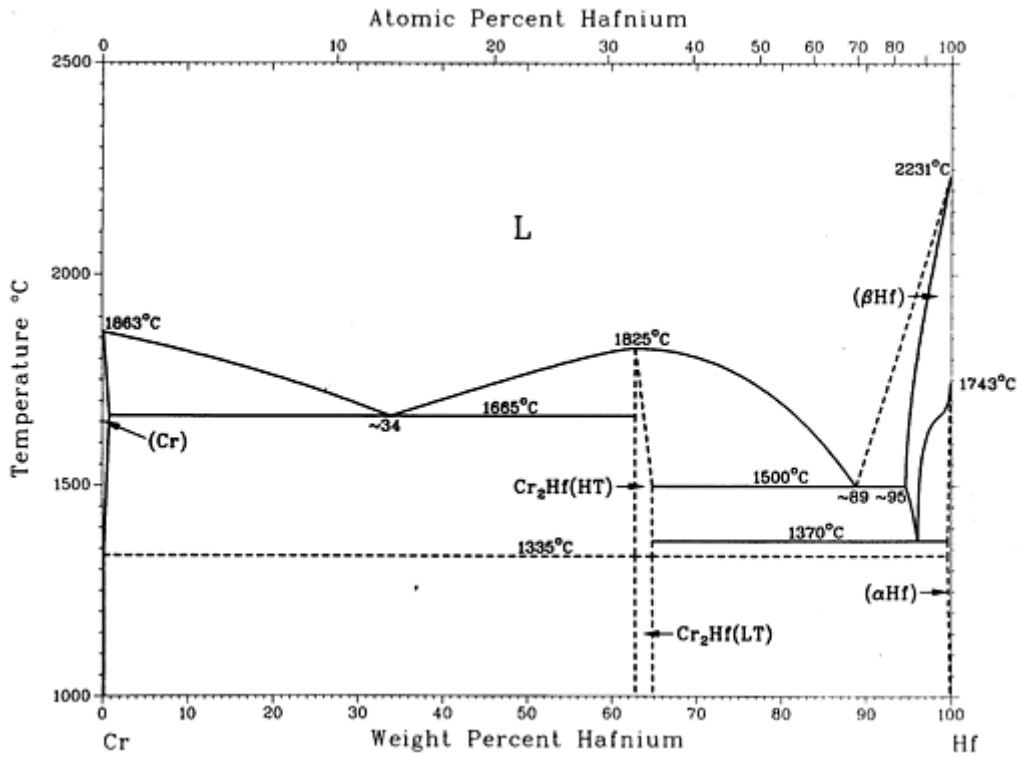

Cr-Hf phase diagram

Cr-Hf crystallographic data

Phase	Composition, wt% Hf	Pearson symbol	Space group
(Cr) ^(a)	~0	<i>cI2</i>	<i>Im</i> $\bar{3}m$
$Cr_2Hf(HT)$ ^(b)	63 to 65	<i>hP12</i>	<i>P6</i> ₃ / <i>mmc</i>
$Cr_2Hf(LT)$ ^(c)	63 to 65	<i>cF24</i>	<i>Fd</i> $\bar{3}m$
(βHf) ^(d)	~95 to 100	<i>cI2</i>	<i>Im</i> $\bar{3}m$
(αHf) ^(e)	98 to 100	<i>hP2</i>	<i>P6</i> ₃ / <i>mmc</i>

(a) Stable at <1863 °C.

(b) Stable at 1335 to 1825 °C.

(c) Stable at <1335 °C.

(d) Stable at 1740 to 2224 °C.

(e) Stable at <1740 °C

Cr-Ir (Chromium - Iridium)

M. Venkatraman and J.P. Neumann, 1990

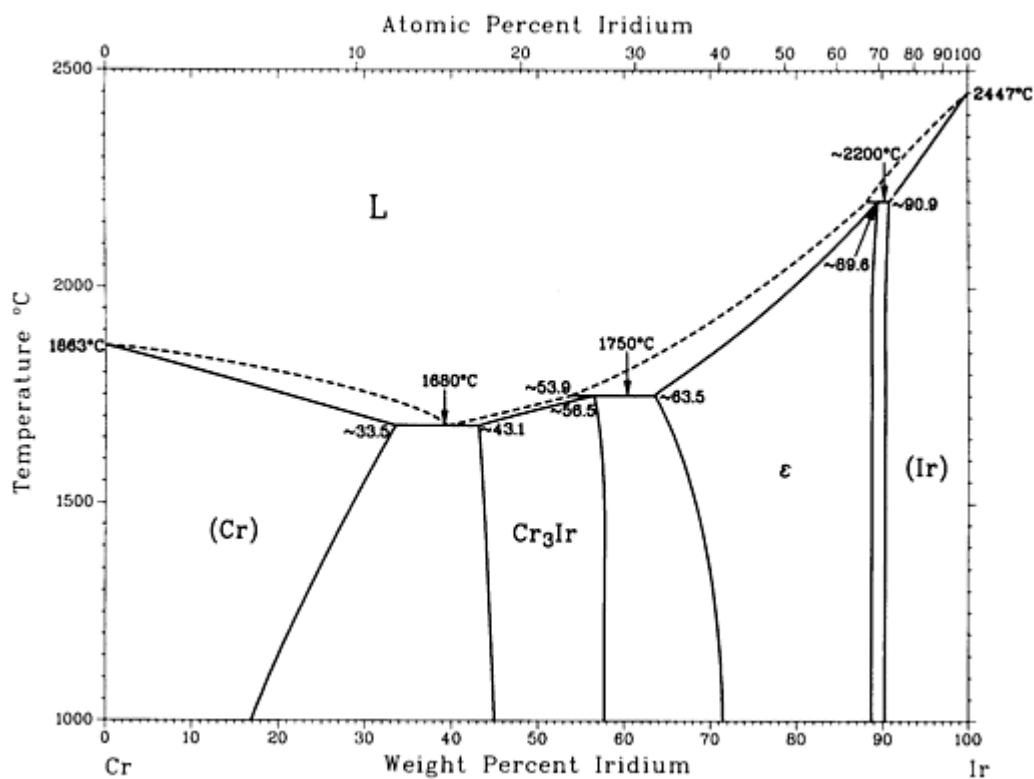

Cr-Ir phase diagram

Cr-Ir crystallographic data

Phase	Composition, wt% Ir	Pearson symbol	Space group
(Cr)	0 to ~33.5	cI2	$Im\bar{3}m$

Cr₃Ir	~43.1 to 58	cP8	$Pm\bar{3}n$
ε	~63.5 to ~89.6	hP2	$P6_3/mmc$
CrIr₃^(a)	~90 to ~95	cP4	$Pm\bar{3}m$
(Ir)	91 to 100	cF4	$Fm\bar{3}m$

(a) Order-disorder temperature has not been determined, but because it is presumably below 1000 °C, the phase is not shown in the diagram.

Cr-Lu (Chromium - Lutetium)

H. Okamoto, 1992

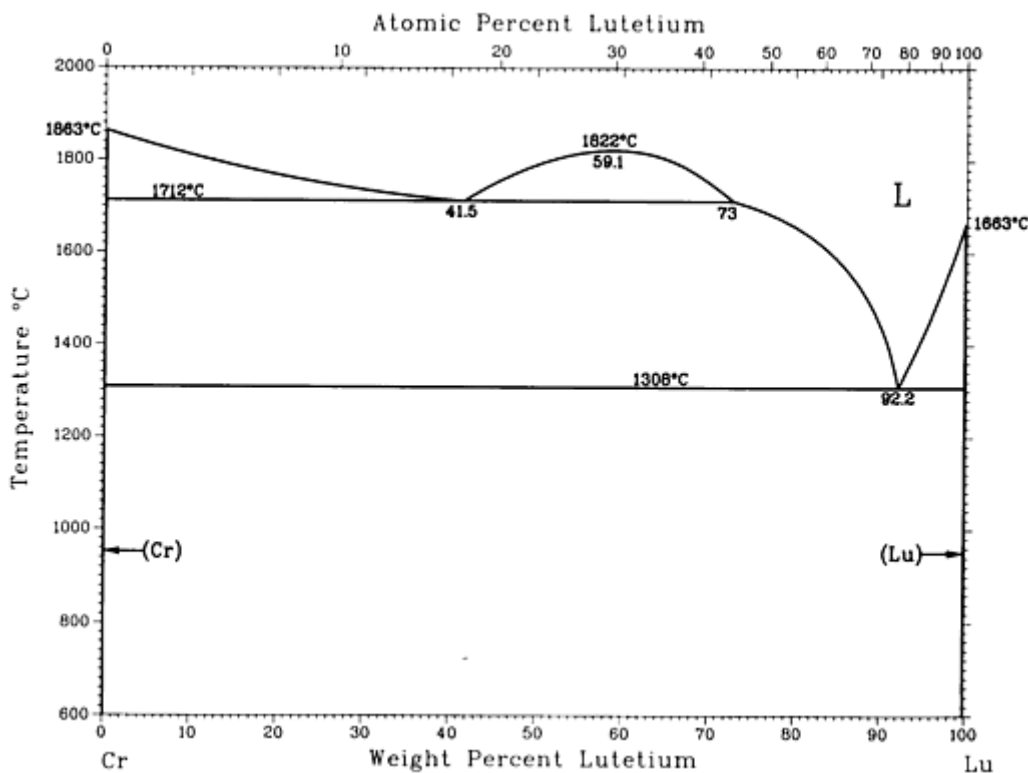

Cr-Lu phase diagram

Cr-Lu crystallographic data

Phase	Composition, wt% Lu	Pearson symbol	Space group

(Cr)	0	<i>cI2</i>	$Im\bar{3}m$
(Lu)	100	<i>hP2</i>	$P6_3/mmc$

Cr-Mn (Chromium - Manganese)

M. Venkatraman and J.P. Neumann, 1986

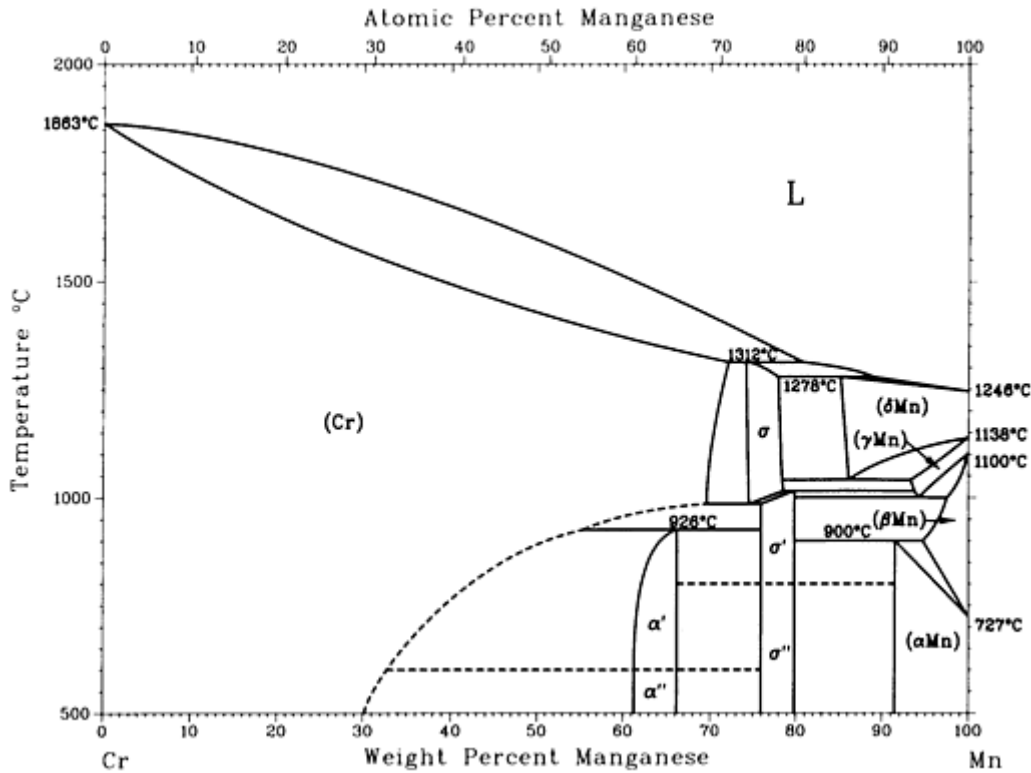

Cr-Mn phase diagram

Cr-Mn crystallographic data

Phase	Composition, wt% Mn	Pearson symbol	Space group
(Cr) ^(a)	0 to 72.5	<i>cI2</i>	$Im\bar{3}m$
α' (HT) ^(b)	61.5 to 66.5
α'' (LT) ^(c)	61.5 to 66.5
σ(HT) ^(d)	74 to 79	<i>tP30</i>	$P4_2/mmm$

σ' (MT) ^(e)	76 to 80	<i>tP30</i>	<i>P4₂/mmm</i>
σ'' (LT) ^(f)	76 to 80	<i>tP30</i>	<i>P4₂/mmm</i>
(δMn) ^(g)	86 to 100	<i>cI2</i>	<i>Im\bar{3}m</i>
(αMn) ^(h)	91 to 100	<i>cI58</i>	<i>I\bar{4}3m</i>
(γMn) ⁽ⁱ⁾	93 to 100	<i>cF4</i>	<i>Fm\bar{3}m</i>
(βMn) ^(j)	94 to 100	<i>cP20</i>	<i>P4₁32</i>
Metastable phases			
" (δMn) "	73 to 84	<i>cI2</i>	<i>Im\bar{3}m</i>
" (γMn) "	85 to 100	<i>tI2</i>	<i>I4/mmm</i>

(a) Below 1863 °C.

(b) From 600 to 926 °C.

(c) Below 600 °C.

(d) From 999 to 1312 °C.

(e) From \sim 800 to 1006 °C.

(f) Below \sim 800 °C.

(g) From 1140 to 1246 °C.

(h) Below 707 °C.

(i) From 1088 to 1140 °C.

(j) From 707 to 1088 °C

Cr-Mo (Chromium - Molybdenum)

M. Venkatraman and J.P. Neumann, 1987

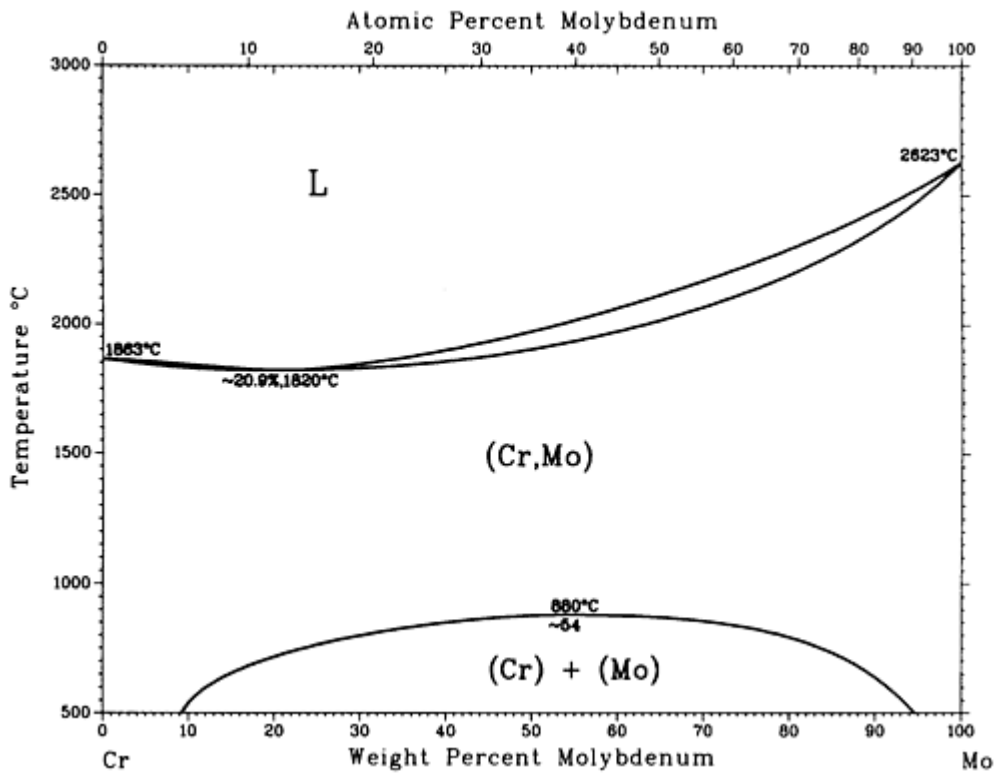

Cr-Mo phase diagram

Cr-Mo crystallographic data

Phase	Composition, wt% Mo	Pearson symbol	Space group
(Cr,Mo)	0 to 100	<i>cI2</i>	$Im\bar{3}m$

Cr-Nb (Chromium - Niobium)

M. Venkatraman and J.P. Neumann, 1986

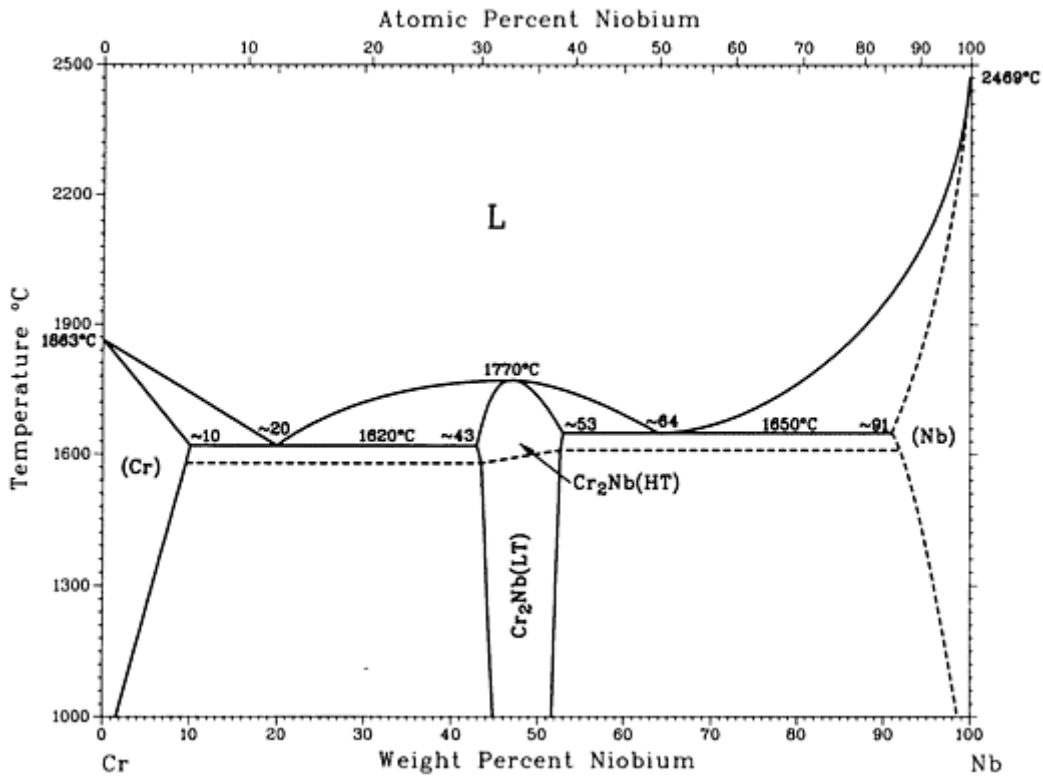

Cr-Nb phase diagram

Cr-Nb crystallographic data

Phase	Composition, wt% Nb	Pearson symbol	Space group
(Cr)	0 to ~10	<i>cI2</i>	$Im\bar{3}m$
Cr ₂ Nb (HT)	~43 to ~53	<i>hP12</i>	$P6_3/mmc$
Cr ₂ Nb (LT)	43 to 53	<i>cF24</i>	$Fd\bar{3}m$
(Nb)	~91 to 100	<i>cI2</i>	$Im\bar{3}m$

Cr-Ni (Chromium - Nickel)

P. Nash, 1991

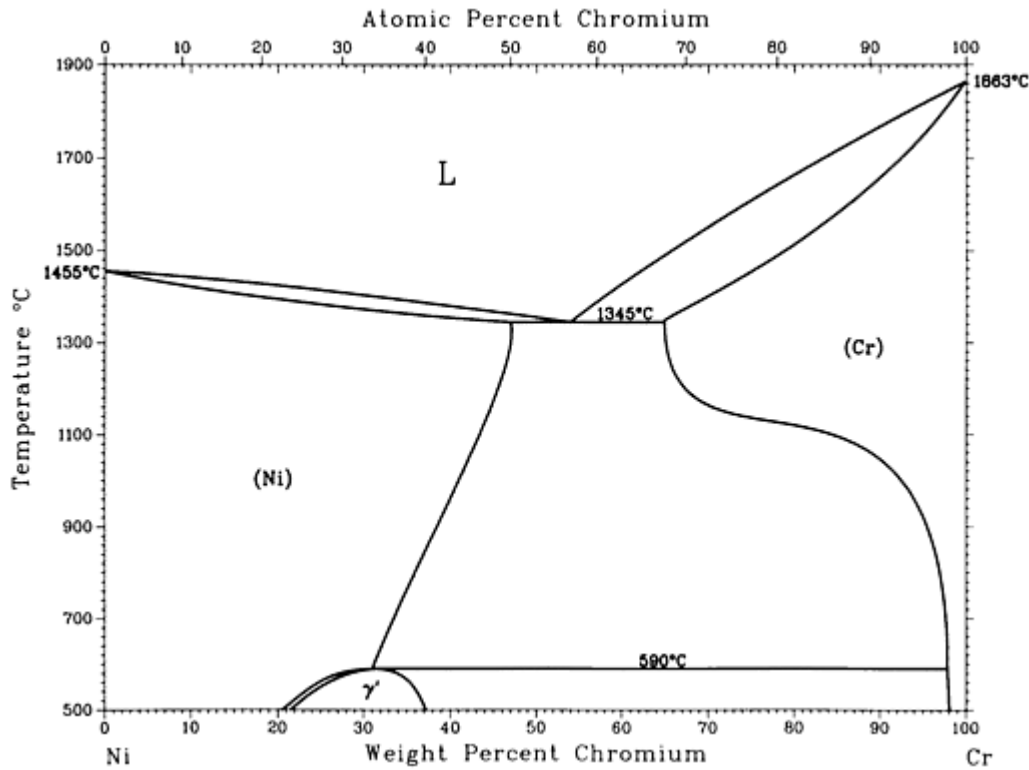

Cr-Ni phase diagram

Cr-Ni crystallographic data

Phase	Composition, wt% Cr	Pearson symbol	Space group
(Ni)	0 to 47.0	<i>cF4</i>	<i>Fm$\bar{3}m$</i>
Ni ₂ Cr or γ'	21 to 37	<i>oI6</i>	<i>Immm</i>
(Cr)	65 to 100	<i>cI2</i>	<i>Im$\bar{3}m$</i>
Metastable phases			
σ	~28	<i>tP30</i>	<i>P4₂/mnm</i>
δ	100	<i>cP8</i>	<i>Pm$\bar{3}m$</i>

Cr-O (Chromium - Oxygen)

C. Banik, T. Schmitt, P. Ettmayer, and B. Lux, 1980

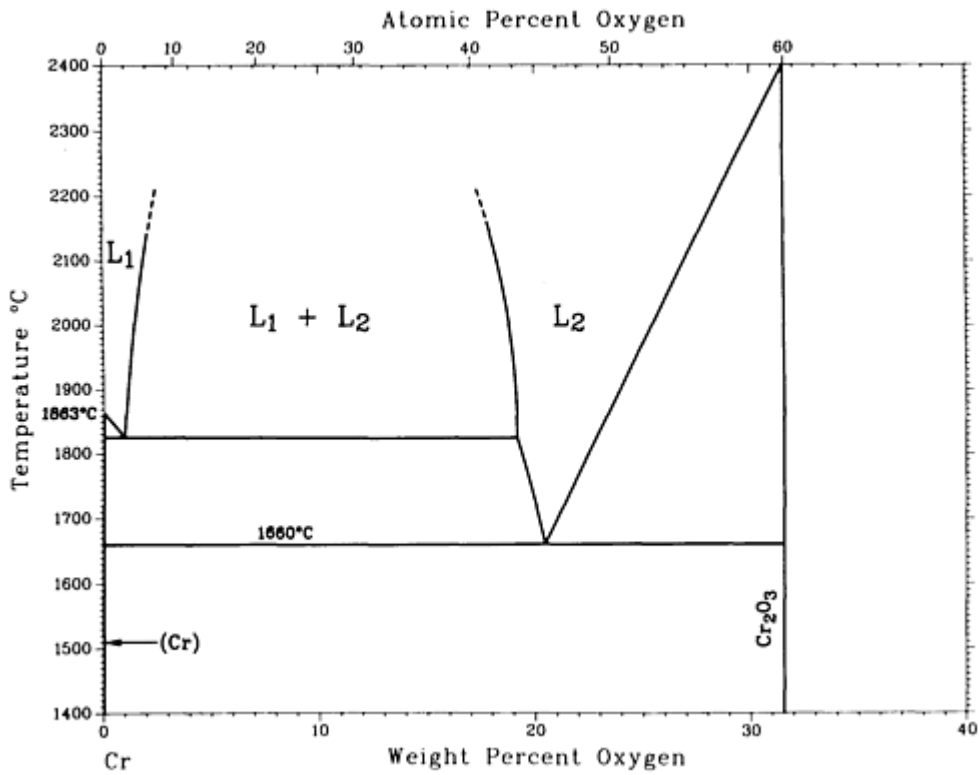

Cr-O phase diagram

Cr-O crystallographic data

Phase	Composition, wt% O	Pearson symbol	Space group
(Cr)	0	<i>cI2</i>	<i>Im</i> $\bar{3}m$
Cr ₃ O ₄ ^(a)	29.1	<i>tI28</i>	<i>I4₁/amd</i>
Cr ₂ O ₃	32	<i>hR10</i>	<i>R</i> $\bar{3}c$
CrO ₂	38.1	<i>tP6</i>	<i>P4₂/mmm</i>
Cr ₅ O ₁₂	42.5	<i>oP68</i>	<i>Pbcn</i>
Cr ₆ O ₁₅	43.4	<i>oC84</i>	<i>Cmcm</i>
CrO ₃	48	<i>oC16</i>	<i>Ama2</i>

(a) Metastable or high-pressure phase

Cr-Os (Chromium - Osmium)

M. Venkatraman and J.P. Neumann, 1990

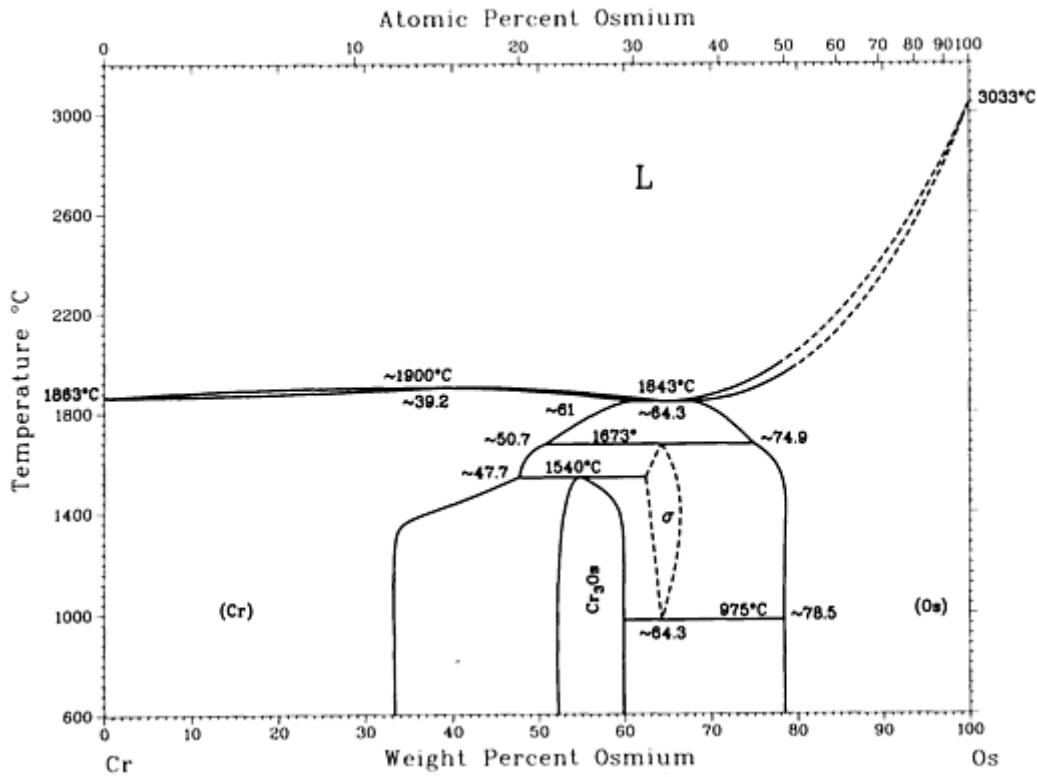

Cr-Os phase diagram

Cr-Os crystallographic data

Phase	Composition, wt% Os	Pearson symbol	Space group
(Cr) ^(a)	0 to ~61	<i>cI2</i>	<i>Im</i> $\bar{3}m$
Cr ₃ Os ^(b)	~52 to ~60	<i>cP8</i>	<i>Pm</i> $\bar{3}n$
σ ^(c)	~61 to ~81	<i>tP30</i>	<i>P4</i> ₂ / <i>mmn</i>
(Os) ^(d)	~66 to 100	<i>hP2</i>	<i>P6</i> ₃ / <i>mmc</i>

(a) Below 1900 °C.

(b) Below 1540 °C.

(c) 975 to 1673 °C.

(d) Below 3033 °C

Cr-Pd (Chromium - Palladium)

M. Venkatraman and J.P. Neumann, 1990

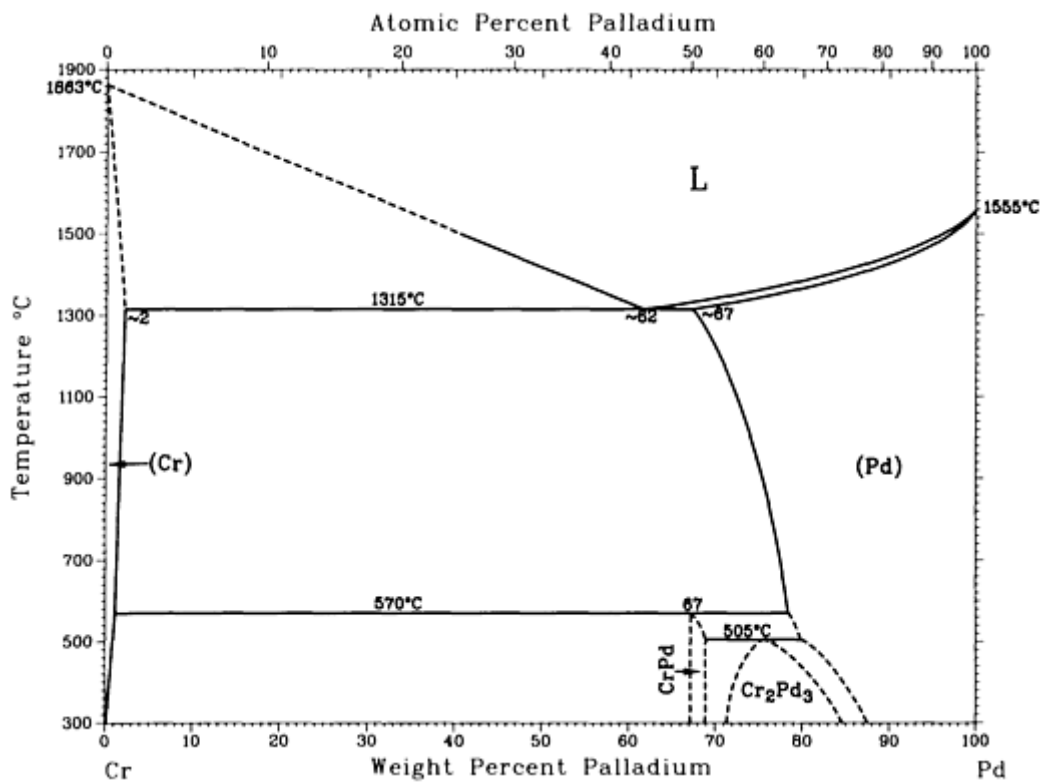

Cr-Pd phase diagram

Cr-Pd crystallographic data

Phase	Composition, wt% Pd	Pearson symbol	Space group
(Cr)	0 to ~2	<i>cI2</i>	<i>Im</i> $\bar{3}m$
CrPd	67 to ~69	<i>tP2</i>	<i>P4/mmm</i>
Cr ₂ Pd ₃	~71 to ~86	<i>cP4</i>	<i>Pm</i> $\bar{3}m$

(Pd) ~67 to 100 *cF4* $Fm\bar{3}m$

Cr-Pt (Chromium - Platinum)

M. Venkatraman and J.P. Neumann, 1990

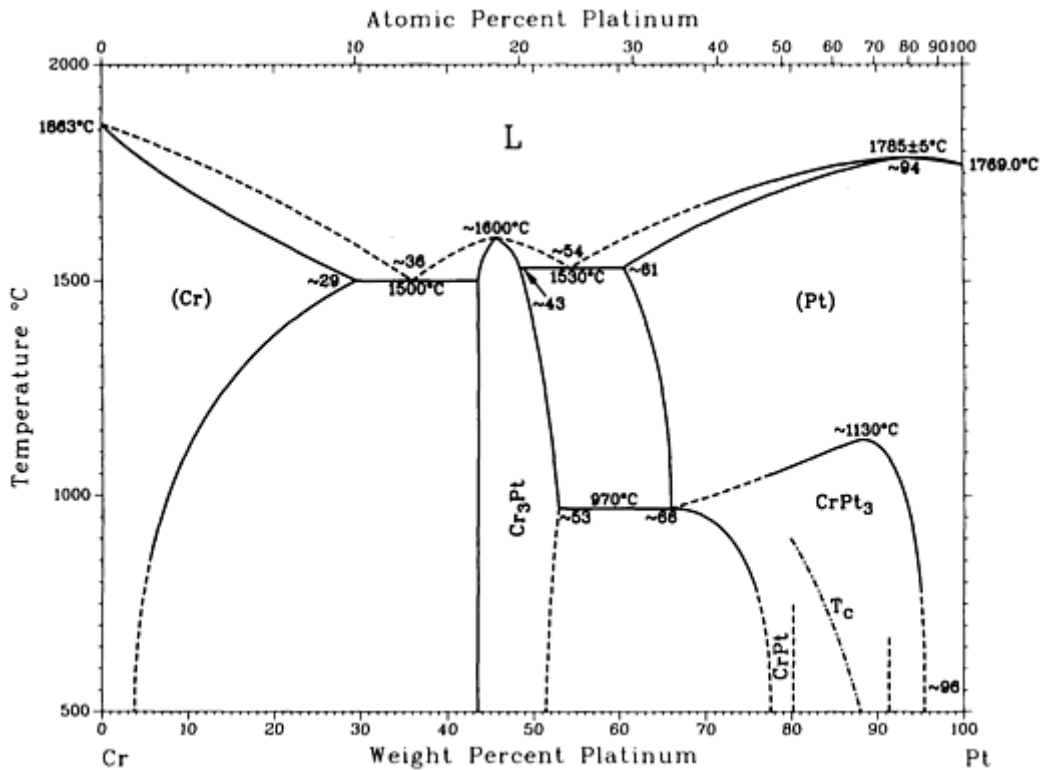

Cr-Pt phase diagram

Cr-Pt crystallographic data

Phase	Composition, wt% Pt	Pearson symbol	Space group
(Cr)	0 to ~29	<i>cI2</i>	$Im\bar{3}m$
Cr ₃ Pt	44 to ~53	<i>cP8</i>	$Pm\bar{3}n$
CrPt	~78 to ~80	<i>tP2</i>	$P4/mmm$
CrPt ₃	~66 to 96	<i>cP4</i>	$Pm\bar{3}m$
(Pt)	~61 to 100	<i>cF4</i>	$Fm\bar{3}m$

Cr-Re (Chromium - Rhenium)

M. Venkatraman and J.P. Neumann, 1987

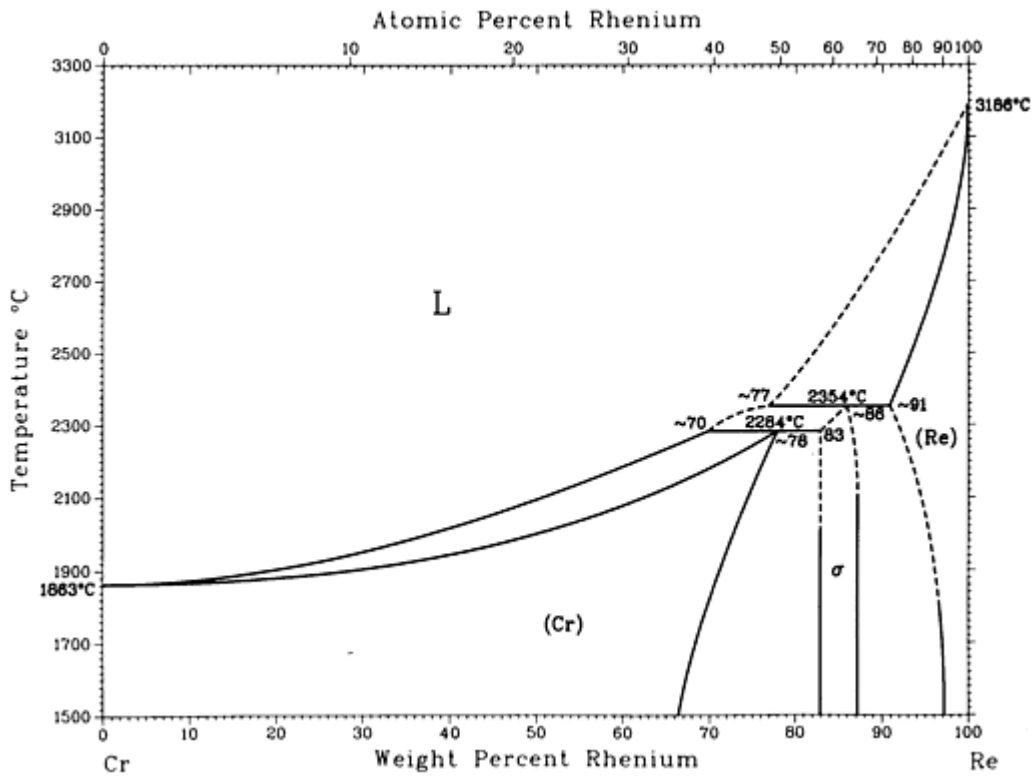

Cr-Re phase diagram

Cr-Re crystallographic data

Phase	Composition, wt% Re	Pearson symbol	Space group
(Cr)	0 to ~78	<i>cI2</i>	<i>Im</i> $\bar{3}m$
σ (Cr ₂ Re ₃)	83 to 87	<i>tP30</i>	<i>P4</i> ₂ / <i>mmm</i>
(Re)	~91 to 100	<i>hP2</i>	<i>P6</i> ₃ / <i>mmc</i>

Cr-Rh (Chromium - Rhodium)

M. Venkatraman and J.P. Neumann, 1987

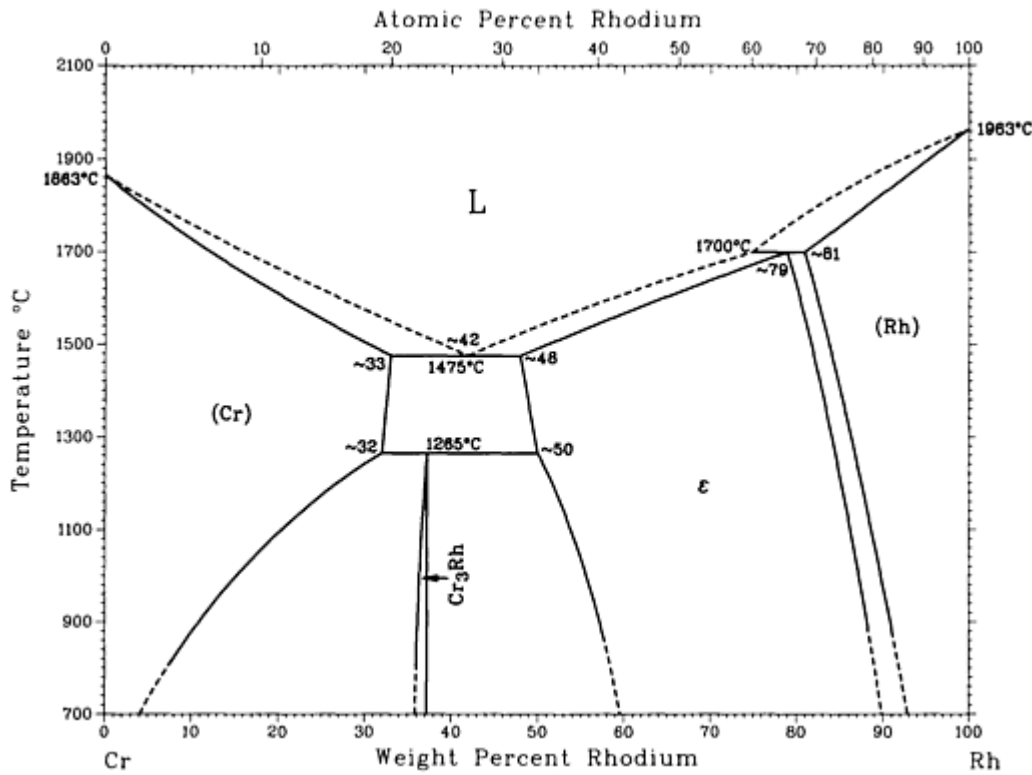

Cr-Rh phase diagram

Cr-Rh crystallographic data

Phase	Composition, wt% Rh	Pearson symbol	Space group
(Cr)	0 to ~33	<i>cI2</i>	$Im\bar{3}m$
Cr ₃ Rh	36 to 37	<i>cP8</i>	$Pm\bar{3}n$
ε	~48 to 81	<i>hP2</i>	$P6_3/mmc$
(Rh)	~81 to 100	<i>cF4</i>	$Fm\bar{3}m$

Cr-Ru Chromium - Ruthenium

M. Venkatraman and J.P. Neumann, 1987

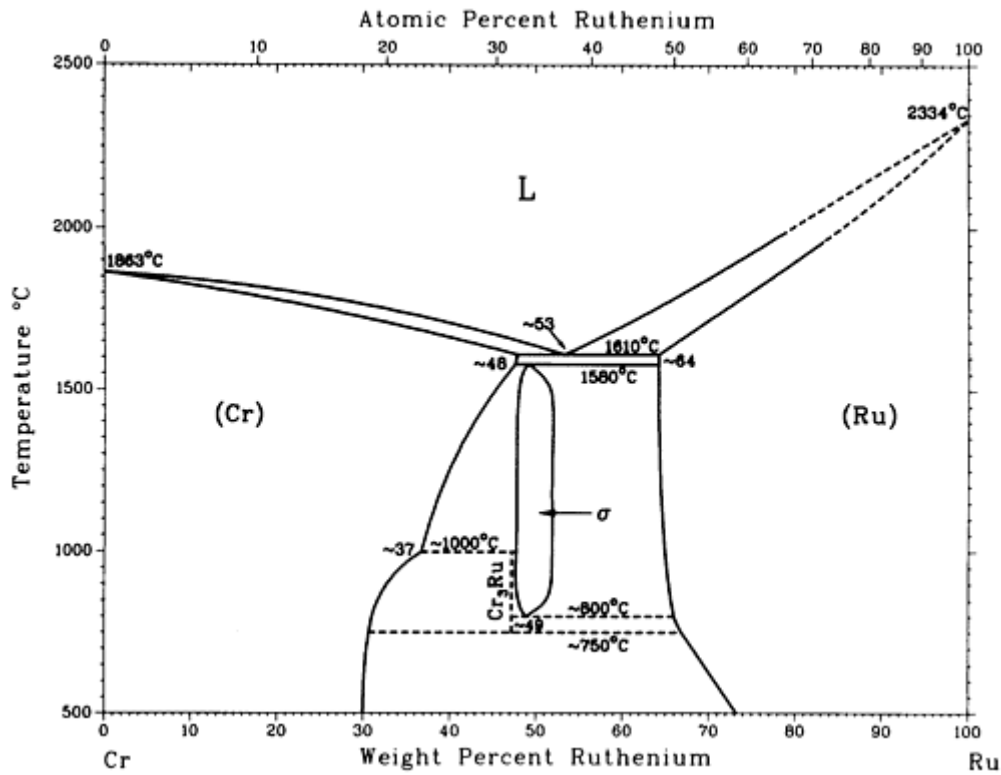

Cr-Ru phase diagram

Cr-Ru crystallographic data

Phase	Composition, wt% Ru	Pearson symbol	Space group
(Cr) ^(a)	0 to ~48	<i>cI2</i>	<i>Im</i> $\bar{3}m$
Cr_3Ru ^(b)	47.2	<i>cP8</i>	<i>Pm</i> $\bar{3}n$
$\sigma\text{Cr}_2\text{Ru}$ ^(c)	48 to 52	<i>tP30</i>	<i>P4</i> ₂ / <i>mnm</i>
(Ru) ^(d)	~64 to 100	<i>hP2</i>	<i>P6</i> ₃ / <i>mmc</i>

(a) Stable below 1863 °C.

(b) Stable from 750 to 1000 °C; might be located at ~39.3 wt%, instead.

(c) Stable from 800 to 1580 °C.

(d) Stable below 2334 °C

Cr-S(Chromium - Sulfur)

M. Venkatraman and J.P. Neumann, unpublished

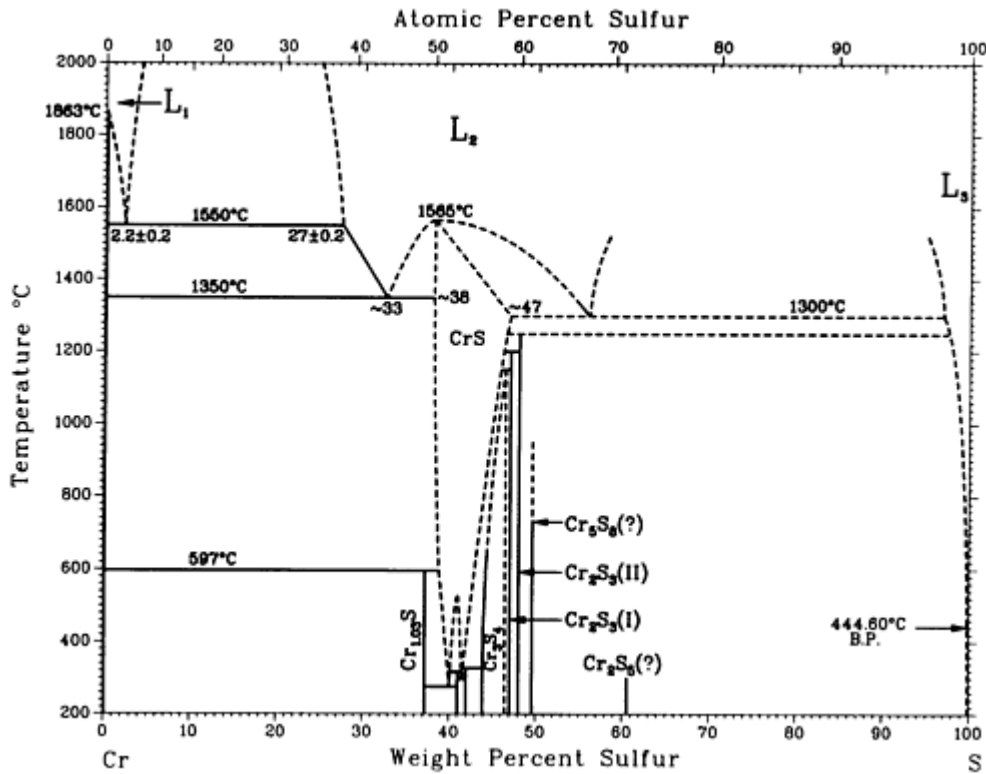

Cr-S phase diagram

Cr-S crystallographic data

Phase	Composition, wt% S	Pearson symbol	Space group
(Cr)	0 to ~0.001	<i>cI2</i>	$Im\bar{3}m$
Cr _{1.03} S	~37.5	<i>mC8</i>	<i>C2/c</i>
CrS	~38 to ~47	<i>hP4</i>	$P6_3/mmc$
Cr ₇ S ₈	41.2 to 41.5	<i>hP4</i>	$P\bar{3}m1$
Cr ₅ S ₆	~42	<i>hP22</i>	$P\bar{3}1c$

Cr_3S_4	44 to ~ 46.2	$mC14$	$C2/m$
$\text{Cr}_2\text{S}_3(\text{I})$	46.5 to 47.5	$hP20$	$P\bar{3}1c$
$\text{Cr}_2\text{S}_3(\text{II})$	47.8 to 48.7	$hR10$	$R\bar{3}$
$\text{Cr}_5\text{S}_8^{(a)}$	49.6	mC^*	$C2/m$
$\text{Cr}_2\text{S}_5(?)$	60.6	^(b)	...

(a) High-pressure phase.

(b) Unknown

Cr-Sb (Chromium - Antimony)

H. Okamoto, 1992

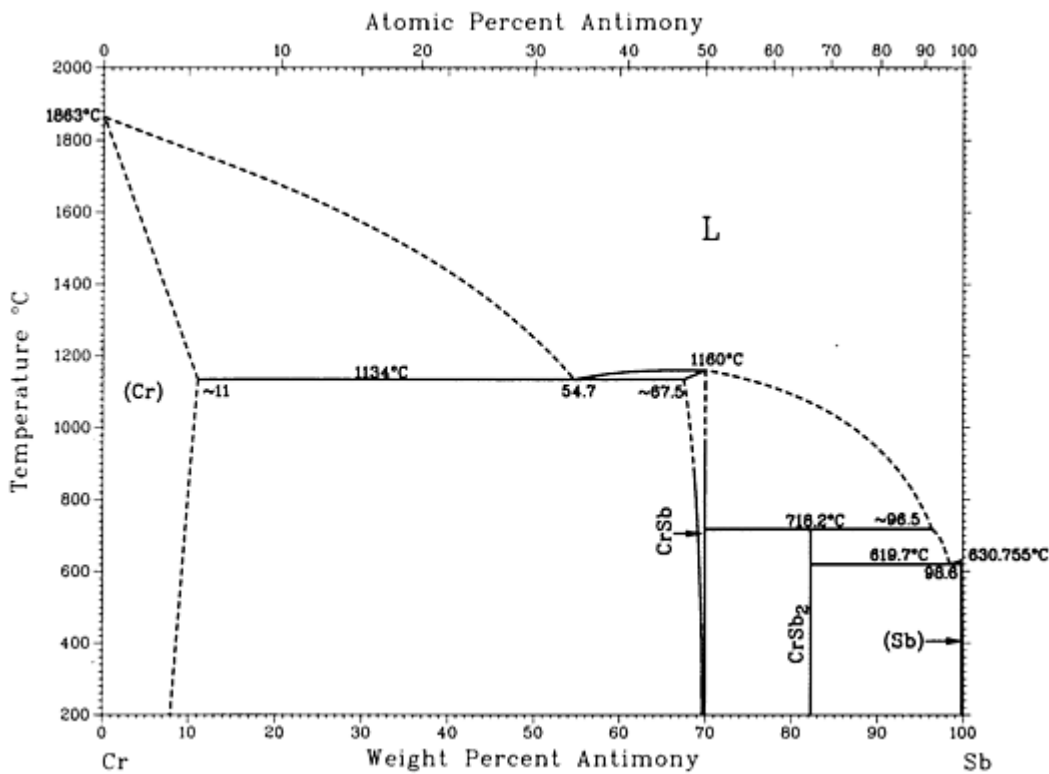

Cr-Re phase diagram

Cr-Sb crystallographic data

Phase	Composition, wt% Sb	Pearson symbol	Space group
(Cr)	0 to ~11	<i>cI2</i>	$Im\bar{3}m$
CrSb	~67.5 to 70.1	<i>hP4</i>	$P6_3/mmc$
CrSb ₂	82.4	<i>oP6</i>	$Pn\bar{3}m$
(Sb)	100	<i>hR2</i>	$R\bar{3}m$

Cr-Sc (Chromium - Scandium)

M. Venkatraman and J.P. Neumann, 1985

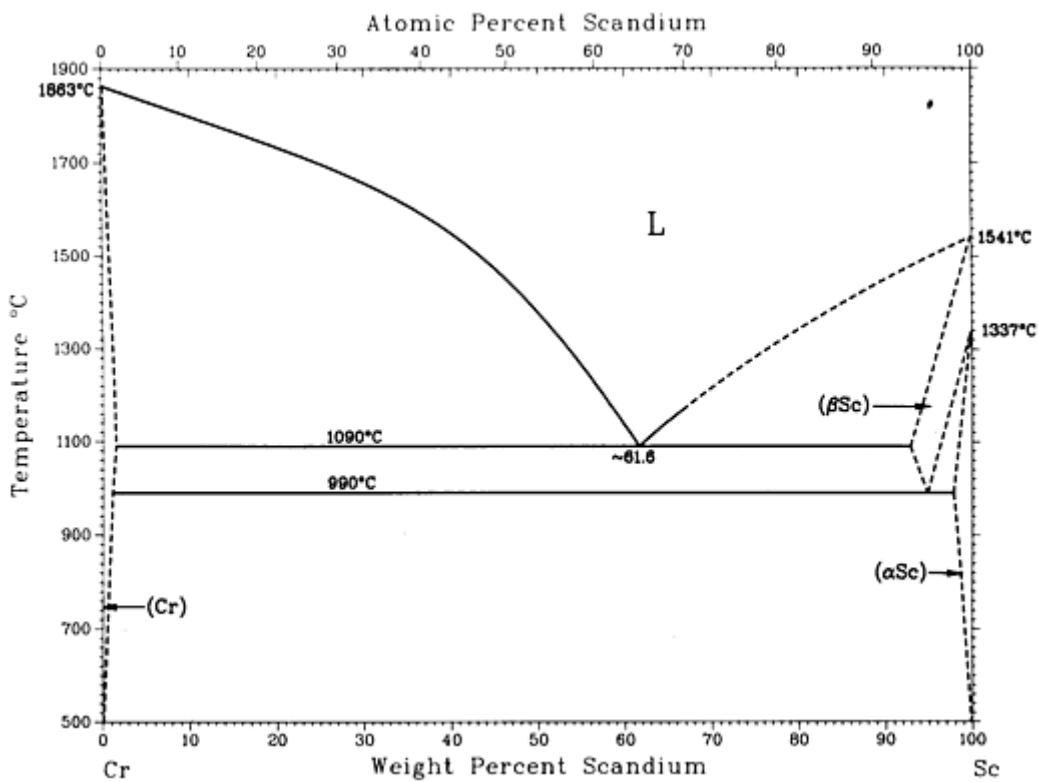

Cr-Sc phase diagram

Cr-Sc crystallographic data

Phase	Composition, wt% Sc	Pearson symbol	Space group
(Cr)	0 to <0.09	<i>cI2</i>	$Im\bar{3}m$

(βSe)	>89 to 100	$cI2$	$Im\bar{3}m$
(αSe)	~ 100	$hP2$	$P6_3/mmc$
Metastable phase			
$\text{Cr}_{0.85}\text{Sc}_{2.15}\text{B}_x$	~ 69.0	$cF112$	$Fd\bar{3}m$

Cr-Se (Chromium - Selenium)

M. Venkatraman and J.P. Neumann, unpublished

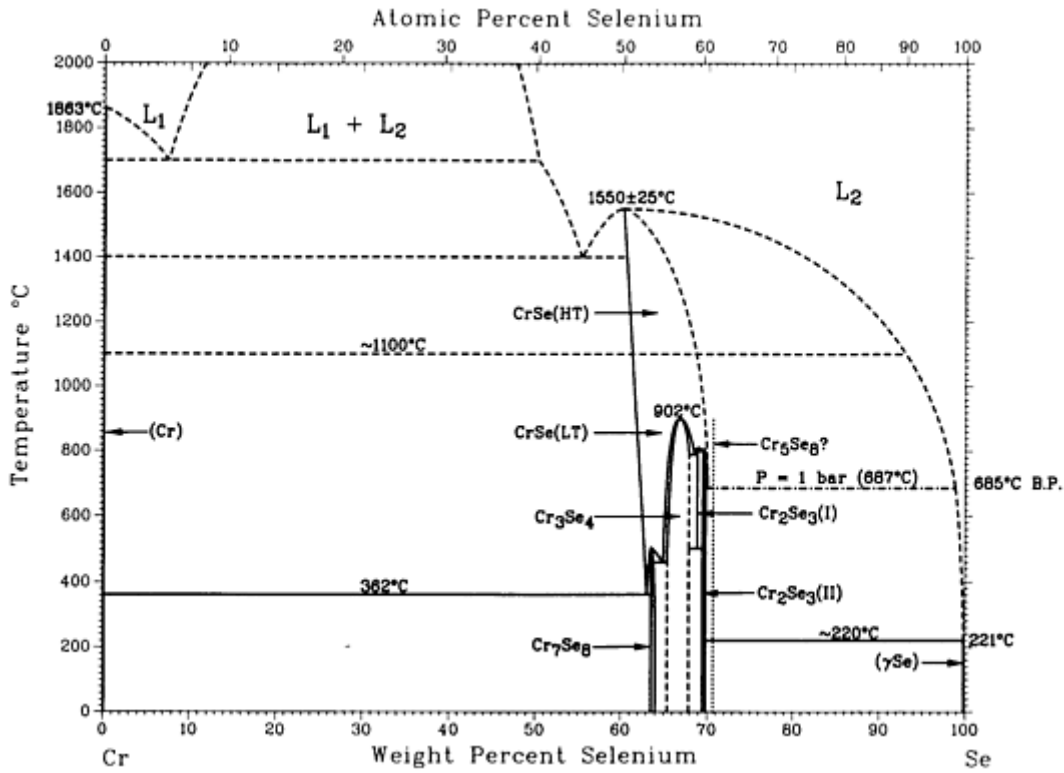

Cr-Se phase diagram

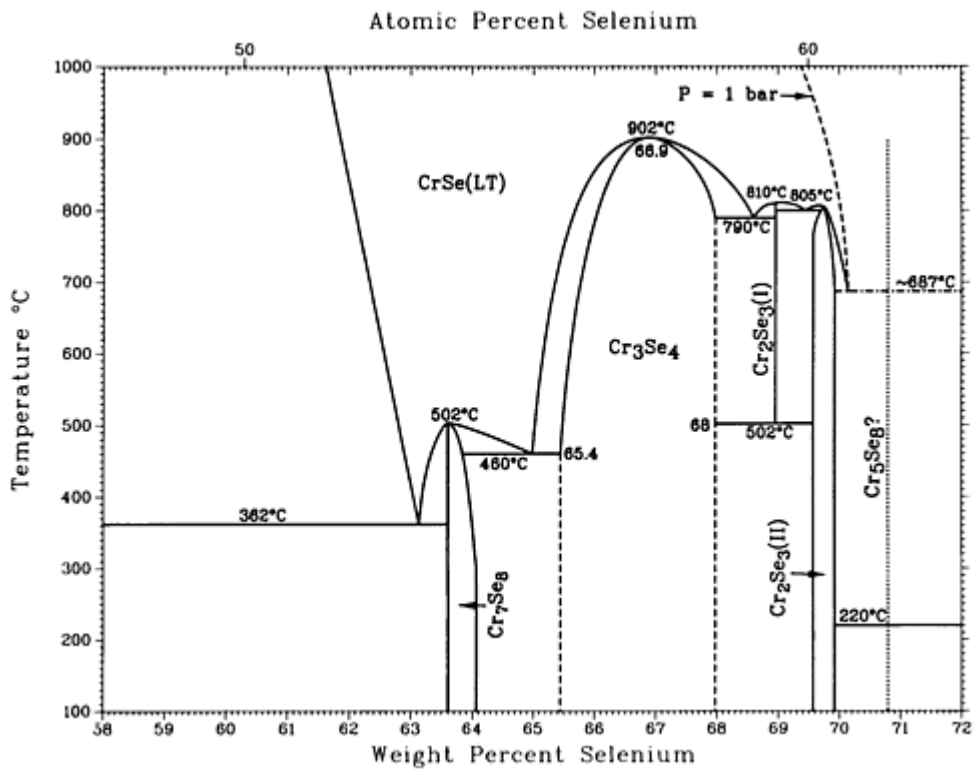

Detailed view of the Cr-Se phase diagram in the region 59.9 to 70.5 wt% Se.

Cr-Se crystallographic data

Phase	Composition, wt% Se	Pearson symbol	Space group
(Cr)	~0	<i>cI2</i>	<i>Im</i> $\bar{3}m$
CrSe(HT)	60.3 to ~69.5	<i>hP4</i>	<i>P6</i> ₃ / <i>mmc</i>
CrSe(LT)	~61 to ~69.9	<i>hP4</i>	<i>P</i> $\bar{3}m1$
Cr ₇ Se ₈	63.6 to 64.1	<i>mF60</i>	<i>F2/m</i>
Cr ₃ Se ₄	65.4 to 68.0	<i>mI14</i>	<i>I2/m</i>
Cr ₂ Se ₃ (I)	~69.0	<i>hP20</i>	<i>P</i> $\bar{3}1c$
Cr ₂ Se ₃ (II)	69.3 to 69.7	<i>hR10</i>	<i>R</i> $\bar{3}$
Cr ₂ Se ₃ (III) ^(a)	69.9 to 70.4	<i>mI15</i>	<i>I2/m</i>

$\text{Cr}_5\text{Se}_8^{(b)}$	70.8	<i>mF52</i>	<i>F2/m</i>
$\text{CrSe}_2^{(a)}$	75.3	<i>hP3</i>	$P\bar{3}m1$
(γ Se)	~ 100	<i>hP3</i>	<i>P3_121</i>

(a) Metastable.

(b) Stable at high pressure

Cr-Si (Chromium - Silicon)

A.B. Gokhale and G.J. Abbaschian, 1987

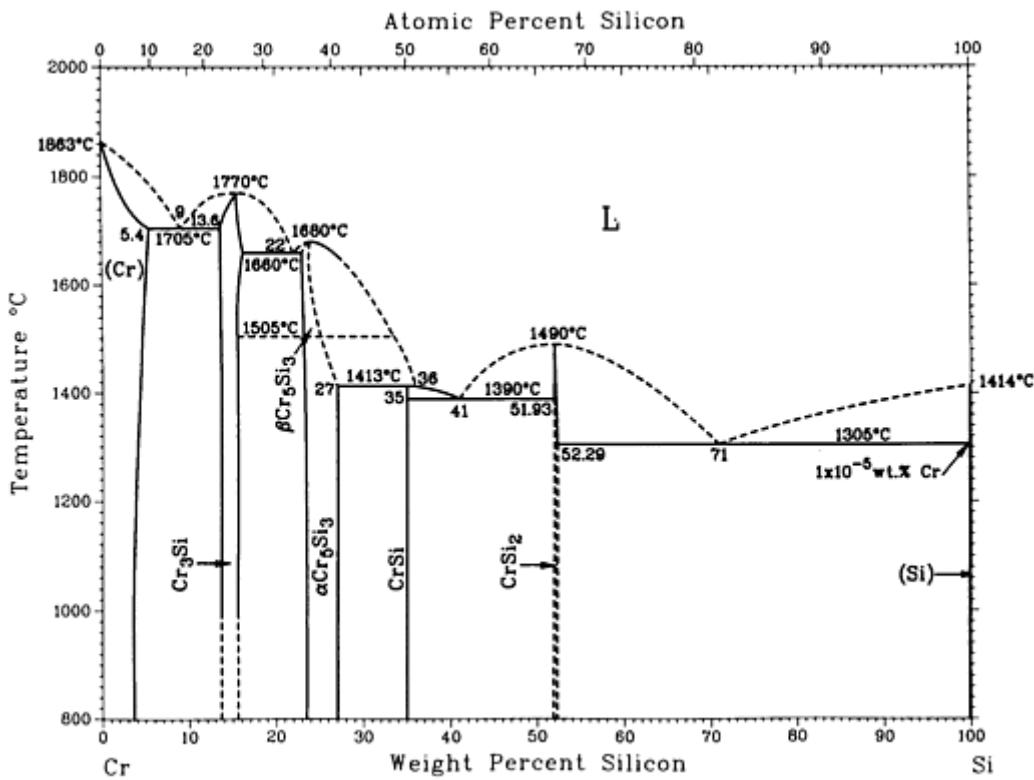

Cr-Si phase diagram

Cr-Si crystallographic data

Phase	Composition, wt% Si	Pearson symbol	Space group
(Cr)	0 to 5.4	<i>cI2</i>	$Im\bar{3}m$

Cr_3Si	13.6 to 16.2	<i>cP8</i>	$Pm\bar{3}n$
$\alpha\text{Cr}_5\text{Si}_3$	23 to 27	<i>tI38</i>	$I4/mcm$
CrSi	35	<i>cP8</i>	$P2_13$
CrSi_2	51.9 to 52.29	<i>hP9</i>	$P6_222$
(Si)	~ 100	<i>cF8</i>	$Fd\bar{3}m$

Cr-Sn (Chromium - Tin)

M. Venkatraman and J.P. Neumann, 1988

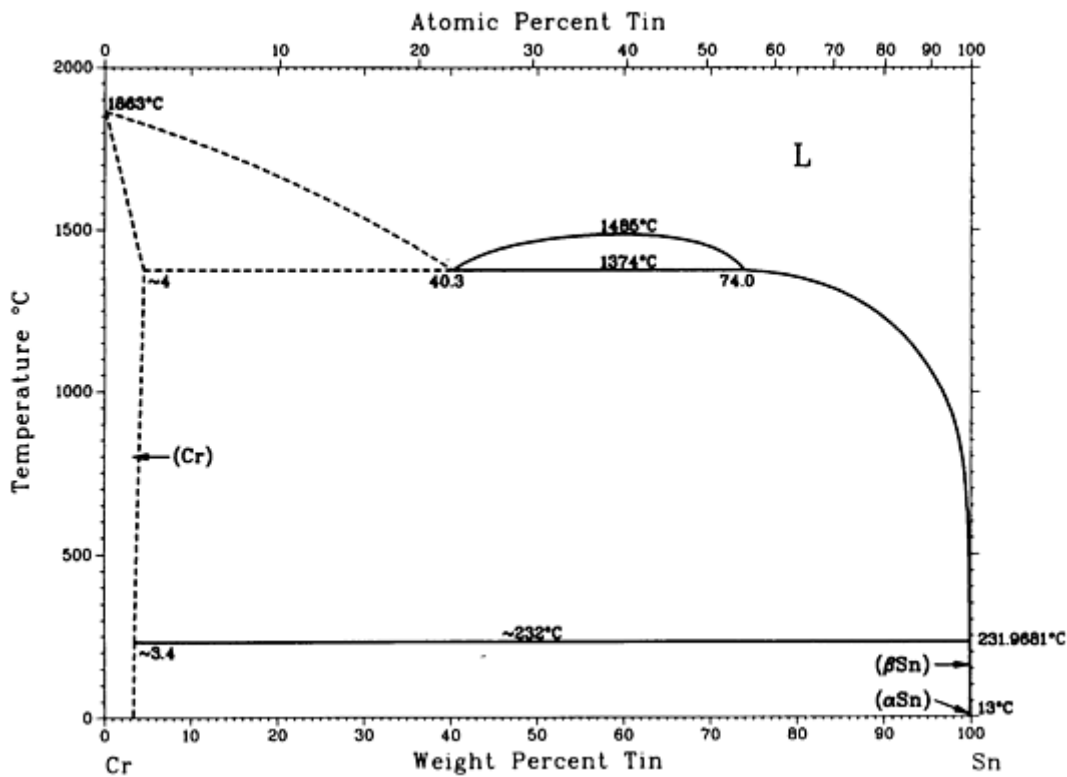

Cr-Sn phase diagram

Cr-Sn crystallographic data

Phase	Composition, wt% Sn	Pearson symbol	Space group
(Cr)	0 to ~ 4	<i>cI2</i>	$Im\bar{3}m$

(βSn)	~ 100	$tI4$	$I4_1/amd$
(αSn)	~ 100	$cF8$	$Fd\bar{3}m$
Metastable phase			
Cr_2Sn_3	77 to 78	$oF48$	$Fddd$

Cr-Ta (Chromium - Tantalum)

M. Venkatraman and J.P. Neumann, 1987

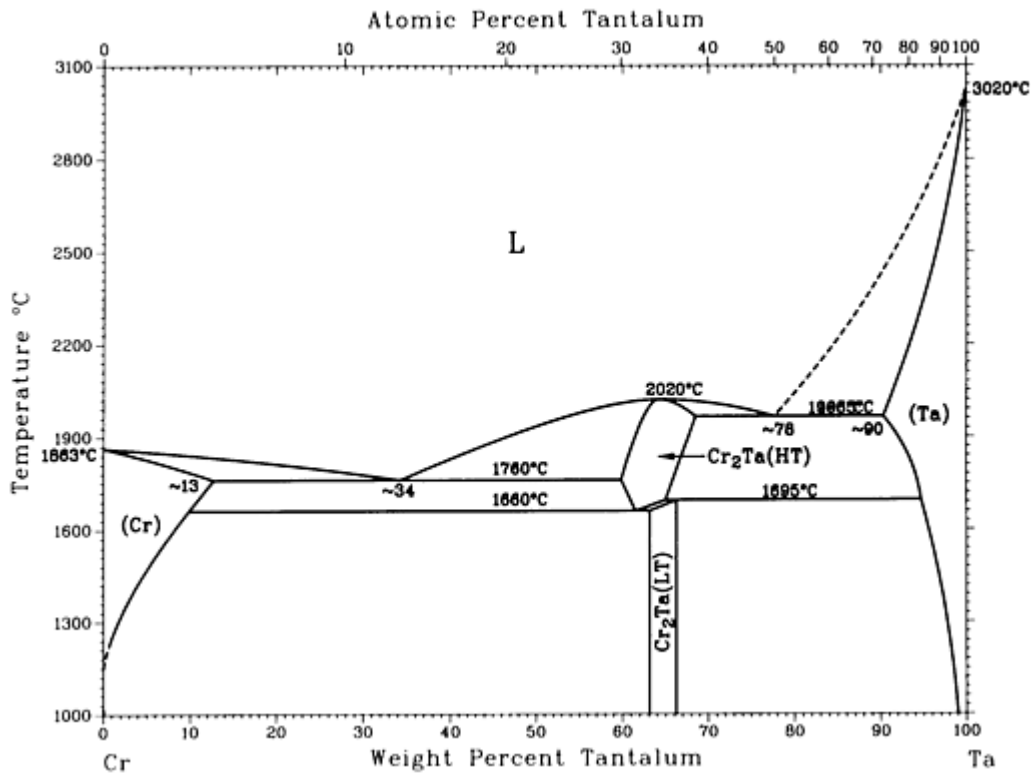

Cr-Ta phase diagram

Cr-Ta crystallographic data

Phase	Composition, wt% Ta	Pearson symbol	Space group
(Cr)	0 to ~ 13	$cI2$	$Im\bar{3}m$
$\text{Cr}_2\text{Ta(HT)}$	60 to 68	$hP12$	$P6_3/mmc$

$\text{Cr}_2\text{Ta}(\text{LT})$	63 to 66	$cF24$	$Fd\bar{3}m$
(Ta)	~ 90 to 100	$cI2$	$Im\bar{3}m$

Cr-Te (Chromium - Tellurium)

M. Venkatraman and J.P. Neumann, unpublished

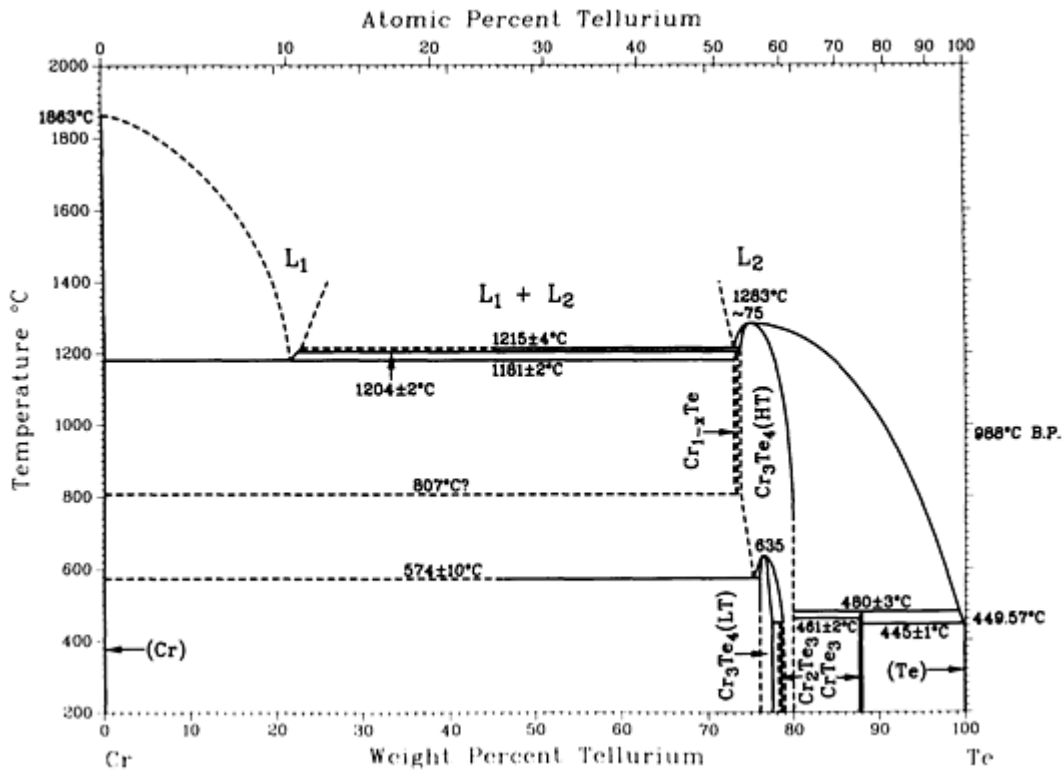

Cr-Te phase diagram

Cr-Te crystallographic data

Phase	Composition wt% Te	Pearson symbol	Space group
(Cr)	~ 0	$cI2$	$Im\bar{3}m$
Cr_{1-x}Te	73.1 to 73.8	$hP4$	$P6_3/mmc$
$\text{Cr}_3\text{Te}_4(\text{HT})$	~ 73.9 to ~ 80.0	$mC14$	$C2/m$
$\text{Cr}_3\text{Te}_4(\text{LT})$	~ 76 to 77.5

$\text{Cr}_5\text{Te}_8\text{-I}^{(a)}$	78.4 to \sim 78.9	<i>mC26</i>	<i>C2/m</i>
$\text{Cr}_5\text{Te}_8\text{-II}^{(a)}$	\sim 79.7 to \sim 80.0	...	$P\bar{3}c1$ (?)
Cr_2Te_3	78.3 to 78.6	<i>hP20</i>	$P\bar{3}1c$
CrTe_3	\sim 88	<i>mP32</i>	$P2_1/c$
(Te)	\sim 100	<i>hP3</i>	$P3_121$

(a) Not shown in diagram

Cr-Ti (Chromium - Titanium)

J.L. Murray, 1987

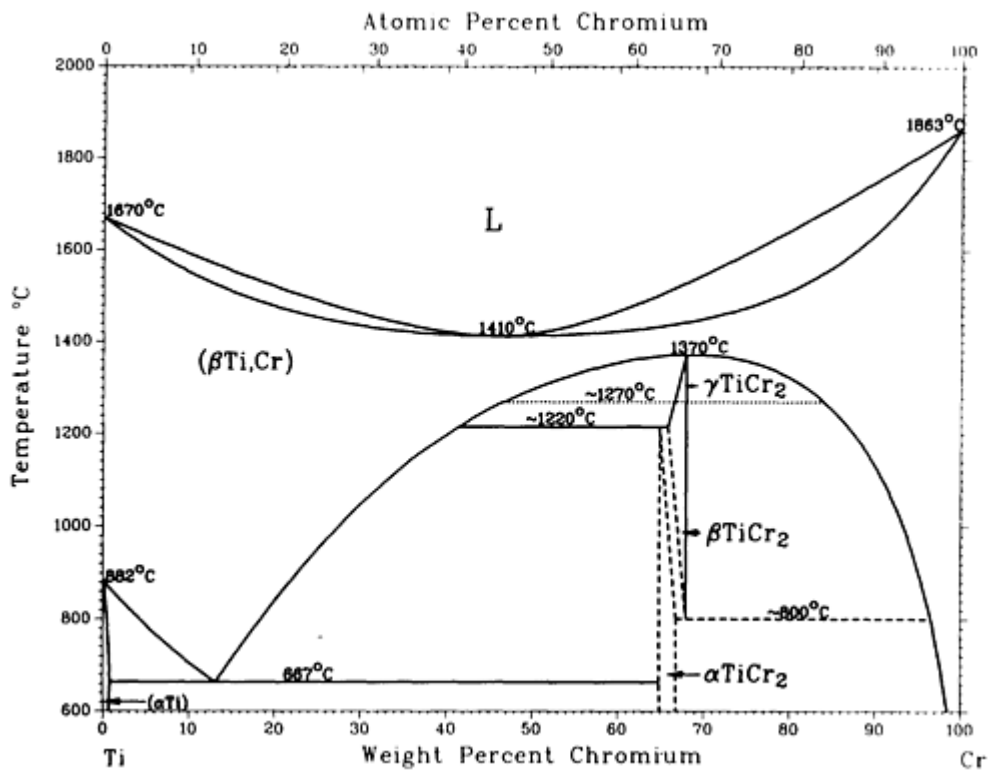

Cr-Ti phase diagram

Cr-Ti crystallographic data

Phase	Composition wt% Cr	Pearson symbol	Space group
-------	-----------------------	-------------------	----------------

$(\beta\text{Ti,Cr})$	0 to 100	$cI2$	$Im\bar{3}m$
(αTi)	0 to 0.2	$hP2$	$P6_3/mmc$
αTiCr_2	65 to 67	$cF24$	$Fd\bar{3}m$
βTiCr_2	66 to 68	$hP12$	$P6_3/mmc$
γTiCr_2	66 to 68	$hP24$	$P6_3/mmc$
Metastable phase			
ω	...	$hP3$	$P\bar{3}m1$

Cr-U (Chromium - Uranium)

M. Venkatraman, J.P. Neumann, and D.E. Peterson, 1985

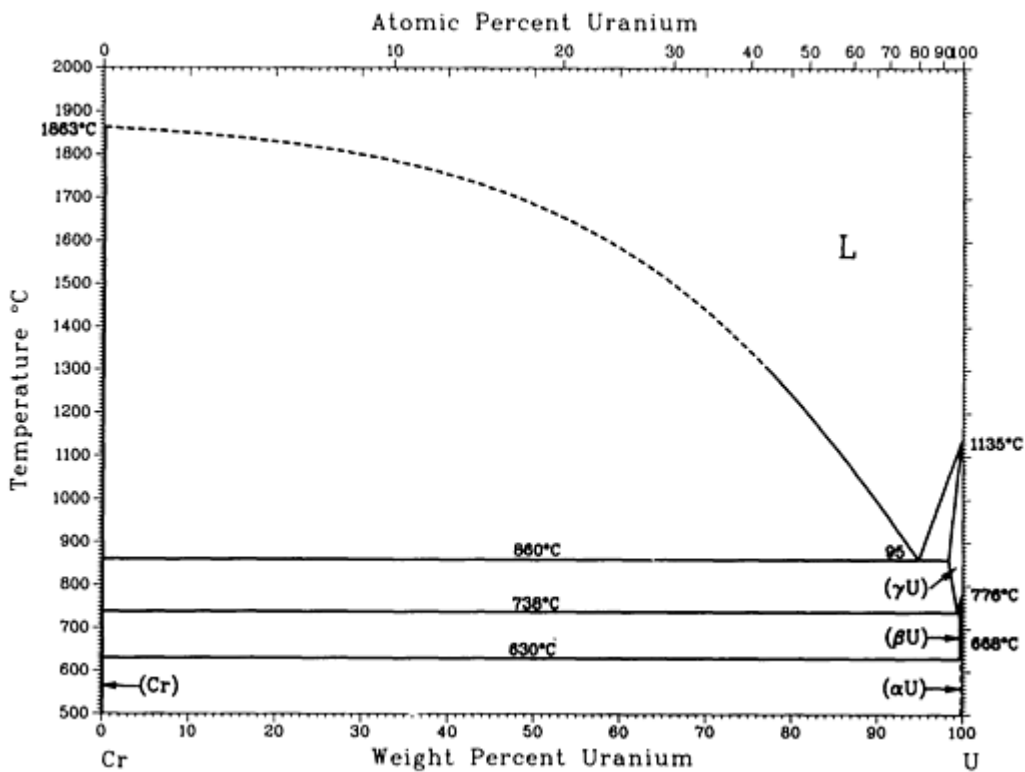

Cr-U phase diagram

Cr-U crystallographic data

Phase	Composition wt% U	Pearson symbol	Space group
(Cr) ^(a)	~0	<i>cI2</i>	<i>Im$\bar{3}m$</i>
(γ U) ^(b)	99 to 100	<i>cI2</i>	<i>Im$\bar{3}m$</i>
(β U) ^(c)	99.8 to 100	<i>tP30</i>	<i>P4₂/mnm</i>
(α U) ^(d)	~100	<i>oC4</i>	<i>Cmcm</i>

(a) Stable below 1863 °C.

(b) Stable from 775 to 1135 °C.

(c) Stable from 668 to 775 °C.

(d) Stable below 668 °C

Cr-V (Chromium - Vanadium)

J.F. Smith, 1989

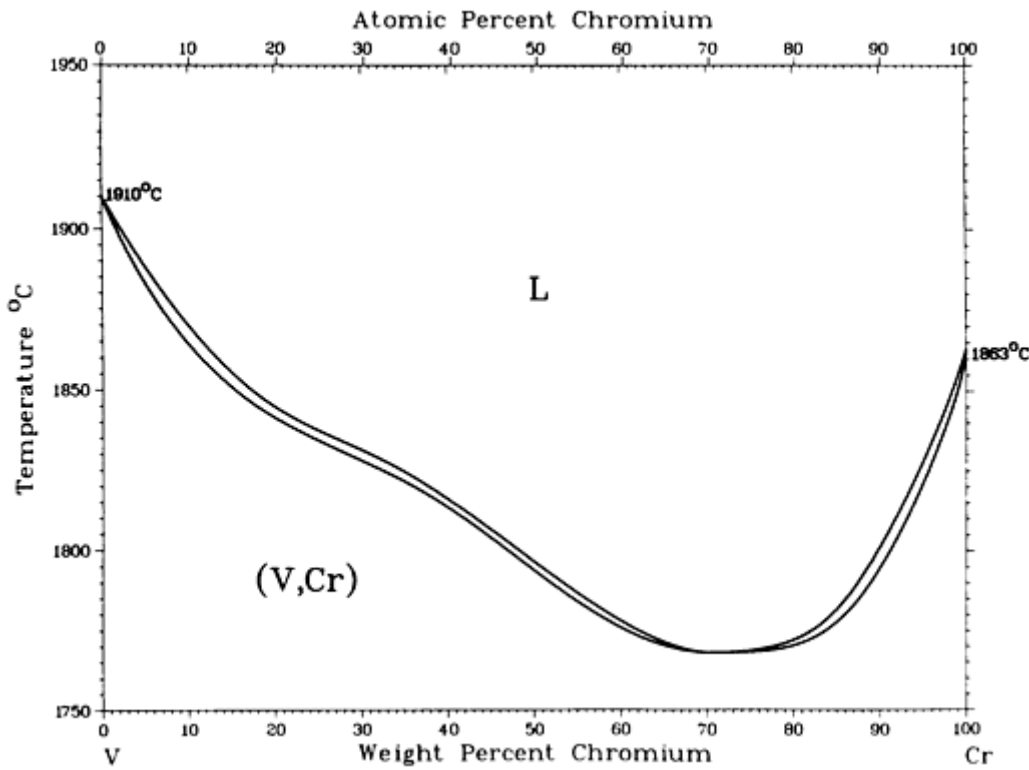

Cr-V phase diagram

Cr-V crystallographic data

Phase	Composition wt% Cr	Pearson symbol	Space group
(V,Cr)	0 to 100	<i>cI2</i>	$Im\bar{3}m$

Cr-W (Chromium - Tungsten)

S.V. Nagender Naidu, A.M. Sriramamurthy, and P. Rama Rao, 1984

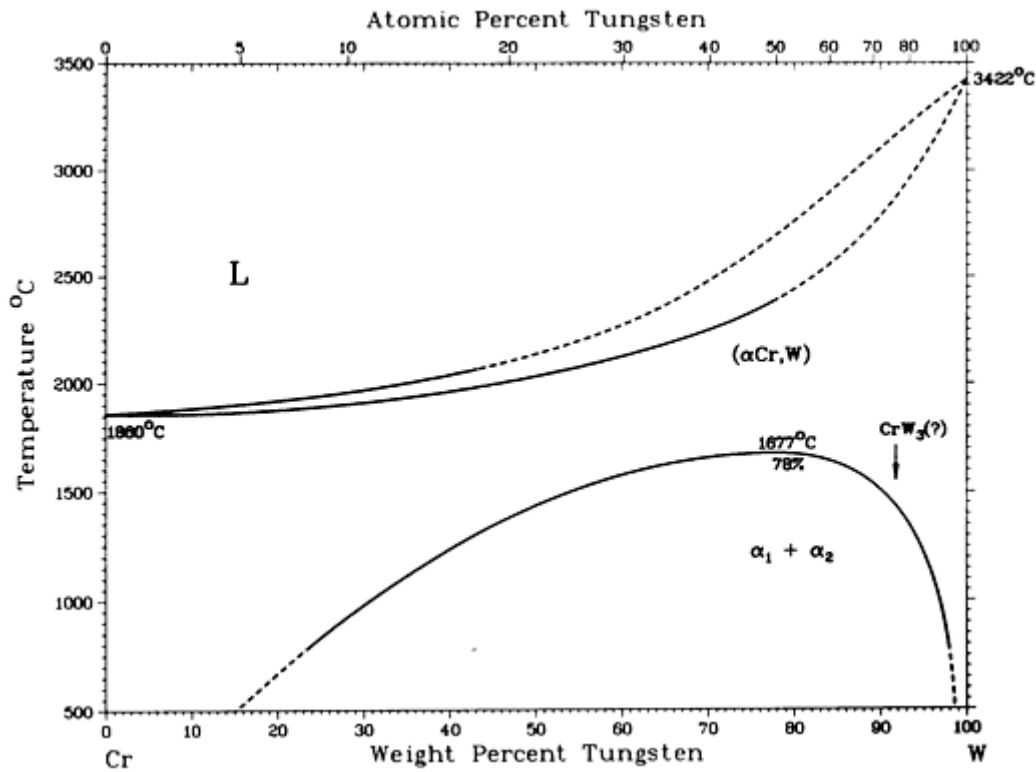

Cr-W phase diagram

Cr-W crystallographic data

Phase	Composition wt% W	Pearson symbol	Space group
(βCr) ^(a)	0	cF4	$Fm\bar{3}m$
(γCr) ^(b)	0	cI58	$I\bar{4}3m$
(δCr)	0	cP8	$Pm\bar{3}n$
(εCr)	0	hP2	$P6_3/mmc$
(αCr,W)	0 to 100	cI2	$Im\bar{3}m$
CrW ₃ (?)	91	tI*	...

(a) Above 1840 °C.

(b) Electrolytic

Cr-Zr (Chromium - Zirconium)

D. Arias and J.P. Abriata, 1986

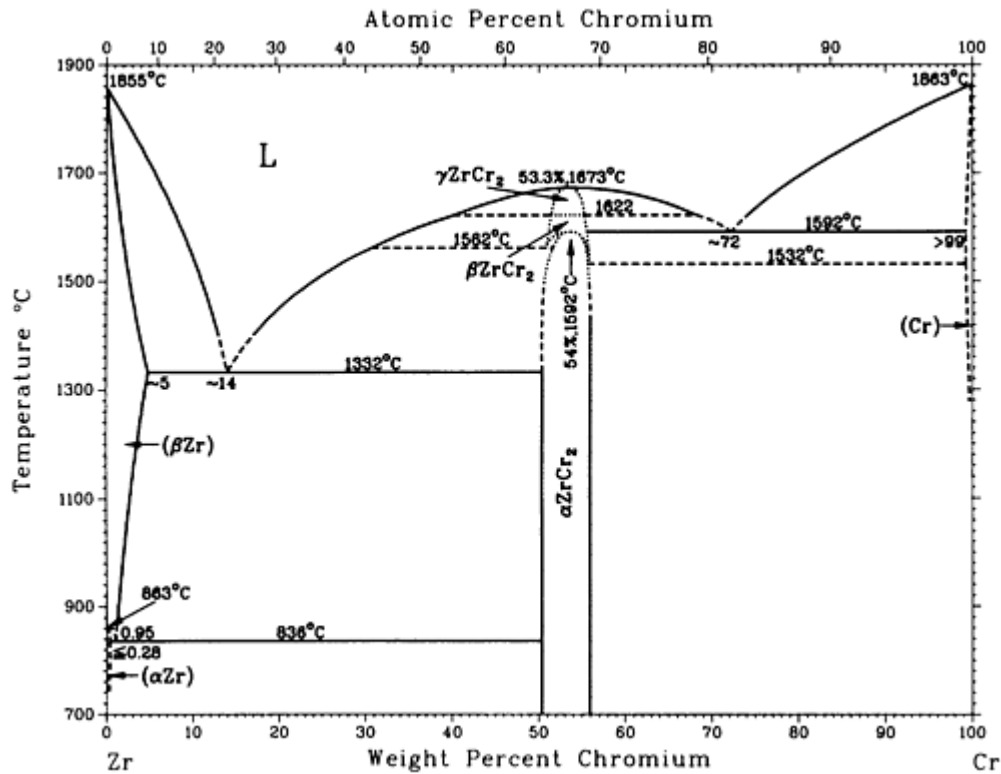

Cr-Zr phase diagram

Cr-Zr crystallographic data

Phase	Composition wt% Cr	Pearson symbol	Space group
(αZr)	0 to 0.28	<i>hP2</i>	<i>P6₃/mmc</i>
(βZr)	0 to ~5	<i>cI2</i>	<i>Im$\bar{3}m$</i>
γZrCr ₂	50 to 56	<i>hP12</i>	<i>P6₃/mmc</i>
βZrCr ₂	50 to 56	<i>hP24</i>	<i>P6₃/mmc</i>
αZrCr ₂	50 to 56	<i>cF24</i>	<i>Fd$\bar{3}m$</i>

(Cr)	>99 to 100	<i>cI2</i>	$Im\bar{3}m$
Metastable phases			
ω	...	<i>hP3</i>	$P\bar{3}m1$ (<i>P6/mmm?</i>)

Cs (Cesium) Binary Alloy Phase Diagrams

Introduction

THIS ARTICLE includes systems where cesium is the first-named element in the binary pair. Additional binary systems that include cesium are provided in the following locations in this Volume:

- “Bi-Cs (Bismuth - Cesium)” in the article “Bi (Bismuth) Binary Phase Diagrams.”
- “Cl-Cs (Chlorine - Cesium)” in the article “Cl (Chlorine) Binary Phase Diagrams.”

Cs-Ge (Cesium - Germanium)

H. Okamoto, 1990

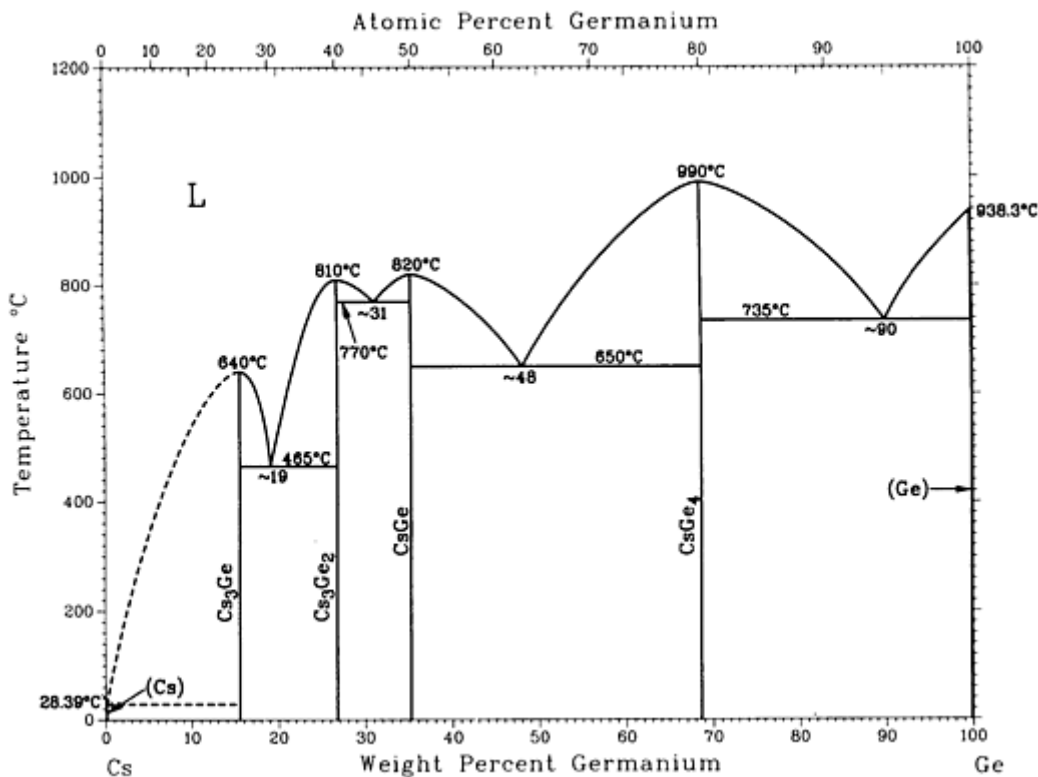

Cs-Ge phase diagram

Cs-Ge crystallographic data

Phase	Composition, wt% Ge	Pearson symbol	Space group

(Cs)	0	<i>cI2</i>	$Im\bar{3}m$
Cs ₃ Ge	15
Cs ₃ Ge ₂	27
CsGe	35.3	<i>cP64</i>	$P\bar{4}3n$
CsGe ₄	69	<i>cP*</i>	$Pm\bar{3}n$
(Ge)	100	<i>cF8</i>	$Fm\bar{3}m$

Cs-Hg (Cesium - Mercury)

From [Hansen] 6

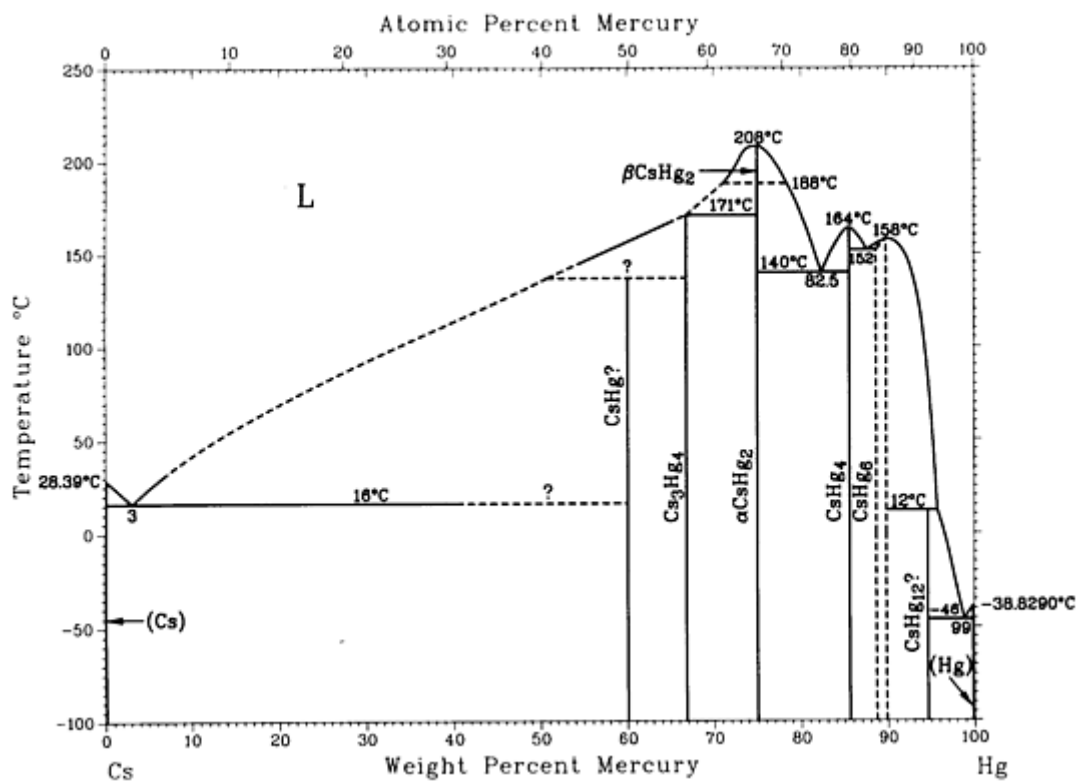

Cs-Hg phase diagram

Cs-Hg crystallographic data

Phase	Composition, wt% Hg	Pearson symbol	Space group
(Cs)	0	<i>cI2</i>	$Im\bar{3}m$
Cs ₃ Ge	15
Cs ₃ Ge ₂	27
CsGe	35.3	<i>cP64</i>	$P\bar{4}3n$
CsGe ₄	69	<i>cP*</i>	$Pm\bar{3}n$
(Ge)	100	<i>cF8</i>	$Fm\bar{3}m$

(Cs)	0	$cI2$	$Im\bar{3}m$
CsHg?	60.1
Cs₃Hg₄	66.8
β CsHg ₂	75.1
α CsHg ₂	75.1
CsHg₄	86
CsHg₆	90.0
CsHg₁₂?	~95	c^{**}	...
(Hg)	100	$hR1$	$R\bar{3}m$

Reference cited in this section

6. [**Hansen**]: M. Hansen and K. Anderko, *Constitution of Binary Alloys*, McGraw-Hill, New York or General Electric Co., Business Growth Services, Schenectady, New York (1958).

Cs-In (Cesium - Indium)

A.D. Pelton and S. LaRose, 1990

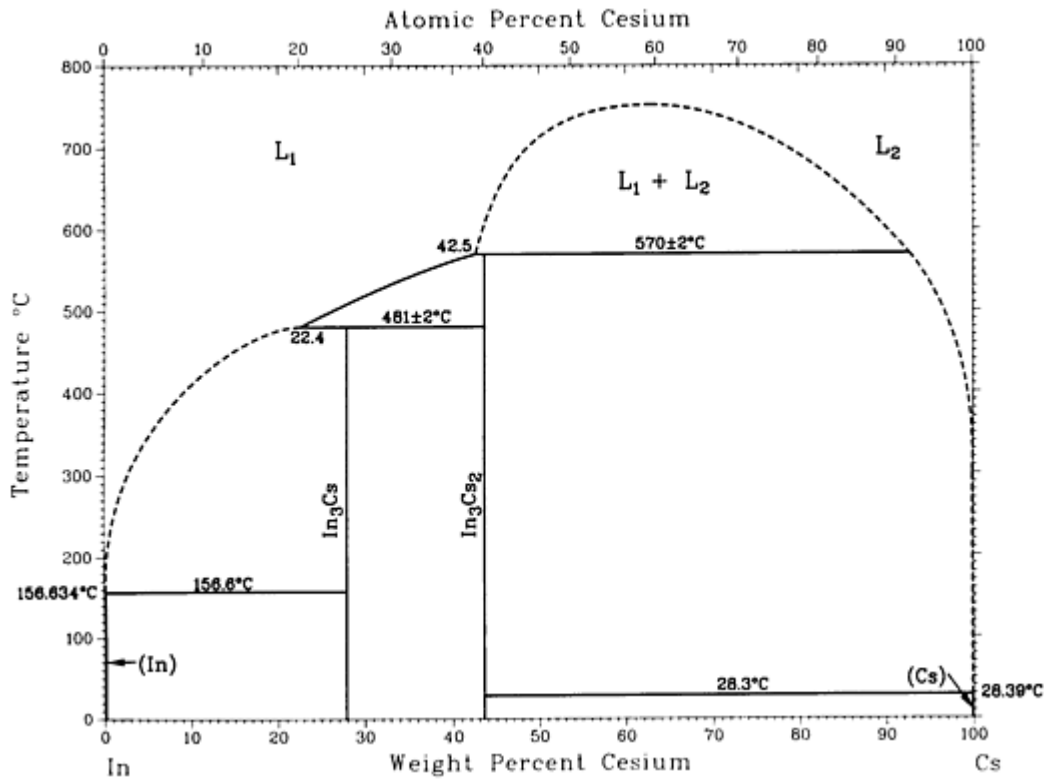

Cs-In phase diagram

Cs-In crystallographic data

Phase	Composition, wt% Cs	Pearson symbol	Space group
(In)	0	<i>tI2</i>	<i>I4/mmm</i>
In_3Cs	28	<i>tI24</i>	<i>I4m2</i>
In_3Cs_2	44	...	<i>I4m2</i>
(Cs)	100	<i>cI2</i>	<i>Im$\bar{3}m$</i>

Cs-K (Cesium - Potassium)

C.W. Bale and A.D. Pelton, 1983

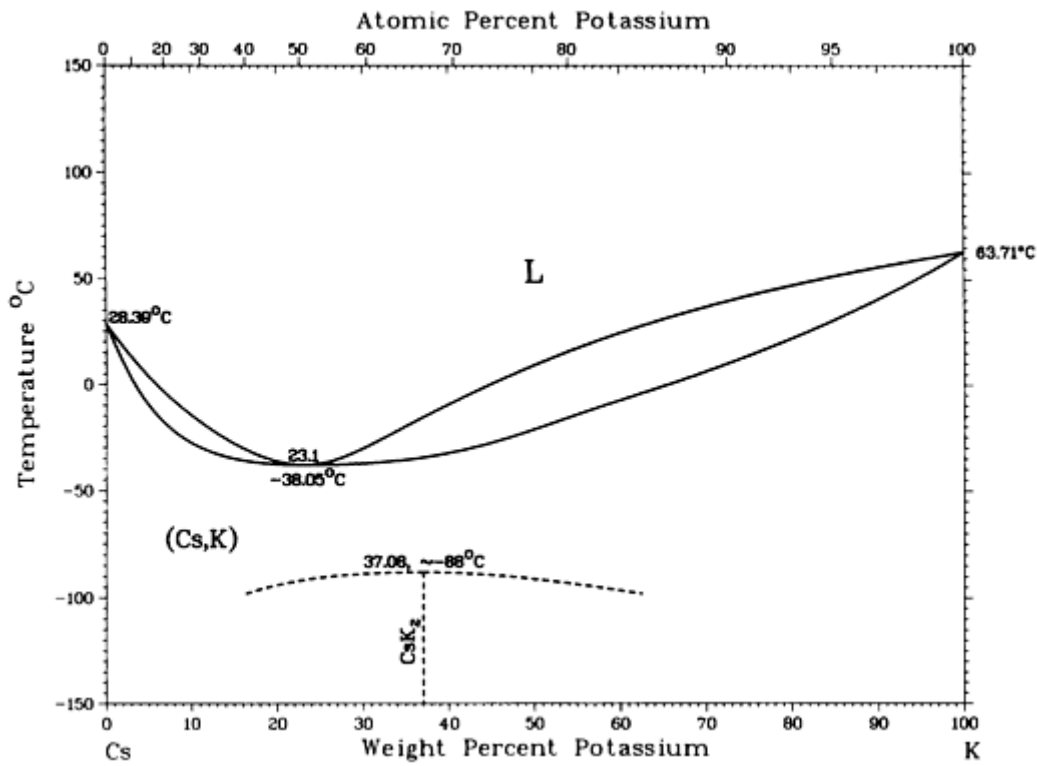

Cs-K phase diagram

Cs-K crystallographic data

Phase	Composition, wt% K	Pearson symbol	Space group
(Cs,K)	0 to 100	<i>cI2</i>	<i>Im</i> $\bar{3}m$
CsK ₂	37.0	<i>hP2?</i>	...
Other reported phase			
Cs ₆ K ₇	?

Cs-Na (Cesium - Sodium)

C.W. Bale, 1982

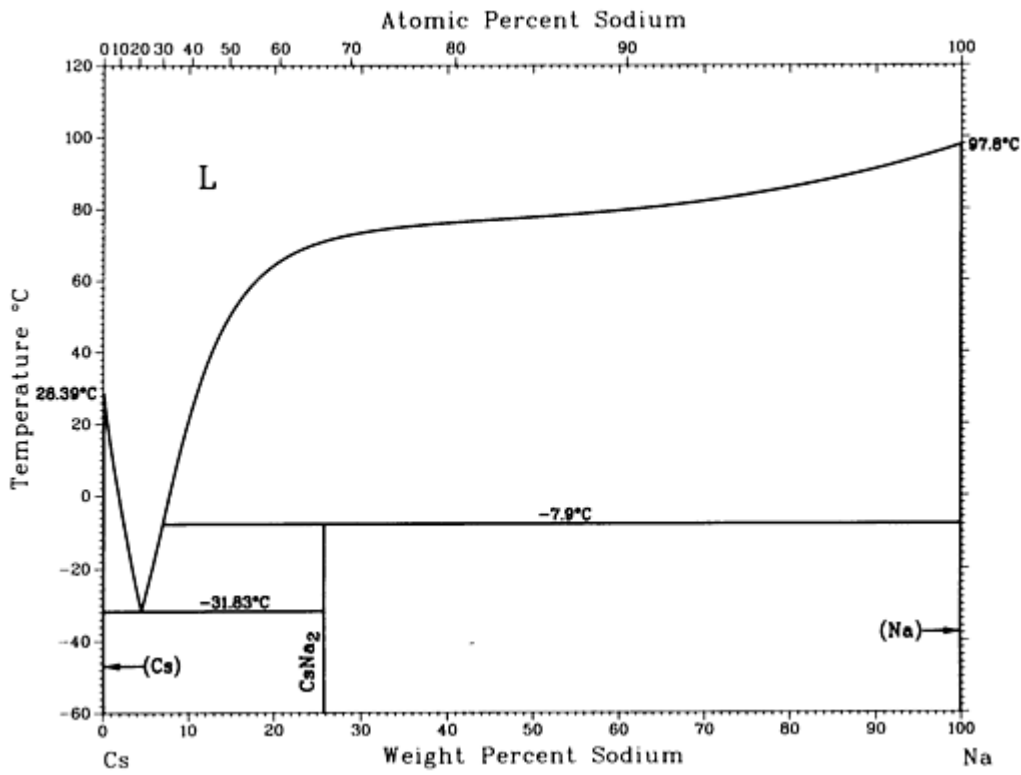

Cs-Na phase diagram

Cs-Na crystallographic data

Phase	Composition, wt% Na	Pearson symbol	Space group
(Cs)	0	<i>cI2</i>	<i>Im</i> $\bar{3}m$
CsNa ₂	25.7
(Na)	100	<i>cI2</i>	<i>Im</i> $\bar{3}m$

Cs-O (Cesium - Oxygen)

P.R. Subramanian, 1990

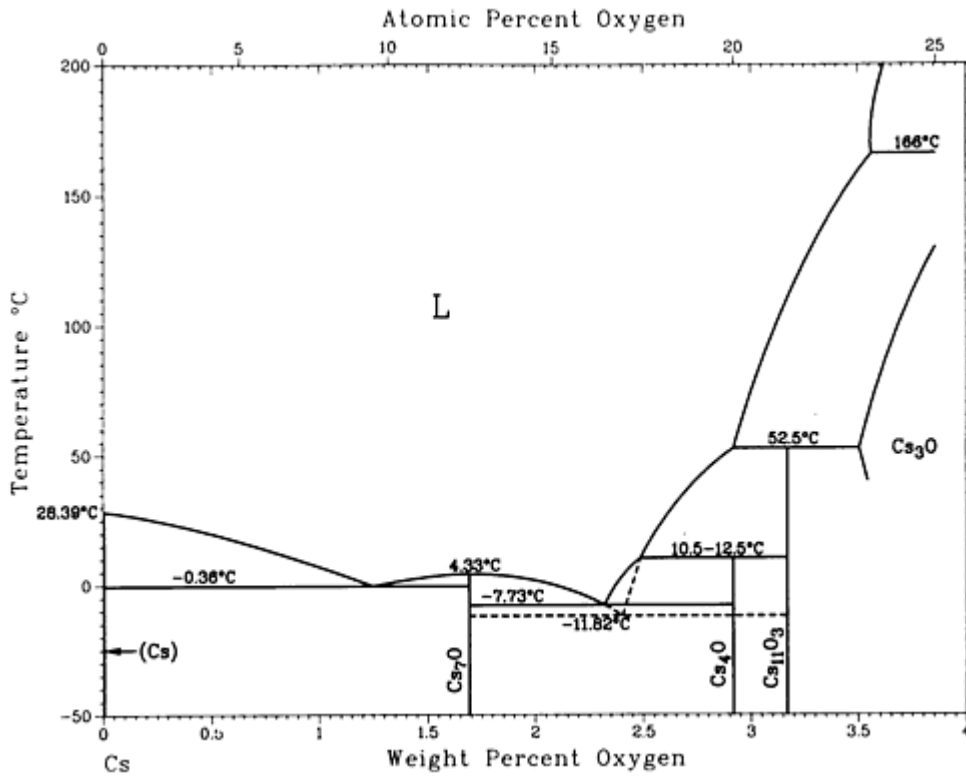

Cs-O phase diagram

Cs-O crystallographic data

Phase	Composition, wt% O	Pearson symbol	Space group
(Cs)	~0	<i>cI2</i>	<i>Im</i> $\bar{3}m$
Cs ₇ O	~1.7	<i>hP24</i>	<i>P</i> $\bar{6}m2$
Cs ₄ O	3
Cs ₁₁ O ₃ ^(a)	~3.2	<i>mP56</i>	<i>P</i> ₂ ₁ / <i>c</i>
Cs ₃ O	~4
Cs ₂ O	~5.7	<i>hR3</i>	<i>R</i> $\bar{3}m$
CsO	~10.7	<i>oI8</i>	<i>Immm</i>

Cs_2O_3	~ 15	$cI28$	$I\bar{4}3d$
$\text{CsO}_2(\text{LT})$	~ 19.4	$tI6$	$I4/mmm$
$\text{CsO}_2(\text{HT})^{(b)}$	~ 19.4	$cF8$	$Fm\bar{3}m$

(a) Also reported as Cs_7O_2 .

(b) Above $\sim 200^\circ\text{C}$

Cs-Rb (Cesium - Rubidium)

C.W. Bale and A.D. Pelton, 1983

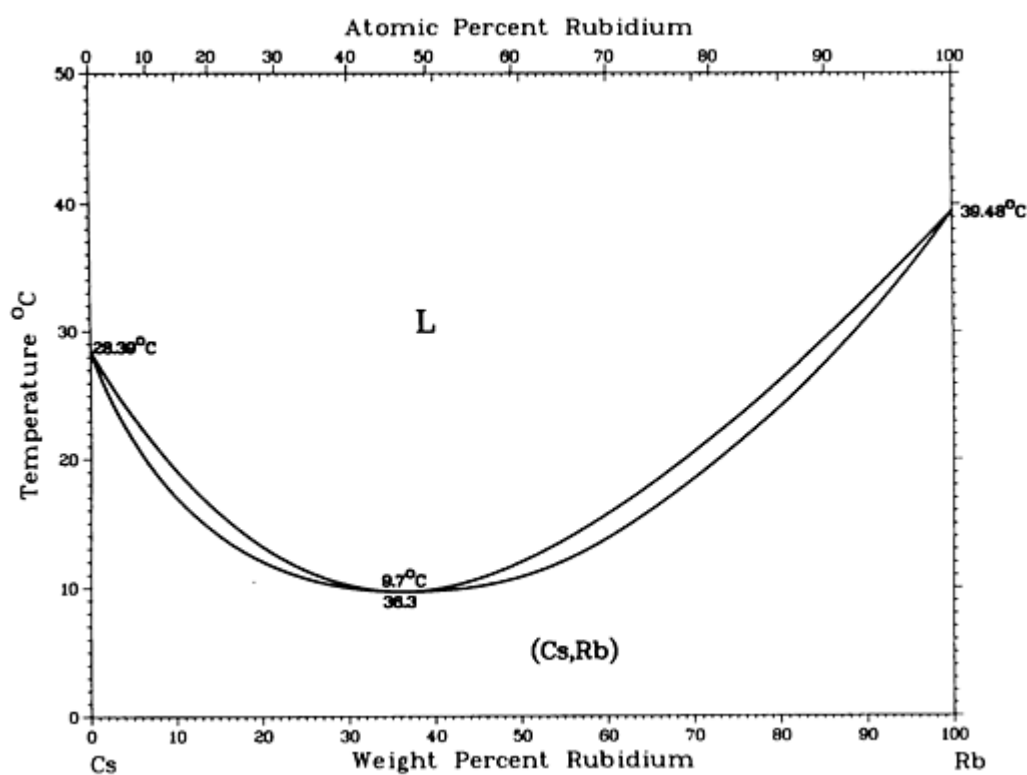

Cs-Rb phase diagram

Cs-Rb crystallographic data

Phase	Composition, wt% Rb	Pearson symbol	Space group
(Cs,Rb)	0 to 100	$cI2$	$Im\bar{3}m$

Cs-S (Cesium - Sulfur)

From [Smithells] 19

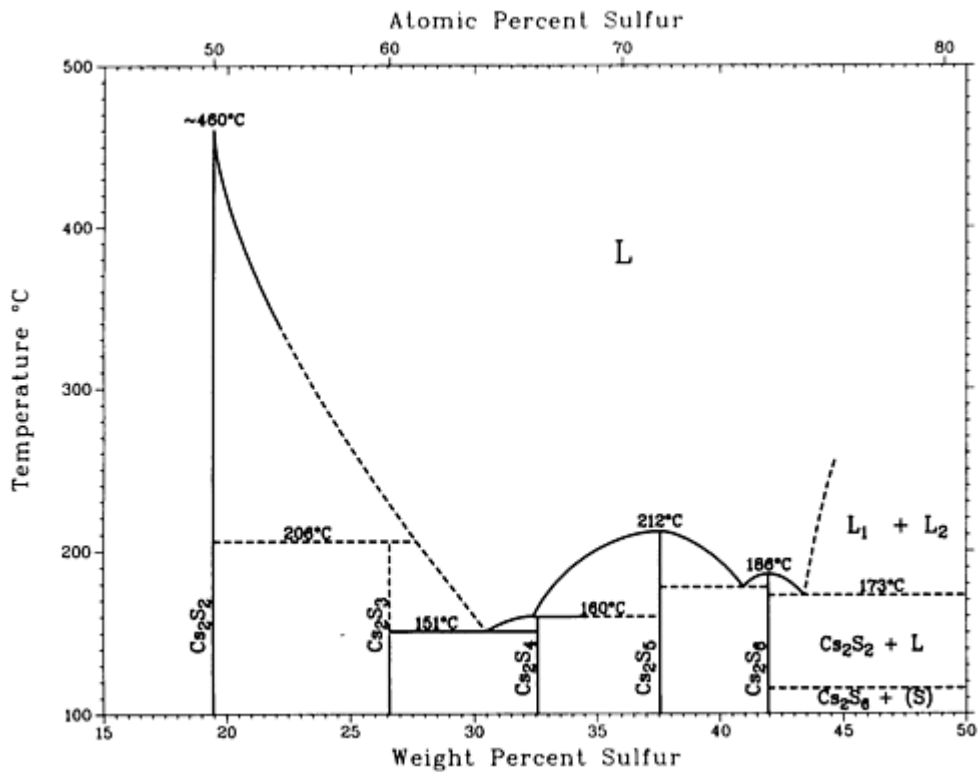

Cs-S phase diagram

Cs-S crystallographic data

Phase	Composition, wt% S	Pearson symbol	Space group
Cs ₂ S ₂	19.4	<i>oI8</i>	...
Cs ₂ S ₃	27	<i>oC20</i>	<i>Cmc2</i> ₁
Cs ₂ S ₄	~34.7
Cs ₂ S ₅	~40.0
Cs ₂ S ₆	~42.5

Reference cited in this section

19. [Smithells]: C.J. Smithells and E.A. Brandes, *Metals Reference Book*, 5th ed., Butterworths, Wobum, MA (1976).

Cs-Sb (Cesium - Antimony)

F.W. Dorn and W. Klemm, 1961

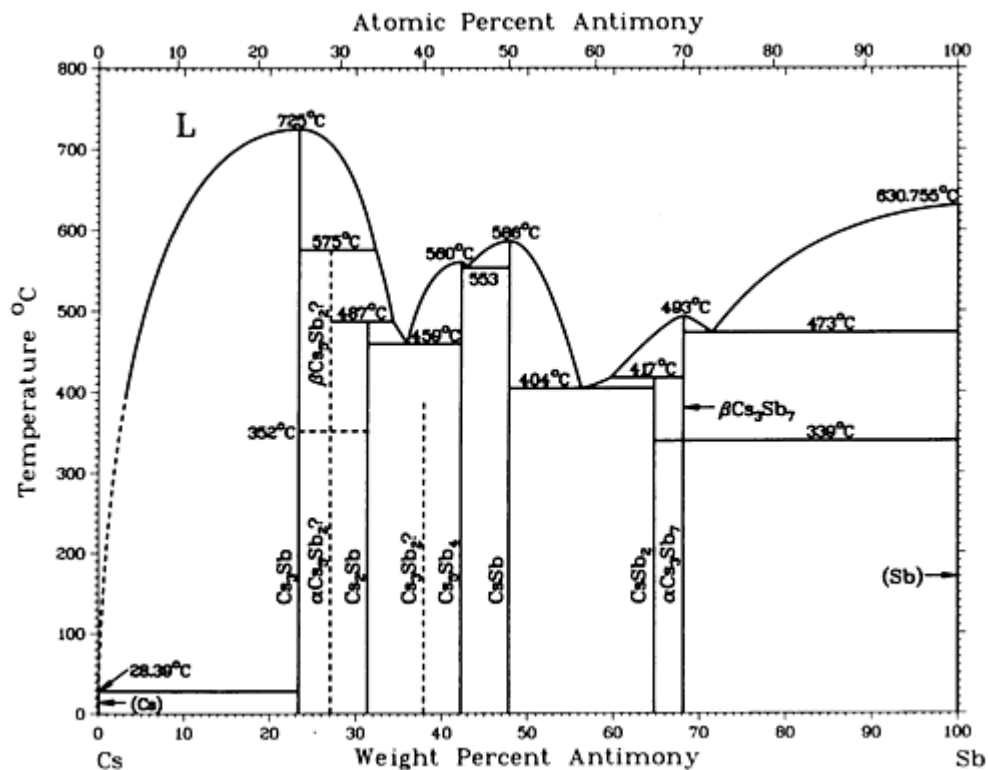

Cs-Sb phase diagram

Cs-Sb crystallographic data

Phase	Composition, wt% Sb	Pearson symbol	Space group
(Cs)	0	<i>cI2</i>	$Im\bar{3}m$
Cs₃Sb	23	<i>cF16</i>	$Fd\bar{3}m$
$\alpha\text{Cs}_5\text{Sb}_2$	26.8
$\beta\text{Cs}_5\text{Sb}_2$	26.8
Cs₂Sb	31
Cs₃Sb₂	38
Cs₅Sb₄	42.2

CsSb	47.8	<i>oP16</i>	$P2_12_12_1$
CsSb ₂	64.7
α -Cs ₃ Sb ₇	68
β -Cs ₃ Sb ₇	68
(Sb)	100	<i>hR2</i>	$R\bar{3}m$

Cs-Se (Cesium - Selenium)

H. Okamoto, 1990

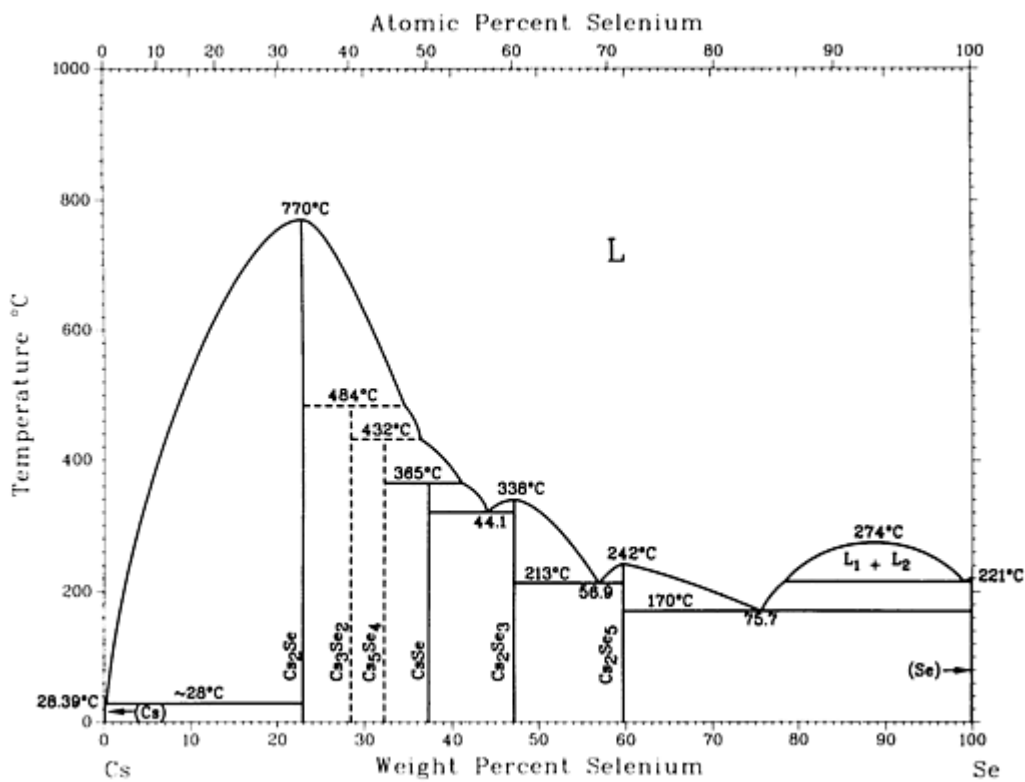

Cs-Se phase diagram

Cs-Se crystallographic data

Phase	Composition, wt% Se	Pearson symbol	Space group
(Cs)	0	<i>cI2</i>	$Im\bar{3}m$

Cs_2Se	22.9	<i>oP12</i>	<i>Pnma</i>
Cs_3Se_2	28
Cs_5Se_4	32.2
CsSe	37.3
Cs_2Se_3	47	<i>oC20</i>	<i>Cmc2_1</i>
Cs_2Se_5	59.7	<i>oP28</i>	<i>P2_12_12_1</i>
(Se)	100	<i>hP3</i>	<i>P3_12_1</i>
High-pressure phase			
Cs_2Se	22.9	<i>oF24</i>	<i>Fdd2</i>

Cs-Sn (Cesium - Tin)

L.Z. Melenkov, S.P. Yatsenko, K.A. Chantonov, and Yu.N. Grin, 1987

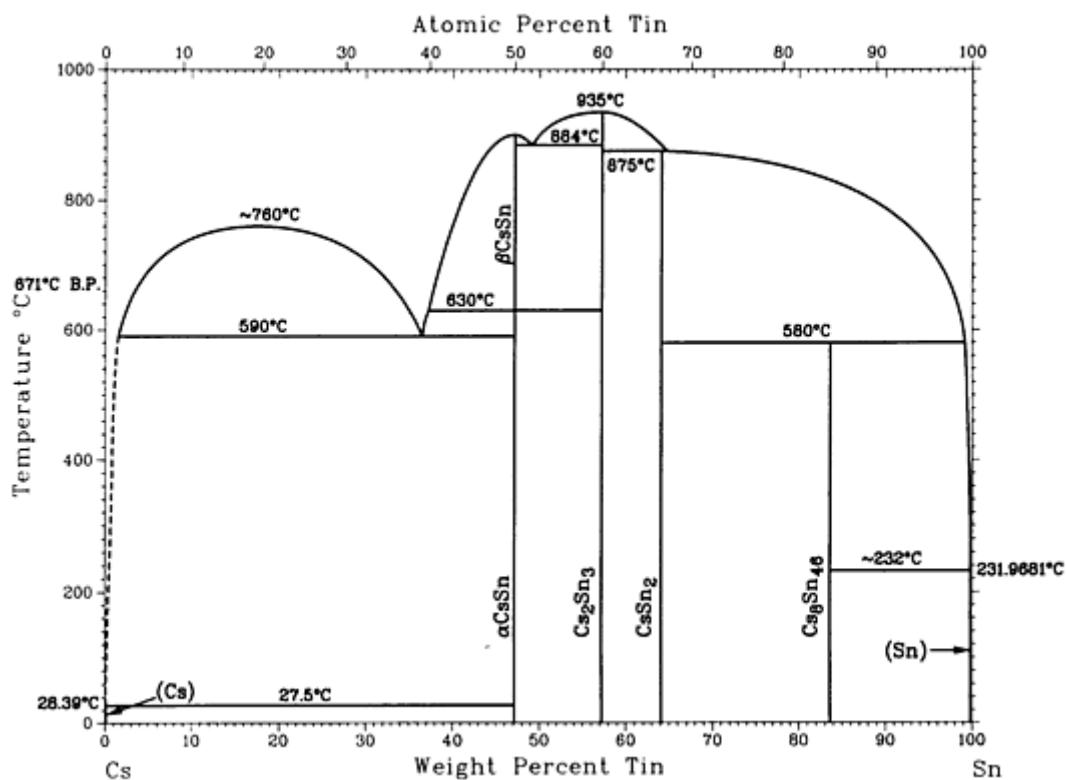

Cs-Sn phase diagram

Cs-Sn crystallographic data

Phase	Composition, wt% Sn	Pearson symbol	Space group
(Cs)	~0	<i>cI2</i>	<i>Im</i> $\bar{3}m$
β CsSn	47.2
α CsSn	47.2	<i>tI64</i>	<i>I4</i> ₁ / <i>acd</i>
Cs ₂ Sn ₃	57
CsSn ₂	64.1
Cs ₈ Sn ₄₆	84	...	<i>Pm</i> $\bar{3}n$
(β Sn) ^(a)	~100	<i>tI4</i>	<i>I4</i> ₁ / <i>amd</i>
(α Sn) ^(b)	~100	<i>cF8</i>	<i>Fd</i> $\bar{3}m$

(a) Between 13 and 231.9681 °C.

(b) Below 13 °C

Cs-Te (Cesium - Tellurium)

J. Sangster and A.D. Pelton, unpublished

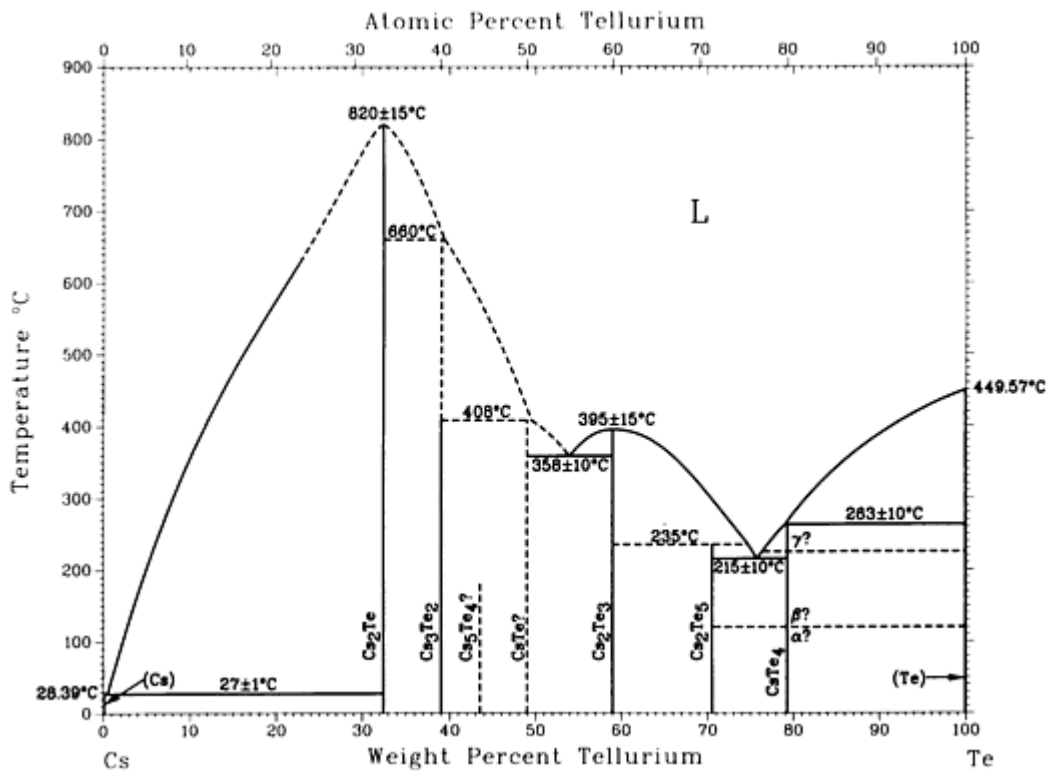

Cs-Te phase diagram

Cs-Te crystallographic data

Phase	Composition, wt% Te	Pearson symbol	Space group
(Cs)	0	<i>cI2</i>	<i>Im</i> $\bar{3}m$
Cs ₂ Te	32.4	<i>oP12</i>	<i>P2</i> ₁ <i>2</i> ₁
Cs ₃ Te ₂	39.0
Cs ₅ Te ₄ ^(a)	43.4
CsTe ^(a)	49.0
Cs ₂ Te ₃	59	<i>oC20</i>	<i>Cmc</i> ₂ <i>1</i>
Cs ₂ Te ₅	70.6	<i>oC28</i>	<i>Cmcm</i>

$\text{CsTe}_4^{(b)}$	79	<i>mP20</i>	$P2_1/c$
(Te)	100	<i>hP3</i>	$P3_12_1$

(a) Might not exist.

(b) Three allotropic forms have been reported to exist. If so, this is the structure of a metastable high-temperature allotope.

Cs-Tl (Cesium - Thallium)

V.D. Busmanov and S.P. Yatsenko, 1981

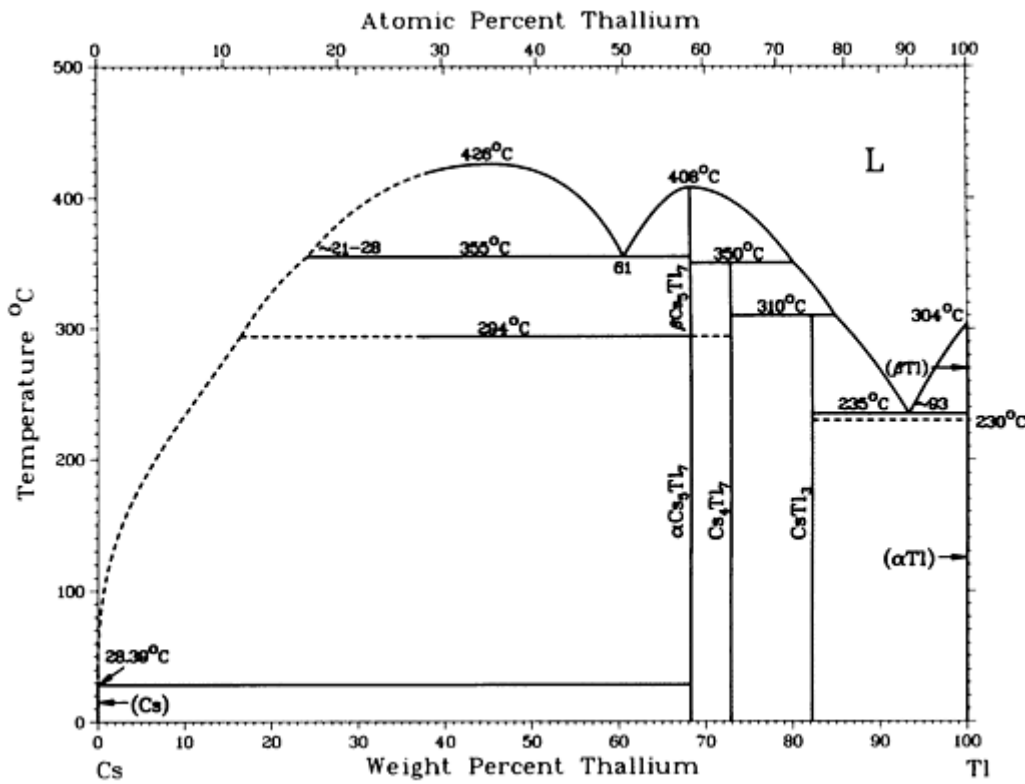

Cs-Tl phase diagram

Cs-Tl crystallographic data

Phase	Composition, wt% Tl	Pearson symbol	Space group
(Cs)	0	<i>cI2</i>	$Im\bar{3}m$

$\alpha\text{Cs}_5\text{Tl}_7$	68.3
$\beta\text{Cs}_5\text{Tl}_7$	68.3
Cs_4Tl_7	62.9
CsTl_3	82
(αTl)	100	<i>hP2</i>	<i>P6₃/mmc</i>
(βTl)	100	<i>cI2</i>	<i>Im$\bar{3}m$</i>

Cu (Copper) Binary Alloy Phase Diagrams

Introduction

THIS ARTICLE includes systems where copper is the first-named element in the binary pair. Additional binary systems that include copper are provided in the following locations in this Volume:

- “Ag-Cu (Silver - Copper)” in the article “Ag (Silver) Binary Alloy Phase Diagrams.”
- “Al-Cu (Aluminum - Copper)” in the article “Al (Aluminum) Binary Alloy Phase Diagrams.”
- “As-Cu (Arsenic - Copper)” in the article “As (Arsenic) Binary Alloy Phase Diagrams.”
- “Au-Cu (Gold - Copper)” in the article “Au (Gold) Binary Alloy Phase Diagrams.”
- “B-Cu (Boron - Copper)” in the article “B (Boron) Binary Alloy Phase Diagrams.”
- “Ba-Cu (Barium - Copper)” in the article “Ba (Barium) Binary Alloy Phase Diagrams.”
- “Be-Cu (Beryllium - Copper)” in the article “Be (Beryllium) Binary Alloy Phase Diagrams.”
- “Bi-Cu (Bismuth - Copper)” in the article “Bi (Bismuth) Binary Alloy Phase Diagrams.”
- “C-Cu (Carbon - Copper)” in the article “C (Carbon) Binary Alloy Phase Diagrams.”
- “Ca-Cu (Calcium - Copper)” in the article “Ca (Calcium) Binary Alloy Phase Diagrams.”
- “Cd-Cu (Cadmium - Copper)” in the article “Cd (Cadmium) Binary Alloy Phase Diagrams.”
- “Ce-Cu (Cerium - Copper)” in the article “Ce (Cerium) Binary Alloy Phase Diagrams.”
- “Co-Cu (Cobalt - Copper)” in the article “Co (Cobalt) Binary Alloy Phase Diagrams.”
- “Cr-Cu (Chromium - Copper)” in the article “Cr (Chromium) Binary Alloy Phase Diagrams.”

Cu-Dy (Copper - Dysprosium)

P.R. Subramanian and D.E. Laughlin, 1988

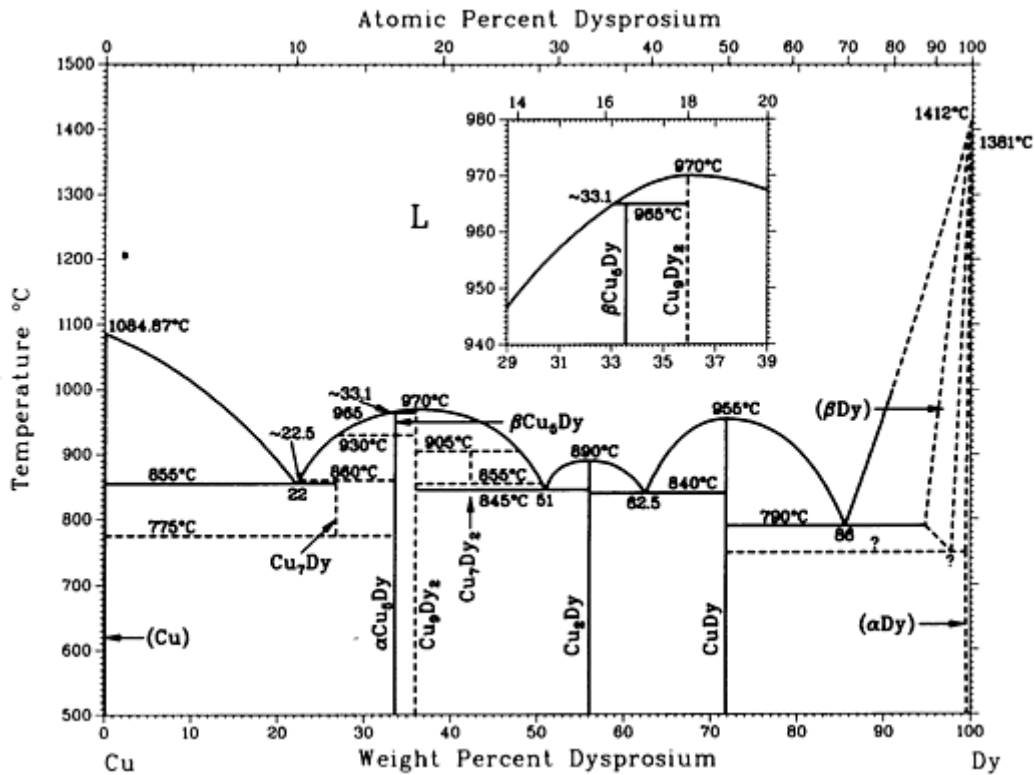

Cu-Dy phase diagram

Cu-Dy crystallographic data

Phase	Composition, wt% Dy	Pearson symbol	Space group
(Cu)	0	<i>cF4</i>	<i>Fm</i> $\bar{3}m$
βCu_5Dy	~33.84	<i>hP6</i>	<i>P6/mmm</i>
αCu_5Dy	~33.84	<i>cF24</i>	<i>F</i> $\bar{4}3m$
Cu_7Dy	~56.1	<i>oI12</i>	<i>Imma</i>
$CuDy$	~72	<i>cP2</i>	<i>Pm</i> $\bar{3}m$

(α' Dy)	100	<i>oC4</i>	<i>Cmcm</i>
(α Dy)	100	<i>hP2</i>	<i>P6₃/mmc</i>
(β Dy)	100	<i>cI2</i>	<i>Im$\bar{3}m$</i>

Cu-Er (Copper - Erbium)

P.R. Subramanian and D.E. Laughlin, 1988

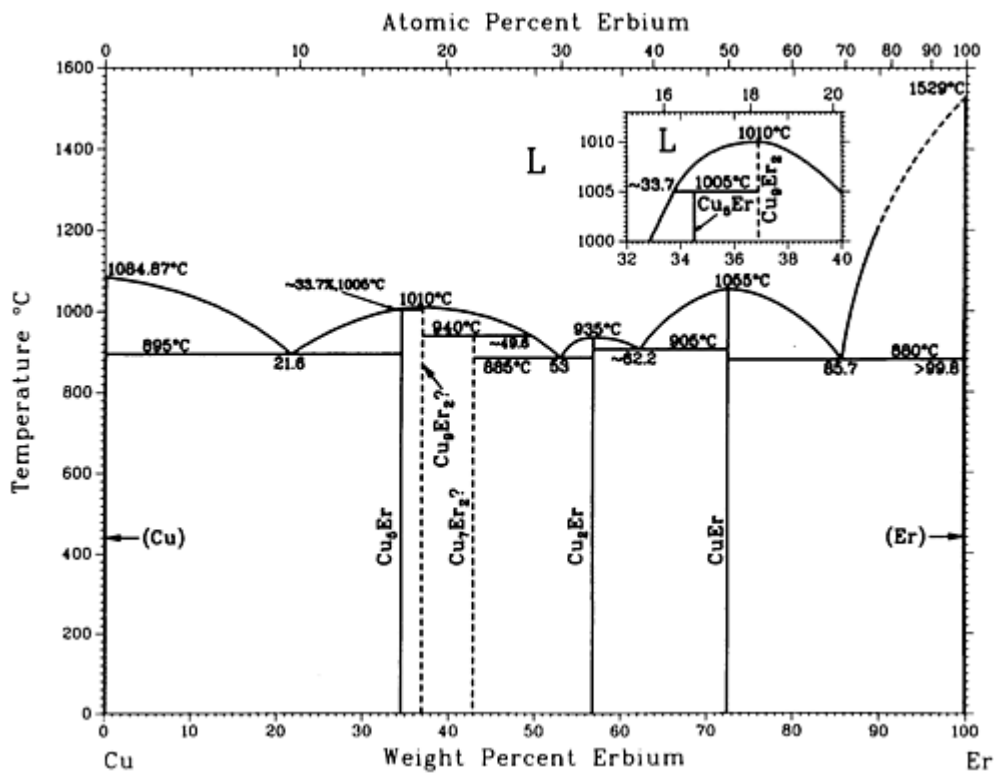

Cu-Er phase diagram

Cu-Er crystallographic data

Phase	Composition, wt% Er	Pearson symbol	Space group
(Cu)	0	<i>cF4</i>	<i>Fm$\bar{3}m$</i>
Cu_3Er	~34.49	<i>cF24</i>	<i>F$\bar{4}3m$</i>
Cu_2Er	~56.8	<i>oI12</i>	<i>Imma</i>

CuEr	~73	<i>cP2</i>	<i>Pm</i> $\bar{3}m$
(Er)	100	<i>hP2</i>	<i>P6₃/mmc</i>

Cu-Eu (Copper - Europium)

P.R. Subramanian and D.E. Laughlin, 1988

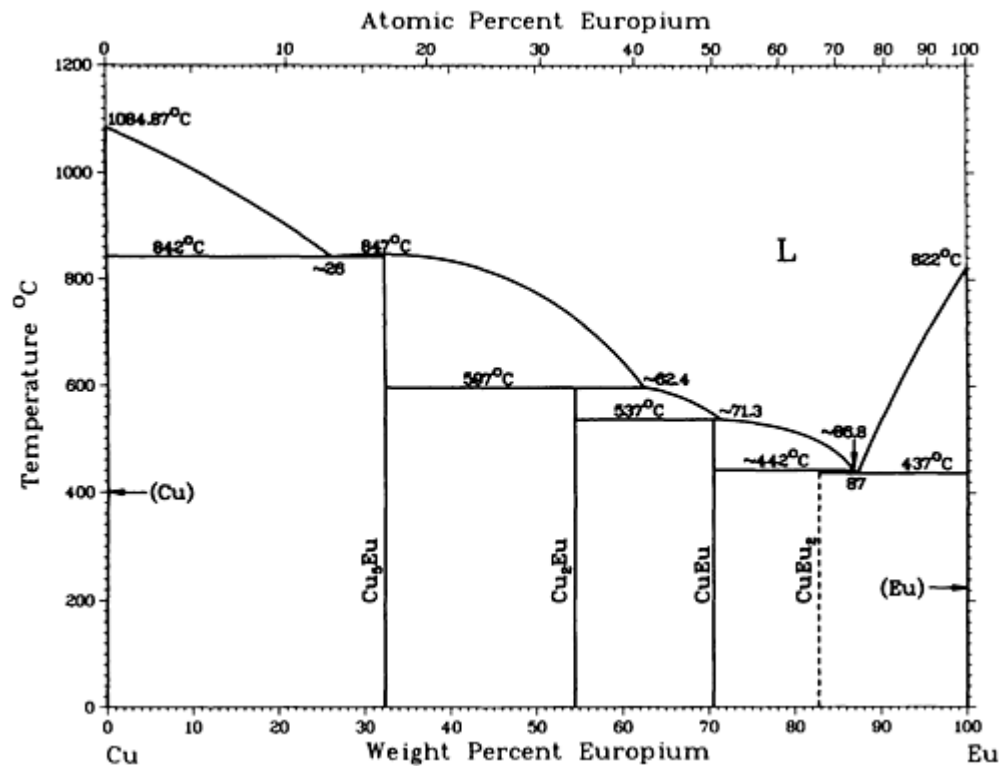

Cu-Eu phase diagram

Cu-Eu crystallographic data

Phase	Composition, wt% Eu	Pearson symbol	Space group
(Cu)	0	<i>cF4</i>	<i>Fm</i> $\bar{3}m$
Cu_5Eu	~35.24	<i>hP6</i>	<i>P6/mmm</i>
Cu_2Eu	~57.6	<i>oI12</i>	<i>Imma</i>
CuEu	~73	<i>oP8</i>	<i>Pnma</i>

CuEu_2	~ 84.48	$oP12$	$Pnma$
(Eu)	100	$cI2$	$Im\bar{3}m$

Cu-Fe (Copper - Iron)

L.J. Swartzendruber, 1992

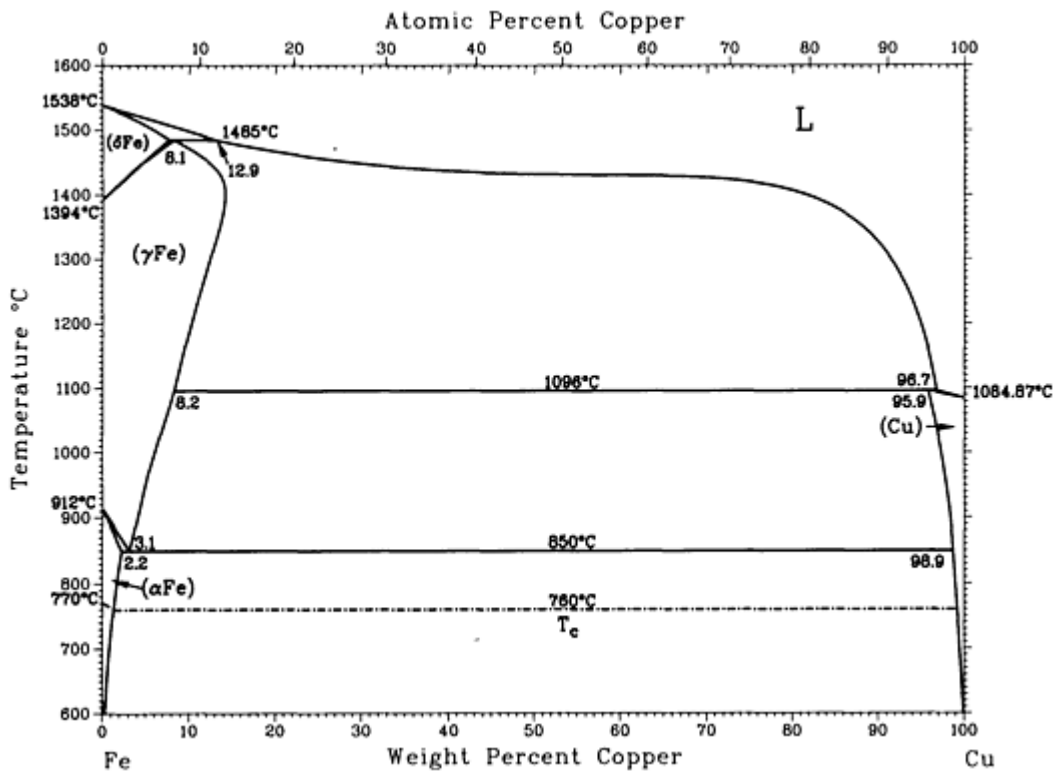

Cu-Fe phase diagram

Cu-Fe crystallographic data

Phase	Composition, wt% Cu	Pearson symbol	Space group
(δ Fe)	0 to 7.6	$cI2$	$Im\bar{3}m$
(γ Fe)	0 to 13	$cF4$	$Fm\bar{3}m$
(α Fe)	0 to 2.2	$cI2$	$Im\bar{3}m$

(Cu) 95.9 to 100 $cF4$ $Fm\bar{3}m$

Cu-Ga (Copper - Gallium)

P.R. Subramanian and D.E. Laughlin, unpublished

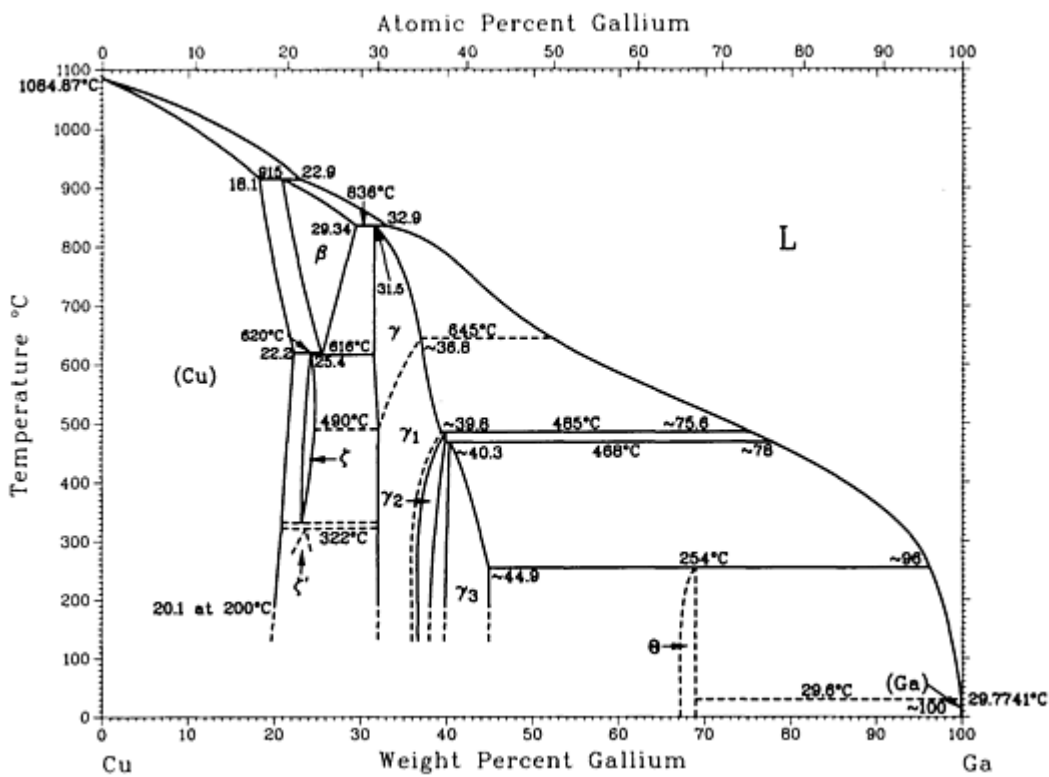

Cu-Ga phase diagram

Cu-Ga crystallographic data

Phase	Composition, wt% Ga	Pearson symbol	Space group
(Cu)	0 to 22.2	$cF4$	$Fm\bar{3}m$
β	20.8 to 29.34	$cI2$	$Im\bar{3}m$

γ	31.5 to \sim 36.8	<i>cP</i> 52	$P\bar{4}3m$
γ_1	31.8 to 39.8	<i>cP</i> 52	$P\bar{4}3m$
γ_2	36.0 to 39.9	<i>cP</i> ? ^(a)	$P\bar{4}3m$
γ_3	39.7 to \sim 44.9	<i>cP</i> ? ^(a)	$P\bar{4}3m$
ζ	22.1 to 24.2	<i>hP</i> 2	$P6_3/mmc$
ζ_1	22.6 to 24.1
θ	66.7 to 68.70	<i>tP</i> 3	$P4/mmm$
(Ga)	\sim 100	<i>oC</i> 8	<i>Cmca</i>

(a) The number of atoms/cell decreases from 52 to \sim 47, as the Ga contents decrease from 32.0 to 44.6 wt%.

Cu-Gd (Copper - Gadolinium)

P.R. Subramanian and D.E. Laughlin, 1988

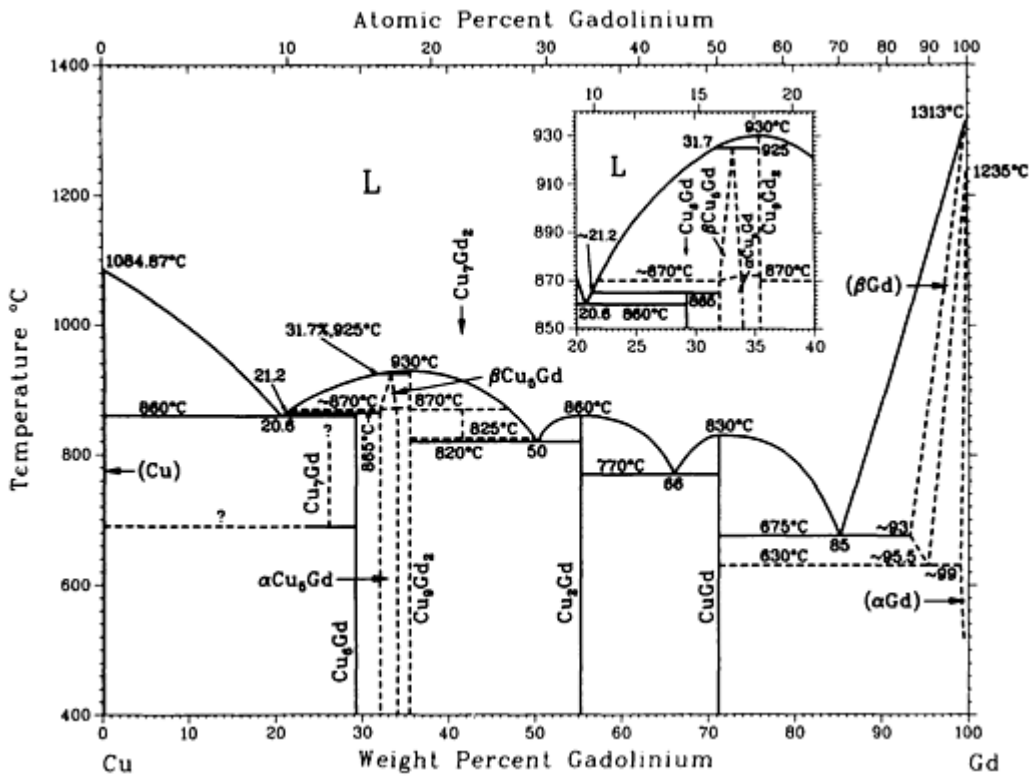

Cu-Gd phase diagram

Cu-Gd crystallographic data

Phase	Composition, wt% Gd	Pearson symbol	Space group
(Cu)	0	<i>cF4</i>	<i>Fm</i> $\bar{3}m$
Cu₆Gd	~29.21	<i>oP28</i>	<i>Pnma</i>
β-Cu₅Gd	~32 to ~34.1	<i>hP6</i>	<i>P6/mmm</i>
α-Cu₅Gd	~32 to ~34.1	<i>cF4</i>	<i>F</i> $\bar{4}3m$
Cu₂Gd	~55.3	<i>oI12</i>	<i>Imma</i>
CuGd	~71.2	<i>cP2</i>	<i>Pm</i> $\bar{3}m$
(αGd)	~99.3 to 100	<i>hP2</i>	<i>P6₃/mmc</i>
(βGd)	~93 to 100	<i>cI2</i>	<i>Im</i> $\bar{3}m$

Cu-Ge (Copper - Germanium)

R.W. Olesinski and G.J. Abbaschian, 1986

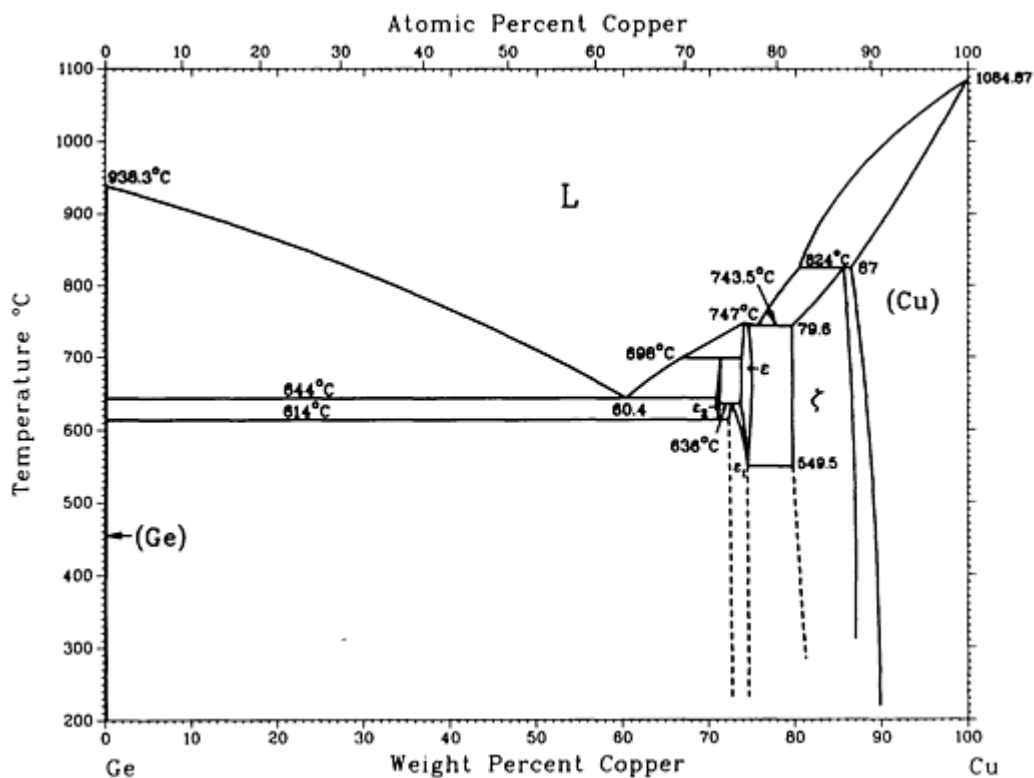

Cu-Ge phase diagram

Cu-Ge crystallographic data

Phase	Composition, wt% Cu	Pearson symbol	Space group
(Ge)	0	<i>cF8</i>	<i>Fd$\bar{3}m$</i>
GeII (HP)	...	<i>tI4</i>	<i>I4$_1$/amd</i>
$\epsilon_2^{(a)}$	70.8 to 71.3	<i>cI2</i>	<i>Im$\bar{3}m$</i>
$\epsilon_1^{(a)}$	72.3 to 74.4	<i>oP8</i>	<i>Pmnm</i>
$\epsilon^{(a)}$	73.7 to 74.4	^(b)	...
$\zeta^{(c)}$	79.6 to 87.1	<i>hP2</i>	<i>P6$_3$/mmc</i>
(Cu)	87 to 100	<i>cF4</i>	<i>Fm$\bar{3}m$</i>

Other reported phase			
γ'''	75.6	(d)	...

(a) Also denoted as Cu_3Ge .

(b) Rhombohedral.

(c) Also denoted as Cu_5Ge .

(d) Cubic

Cu-H (Copper - Hydrogen)

O.M. Barabash and Yu.N. Koval, 1986

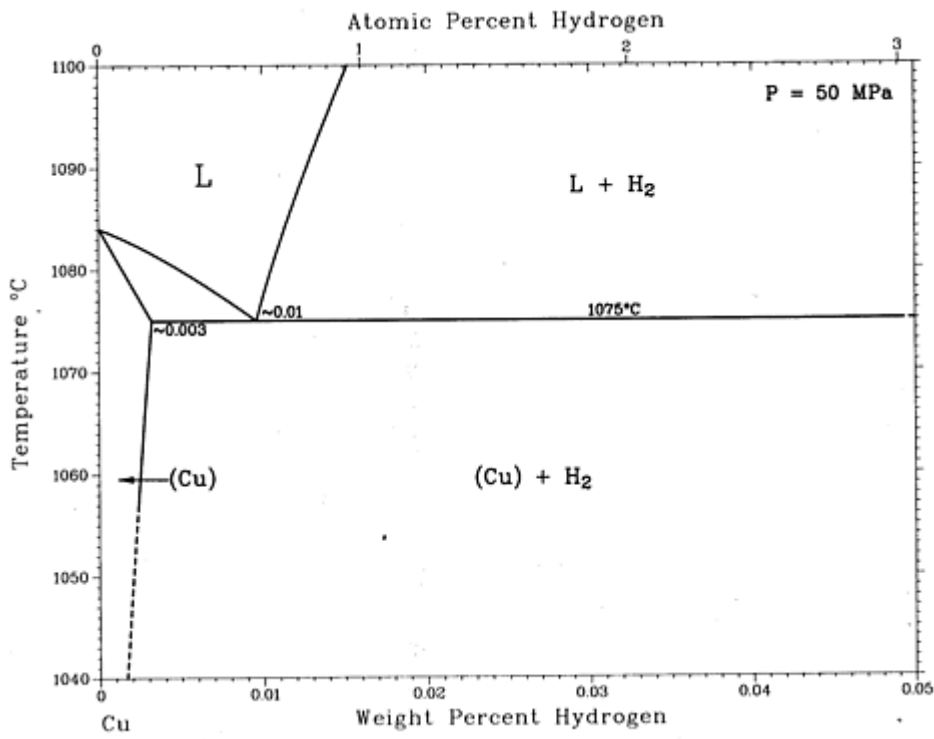

Cu-H phase diagram

Cu-H crystallographic data

Phase	Composition, wt% H	Pearson symbol	Space group
(Cu)	0 to ~0.003	$cF4$	$Fm\bar{3}m$

Cu-Hf (Copper - Hafnium)

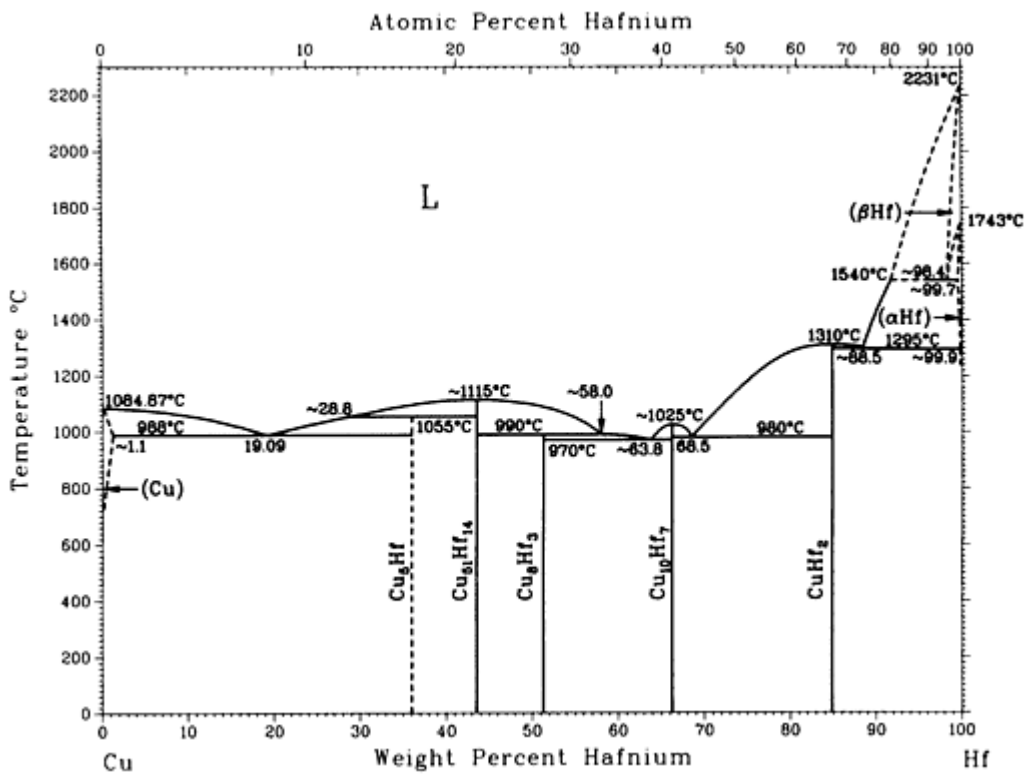

Cu-Hf phase diagram

Cu-Hf crystallographic data

Phase	Composition, wt% Hf	Pearson symbol	Space group
(Cu)	0 to ~1.1	<i>cF4</i>	<i>Fm</i> $\bar{3}m$
Cu₅₁Hf₁₄	43.54	<i>hP68</i>	<i>P6/m</i>
Cu₈Hf₃	51.29	<i>oP44</i>	<i>Pnma</i>
Cu₁₀Hf₇	66.29	<i>oC68</i>	...
CuHf₂	84.89	<i>tI6</i>	<i>I4/mmm</i>
(αHf)	~99.7 to 100	<i>hP2</i>	<i>P6₃/mmc</i>
(βHf)	~98.4 to 100	<i>cI2</i>	<i>Im</i> $\bar{3}m$

Cu-Hg (Copper - Mercury)

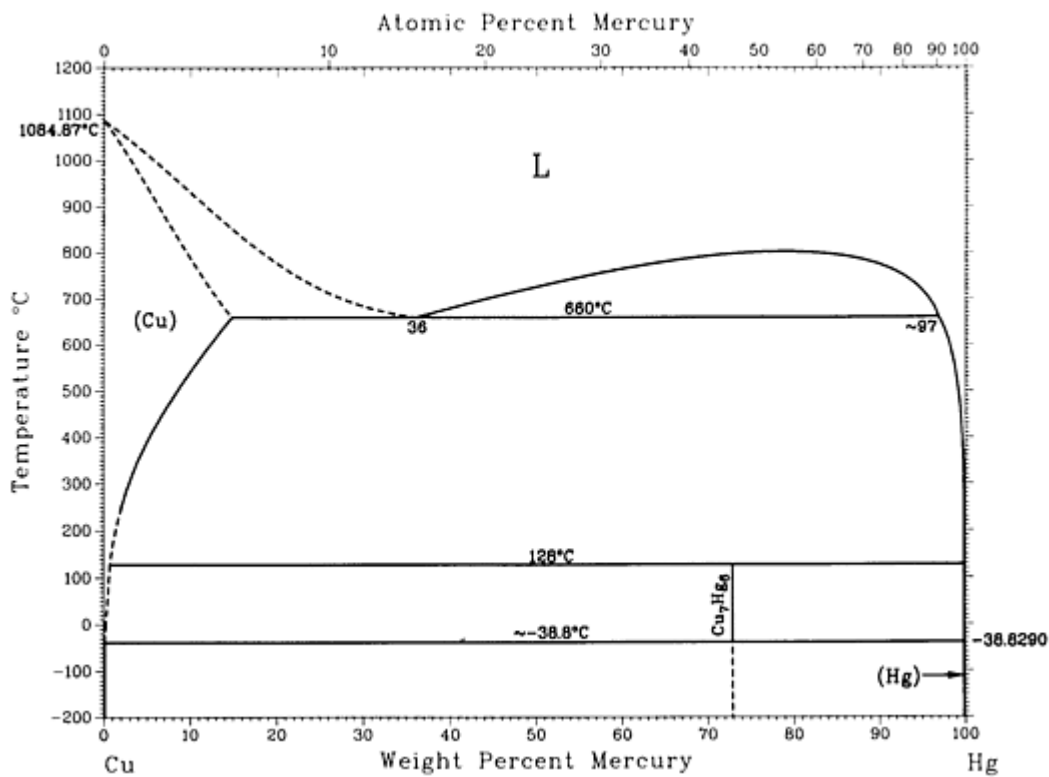

Cu-Hg phase diagram

Cu-Hg crystallographic data

Phase	Composition, wt% Hg	Pearson symbol	Space group
(Cu)	0 to ?	<i>cF4</i>	<i>Fm</i> $\bar{3}m$
$\gamma^{(a)}$	73	<i>hR52</i>	<i>R</i> $\bar{3}m$
(α Hg)	100	<i>hR1</i>	<i>R</i> $\bar{3}m$
(β Hg)	100	<i>tI2</i>	<i>I4/mmm</i>
(γ Hg) ^(b)	100

(a) Composition of the γ phase corresponds to stoichiometry Cu₇Hg₆.

(b) Formed from α Hg by strain-induced (martensitic) transformation at 4.2 K, reverting to α Hg at 50 K.

Cu-In (Copper - Indium)

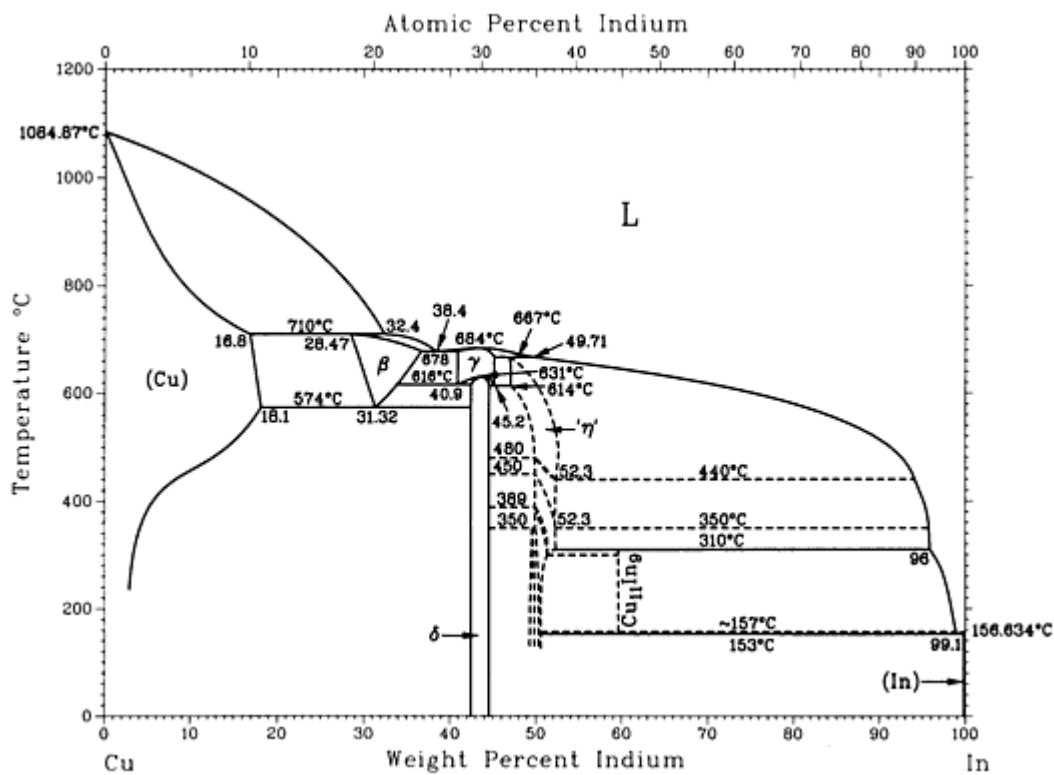

Cu-In phase diagram

Cu-In crystallographic data

Phase	Composition, wt% In	Pearson symbol	Space group
(Cu)	0 to 18.1	<i>cF4</i>	<i>Fm</i> $\bar{3}m$
β	28.47 to 37.0	<i>cI2</i>	<i>Im</i> $\bar{3}m$
γ	40.9 to 45.2	<i>cP52</i>	<i>P</i> $\bar{4}3m$
δ	42.52 to 44.3	<i>aP40</i>	<i>P</i> $\bar{1}$
" η "	47.00 to 52.3	<i>hP4</i>	<i>P</i> $6_3/mmc$
		<i>hP6</i>	<i>P</i> $6_3/mmc$
	49.5 to 52.3	<i>o**</i>	...

$\text{Cu}_{11}\text{In}_9$	~ 59	$mC20$	$C2/m$
(In)	~ 100	$tI2$	$I4/mmm$

Cu-Ir (Copper - Iridium)

D.J. Chakrabarti and D.E. Laughlin, 1987

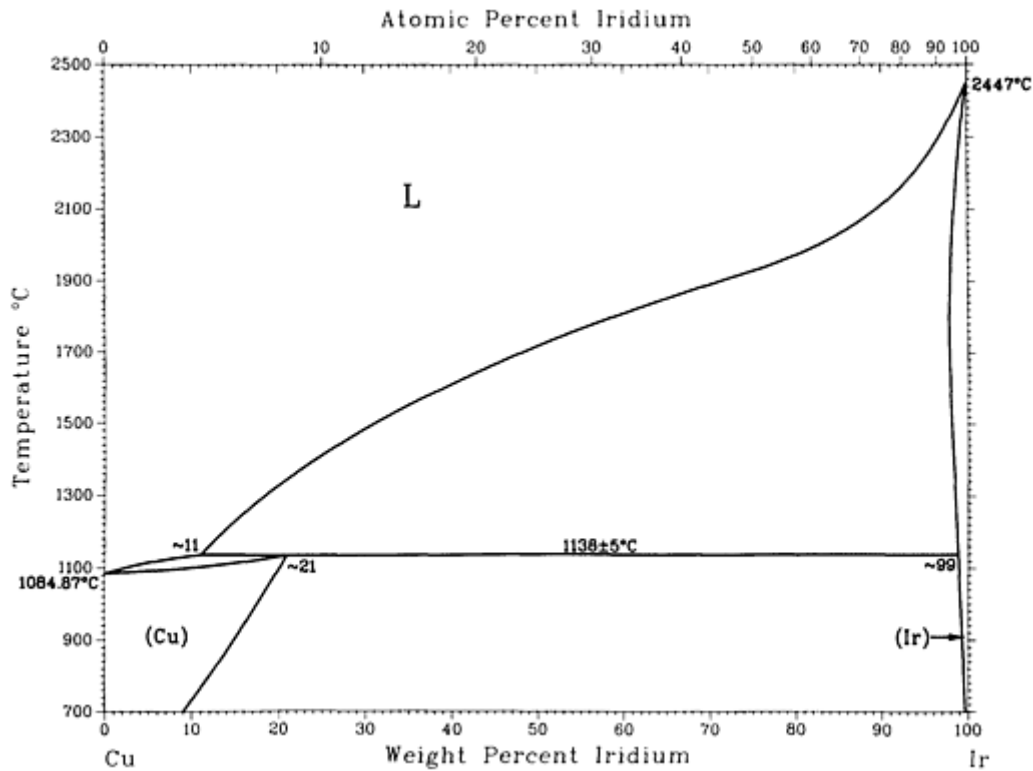

Cu-Ir phase diagram

Cu-Ir crystallographic data

Phase	Composition, wt% Ir	Pearson symbol	Space group
(Cu)	0 to ~ 21	$cF4$	$Fm\bar{3}m$
(Ir)	~ 97.8 to 100	$cF4$	$Fm\bar{3}m$

Cu-La (Copper - Lanthanum)

H. Okamoto, 1991

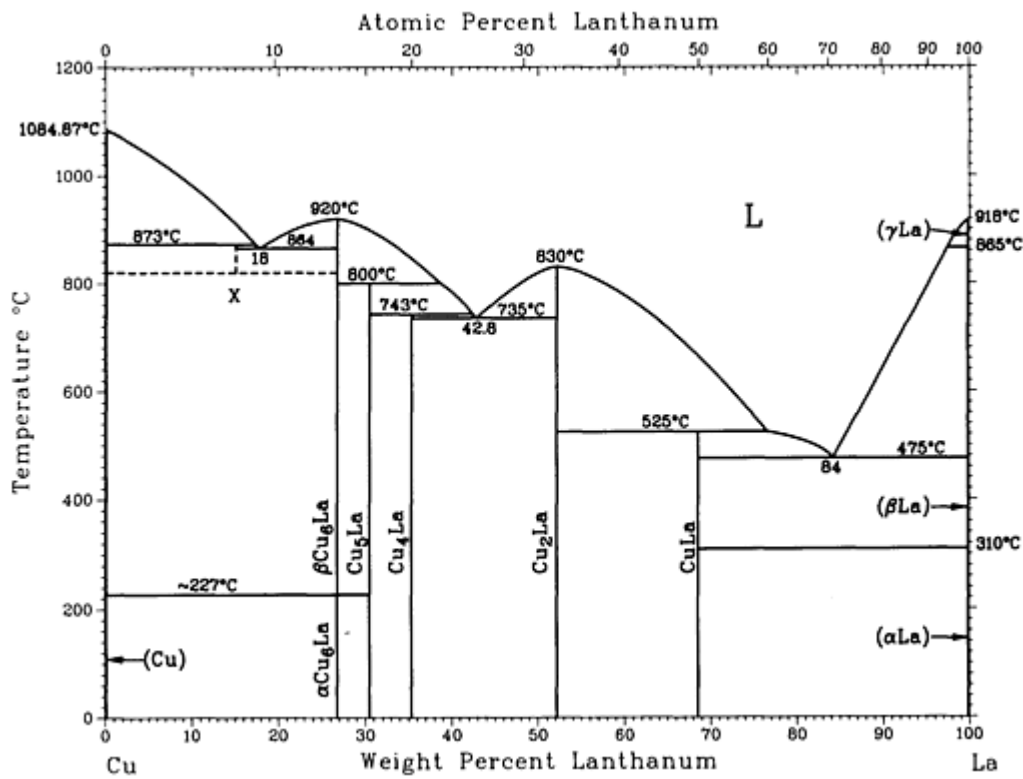

Cu-La phase diagram

Cu-La crystallographic data

Phase	Composition, wt% La	Pearson symbol	Space group
(Cu)	~0	<i>cF4</i>	<i>Fm</i> $\bar{3}m$
X	15.1
β Cu ₆ La	26.7	<i>oP28</i>	<i>Pnma</i>
α Cu ₆ La ^(a)	26.7	<i>mP*</i>	...
Cu ₅ La	30.3	<i>hP6</i>	<i>P6/mmm</i>
Cu ₄ La	35	<i>tI90</i>	<i>I</i> $\bar{4}m2$
Cu ₂ La	52.2	<i>hP3</i>	<i>P6/mmm</i>
CuLa	69	<i>oP8</i>	<i>Pnma</i>

(γ La)	~ 100	$cI2$	$Im\bar{3}m$
(β La)	~ 100	$cF4$	$Fm\bar{3}m$
(α La)	~ 100	$hP4$	$P6_3/mmc$

(a) Below ~ 227 °C

Cu-Li (Copper - Lithium)

A.D. Pelton, 1986

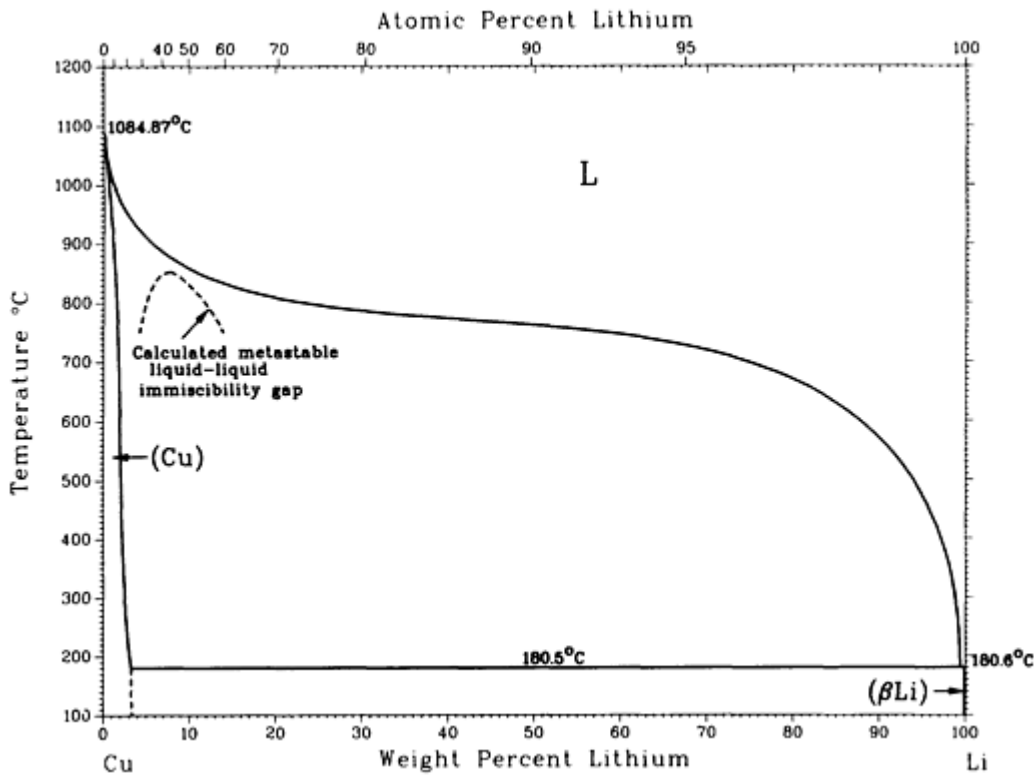

Cu-Li phase diagram

Cu-Li crystallographic data

Phase	Composition, wt% Li	Pearson symbol	Space group
(Cu)	0 to 3	$cF4$	$Fm\bar{3}m$
(β Li)	100	$cI2$	$Im\bar{3}m$

(α Li)^(a) 100 *hP2* *P6₃/mmc*

(a) Below ~ 193 °C

Cu-Mg (Copper - Magnesium)

H. Okamoto, 1992

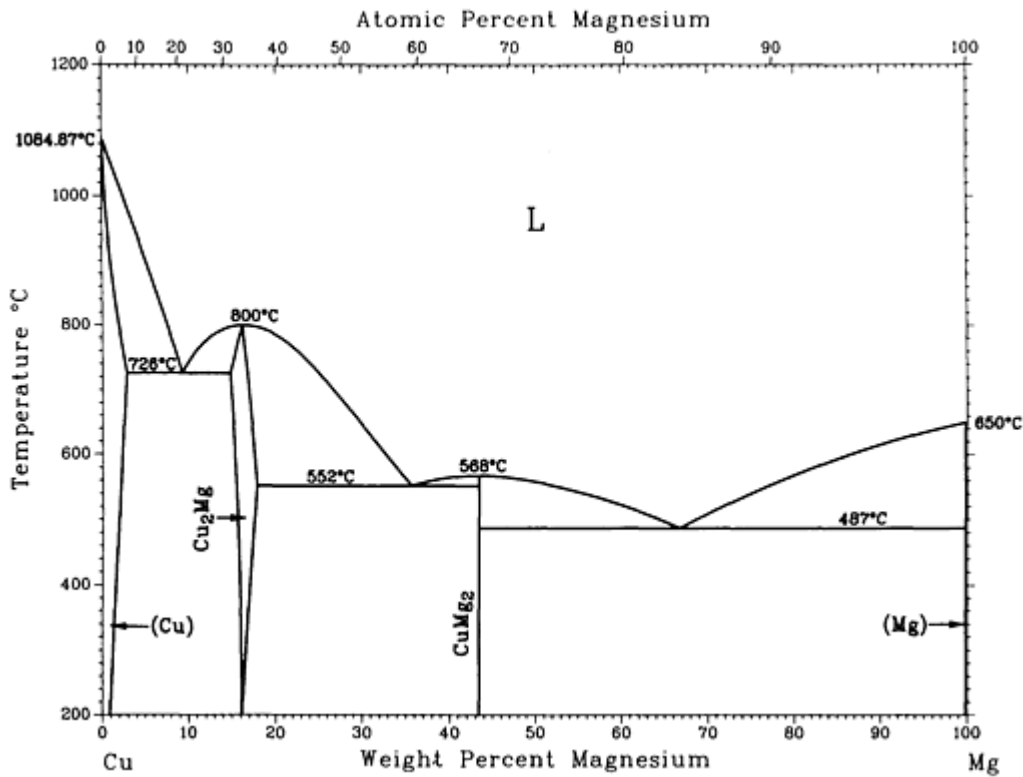

Cu-Mg phase diagram

Cu-Mg crystallographic data

Phase	Composition, wt% Mg	Pearson symbol	Space group
(Cu)	0 to 2.77	<i>cF4</i>	<i>Fm</i> $\bar{3}m$
Cu₂Mg	15 to 18	<i>cF24</i>	<i>Fd</i> $\bar{3}m$
CuMg₂	43.4	<i>oF48</i>	<i>Fddd</i>
(Mg)	100	<i>hP2</i>	<i>P6₃/mmc</i>

Cu-Mn (Copper - Manganese)

N.A. Gokcen, unpublished

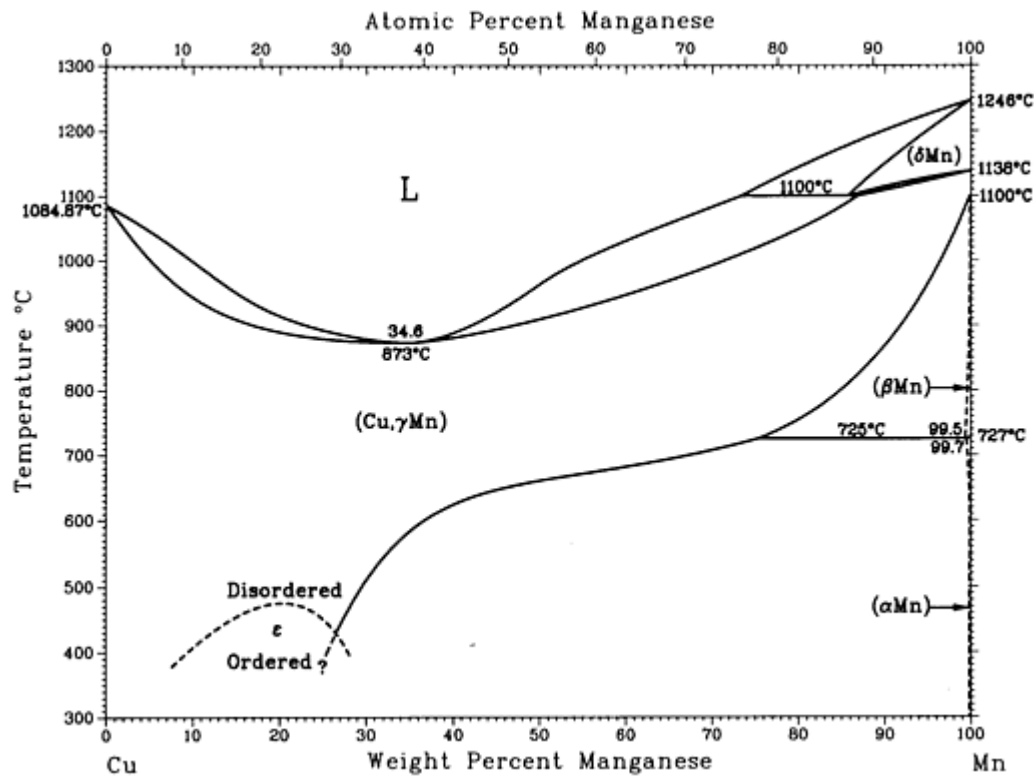

Cu-Mn phase diagram

Cu-Mn crystallographic data

Phase	Composition, wt% Mn	Pearson symbol	Space group
(Cu,γMn)	0 to 100	<i>cF4</i>	<i>Fm</i> $\bar{3}m$
(δMn)	85.8 to 100	<i>cI2</i>	<i>Im</i> $\bar{3}m$
(βMn)	99.5 to 100	<i>cP20</i>	<i>P4</i> ₁ 32
(αMn)	99.7 to 100	<i>cI58</i>	<i>I</i> $\bar{4}$ ₃ <i>m</i>

Cu-Nb (Copper - Niobium)

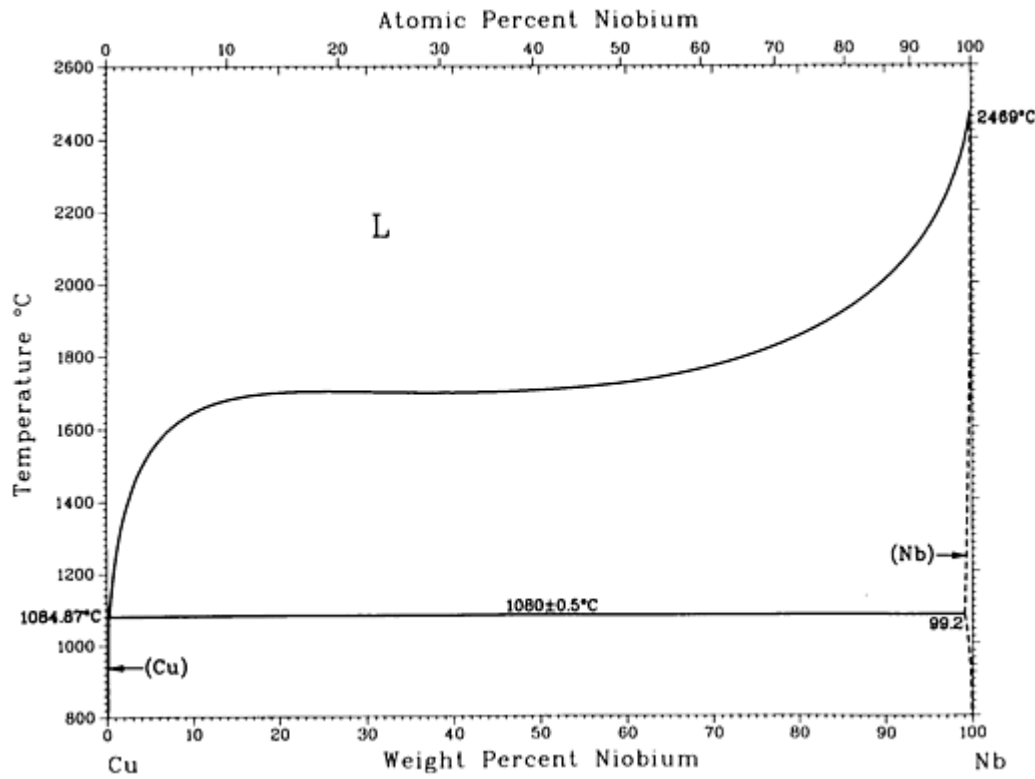

Cu-Nb phase diagram

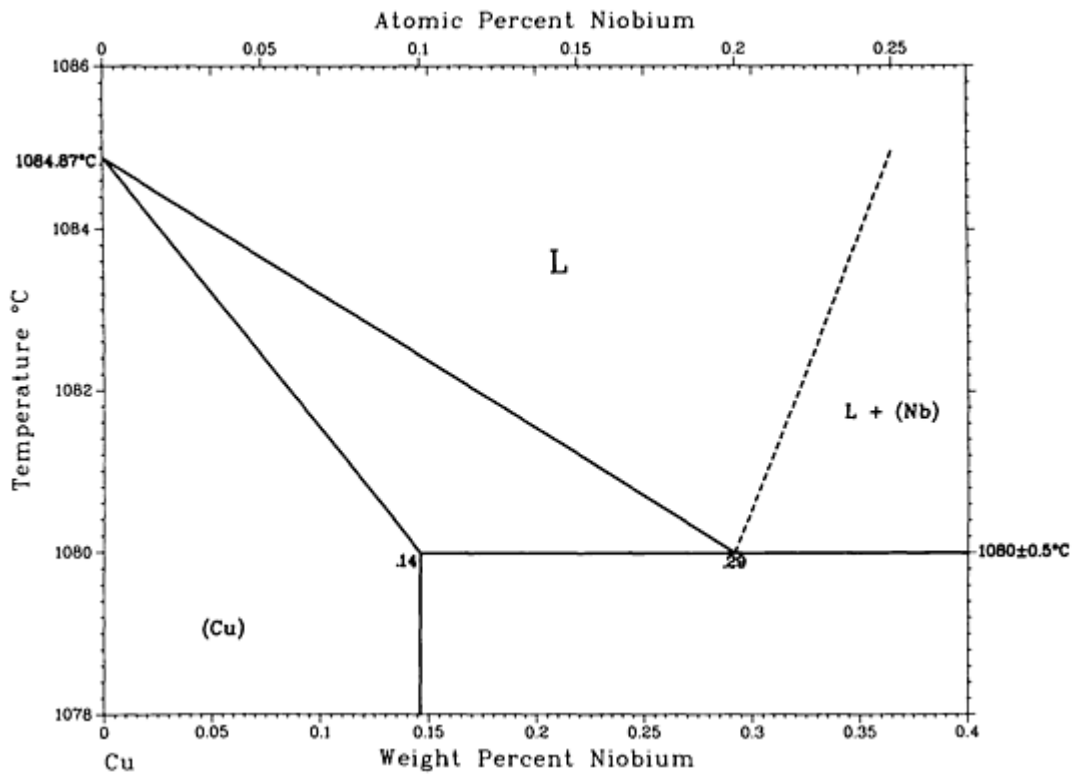

Enlargement of the Cu-rich portion of the Cu-Nb system.

Cu-Nb crystallographic data

Phase	Composition, wt% Nb	Pearson symbol	Space group
(Cu) or α	0 to 0.15	$cF4$	$Fm\bar{3}m$
(Nb) or β	99.2 to 100	$cI2$	$Im\bar{3}m$

Cu-Nd (Copper - Neodymium)

P.R. Subramanian and D.E. Laughlin, 1988

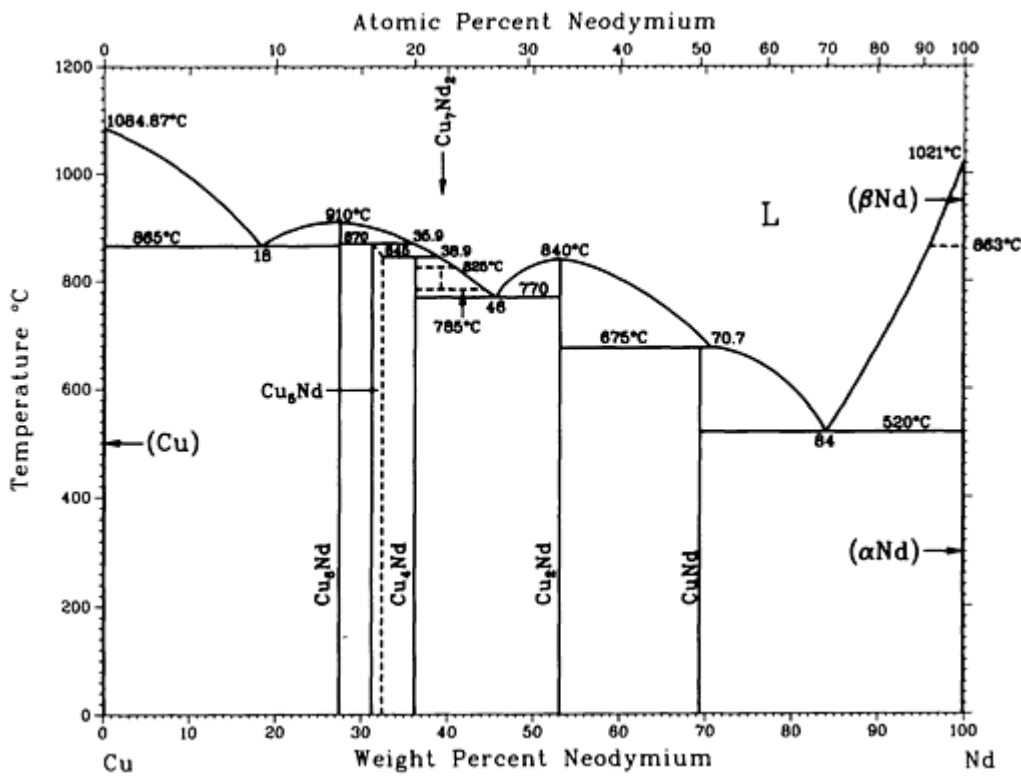

Cu-Nd phase diagram

Cu-Nd crystallographic data

Phase	Composition, wt% Nd	Pearson symbol	Space group
(Cu)	0	$cF4$	$Fm\bar{3}m$
Cu₆Nd	~27.45	$oP28$	$Pnma$
Cu₅Nd	~31.23	$hP6$	$P6/mmm$

Cu_4Nd	~ 36.2	...	$Pnmm$
Cu_2Nd	~ 53.1	$oI12$	$Imma$
CuNd	~ 69	$oP8$	$Pnma$
(βNd)	100	$cI2$	$Im\bar{3}m$
(αNd)	100	$hP4$	$P6_3/mmc$

Cu-Ni (Copper - Nickel)

D.J. Chakrabarti, D.E. Laughlin, S.W. Chen, and Y.A. Chang, 1991

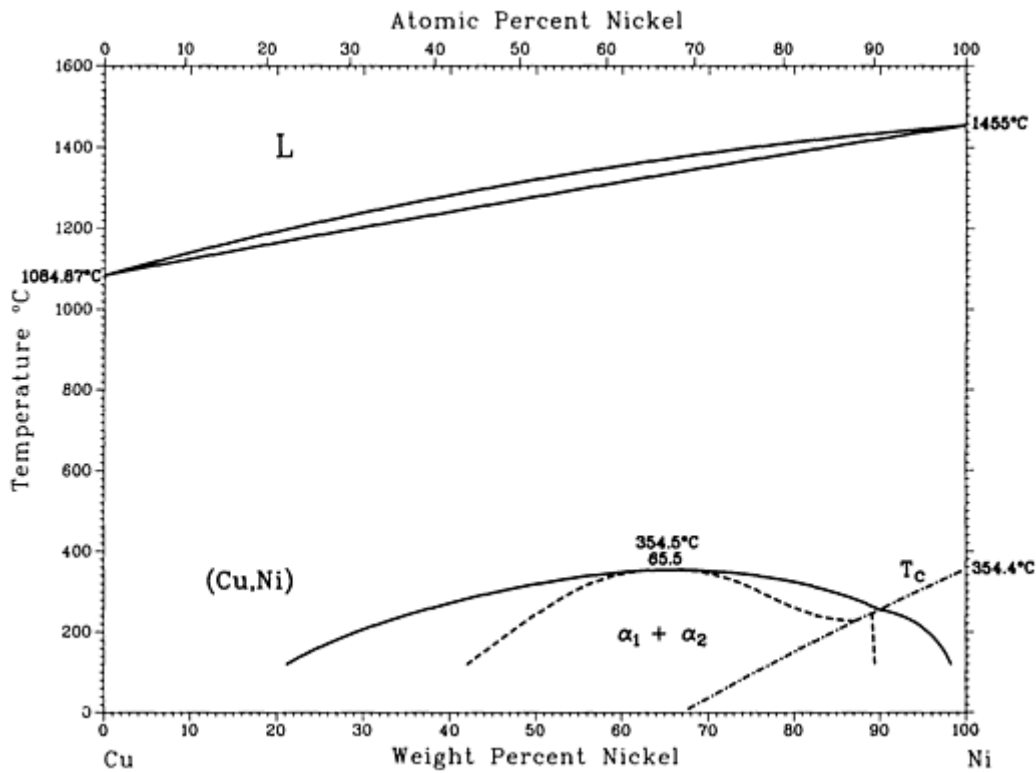

Cu-Ni phase diagram

Cu-Ni crystallographic data

Phase	Composition, wt% Ni	Pearson symbol	Space group
(Cu,Ni)	0 to 100 ^(a)	$cF4$	$Fm\bar{3}m$

(a) Above 354.5 °C

Cu-O (Copper - Oxygen)

J.P. Neumann, T. Zhong, and Y.A. Chang, 1984

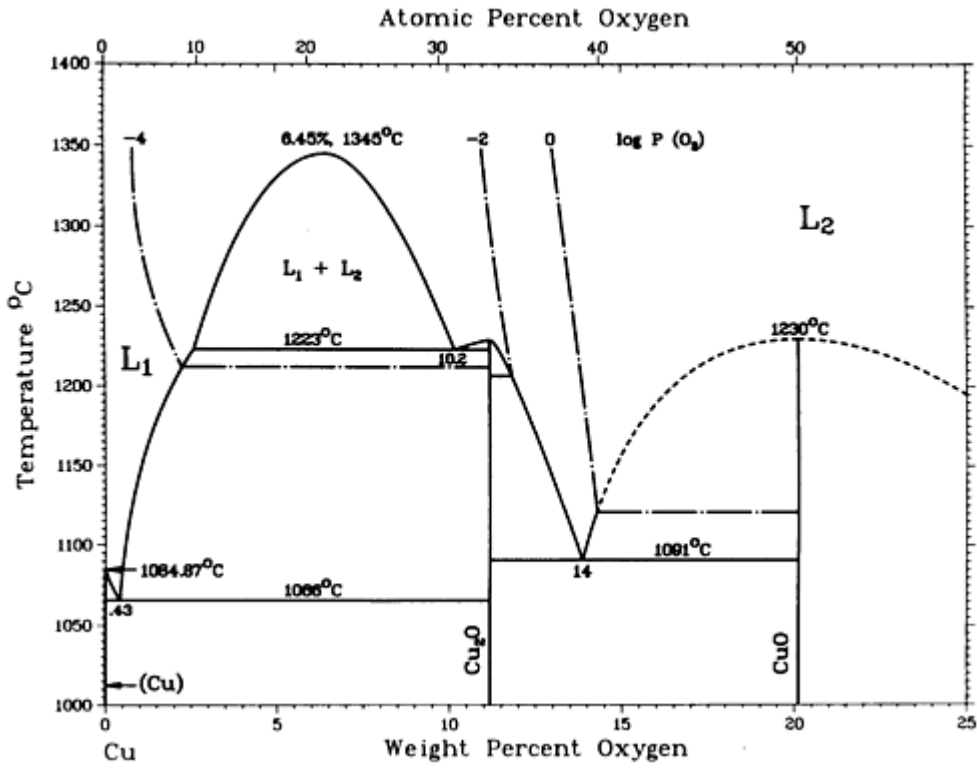

Cu-O phase diagram

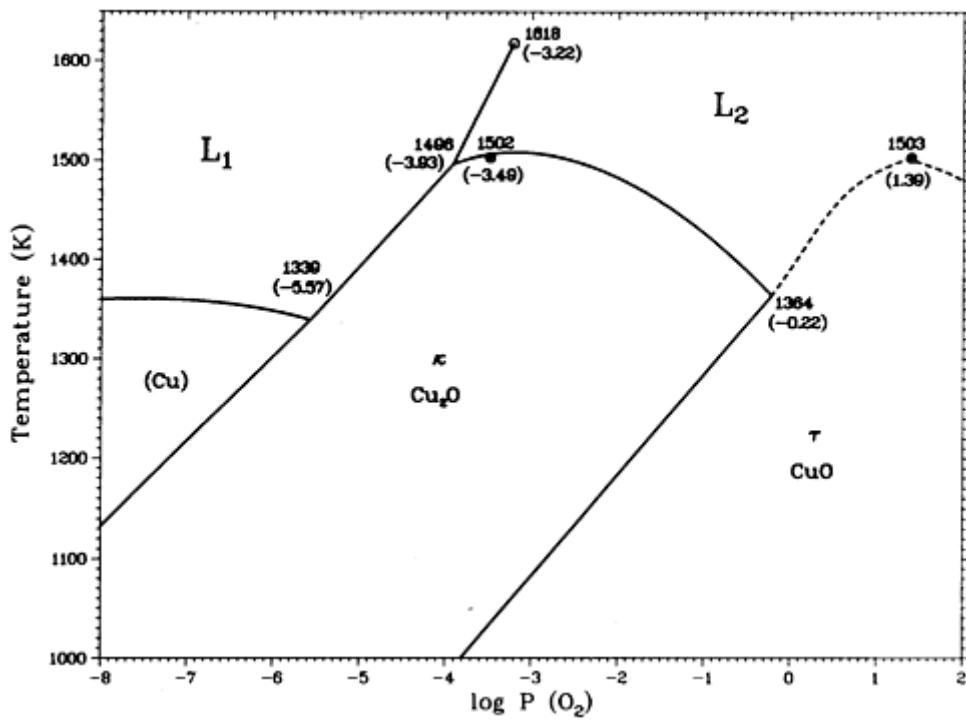

Cu-O stability diagram.

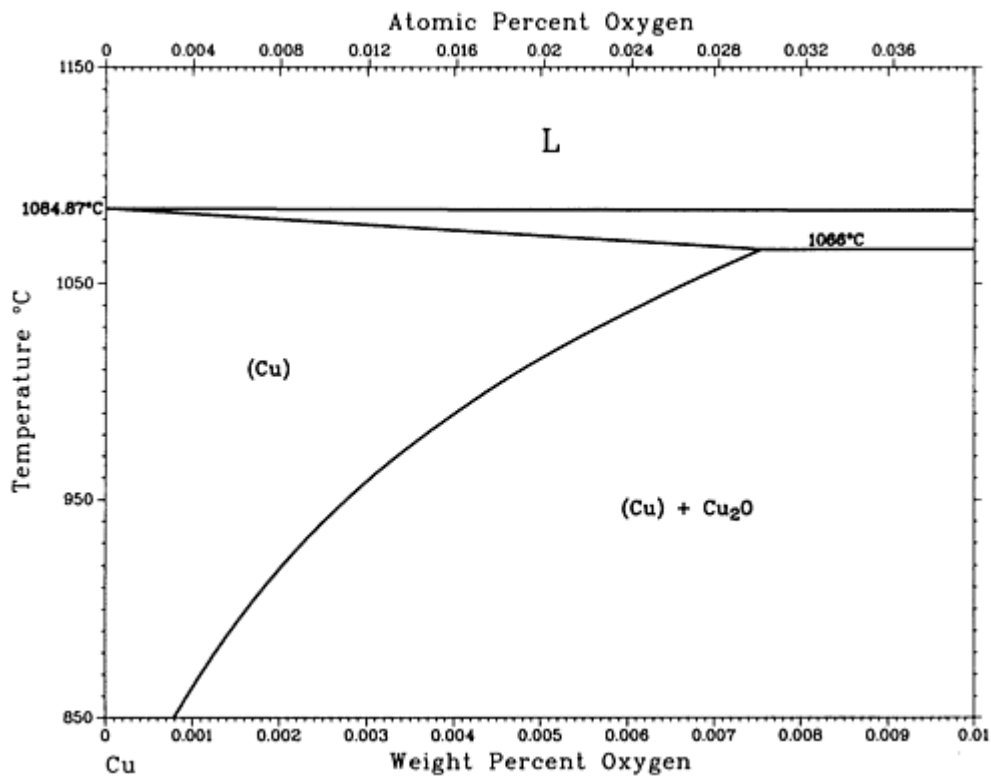

Solubility of O in (Cu).

Cu-O crystallographic data

Phase	Composition	Pearson	Space

	wt% O	symbol	group
(Cu)	0 to 0.008	<i>cF4</i>	<i>Fm$\bar{3}m$</i>
Cu₂O^(a)	11.2	<i>cP6</i>	<i>Pn$\bar{3}m$</i>
CuO^(b)	20	<i>mC8</i>	...
Cu₄O₃^(c)	15.9	<i>tI28</i>	<i>I4/mcm</i>

(a) *K* or cuprite.

(b) *T* or tenorite.

(c) Additional possible phase, *π* or paramelaconite

Cu-P (Copper - Phosphorus)

H. Okamoto, 1990

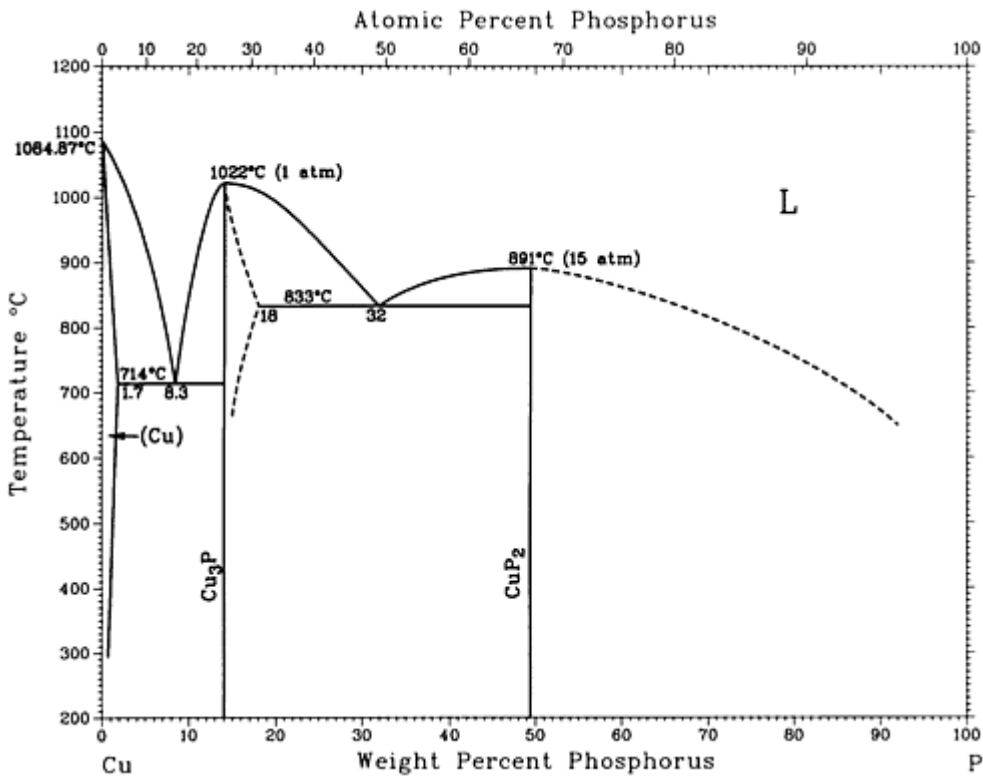

Cu-P phase diagram

Cu-P crystallographic data

Phase	Composition, wt% P	Pearson symbol	Space group
(Cu)	0 to 1.7	<i>cF4</i>	<i>Fm$\bar{3}m$</i>
Cu₃P	14 to 18	<i>hP24</i>	<i>P6₃cm</i>
CuP₂	49.4	<i>mP12</i>	<i>P2₁/c</i>
Cu₂P₇^(a)	63.1	<i>mC72</i>	<i>C2/m</i>

(a) Not shown in the diagram

Cu-Pb (Copper - Lead)

D.J. Chakrabarti and D.E. Laughlin, 1984

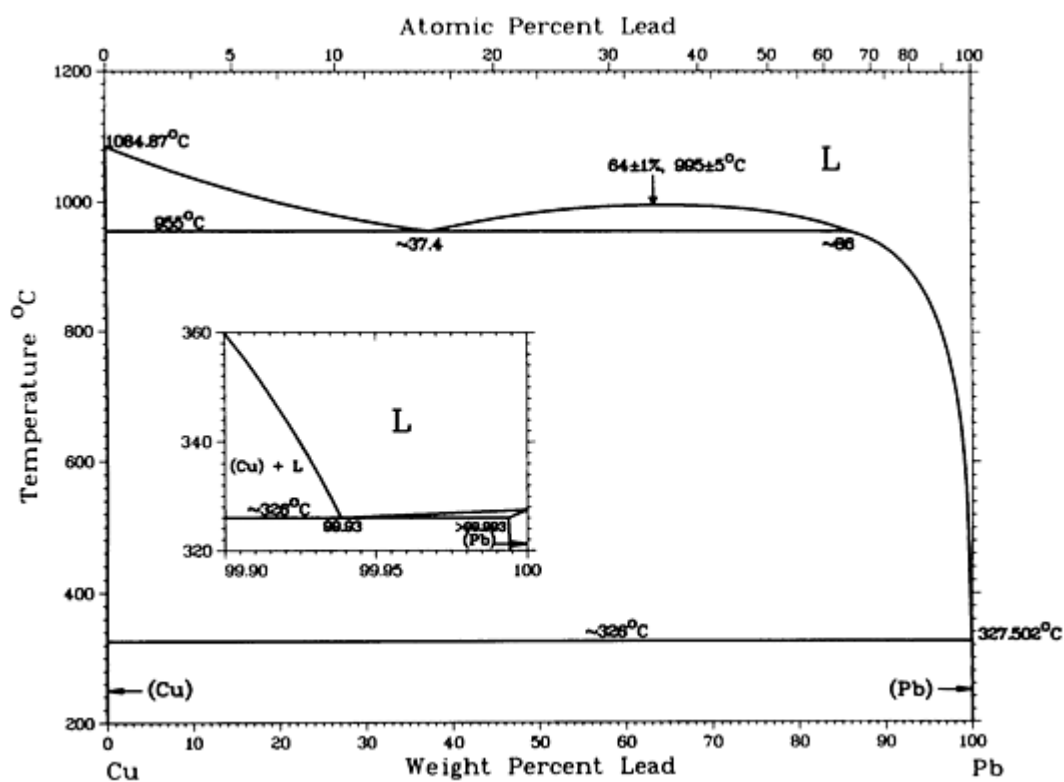

Cu-Pb phase diagram

Cu-Pb crystallographic data

Phase	Composition, wt% Pb	Pearson symbol	Space group
(Cu)	0 ^(a)	<i>cF4</i>	<i>Fm</i> $\bar{3}m$
(α Pb)	100	<i>cF4</i>	<i>Fm</i> $\bar{3}m$
(β Pb) ^(b)	100	<i>hP2</i>	<i>P6</i> ₃ / <i>mmc</i>

(a) Metastable solid solubility may extend up to 10.0 to 12.0 wt% Pb.

(b) Above 10.3 GPa

Cu-Pd (Copper - Palladium)

P.R. Subramanian and D.E. Laughlin, 1991

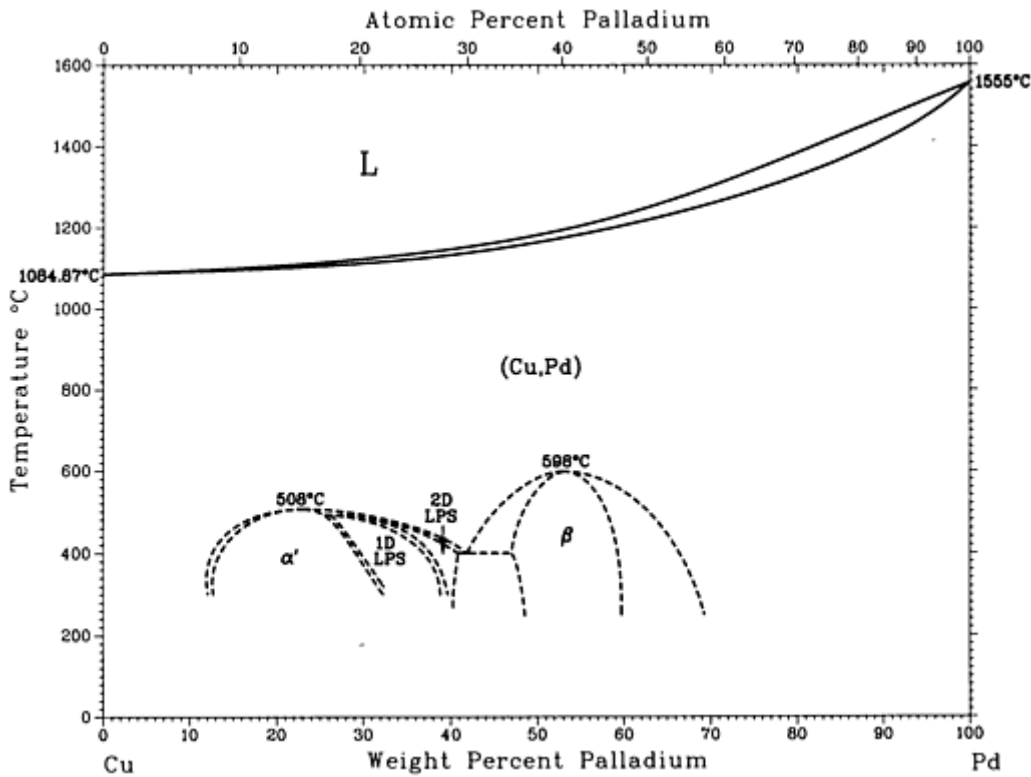

Cu-Pd phase diagram

Cu-Pd crystallographic data

Phase	Composition, wt% Pd	Pearson symbol	Space group
(Cu,Pd)	0 to 100	<i>cF4</i>	<i>Fm$\bar{3}m$</i>
Cu ₃ Pd (α')	~12.1 to ~32	<i>cP4</i>	<i>Pm$\bar{3}m$</i>
Cu ₃ Pd (α'')			
1D-LPS	~26 to ~39	<i>tP28</i>	<i>P4mm</i>
2D-LPS	~28 to ~43
CuPd (β)	~49 to ~60	<i>cP2</i>	<i>Pm$\bar{3}m$</i>

Cu-Pt (Copper - Platinum)

P.R. Subramanian and D.E. Laughlin, unpublished

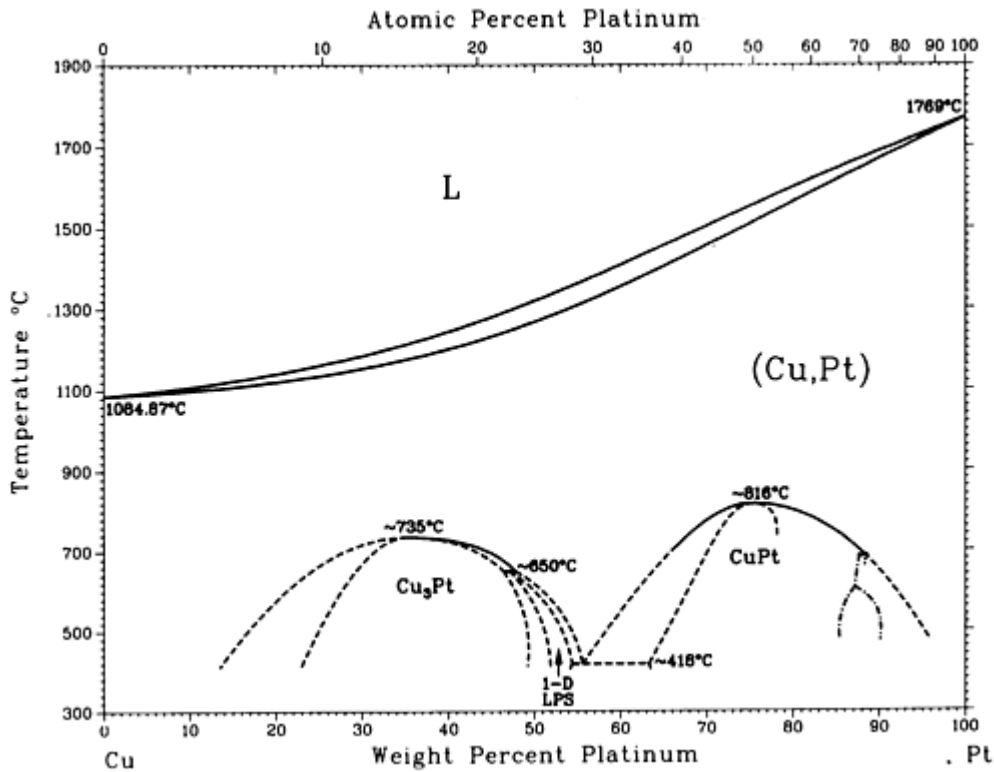

Cu-Pt phase diagram

Cu-Pt crystallographic data

Phase	Composition, wt% Pt	Pearson symbol	Space group
(Cu,Pt)	0 to 100	<i>cF4</i>	<i>Fm</i> $\bar{3}m$
Cu ₃ Pt	~16 to ~52	<i>cP4</i>	<i>Pm</i> $\bar{3}m$
1D-LPS	~43 to ~56	<i>tP28</i>	<i>P4mm</i>
CuPt	~63 to ~81	<i>hR32</i>	<i>R</i> $\bar{3}m$
Cu ₃ Pt ₅	~85 to ~88	<i>hR*</i>	?
CuPt ₃	~87 to ~90	<i>o**</i>	?
CuPt ₃	~88 to ?	<i>c**</i>	?

Cu-Pu (Copper - Plutonium)

V.I. Kutaitsev, N.T. Chebotarev, I.G. Lebedev, M.A. Andrianov, V.N. Konev, and T.S. Menshikova, 1967

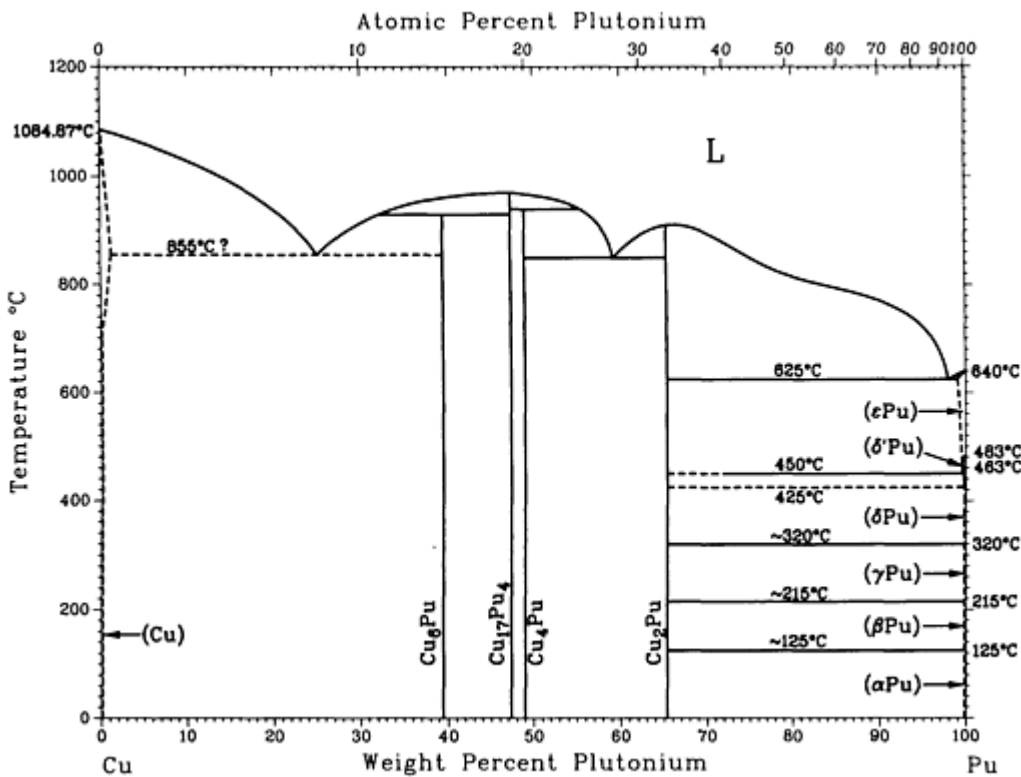

Cu-Pu phase diagram

Cu-Pu crystallographic data

Phase	Composition, wt% Pu	Pearson symbol	Space group
(Cu)	0	<i>cF4</i>	<i>Fm</i> $\bar{3}m$
Cu₆Pu	39.1
Cu₁₇Pu₄	47.4
Cu₄Pu	49	<i>o</i> *20	...
Cu₂Pu	65.7	<i>oI12</i>	<i>Imma</i>
(ϵ Pu)	? to 100	<i>cI2</i>	<i>Im</i> $\bar{3}m$
(δ' Pu)	100	<i>tI2</i>	<i>I4/mmm</i>
(δ Pu)	100	<i>cF4</i>	<i>Fm</i> $\bar{3}m$
(γ Pu)	100	<i>oF8</i>	<i>Fddd</i>
(β Pu)	100	<i>mC34</i>	<i>C2/m</i>
(α Pu)	100	<i>mP16</i>	<i>P2₁/m</i>

Cu-Rh (Copper - Rhodium)

D.J. Chakrabarti and D.E. Laughlin, 1982

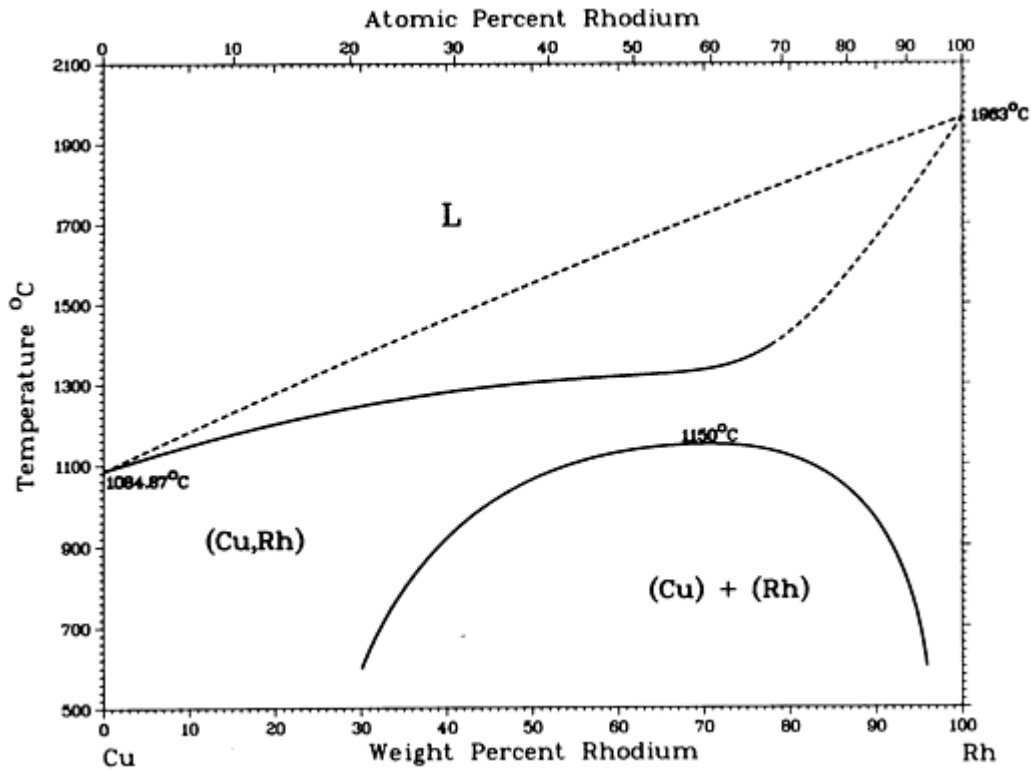

Cu-Rh phase diagram

Cu-Rh crystallographic data

Phase	Composition, wt% Rh	Pearson symbol	Space group
(Cu,Rh)	0 to 100	<i>cF4</i>	<i>Fm</i> $\bar{3}m$

Cu-S (Copper - Sulfur)

D.J. Chakrabarti and D.E. Laughlin, 1983

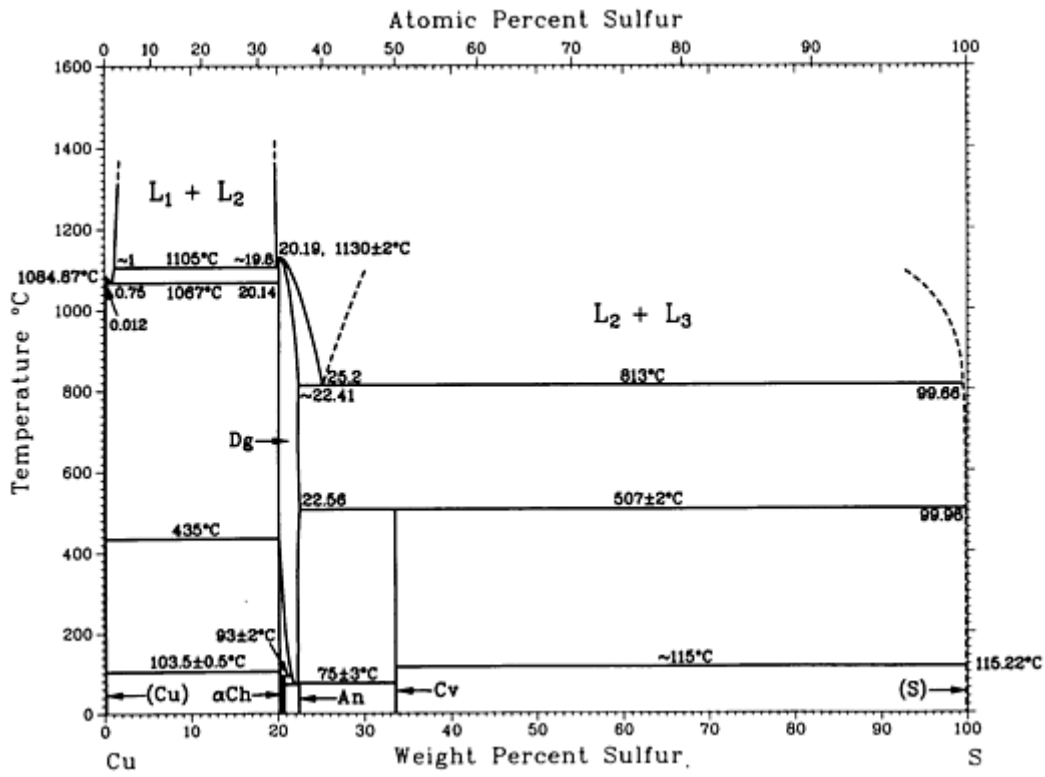

Cu-S phase diagram

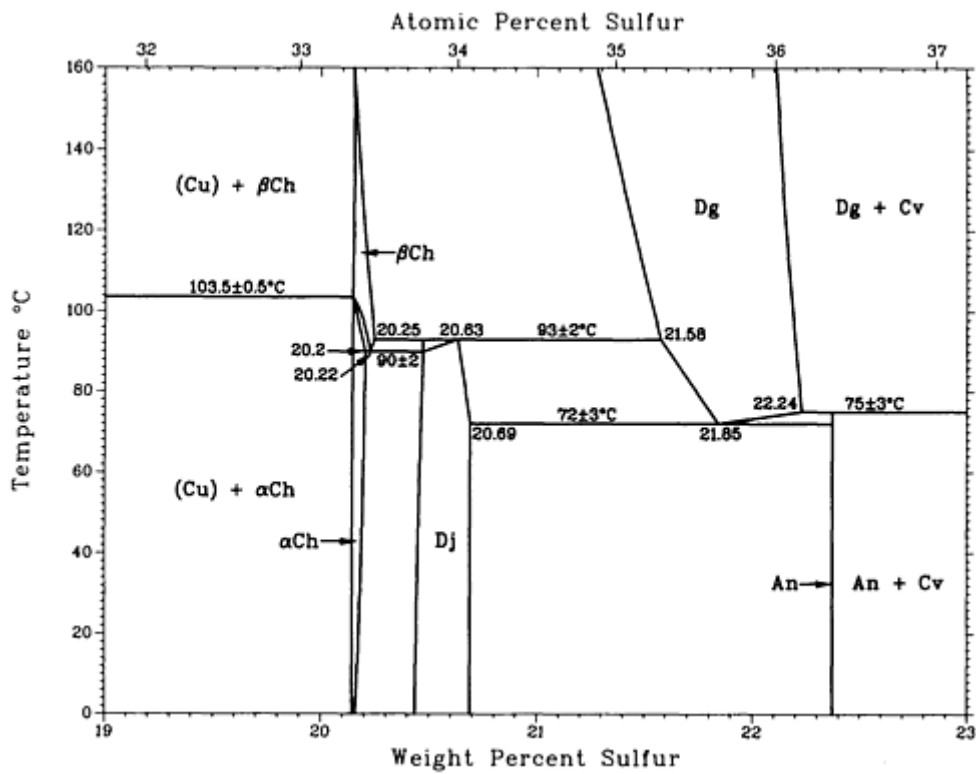

Enlargement of the Cu-S diagram from 0 to 160 °C.

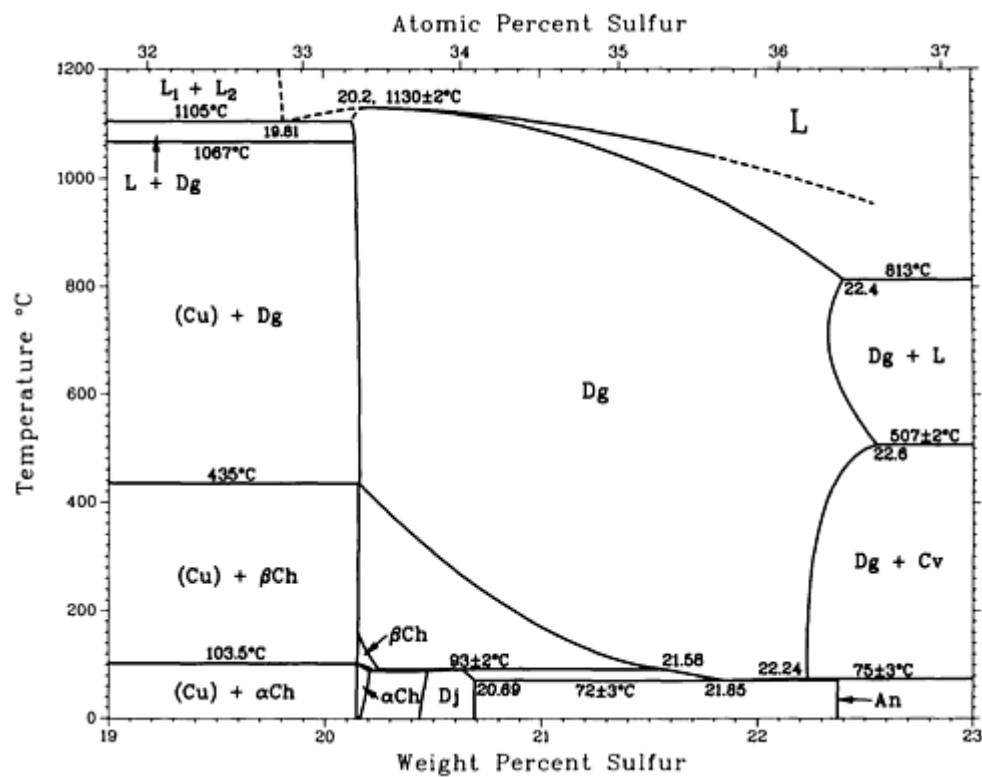

Cu-saturated boundary of digenite phase diagram

Cu-S crystallographic data

Phase	Composition, wt% S(Cu/S)	Pearson symbol	Space group
(Cu)	0 to 0.012	<i>cF4</i>	<i>Fm$\bar{3}m$</i>
α chalcocite (α Cu ₂ S)	20.14 to 20.01	<i>mP144(?)</i>	<i>P2₁/c</i>
β chalcocite (β Cu ₂ S)	20.14 to 20.22	<i>hP6</i>	<i>P6₃/mmc</i>
Djurleite (Cu \sim 1.96S)	20.4 to 20.69	<i>oP380(?)</i>	<i>Pmnm</i> <i>P2₁nm(?)</i> <i>Pmn2₁</i>
Digenite (Cu $^{2-\delta}$ S)	20.14 to 22.24	<i>cF12</i>	<i>Fm$\bar{3}m$</i>
Anilite(Cu _{1.75} S)	22.38 \pm 0.03	<i>oP44(?)</i>	<i>Pnma</i>
Covellite (CuS)	33.5	<i>hP12</i>	<i>P6₃/mmc</i>
(S)	\sim 100	<i>oF128</i> <i>mP48</i> <i>hR6</i>	<i>Fddd</i> <i>P2₁/a</i> <i>R$\bar{3}$</i>
Metastable phases			
Protodjurleite	20.4 (1.00) ^(a) 20.5 (0.999) ^(b)
Tetragonal	20.5 (0.999)	<i>tP12</i>	<i>P4₃2₁2</i>
Hexagonal-tetragonal Cu _x S	20.7 to 22.4 (0.98 to 0.89)
Low digenite (α Dg)	21.99 to 22.22 (0.911 to 0.899) ^(c)	...	<i>R$\bar{3}m$</i>
Blaubleibender covellite I	26.5 \pm 1.4 (0.71 \pm 0.5)
Blaubleibender covellite II	31.6 \pm 1.95 (0.6 \pm 0.1)
CuS ₂	50.23 (0.3)	...	<i>Pa$\bar{3}$(?)</i>

(a) At 75 °C.

(b) At 93 °C.

(c) At 25 °C

Cu-Sb (Copper - Antimony)

P.R. Subramanian, 1990

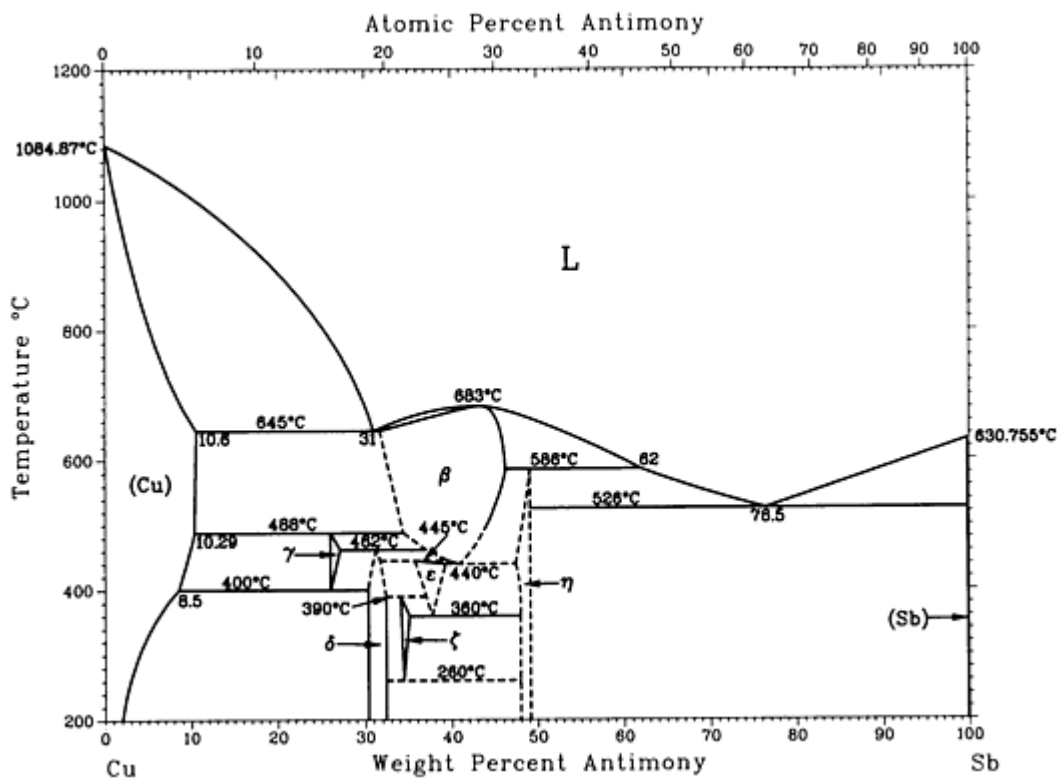

Cu-Sb phase diagram

Cu-Sb crystallographic data

Phase	Composition, wt% Sb	Pearson symbol	Space group
(Cu)	0 to 10.6	<i>cF4</i>	$Fm\bar{3}m$
β	31.6 to 46.0	<i>oF16</i>	$Fm\bar{3}m$
γ	~26.0 to 26.7	<i>hP2</i>	$P6_3/mmc$
δ	30.3 to 32	<i>hP?</i>	$P6_3/mmc$
ϵ	~36.1 to 39.4	<i>oP8</i>	$Pmmn$
ζ	~34.1 to 34.5	<i>hP26</i>	$P\bar{3}$
η	~47.4 to 48.9	<i>iP6</i>	$P4/nmm$
(Sb)	~100	<i>hR2</i>	$R\bar{3}m$

Cu-Se (Copper - Selenium)

D.J. Chakrabarti and D.E. Laughlin, 1981

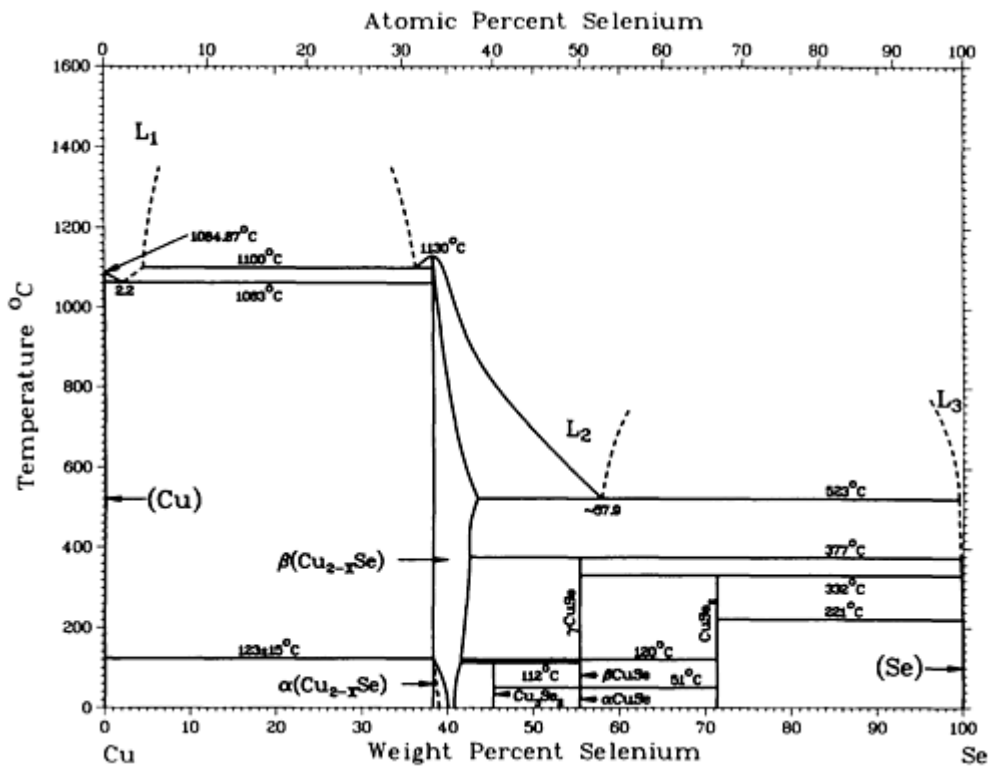

Cu-Se phase diagram

Cu-Se crystallographic data

Phase	Composition, wt% Se	Pearson symbol	Space group
(Cu)	~0	<i>cF4</i>	<i>Fm</i> $\bar{3}m$
α Cu _{2-x} Se	~38.3 to 38.8	(a)	...
β Cu _{2-x} Se	~38.3 to 41.6 ^(b)	<i>cF12</i>	<i>Fm</i> $\bar{3}m$
Cu ₃ Se ₂	45	...	<i>P</i> $\bar{4}2_1m$
α CuSe	55.4	...	<i>P6</i> ₃ / <i>mmc</i>
β CuSe	55.4
γ CuSe	55.4	...	<i>P6</i> ₃ / <i>mmc</i>
CuSe ₂	71.3	<i>oP6</i>	<i>Pnm</i>

(Se) ~100 *hP3* *P3₁21*

(a) Monoclinic.

(b) Homogeneity range at room temperature, $0.18 \leq x \leq 0.22$, and at 500 °C, $x = 0$ to ~ 0.26

Cu-Si (Copper - Silicon)

R.W. Olesinski and G.J. Abbaschian, 1986

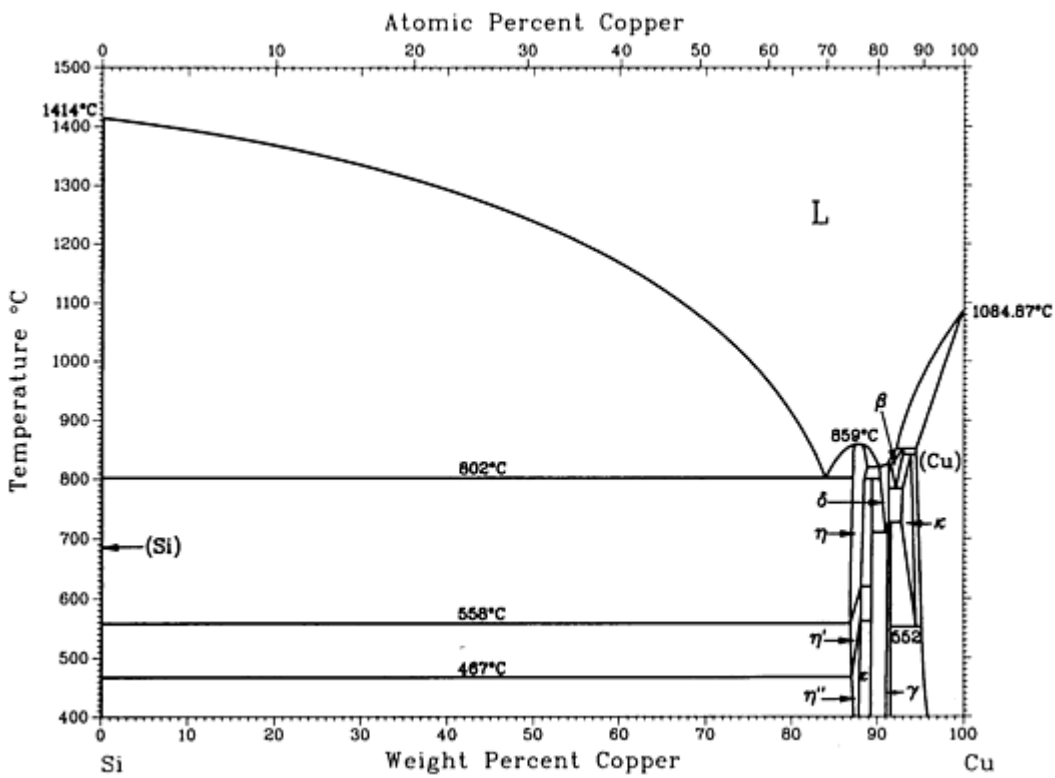

Cu-Si phase diagram

Cu-Si crystallographic data

Phase	Composition, wt% Cu	Pearson symbol	Space group
(Si)	0	<i>cF8</i>	<i>Fd$\bar{3}m$</i>
SiII (HP)	0	<i>tI4</i>	<i>I4₁/amd</i>

$\eta_{\text{r(a)}}$	87.2 to 88.16	(b)	...
$\eta_{\text{r(a)}}$	87.0 to 88.22	(c)	$R\bar{3}$
$\eta_{\text{r(a)}}$	87.2 to 88.8	(c)	$R\bar{3}m$
$\epsilon^{(d)}$	89.3 to 89.4	(e)	...
δ	90.3 to 91.4	(f)	...
$\gamma^{(g)}$	91.4 to 91.62	<i>cP20</i>	<i>P4₁32</i>
β	91.6 to 93.2	<i>cI2</i>	<i>Im\bar{3}m</i>
$\kappa^{(h)}$	93.0 to 94.80	<i>hP2</i>	<i>P6₃/mmc</i>
(Cu)	94.6 to \sim 100	<i>cF4</i>	<i>Fm\bar{3}m</i>
Other reported phases			
$\eta_{\text{r(i)}}$...	(f)	...
Metastable	...	(f)	...

(a) Also denoted
Cu₃Si.

(b) Orthorhombic.

(c) Rhombohedral.

(d) Also denoted
Cu₁₅Si₄.

(e) Cubic.

(f) Tetragonal.

(g) Also denoted

Cu₅Si.

(h) Also denoted
Cu₇Si.

(i) Originally
denoted η' .

Cu-Sn (Copper - Tin)

N. Saunders and A.P. Miodownik, 1990

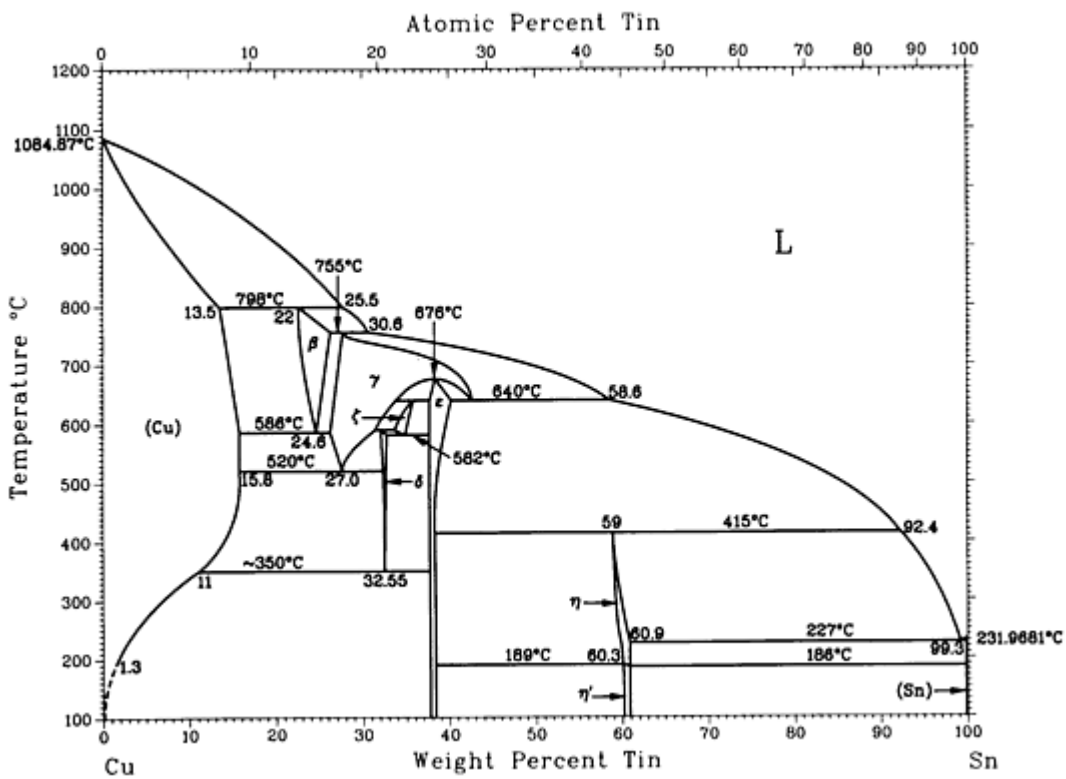

Cu-Sn phase diagram

Cu-Sn crystallographic data

Phase	Composition, wt% Sn	Pearson symbol	Space group
α	0 to 15.8	<i>cF4</i>	<i>Fm</i> $\bar{3}m$
β	22.0 to 27.0	<i>cI2</i>	<i>Im</i> $\bar{3}m$

γ	25.5 to 41.5	<i>cF16</i>	<i>Fm</i> $\bar{3}m$
δ	32 to 33	<i>cF416</i>	<i>F</i> $\bar{4}3m$
ζ	32.2 to 35.2	<i>hP26</i>	<i>P6</i> ₃
ϵ	27.7 to 39.5	<i>oC80</i>	<i>Cmcm</i>
η	59.0 to 60.9	<i>hP4</i>	<i>P6</i> ₃ / <i>mmc</i>
η'	44.8 to 60.9	^(a)	...
(β Sn)	~ 100	<i>tI4</i>	<i>I4</i> ₁ / <i>amd</i>
(α Sn)	100	<i>cF8</i>	<i>Fd</i> $\bar{3}m$

Note: Lattice parameter data can be found in [Pearson3] 14.

(a) Hexagonal; superlattice based on NiAs-type structure

Reference cited in this section

14. [Pearson3]: P. Villars and L.D. Calvert, *Pearson's Handbook of Crystallographic Data for Intermetallic Phases*, Vol.1, 2, and 3, American Society for Metals, Metals Park, OH (1985).

Cu-Sr (Copper - Strontium)

D.J. Chakrabarti and D.E. Laughlin, 1984

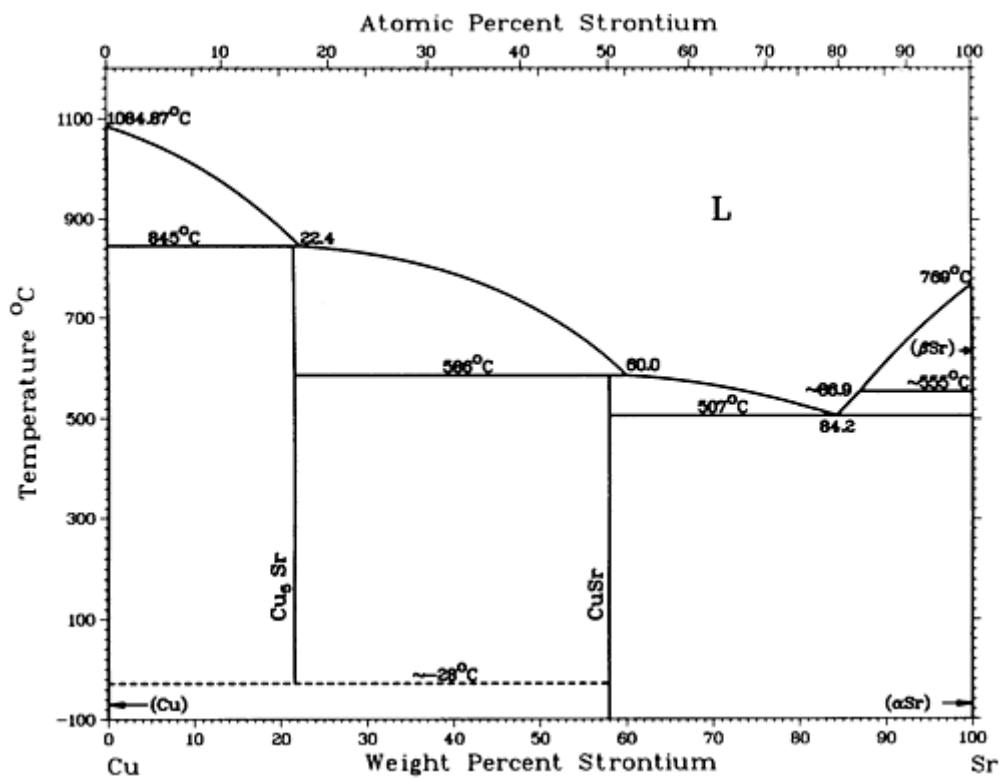

Cu-Sr phase diagram

Cu-Sr crystallographic data

Phase	Composition wt% Sr	Pearson symbol	Space group
(Cu)	0	<i>cF4</i>	<i>Fm</i> $\bar{3}m$
Cu₅Sr	21.62	<i>hP6</i>	<i>P6/mmm</i>
CuSr	58.0	<i>hP8(?)</i>	<i>P6₃/mmc</i>
(βSr)	100	<i>cI2</i>	<i>Im</i> $\bar{3}m$
(αSr)	100	<i>cF4</i>	<i>Fm</i> $\bar{3}m$
Pressure-stabilized form			
βSr or Sr-II	100	<i>cI2</i>	<i>Im</i> $\bar{3}m$

Cu-Te (Copper - Tellurium)

H. Okamoto, unpublished

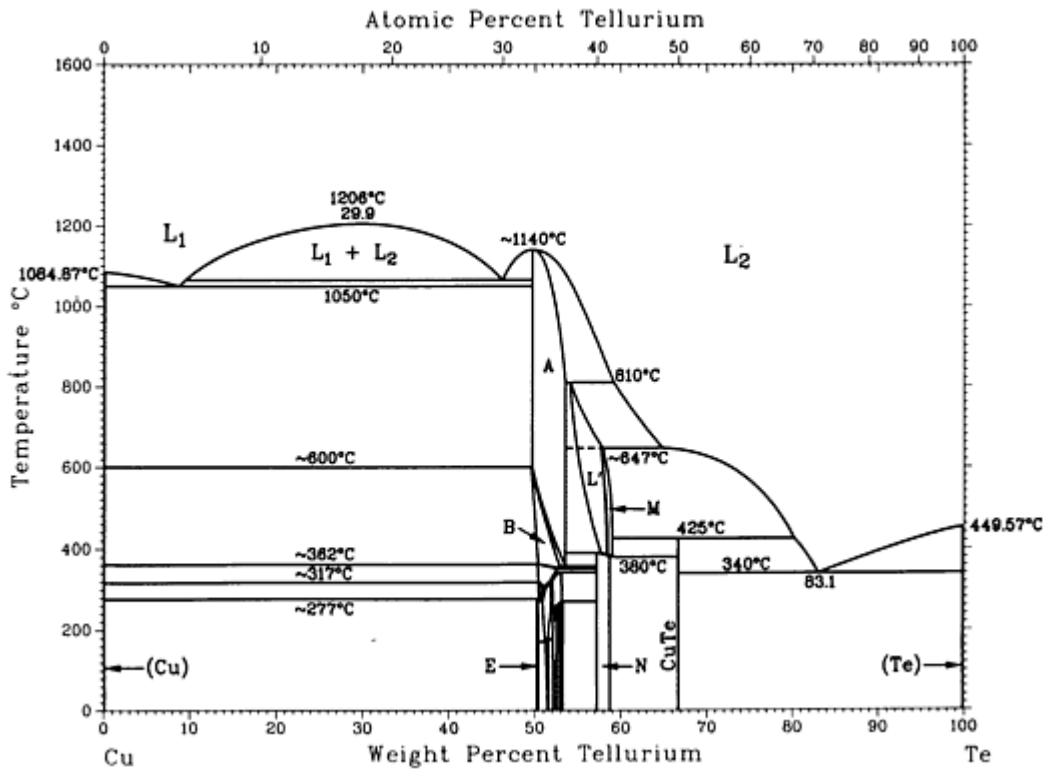

Cu-Te phase diagram

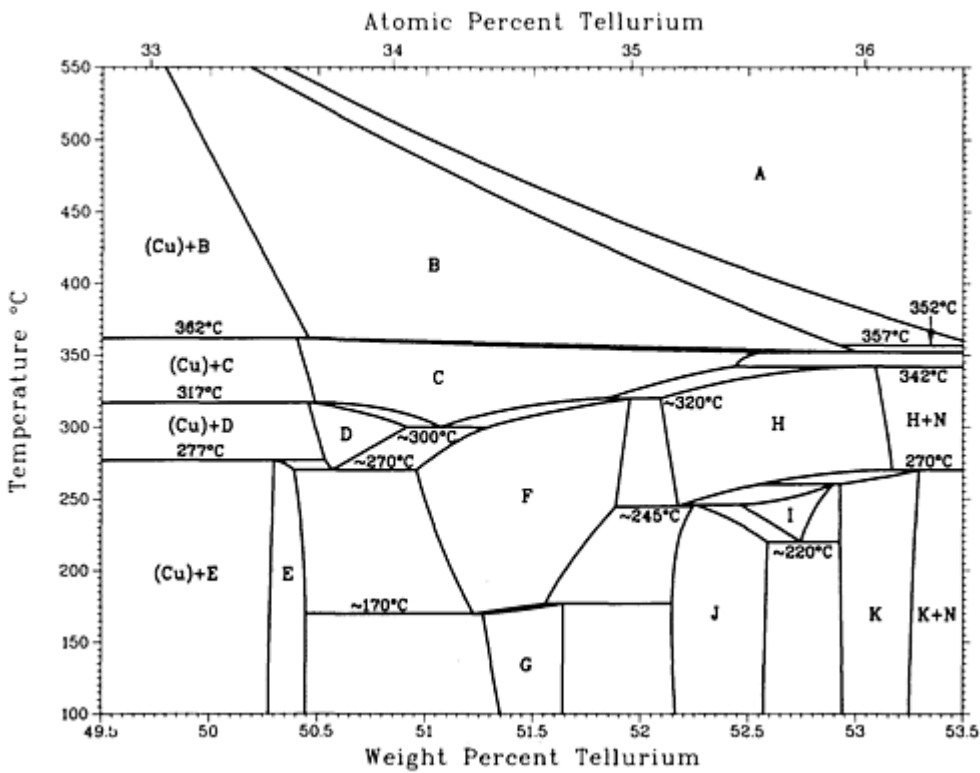

Details of the Cu-Te phase diagram from 49.7 to 53.6 wt% Te.

Cu-Te crystallographic data

Phase	Composition wt% Te	Pearson symbol	Space group
(Cu)	0	<i>cF2</i>	<i>Fm</i> $\bar{3}m$
Cu₂Te group			
A	50 to 53.6	<i>cF12</i>	<i>Fd</i> $\bar{3}m$
B	50 to 52.99	<i>hP6</i>	<i>P6/mmm</i>
C	50.4 to 52.5	<i>hP*</i>	...
D	50.46 to 51.1	<i>o**</i>	...
E	50.3 to 50.46	<i>o**</i>	...
F	51.0 to 52	<i>o**</i>	...
G	51.3 to 51.6	<i>o**</i>	...
H	52.12 to 53.1	<i>hP72</i>	<i>P3m1</i>
I	52.23 to 52.88
J	52.23 to 52.6	<i>hP*</i>	...
K	52.9 to 53.3	<i>hP22</i>	<i>P3m1</i>
L	54 to 58	<i>tP6</i>	<i>P4/nmm</i>
L'	55 to 58
M	58 to 59
N	57 to 58.8
CuTe	67	<i>oP4</i>	<i>Pmmn</i>
(Te)	100	<i>hP3</i>	<i>P3₁21</i>

High-pressure phase			
CuTe_2	50.1	<i>cP12</i>	<i>Pa3</i>

Cu-Th (Copper - Thorium)

D.J. Chakrabarti, D.E. Laughlin, and D.E. Peterson, 1986

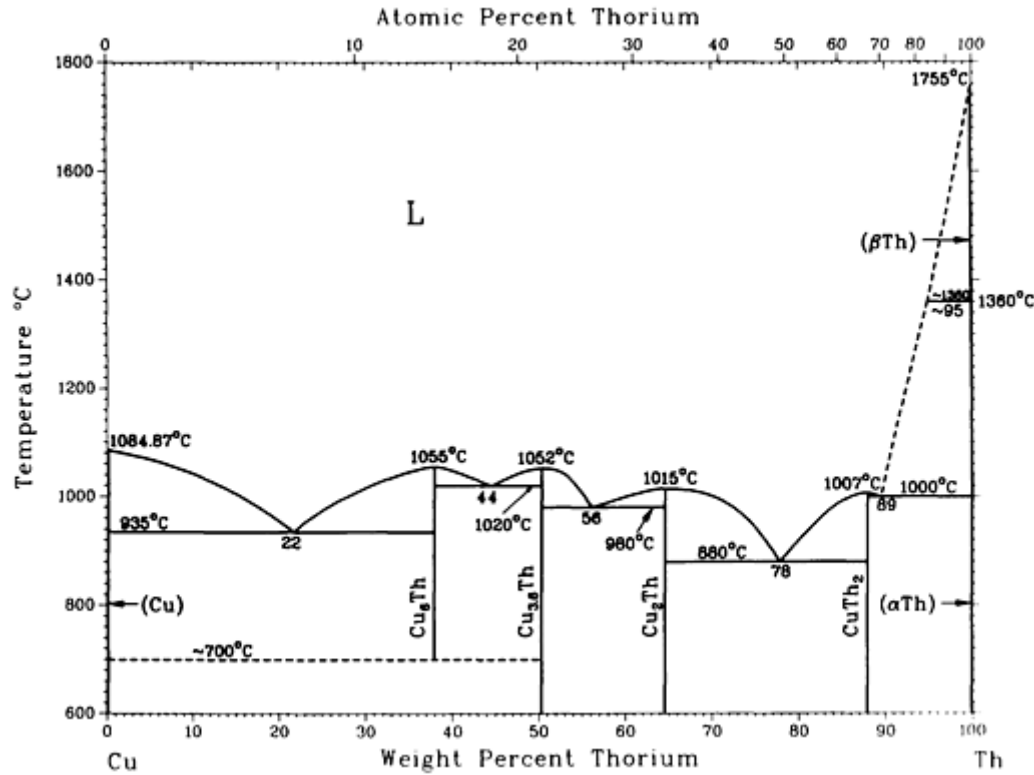

Cu-Th phase diagram

Cu-Th crystallographic data

Phase	Composition wt% Th	Pearson symbol	Space group
(Cu)	0	<i>cF4</i>	<i>Fm$\bar{3}m$</i>
Cu_6Th	37.84	<i>oP28?</i>	<i>Pnma</i>
$\text{Cu}_{3.6}\text{Th}$	50.36	^(a)	<i>P6/m</i>
Cu_2Th	64.61	<i>hP3</i>	<i>P6/mmm</i>

$\text{CuTh}^{(b)}$	79	<i>oC8</i>	<i>Cmcm</i>
CuTh_2	87.96	<i>tI12</i>	<i>I4/mcm</i>
(βTh)	100	<i>cI2</i>	<i>Im\bar{3}m</i>
(αTh)	100	<i>cF4</i>	<i>Fm\bar{3}m</i>

(a) Hexagonal.

(b) Metastable

Cu-Ti (Copper - Titanium)

J.L. Murray, 1987

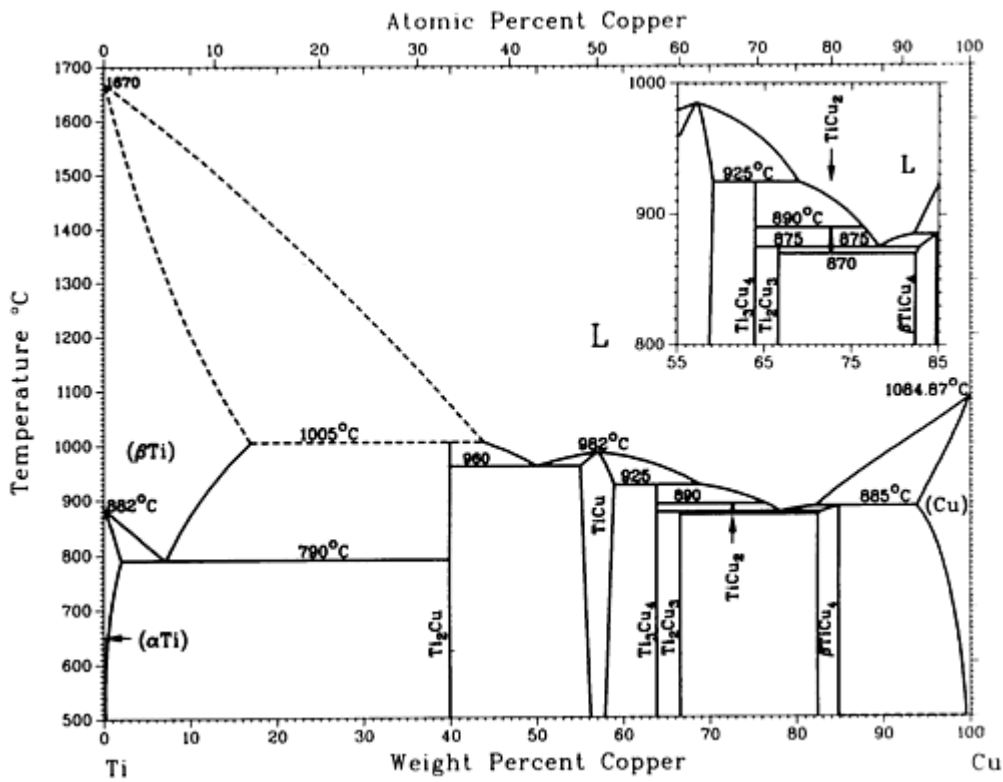

Cu-Ti phase diagram

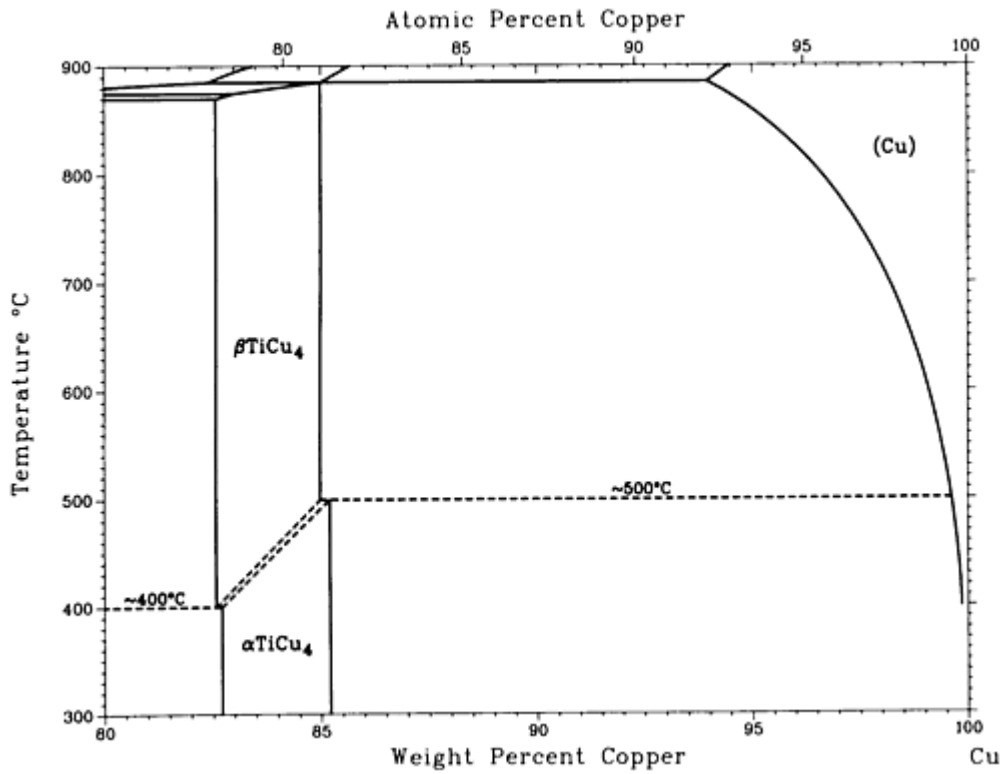

Transformation of $\beta\text{TiCu}_4 \leftrightarrow \alpha\text{TiCu}_4$.

Cu-Ti crystallographic data

Phase	Composition wt% Cu	Pearson symbol	Space group
(αTi)	0 to 2.1	<i>hP2</i>	<i>P6₃/mmc</i>
(βTi)	0 to 17.2	<i>cI2</i>	<i>Im$\bar{3}m$</i>
Ti_2Cu	39.9	<i>tI6</i>	<i>I4/mmm</i>
TiCu	55 to 59	<i>tP4</i>	<i>P4/nmm</i>
Ti_3Cu_4	63.9	<i>tI14</i>	<i>I4/mmm</i>
Ti_2Cu_3	67	<i>tP10</i>	<i>P4/nmm</i>
TiCu_2	72.7	<i>oC12</i>	<i>Amm2</i>
TiCu_4	83 to 84.9	<i>oP20</i>	<i>Pnma</i>

αTiCu_4	~83 to 84.9	<i>tI10</i>	<i>I4/m</i>
(Cu)	94 to 100	<i>cF4</i>	<i>Fm\bar{3}m</i>
Metastable phases			
TiCu_3	...	<i>oP8</i>	<i>Pmnm</i>
$\beta_{..}$...	<i>tP2</i>	<i>P4/mmm</i>

Cu-Tl (Copper - Thallium)

D.J. Chakrabarti and D.E. Laughlin, 1984

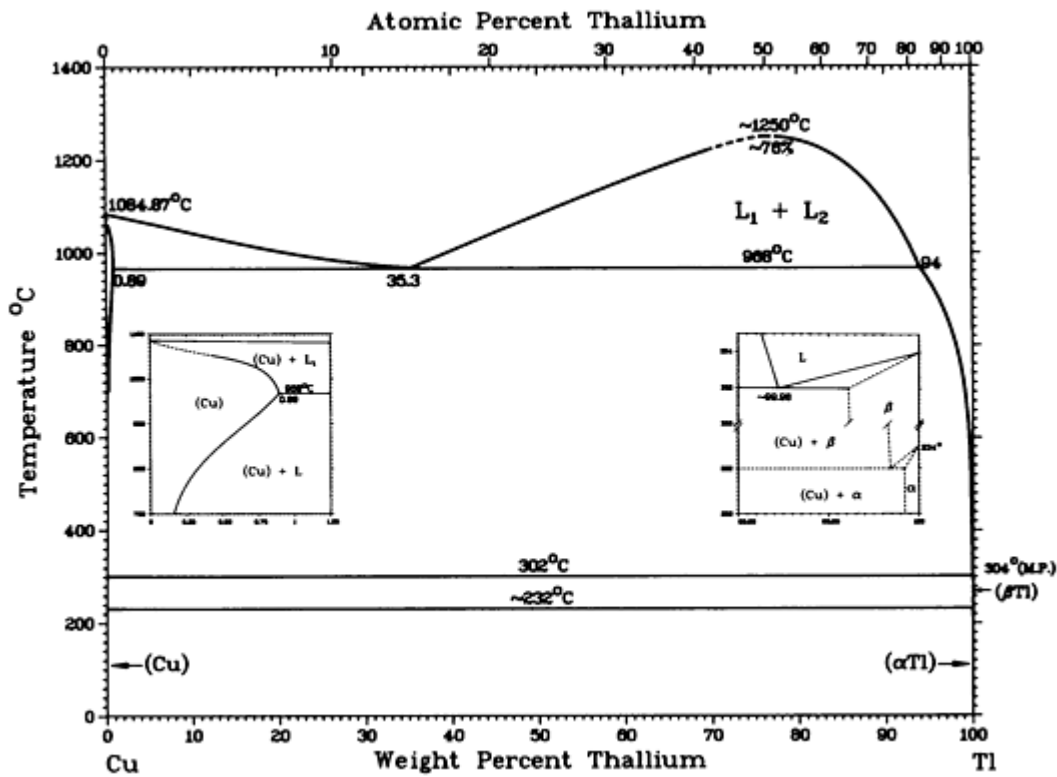

Cu-Tl phase diagram

Cu-Tl crystallographic data

Phase	Composition, wt% Tl	Pearson symbol	Space group
(Cu)	0 to 0.89	<i>cF4</i>	<i>Fm\bar{3}m</i>

(αTi)	100	$hP2$	$P6_3/mmc$
(βTi)	100	$cI2$	$Im\bar{3}m$
Pressure-stabilized phase			
γTi	100	$cF?$...

Cu-V (Copper - Vanadium)

J.F. Smith and O.N. Carlson, 1989

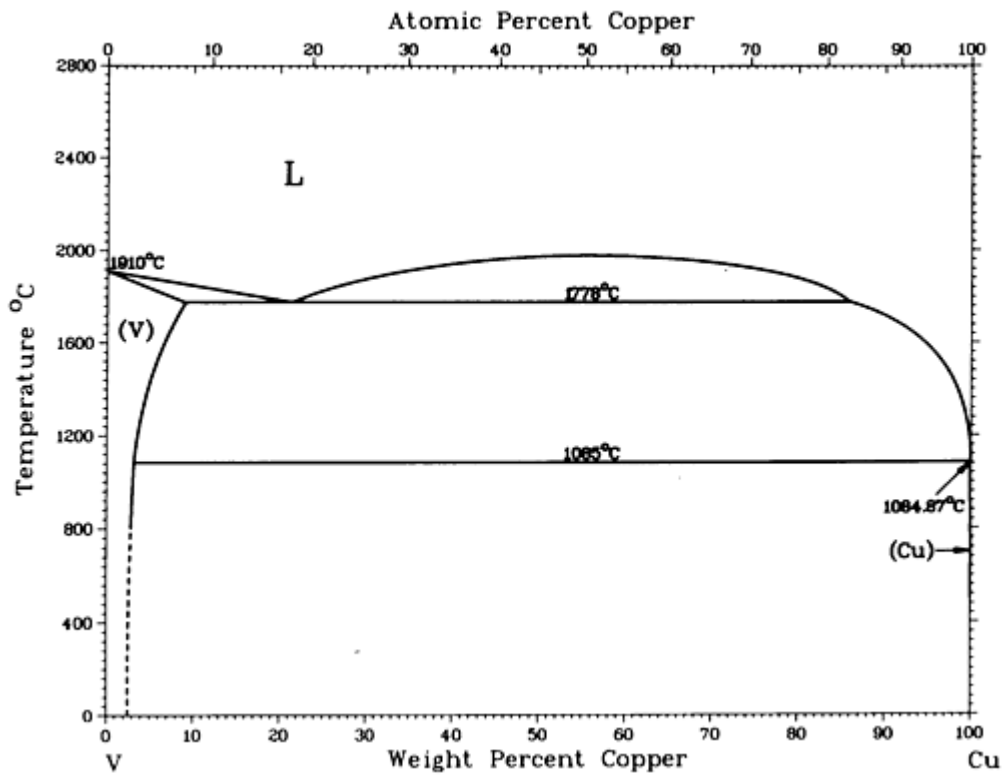

Cu-V phase diagram

Cu-V crystallographic data

Phase	Composition, wt% Cu	Pearson symbol	Space group
(V)	0 to 9.2	$cI2$	$Im\bar{3}m$
(Cu)	99.9 to 100	$cF4$	$Fm\bar{3}m$

Cu-Yb (Copper - Ytterbium)

P.R. Subramanian and D.E. Laughlin, 1988

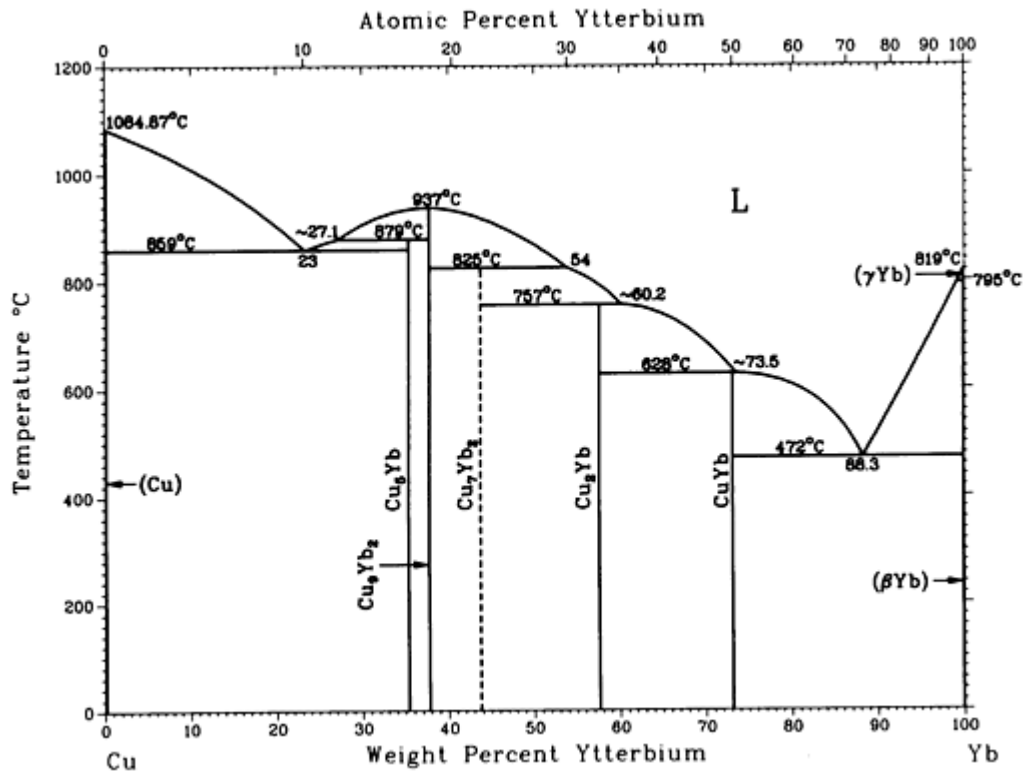

Cu-Yb phase diagram

Cu-Yb crystallographic data

Phase	Composition, wt% Yb	Pearson symbol	Space group
(Cu)	0	<i>cF4</i>	<i>Fm</i> $\bar{3}m$
Cu ₅ Yb	~35.26	<i>hP6</i>	<i>P6/mmm</i>
Cu ₂ Yb	~57.6	<i>oI12</i>	<i>Imma</i>
CuYb	~73.1	<i>oP8</i>	<i>Pnma</i>
(γYb)	100	<i>cI2</i>	<i>Im</i> $\bar{3}m$
(βYb)	~99.99 to 100	<i>cF4</i>	<i>Fm</i> $\bar{3}m$
(αYb)	100	<i>hP2</i>	<i>P6₃/mmc</i>

Cu-Zn (Copper - Zinc)

A.P. Miodownik, unpublished

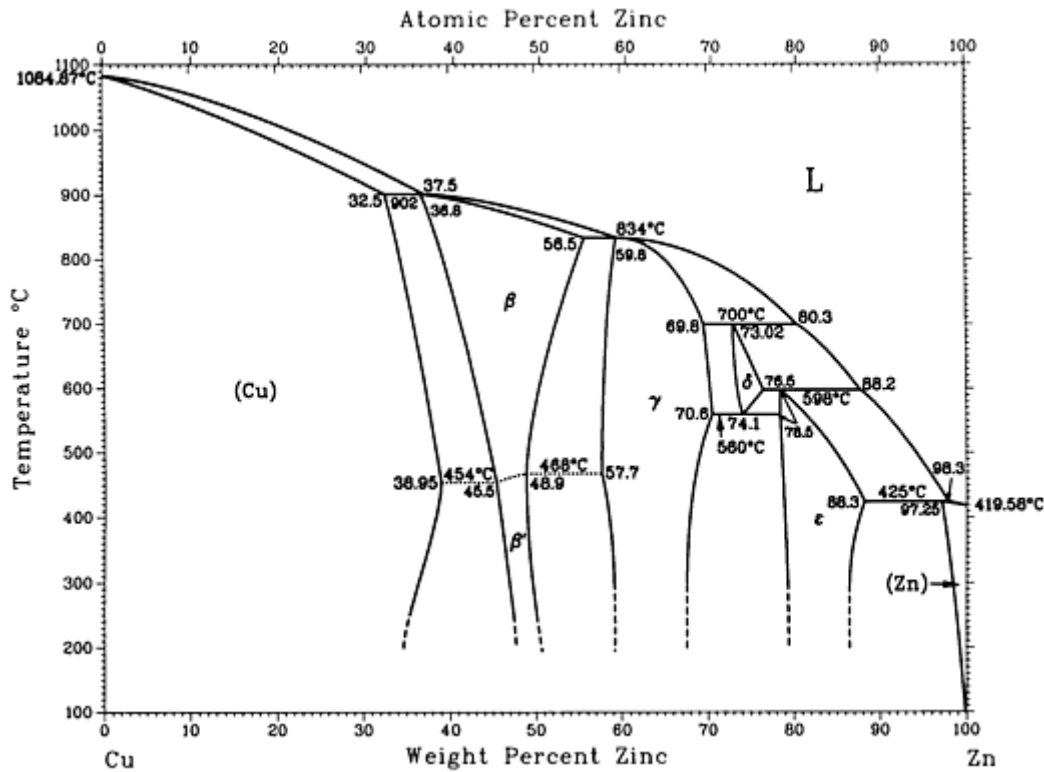

Cu-Zn phase diagram

Cu-Zn crystallographic data

Phase	Composition, wt% Zn	Pearson symbol	Space group
α or (Cu)	0 to 38.95	<i>cF4</i>	<i>Fm</i> $\bar{3}m$
β	36.8 to 56.5	<i>cI2</i>	<i>Im</i> $\bar{3}m$
β'	45.5 to 50.7	<i>cP2</i>	<i>Pm</i> $\bar{3}m$
γ	57.7 to 70.6	<i>cI52</i>	$\bar{1}43m$
δ	73.02 to 76.5	<i>hP3</i>	<i>P</i> $\bar{6}$
ϵ	78.5 to 88.3	<i>hP2</i>	<i>P6</i> ₃ / <i>mmc</i>
η or (Zn)	97.25 to 100	<i>hP2</i>	<i>P6</i> ₃ / <i>mmc</i>

Cu-Zr (Copper - Zirconium)

D. Arias and J.P. Abriata, 1990

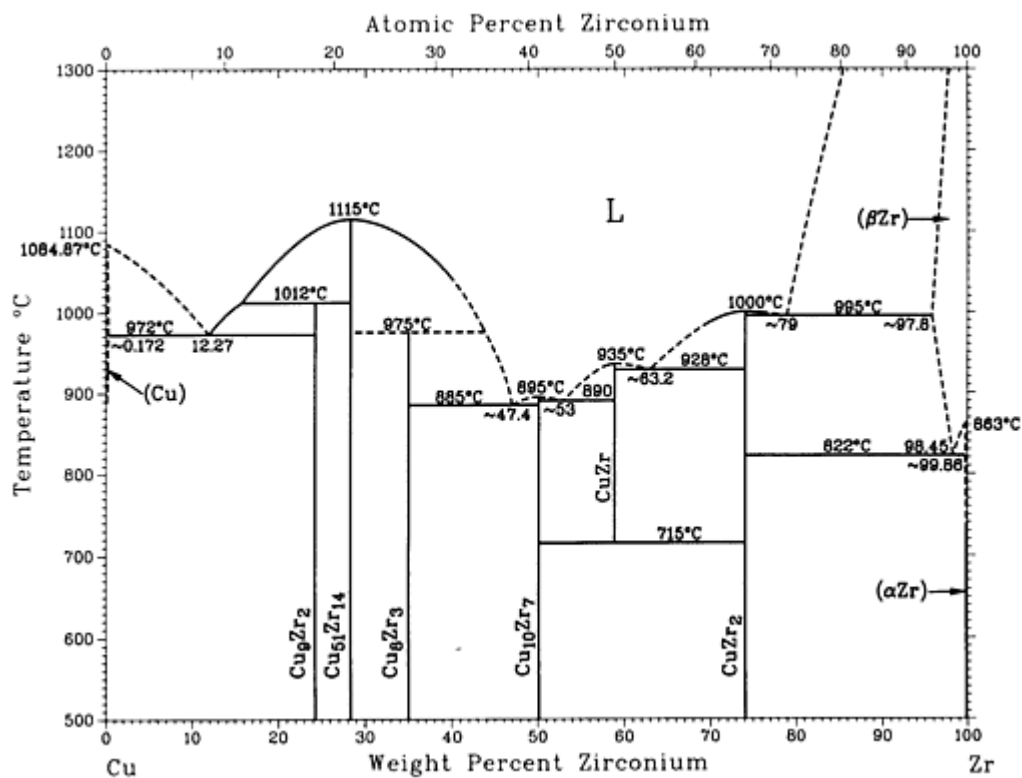

Cu-Zr phase diagram

Cu-Zr crystallographic data

Phase	Composition, wt% Zr	Pearson symbol	Space group
(Cu)	0 to ~0.172	<i>cF4</i>	<i>Fm</i> $\bar{3}m$
Cu₉Zr₂ ^(a)	24.18	<i>tP24</i>	<i>P4/m</i>
Cu₅₁Zr₁₄	28.27	<i>hP65</i>	<i>P6/m</i>
Cu₈Zr₃	34.99	<i>oP44</i>	<i>Pnma</i>
Cu₁₀Zr₇	50.13	<i>oC68</i>	...
CuZr	58.9	<i>cP2</i>	<i>Pm</i> $\bar{3}m$
CuZr₂	74.17	<i>tI6</i>	<i>I4/mmm</i>

(βZr)	~ 97.8 to 100	$cI2$	$Im\bar{3}m$
(αZr)	~ 99.86 to 100	$hP2$	$P6_3/mmc$

(a) Tetragonal long-period superlattice derived from the AuBe₅-type structure

Dy (Dysprosium) Binary Alloy Phase Diagrams

Introduction

THIS ARTICLE includes systems where dysprosium is the first-named element in the binary pair. Additional binary systems that include dysprosium are provided in the following locations in this Volume:

- “Ag-Dy (Silver - Dysprosium)” in the article “Ag (Silver) Binary Alloy Phase Diagrams.”
- “Au-Dy (Gold - Dysprosium)” in the article “Au (Gold) Binary Alloy Phase Diagrams.”
- “Co-Dy (Cobalt - Dysprosium)” in the article “Co (Cobalt) Binary Alloy Phase Diagrams.”
- “Cu-Dy (Copper - Dysprosium)” in the article “Cu (Copper) Binary Alloy Phase Diagrams.”

Dy-Fe (Dysprosium - Iron)

H. Okamoto, 1992

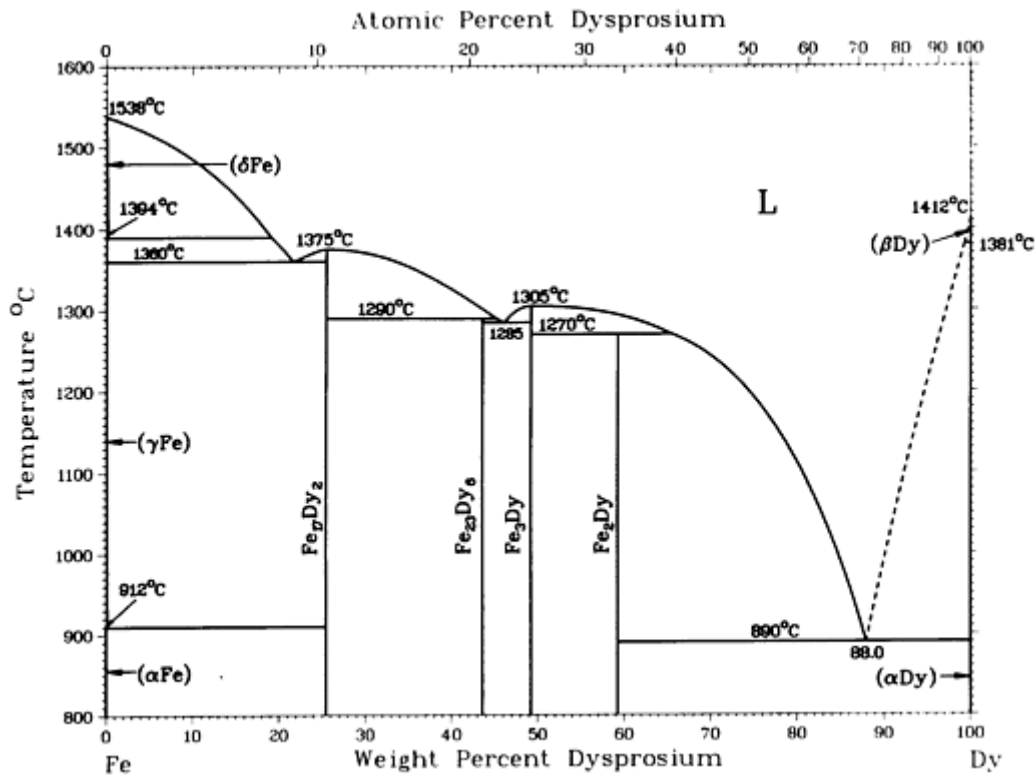

Dy-Fe phase diagram

Dy-Fe crystallographic data

Phase	Composition, wt% Dy	Pearson symbol	Space group
(Fe)	0	<i>cI2</i>	<i>Im</i> $\bar{3}m$
(γFe)	0	<i>cF4</i>	<i>Fm</i> $\bar{3}m$
(αFe)	0	<i>cI2</i>	<i>Im</i> $\bar{3}m$
Fe ₁₇ Dy ₂	25.4	<i>hP38</i>	<i>P6</i> ₃ / <i>mmc</i>
Fe ₂₃ Dy ₆	43.2	<i>cF116</i>	<i>Fm</i> $\bar{3}m$
Fe ₃ Dy	49	<i>hR12</i>	<i>R</i> $\bar{3}m$

Fe_2Dy	59.2	$cF24$	$Fd\bar{3}m$
$\text{Fe}_2\text{Dy}^{(a)}$	59.2	t^{**}	...
(βDy)	100	$cI2$	$Im\bar{3}m$
(αDy)	100	$hP2$	$P6_3/mmc$

(a) Below
-23 °C

Dy-Ga (Dysprosium - Gallium)

From [Moffatt] 11

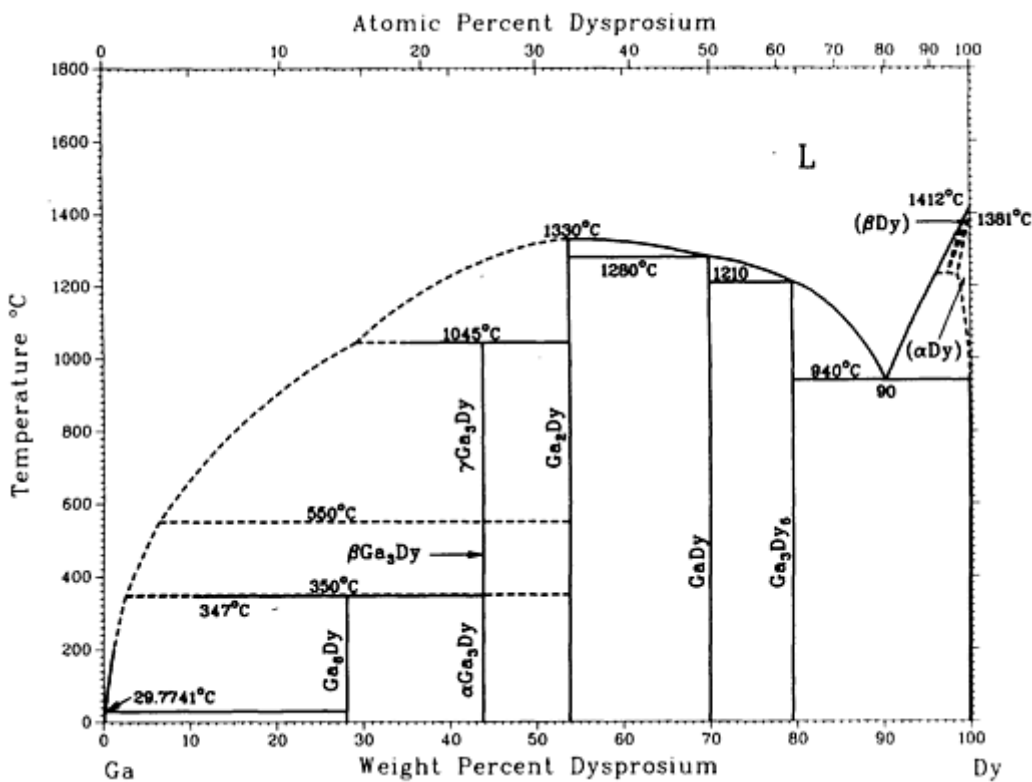

Dy-Ga phase diagram

Dy-Ga crystallographic data

Phase	Composition, wt% Dy	Pearson symbol	Space group
Fe_2Dy	59.2	$cF24$	$Fd\bar{3}m$
$\text{Fe}_2\text{Dy}^{(a)}$	59.2	t^{**}	...
(βDy)	100	$cI2$	$Im\bar{3}m$
(αDy)	100	$hP2$	$P6_3/mmc$

(Ga)	0	<i>oC8</i>	<i>Cmca</i>
Ga₆Dy	28.0	<i>tP14</i>	<i>P4/nbm</i>
γ Ga ₃ Dy	44	<i>cP4</i>	<i>Pm$\bar{3}m$</i>
β Ga ₃ Dy	44	<i>hP40</i>	<i>P6₃/mmc</i>
α Ga ₃ Dy	44	<i>hP16</i>	<i>R$\bar{3}m$</i>
Ga₂Dy	53.8	<i>hP3</i>	<i>P6/mmm</i>
GaDy	70.0	<i>oC8</i>	<i>Cmcm</i>
Ga₃Dy₅	79.5	<i>tI32</i>	<i>I4/mcm</i>
(β Dy)	100	<i>cI2</i>	<i>Im$\bar{3}m$</i>
(α Dy)	100	<i>hP2</i>	<i>P6₃/mmc</i>

Reference cited in this section

- [Moffatt]: W.G. Moffatt, Ed., *Handbook of Binary Phase Diagrams*, Business Growth Services, General Electric Co., Schenectady, NY (1976).

Dy-Ge (Dysprosium - Germanium)

V.N. Eremenko, V.G. Batalin, Yu.I. Buyanov, and I.M. Obushenko, 1977

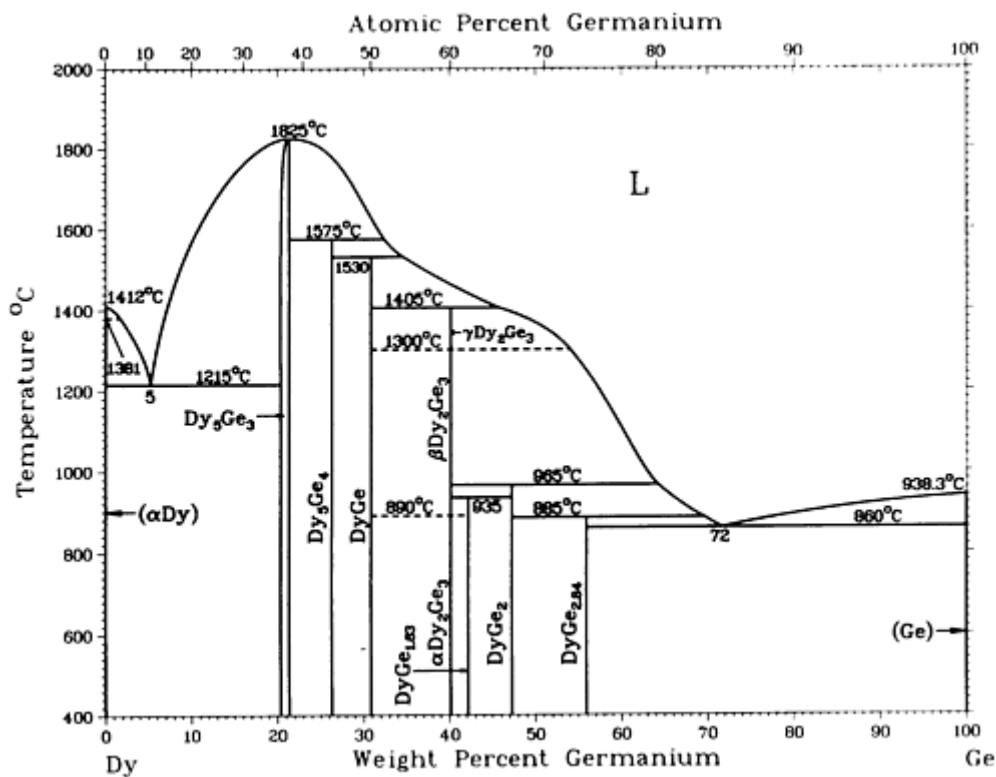

Dy-Ge phase diagram

Dy-Ge crystallographic data

Phase	Composition, wt% Ge	Pearson symbol	Space group
(βDy)	0	<i>cI2</i>	<i>Im$\bar{3}m$</i>
(αDy)	0	<i>hP2</i>	<i>P6₃/mmc</i>
Dy ₅ Ge ₃	~21.4	<i>hP16</i>	<i>P6₃/mcm</i>
Dy ₅ Ge ₄	26.3	<i>oP36</i>	<i>Pnma</i>
DyGe	30.9	<i>oC8</i>	<i>Cmcm</i>
γDy ₂ Ge ₃	40
βDy ₂ Ge ₃	40

$\alpha\text{Dy}_2\text{Ge}_3$	40	$hP3$	$P6/mmm$
$\text{DyGe}_{1.83}$	45.0
DyGe_2	47.2	$tI12$ $o^{**(\text{a})}$	$I4_1/amd$...
$\text{DyGe}_{2.84}$	56
(Ge)	100	$hR2$	$R\bar{3}m$

(a) High-temperature (>750 °C) phase?

Dy-In (Dysprosium - Indium)

H. Okamoto, 1992

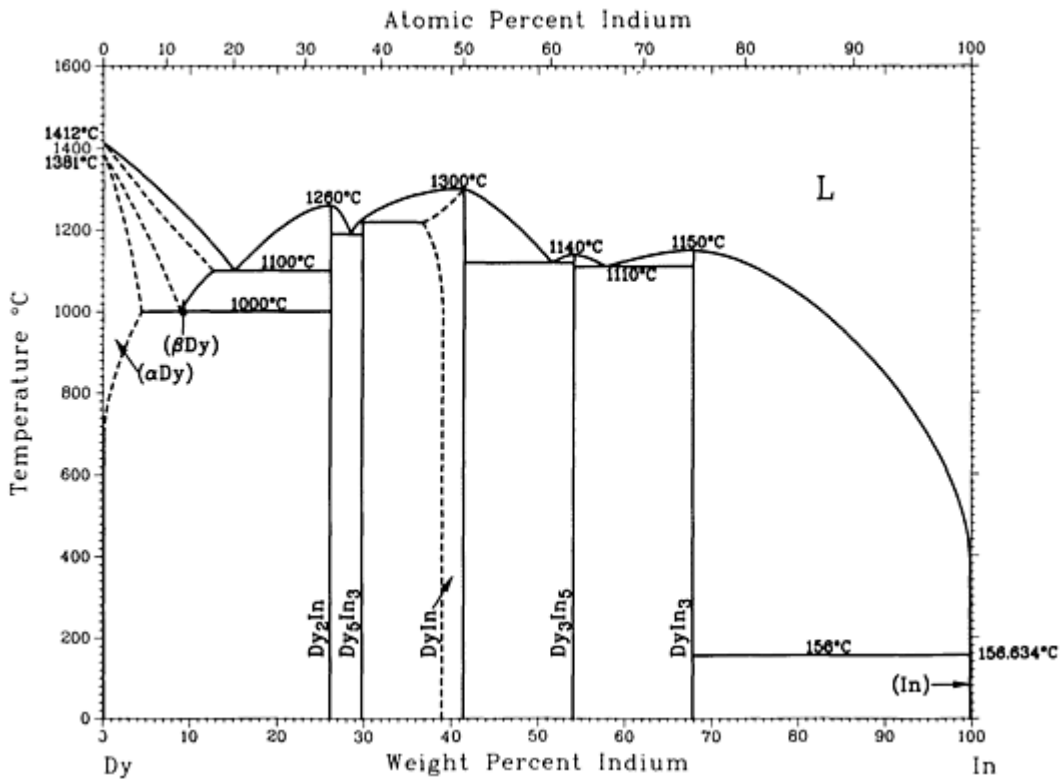

Dy-In phase diagram

Dy-In crystallographic data

Phase	Composition, wt% In	Pearson symbol	Space group

(βDy)	0 to 13	<i>cI2</i>	<i>Im$\bar{3}m$</i>
(αDy)	0 to 6	<i>hP2</i>	<i>P6₃/mmc</i>
Dy₃In^(a)	19	<i>tP4</i>	<i>P4/mmm</i>
Dy₂In	26.1	<i>hP6</i>	<i>P6₃/mmc</i>
Dy₃In₃	29.8	<i>tI32</i>	<i>I4/mcm</i>
DyIn	37 to 41	<i>cP2</i>	<i>Pm$\bar{3}m$</i>
Dy₃In₅	54.1	<i>oC32</i>	<i>Cmcm</i>
DyIn₃	68	<i>cP4</i>	<i>Pm$\bar{3}m$</i>
(In)	100	<i>tI2</i>	<i>I4/mmm</i>

(a) Not accepted in the assessed diagram

Dy-Mn (Dysprosium - Manganese)

H.R. Kirchmayr and W. Lugscheider, 1967

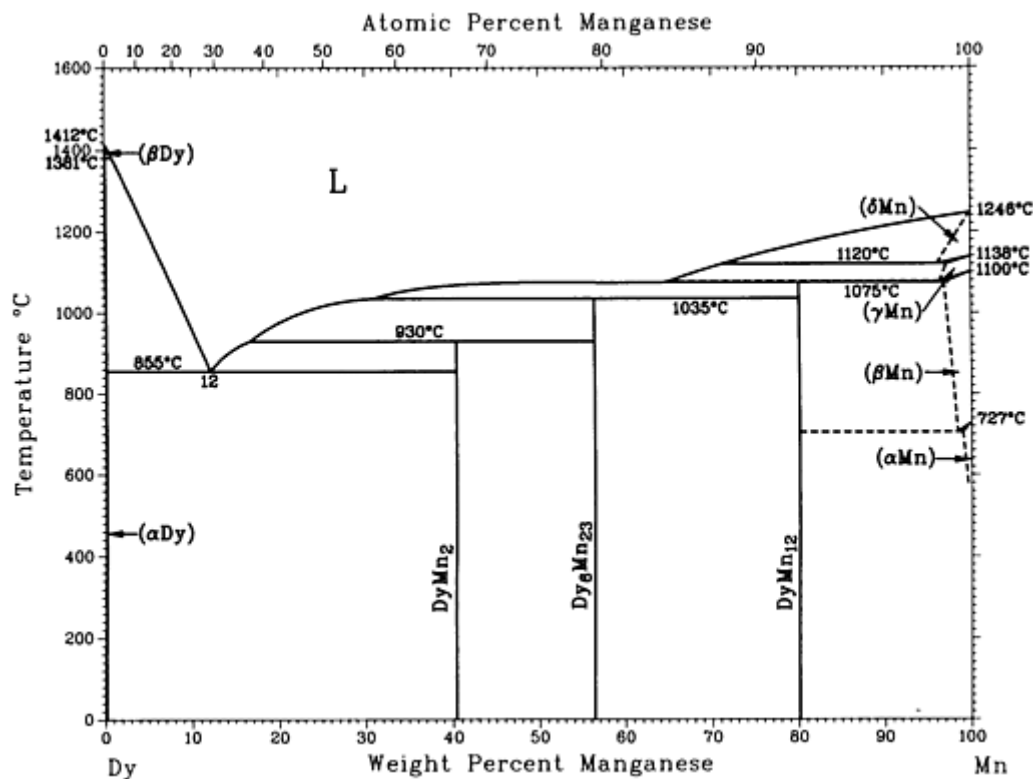

Dy-Mn phase diagram

Dy-Mn crystallographic data

Phase	Composition, wt% Mn	Pearson symbol	Space group
(βDy)	0	<i>cI2</i>	<i>Im</i> $\bar{3}m$
(αDy)	0	<i>hP2</i>	<i>P6</i> ₃ / <i>mmc</i>
DyMn ₂	40.4	<i>cF24</i>	<i>Fd</i> $\bar{3}m$
Dy ₆ Mn ₂₃	56.4	<i>cF116</i>	<i>Fm</i> $\bar{3}m$
DyMn ₁₂	80.2	<i>tI26</i>	<i>I4/mmm</i>
(δMn)	100	<i>cI2</i>	<i>Im</i> $\bar{3}m$
(γMn)	100	<i>cF4</i>	<i>Fm</i> $\bar{3}m$

(β_{Mn})	100	<i>cP20</i>	<i>P4₁32</i>
(α_{Mn})	100	<i>cI58</i>	<i>I4₃m</i>

Dy-Ni (Dysprosium - Nickel)

Y.Y. Pan and P. Nash, 1991

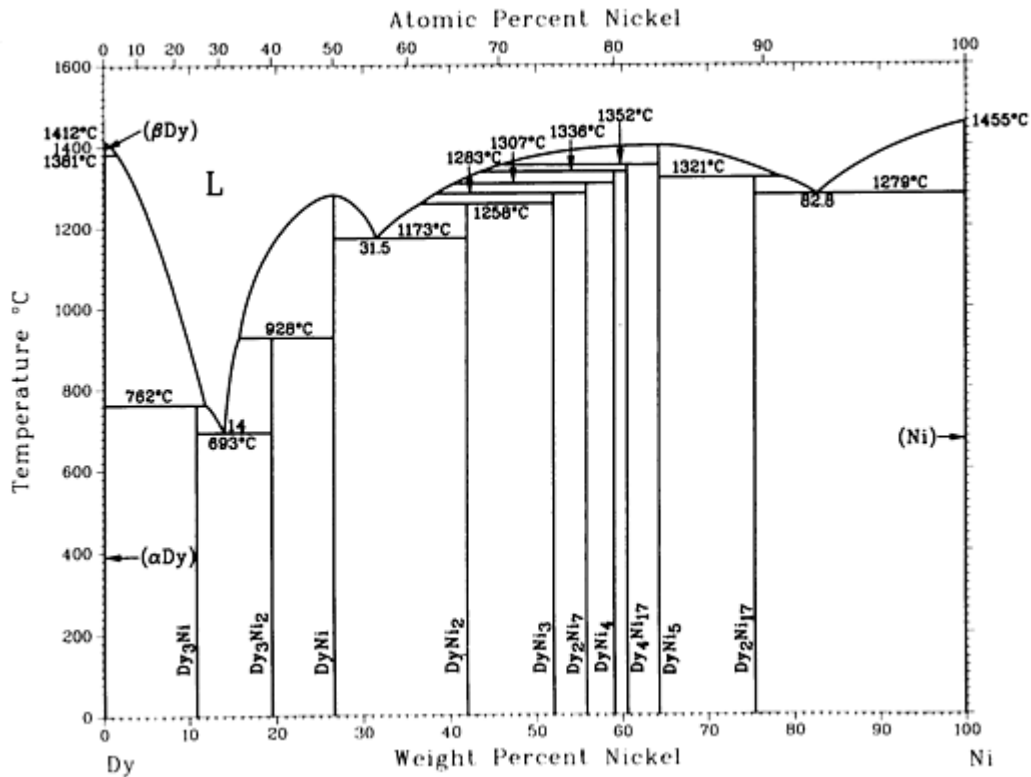

Dy-Ni phase diagram

Dy-Ni crystallographic data

Phase	Composition, wt% Ni	Pearson symbol	Space group
(α_{Dy})	0	<i>cI2</i>	<i>Im$\bar{3}m$</i>
(β_{Dy})	0	<i>hP2</i>	<i>P6₃/mmc</i>
$(\alpha'\text{Dy})$	0	<i>oC4</i>	<i>Cmcm</i>
Dy_3Ni	10.7	<i>oP16</i>	<i>Pnma</i>

Dy₃Ni₂	19.4	<i>mC20</i>	<i>C2/m</i>
DyNi	26.5	<i>oP8</i>	<i>Pbnm</i>
DyNi₂	42.0	<i>cF24</i>	<i>Fd$\bar{3}m$</i>
DyNi₃	52.0	<i>hR24</i>	<i>R$\bar{3}m$</i>
Dy₂Ni₇	55.9	<i>hR54</i> <i>hP36</i>	<i>R$\bar{3}m$</i> <i>P6₃/mmc</i>
DyNi₄	59.1
Dy₄Ni₁₇	61
DyNi₅	64.3	<i>hP6</i>	<i>P6₃/mmm</i>
Dy₂Ni₁₇	75.5	<i>hP38</i>	<i>P6₃/mmc</i>
(Ni)	100	<i>cF4</i>	<i>Fm$\bar{3}m$</i>

Dy-Pb (Dysprosium - Lead)

O.D. McMasters, T.J. O'Keefe, and K.A. Gschneidner, Jr., 1968

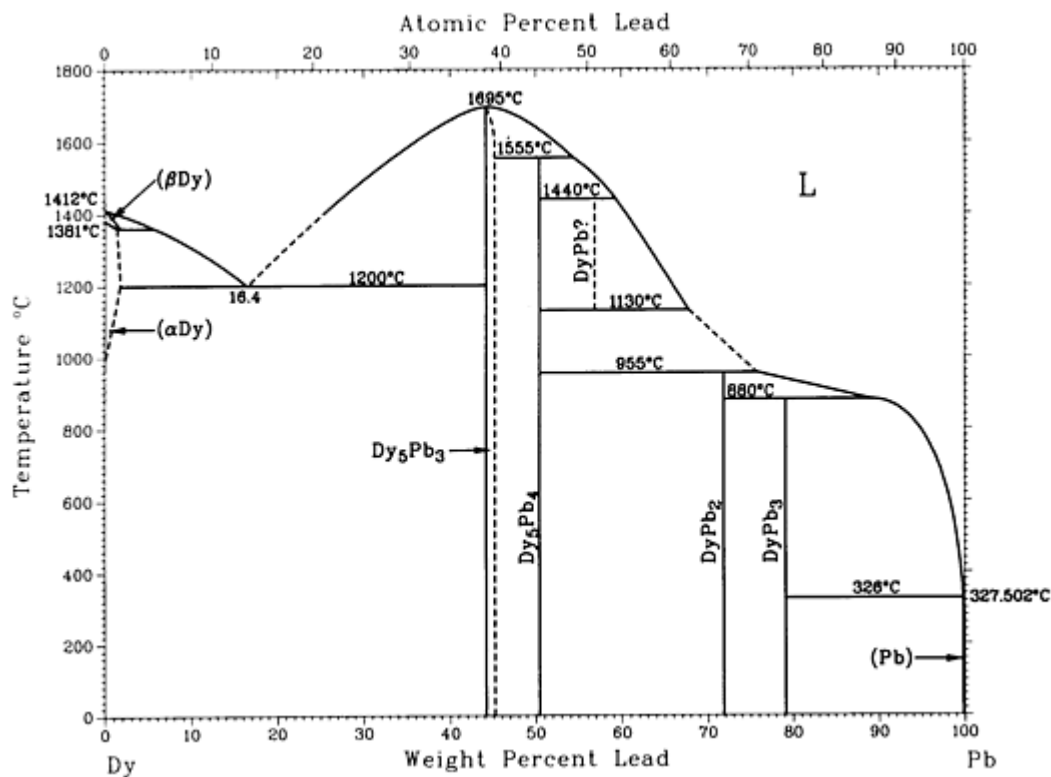

Dy-Pb phase diagram

Dy-Pb crystallographic data

Phase	Composition, wt% Pb	Pearson symbol	Space group
(βDy)	0	<i>cI2</i>	<i>Im</i> $\bar{3}m$
(αDy)	0	<i>hP2</i>	<i>P6</i> ₃ / <i>mmc</i>
Dy ₅ Pb ₃	43.3	<i>hP16</i>	<i>P6</i> ₃ / <i>mcm</i>
Dy ₅ Pb ₄	50.5	<i>oP36</i>	<i>Pnma</i>
DyPb	56.0
DyPb ₂	71.9
DyPb ₃	79	<i>cP4</i>	<i>Pm</i> $\bar{3}m$

(Pb) 100 $cF4$ $Fm\bar{3}m$

Dy-Pd (Dysprosium - Palladium)

H. Okamoto, 1990

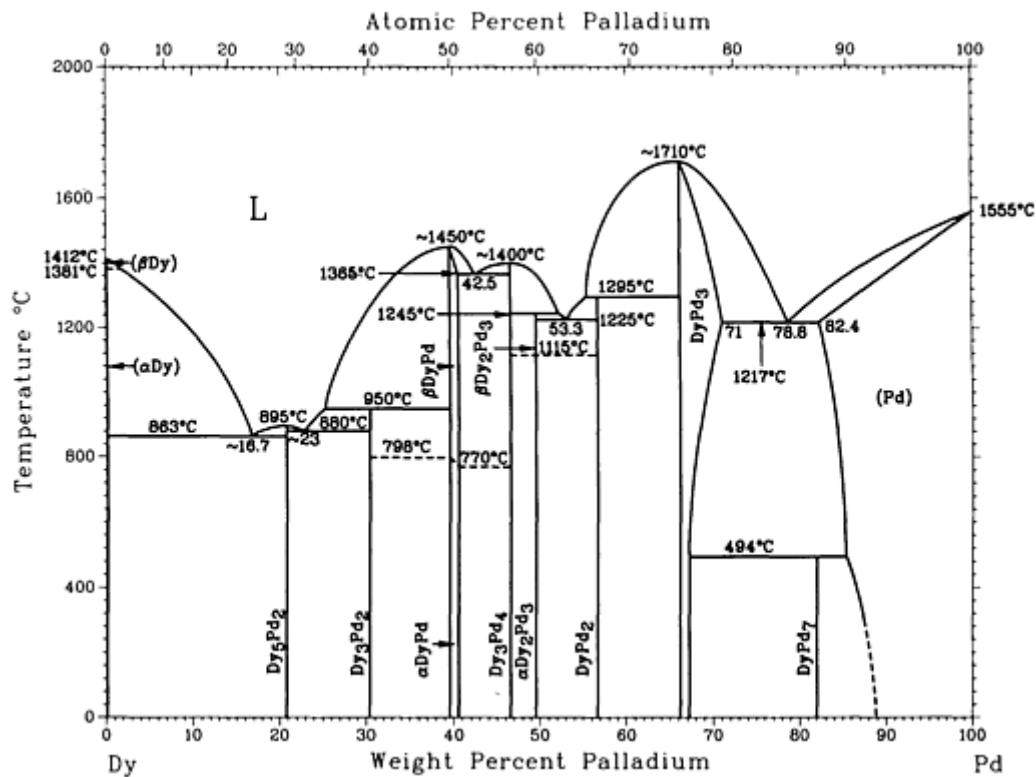

Dy-Pd phase diagram

Dy-Pd crystallographic data

Phase	Composition, wt% Pd	Pearson symbol	Space group
(βDy)	0	$cI2$	$Im\bar{3}m$
(αDy)	0	$hP2$	$P6_3/mmc$
Dy ₃ Pd ₂	20.8	$tI49$	$I4_1/a$
Dy ₃ Pd ₂	30	$tP10$	$P4/mbm$
βDyPd	39.6	$cP2$	$Pm\bar{3}m$

α DyPd	39.6	<i>oP8</i>	<i>Pnma</i>
Dy ₃ Pd ₄	46.6	<i>hR14</i>	$R\bar{3}$
β Dy ₂ Pd ₃	50
α Dy ₂ Pd ₃	50
DyPd ₂	56.7
DyPd ₃	66 to 71	<i>cP4</i>	<i>Fm\bar{3}m</i>
DyPd ₇	82	<i>c**</i>	...
(Pd)	82.4 to 100	<i>cF4</i>	<i>Fm\bar{3}m</i>

Dy-S (Dysprosium - Sulfur)

H. Okamoto, 1990

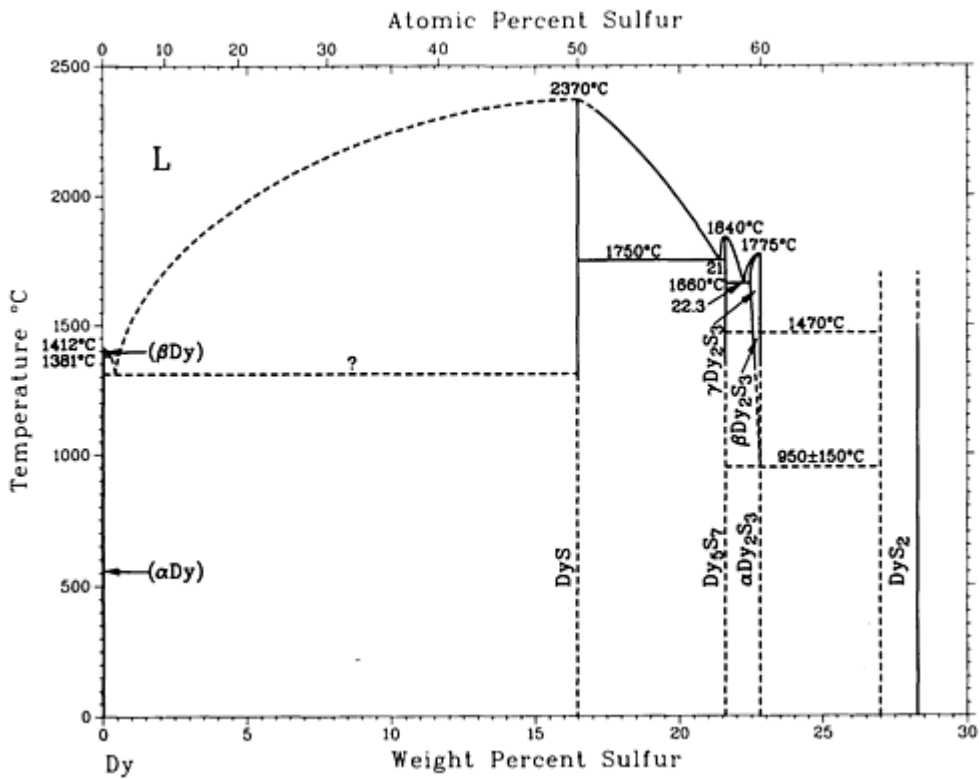

Dy-S phase diagram

Dy-S crystallographic data

Phase	Composition, wt% S	Pearson symbol	Space group
(βDy)	0	<i>cI2</i>	<i>Im\bar{3}m</i>
(αDy)	0	<i>hP2</i>	<i>P6₃/mmc</i>
DyS	17	<i>cF8</i>	<i>Fm\bar{3}m</i>
Dy₃S₇	21.6	<i>mC24</i>	<i>C2/m</i>
$\gamma\text{Dy}_2\text{S}_3$	23	<i>cI28</i>	<i>I\bar{4}3d</i>
$\beta\text{Dy}_2\text{S}_3$	23	<i>oP20</i>	<i>Pnma</i>
$\alpha\text{Dy}_2\text{S}_3$	23	<i>m**</i>	...
DyS₂	27.2 to 28.3	<i>cF24</i>	<i>Fd\bar{3}m</i>
(S)	100	<i>oF128</i>	<i>Fddd</i>

Dy-Sb (Dysprosium - Antimony)

H. Okamoto, 1990

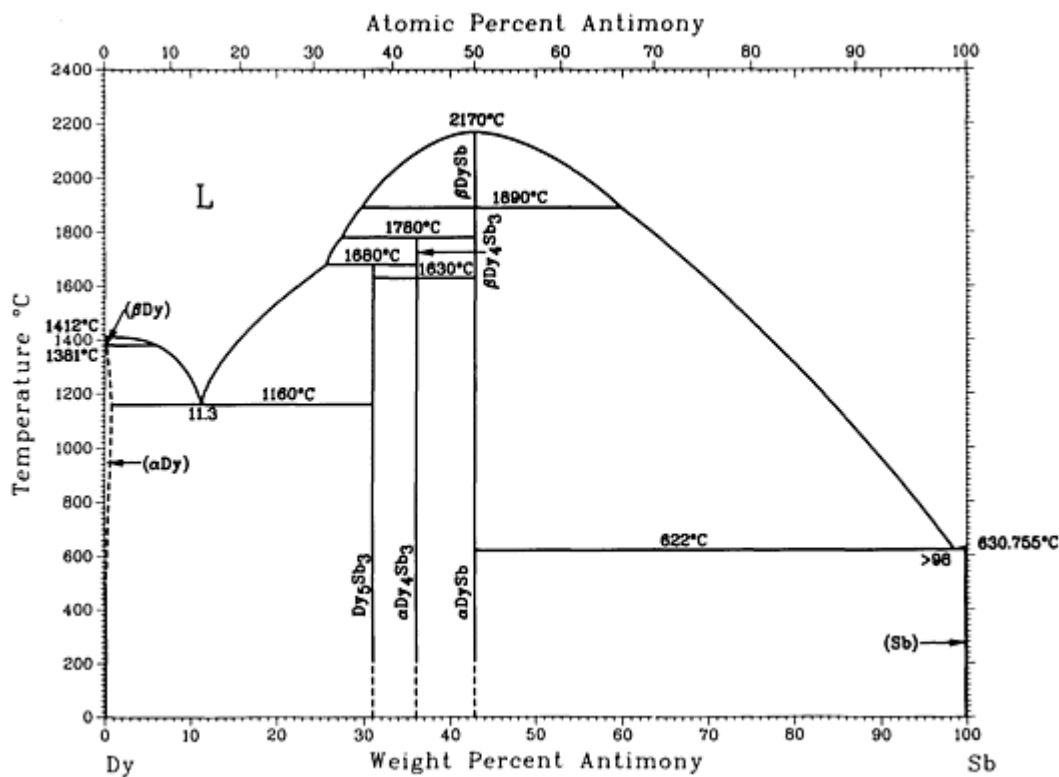

Dy-Sb phase diagram

Dy-Sb crystallographic data

Phase	Composition, wt% Sb	Pearson symbol	Space group
(βDy)	0	<i>cI2</i>	<i>Im</i> $\bar{3}m$
(αDy)	0	<i>hP2</i>	<i>P6</i> ₃ / <i>mmc</i>
Dy ₅ Sb ₃	31.0	<i>hP16</i>	<i>P6</i> ₃ / <i>mcm</i>
βDy ₄ Sb ₃	36.0
αDy ₄ Sb ₃	36.0	<i>cI28</i>	<i>I</i> $\bar{4}$ ₃ <i>d</i>
βDySb	42.8
αDySb	42.8	<i>cF8</i>	<i>Fm</i> $\bar{3}m$

α' DySb ^(a)	42.8	<i>tI4</i>	<i>I4/mmm</i>
(Sb)	100	<i>hR2</i>	$R\bar{3}m$
High-pressure phase			
DySb ₂	60.1	<i>o*6</i>	...

(a) Below 11 K

Dy-Sn (Dysprosium - Tin)

H. Okamoto, 1990

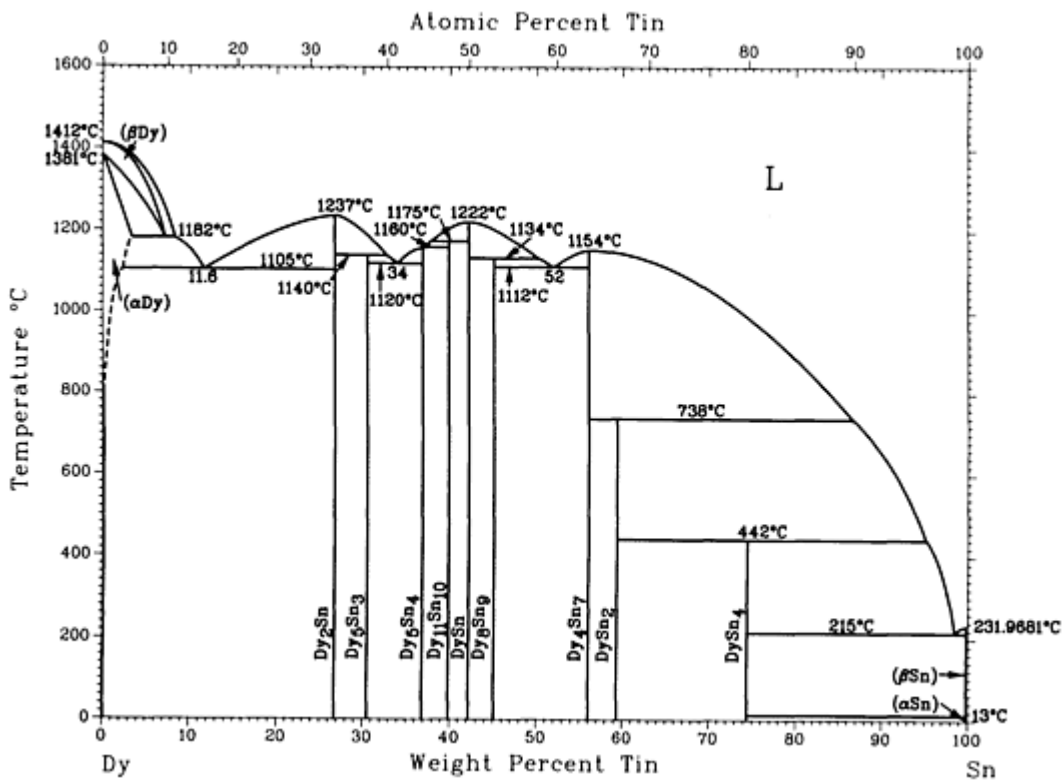

Dy-Sn phase diagram

Dy-Sn crystallographic data

Phase	Composition, wt% Sn	Pearson symbol	Space group
(βDy)	0	<i>cI2</i>	$Im\bar{3}m$

(αDy)	0	$hP2$	$P6_3/mmc$
Dy_2Sn	26.7
Dy_5Sn_3	30.5	$hP16$	$P6_3/mcm$
Dy_5Sn_4	36.8	$oP36$	$Pnma$
$\text{Dy}_{11}\text{Sn}_{10}$	39.9	$iI84$	$I4/mmm$
DySn	42.2
Dy_8Sn_9	45.1
Dy_4Sn_7	56.1
DySn_2	59.4	$oC12$	$Cmcm$
DySn_4	75
(βSn)	100	$iI4$	$I4_1/amd$
(αSn)	100	$cF8$	$Fd\bar{3}m$
High-pressure phase			
DySn_3	69	$cP4$	$Pm\bar{3}m$

Dy-Tl (Dysprosium - Thallium)

S. Delfino, A. Saccone, A. Palenzona, and R. Ferro, unpublished

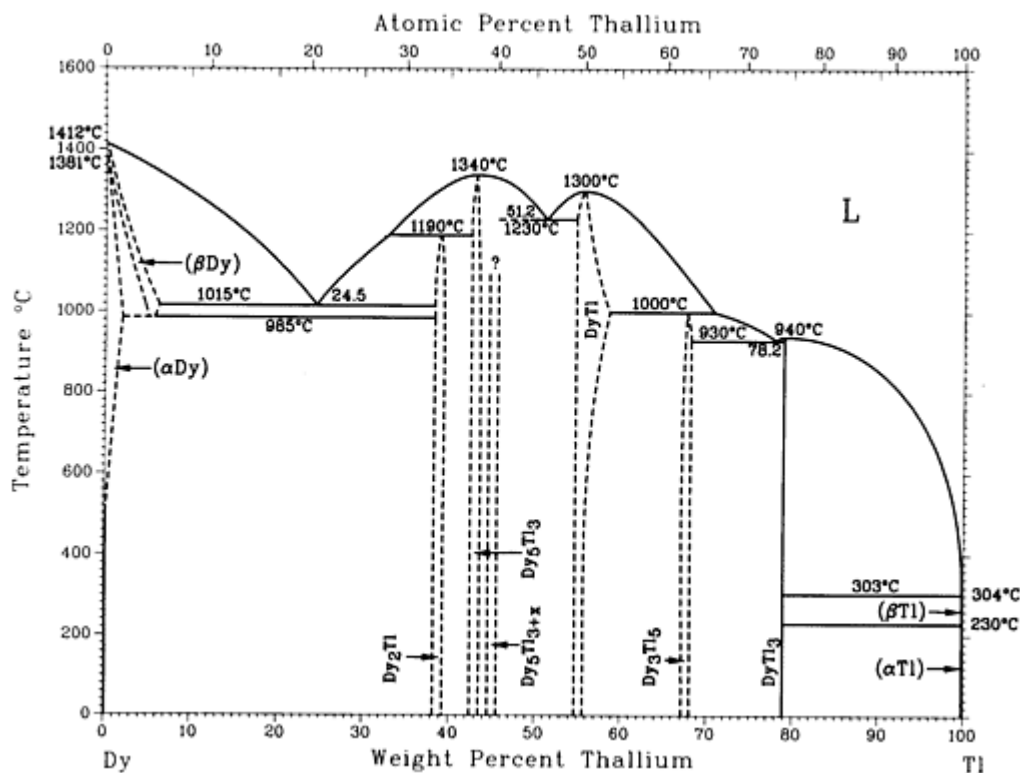

Dy-Tl phase diagram

Dy-Tl crystallographic data

Phase	Composition, wt% Tl	Pearson symbol	Space group
(β Dy)	0 to \sim 6	<i>cI2</i>	<i>Im$\bar{3}m$</i>
(α Dy)	0 to ?	<i>hP2</i>	<i>P6₃/mmc</i>
Dy ₂ Tl	\sim 38 to \sim 39	<i>hP6</i>	<i>P6₃/mmc</i>
Dy ₅ Tl ₃	\sim 43 to \sim 44	<i>hP16</i>	<i>P6₃/mcm</i>
Dy ₅ Tl _{3+x}	?	<i>tI32</i>	<i>I4/mcm</i>
DyTl ^(a)	55 to \sim 59	<i>cP2</i> (or <i>cI2</i>)	<i>Pm$\bar{3}m$</i> <i>Im$\bar{3}m$</i>
DyTl ^(b)	\sim 55 to \sim 59	<i>tP2</i>	<i>P4/mmm</i>

Dy_3Tl_5	~ 67 to ~ 68	$oC32$	$Cmcm$
DyTl_3	79	$cP4$	$Pm\bar{3}m$
(βTl)	100	$cI2$	$Im\bar{3}m$
(αTl)	100	$hP2$	$P6_3/mmc$

- (a) Cubic Structure presumed to be room- and higher temperature phases.
- (b) Tetragonal structure presumed to be lower temperature phase

Dy-Zr (Dysprosium - Zirconium)

J. Croni, C.E. Armantrout, and H. Kato, 1960

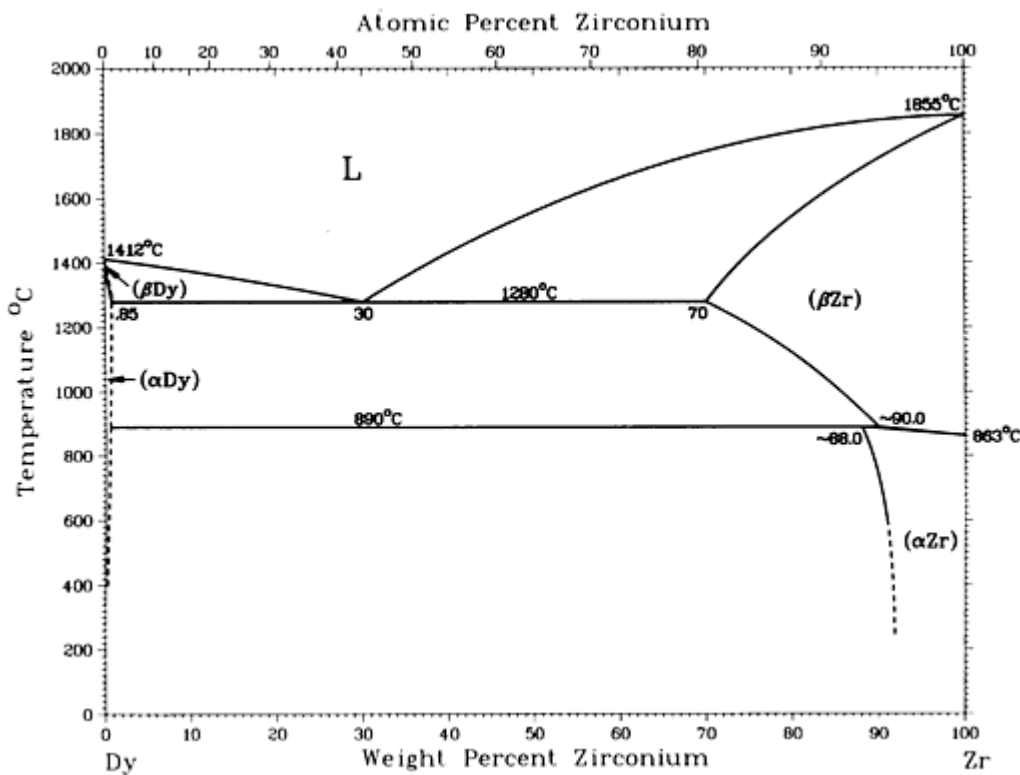

Dy-Cr phase diagram

Dy-Zr crystallographic data

Phase	Composition,	Pearson	Space
-------	--------------	---------	-------

	wt% Zr	symbol	group
(β Dy)	0 to ?	<i>cI2</i>	<i>Im$\bar{3}m$</i>
(α Dy)	0 to 0.85	<i>hP2</i>	<i>P6$_3$/mmc</i>
(β Zr)	70 to 100	<i>cI2</i>	<i>Im$\bar{3}m$</i>
(α Zr)	~88 to 100	<i>hP2</i>	<i>P6$_3$/mmc</i>

Er (Erbium) Binary Alloy Phase Diagrams

Introduction

THIS ARTICLE includes systems where erbium is the first-named element in the binary pair. Additional binary systems that include erbium are provided in the following locations in this Volume:

- “Ag-Er (Silver - Erbium)” in the article “Ag (Silver) Binary Alloy Phase Diagrams.”
- “Al-Er (Aluminum - Erbium)” in the article “Al (Aluminum) Binary Alloy Phase Diagrams.”
- “Co-Er (Cobalt - Erbium)” in the article “Co (Cobalt) Binary Alloy Phase Diagrams.”
- “Cu-Er (Copper - Erbium)” in the article “Cu (Copper) Binary Alloy Phase Diagrams.”

Er-Fe (Erbium - Iron)

H. Okamoto, 1992

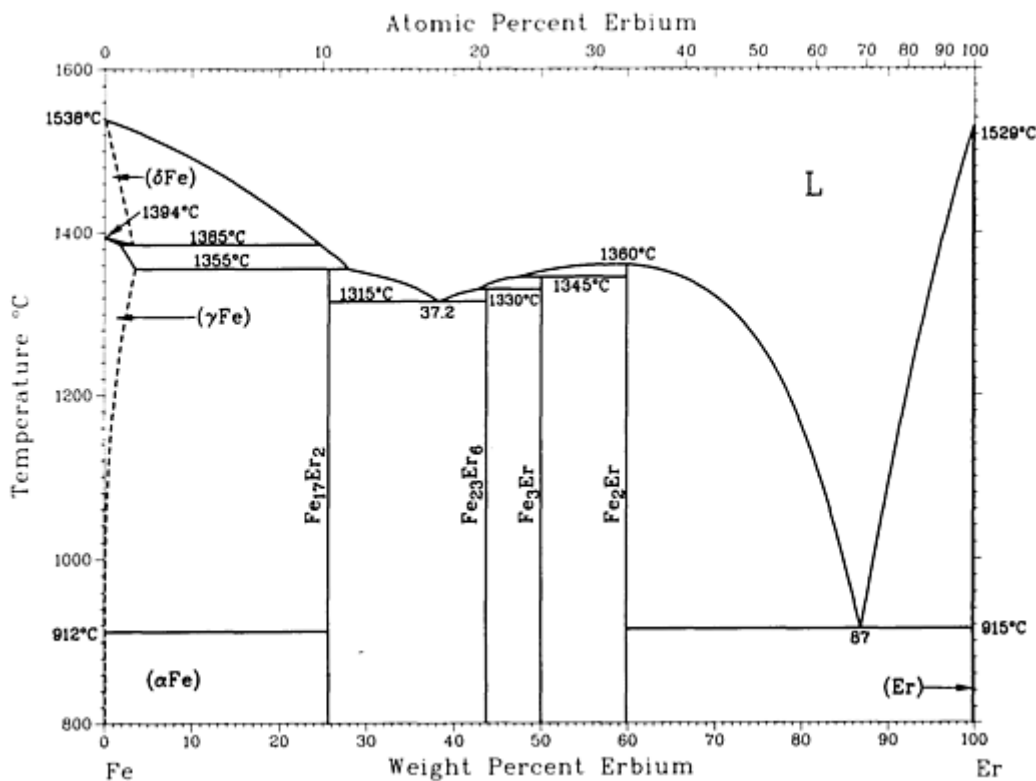

Er-Fe phase diagram

Er-Fe crystallographic data

Phase	Composition, wt% Er	Pearson symbol	Space group
(δ Fe)	0	<i>cI2</i>	<i>Im$\bar{3}m$</i>
(γ Fe)	0	<i>cF4</i>	<i>Fm$\bar{3}m$</i>
(α Fe)	0	<i>cI2</i>	<i>Im$\bar{3}m$</i>
Fe₁₇Er₂	26.0	<i>hP38</i>	<i>P6₃/mmc</i>
Fe₂₃Er₆	43.9	<i>cF116</i>	<i>Fm$\bar{3}m$</i>
Fe₃Er	50	<i>hR12</i>	<i>R$\bar{3}m$</i>
Fe₂Er	59.9	<i>cF24</i>	<i>Fd$\bar{3}m$</i>
(Er)	100	<i>hP2</i>	<i>P6₃/mmc</i>
Metastable phase			
	~75.0	<i>hP12</i>	<i>P6₃/mmc</i>

Er-Ga (Erbium - Gallium)

H. Okamoto, 1990

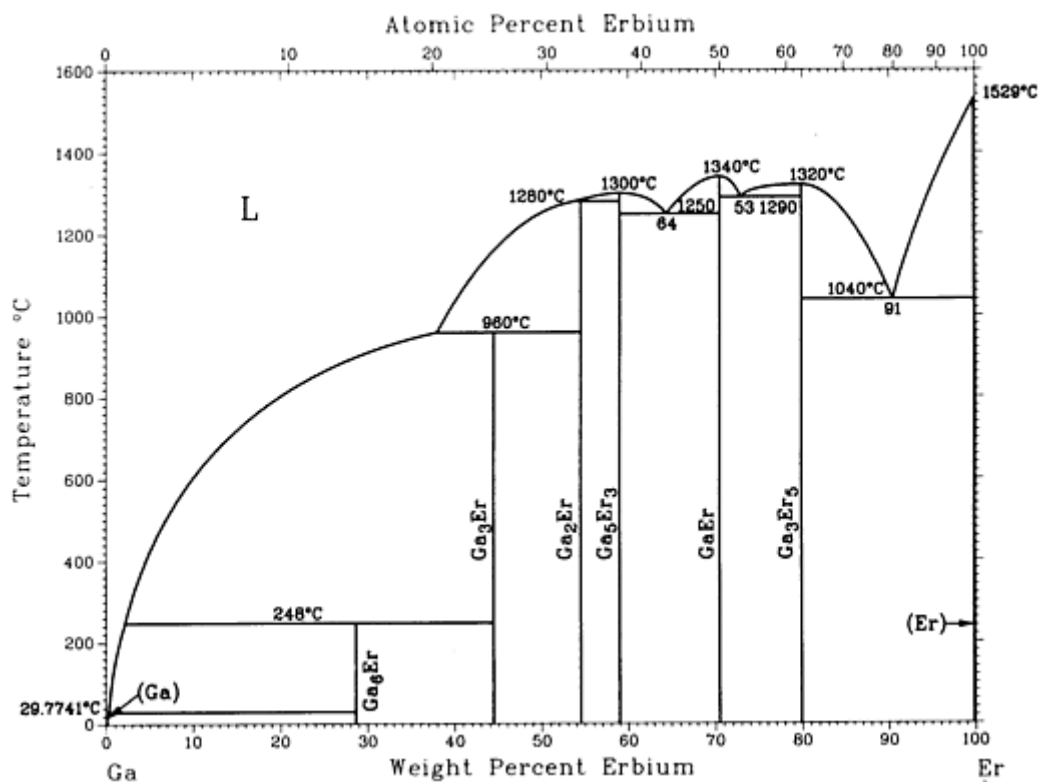

Er-Ga phase diagram

Er-Ga crystallographic data

Phase	Composition, wt% Er	Pearson symbol	Space group
(Ga)	0	<i>oC8</i>	<i>Cmca</i>
Ga ₆ Er	28.6	<i>tP14</i>	<i>P4/nbm</i>
Ga ₃ Er	44	<i>cP4</i>	<i>Pm$\bar{3}m$</i>
Ga ₂ Er	54.5	<i>hP3</i>	<i>P6/mmm</i>
Ga ₅ Er ₃	59.0	<i>oP32</i>	<i>Pnma</i>
GaEr	70.6	<i>oC8</i>	<i>Cmcm</i>
Ga ₃ Er ₅	80.0	<i>hP16</i>	<i>P6₃/mcm</i>

(Er) 100 *hP2* *P6₃/mmc*

Er-Ge (Erbium - Germanium)

H. Okamoto, 1990

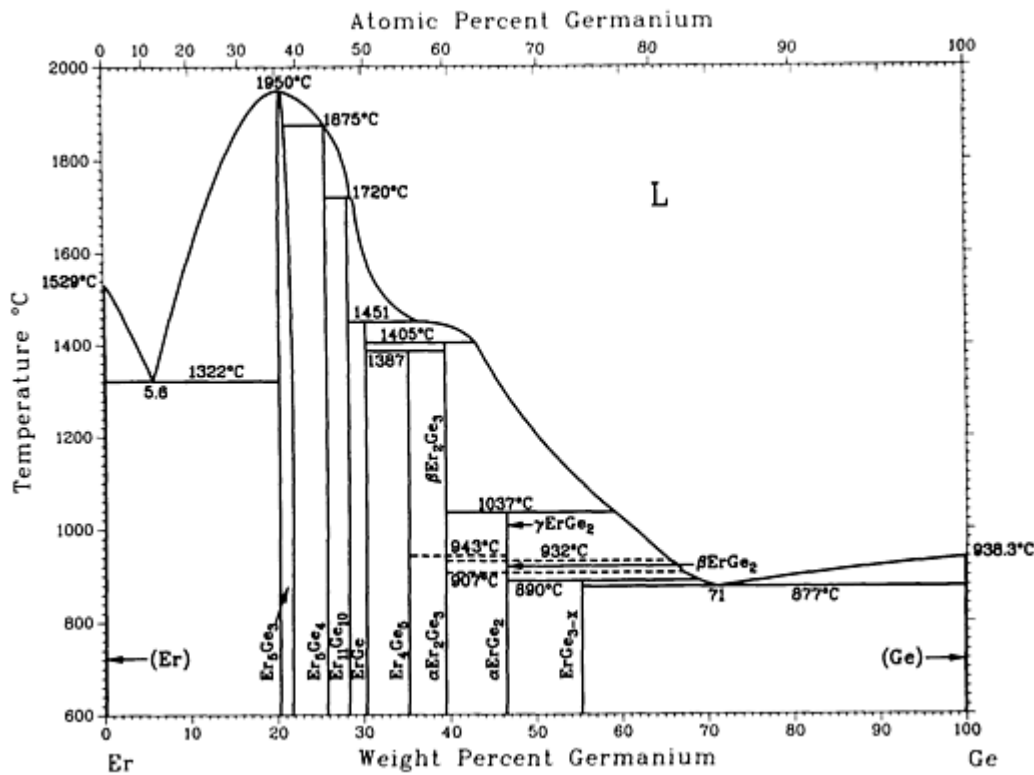

Er-Ge phase diagram

Er-Ge crystallographic data

Phase	Composition, wt% Ge	Pearson symbol	Space group
(Er)	0	<i>hP2</i>	<i>P6₃/mmc</i>
Er ₅ Ge ₃	~20.7	<i>hP16</i>	<i>P6₃/mcm</i>
Er ₅ Ge ₄	25.7	<i>oP36</i>	<i>Pnma</i>
Er ₁₁ Ge ₁₀	28.3	<i>tI84</i>	<i>I4/mmm</i>
ErGe	30.3	<i>oC8</i>	<i>Cmcm</i>

Er_4Ge_5	35.2
$\beta\text{Er}_2\text{Ge}_3$	39	<i>hP3</i>	<i>P6/mmm</i>
$\alpha\text{Er}_2\text{Ge}_3$	39
γErGe_2	46.5
βErGe_2	46.5
αErGe_2	46.5
ErGe_{3-x}	55	<i>oC16</i>	<i>C222_1</i>
(Ge)	100	<i>cF8</i>	<i>Fd\bar{3}m</i>

Er-In (Erbium - Indium)

H. Okamoto, 1992

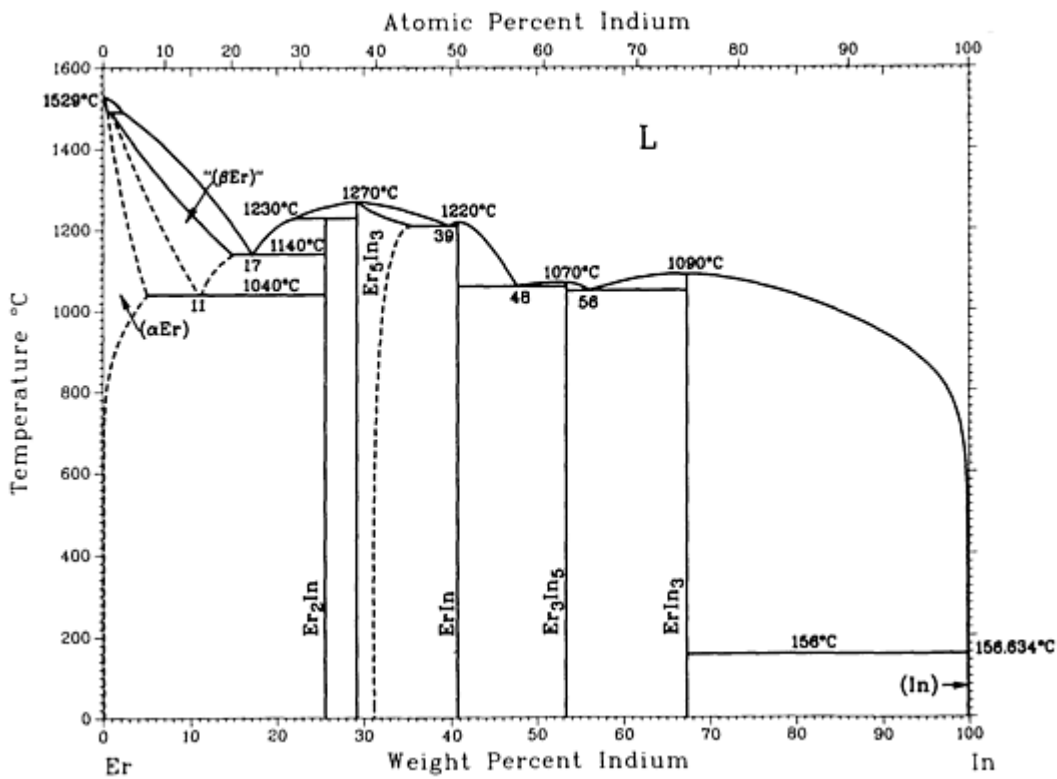

Er-In phase diagram

Er-In crystallographic data

Phase	Composition, wt% In	Pearson symbol	Space group
(αEr)	0 to 5	<i>hP2</i>	<i>P6₃/mmc</i>
"(βEr)"	? to 15	<i>cI2</i>	<i>Im$\bar{3}m$</i>
Er₂In	25.5	<i>hP6</i>	<i>P6₃/mmc</i>
Er₅In₃	29.2 to 36	<i>hP16</i>	<i>P6₃/mcm</i>
ErIn	40.7	<i>cP2</i>	<i>Pm$\bar{3}m$</i>
Er₃In₅	53.4	<i>oC32</i>	<i>Cmcm</i>
ErIn₃	67	<i>cP4</i>	<i>Pm$\bar{3}m$</i>
(In)	100	<i>tI2</i>	<i>I4/mmm</i>

Er-Mn (Erbium - Manganese)

H.R. Kirchmayr and W. Lugscheider, 1967

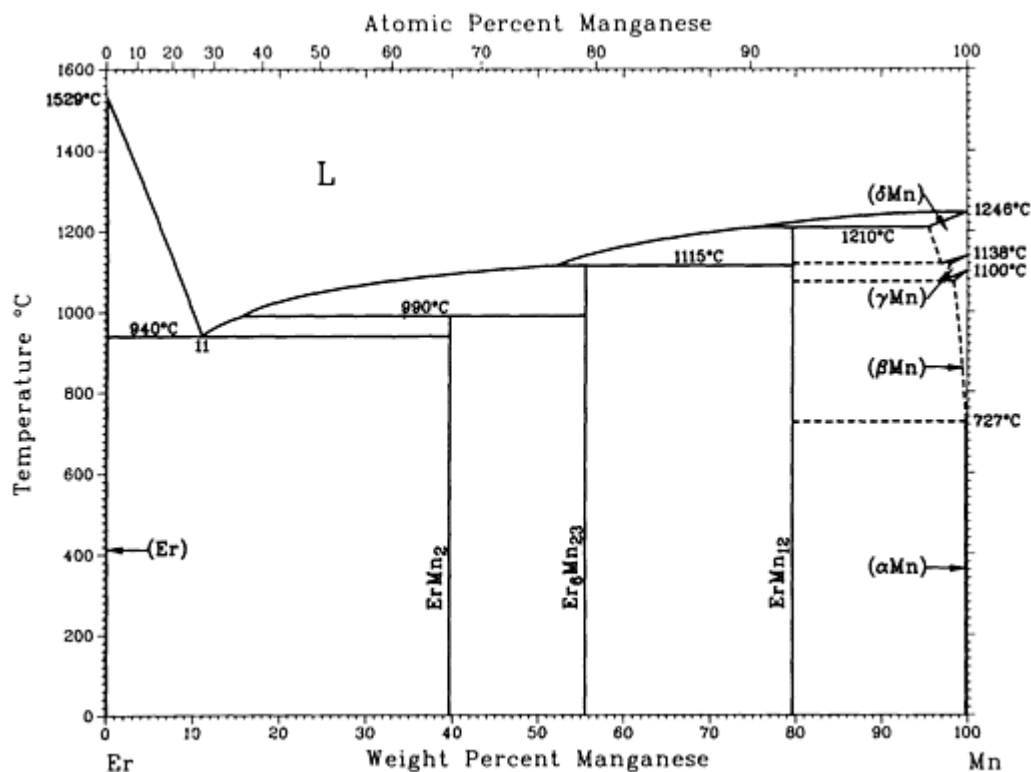

Er-Mn phase diagram

Er-Mn crystallographic data

Phase	Composition, wt% Mn	Pearson symbol	Space group
(Er)	0	<i>hP2</i>	<i>P6₃/mmc</i>
ErMn ₂	39.7
Er ₆ Mn ₂₃	55.7	<i>cF116</i>	<i>Fm$\bar{3}$m</i>
ErMn ₁₂	79.7	<i>iI26</i>	<i>I4/mmm</i>
(δMn)	100	<i>cI2</i>	<i>Im$\bar{3}$m</i>
(γMn)	100	<i>cF4</i>	<i>Fm$\bar{3}$m</i>
(βMn)	100	<i>cP20</i>	<i>P4₁32</i>

(α Mn) 100 $cI58$ $\bar{1}4_3m$

Er-Ni (Erbium - Nickel)

Y.Y. Pan and P. Nash, 1991

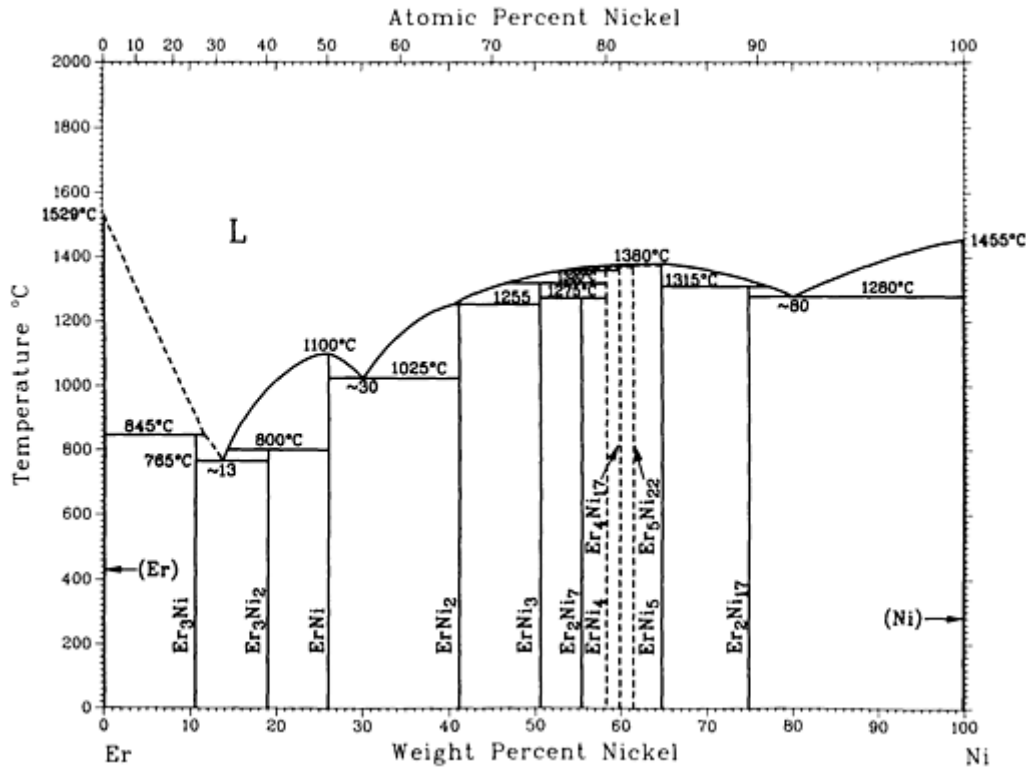

Er-Ni phase diagram

Er-Ni crystallographic data

Phase	Composition, wt% Ni	Pearson symbol	Space group
(Er)	0	$hP2$	$P6_3/mmc$
Er ₃ Ni	10.5	$oP16$	$Pnma$
Er ₃ Ni ₂	19.0	$hR5$	$R\bar{3}$
ErNi	26.0	$oP8$	$Pnma$
ErNi ₂	41.3	$cF24$	$Fd\bar{3}m$

ErNi ₃	51.3	<i>hR24</i>	$R\bar{3}m$
Er ₂ Ni ₇	55.2	<i>hR54</i>	$R\bar{3}m$
ErNi ₄	58.4	<i>hP36</i>	$P6_3/mmc$
Er ₄ Ni ₁₇	60
Er ₅ Ni ₂₂	60.7
ErNi ₅	63.6	<i>hP6</i>	$P6/mmm$
Er ₂ Ni ₁₇	74.9	<i>hP38</i>	$P6_3/mmc$
(Ni)	100	<i>cF4</i>	$Fm\bar{3}m$

Er-Pd (Erbium - Palladium)

H. Okamoto, 1991

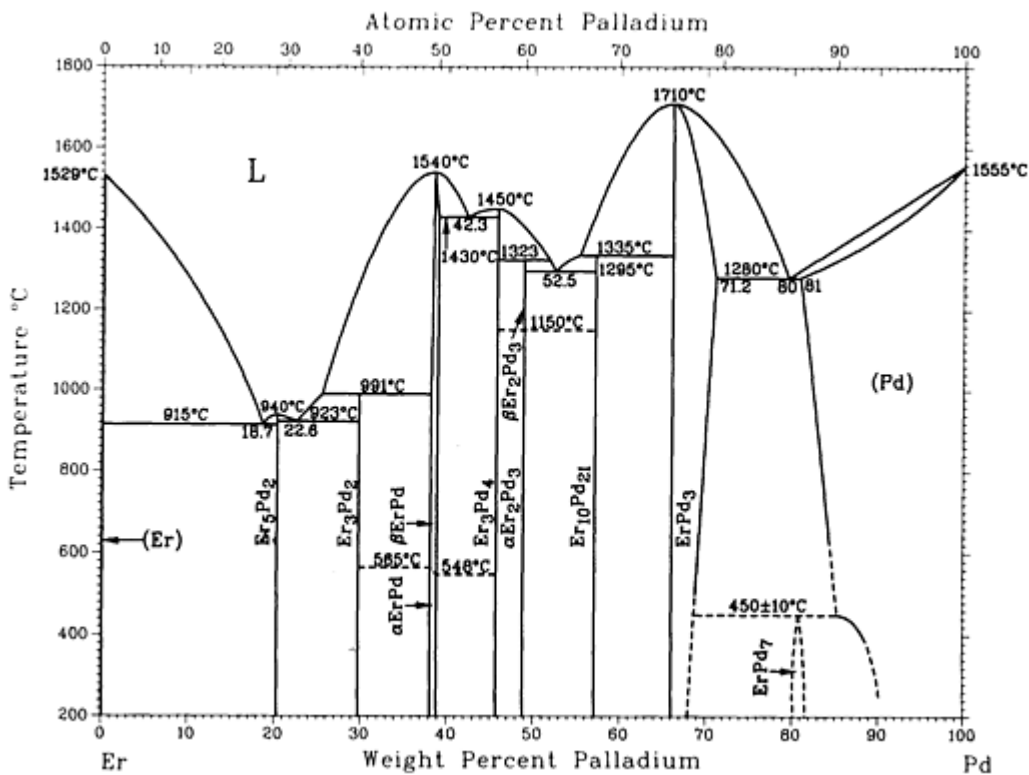

Er-Pd phase diagram

Er-Pd crystallographic data

Phase	Composition, wt% Pd	Pearson symbol	Space group
(Er)	0	<i>hP2</i>	<i>P6₃/mmc</i>
Er₅Pd₂	20.3	<i>cF96</i> <i>tI49</i>	<i>Fd$\bar{3}m$</i> <i>I4₁/a</i>
Er₃Pd₂	30	<i>tP10</i>	<i>P4/mbm</i>
β ErPd	~ 38.9	<i>cP2</i>	<i>Pm$\bar{3}m$</i>
α ErPd	~ 38.9
Er₃Pd₄	45.9	<i>hR14</i>	<i>R$\bar{3}$</i>
β Er ₂ Pd ₃	49
α Er ₂ Pd ₃	49
Er₁₀Pd₂₁ ^(a)	57.1	<i>mC124</i>	<i>C2/m</i>
ErPd₃	66 to 71.2	<i>cP4</i>	<i>Pm$\bar{3}m$</i>
ErPd₇	81.7	<i>c**</i>	...
(Pd)	100	<i>cF4</i>	<i>Fm$\bar{3}m$</i>

(a) Similarity to Sm₁₀Pd₂₁ is assumed.

Er-Pt (Erbium - Platinum)

H. Okamoto, 1990

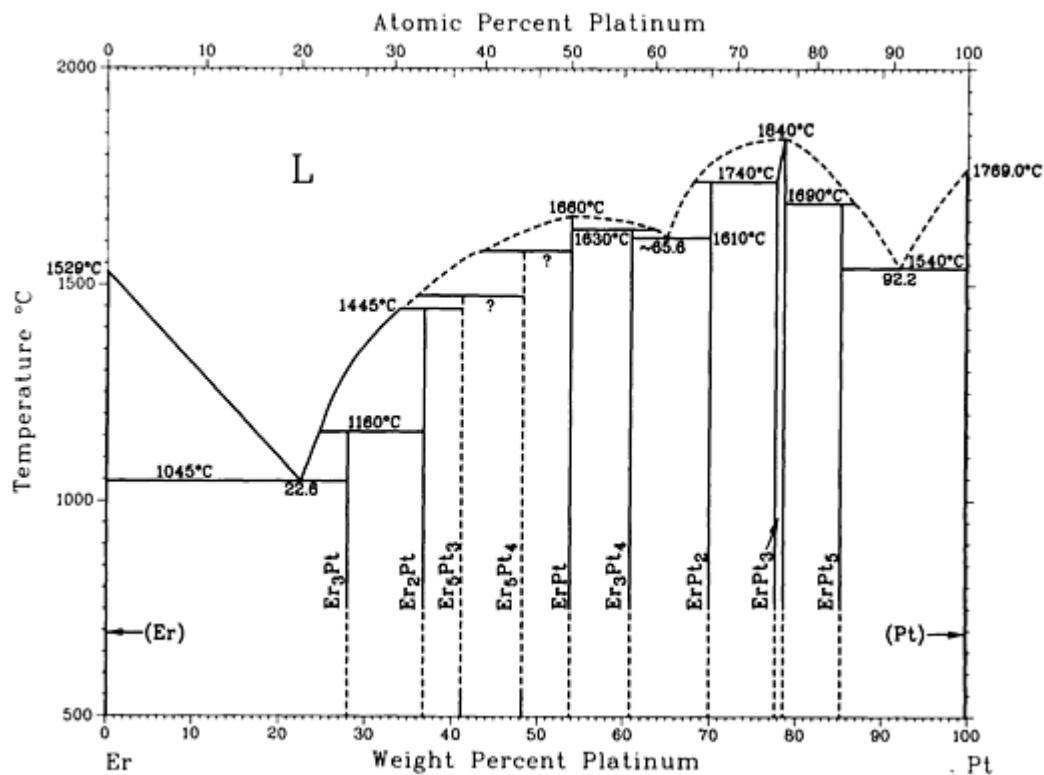

Er-Pt phase diagram

Er-Pt crystallographic data

Phase	Composition, wt% Pt	Pearson symbol	Space group
(Er)	0	<i>hP2</i>	<i>P6₃/mmc</i>
Er ₃ Pt	28	<i>oP16</i>	<i>Pnma</i>
Er ₂ Pt	36.8	<i>oP12</i>	<i>Pnma</i>
Er ₅ Pt ₃	41.2	<i>hP16</i>	<i>P6₃/mcm</i>
Er ₅ Pt ₄	48.2	<i>oP36</i>	<i>Pnma</i>
ErPt	53.8	<i>oP8</i>	<i>Pnma</i>
Er ₃ Pt ₄	60.8	<i>hR14</i>	<i>R$\bar{3}m$</i>

ErPt₂	70.0	<i>cF24</i>	<i>Fd</i> $\bar{3}m$
ErPt₃	~78	<i>cP4</i>	<i>Pm</i> $\bar{3}m$
ErPt₅	85.3	<i>o*72</i>	...
(Pt)	100	<i>cF4</i>	<i>Fm</i> $\bar{3}m$

Er-Se (Erbium - Selenium)

H. Okamoto, 1990

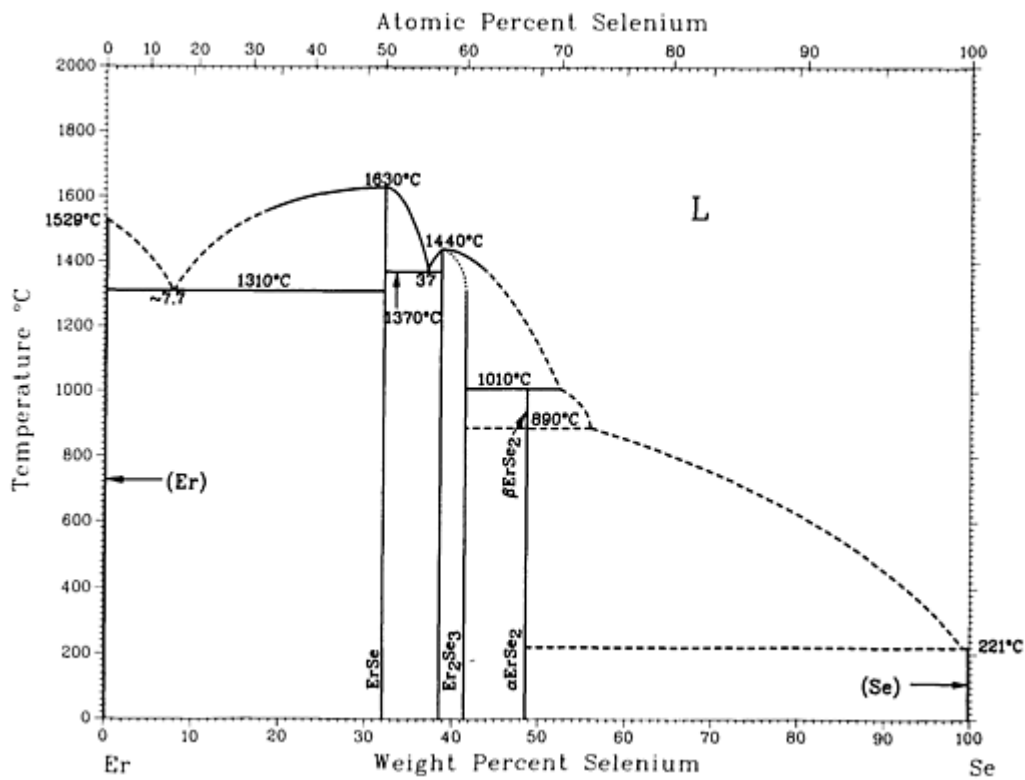

Er-Se phase diagram

Er-Se crystallographic data

Phase	Composition, wt% Se	Pearson symbol	Space group
(Er)	0	<i>hP2</i>	<i>P6₃/mmc</i>
ErSe	32.1	<i>cF8</i>	<i>Fm</i> $\bar{3}m$

Er_2Se_3	38.6 to 42	<i>oF80</i>	<i>Fddd</i>
$\beta\text{-ErSe}_2$	48.6	<i>oC132</i>	<i>Cmma</i>
$\alpha\text{-ErSe}_2$	48.6	<i>oI12</i>	<i>Immm</i>
(Se)	100	<i>hP3</i>	<i>P3_121</i>

Er-Te (Erbium - Tellurium)

H. Okamoto, 1990

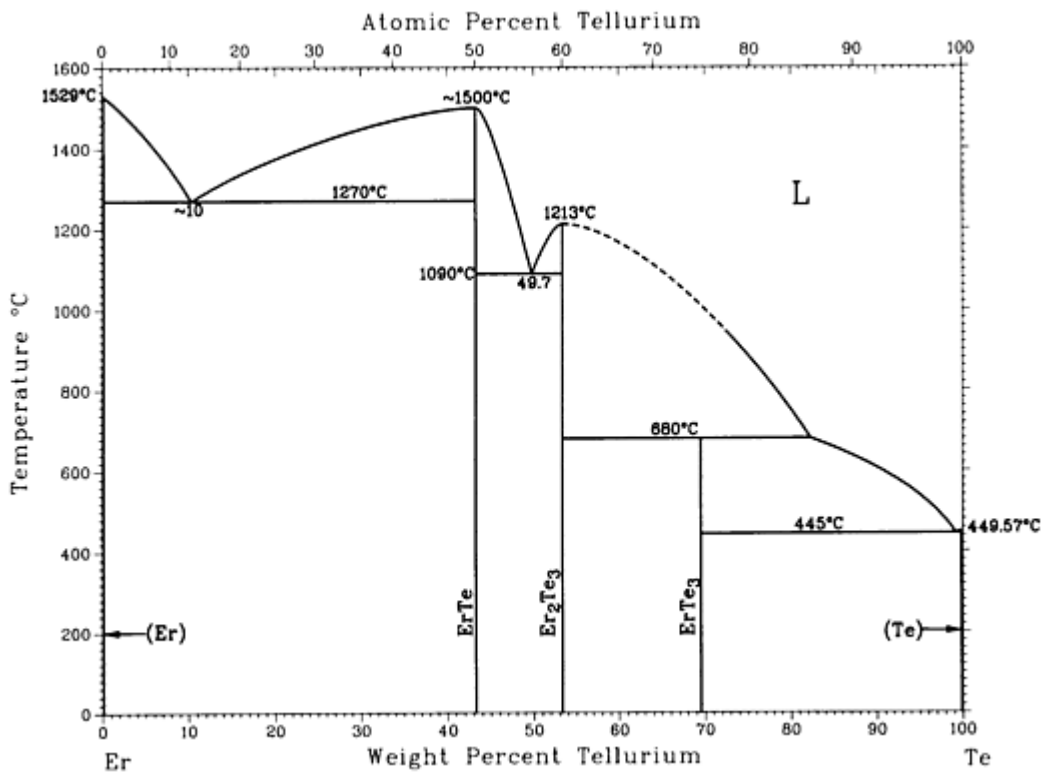

Er-Te phase diagram

Er-Te crystallographic data

Phase	Composition, wt% Te	Pearson symbol	Space group
(Er)	0	<i>hP2</i>	<i>P6_3/mmc</i>
ErTe	43.3	<i>cF8</i>	<i>Fm$\bar{3}m$</i>

Er_2Te_3	53	<i>oF80</i>	<i>Fddd</i>
ErTe_3	70	<i>oC16</i>	<i>Cmcm</i>
(Te)	100	<i>hP3</i>	<i>P3_121</i>
High-temperature, high-pressure phase			
ErTe_2	60.4	<i>tP6</i>	<i>P4/nmm</i>

Er-Ti (Erbium - Titanium)

J.L. Murray, 1987

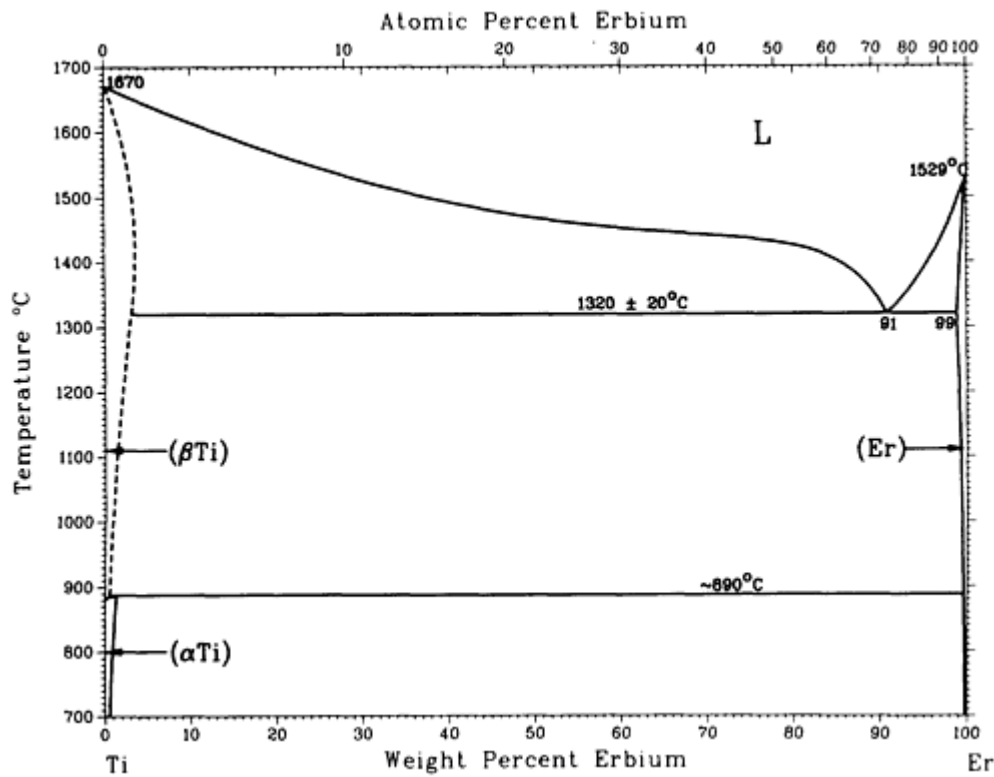

Er-Ti phase diagram

Er-Ti crystallographic data

Phase	Composition, wt% Er	Pearson symbol	Space group
(βTi)	0 to ~3.1	<i>cI2</i>	<i>Im\bar{3}m</i>

(α Ti)	0 to \sim 1.0	<i>hP2</i>	<i>P6₃/mmc</i>
(Er)	99.7 to 100	<i>hP2</i>	<i>P6₃/mmc</i>

Er-Tl (Erbium - Thallium)

S. Delfino, A. Saccone, A. Palenzona, and R. Ferro, unpublished

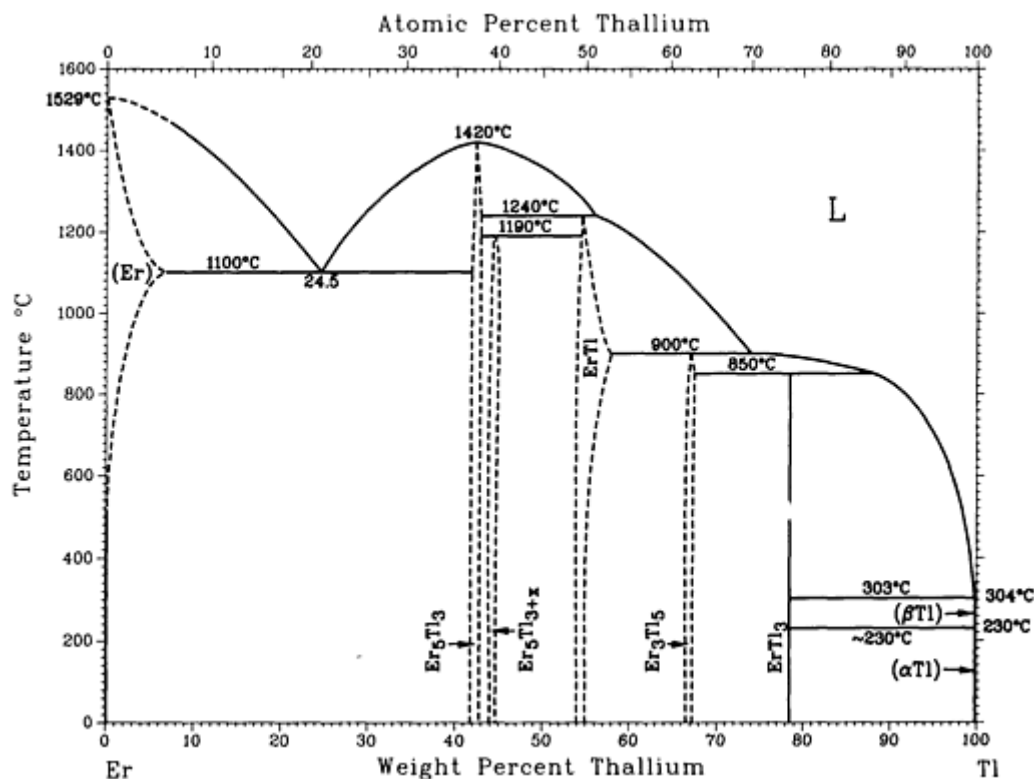

Er-Tl phase diagram

Er-Tl crystallographic data

Phase	Composition, wt% Tl	Pearson symbol	Space group
(Er)	0 to \sim 7	<i>hP2</i>	<i>P6₃/mmc</i>
Er ₅ Tl ₃	\sim 42 to 43	<i>hP16</i>	<i>P6₃/mcm</i>
Er ₅ Tl _{3+x}	?	<i>tI32</i>	<i>I4/mcm</i>
ErTl ^(a)	\sim 54 to \sim 58	<i>cP2</i> (or <i>cI2</i>)	<i>Pm</i> $\bar{3}$ <i>m</i> <i>Im</i> $\bar{3}$ <i>m</i>

ErTl^(b)	~54 to ~58	<i>tP2</i>	<i>P4/mmm</i>
Er₃Tl₅	~67 to ~68	<i>oC32</i>	<i>Cmcm</i>
ErTl₃	79	<i>cP4</i>	<i>Pm$\bar{3}m$</i>
(βTl)	100	<i>cI2</i>	<i>Im$\bar{3}m$</i>
(αTl)	100	<i>hP2</i>	<i>P6₃/mmc</i>

(a) Cubic structure presumed to be room-temperature and higher temperature phases.

(b) Tetragonal structure presumed to be lower temperature phase

Eu (Europium) Binary Alloy Phase Diagrams

Introduction

THIS ARTICLE includes systems where europium is the first-named element in the binary pair. Additional binary systems that include europium are provided in the following locations in this Volume:

- “Ag-Eu (Silver - Europium)” in the article “Ag (Silver) Binary Alloy Phase Diagrams.”
- “Au-Eu (Gold - Europium)” in the article “Au (Gold) Binary Alloy Phase Diagrams.”
- “Cd-Eu (Cadmium - Europium)” in the article “Cd (Cadmium) Binary Alloy Phase Diagrams.”
- “Cu-Eu (Copper - Europium)” in the article “Cu (Copper) Binary Alloy Phase Diagrams.”

Eu-Ga (Europium - Gallium)

S.P. Yatsenko, B.G. Semenov, and K.A. Chuntunov, 1978

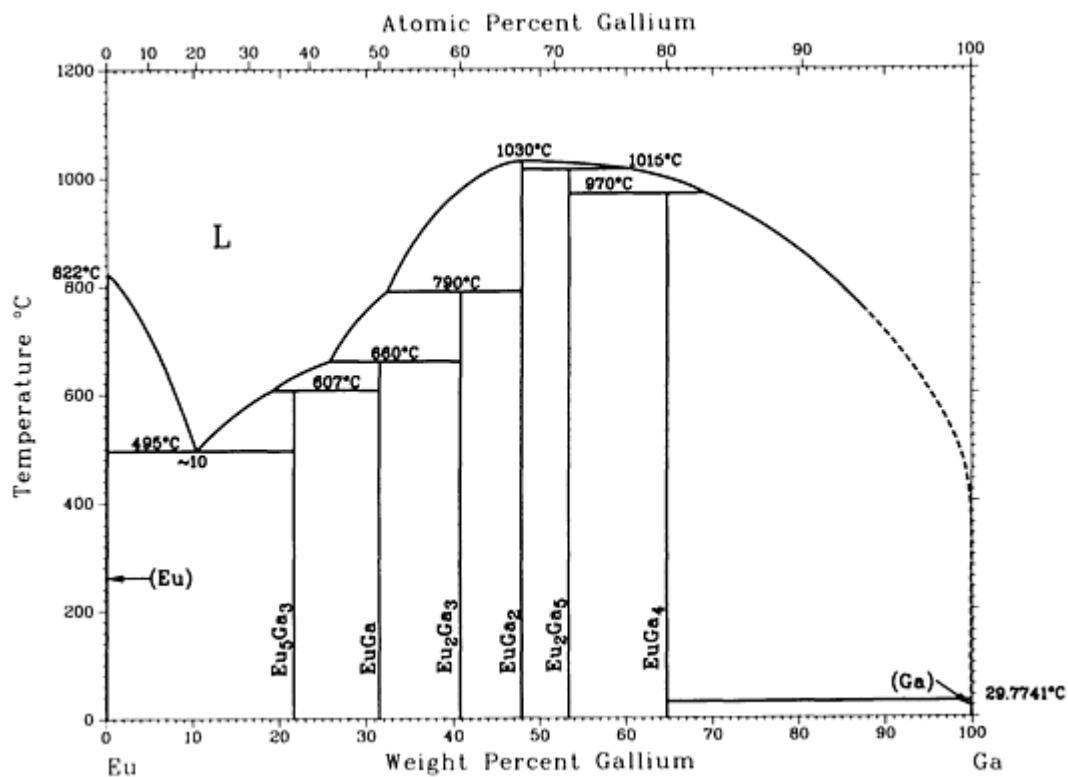

Eu-Ga phase diagram

Eu-Ga crystallographic data

Phase	Composition, wt% Ga	Pearson symbol	Space group
(Eu)	0	<i>cI2</i>	$Im\bar{3}m$
Eu_5Ga_3	21.6
EuGa	31.5
Eu_2Ga_3	41
β $\text{EuGa}_2^{(a)}$	47.9	<i>hP3</i>	<i>P6/mmm</i>
α $\text{EuGa}_2^{(b)}$	47.9	<i>oI12</i>	<i>Imma</i>
Eu_2Ga_5	53.4

EuGa₄	65	<i>tI10</i>	<i>I4/mmm</i>
(Ga)	100	<i>oC8</i>	<i>Cmca</i>

- (a) Hexagonal structure presumed to be lower temperature phase.
- (b) Cubic structure presumed to be higher temperature phase

Eu-Ge (Europium - Germanium)

A.B. Gokhale and G.J. Abbaschian, 1991

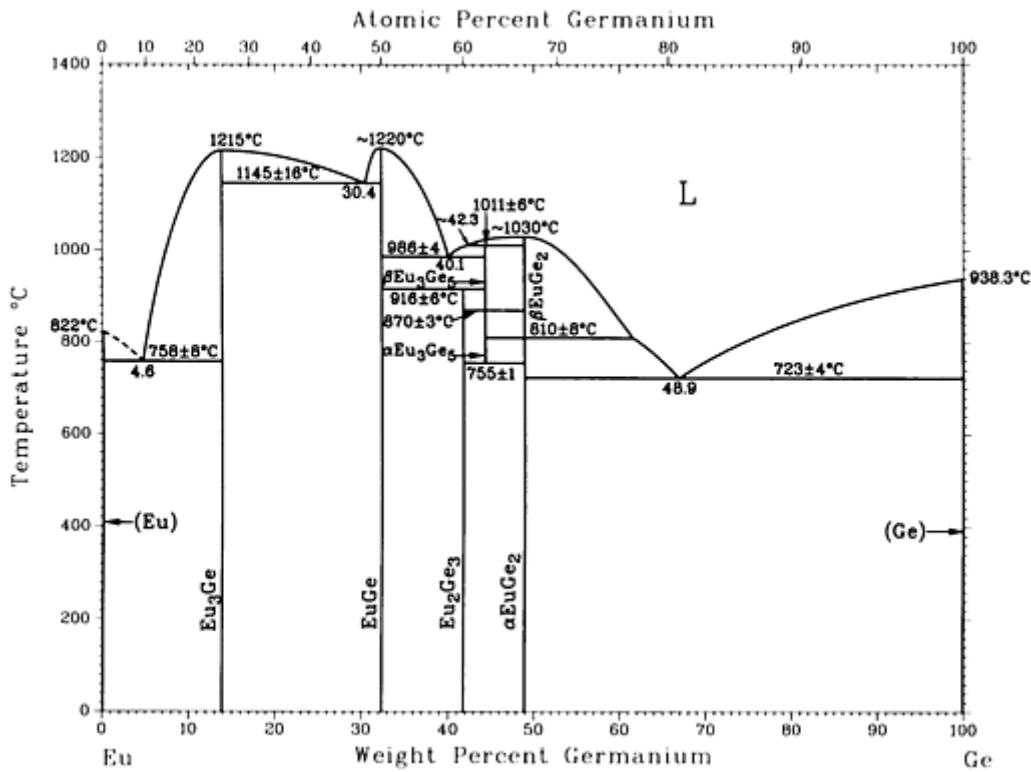

Eu-Ge phase diagram

Eu-Ge crystallographic data

Phase	Composition, wt% Ge	Pearson symbol	Space group
(Eu)	0	<i>cI2</i>	<i>Im$\bar{3}m$</i>

EuGe	32.3	<i>oC8</i>	<i>Cmcm</i>
Eu₂Ge₃	41.7
βEu₃Ge₅	44.3
αEu₃Ge₅	44.3	(a)	...
βEuGe₂	48.82
αEuGe₂	48.9	<i>hP3</i>	<i>P$\bar{3}m1$</i>
(Ge)	100	<i>cF8</i>	<i>Fd$\bar{3}m$</i>

(a) Hexagonal structure

Eu-In (Europium - Indium)

H. Okamoto, 1990

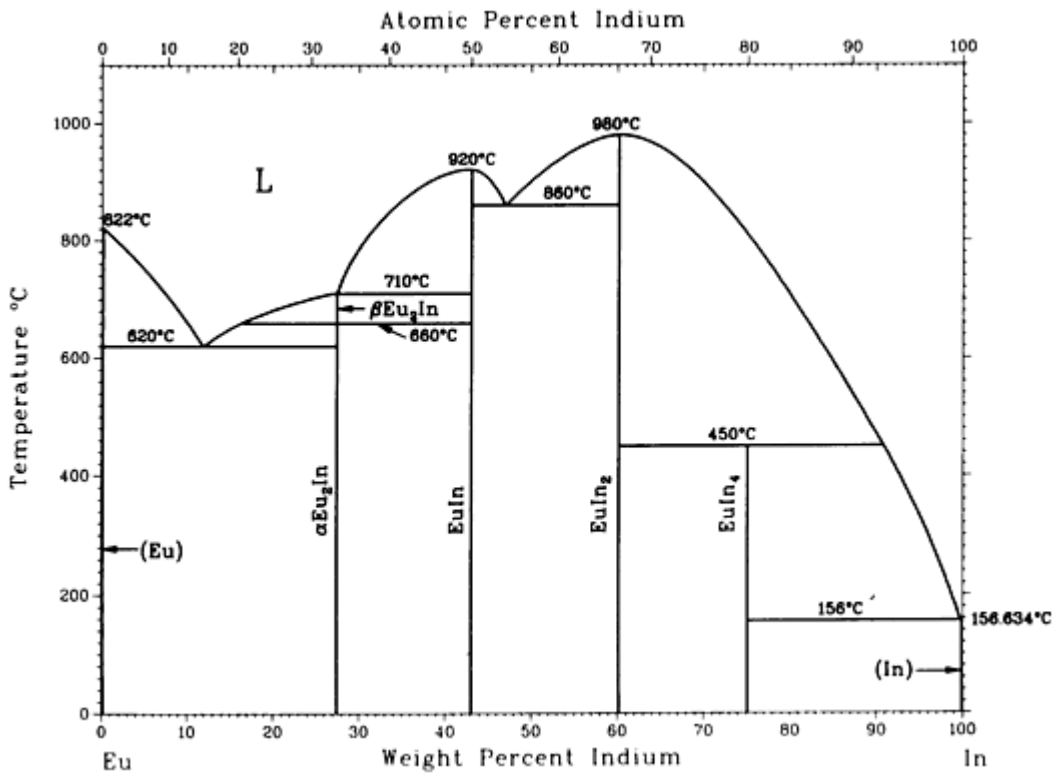

Eu-In phase diagram

Eu-In crystallographic data

Phase	Composition, wt% In	Pearson symbol	Space group
(Eu)	0	<i>cI2</i>	<i>Im$\bar{3}m$</i>
β Eu ₂ In	27.4
α Eu ₂ In	27.4
EuIn	43.0
EuIn ₂	60.1	<i>hP6</i>	<i>P6₃/mmc</i>
EuIn ₄	75.1
(In)	100	<i>tI2</i>	<i>I4/mmm</i>

Eu-Mg (Europium - Magnesium)

H. Okamoto, 1992

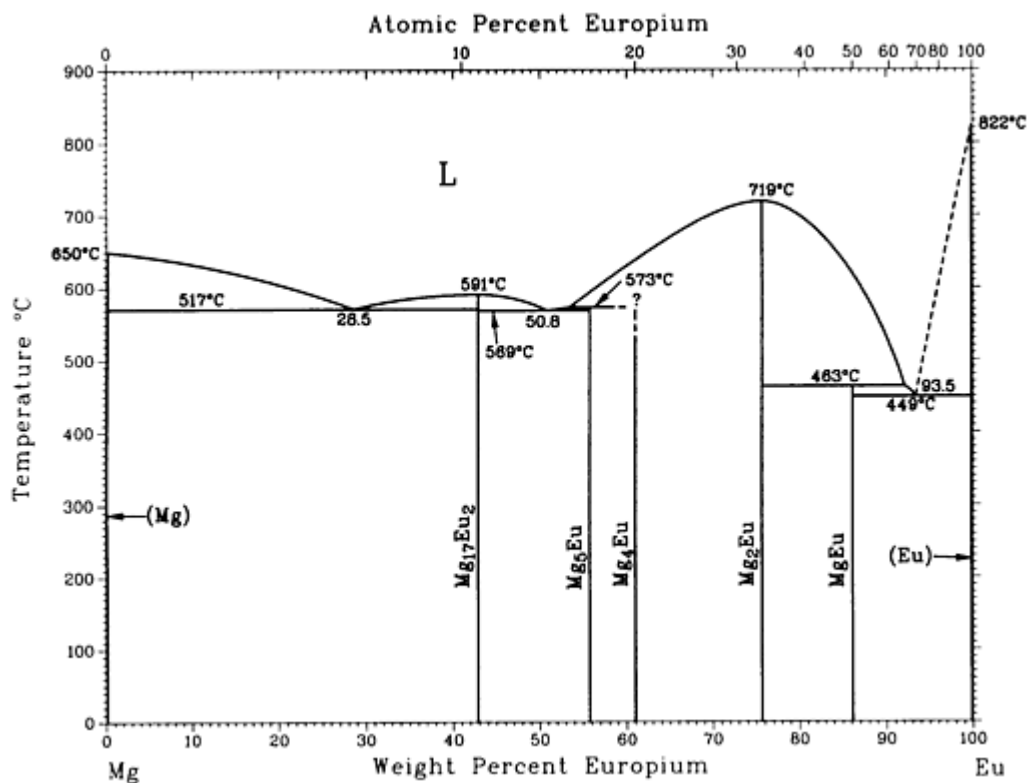

Eu-Mg phase diagram

Eu-Mg crystallographic data

Phase	Composition, wt% Eu	Pearson symbol	Space group
(Mg)	0	<i>hP2</i>	<i>P6₃/mmc</i>
$Mg_{17}Eu_2$	42.3	<i>hP38</i>	<i>P6₃/mmc</i>
Mg_5Eu	55.6	<i>hP36</i>	<i>P6₃/mmc</i>
Mg_4Eu	61	<i>hP90</i>	<i>P6₃/mmc</i>
Mg_2Eu	75.7	<i>hP12</i>	<i>P6₃/mmc</i>
$MgEu$	86.2	<i>cP2</i>	<i>Pm$\bar{3}m$</i>
(Eu)	100	<i>cI2</i>	<i>Im$\bar{3}m$</i>

Eu-Pb (Europium - Lead)

O.D. McMasters and K.A. Gschneidner, Jr., 1967

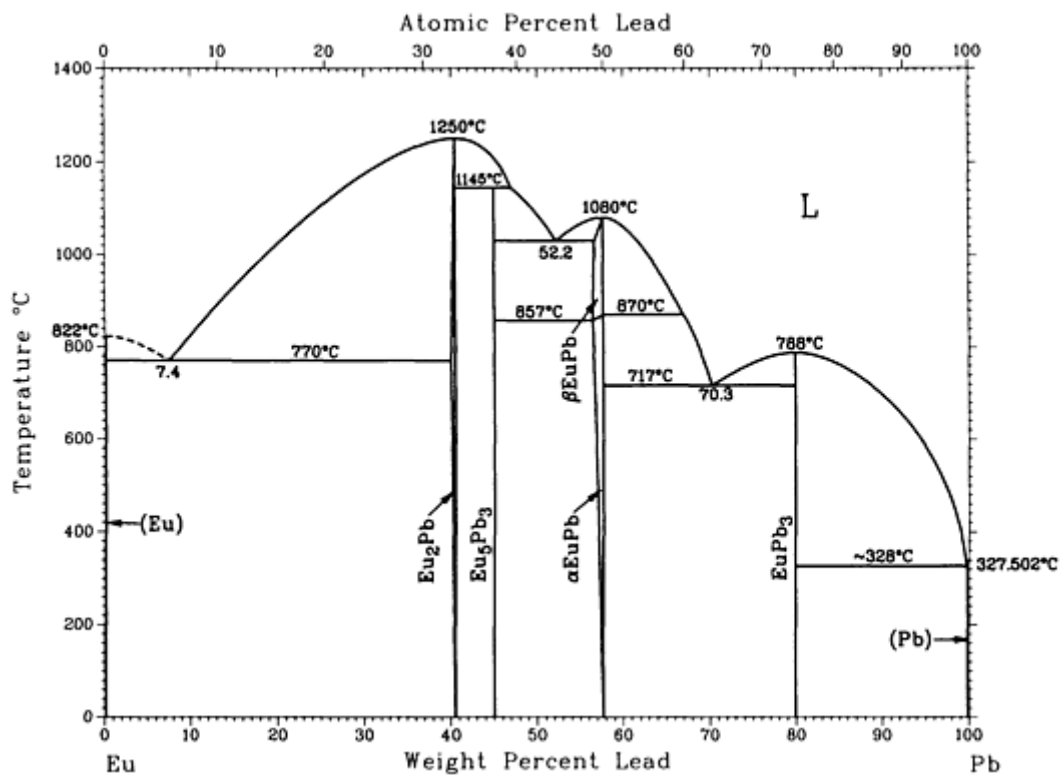

Eu-Pb phase diagram

Eu-Pb crystallographic data

Phase	Composition, wt% Pb	Pearson symbol	Space group
(Eu)	0	$cI2$	$Im\bar{3}m$
Eu_2Pb	~40 to 40.5	$oP12$	$Pnma$
Eu_5Pb_3	45.0	$tI32$	$I4/mcm$
βEuPb	~57.7
$\alpha\text{EuPb}^{(a)}$	~57.7	$tP2$	$P4/mmm$
EuPb_3	80	$cP4$	$Pm\bar{3}m$
(Pb)	100	$cF4$	$Fm\bar{3}m$

(a) Crystal structure data might be for β EuPd.

Eu-Pd (Europium - Palladium)

H. Okamoto, 1990

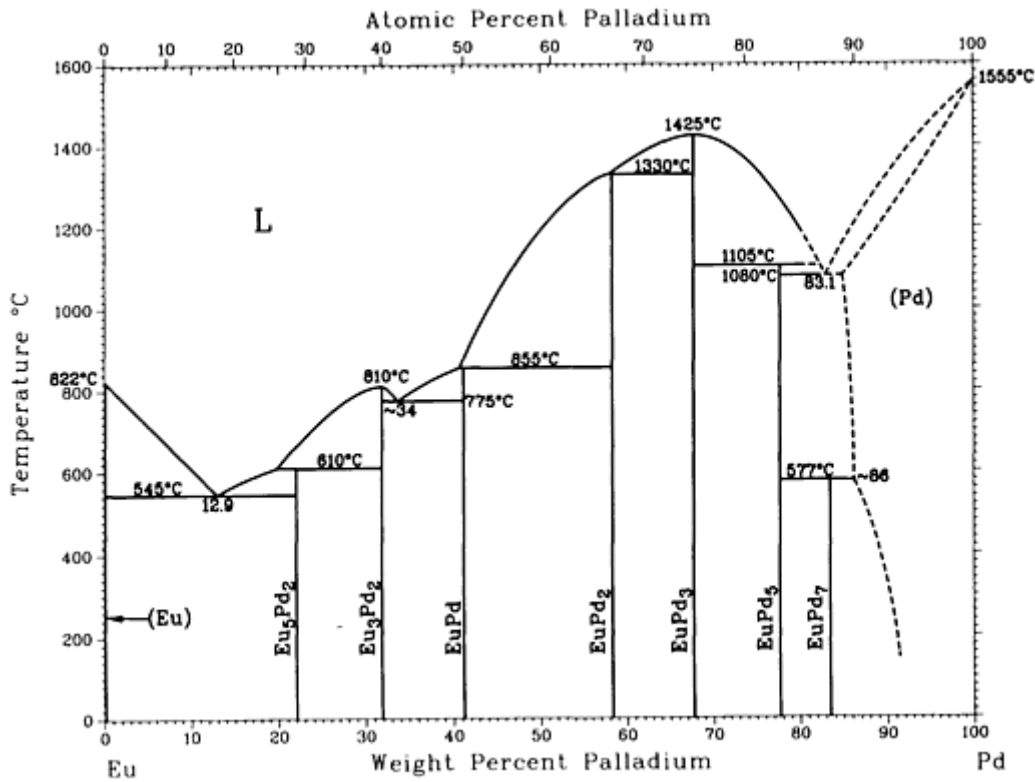

Eu-Pd phase diagram

Eu-Pd crystallographic data

Phase	Composition, wt% Pd	Pearson symbol	Space group
(Eu)	0	<i>cI2</i>	<i>Im</i> $\bar{3}m$
Eu ₅ Pd ₂	21.8	<i>mC28</i>	<i>C2/c</i>
Eu ₃ Pd ₂	32	<i>hR15</i>	<i>R</i> $\bar{3}$
EuPd	41.2	<i>oC8</i>	<i>Cmcm</i>
EuPd ₂	58.4

EuPd₃	68	<i>cP4</i>	<i>Pm</i> $\bar{3}m$
EuPd₅	77.7	<i>o*72</i>	...
EuPd₇	~83.1	<i>c**</i>	...
(Pd)	~86 to 100	<i>cF4</i>	<i>Fm</i> $\bar{3}m$

Eu-Pt (Europium - Platinum)

A. Iandelli and A. Palenzona, 1981

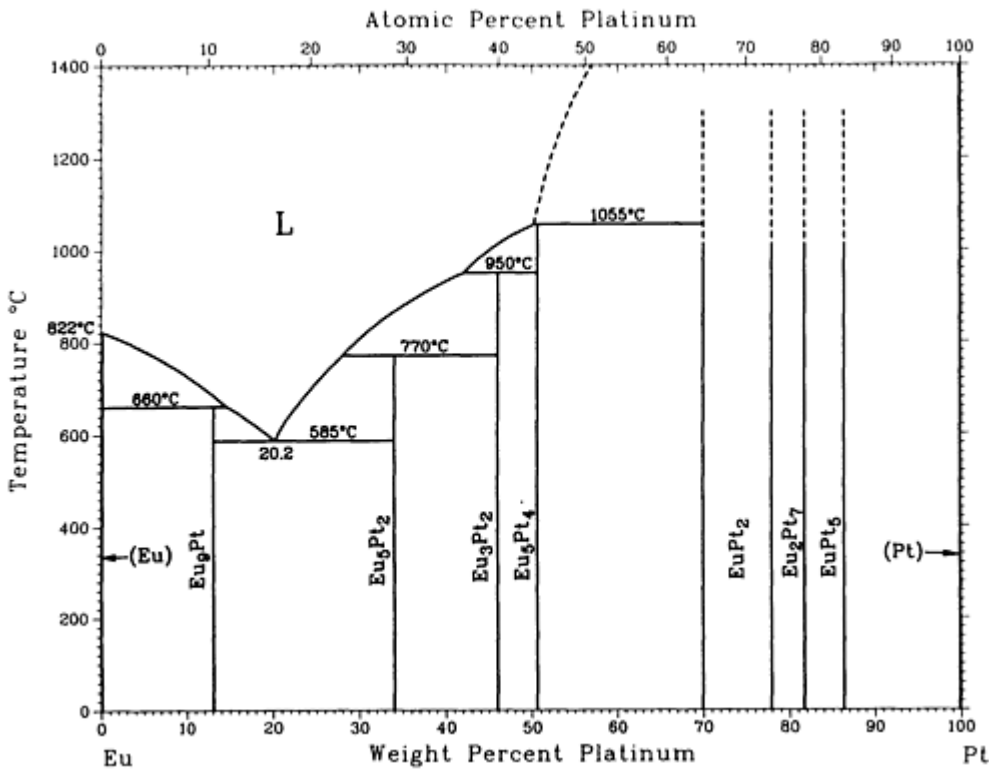

Eu-Pt phase diagram

Eu-Pt crystallographic data

Phase	Composition, wt% Pt	Pearson symbol	Space group
(Eu)	0	<i>cI2</i>	<i>Im</i> $\bar{3}m$
Eu₉Pt	13	<i>cF*</i>	...

Eu_5Pt_2	34.0	<i>mC28</i>	<i>C2/c</i>
Eu_3Pt_2	46	<i>hR15</i>	$R\bar{3}$
Eu_5Pt_4	50.6	<i>oP36</i>	<i>Pnma</i>
EuPt_2	70 to 78	<i>cF24</i>	$Fd\bar{3}m$
Eu_2Pt_7	81.8	<i>hP36</i>	<i>P6_3/mmc</i>
EuPt_5	86.5	<i>o**</i>	...
(Pt)	100	<i>cF4</i>	$Fm\bar{3}m$

Eu-Te (Europium - Tellurium)

O.A. Sadovskaya and E.I. Yarembash, 1970

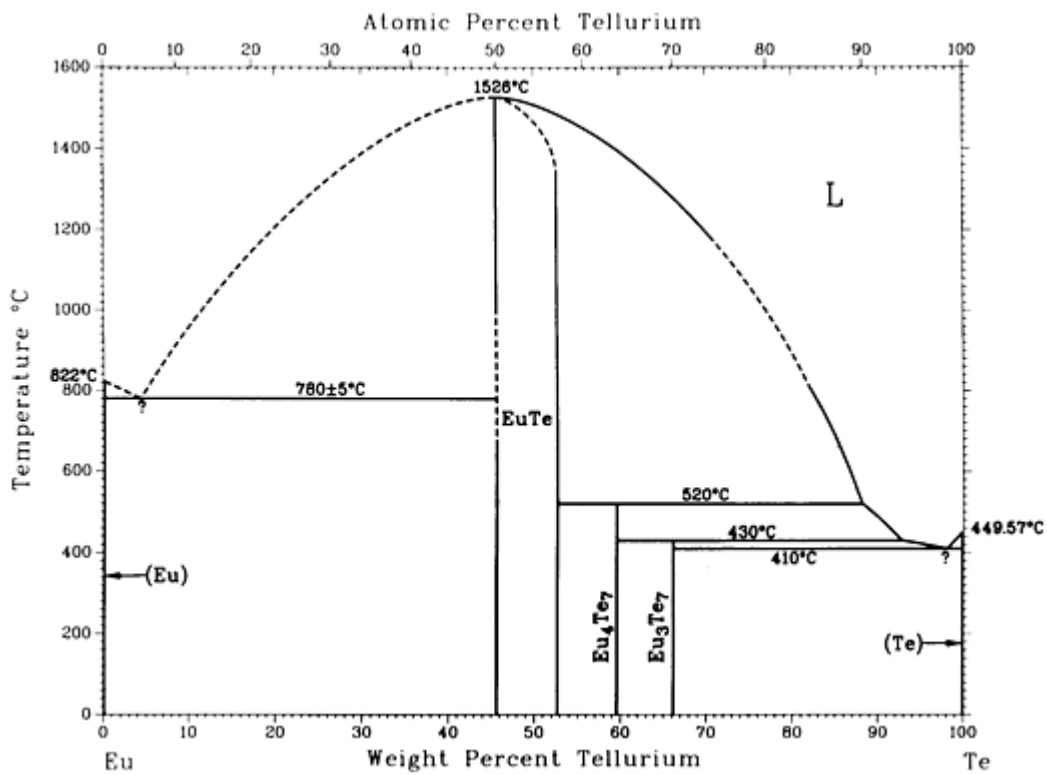

Eu-Te. Phase-Diagram

Eu-Te crystallographic data

Phase	Composition, wt% Te	Pearson symbol	Space group
(Eu)	0	<i>cI2</i>	<i>Im</i> $\bar{3}m$
EuTe	46 to 52.8	<i>cF8</i>	<i>Fm</i> $\bar{3}m$
Eu ₄ Te ₇	59.5
Eu ₃ Te ₇	66
(Te)	100	<i>hP3</i>	<i>P</i> ₃ 21

Fe (Iron) Binary Alloy Phase Diagrams

Introduction

THIS ARTICLE includes systems where iron is the first-named element in the binary pair. Additional binary systems that include iron are provided in the following locations in this Volume:

- “Ag-Fe (Silver - Iron)” in the article “Ag (Silver) Binary Alloy Phase Diagrams.”
- “Al-Fe (Aluminum - Iron)” in the article “Al (Aluminum) Binary Alloy Phase Diagrams.”
- “As-Fe (Arsenic - Iron)” in the article “As (Arsenic) Binary Alloy Phase Diagrams.”
- “Au-Fe (Gold - Iron)” in the article “Au (Gold) Binary Alloy Phase Diagrams.”
- “B-Fe (Boron - Iron)” in the article “B (Boron) Binary Alloy Phase Diagrams.”
- “Be-Fe (Beryllium - Iron)” in the article “Be (Beryllium) Binary Alloy Phase Diagrams.”
- “C-Fe (Carbon - Iron)” in the article “C (Carbon) Binary Alloy Phase Diagrams.”
- “Ce-Fe (Cerium - Iron)” in the article “Ce (Cerium) Binary Alloy Phase Diagrams.”
- “Co-Fe (Cobalt - Iron)” in the article “Co (Cobalt) Binary Alloy Phase Diagrams.”
- “Cr-Fe (Chromium - Iron)” in the article “Cr (Chromium) Binary Alloy Phase Diagrams.”
- “Cu-Fe (Copper - Iron)” in the article “Cu (Copper) Binary Alloy Phase Diagrams.”
- “Dy-Fe (Dysprosium - Iron)” in the article “Dy (Dysprosium) Binary Alloy Phase Diagrams.”
- “Er-Fe (Erbium - Iron)” in the article “Er (Erbium) Binary Alloy Phase Diagrams.”

Fe-Ga (Iron - Gallium)

H. Okamoto, 1992

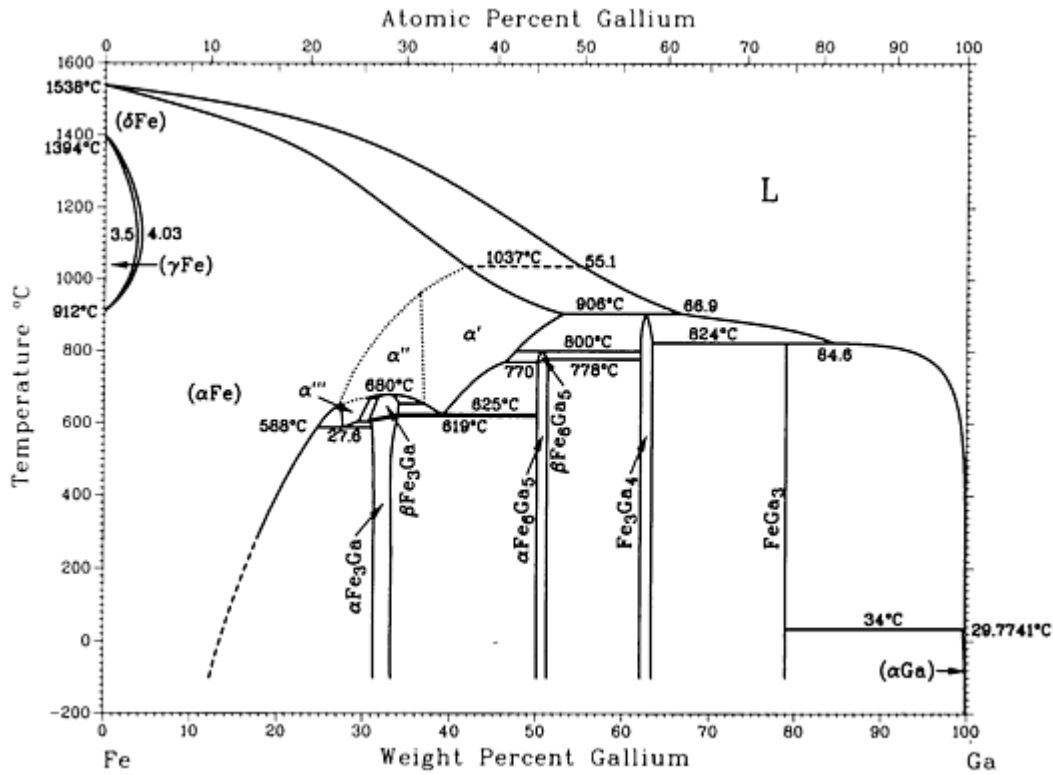

Fe-Ga phase diagram

Fe-Ga crystallographic data

Phase	Composition, wt% Ga	Pearson symbol	Space group
(γFe)	0 to 3.5	cF4	$Fm\bar{3}m$
(αFe)	0 to 41	cI2	$Im\bar{3}m$
α'	36.5 to 53.0	cP2	$Pm\bar{3}m$
α''	26.9 to 37.1	cF16	$Fm\bar{3}m$
α'''	26.9 to 30.4	cF16	$Fm\bar{3}m$
β-Fe ₃ Ga	30.5 to 33.8	hP8	$P6_3/mmc$

$\alpha\text{Fe}_3\text{Ga}$	30.7 to 34.0	$cP4$	$Pm\bar{3}m$
$\beta\text{Fe}_6\text{Ga}_5$	50.0 to 51.0	$hR26$	$R\bar{3}m$
$\alpha\text{Fe}_6\text{Ga}_5$	50.0 to 51.0	$mC44$	$C2/m$
Fe_3Ga_4	61.9 to 63.3	$mC42$ t^*63	$C2/m$...
FeGa_3	79	$tP16$ $tP16$	$P\bar{4}n2$ PA_2/mnm
(αGa)	100	$oC8$	$Cmca$
Metastable phase			
$\text{Fe}_{13}\text{Ga}_9$	46.4

Fe-Gd (Iron - Gadolinium)

H. Okamoto, 1992

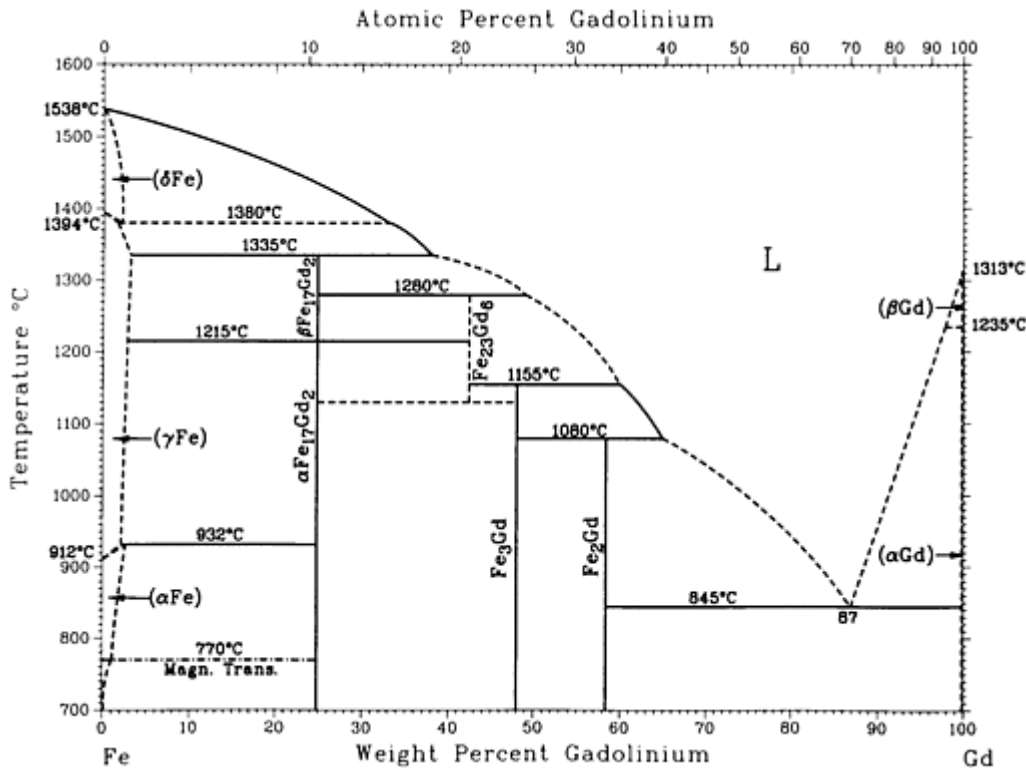

Fe-Gd phase diagram

Fe-Gd crystallographic data

Phase	Composition, wt% Gd	Pearson symbol	Space group
(δ Fe)	0	<i>cI2</i>	<i>Im$\bar{3}m$</i>
(γ Fe)	0	<i>cF4</i>	<i>Fm$\bar{3}m$</i>
(α Fe)	0	<i>cI2</i>	<i>Im$\bar{3}m$</i>
β Fe ₁₇ Gd ₂	24.8	<i>hP38</i>	<i>P6₃/mmc</i>
α Fe ₁₇ Gd ₂	24.8	<i>hR19</i>	<i>R$\bar{3}m$</i>
Fe ₂₃ Gd ₆	42.4	<i>cF116</i>	<i>Fm$\bar{3}m$</i>
Fe ₃ Gd	48	<i>hR12</i>	<i>R$\bar{3}m$</i>
Fe ₂ Gd	58.4	<i>cF24</i>	<i>Fd$\bar{3}m$</i>
(β Gd)	100	<i>cI2</i>	<i>Im$\bar{3}m$</i>
(α Gd)	100	<i>hP2</i>	<i>P6₃/mmc</i>
Questionable phases			
Fe ₅ Gd	24	<i>hP*</i>	...
Fe ₁₇ Gd ₂	24.8	<i>hP8</i>	<i>P6/mmm</i>
Fe ₅ Gd	36.1	<i>hP6</i>	<i>P6/mmm</i>
Fe ₄ Gd	41	<i>hP10</i>	...
Fe ₇ Gd ₂	44.6	<i>o*18</i>	...
Fe ₃ Gd ₂	65	<i>c*30</i>	...

Fe-Ge (Iron - Germanium)

E. Kato and S. Nunoue, 1992

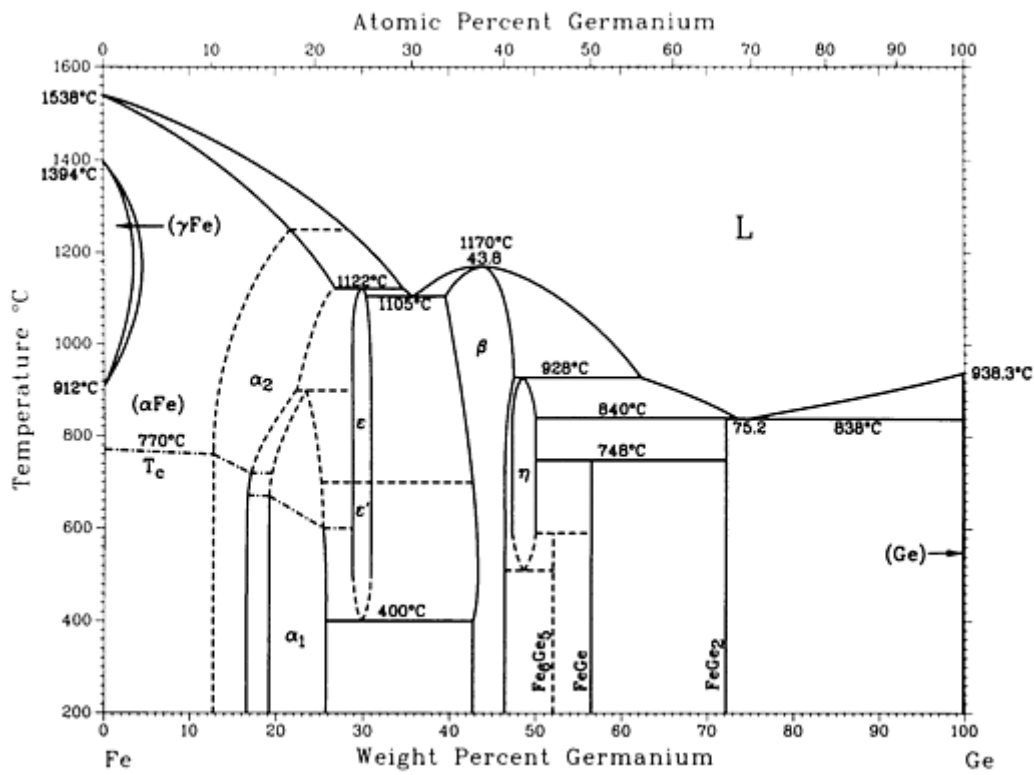

Fe-Ge phase diagram

Fe-Ge crystallographic data

Phase	Composition, wt% Ge	Pearson symbol	Space group
(γFe)	0 to 4.4	<i>cF4</i>	<i>Fm</i> $\bar{3}m$
(αFe)	0 to 21.6	<i>cI2</i>	<i>Im</i> $\bar{3}m$
α ₂	12.6 to 26.8	<i>cP2</i>	<i>Pm</i> $\bar{3}m$
α ₁	18.9 to 25.7	<i>cF16</i>	<i>Fm</i> $\bar{3}m$
ε(Fe ₃ Ge)	28.8 to 31.0	<i>hP8</i>	<i>P6</i> ₃ / <i>mmc</i>

ϵ' (Fe ₃ Ge)	28.8 to 31.0	<i>cP4</i>	<i>Pm$\bar{3}m$</i>
β	39.6 to 47.5	<i>hP4</i>	<i>P6₃/mmc</i>
η	47.3 to 50.0	<i>hP6</i>	<i>P6₃/mmc</i>
Fe ₆ Ge ₅	52.0	...	<i>C2/m</i>
FeGe	56.5	<i>hP6</i> <i>cP8</i>	<i>C2/m</i> <i>P6/mmm</i> <i>P2₁₃</i>
FeGe ₂	72.3	<i>tI2</i>	<i>I4/mcm</i>
(Ge)	100	<i>cF8</i>	<i>Fd$\bar{3}m$</i>

Fe-H (Iron - Hydrogen)

A. San-Martin and F.D. Manchester, 1992

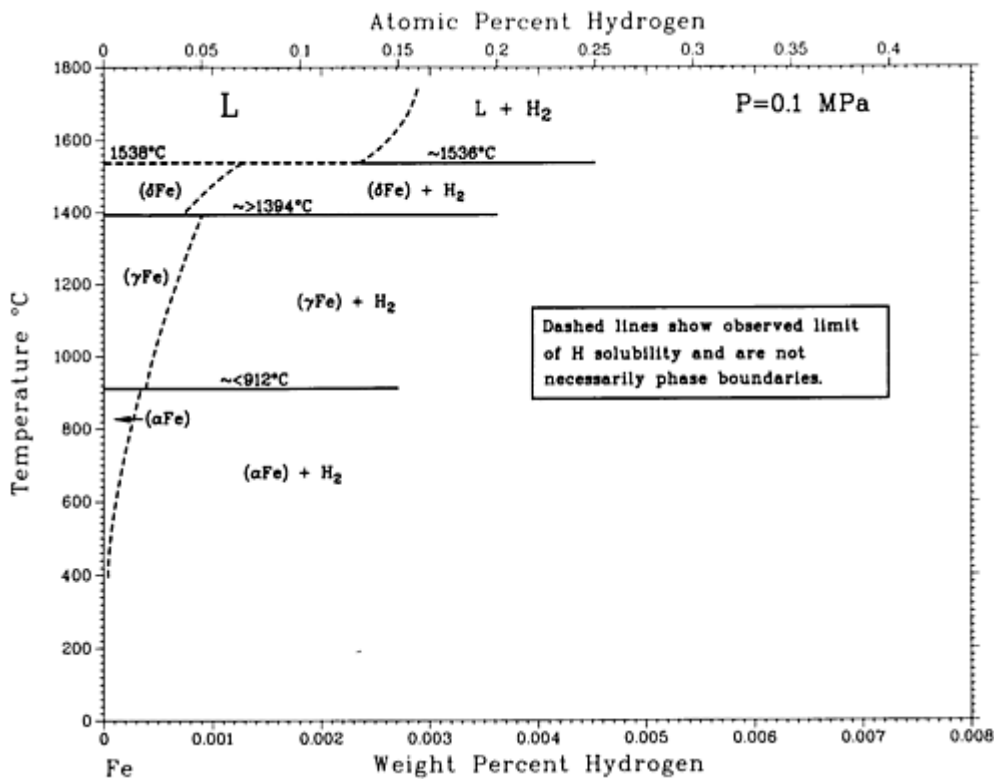

Fe-H phase diagram

Fe-H crystallographic data

Phase	Composition, wt% H	Pearson symbol	Space group
(δ Fe) or δ	0 to 0.0013	<i>cI2</i>	<i>Im$\bar{3}m$</i>
(γ Fe) or γ	0 to 0.0008	<i>cF4</i>	<i>Fm$\bar{3}m$</i>
(α Fe) or α	0 to 0.0003	<i>cI2</i>	<i>Im$\bar{3}m$</i>
Metastable phases			
ϵ	1.2 to 1.4 ^(a)	<i>hP2</i>	<i>P6$_3$/mmc</i>
		<i>hP4</i>	<i>P6$_3$/mmc</i>
		<i>hP4</i>	<i>P6$_3$mc</i>

(a) Produced under a pressure of 6.7 GPa at 250 °C

Fe-Hf (Iron - Hafnium)

H. Okamoto, 1992

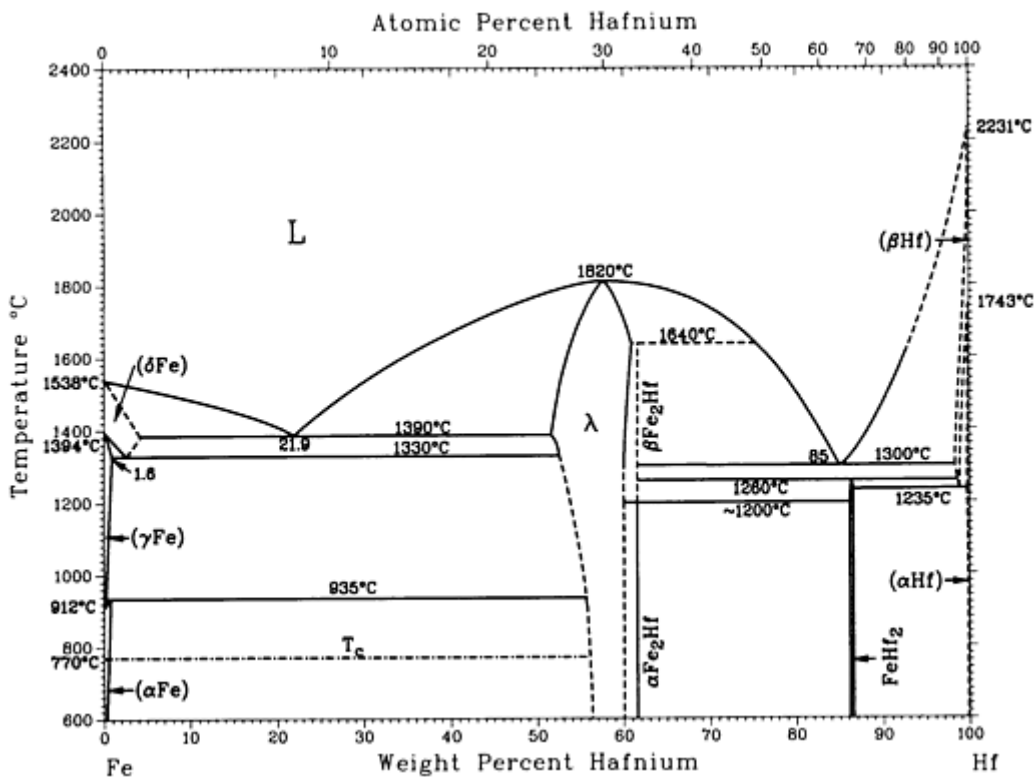

Fe-Hf phase diagram

Fe-Hf crystallographic data

Phase	Composition, wt% Hf	Pearson symbol	Space group
(δFe)	0 to 6	<i>cI2</i>	<i>Im</i> $\bar{3}m$
(γFe)	0 to 1.6	<i>cF4</i>	<i>Fm</i> $\bar{3}m$
(αFe)	0 to 0.70	<i>cI2</i>	<i>Im</i> $\bar{3}m$
λ	52 to 61.2	<i>hP12</i>	<i>P6</i> $_3/mmc$
$\beta_{\text{Fe}_2\text{Hf}}$	61.5	<i>hP24</i>	<i>P6</i> $_3/mmc$
$\alpha_{\text{Fe}_2\text{Hf}}$	61.5	<i>cF24</i>	<i>Fd</i> $\bar{3}m$
FeHf_2	85.6 to 86.6	<i>cF96</i>	<i>Fd</i> $\bar{3}m$
(β_{Hf})	? to 100	<i>cI2</i>	<i>Im</i> $\bar{3}m$
(α_{Hf})	? to 100	<i>hP2</i>	<i>P6</i> $_3/mmc$

Fe-Ho (Iron - Holmium)

H. Okamoto, 1992

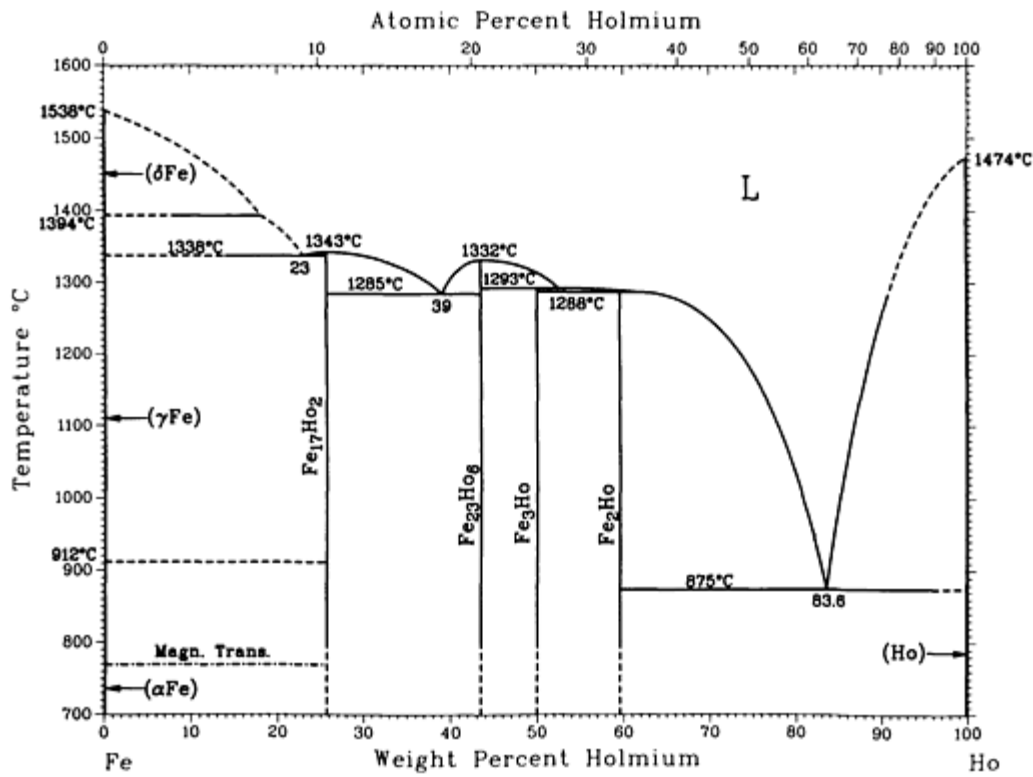

Fe-Ho phase diagram

Fe-Ho crystallographic data

Phase	Composition, wt% Ho	Pearson symbol	Space group
(δFe)	0	<i>cI2</i>	<i>Im</i> $\bar{3}m$
(γFe)	0	<i>cF4</i>	<i>Fm</i> $\bar{3}m$
(αFe)	0	<i>cI2</i>	<i>Im</i> $\bar{3}m$
Fe ₁₇ Ho ₂	25.7	<i>hP38</i>	<i>P6</i> ₃ / <i>mmc</i>
Fe ₂₃ Ho ₆	43.5	<i>cF116</i>	<i>Fm</i> $\bar{3}m$

Fe₃Ho	50	<i>hR12</i>	<i>R</i> $\bar{3}m$
Fe₂Ho	59.6	<i>cF24</i>	<i>Fd</i> $\bar{3}m$
(Ho)	100	<i>hP2</i>	<i>P6₃/mmc</i>
Metastable phase			
...	~75	<i>hP12</i>	<i>P6₃/mmc</i>

Fe-Ir (Iron - Iridium)

L.J. Swartzendruber, 1992

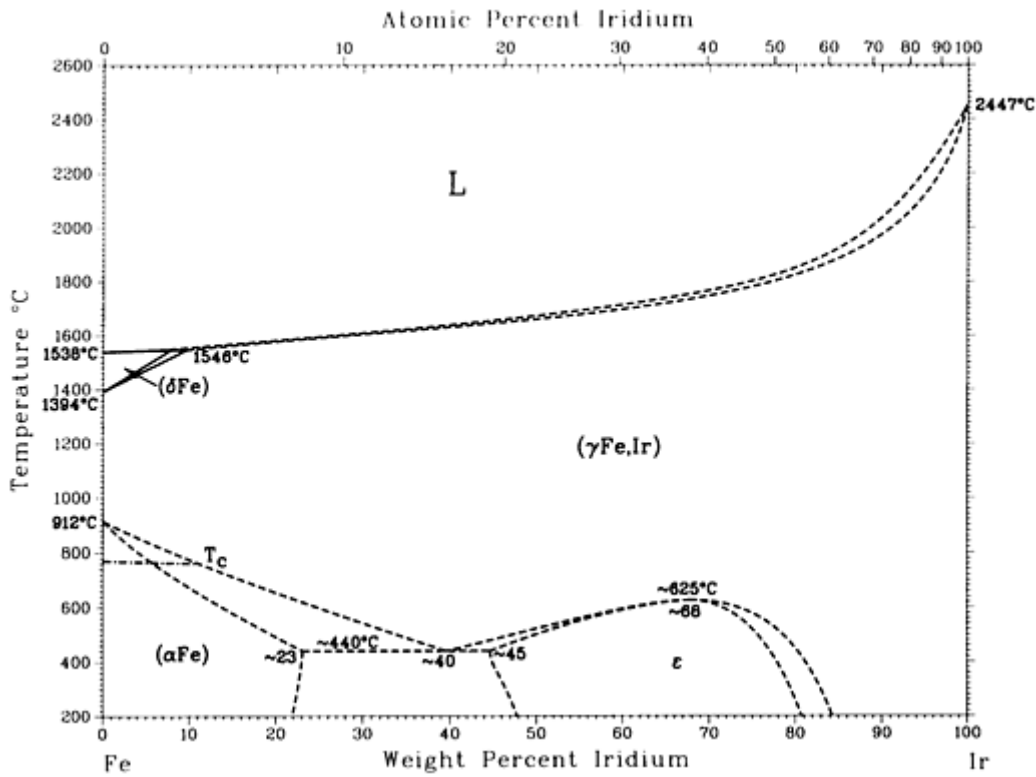

Fe-Ir phase diagram

Fe-Ir crystallographic data

Phase	Composition, wt% Ir	Pearson symbol	Space group
(αFe)	0 to ~23	<i>cI2</i>	<i>Im</i> $\bar{3}m$

$(\gamma_{\text{Fe,Ir}})$	0 to 100	<i>cF4</i>	$Fm\bar{3}m$
(δ_{Fe})	0 to 7	<i>cI2</i>	$Im\bar{3}m$
ϵ	~45 to 80	<i>hP2</i>	$P6_3/mmc$

Fe-La (Iron - Lanthanum)

H. Okamoto, 1992

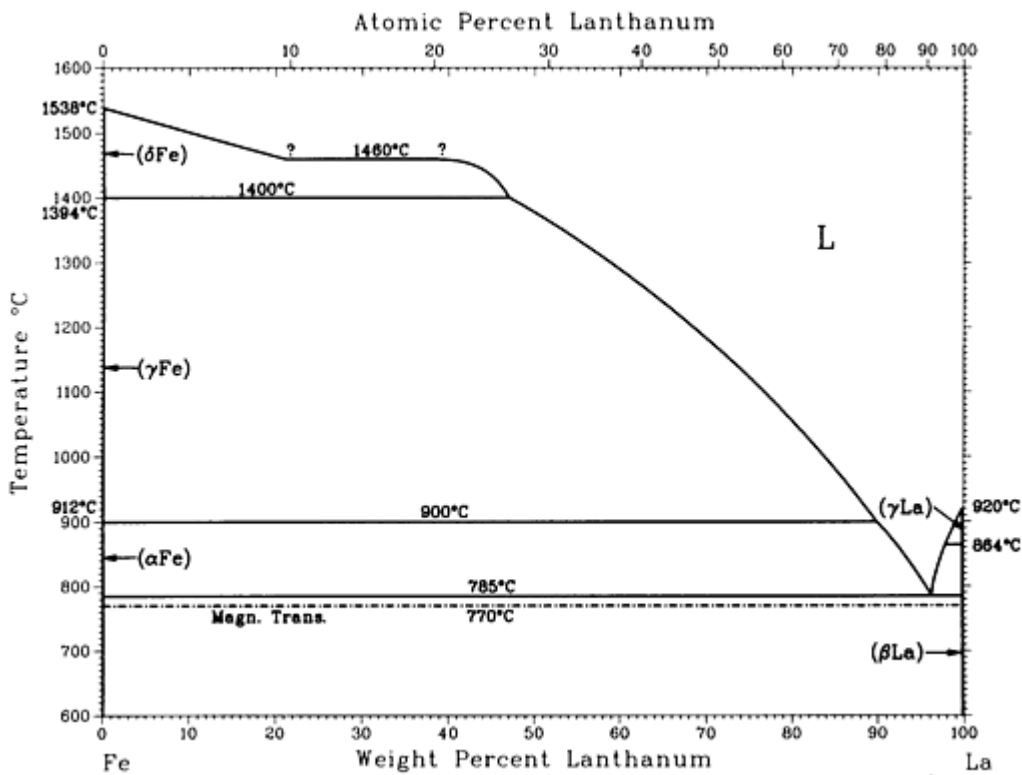

Fe-La phase diagram

Fe-La crystallographic data

Phase	Composition, wt% La	Pearson symbol	Space group
(δ_{Fe})	0	<i>cI2</i>	$Im\bar{3}m$
(γ_{Fe})	0	<i>cF4</i>	$Fm\bar{3}m$
(α_{Fe})	0	<i>cI2</i>	$Im\bar{3}m$

(γ La)	100	<i>cI2</i>	<i>Im</i> $\bar{3}m$
(β La)	100	<i>cF4</i>	<i>Fm</i> $\bar{3}m$
(α La)	100	<i>hP4</i>	<i>P6</i> $\bar{3}/mmc$

Fe-Lu (Iron - Lutetium)

H. Okamoto, 1992

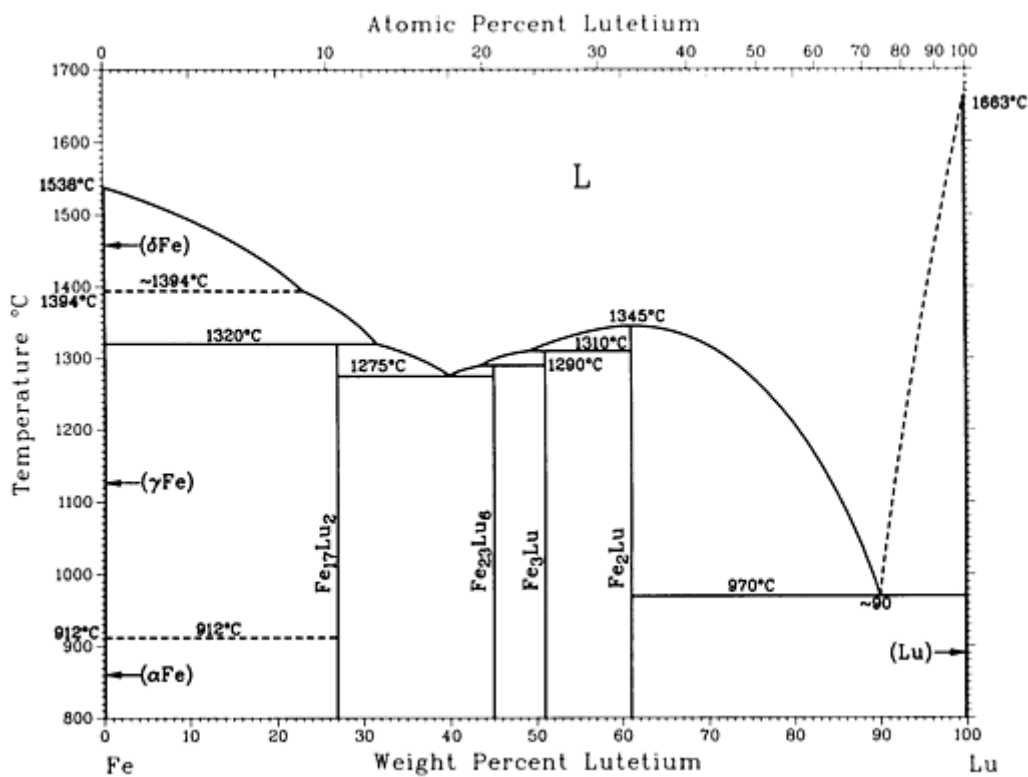

Fe-Lu phase diagram

Fe-Lu crystallographic data

Phase	Composition, wt% Lu	Pearson symbol	Space group
(δ Fe)	0	<i>cI2</i>	<i>Im</i> $\bar{3}m$
(γ Fe)	0	<i>cF4</i>	<i>Fm</i> $\bar{3}m$
(α Fe)	0	<i>cI2</i>	<i>Im</i> $\bar{3}m$

$\text{Fe}_{17}\text{Lu}_2$	24.7 to 26.9	<i>hP</i> 38	$P6_3/mmc$
$\text{Fe}_{23}\text{Lu}_6$	45.0	<i>cF</i> 116	$Fm\bar{3}m$
Fe_3Lu	51	<i>hR</i> 12	$R\bar{3}m$
Fe_2Lu	61.0	<i>cF</i> 24	$Fd\bar{3}m$
(Lu)	100	<i>hP</i> 2	$P6_3/mmc$
Metastable phase			
...	~76	<i>hP</i> 12	$P6_3/mmc$

Fe-Mn (Iron - Manganese)

H. Okamoto, 1992

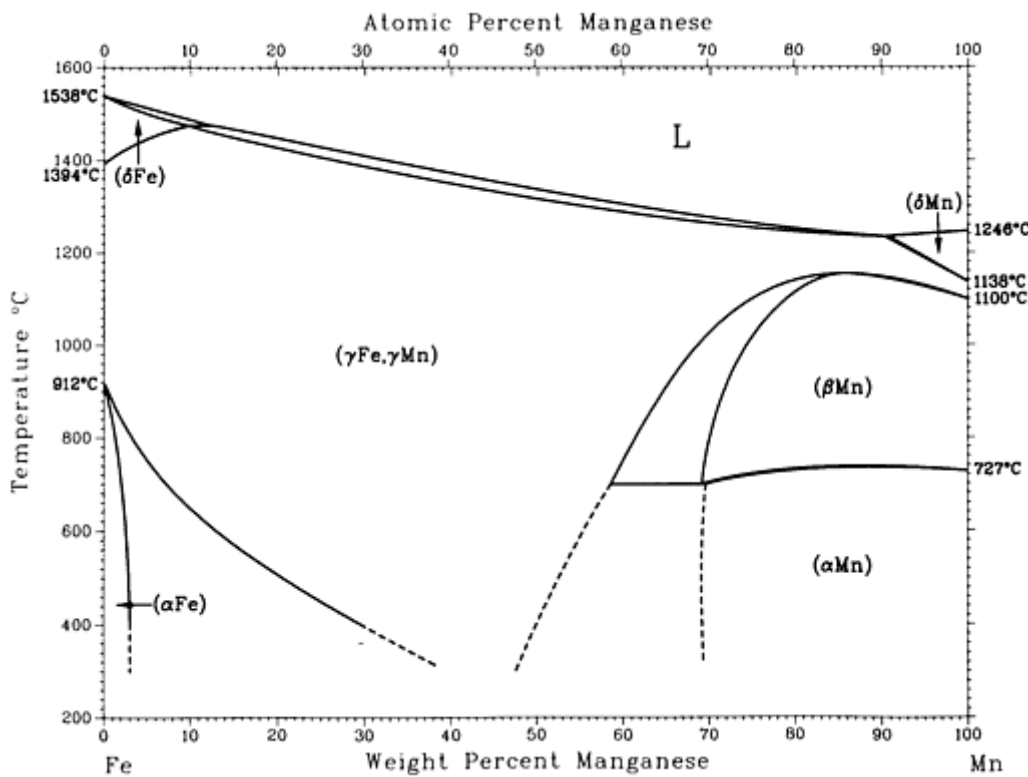

Fe-Mn phase diagram

Fe-Mn crystallographic data

Phase	Composition, wt% Mn	Pearson symbol	Space group
(δ Fe)	0 to 10	<i>cI2</i>	<i>Im</i> $\bar{3}m$
(γ Fe, γ Mn)	0 to 100	<i>cF4</i>	<i>Fm</i> $\bar{3}m$
(α Fe)	0 to 3	<i>cI2</i>	<i>Im</i> $\bar{3}m$
(δ Mn)	91 to 100	<i>cI2</i>	<i>Im</i> $\bar{3}m$
(β Mn)	69.2 to 100	<i>cP20</i>	<i>P4</i> ₁ <i>32</i>
(α Mn)	~70 to 100	<i>cI58</i>	<i>I</i> $\bar{4}$ ₃ <i>m</i>
Metastable phases			
α'	3 to 18	<i>tI2</i>	<i>I4/mmm</i>
ϵ	12 to 30	<i>hP2</i>	<i>P6</i> ₃ <i>/mmc</i>
γ'	?	<i>t**</i>	...

Fe-Mo (Iron - Molybdenum)

A. Fernández Guillermet, 1992

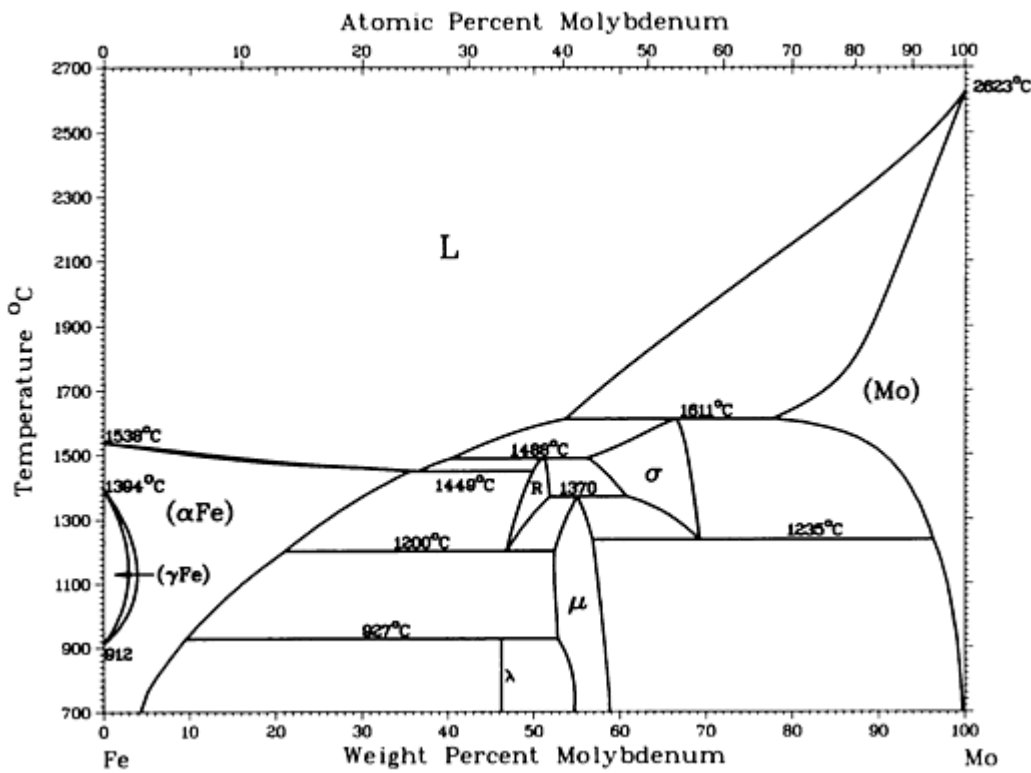

Fe-Mo phase diagram

Fe-Mo crystallographic data

Phase	Composition, wt% Mo	Pearson symbol	Space group
(αFe)	0 to 35.7	<i>cI2</i>	<i>Im$\bar{3}m$</i>
(γFe)	0 to 2.9	<i>cF4</i>	<i>Fm$\bar{3}m$</i>
λ	46.2	<i>hP12</i>	<i>P6₃/mmc</i>
R	46.8 to 51.8	<i>hR53</i>	...
μ	52.3 to 57.4	<i>hR13</i>	<i>R$\bar{3}m$</i>
σ	56.3 to 69.2	<i>tP30</i>	<i>P4₂/mnm</i>
(Mo)	79.0 to 100	<i>cI2</i>	<i>Im$\bar{3}m$</i>

Fe-N (Iron - Nitrogen)

H.A. Wriedt, N.A. Gokcen, and R.H. Nafziger, 1992

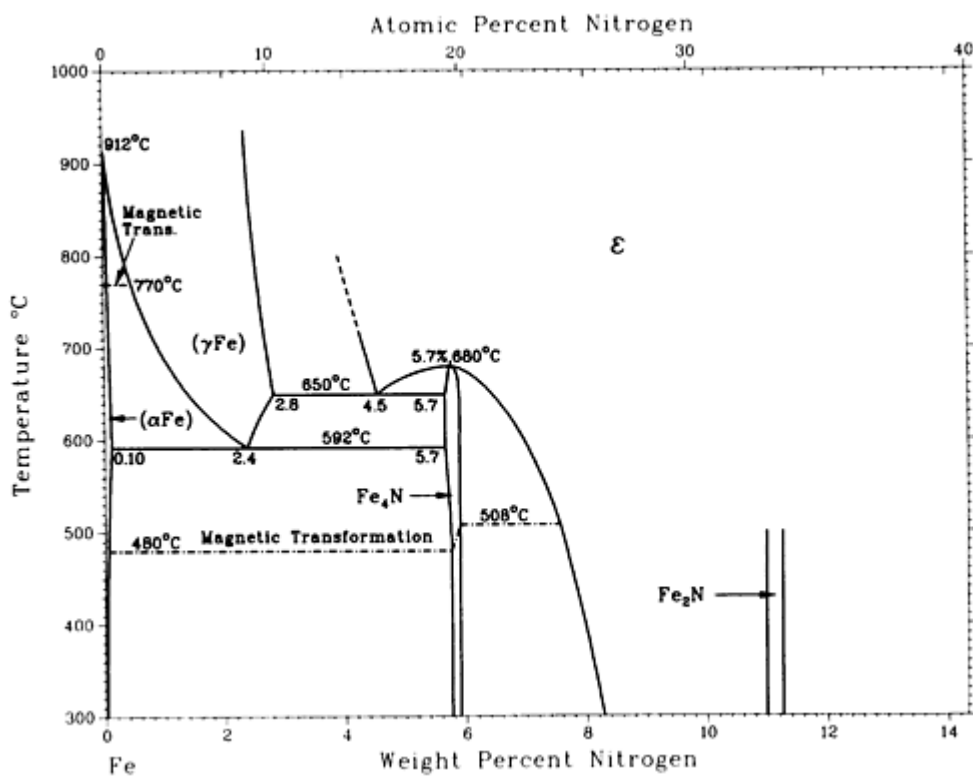

Fe-N phase diagram

Fe-N crystallographic data

Phase	Composition, wt% N	Pearson symbol	Space group
Stable at 0.1 MPa			
(δ Fe)	0.to \sim 0.9	<i>cI2</i>	<i>Im$\bar{3}m$</i>
(γ Fe)	0 to 2.8	<i>cF4</i>	<i>Fm$\bar{3}m$</i>
(α Fe)	0. to 0.10	<i>cI2</i>	<i>Im$\bar{3}m$</i>
Fe ₄ N	5.7 to 5.9	<i>cP5</i>	<i>Pm$\bar{3}m$</i> or <i>P$\bar{4}3m$</i>
ϵ	\sim 4 to \sim 11	<i>hP3</i>	<i>P6₃/mmc</i>
Fe ₂ N	\sim 11.1	<i>o**</i>	...
FeN ₆	\sim 61
FeN ₉	\sim 69
Other phases			
(ϵ Fe) ^(a)	0 to ?	<i>hP2</i>	<i>P6₃/mmc</i>
Martensite	0.6 to 0.6 0.7 to 2.6	<i>cI2</i> (b)	<i>Im$\bar{3}m$</i> ...
Fe ₁₆ N ₂	\sim 3.0	(b)	<i>I4/mmm</i>

(a) Stable at pressures >13 GPa.

(b) bct

Fe-Nb (Iron - Niobium)

E. Paul and L.J. Swartzendruber, 1992

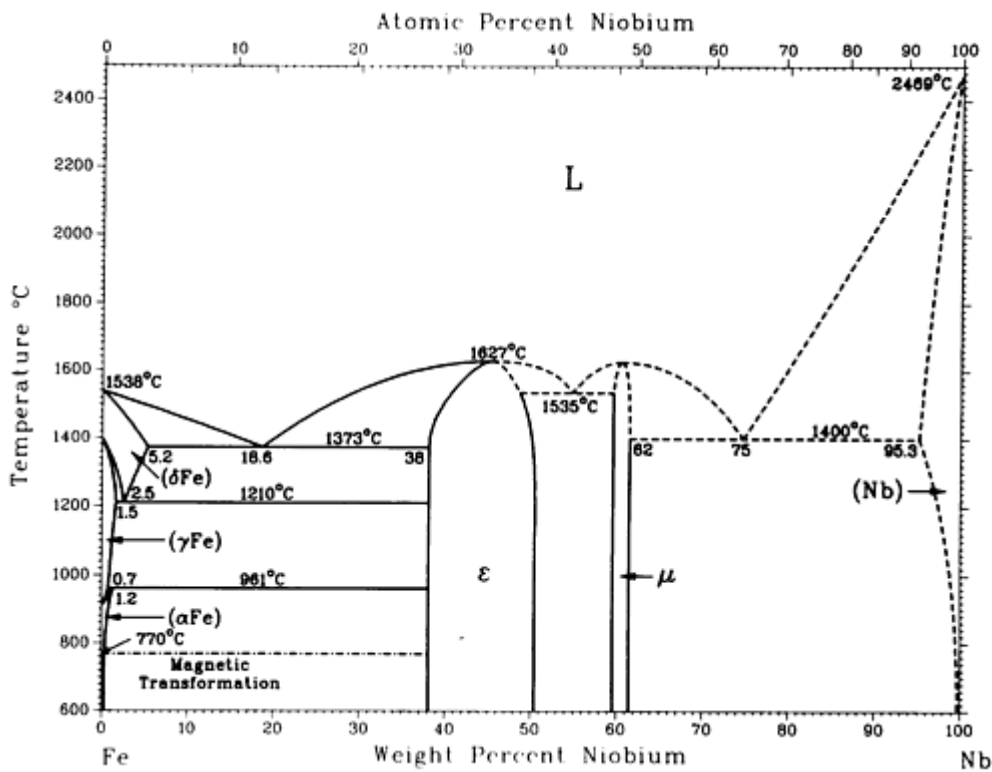

Fe-Nb phase diagram

Fe-Nb crystallographic data

Phase	Composition, wt% Nb	Pearson symbol	Space group
δ or (δ Fe)	0 to 5.2	<i>cI2</i>	$Im\bar{3}m$
γ or (γ Fe)	0 to 1.5	<i>cF4</i>	$Fm\bar{3}m$
α or (α Fe)	0 to 1.2	<i>cI2</i>	$Im\bar{3}m$
ϵ or Fe ₂ Nb	38 to 51	<i>hP12</i>	$P6_3/mmc$
μ or FeNb	60 to 62	<i>hR13</i>	$R\bar{3}m$
(Nb)	95.3 to 100	<i>cI2</i>	$Im\bar{3}m$

Fe-Nd (Iron - Neodymium)

W. Zhang, G. Liu, and K. Han, 1992

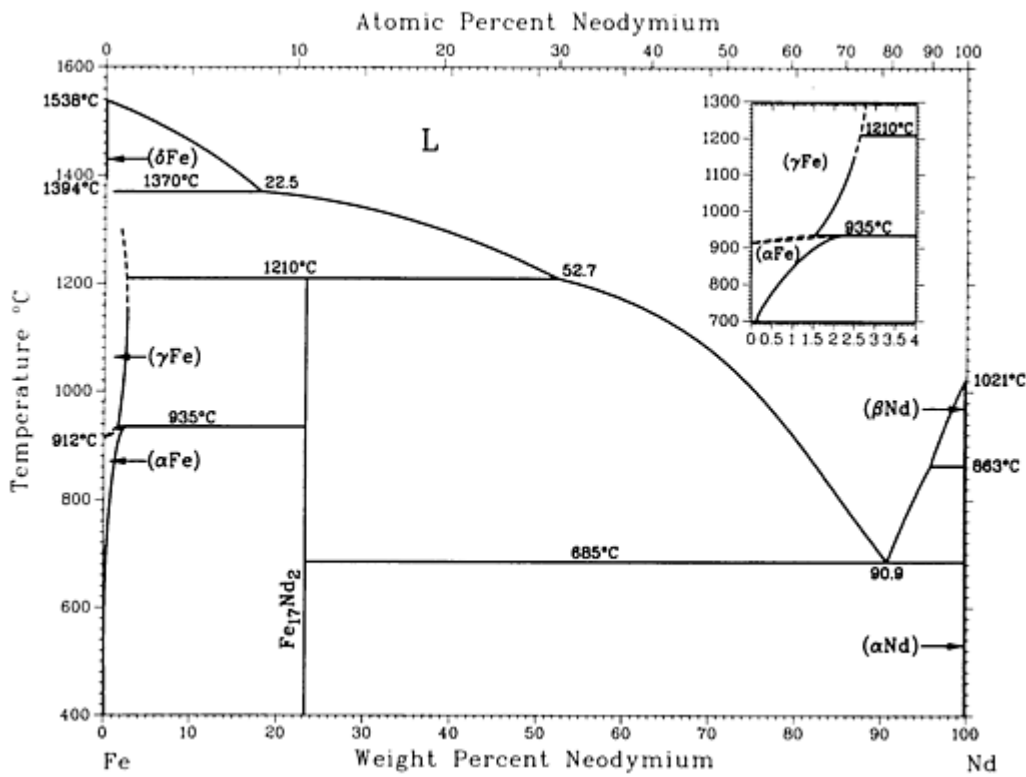

Fe-Nd phase diagram

Fe-Nd crystallographic data

Phase	Composition, wt% Nd	Pearson symbol	Space group
(δ Fe) ^(a)	0	<i>cI2</i>	<i>Im</i> $\bar{3}m$
(γ Fe) ^(b)	0 to \sim 1	<i>cF4</i>	<i>Fm</i> $\bar{3}m$
(α Fe) ^(c)	0 to \sim 1.1	<i>cI2</i>	<i>Im</i> $\bar{3}m$
Fe ₁₇ Nd ₂	23.3	^(d)	<i>R</i> $\bar{3}m$
(β Nd) ^(e)	100	<i>cI2</i>	<i>Im</i> $\bar{3}m$
(α Nd) ^(f)	100	<i>hP4</i>	<i>P6</i> ₃ / <i>mmc</i>
Metastable phase			
Fe _{5+x} Nd	...	<i>hP6</i>	<i>P6</i> / <i>mmm</i>

- (a) From 1538 to 1394 °C.
- (b) From <1394 to 912 °C.
- (c) Below 912 °C.
- (d) Rhombohedral.
- (e) From 1021 to 863 °C.
- (f) Below 863 °C

Fe-Ni (Iron - Nickel)

L.J. Swartzendruber, V.P. Itkin, and C.B. Alcock, 1992

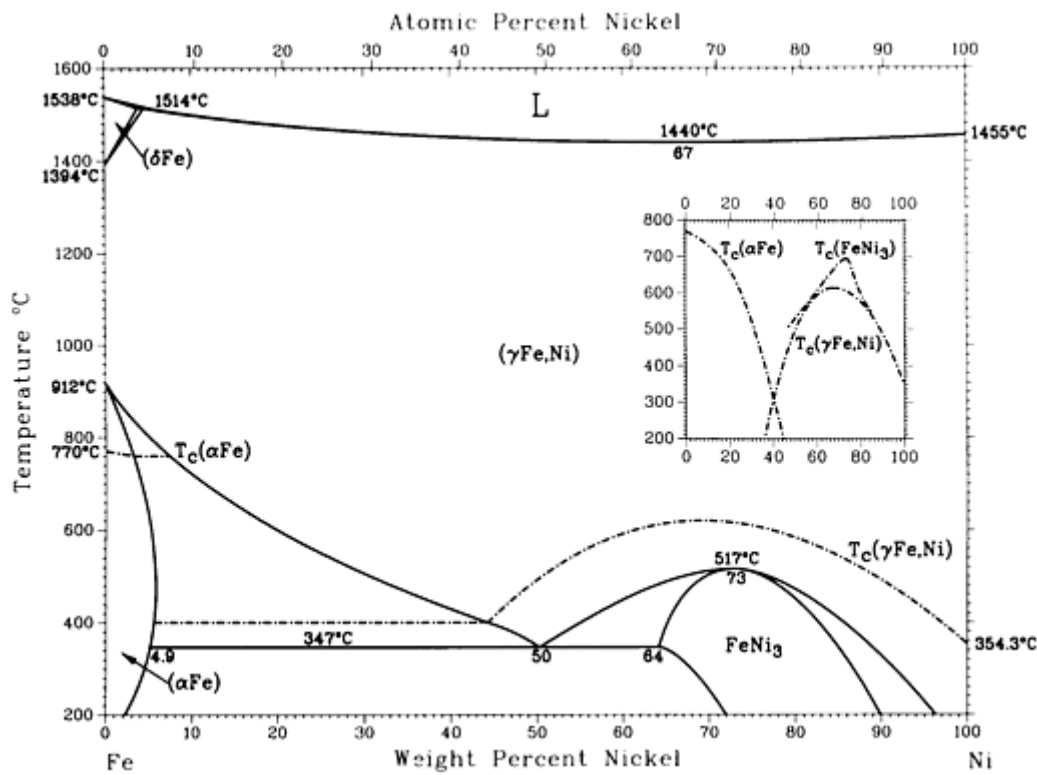

Fe-Ni phase diagram

Fe-Ni crystallographic data

Phase	Composition, wt% Ni	Pearson symbol	Space group
(δFe)	0 to 3.7	$cI2$	$Im\bar{3}m$
$(\gamma\text{Fe, Ni})$	0 to 100	$cF4$	$Fm\bar{3}m$
(αFe)	0 to 5.8	$cI2$	$Im\bar{3}m$
$\text{Fe}_3\text{Ni}^{(a)}$	26	$cP4$	$Pm\bar{3}m$
$\text{FeNi}^{(a)}$	51	$tP2$	$P4/mmm$
FeNi_3	64 to ~ 90	$cP4$	$Pm\bar{3}m$

(a) Metastable

Fe-O (Iron - Oxygen)

H.A. Wriedt, 1992

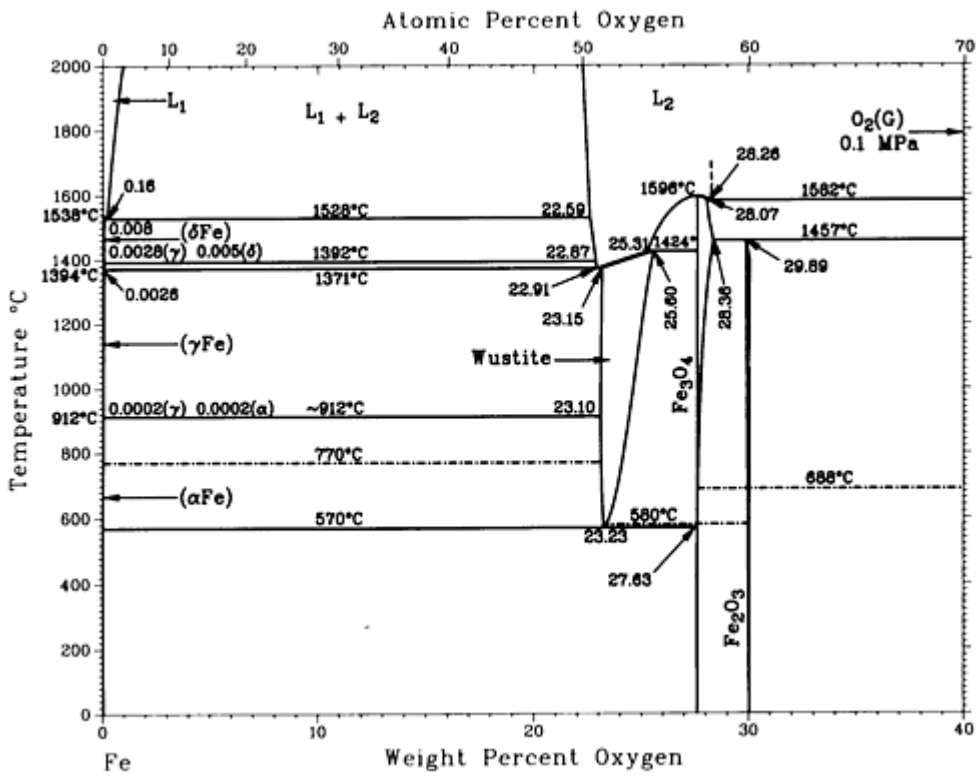

Fe-O phase diagram

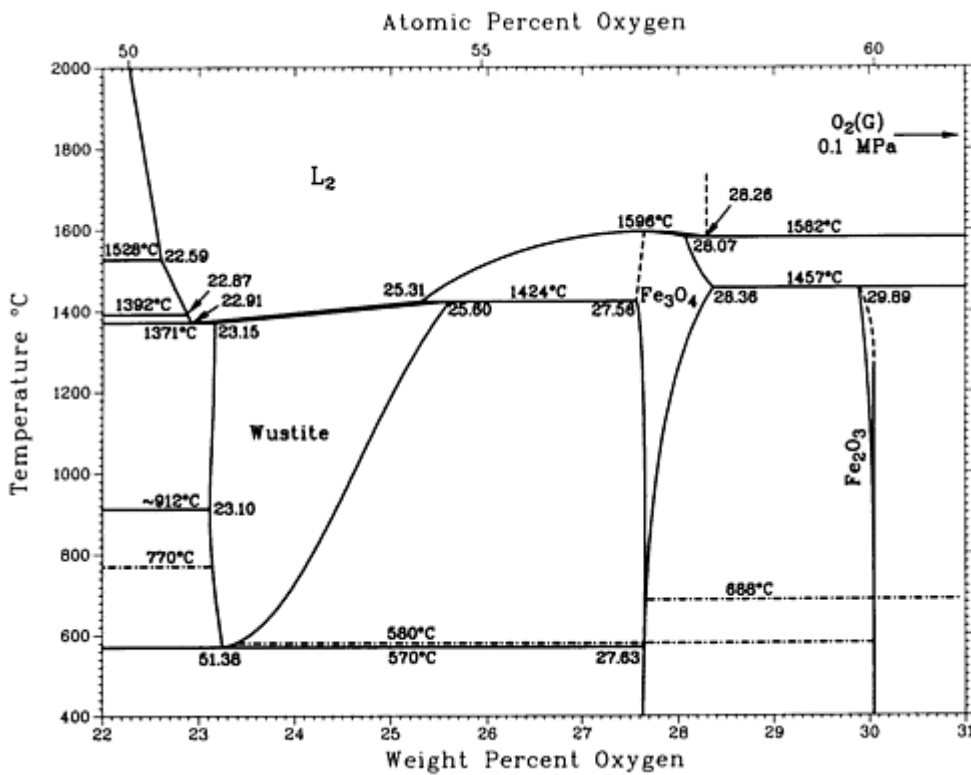

Fe-O phase diagram from 22 to 31 wt% O.

Fe-O crystallographic data

Phase	Composition, wt% O	Pearson symbol	Space group
Stable phases			
(δ Fe)	~ 0	<i>cI2</i>	<i>Im$\bar{3}m$</i>
(γ e)	~ 0	<i>cF4</i>	<i>Fm$\bar{3}m$</i>
(α Fe)	~ 0	<i>cI2</i>	<i>Im$\bar{3}m$</i>
Wustite	23.15 to 25.60	<i>cF8</i>	<i>Fm$\bar{3}m$</i>
Fe₃O₄(LT)	~ 27.6	<i>mC224</i>	<i>Cc</i>
Fe₃O₄	27.56 to 28.36	<i>cF56</i>	<i>Fd$\bar{3}m$</i>
αFe₂O₃	~ 30.1	<i>hR10</i>	<i>R$\bar{3}c$</i>
Other phases			
(ϵ Fe) ^(a)	0 to ?	<i>hP2</i>	<i>P6₃/mmc</i>
P'(wustite)	~ 23.2 to ~ 24.8	<i>c**(?)^(b)</i>	...
P''(wustite)	~ 24 to ~ 25	<i>mP500(?)</i>	<i>P2₁/m</i>
P'''(wustite)
Wustite(LT)	23.2 to 24.6	<i>hR2^(c)</i>	<i>R$\bar{3}$</i>
Fe₃O₄(P)^(d)	~ 27.6	<i>m*14</i>	...
βFe₂O₃	~ 30.1	<i>cI80</i>	<i>Ia$\bar{3}$</i>
γFe₂O₃	~ 30.1	<i>tP60</i>	<i>P4₃2₁2</i>
ϵFe₂O₃	~ 30.1	<i>m*100</i>	...

- (a) Stable at pressures >13 GPa.
- (b) Incommensurate or orthorhombic.
- (c) Magnetic reflections might indicate linear cell dimensions are doubled, corresponding to $hR16$.
- (d) Stable at pressures >25 GPa.

Fe-P (Iron - Phosphorus)

H. Okamoto, 1992

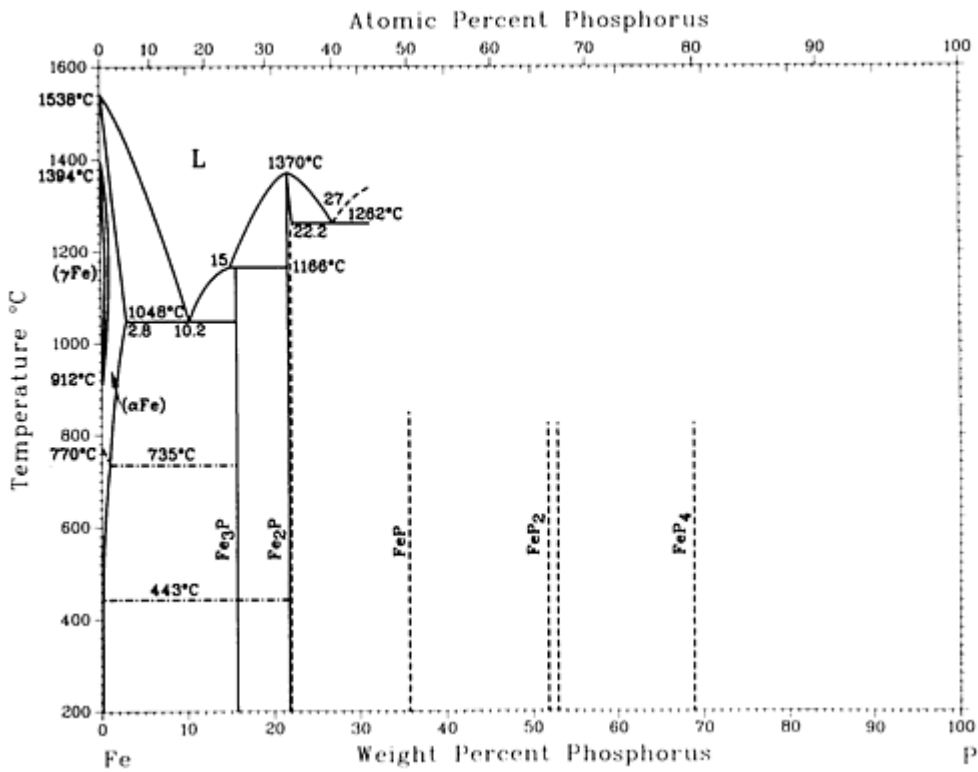

Fe-P phase diagram

Fe-P crystallographic data

Phase	Composition, wt% P	Pearson symbol	Space group
γ Fe	0 to 0.31	$cF4$	$Fm\bar{3}m$

(αFe)	0 to 2.8	<i>cI2</i>	<i>Im$\bar{3}m$</i>
Fe₃P	16	<i>tI32</i>	<i>I4</i>
Fe₂P	21.7 to 22.2	<i>hP9</i>	<i>P$\bar{6}2m$</i>
FeP	36	<i>oP8</i>	<i>Pna2₁</i>
FeP₂	52 to 53	<i>oP6</i>	<i>Pnm</i>
FeP₄	69	<i>mP30</i>	<i>P2₁/c</i>
(P) (white)	100	<i>c**</i>	...
Metastable phases			
Fe₄P	<12	<i>o**</i>	...
(P) black	100	<i>oC8</i>	<i>Cmca</i>
High-pressure phases			
Fe₂P	21.7	<i>oP12</i>	<i>Pnma</i>
FeP₄	69	<i>oC20</i>	<i>C222₁</i>

Fe-Pd (Iron - Palladium)

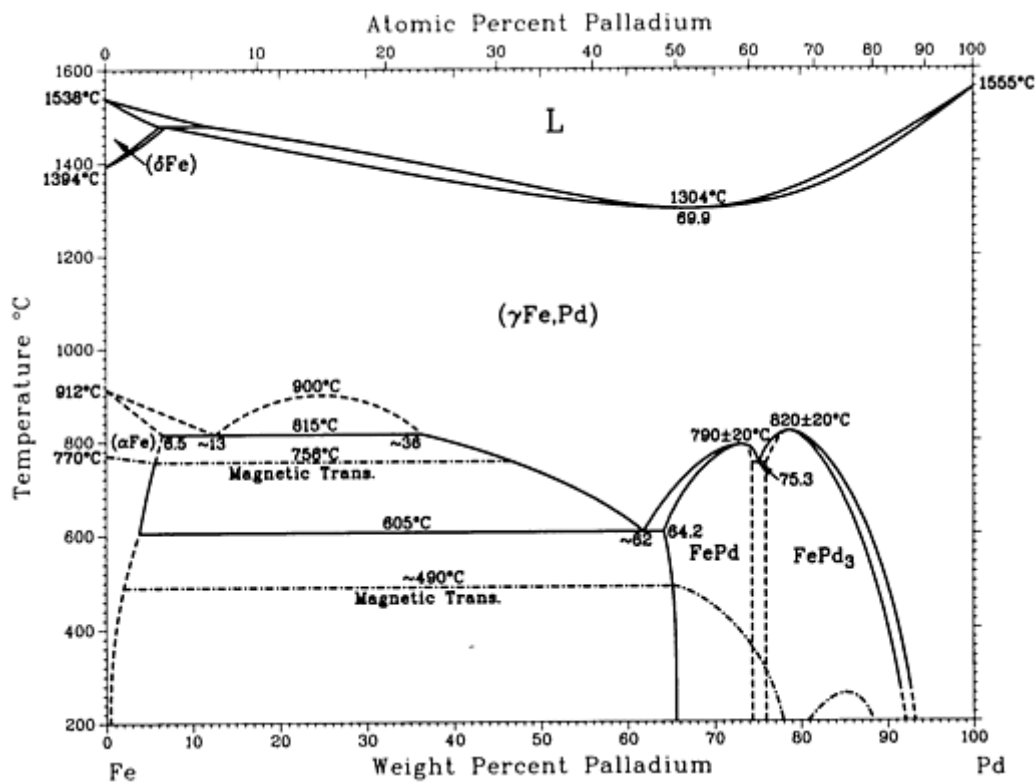

Fe-Pd phase diagram

Fe-Pd crystallographic data

Phase	Composition, wt% Pd	Pearson symbol	Space group
(δFe)	0 to 6.1	<i>cI2</i>	<i>Im</i> $\bar{3}m$
(γFe, Pd)	0 to 100	<i>cF4</i>	<i>Fm</i> $\bar{3}m$
(αFe)	0 to 6.5	<i>cI2</i>	<i>Im</i> $\bar{3}m$
FePd	64.2 to 74	<i>tP2</i>	<i>P4/mmm</i>
FePd ₃	76 to ?	<i>cP4</i>	<i>Pm</i> $\bar{3}m$

Fe-Pu (Iron - Plutonium)

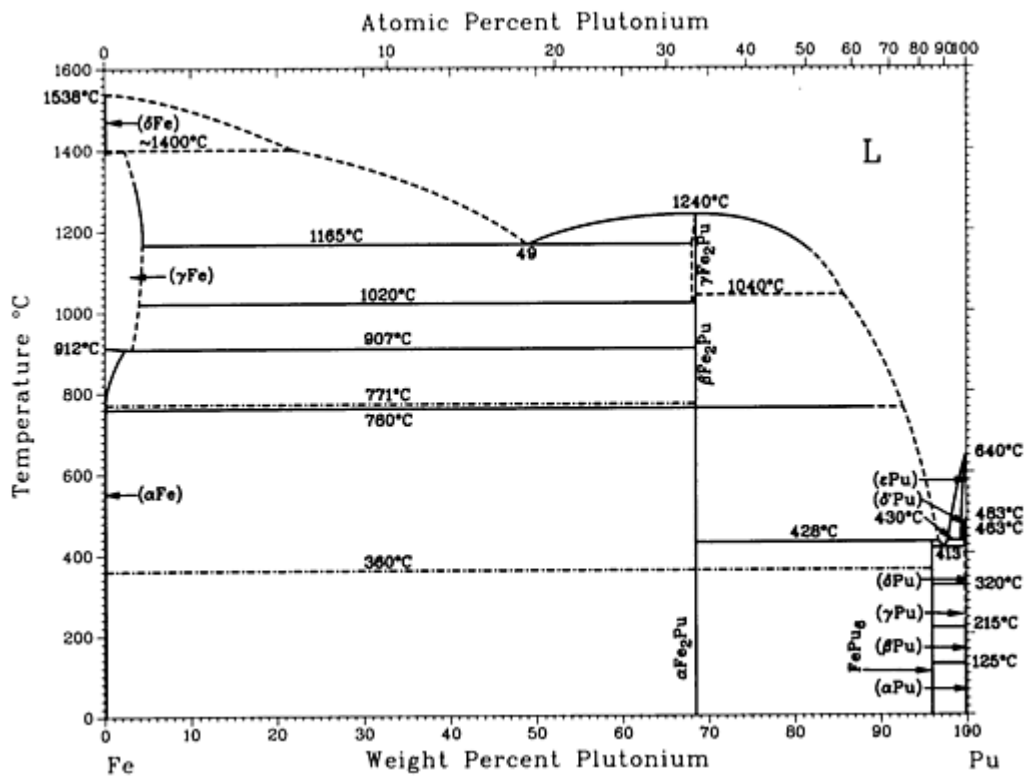

Fe-Pu phase diagram

Fe-Pu crystallographic data

Phase	Composition, wt% Pu	Pearson symbol	Space group
(δFe)	0	$cI2$	$Im\bar{3}m$
(γFe)	0 to ~ 4	$cF4$	$Fm\bar{3}m$
(αFe)	0	$cI2$	$Im\bar{3}m$
$\gamma\text{Fe}_2\text{Pu}$	68.6	c^{**}	...
$\beta\text{Fe}_2\text{Pu}$	68.6	$hP24$	$P6_3/mmc$
$\alpha\text{Fe}_2\text{Pu}$	68.6	$cF24$	$Fd\bar{3}m$
FePu_6	96.3	$tI28$	$I4/mcm$
(ϵPu)	99.5 to 100	$cI2$	$Im\bar{3}m$

$(\delta'Pu)$	~ 100	$tI2$	$I4/mmm$
(δPu)	99.9 to 100	$cF4$	$Fm\bar{3}m$
(γPu)	100	$oF8$	$Fddd$
(βPu)	100	$mC34$	$C2/m$
(αPu)	100	$mP16$	$P2_1/m$

Fe-Rh (Iron - Rhodium)

L.J. Swartzendruber, 1992

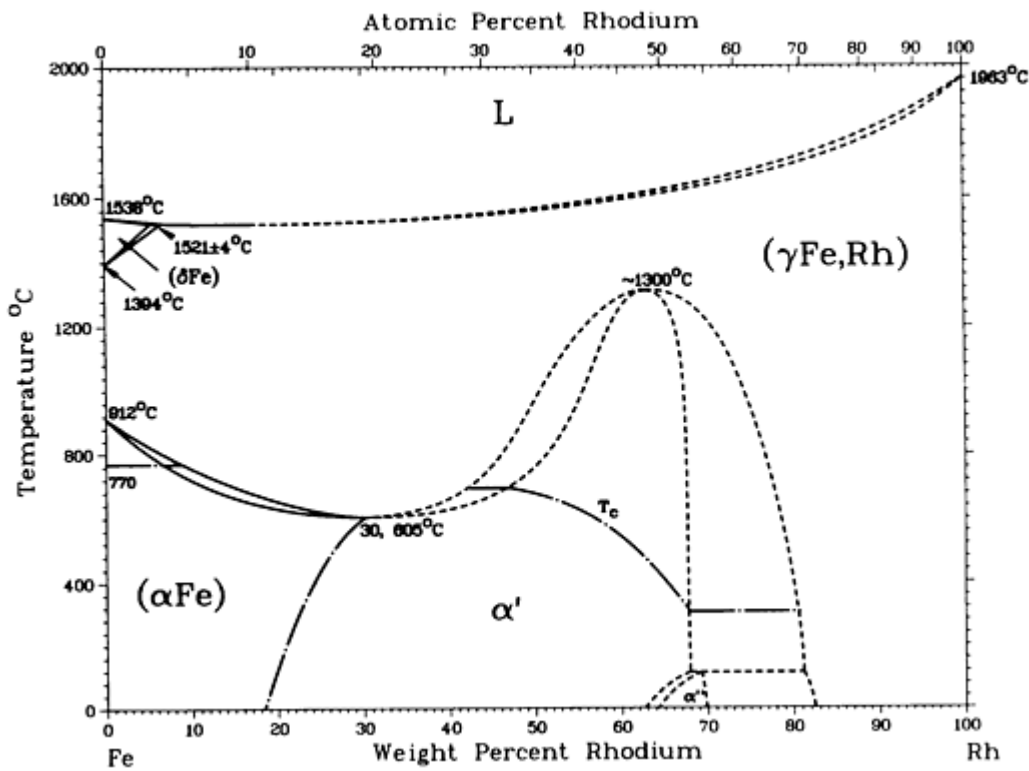

Fe-Rh phase diagram

Fe-Rh crystallographic data

Phase	Composition, wt% Rh	Pearson symbol	Space group
(δFe)	0 to 5	$cI2$	$Im\bar{3}m$

$(\gamma\text{Fe,Rh})$	0 to 100	$cF4$	$Fm\bar{3}m$
(αFe)	0 to 30	$cI2$	$Im\bar{3}m$
α'	19 to 69	$cP2$	$Pm\bar{3}m$
α'' (chemical cell)	63 to 69	$cP2$	$Pm\bar{3}m$
α'' (magnetic cell)	63 to 69	$cF16$	$Fm\bar{3}m$

Fe-S (Iron - Sulfur)

From [Kubaschewski] 9

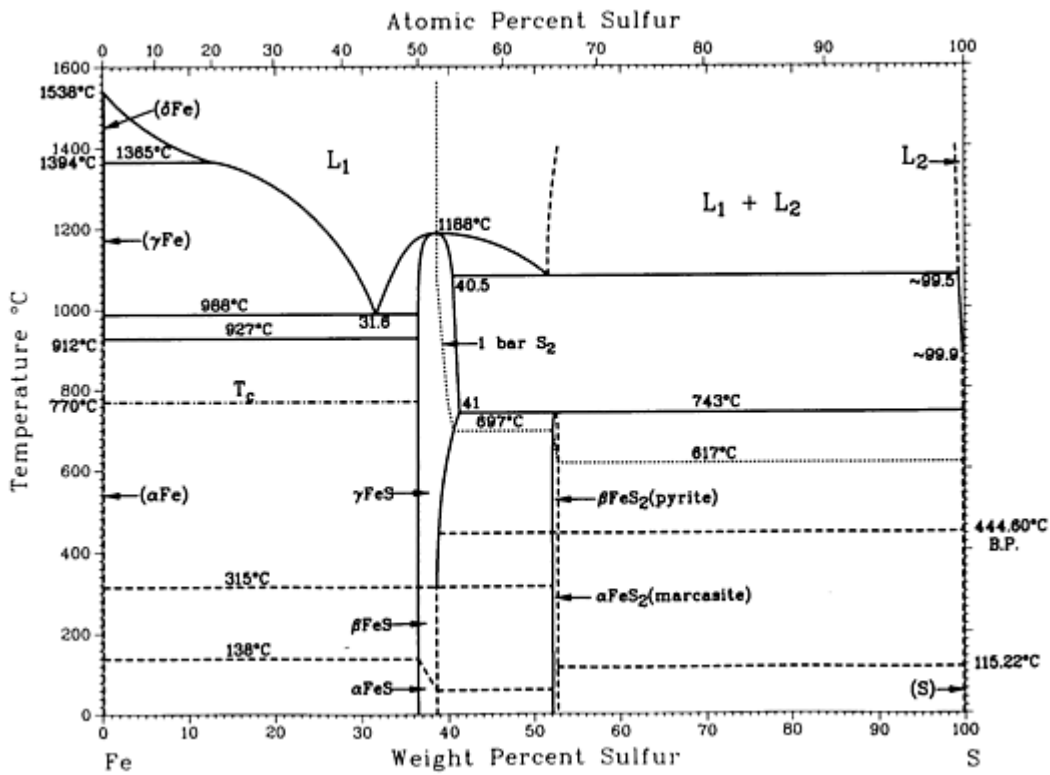

Fe-S phase diagram

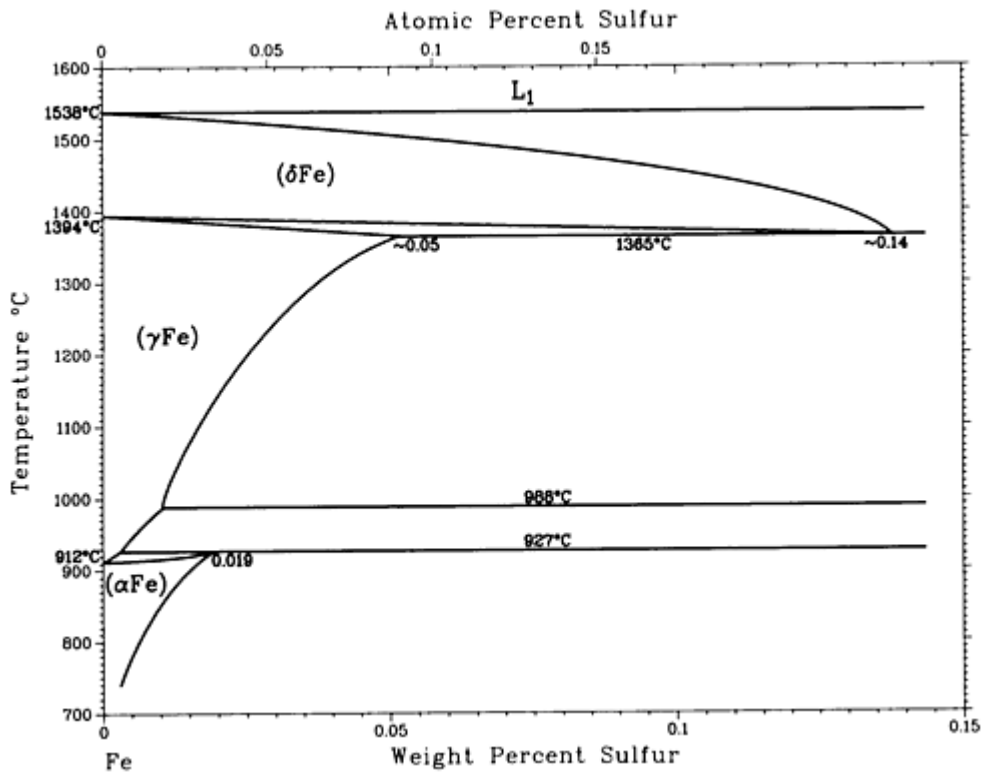

Fe-rich region of the Fe-S system.

Fe-S crystallographic data

Phase	Composition, wt% S	Pearson symbol	Space group
(δ Fe)	0 to \sim 0.14	<i>cI2</i>	$Im\bar{3}m$
(γ Fe)	0 to \sim 0.05	<i>cF4</i>	$Fm\bar{3}m$
(α Fe)	0 to 0.019	<i>cI2</i>	$Im\bar{3}m$
γ_{FeS}	36.5 to 41	<i>hP4</i>	$P6_3/mmc$
β_{FeS}	36.5 to \sim 38	<i>hP24</i>	$P\bar{6}2c$
α_{FeS}	36.5 to \sim 38
β_{FeS_2}	\sim 53.5	<i>cP12</i>	$Pa3$
α_{FeS_2}	\sim 53.5	<i>oP6</i>	$Pnmm$

Reference cited in this section

9. [Kubaschewski]: O. Kubaschewski, *Iron--Binary Phase Diagrams*, Springer-Verlag, New York (1982).

Fe-Sb (Iron - Antimony)

H. Okamoto, 1992

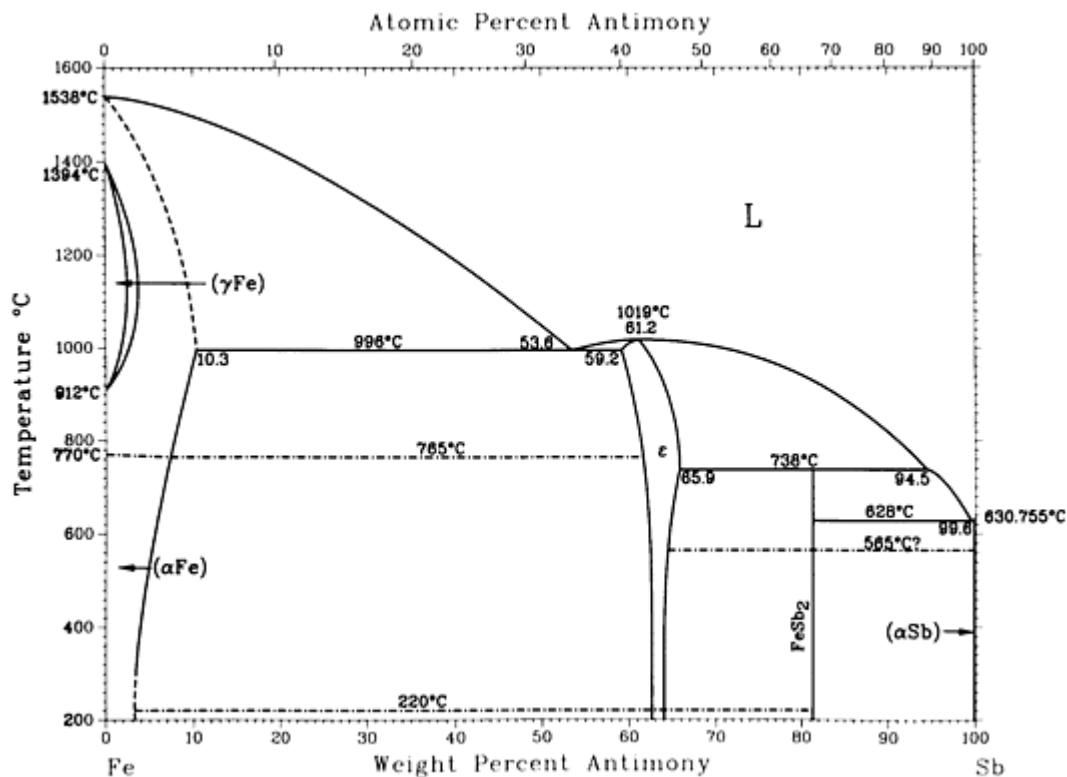

Fe-Sb phase diagram

Fe-Sb crystallographic data

Phase	Composition, wt% Sb	Pearson symbol	Space group
(αFe)	0 to 10.3	<i>cI2</i>	$Im\bar{3}m$
(γFe)	0 to 2.4	<i>cF4</i>	$Fm\bar{3}m$
ϵ	59.2 to 65.9	<i>hP4</i>	$P6_3/mmc$
FeSb ₂	81.4	<i>oP6</i>	$Pnn2$
(αSb)	100	<i>hR2</i>	$R\bar{3}m$

Metastable phase			
FeSb_4	90	$cP1$	$Pm\bar{3}m$

Fe-Sc (Iron - Scandium)

H. Okamoto, 1992

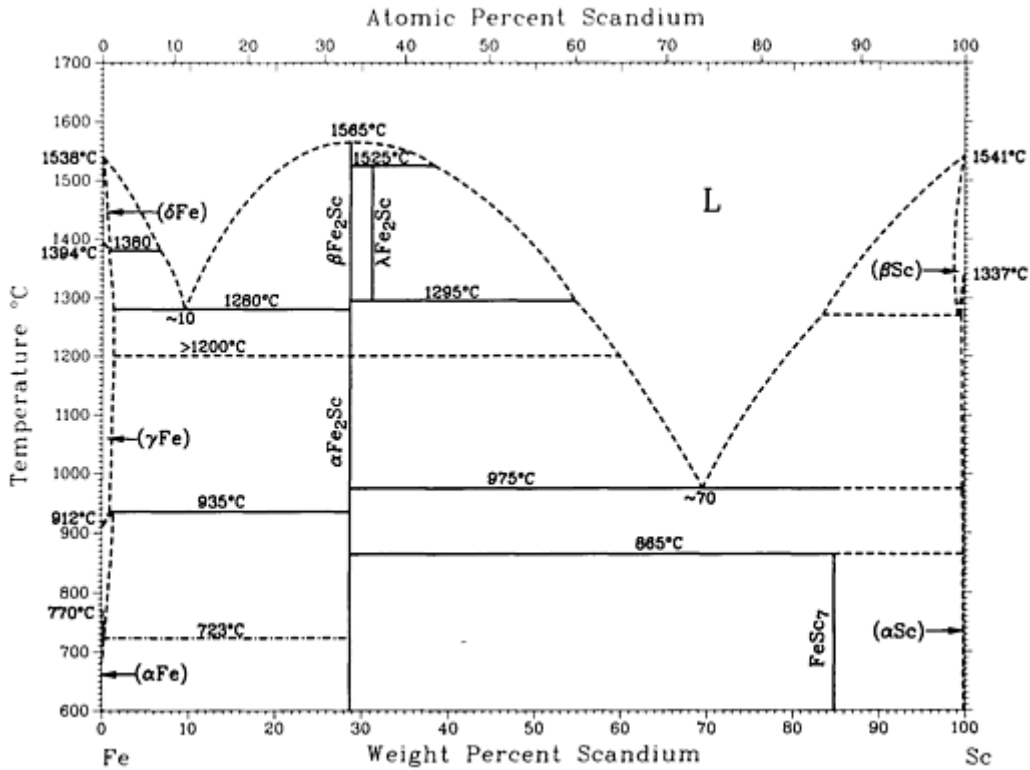

Fe-Sc phase diagram

Fe-Sc crystallographic data

Phase	Composition, wt% Sc	Pearson symbol	Space group
(δFe)	~ 0	$cI2$	$Im\bar{3}m$
(γFe)	~ 0	$cF4$	$Fm\bar{3}m$
(αFe)	~ 0	$cI2$	$Im\bar{3}m$
$\beta\text{-Fe}_2\text{Sc}$	28.7	$hP24$	$P6_3/mmc$

$\alpha\text{Fe}_2\text{Sc}$	28.7	<i>hP</i> 12	<i>P</i> 6 ₃ / <i>mmc</i>
$\lambda\text{Fe}_2\text{Sc}$	~31	<i>cF</i> 24	<i>Fd</i> $\bar{3}m$
FeSc_7	84.9
(βSc)	~100	<i>cI</i> 2	<i>Im</i> $\bar{3}m$
(αSc)	~100	<i>hP</i> 2	<i>P</i> 6 ₃ / <i>mmc</i>

Fe-Se (Iron - Selenium)

H. Okamoto, 1992

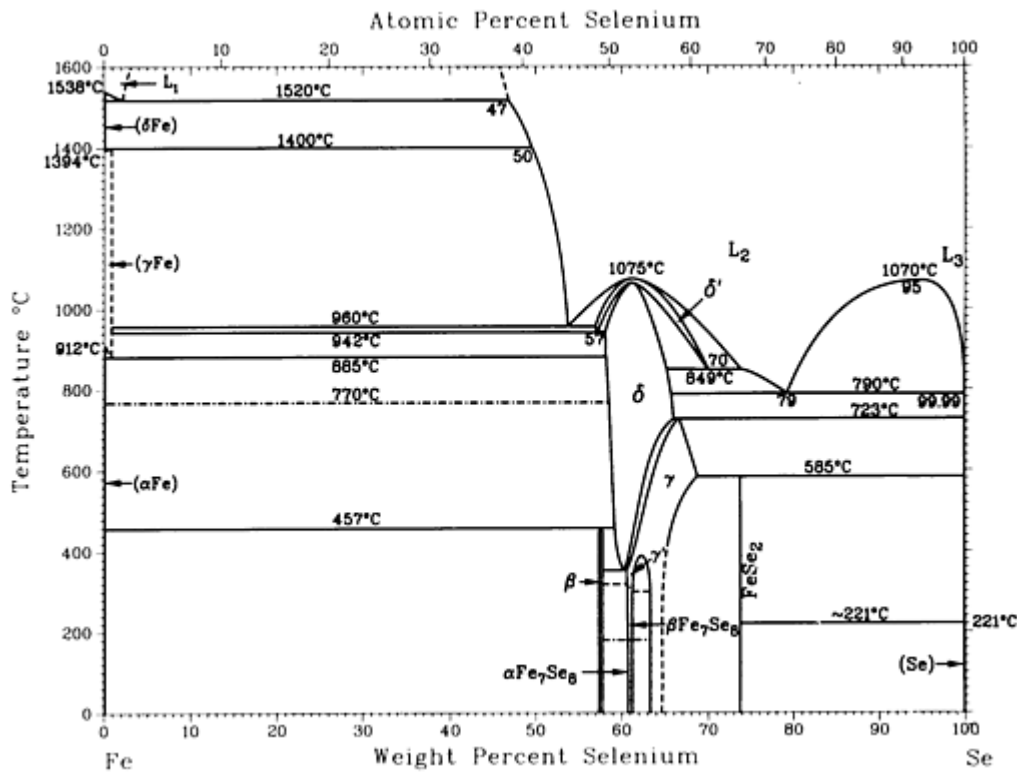

Fe-Se phase diagram

Fe-Se crystallographic data

Phase	Composition, wt% Se	Pearson symbol	Space group
(δFe)	~0	<i>cI</i> 2	<i>Im</i> $\bar{3}m$

(γFe)	~ 0	$cF4$	$Fm\bar{3}m$
(αFe)	~ 0	$cI2$	$Im\bar{3}m$
β	57.6 to 58.0	$tP4$	$P4/nmm$
δ'	57 to 70
δ	58.1 to 66	$hP4$	$P6_3/mmc$
γ'	?	$mC7$	$C2/m$
γ	? to 69	$mC14$	$C2/m$
$\beta_{\text{Fe}_7\text{Se}_8}$	61.7	$hP45$	$P3_121$
$\alpha_{\text{Fe}_7\text{Se}_8}$	61.7	$aP120$...
FeSe_2	73.9	$oP6$	$Pnmm$
(γSe)	100	$hP3$	$P3_121$
Metastable phases			
FeSe	58.6	c^{**}	...
FeSe	58.6	$hP4$	$P6_3/mmc$
FeSe	58.6	$tP2$	$P4/mmm$
High-pressure phase			
FeSe_2	73.9	$cP12$	$Pa3$

Fe-Si (Iron - Silicon)

From [Kubaschewski] 9

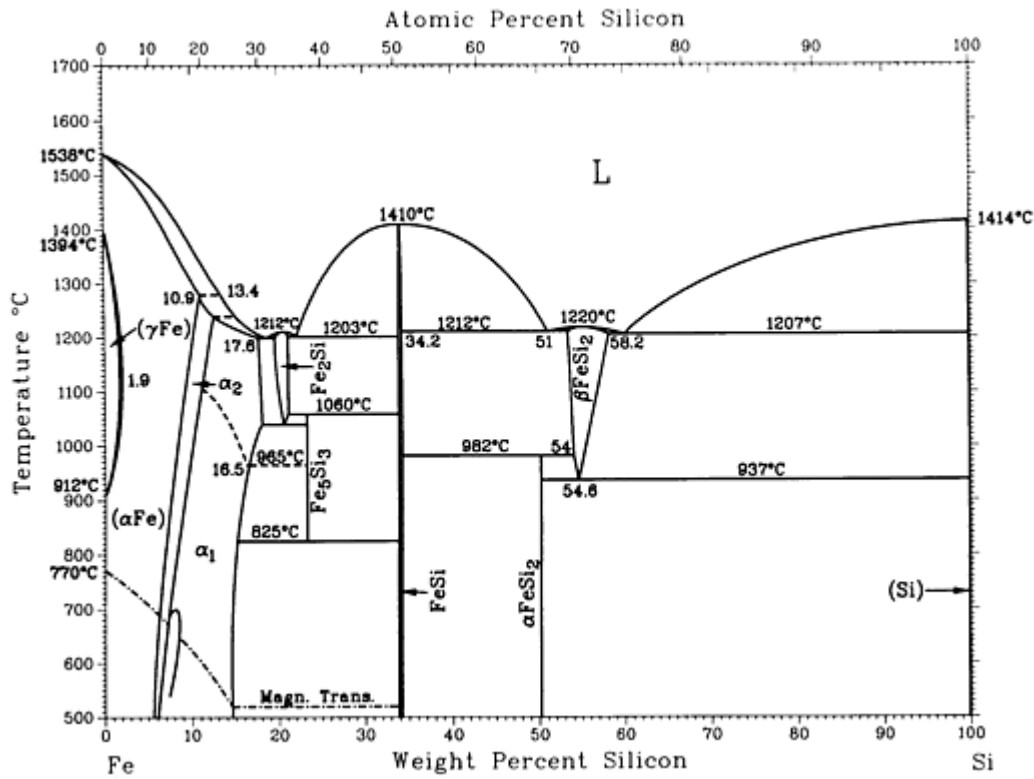

Fe-Si phase diagram

Fe-Si crystallographic data

Phase	Composition, wt% Si	Pearson symbol	Space group
(γFe)	0 to 10.9	<i>cF4</i>	<i>Fm</i> $\bar{3}m$
(αFe)	0 to 1.63	<i>cI2</i>	<i>Im</i> $\bar{3}m$
α ₂	~5 to 12	<i>cP2</i>	<i>Pm</i> $\bar{3}m$
α ₁	~5 to 18	<i>cF16</i>	<i>Fm</i> $\bar{3}m$
Fe ₂ Si	~20.1	<i>hP6</i>	<i>P</i> $\bar{3}m1$
Fe ₅ Si ₃	23.2	<i>hP16</i>	<i>P</i> _{6₃} / <i>mcm</i>
FeSi	~34	<i>cP8</i>	<i>P</i> _{2,3}

β FeSi ₂	53.4 to 58.2	<i>tP3</i>	<i>P4/mmm</i>
α FeSi ₂	50.2	<i>oC48</i>	<i>Cmca</i>
(Si)	100	<i>cF8</i>	<i>Fd$\bar{3}m$</i>

Reference cited in this section

9. [Kubaschewski]: O. Kubaschewski, *Iron--Binary Phase Diagrams*, Springer-Verlag, New York (1982).

Fe-Sm (Iron - Samarium)

H. Okamoto, 1992

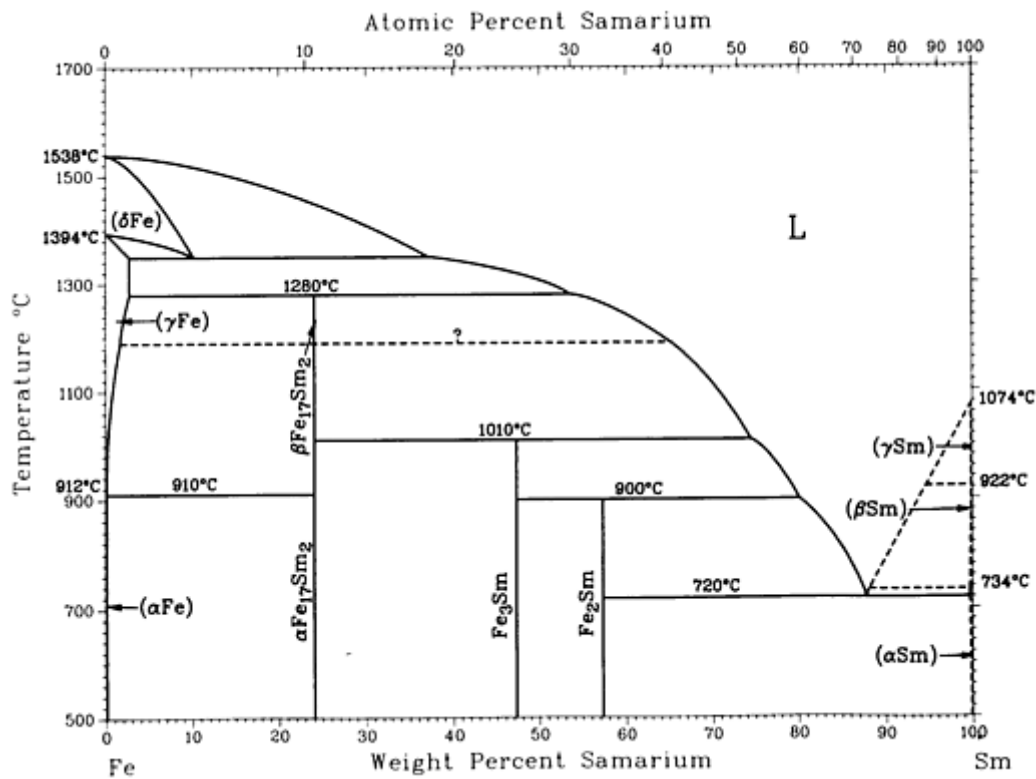

Fe-Sm phase diagram

Fe-Sm crystallographic data

Phase	Composition, wt% Sm	Pearson symbol	Space group
(δ Fe)	~0	<i>cI2</i>	<i>Im$\bar{3}m$</i>

(γFe)	~ 0	$cF4$	$Fm\bar{3}m$
(αFe)	0	$cI2$	$Im\bar{3}m$
$\beta\text{Fe}_{17}\text{Sm}_2$	24.0	$hP38$	$P6_3/mmc$
$\alpha\text{Fe}_{17}\text{Sm}_2$	24.0	$hR19$	$R\bar{3}m$
Fe_3Sm	47	$hR12$	$R\bar{3}m$
Fe_2Sm	57.3	$cF24$	$Fd\bar{3}m$
(γSm)	100	$cI2$	$Im\bar{3}m$
(βSm)	~ 100	$hP2$	$P6_3/mmc$
(αSm)	>99.8 to 100	$hR3$	$R\bar{3}m$
Questionable phase			
Fe_5Sm	35.1	$hP6$	$P6/mmm$

Fe-Sn (Iron - Tin)

H. Okamoto, 1992

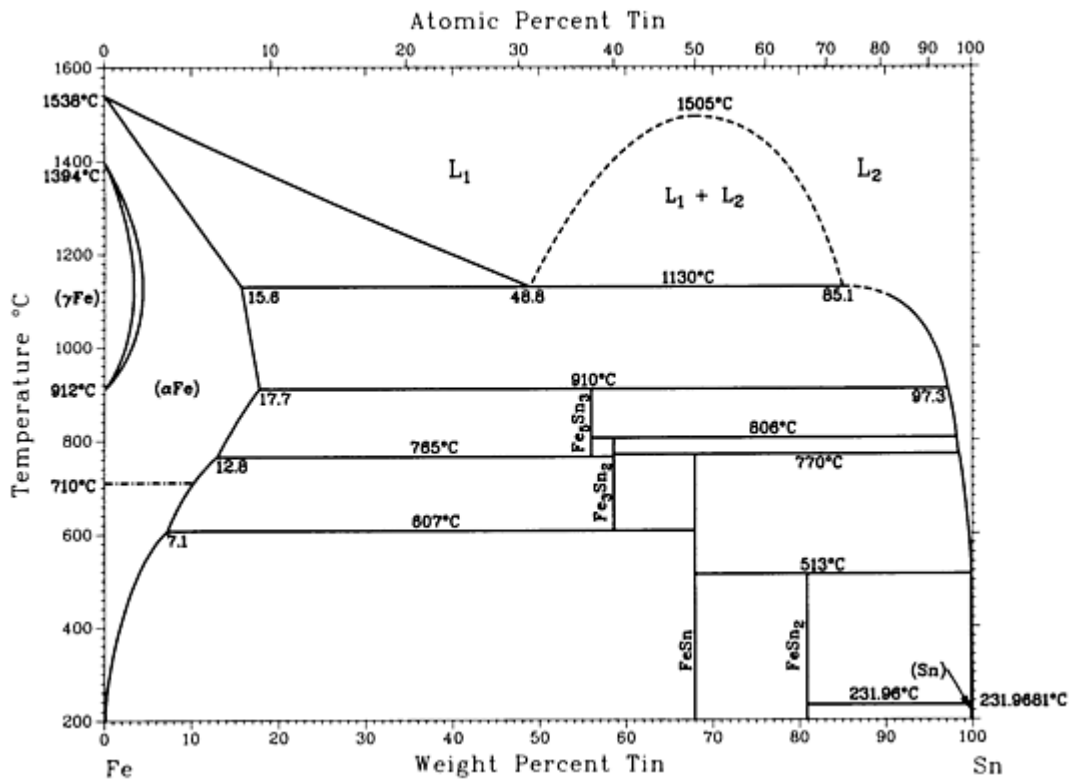

Fe-Sn phase diagram

Fe-Sn crystallographic data

Phase	Composition, wt% Sn	Pearson symbol	Space group
(γ Fe)	0 to 1.7	<i>cF4</i>	<i>Fm</i> $\bar{3}m$
(α Fe)	0 to 17.7	<i>cI2</i>	<i>Im</i> $\bar{3}m$
Fe ₅ Sn ₃	56.1	<i>hP6</i>	<i>P6</i> ₃ / <i>mmc</i>
Fe ₃ Sn ₂	59	<i>hR10</i>	<i>R</i> $\bar{3}m$
FeSn	68.0	<i>hP6</i>	<i>P6</i> / <i>mmm</i>
FeSn ₂	81.0	<i>tI2</i>	<i>I4</i> / <i>mcm</i>
(β Sn)	100	<i>tI4</i>	<i>I4</i> ₁ / <i>amd</i>

(α Sn)	100	<i>cF8</i>	<i>Fm$\bar{3}m$</i>
Oxygen stabilized phase			
"Fe ₃ Sn"	42	<i>hP8</i>	<i>P6₃/mmc</i>

Fe-Tb (Iron - Terbium)

H. Okamoto, 1992

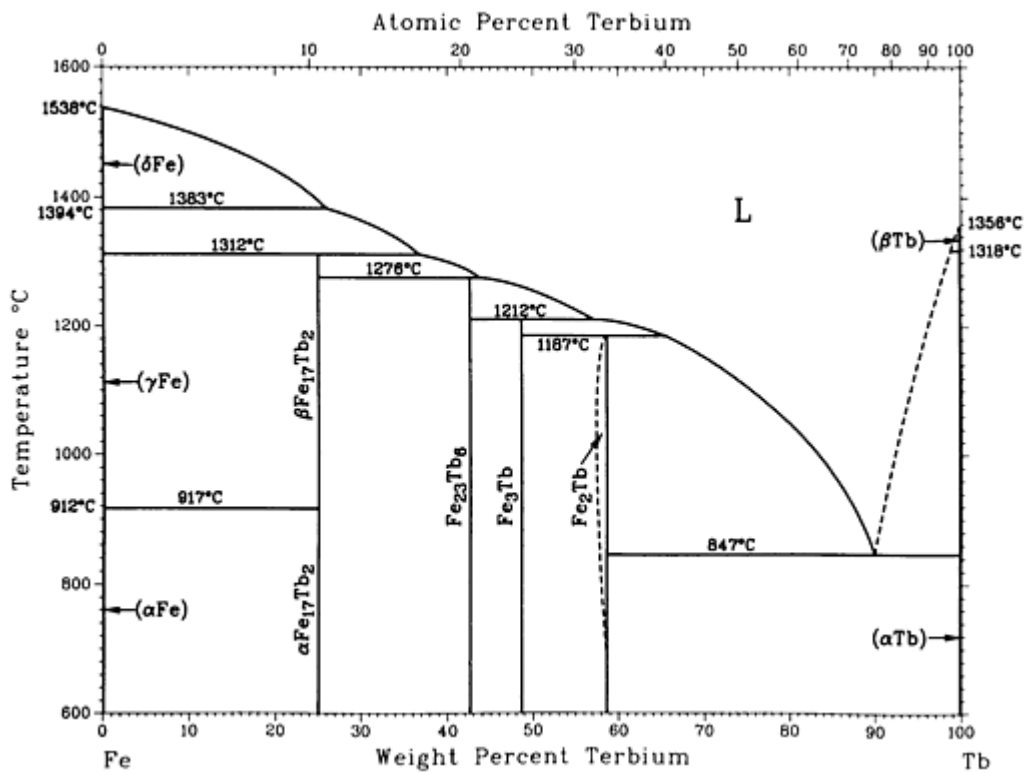

Fe-Tb phase diagram

Fe-Tb crystallographic data

Phase	Composition, wt% Tb	Pearson symbol	Space group
(δ Fe)	0	<i>cI2</i>	<i>Im$\bar{3}m$</i>
(γ Fe)	~ 0	<i>cF4</i>	<i>Fm$\bar{3}m$</i>
(α Fe)	0	<i>cI2</i>	<i>Im$\bar{3}m$</i>

β Fe ₁₇ Tb ₂	25.0	<i>hP38</i>	<i>P6₃/mmc</i>
α Fe ₁₇ Tb ₂	25.0	<i>hR19</i>	<i>R$\bar{3}$_m</i>
Fe ₂₃ Tb ₆	42.6	<i>cF116</i>	<i>Fm$\bar{3}$_m</i>
Fe ₃ Tb	49	<i>hR12</i>	<i>R$\bar{3}$_m</i>
Fe ₂ Tb	58.7	<i>cF24</i>	<i>Fd$\bar{3}$_m</i>
Fe ₂ Tb ^(a)	58.7	<i>hR6</i>	<i>R$\bar{3}$_m</i>
(β -Tb)	100	<i>cI2</i>	<i>Im$\bar{3}$_m</i>
(α -Tb)	100	<i>hP2</i>	<i>P6₃/mmc</i>

(a) Distorted Cu₂Mg type due to magnetostriction at low temperatures

Fe-Te (Iron - Tellurium)

H. Okamoto and L.E. Tanner, 1992

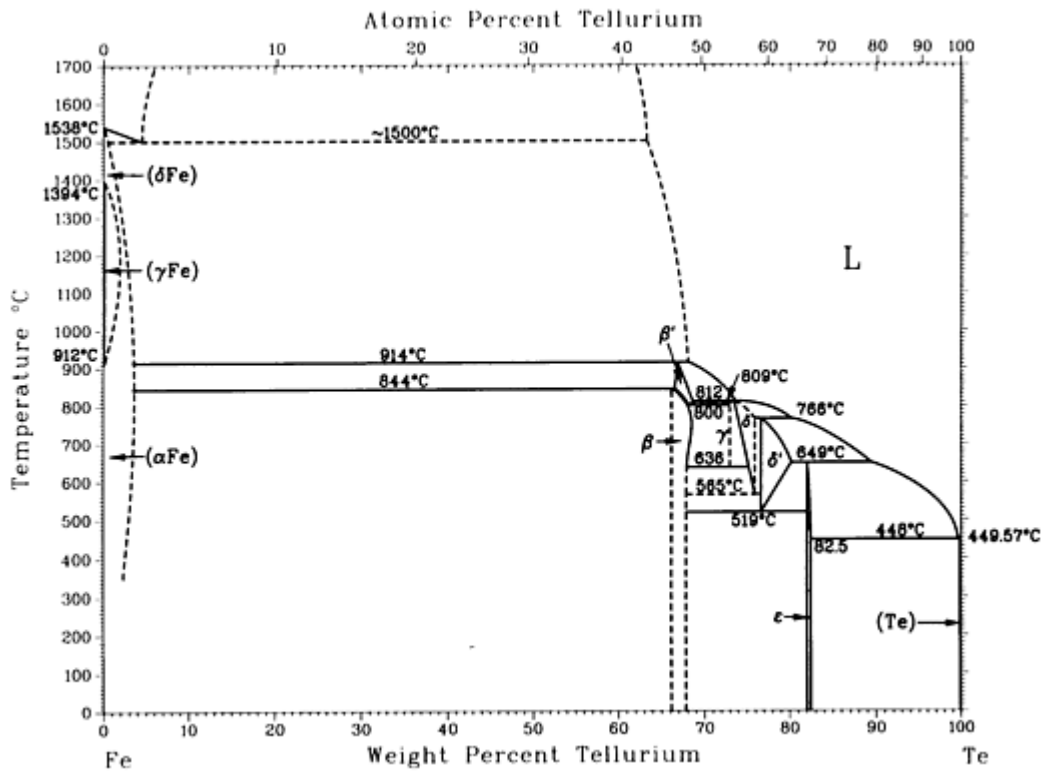

Fe-Te phase diagram

Fe-Te crystallographic data

Phase	Composition, wt% Te	Pearson symbol	Space group
(δFe, αFe)	0 to 3.4	<i>cI2</i>	<i>Im</i> $\bar{3}m$
(γFe)	~0	<i>cF4</i>	<i>Fm</i> $\bar{3}m$
β ₁	66.5 to 68.3	<i>hR*</i>	...
β	66 to 68.3	<i>tP4</i> <i>tP6</i>	<i>P4/nmm</i> <i>P4/nmm</i>
β _{1(a)}	66 to 68	<i>mP*</i>	<i>P2₁/m</i>
γ	73.0

δ	74 to 77	<i>mC14</i>	<i>C2/m</i>
δ'	76.9 to 80.6	<i>hP4</i>	<i>P6₃/mmc</i>
ϵ	82.0 to 82.5	<i>oP6</i>	<i>Pnn2</i>
FeTe₂I^(b)	82.1	<i>cP12</i>	<i>Pa$\bar{3}$</i>
(Te)	100	<i>hP3</i>	<i>P3₁21</i>

(a) Low-temperature phase.

(b) High-pressure phase

Fe-Th (Iron - Thorium)

H. Okamoto, 1992

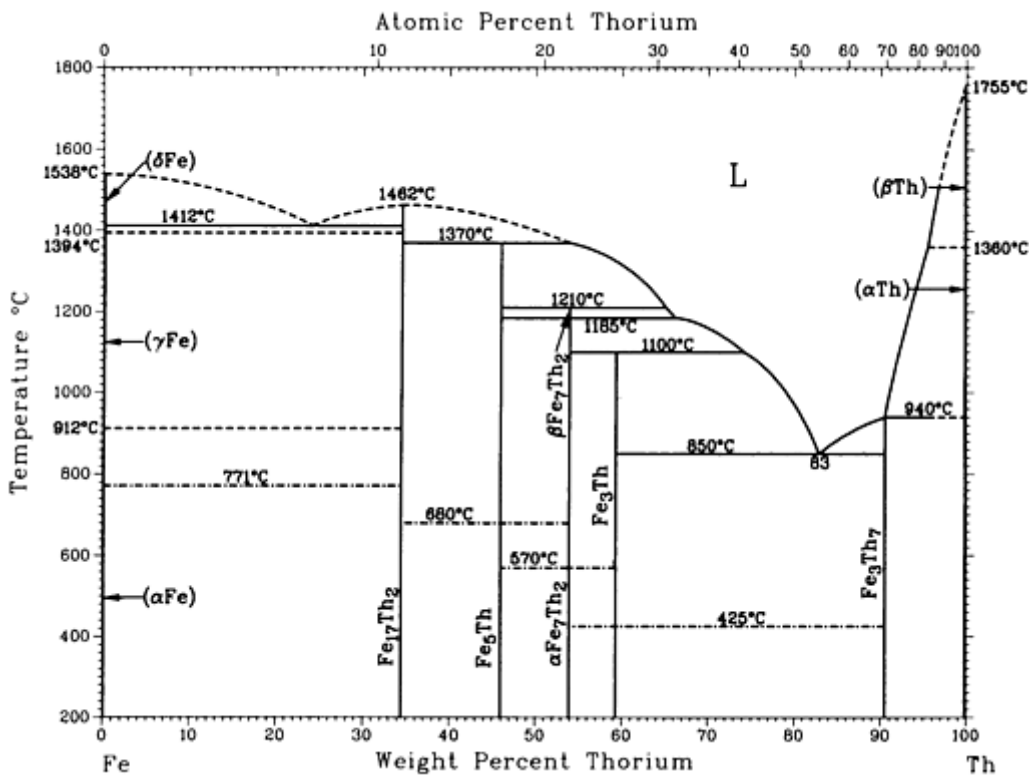

Fe-Th phase diagram

Fe-Th crystallographic data

Phase	Composition, wt% Th	Pearson symbol	Space group
(δFe)	0	<i>cI2</i>	<i>Im</i> $\bar{3}m$
(γFe)	0	<i>cF4</i>	<i>Fm</i> $\bar{3}m$
(αFe)	0	<i>cI2</i>	<i>Im</i> $\bar{3}m$
$\text{Fe}_{17}\text{Th}_2$	32.8	<i>hR19</i>	<i>R</i> $\bar{3}m$
Fe_5Th	45.4	<i>hP6</i>	<i>P6/mmm</i>
$\beta\text{Fe}_7\text{Th}_2$	54.2	<i>hR18</i>	<i>R</i> $\bar{3}m$
$\alpha\text{Fe}_7\text{Th}_2$	54.2	<i>hP36</i>	<i>P6_3/mmc</i>
Fe_3Th	58	<i>hR12</i>	<i>R</i> $\bar{3}m$
Fe_3Th_7	91	<i>hP20</i>	<i>P6_3mc</i>
(βTh)	100	<i>cI2</i>	<i>Im</i> $\bar{3}m$
(αTh)	100	<i>cF4</i>	<i>Fm</i> $\bar{3}m$

Fe-Ti (Iron - Titanium)

J.L. Murray, 1992

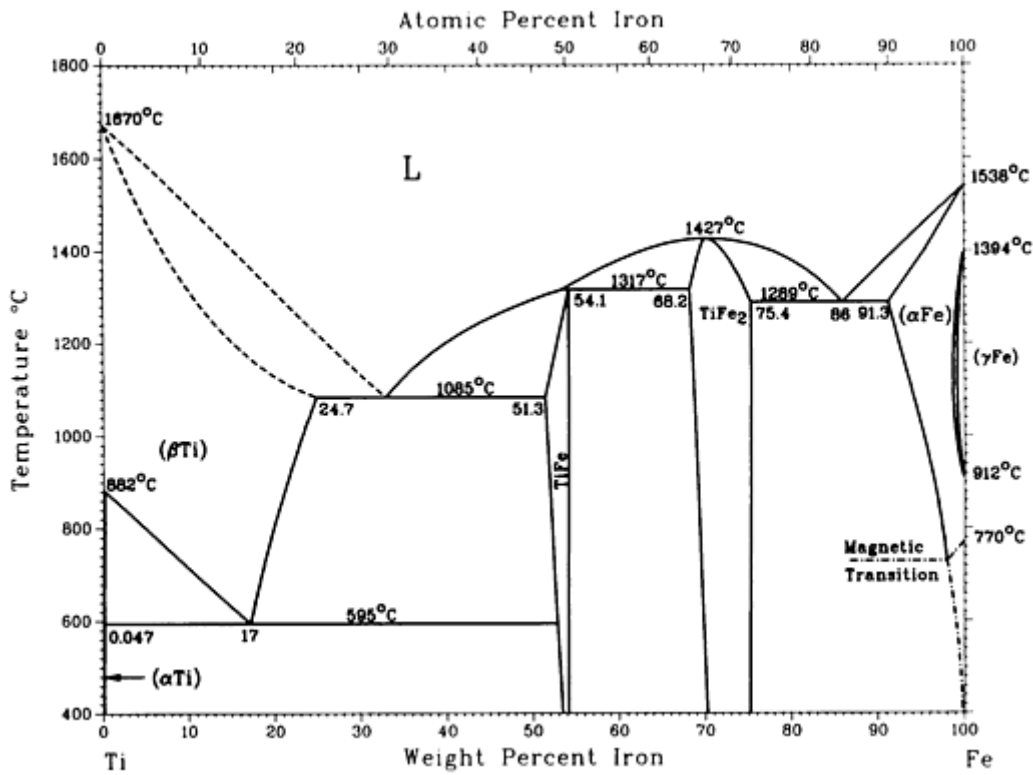

Fe-Ti phase diagram

Fe-Ti crystallographic data

Phase	Composition, wt% Fe	Pearson symbol	Space group
(αTi)	0 to 0.047	<i>hP2</i>	<i>P6₃/mmc</i>
(βTi)	0 to 24.7	<i>cI2</i>	<i>Im$\bar{3}m$</i>
TiFe	51.3 to 54.1	<i>cP2</i>	<i>Pm$\bar{3}m$</i>
TiFe ₂	68.2 to 75.4	<i>hP12</i>	<i>P6₃/mmc</i>
(αFe)	91.3 to 100	<i>cI2</i>	<i>Im$\bar{3}m$</i>
(γFe)	99.5 to 100	<i>cF4</i>	<i>Fm$\bar{3}m$</i>
ω	(a)	<i>hP3</i>	<i>P6/mmm</i>

(a) Metastable phase

Fe-Tm (Iron - Thulium)

H. Okamoto, 1992

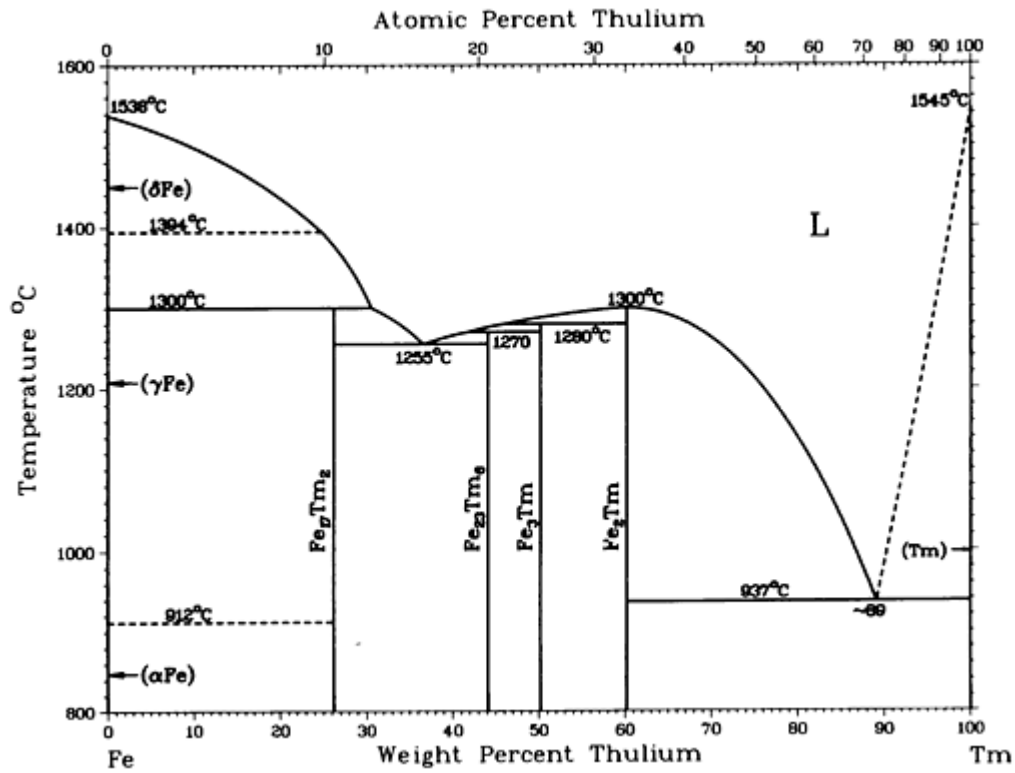

Fe-Tm phase diagram

Fe-Tm crystallographic data

Phase	Composition, wt% Tm	Pearson symbol	Space group
(δFe)	0	<i>cI2</i>	<i>Im</i> $\bar{3}m$
(γFe)	0	<i>cF4</i>	<i>Fm</i> $\bar{3}m$
(αFe)	0	<i>cI2</i>	<i>Im</i> $\bar{3}m$
Fe ₁₇ Tm ₂	26.2	<i>hP38</i>	<i>P6</i> ₃ / <i>mmc</i>
Fe ₂₃ Tm ₆	44.1	<i>cF114</i>	<i>Fm</i> $\bar{3}m$

Fe_3Tm	50.2	$hR12$	$R\bar{3}m$
Fe_2Tm	60.2	$cF24$	$Fd\bar{3}m$
(Tm)	100	$hP2$	$P6_3/mmc$
Metastable phase			
...	~ 75	$hP12$	$P6_3/mmc$

Fe-U (Iron - Uranium)

H. Okamoto, 1992

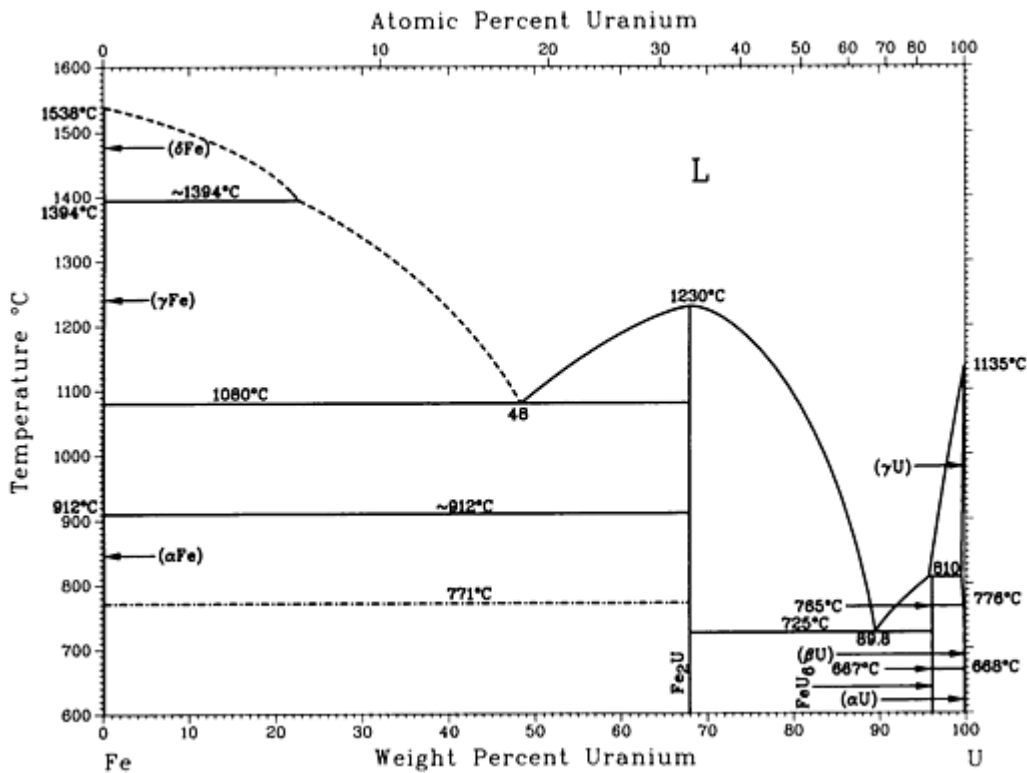

Fe-U phase diagram

Fe-U crystallographic data

Phase	Composition, wt% U	Pearson symbol	Space group
(δFe)	0	$cI2$	$Im\bar{3}m$

(γ Fe)	0	<i>cF4</i>	<i>Fm</i> $\bar{3}m$
(α Fe)	0	<i>cI2</i>	<i>Im</i> $\bar{3}m$
Fe ₂ U	68.0	<i>cF24</i>	<i>Fd</i> $\bar{3}m$
FeU ₆	96.2	<i>tI28</i>	<i>I4/mcm</i>
(γ U)	99.7 to 100	<i>cI2</i>	<i>Im</i> $\bar{3}m$
(β U)	99.9 to 100	<i>tP30</i>	<i>P4</i> ₂ <i>/mnm</i>
(α U)	99.99 to 100	<i>oC4</i>	<i>Cmcm</i>

Fe-V (Iron - Vanadium)

J.F. Smith, 1992

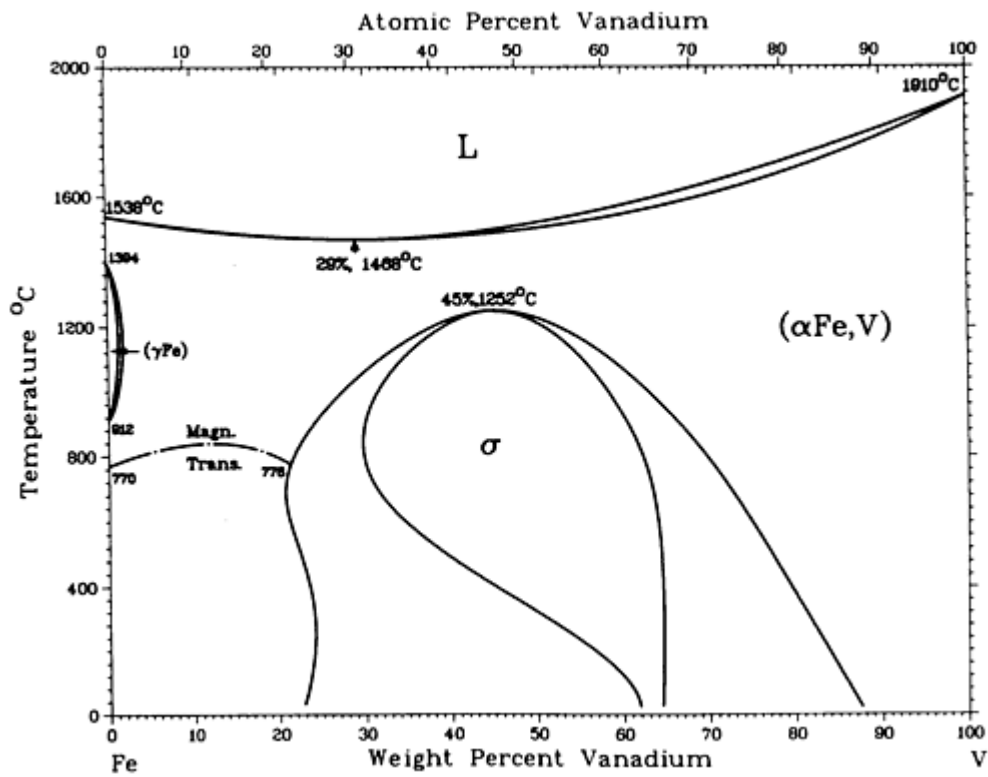

Fe-V phase diagram

Fe-V crystallographic data

Phase	Composition, wt% V	Pearson symbol	Space group
(α Fe,V)	0 to 100	<i>cI2</i>	$Im\bar{3}m$
(γ Fe)	0 to 1.2	<i>cF4</i>	$Fm\bar{3}m$
σ	30 to 65	<i>tP30</i>	Pa_2/mnm
Metastable phase			
α'	47.7	<i>cP2</i>	$Pm\bar{3}m$

Fe-W (Iron - Tungsten)

S.V. Nagender Naidu, A.M. Sriramamurthy, and P. Rama Rao, 1992

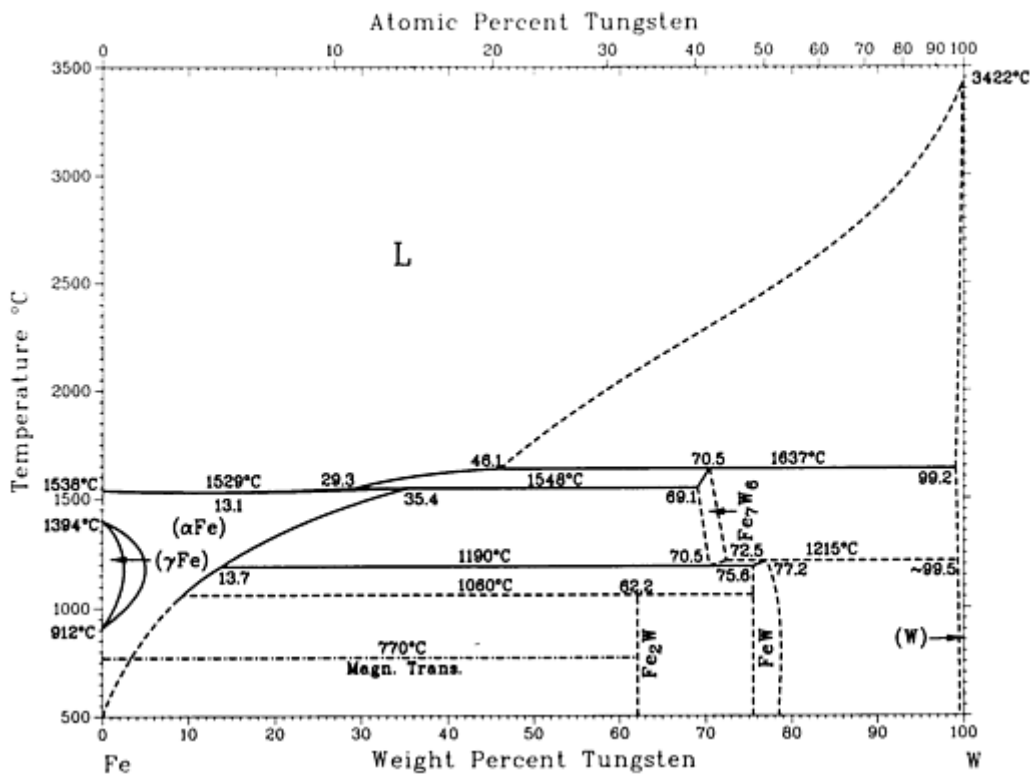

Fe-W phase diagram

Fe-W crystallographic data

Phase	Composition, wt% W	Pearson symbol	Space group
(α Fe)	0 to 100	<i>cI2</i>	$Im\bar{3}m$
(γ Fe)	0 to 1.2	<i>cF4</i>	$Fm\bar{3}m$
σ	30 to 65	<i>tP30</i>	Pa_2/mnm
Metastable phase			
α'	47.7	<i>cP2</i>	$Pm\bar{3}m$

(γ Fe)	0	$cF4$	$Fm\bar{3}m$
(α Fe)	0	$cI2$	$Im\bar{3}m$
Fe_7W_6 (μ)	~ 70.5	$hR13$	$R\bar{3}m$
FeW (δ)	~ 77.2	(a)	$P2_12_12_1$
(W)	100	$cI2$	$Im\bar{3}m$
Metastable phase			
Fe_2W (λ)	62.2	$hP12$	$P6_3/mmc$

(a) Orthorhombic

Fe-Zn (Iron - Zinc)

B.P. Burton and P. Perrot, 1992

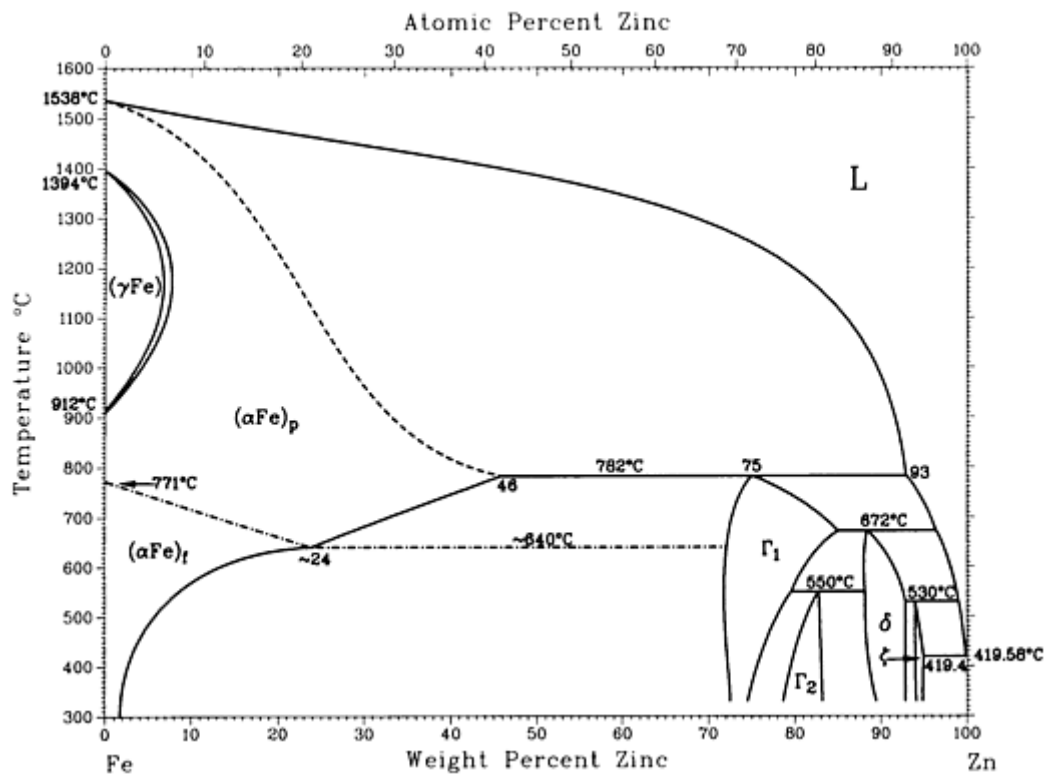

Fe-Zn phase diagram

Fe-Zn crystallographic data

Phase	Composition, wt% Zn	Pearson symbol	Space group
(γ Fe)	0 to 6.59	<i>cF4</i>	<i>Fm</i> $\bar{3}m$
(α Fe, δ Fe)	0 to 46	<i>cI2</i>	<i>Im</i> $\bar{3}m$
Γ_1	~ 72 to ~ 85	<i>cI52</i>	<i>I</i> $\bar{4}3m$
Γ_2	0.91 to 83	<i>cF408</i>	<i>F</i> $\bar{4}3m$
δ -FeZn ₁₀	88.5 to 93.0	<i>hP555</i>	<i>P6</i> ₃ <i>mc</i>
ζ -FeZn ₁₃	~ 94 to 94.8?	<i>mC28</i>	<i>C2/m</i>
(Zn)	~ 100	<i>hP2</i>	<i>P6</i> ₃ <i>/mmc</i>

Fe-Zr (Iron - Zirconium)

D. Arias and J.P. Abriata, 1992

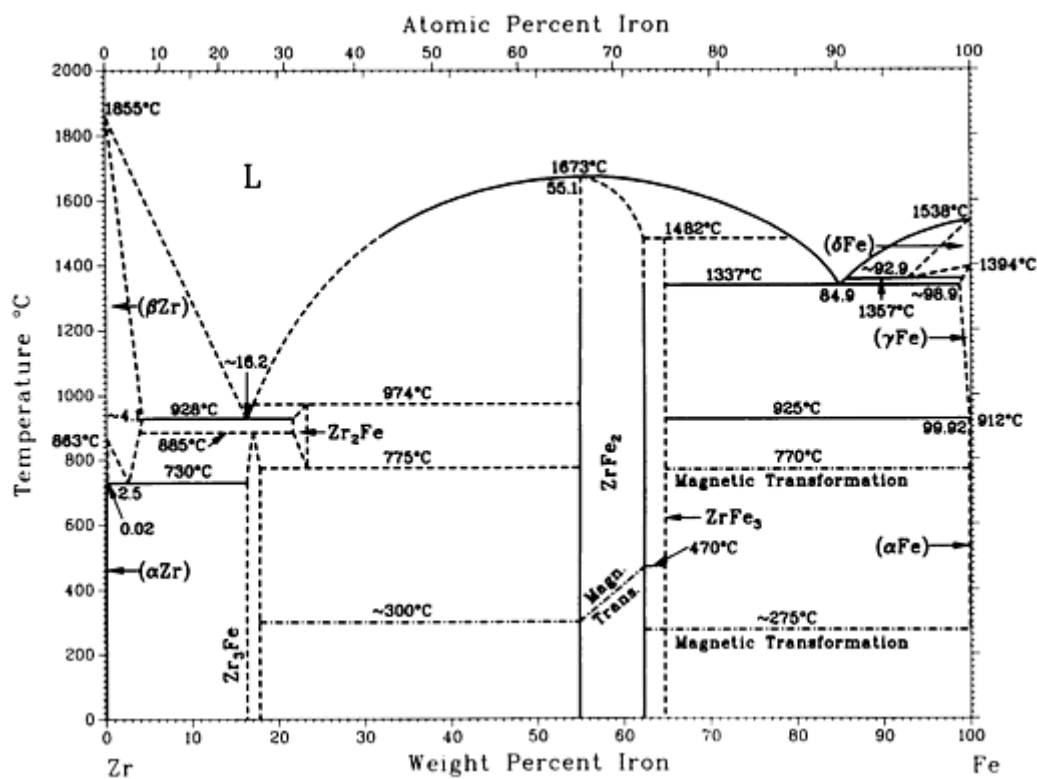

Fe-Zr phase diagram

Fe-Zr crystallographic data

Phase	Composition, wt% Fe	Pearson symbol	Space group
(β Zr)	0 to ~4.1	<i>cI2</i>	<i>Im</i> $\bar{3}m$
(α Zr)	0 to 0.02	<i>hP2</i>	<i>P6</i> $_3$ / <i>mmc</i>
Zr ₃ Fe	16.2 to 18.3	<i>oC16</i>	<i>Cmcm</i>
Zr ₂ Fe	21.6 to 23.4	<i>tI12</i>	<i>I4/mcm</i>
ZrFe ₂	54.3 to 62.2	<i>cF24</i>	<i>Fd</i> $\bar{3}m$
ZrFe ₃	64.7	<i>cF116</i>	<i>Fm</i> $\bar{3}m$
(δ Fe)	~92.9 to 100	<i>cI2</i>	<i>Im</i> $\bar{3}m$
(γ Fe)	~98.9 to 100	<i>cF4</i>	<i>Fm</i> $\bar{3}m$

(α Fe)	99.91 to 100	<i>cI2</i>	<i>Im$\bar{3}m$</i>
----------------	--------------	------------	--------------------------------

Ga (Gallium) Binary Alloy Phase Diagrams

Introduction

THIS ARTICLE includes systems where gallium is the first-named element in the binary pair. Additional binary systems that include gallium are provided in the following locations in this Volume:

- “Ag-Ga (Silver - Gallium)” in the article “Ag (Silver) Binary Alloy Phase Diagrams.”
- “Al-Ga (Aluminum - Gallium)” in the article “Al (Aluminum) Binary Alloy Phase Diagrams.”
- “As-Ga (Arsenic - Gallium)” in the article “As (Arsenic) Binary Alloy Phase Diagrams.”
- “Au-Ga (Gold - Gallium)” in the article “Au (Gold) Binary Alloy Phase Diagrams.”
- “Ba-Ga (Barium - Gallium)” in the article “Ba (Barium) Binary Alloy Phase Diagrams.”
- “Bi-Ga (Bismuth - Gallium)” in the article “Bi (Bismuth) Binary Alloy Phase Diagrams.”
- “Ca-Ga (Calcium - Gallium)” in the article “Ca (Calcium) Binary Alloy Phase Diagrams.”
- “Cd-Ga (Cadmium - Gallium)” in the article “Cd (Cadmium) Binary Alloy Phase Diagrams.”
- “Ce-Ga (Cerium - Gallium)” in the article “Ce (Cerium) Binary Alloy Phase Diagrams.”
- “Cl-Ga (Chlorine - Gallium)” in the article “Cl (Chlorine) Binary Alloy Phase Diagrams.”
- “Co-Ga (Cobalt - Gallium)” in the article “Co (Cobalt) Binary Alloy Phase Diagrams.”
- “Cr-Ga (Chromium - Gallium)” in the article “Cr (Chromium) Binary Alloy Phase Diagrams.”
- “Cu-Ga (Copper - Gallium)” in the article “Cu (Copper) Binary Alloy Phase Diagrams.”
- “Dy-Ga (Dysprosium - Gallium)” in the article “Dy (Dysprosium) Binary Alloy Phase Diagrams.”
- “Er-Ga (Erbium - Gallium)” in the article “Er (Erbium) Binary Alloy Phase Diagrams.”
- “Eu-Ga (Europium - Gallium)” in the article “Eu (Europium) Binary Alloy Phase Diagrams.”
- “Fe-Ga (Iron - Gallium)” in the article “Fe (Iron) Binary Alloy Phase Diagrams.”

Ga-Gd (Gallium - Gadolinium)

A. Palenzona and S. Cirafici, 1990

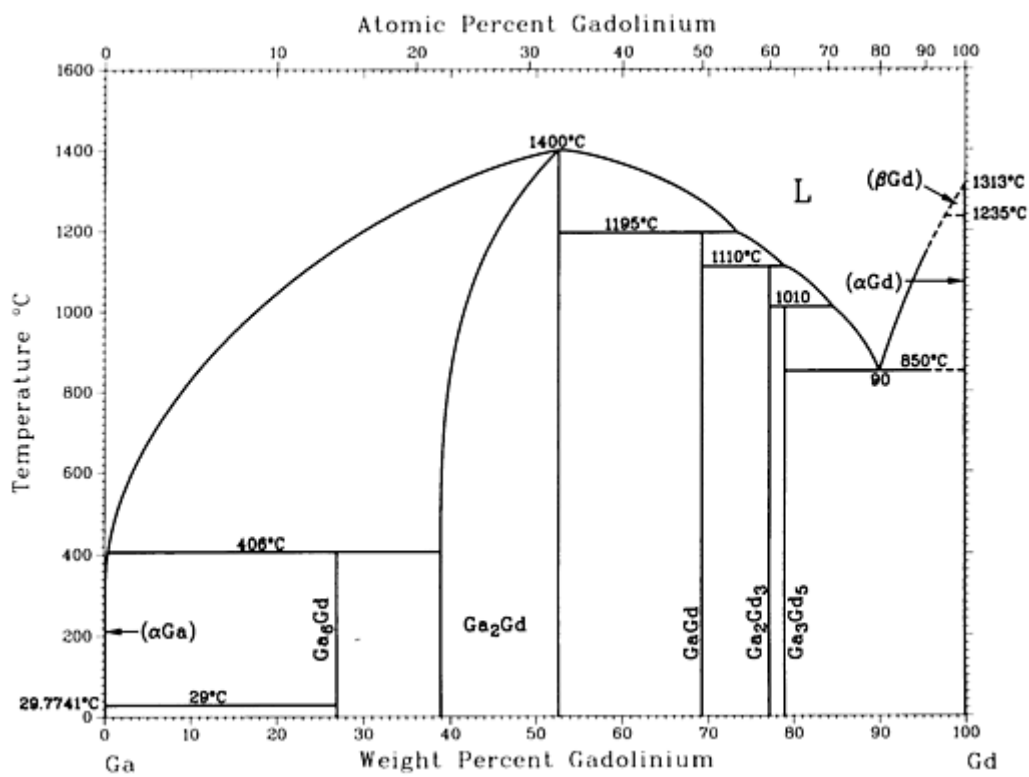

Ga-Gd phase diagram

Ga-Gd crystallographic data

Phase	Composition, wt% Gd	Pearson symbol	Space group
(Ga)	~0	<i>oC8</i>	<i>Cmca</i>
Ga₆Gd	27.32	<i>tP14</i>	<i>P4/nbm</i>
Ga₂Gd	39 to 53.0	<i>hP3</i>	<i>P6/mmm</i>
GaGd	69.3	<i>oC8</i>	<i>Cmcm</i>
Ga₂Gd₃	77	<i>tI80</i>	<i>I4/mcm</i>
Ga₃Gd₅	79.0	<i>tI32</i>	<i>I4/mcm</i>
(βGd)	~100	<i>cI2</i>	<i>Im$\bar{3}m$</i>
(αGd)	~100	<i>hP2</i>	<i>P6₃/mmc</i>

Ga-Ho (Gallium - Holmium)

H. Okamoto, 1990

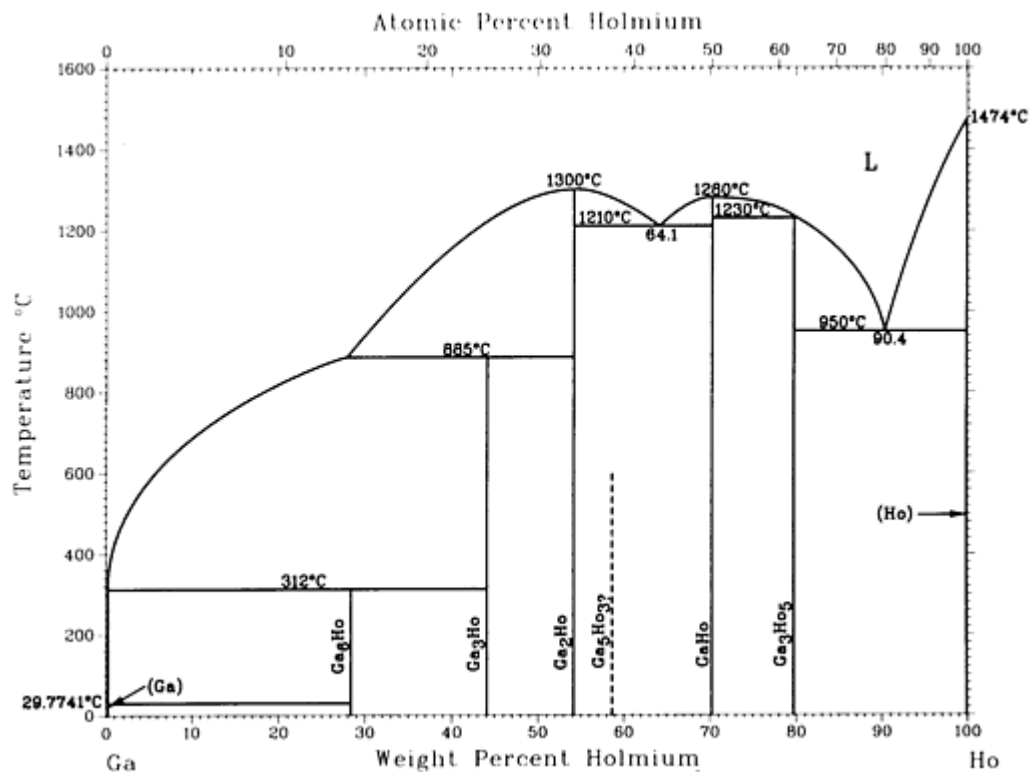

Ga-Ho phase diagram

Ga-Ho crystallographic data

Phase	Composition, wt% Ho	Pearson symbol	Space group
(Ga)	0	<i>oC8</i>	<i>Cmca</i>
Ga ₆ Ho	28.3	<i>tP14</i>	<i>P4/nbm</i>
Ga ₃ Ho	44	<i>cP4</i>	<i>Pm$\bar{3}$m</i>
Ga ₂ Ho	54.1	<i>hP3</i>	<i>P6/mmm</i>
Ga ₅ Ho ₃	58.7	<i>oP32</i>	<i>P4/nbm</i>
GaHo	70.3	<i>oC8</i>	<i>Cmcm</i>
Ga ₃ Ho ₅	79.8	<i>hP16</i>	<i>P6₃/mcm</i>

(Ho) 100 *hP2* *P6₃/mmc*

Ga-In (Gallium - Indium)

T.J. Anderson and I. Ansara, 1992

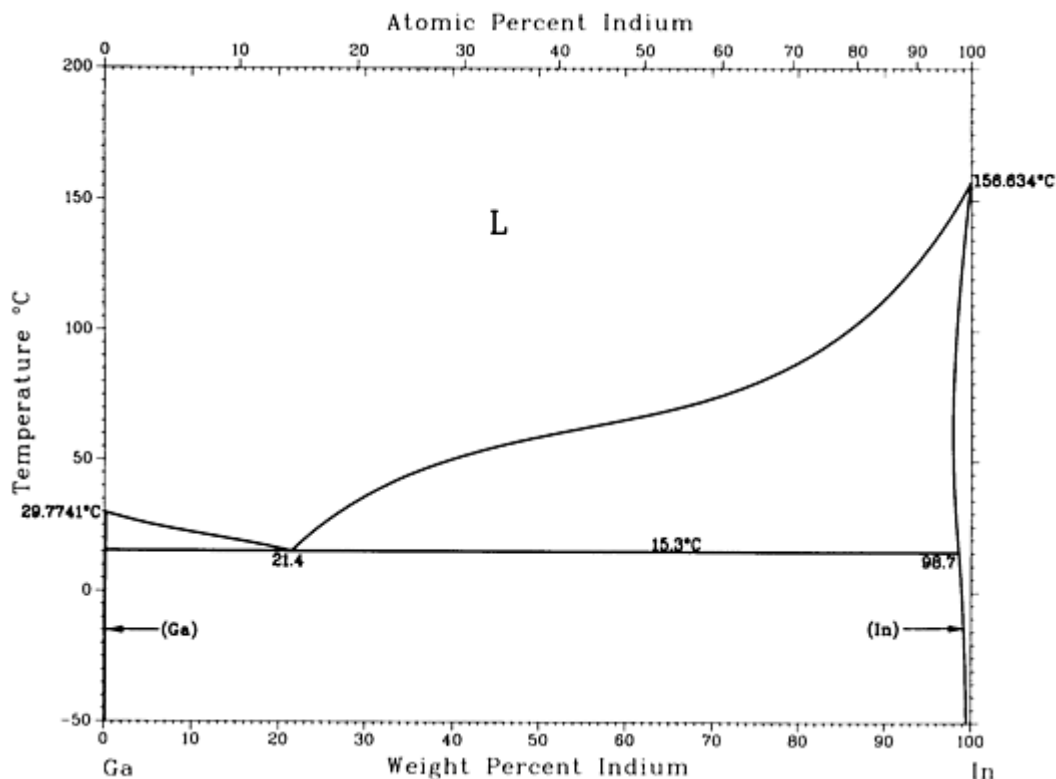

Ga-In phase diagram

Ga-In crystallographic data

Phase	Composition, wt% In	Pearson symbol	Space group
(α Ga)	0	<i>oC8</i>	<i>Cmca</i>
(β Ga)	0	...	<i>C2/c</i>
(In)	98.6 to 100	<i>iI2</i>	<i>I4/mmm</i>

Ga-La (Gallium - Lanthanum)

A. Palenzona and S. Cirafici, 1990

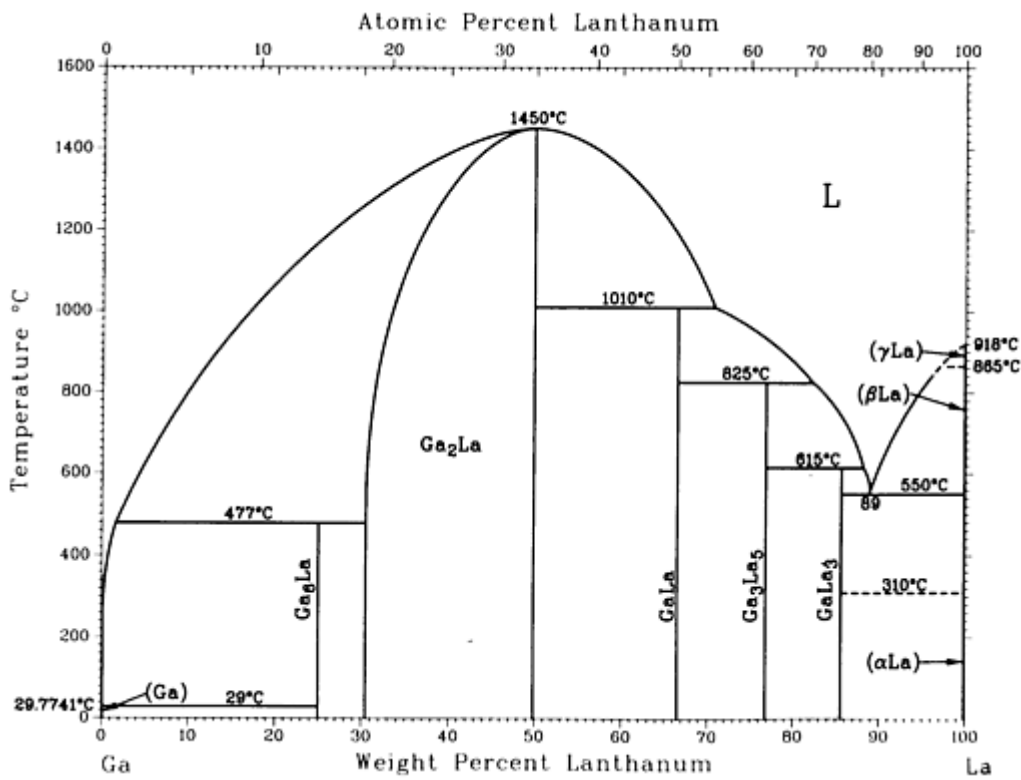

Ga-La phase diagram

Ga-La crystallographic data

Phase	Composition, wt% La	Pearson symbol	Space group
(αGa)	~0	<i>oC8</i>	<i>Cmca</i>
Ga ₆ La	24.9	<i>tP14</i>	<i>P4/nbm</i>
Ga ₄ La ^(a)	33	<i>o**</i>	...
Ga ₂ La	30 to 49.9	<i>hP3</i>	<i>P6/mmm</i>
GaLa	66.6	<i>oC8</i>	<i>Cmcm</i>
Ga ₃ La ₅	76.9	<i>tI32</i>	<i>I4/mcm</i>
GaLa ₃	86	<i>cP4</i>	<i>Pm$\bar{3}$m</i>
(γLa)	~100	<i>cI2</i>	<i>Im$\bar{3}$m</i>

(βLa)	~ 100	$cF4$	$Fm\bar{3}m$
(αLa)	~ 100	$hP4$	$P6_3/mmc$

(a) Not shown on diagram; needs further confirmation

Ga-Li (Gallium - Lithium)

J. Sangster and A.D. Pelton, 1991

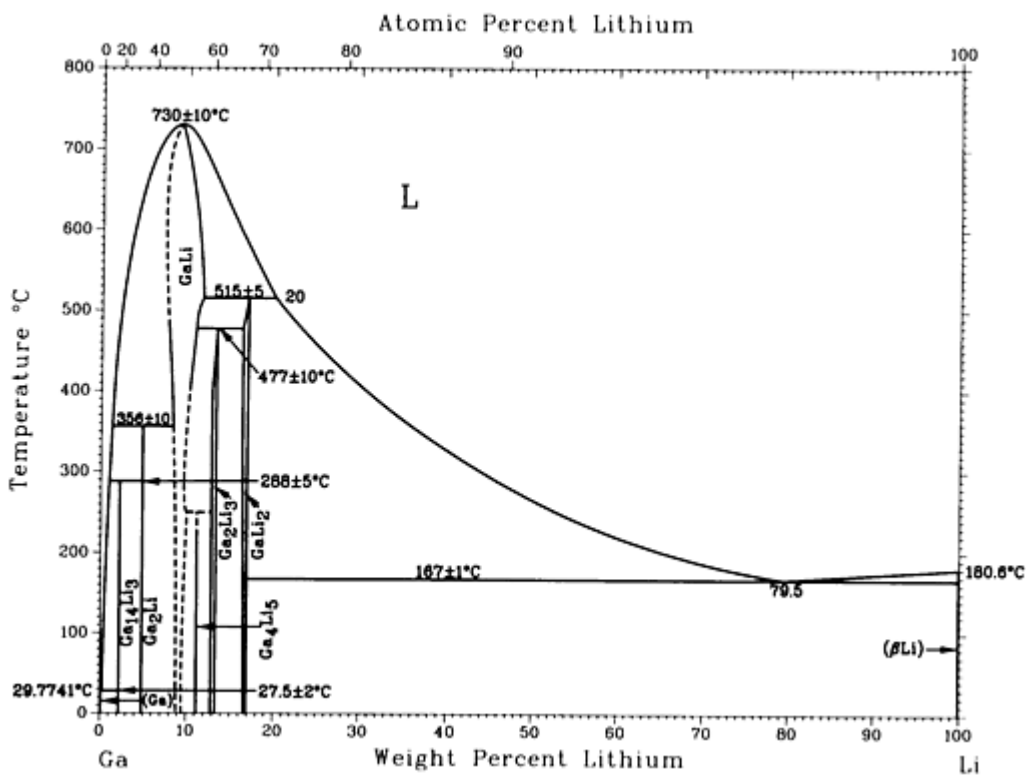

Ga-Li phase diagram

Ga-Li crystallographic data

Phase	Composition, wt% Li	Pearson symbol	Space group
(Ga)	0	$oC8$	$Cmca$
$\text{Ga}_{14}\text{Li}_3$	2.1	$hR51$	$R\bar{3}m$
Ga_2Li	4.7 ^(a)

GaLi	8 to 11 ^(b)	<i>cF16</i>	<i>Fd$\bar{3}m$</i>
Ga₄Li₅	11.1	<i>hR9</i>	<i>P$\bar{3}m1$</i>
Ga₂Li₃	12.8 to 13.2	<i>hR15</i>	<i>R$\bar{3}m$</i>
GaLi₂	16 to 17	<i>oC12</i>	<i>Cmcm</i>
(βLi)	100	<i>cI2</i>	<i>Im$\bar{3}m$</i>
(αLi)^(c)	100	<i>hP2</i>	<i>P6₃/mmc</i>

(a) Stoichiometry uncertain.

(b) Near 400 °C.

(c) Below -193 °C

Ga-Lu (Gallium - Lutetium)

S.P. Yatsenko, A.A. Semyannikov, B.G. Semenov, and K.A. Chuntunov, 1979

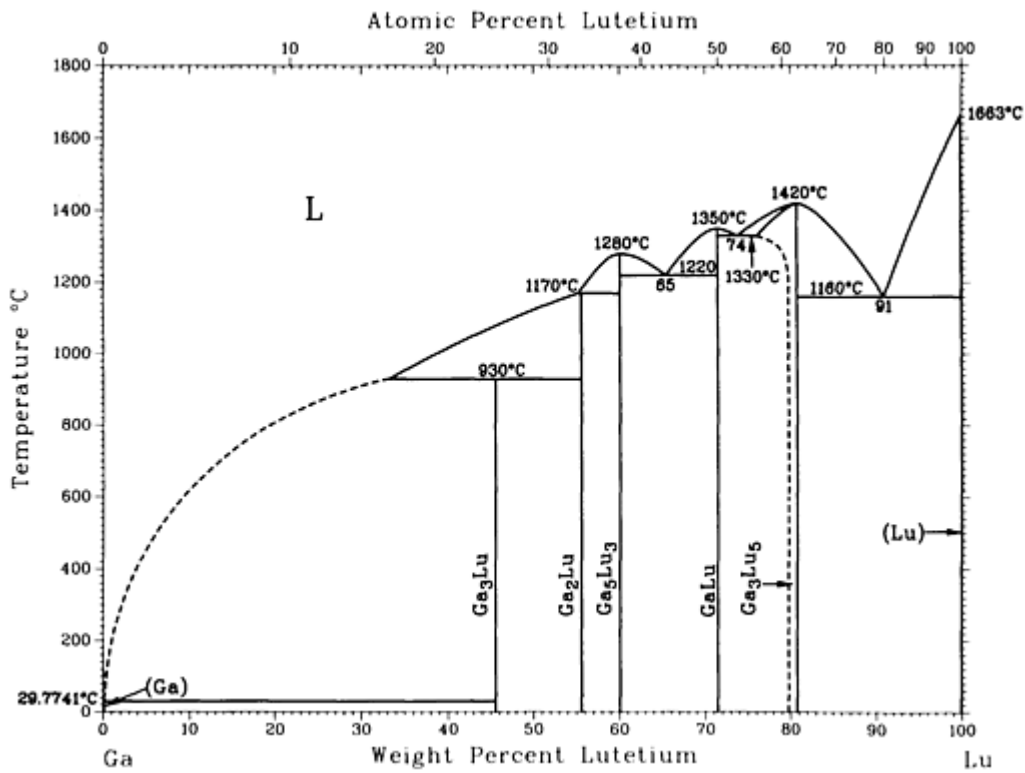

Ga-Lu phase diagram

Ga-Lu crystallographic data

Phase	Composition, wt% Lu	Pearson symbol	Space group
(Ga)	0	<i>oC8</i>	<i>Cmca</i>
Ga_3Lu	46	<i>cP4</i>	$Pm\bar{3}m$
Ga_2Lu	55.6	<i>oI12</i>	<i>Imma</i>
Ga_5Lu_3	60.1	<i>oP32</i>	<i>Pnma</i>
$GaLu$	71.5	<i>oC8</i>	<i>Cmcm</i>
Ga_3Lu_5	? to 80.7	<i>hP16</i>	<i>P6_3/mcm</i>
(Lu)	100	<i>hP2</i>	<i>P6_3/mmc</i>

Ga-Mg (Gallium - Magnesium)

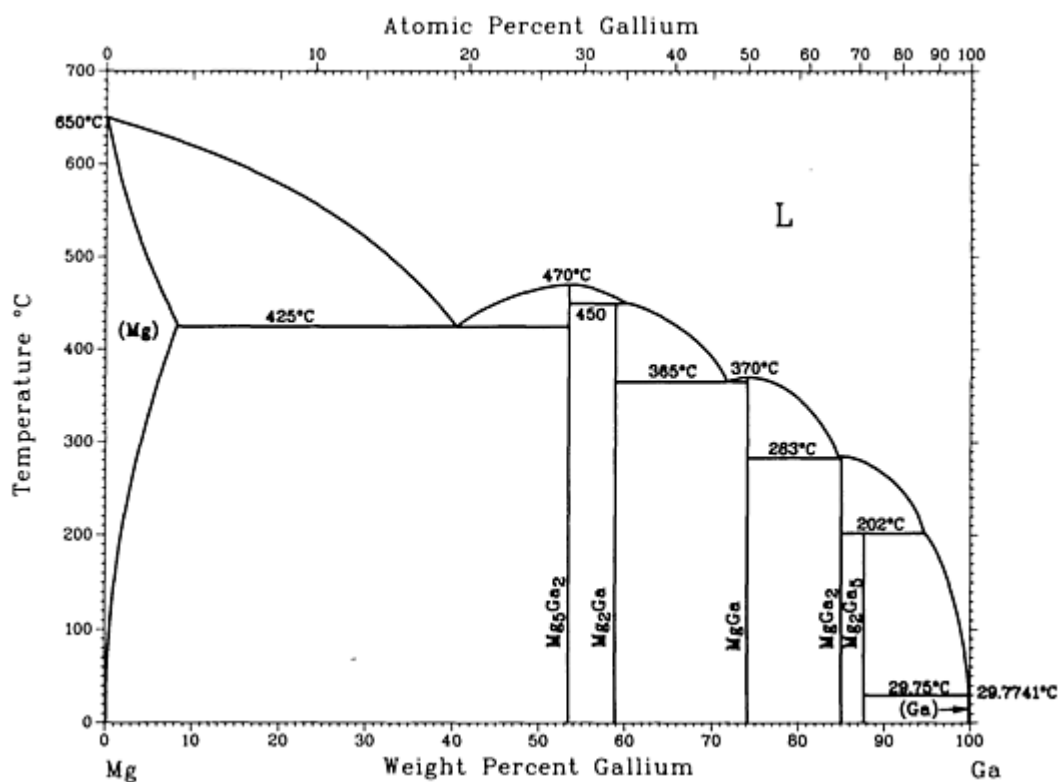

Ga-Mg phase diagram

Ga-Mg crystallographic data

Phase	Composition, wt% Ga	Pearson symbol	Space group
(Mg)	0 to 9.4	<i>hP2</i>	<i>P6₃/mmc</i>
Mg ₅ Ga ₂	53.43	<i>oI28</i>	<i>Ibam</i>
Mg ₂ Ga ^(a)	58.9	<i>hP18</i>	<i>P$\bar{6}$2c</i>
MgGa	74.2	<i>tI32</i>	<i>I4₁/a</i>
MgGa ₂	85.15	<i>oP24</i>	<i>Pbam</i>
Mg ₂ Ga ₅	87.76	<i>tI28</i>	<i>I4/mmm</i>
(Ga)	100	<i>oC8</i>	<i>Cmca</i>

(a) The structure is closely related to the Fe₂P (*hP9*) type with a small deviation.

Ga-Mn (Gallium - Manganese)

X.S. Lu, J.K. Liang, and M.G. Zhou, 1980

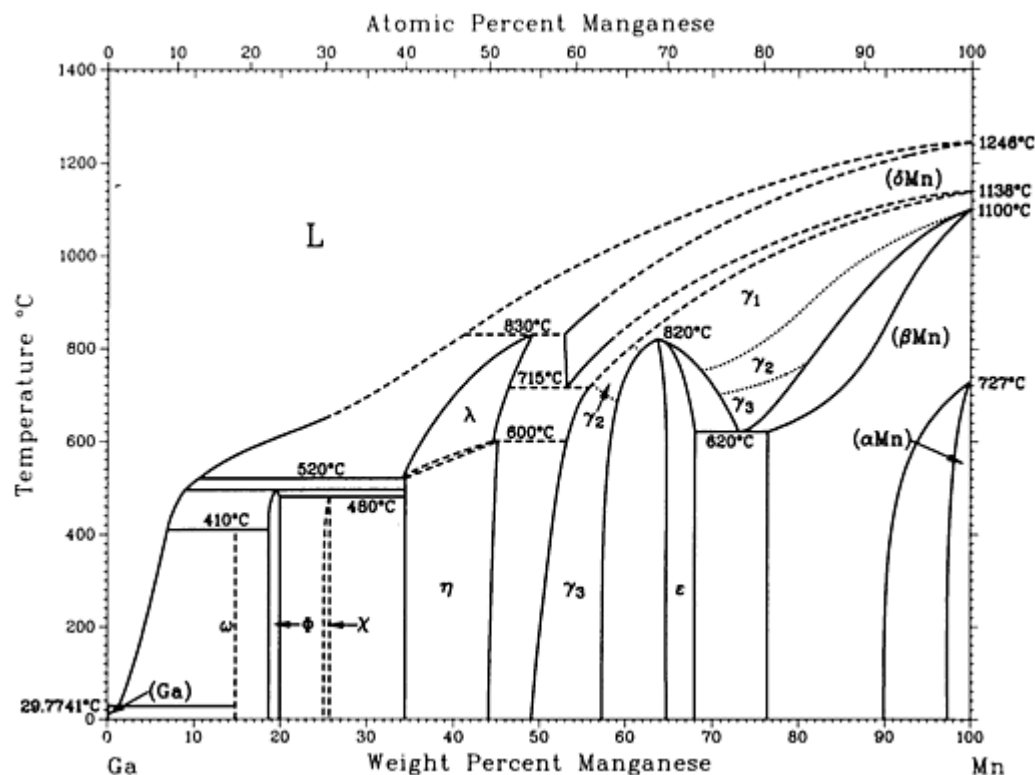

Ga-Mn phase diagram

Ga-Mn crystallographic data

Phase	Composition, wt% Mn	Pearson symbol	Space group
(Ga)	0	<i>oC8</i>	<i>Cmca</i>
ω	15	<i>oC28</i>	<i>Cmcm</i>
φ	~18 to 20
χ	~25	<i>tP14</i>	<i>P4/mbm</i>
λ	~34.0 to 49	<i>hR26</i>	$R\bar{3}m$
η	34.4 to 44
(δMn)	~53 to 100	<i>cI2</i>	$Im\bar{3}m$

$\gamma_1(\gamma\text{Mn})$	~ 62 to 100	$cF4$	$Fm\bar{3}m$
γ_2	~ 56 to 100	$tI8$	$I4/mmm$
γ_3	~ 49 to ~ 59	$tP4$	$P4/mmm$
ϵ	64 to 68	\dots	\dots
(βMn)	76.3 to ~ 100	$cP20$	$P4_132$
(αMn)	97.3 to ~ 100	$cI58$	$I\bar{4}3m$

Ga-Mo (Gallium - Molybdenum)

From [Molybdenum] 12

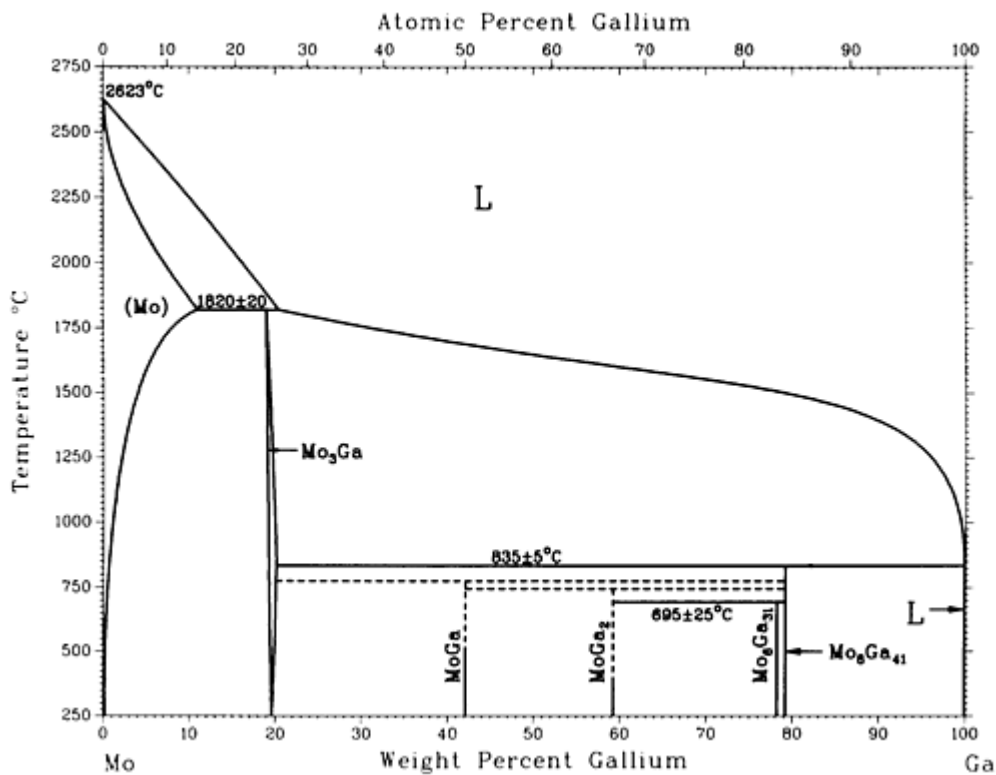

Ga-Mo phase diagram

Ga-Mo crystallographic data

Phase	Composition, wt% Ga	Pearson symbol	Space group
-------	---------------------	----------------	-------------

(Mo)	0 to 11	<i>cI2</i>	<i>Im</i> $\bar{3}m$
Mo₃Ga	~20	<i>cP8</i>	<i>Pm</i> $\bar{3}n$
MoGa	42.1
MoGa₂	59.3
Mo₆Ga₃₁	~78	<i>mP148</i>	<i>P2₁/c</i>
Mo₈Ga₄₁	~79	<i>hR49</i>	<i>R</i> $\bar{3}$
(Ga)	100	<i>oC8</i>	<i>Cmca</i>

Reference cited in this section

12. [**Molybdenum**]: L. Brewer, *Molybdenum: Physico-Chemical Properties of Its Compounds and Alloys*, O. Kubaschewski, Ed., Atomic Energy Review Special Issue No.7, International Atomic Energy Agency, Vienna (1980).

Ga-Na (Gallium - Sodium)

A.D. Pelton and S. Larose, 1990

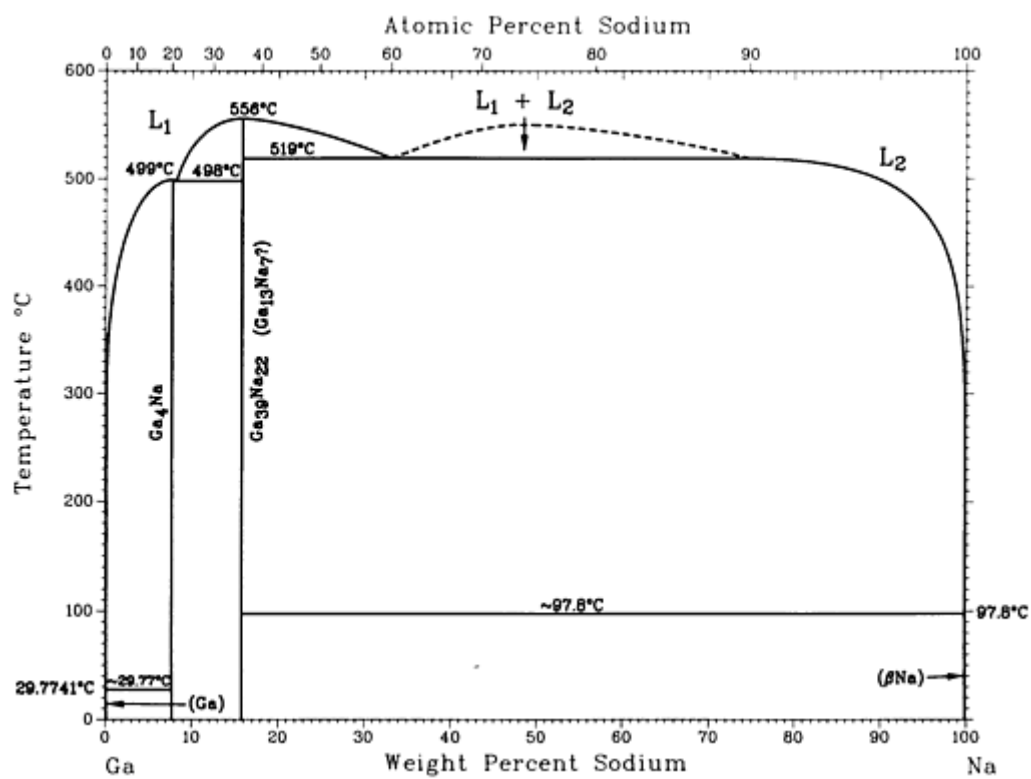

Ga-Na phase diagram

Ga-Na crystallographic data

Phase	Composition, wt% Na	Pearson symbol	Space group
(Ga)	0	<i>oC8</i>	<i>Cmca</i>
Ga₄Na	8	<i>tI10</i>	<i>I4/mmm</i>
Ga₁₃Na₇^(a)	15	<i>hR360</i>	<i>R$\bar{3}m$</i>
Ga₁₃Na₇^{(b) (c)}	15	<i>oP240</i>	<i>Pnma</i>
Ga₃₉Na₂₂^(c)	15.7	<i>oP244</i>	<i>Pnma</i>
(βNa)	100	<i>cI2</i>	<i>Im$\bar{3}m$</i>
(αNa)	100	<i>hP2</i>	<i>P6₃/mmc</i>

(a) Structure observed when compound prepared with excess Ga.

(b) Structure observed when compound prepared with excess Na.

(c) Same compound with same diffractogram, although different stoichiometries have been reported

Ga-Nb (Gallium - Niobium)

H. Okamoto, 1990

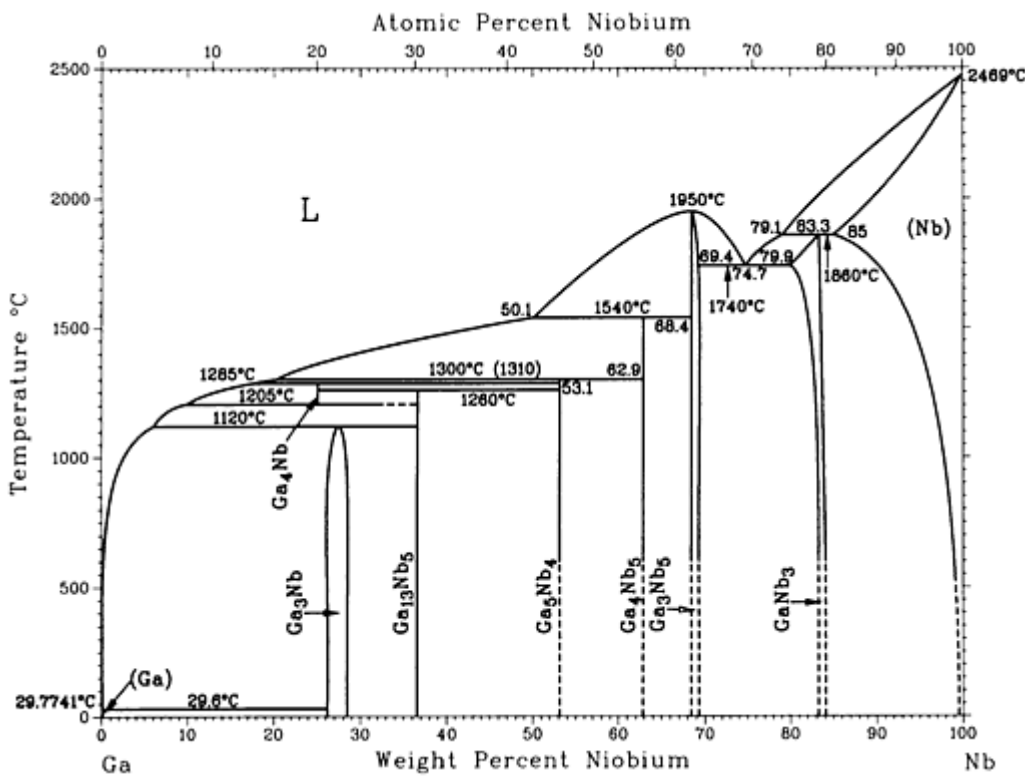

Ga-Nb phase diagram

Ga-Nb crystallographic data

Phase	Composition, wt% Nb	Pearson symbol	Space group
(Ga)	0	<i>oC8</i>	<i>Cmca</i>
Ga ₄ Nb	25
Ga ₃ Nb	26 to 29	<i>tI8</i>	<i>I4/mmm</i>
Ga ₁₃ Nb ₅	36.7	<i>oC36</i>	<i>Cmmm</i>

Ga_5Nb_4	53.3	t^{**}	...
Ga_4Nb_5	62.5	$hP18$	$P6_3/mcm$
$\text{Ga}_2\text{Nb}_3^{(a)}$	67	$tP10$	$P4/mbm$
Ga_3Nb_5	68.4 to 69.4	$tI32$	$I4/mcm$
GaNb_3	79.9 to 84	$cP8$	$Pm\bar{3}n$
(Nb)	100	$cI2$	$Im\bar{3}m$

(a) Not in phase diagram

Ga-Nd (Gallium - Neodymium)

From [Moffatt] 11

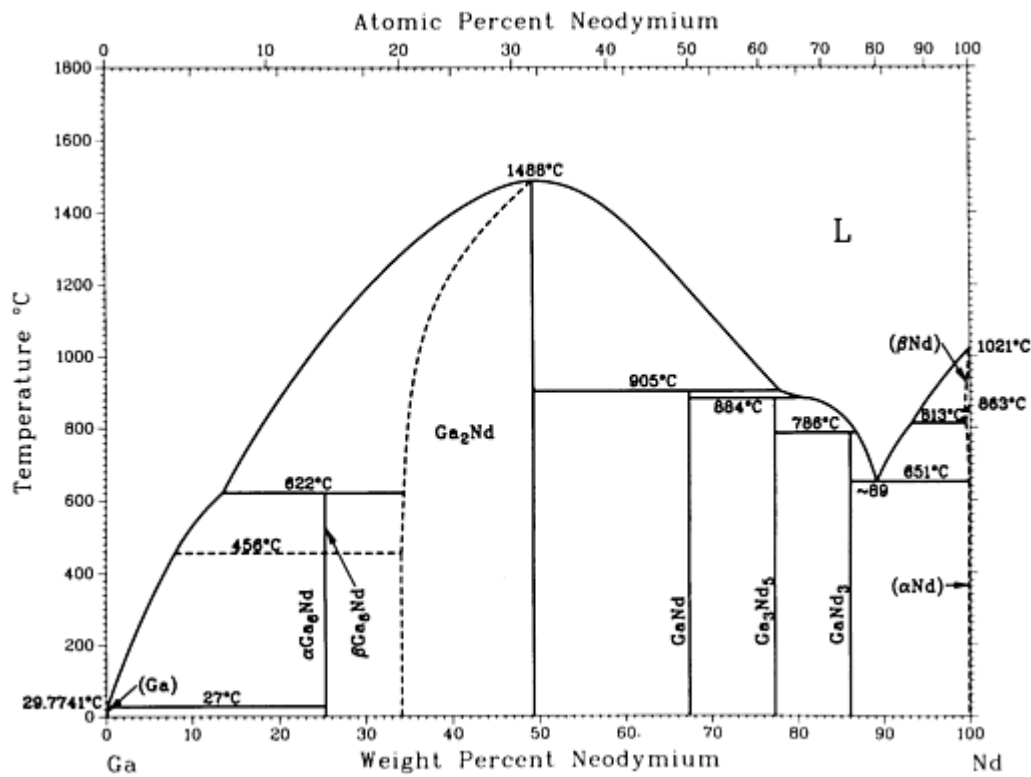

Ga-Nd phase diagram

Ga-Nd crystallographic data

Phase	Composition, wt% Nd	Pearson symbol	Space group
(Ga)	0	<i>oC8</i>	<i>Cmca</i>
β Ga ₆ Nd	25.7
α Ga ₆ Nd	25.7	<i>tP14</i>	<i>P4/nbm</i>
Ga ₂ Nd	~34 to 50.8	<i>hP3</i>	<i>P6/mmm</i>
GaNd	67.4	<i>oC8</i>	<i>Cmcm</i>
Ga ₃ Nd ₅	77.5	<i>tI32</i>	<i>I4/mcm</i>
GaNd ₃	86	<i>cP4</i>	<i>Pm$\bar{3}$m</i>
(β Nd)	? to 100	<i>cI2</i>	<i>Im$\bar{3}$m</i>
(α Nd)	? to 100	<i>hP4</i>	<i>P6₃/mmc</i>

Reference cited in this section

- [Moffatt]: W.G. Moffatt, Ed., *Handbook of Binary Phase Diagrams*, Business Growth Services, General Electric Co., Schenectady, NY (1976).

Ga-Ni (Gallium - Nickel)

S.Y. Lee and P. Nash, 1991

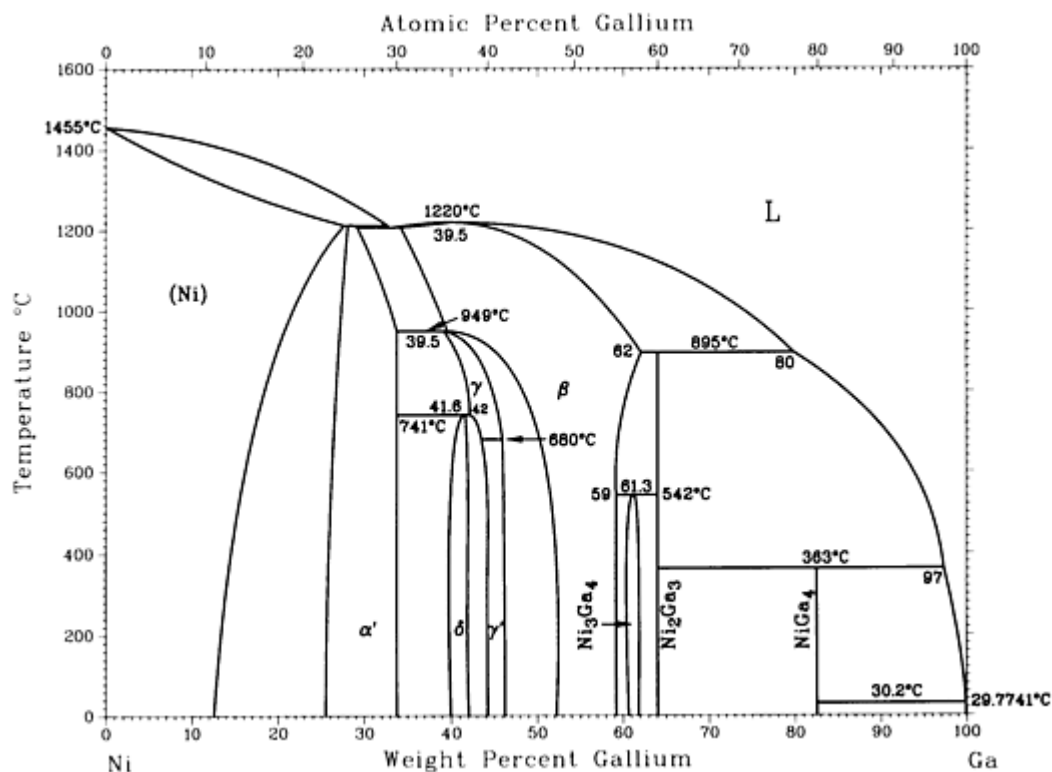

Ga-Ni phase diagram

Ga-Ni crystallographic data

Phase	Composition, wt% Ga	Pearson symbol	Space group
(Ni)	0 to 27.6	<i>cF4</i>	<i>Fm</i> $\bar{3}m$
α' (Ni ₃ Ga)	25.8 to 34	<i>cP4</i>	<i>Pm</i> $\bar{3}m$
β (NiGa)	34.2 to 62	<i>cP2</i>	<i>Pm</i> $\bar{3}m$
γ (Ni ₃ Ga ₂)	39.5 to 46	<i>hP4</i>	<i>P6</i> ₃ / <i>mmc</i>
δ (Ni ₅ Ga ₃)	40.3 to 42	<i>oC16</i>	<i>Cmmm</i>
γ' (Ni ₃ Ga ₂)	~43.4 to ~46.4
Ni ₃ Ga ₄	~60.8 to 61.7	<i>cI112</i>	<i>Ia</i> $\bar{3}d$

β' (Ni ₂ Ga ₃)	64	<i>hP</i> 5	$P\bar{3}m1$
ϵ (NiGa ₄)	83	<i>cI</i> 52	$I\bar{4}3m$
(Ga)	100	<i>oC</i> 8	<i>Cmca</i>

Ga-Pb (Gallium - Lead)

I. Ansara and F. Ajersch, 1991

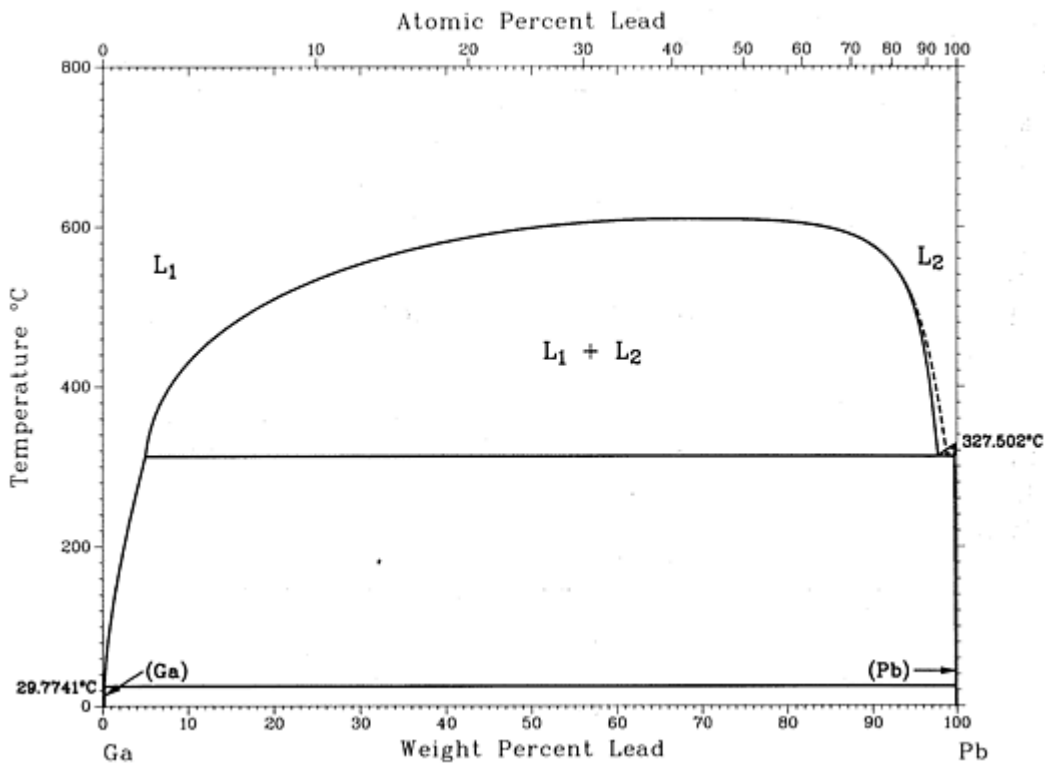

Ga-Pb phase diagram

Ga-Pb crystallographic data

Phase	Composition, wt% Pb	Pearson symbol	Space group
(Ga)	0	<i>oC</i> 8	<i>Cmca</i>
(Pb)	100	<i>cF</i> 4	$Fm\bar{3}m$

Ga-Pd (Gallium - Palladium)

H. Okamoto, 1990

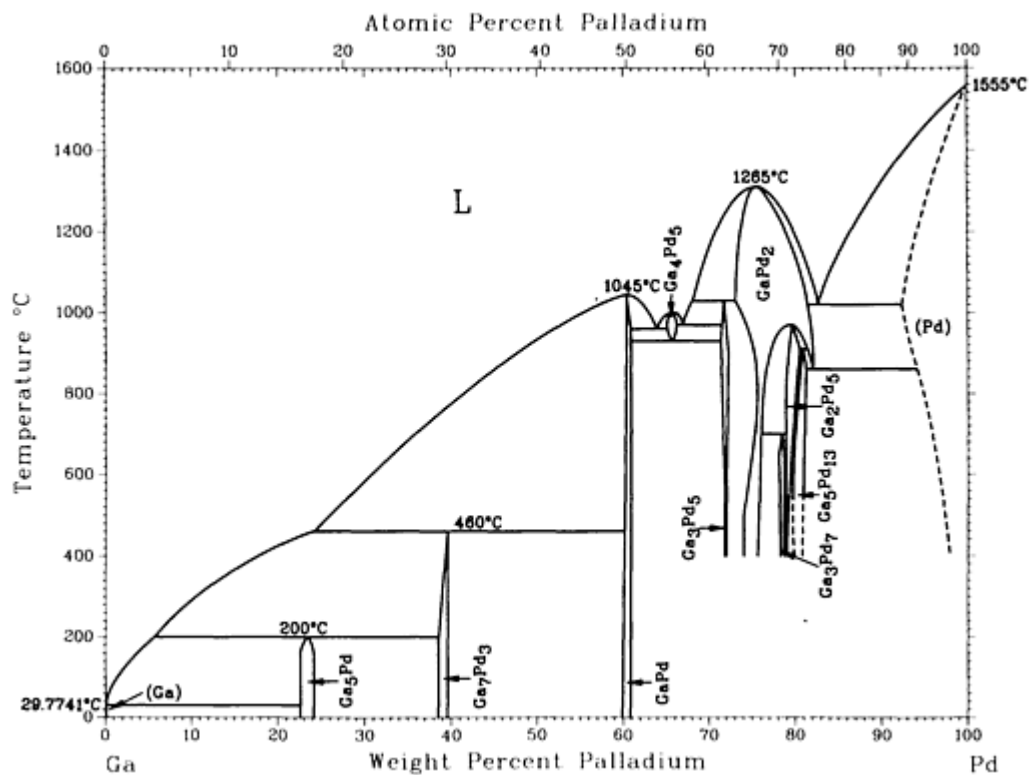

Ga-Pd phase diagram

Ga-Pd crystallographic data

Phase	Composition, wt% Pd	Pearson symbol	Space group
(Ga)	0	<i>oC8</i>	<i>Cmca</i>
Ga ₅ Pd	~23.4	<i>tI24</i>	<i>I4/mcm</i>
Ga ₇ Pd ₃	~40	<i>cI40</i>	<i>Im$\bar{3}m$</i>
GaPd	~60.4	<i>cP8</i>	<i>P2₁3</i>
Ga ₄ Pd ₅	~65.7	<i>cP2</i>	<i>Pm$\bar{3}m$</i>
Ga ₃ Pd ₅	~71.8	<i>oP16</i>	<i>Pbam</i>
GaPd ₂	73 to 82	<i>oP12</i>	<i>Pnma</i>

Ga_3Pd_7	~ 78
Ga_2Pd_5	79 to 80.5	<i>oP28</i>	<i>Pnma</i>
$\text{Ga}_5\text{Pd}_{13}$	80 to 81.3	<i>o**</i>	...
(Pd)	? to 100	<i>cF4</i>	$Fm\bar{3}m$

Ga-Pr (Gallium - Praseodymium)

H. Okamoto, 1990

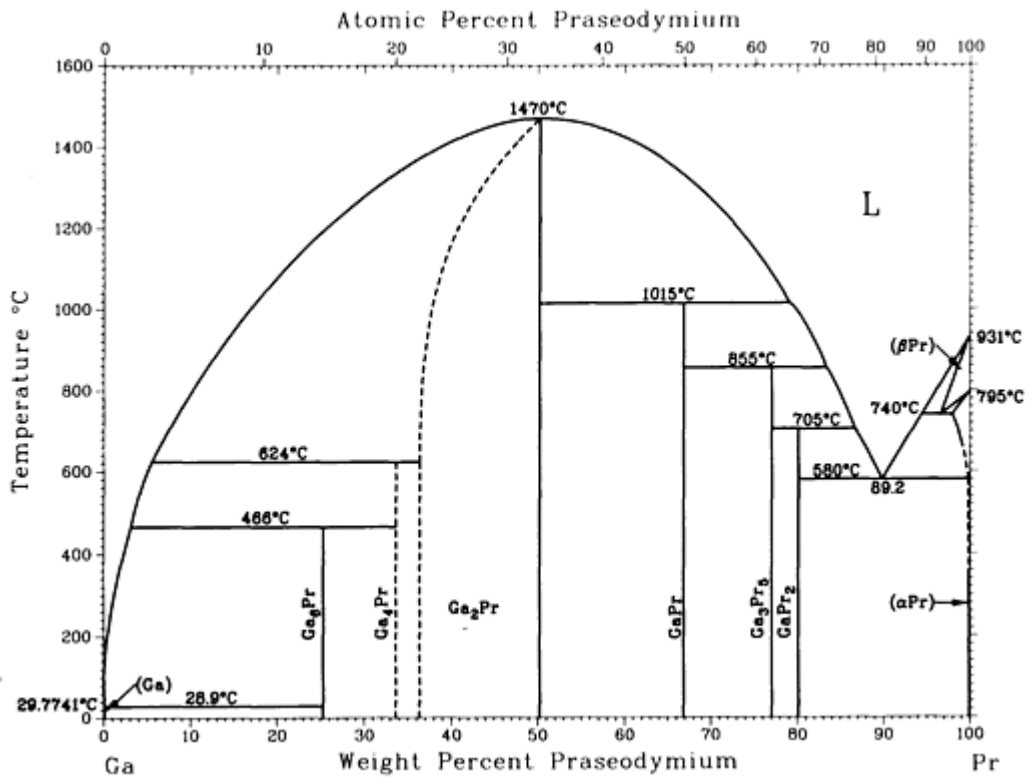

Ga-Pr phase diagram

Ga-Pr crystallographic data

Phase	Composition, wt% Pr	Pearson symbol	Space group
(Ga)	0	<i>oC8</i>	<i>Cmca</i>
Ga_6Pr	25.2	<i>iI14</i>	<i>P4/nbm</i>

Ga_4Pr	34
Ga_2Pr	36 to 50.2	$hP3$	$P6/mmm$
GaPr	66.9	$oC8$	$Cmcm$
Ga_3Pr_5	77.1	$tP32$	$P4/ncc$
GaPr_2	80.2	$oP12$	$Pnma$
(βPr)	96 to 100	$cI2$	$Im\bar{3}m$
(αPr)	98 to 100	$hP4$	$P6_3/mmc$

Ga-Pt (Gallium - Platinum)

H. Okamoto, 1990

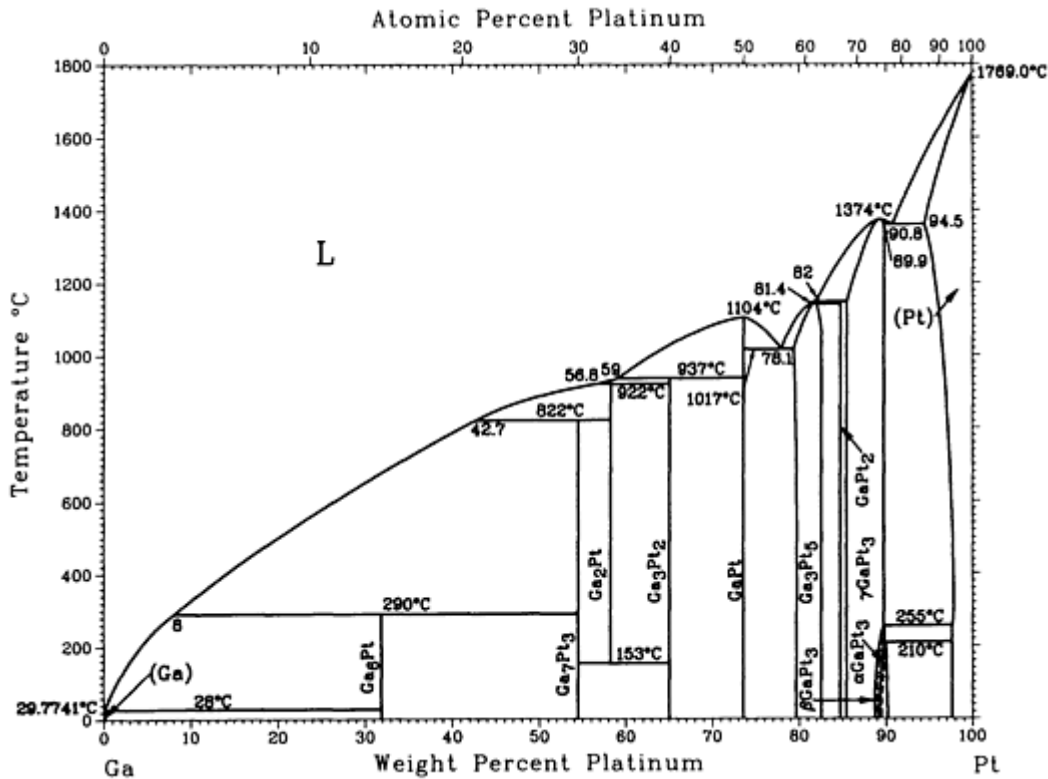

Ga-Pt phase diagram

Ga-Pt crystallographic data

Phase	Composition, wt% Pt	Pearson symbol	Space group
(Ga)	0	<i>oC8</i>	<i>Cmca</i>
Ga₆Pt	31.8	<i>o**</i>	...
Ga₇Pt₃	55	<i>cI40</i>	<i>Im$\bar{3}m$</i>
Ga₂Pt	58.3	<i>cF12</i>	<i>Fm$\bar{3}m$</i>
Ga₃Pt₂	65	<i>hP5</i>	<i>P$\bar{3}m1$</i>
GaPt	73.7	<i>cP8</i>	<i>P2₁₃</i>
Ga₃Pt₅	79 to 83	<i>oC16</i>	<i>Cmmm</i>
γ GaPt₂	84.9	<i>oP16</i>	<i>Pbam</i>
β GaPt₂	84.9	<i>o**</i>	...
α GaPt₂	84.9	<i>tP2</i>	<i>P4/mmm</i>
γ GaPt₃	85 to 90	<i>cP4</i>	<i>Pm$\bar{3}m$</i>
β GaPt₃	~89	<i>tI16</i>	<i>I4/mcm</i>
α GaPt₃	~89	<i>tP16</i>	<i>P4/mbm</i>
(Pt)	94.5 to 100	<i>cF4</i>	<i>Fm$\bar{3}m$</i>

Ga-Pu (Gallium - Plutonium)

D.E. Peterson and M.E. Kassner, 1988

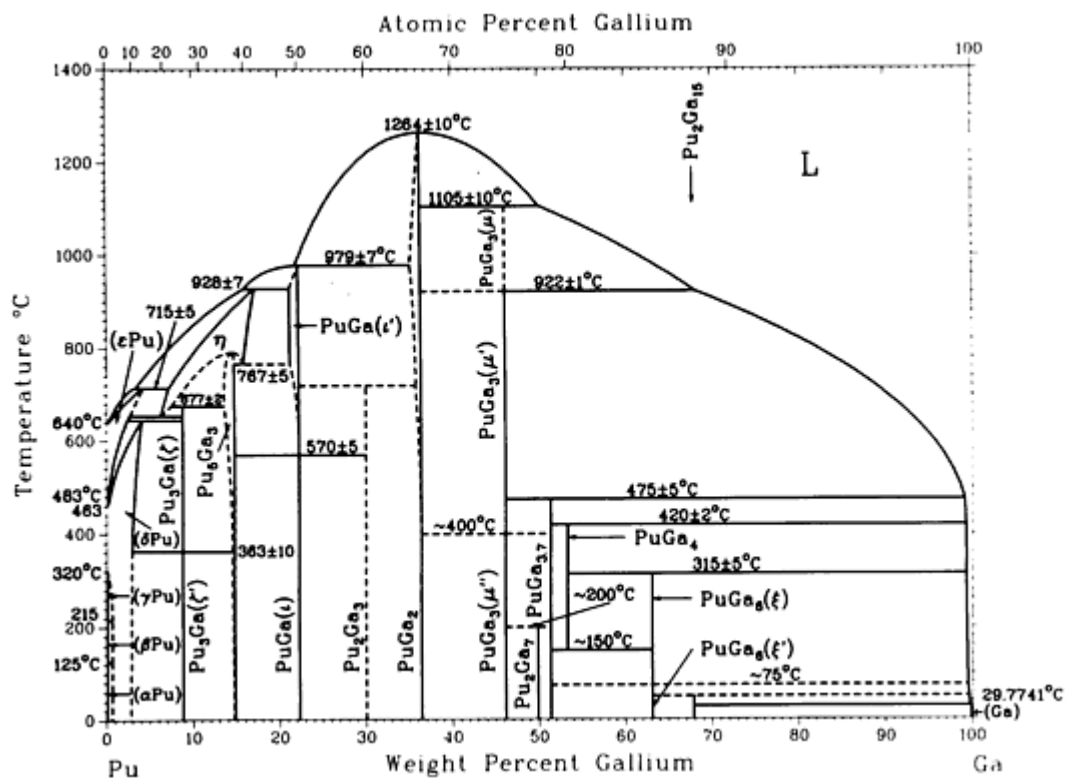

Ga-Pu phase diagram

Ga-Pu crystallographic data

Phase	Composition, wt% Ga	Pearson symbol	Space group
(ϵ Pu)	0 to 4	$cI2$	$Im\bar{3}m$
(δ' Pu)	0 to 0.07	$tI2$	$I4/mmm$
(δ Pu)	0 to 3.9	$cF4$	$Fm\bar{3}m$
(γ Pu)	0	$oF8$	$Fddd$
(β Pu)	0	$mC34$	$C2/m$
(α Pu)	0	$mP16$	$P2_1/m$
η	6.1 to 17	...	$I2_13^{(a)}$

$\text{Pu}_3\text{Ga}(\zeta)$	9	$cP4$	$Pm\bar{3}m$
$\text{Pu}_3\text{Ga}(\zeta')$	9	$tP4$	$P4/mmm$
Pu_5Ga_3	14 to 14.6	$tI38$ (b)	$I4/mcm$...
$\text{PuGa}(L')$	~ 22.2	$cI2$ (c)	$Im\bar{3}m$ $I4/mmm$
$\text{PuGa}(L)$	22.2	(d)	$I4mm$
Pu_2Ga_3	30	(e)	...
PuGa_2	36.4	$hP3$	$P6/mmm$
$\text{PuGa}_3(\mu)$	46
$\text{PuGa}_3(\mu')$	46	$hP8$	$P6_3/mmc$
$\text{PuGa}_3(\mu'')$	46	...	$R\bar{3}m$
Pu_2Ga_7	50.0	(c)	...
$\text{PuGa}_{3,7}$	51.4
PuGa_4	53	$oI20$	$Imma$
$\text{PuGa}_6(\xi)$	63.1	...	$P4/nbm$ $P4/mbm$
$\text{PuGa}_6(\xi')$	63.1
$\text{Pu}_2\text{Ga}_{15}$	68.1	(c)	...
(Ga)	100	$oC8$	$Cmca$

(a) Partially ordered.

(b) Face-centered cubic.

(c) Tetragonal.

(d) Body-centered tetragonal.

(e) Hexagonal

Ga-S (Gallium - Sulfur)

P.G. Rustamov, B.N. Mardakhaev, and M.G. Safarov, 1967

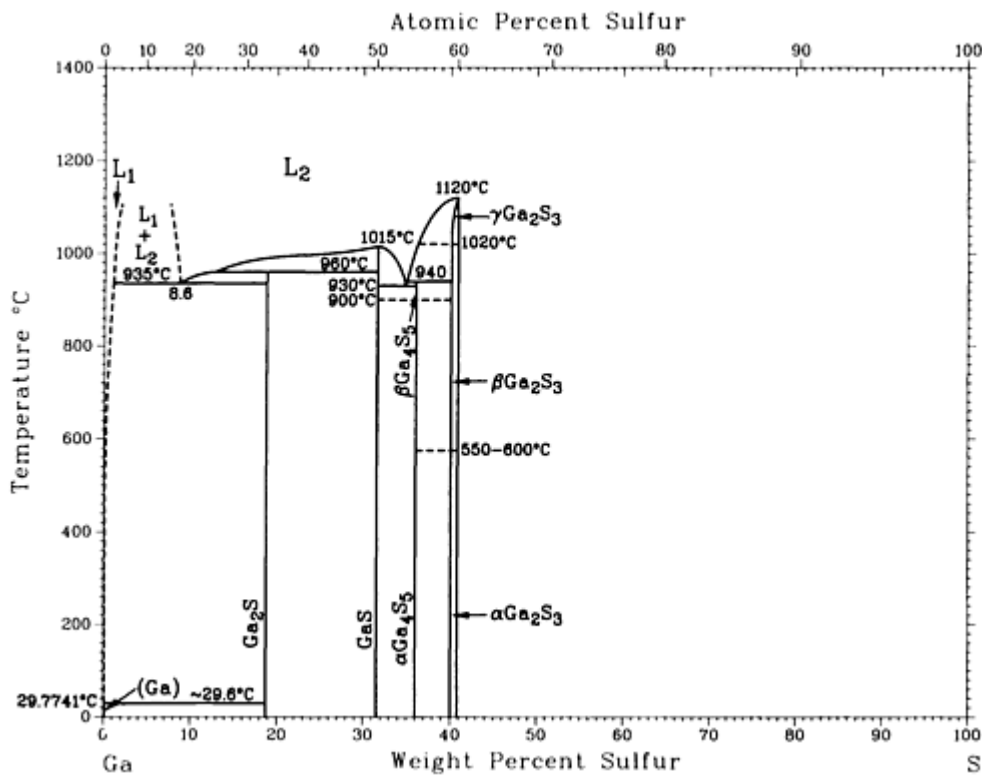

Ga-S phase diagram

Ga-S crystallographic data

Phase	Composition, wt% S	Pearson symbol	Space group
(Ga)	0	<i>oC8</i>	<i>Cmca</i>
Ga ₂ S	18.7
GaS	31.5	<i>hP8</i>	<i>P6₃/mmc</i>

β Ga ₄ S ₅	36.5
α Ga ₄ S ₅	36.5
γ Ga ₂ S ₃	41	<i>hP4</i>	<i>P6₃mc</i>
β Ga ₂ S ₃	41	<i>mC20</i>	<i>Cc</i>
α Ga ₂ S ₃	41	<i>cF8</i>	<i>F$\bar{4}$3m</i>

Ga-Sb (Gallium - Antimony)

T.I. Ngai, R.C. Sharma, and Y.A. Chang, 1988

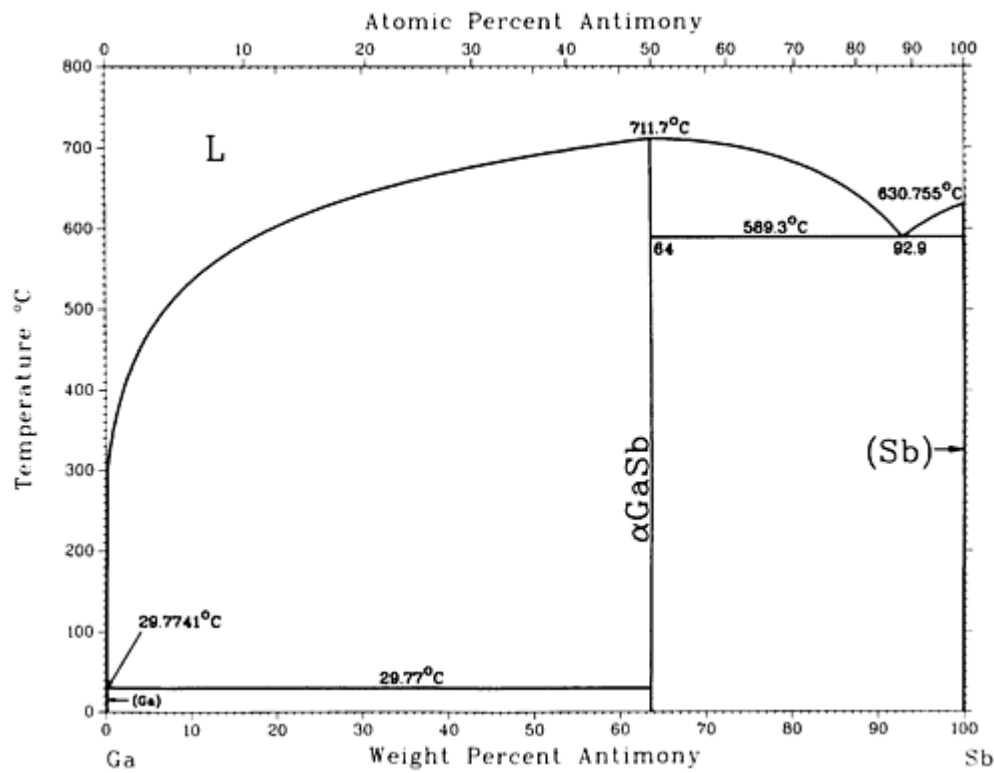

Ga-Sb phase diagram

Ga-Sb crystallographic data

Phase	Composition, wt% Sb	Pearson symbol	Space group
(Ga)	0	<i>oC8</i>	<i>Cmca</i>

α GaSb	63.6	$cF8$	$F4\bar{3}m$
β GaSb ^(a)	63.6	$tI4$	$I4_1/amd$
(Sb)	100	$hR2$	$R\bar{3}m$

(a) At high pressure

Ga-Sc (Gallium - Scandium)

S.P. Yatsenko, A.A. Semyannikov, G.B. Semenov, and K.A. Chuntunov, 1979

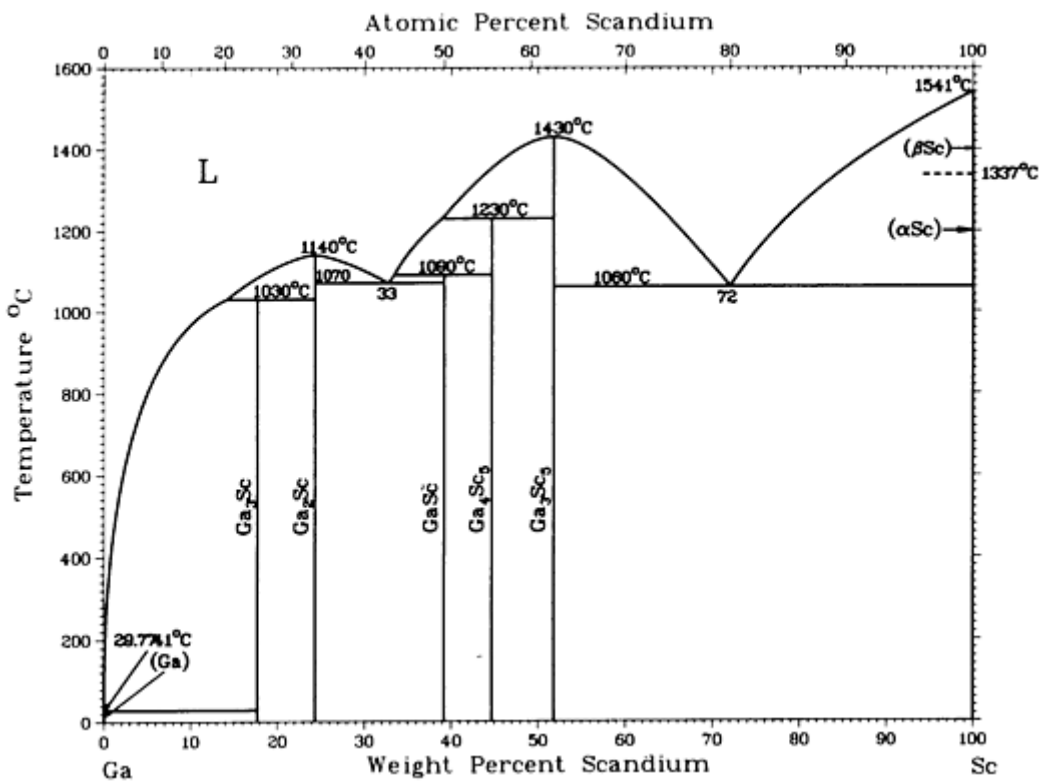

Ga-Sc phase diagram

Ga-Sc crystallographic data

Phase	Composition, wt% Sc	Pearson symbol	Space group
(Ga)	0	$oC8$	$Cmca$
Ga ₃ Sc	18	$cP4$	$Pm\bar{3}m$

Ga_2Se	24.4	$oI12$	$Imma$
GaSe	39.2	$oC8$	$Cmcm$
Ga_4Se_5	44.7	$tI84$	$I4/mmm$
Ga_3Se_5	51.8	$hP16$	$P6_3/mcm$
(βSe)	100	$cI2$	$Im\bar{3}m$
(αSe)	100	$hP2$	$P6_3/mmc$
Other reported phase			
Ga_3Se_2	30	$oP32$	$Pnma$

Ga-Se (Gallium - Selenium)

From [Moffatt] 11

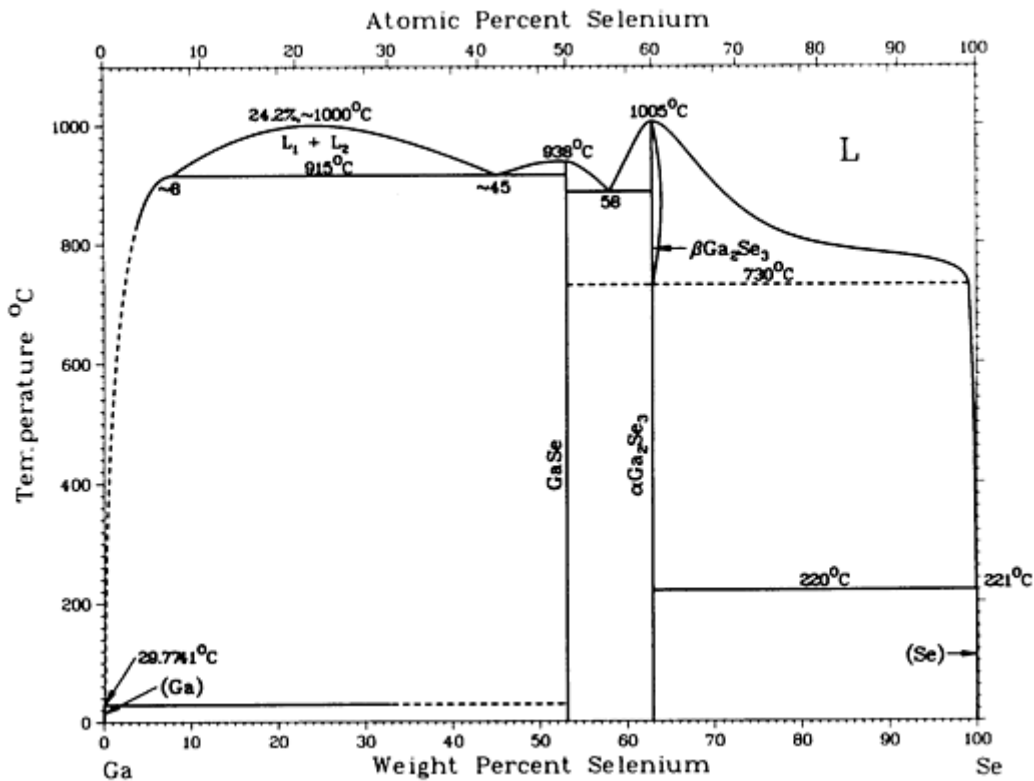

Ga-Se phase diagram

Ga-Se crystallographic data

Phase	Composition, wt% Se	Pearson symbol	Space group
(Ga)	0	<i>oC8</i>	<i>Cmca</i>
GaSe	53.1	<i>hR4</i> <i>hP8</i> <i>hP16</i>	$R\bar{3}m$ $P\bar{6}$ <i>P6₃mc</i>
β -Ga ₂ Se ₃	~63	<i>c**</i>	...
α -Ga ₂ Se ₃	63	<i>mC20</i>	<i>Cc</i>
(Se)	100	<i>hP3</i>	<i>P3₁21</i>

Reference cited in this section

- [Moffatt]: W.G. Moffatt, Ed., *Handbook of Binary Phase Diagrams*, Business Growth Services, General Electric Co., Schenectady, NY (1976).

Ga-Sm (Gallium - Samarium)

From [Moffatt] 11

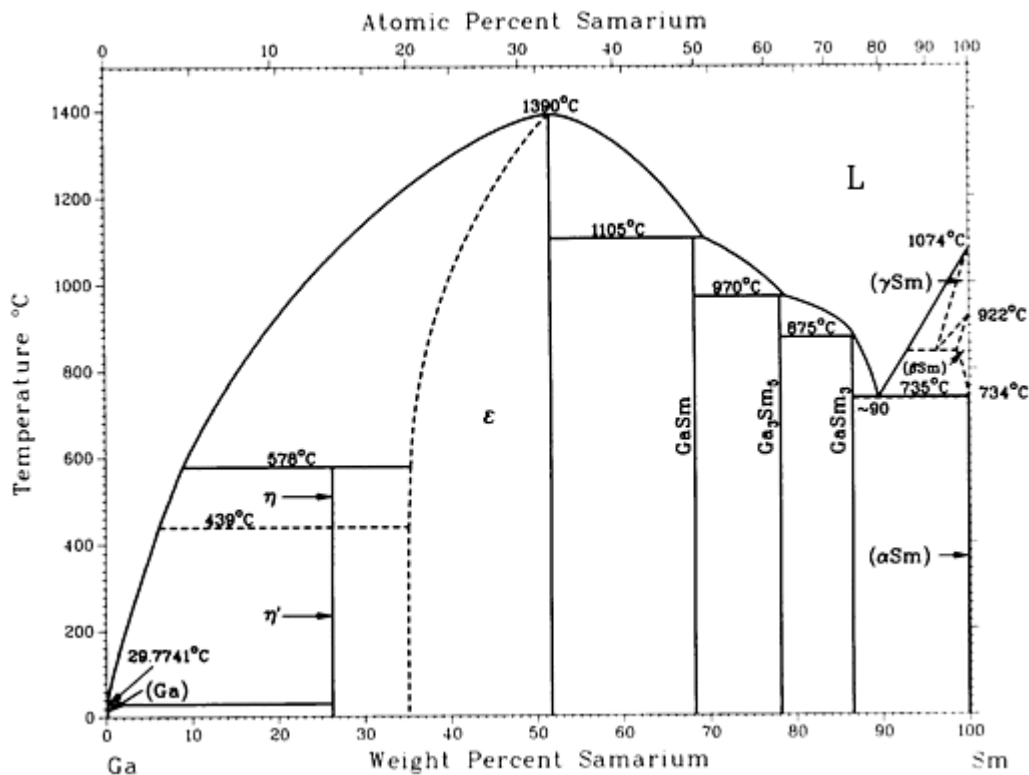

Ga-Sm phase diagram

Ga-Sm crystallographic data

Phase	Composition, wt% Sm	Pearson symbol	Space group
(Ga)	0	<i>oC8</i>	<i>Cmca</i>
β -Ga ₆ Sm(η)	26.5
α -Ga ₆ Sm(η')	26.5	<i>tP14</i>	<i>P4/nbm</i>
Ga ₂ Sm(ϵ)	~35 to 51.8	<i>hP3</i>	<i>P6/mmm</i>
GaSm	68.3	<i>oC8</i>	<i>Cmcm</i>
Ga ₃ Sm ₅	78.2	<i>tI32</i>	<i>I4/mcm</i>
GaSm ₃	87	<i>cP4</i>	<i>Pm$\bar{3}$m</i>

(γ Sm)	? to 100	<i>cI2</i>	$Im\bar{3}m$
(β Sm)	? to 100	<i>hP2</i>	$P6_3/mmc$
(α Sm)	100	<i>hR3</i>	$R\bar{3}m$

Reference cited in this section

11. [Moffatt]: W.G. Moffatt, Ed., *Handbook of Binary Phase Diagrams*, Business Growth Services, General Electric Co., Schenectady, NY (1976).

Ga-Sn (Gallium - Tin)

T.J. Anderson and I. Ansara, 1992

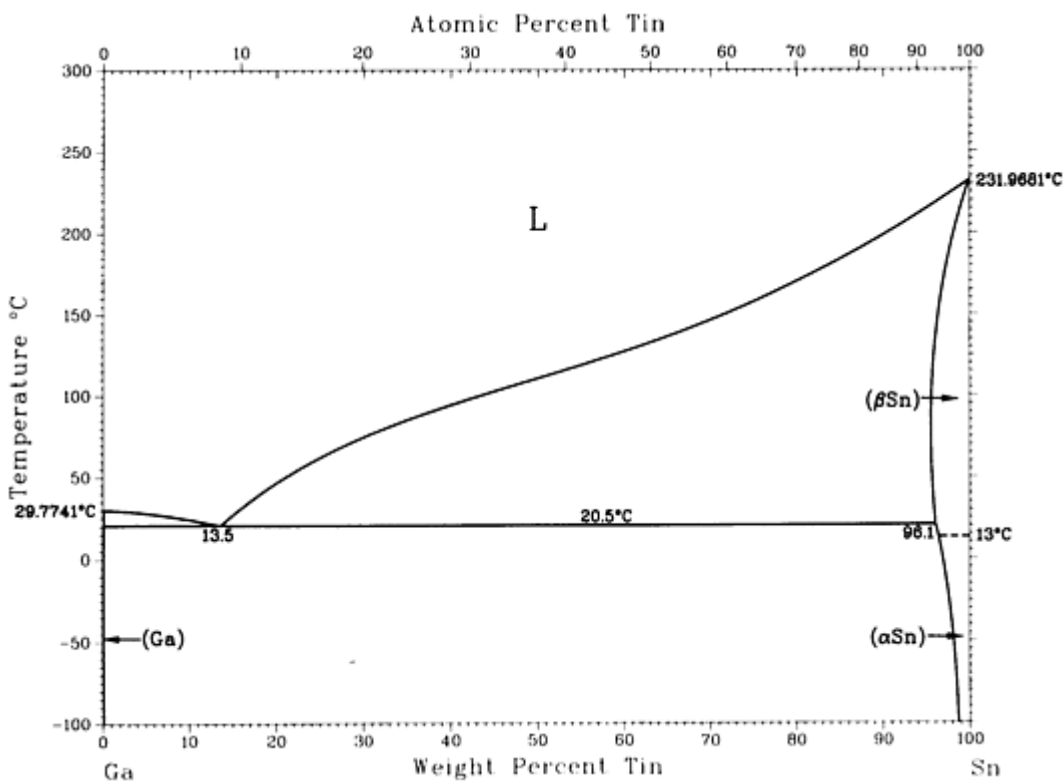

Ga-Sn phase diagram

Ga-Sn crystallographic data

Phase	Composition, wt% Sn	Pearson symbol	Space group
(α Ga)	0	<i>oC8</i>	<i>Cmca</i>

$(\beta_{\text{Ga}})^{(a)}$	0 to 0.03	<i>tI2</i>	<i>I4/mmm</i>
(β_{Sn})	96.1 to 100	<i>tI4</i>	<i>I4₁/amd</i>

(a) Above 1.2 GPa

Ga-Sr (Gallium - Strontium)

V.P. Itkin and C.B. Alcock, 1992

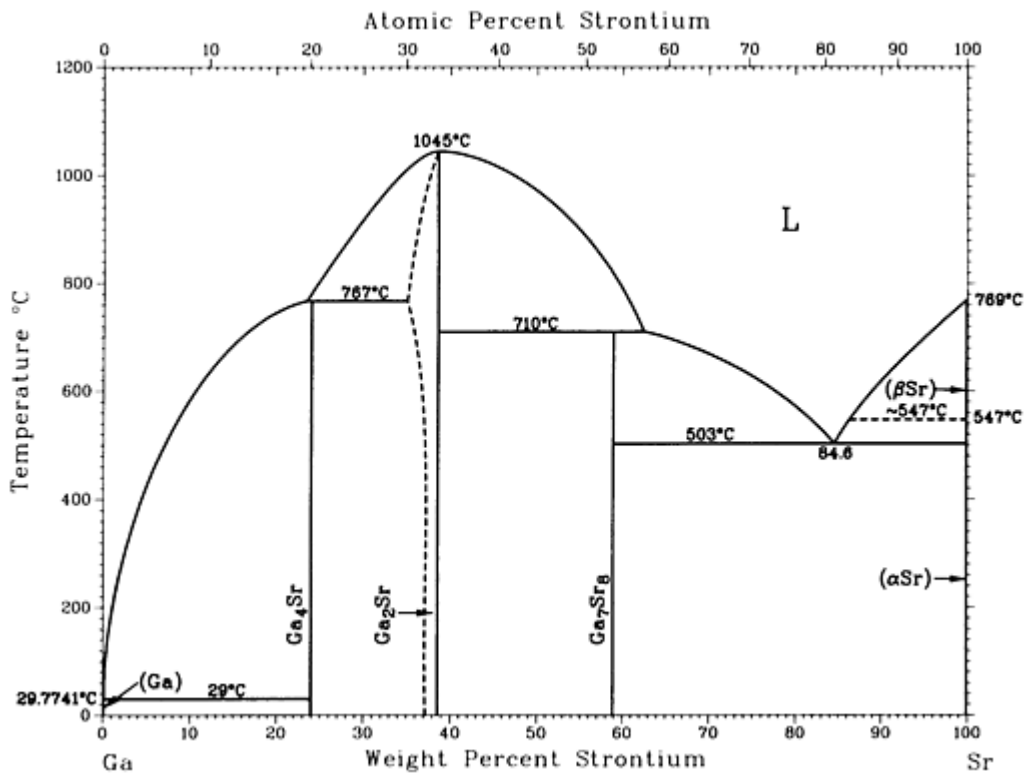

Ga-Sr phase diagram

Ga-Sr crystallographic data

Phase	Composition, wt% Sr	Pearson symbol	Space group
(Ga)	0	<i>hP2</i>	<i>P6₃/mmc</i>
Ga ₄ Sr	24	<i>tI10</i>	<i>I4/mmm</i>
Ga ₂ Sr	35 to 38.6 ^(a)	<i>hP3</i>	<i>P6/mmm</i>

Ga_7Sr_8	58.9	$cP60$	$P2_13$
(αSr)	100	$cF4$	$Fm\bar{3}m$
(βSr)	100	$cI2$	$Im\bar{3}m$

(a) After annealing at 900 °C

Ga-Tb (Gallium - Terbium)

From [Moffatt] 11

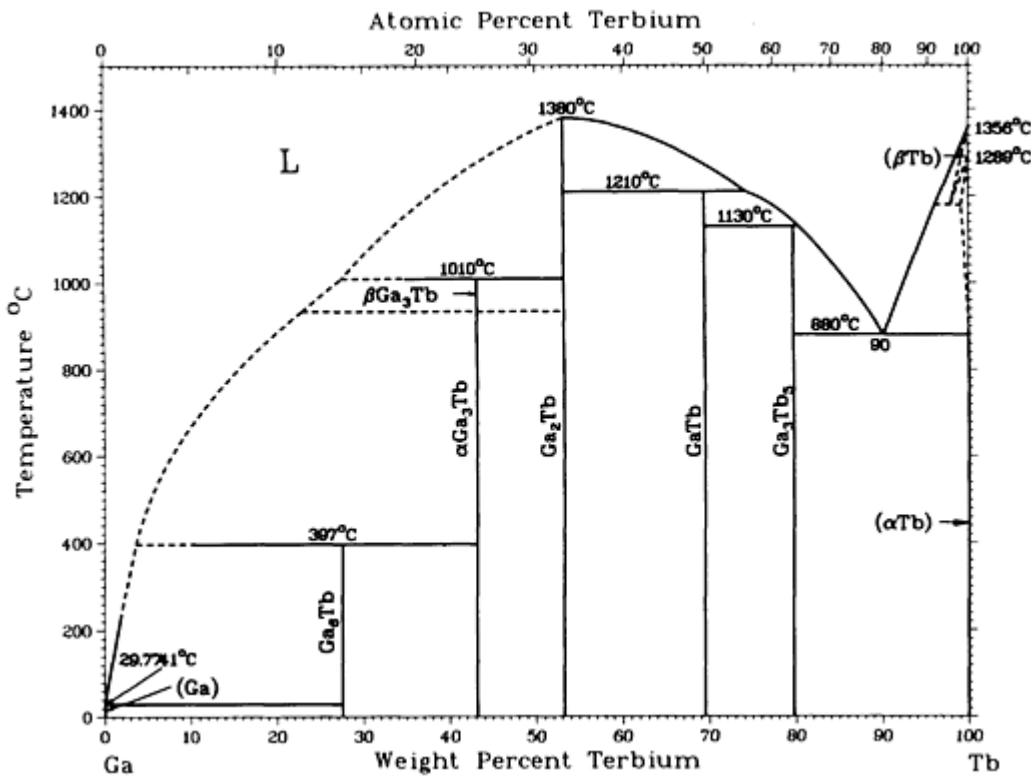

Ga-Tb phase diagram

Ga-Tb crystallographic data

Phase	Composition, wt% Tb	Pearson symbol	Space group
(Ga)	0	$oC8$	$Cmca$
Ga_6Tb	27.6	$tP14$	$P4/nbm$

β Ga ₃ Tb	43	cP4	$Pm\bar{3}m$
α Ga ₃ Tb	43	hP8	$P6_3/mmc$
Ga ₂ Tb	53.2	hP3	$P6/mmm$
GaTb	69.5	oC8	$Cmcm$
Ga ₃ Tb ₅	79.2	tI32	$I4/mcm$
(β Tb)	? to 100	cI2	$Im\bar{3}m$
(α Tb)	? to 100	hP2	$P6_3/mmc$

Reference cited in this section

- [Moffatt]: W.G. Moffatt, Ed., *Handbook of Binary Phase Diagrams*, Business Growth Services, General Electric Co., Schenectady, NY (1976).

Ga-Te (Gallium - Tellurium)

U.R. Kattner, unpublished

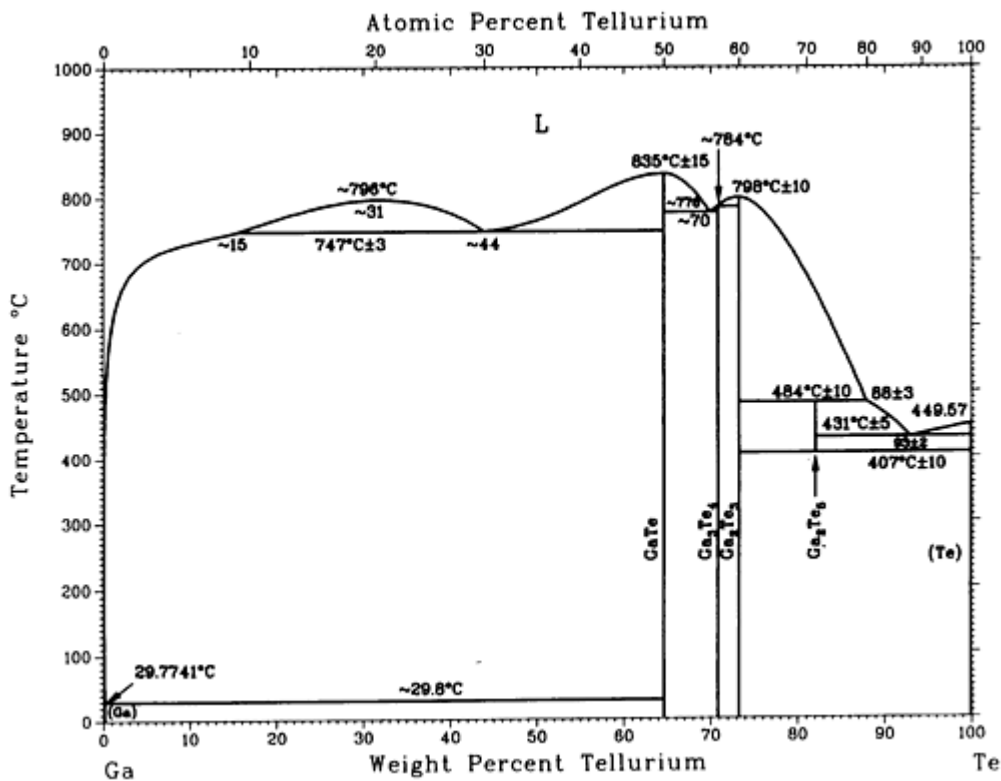

Ga-Te phase diagram

Ga-Te crystallographic data

Phase	Composition, wt% Te	Pearson symbol	Space group
(Ga)	0	<i>oC8</i>	<i>Cmca</i>
GaTe	64.7	<i>mC24</i>	<i>C2/m</i>
Ga₃Te₄	70.9	<i>hP*</i>	...
Ga₂Te₃	73	<i>cF8</i>	<i>F$\bar{4}3m$</i>
Ga₂Te₅	82.1	<i>tI14</i>	<i>I4/m</i>
(Te)	100	<i>hP3</i>	<i>P3₁21</i>
Metastable (thin film)			
GaTe	64.7	<i>hP8</i>	<i>P6₃/mmc</i>

Ga-Tl (Gallium - Thallium)

J. Klingbeil and R. Schmid-Fetzer, 1991

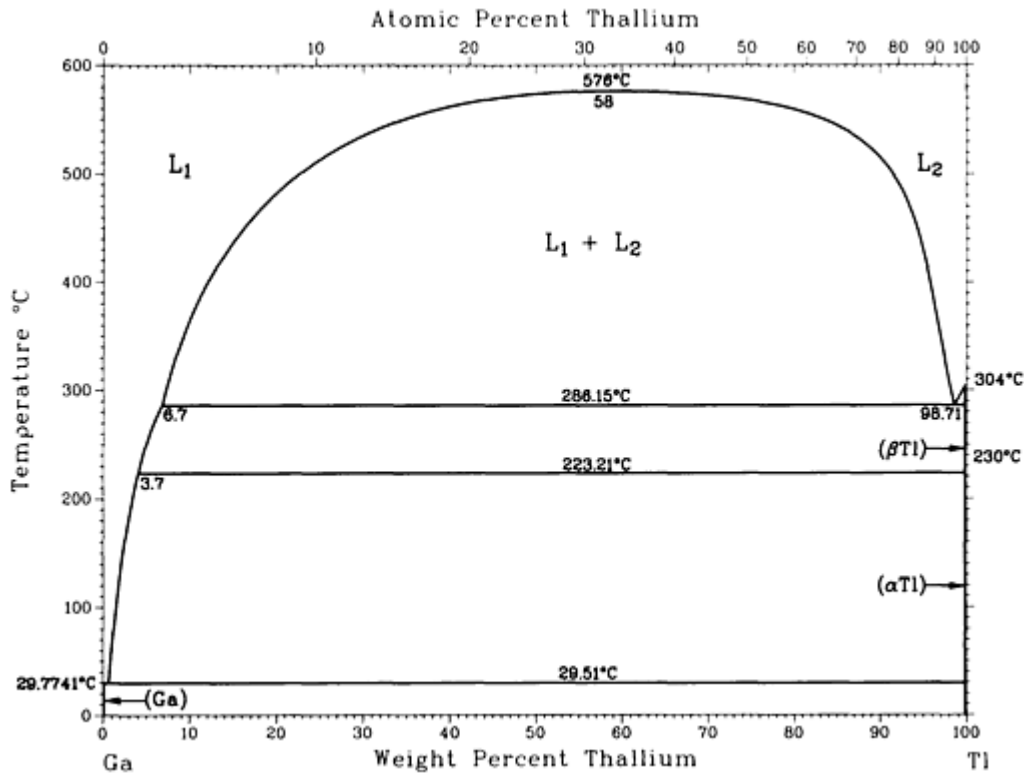

Ga-Tl phase diagram

Ga-Tl crystallographic data

Phase	Composition, wt% Tl	Pearson symbol	Space group
(Ga)	0	<i>oC</i>	<i>Cmca</i>
(αTl)	100	<i>hP2</i>	<i>P6₃/mmc</i>
(βTl)	100	<i>cI2</i>	<i>Im$\bar{3}m$</i>

Ga-Tm (Gallium - Thulium)

From [Moffatt] 11

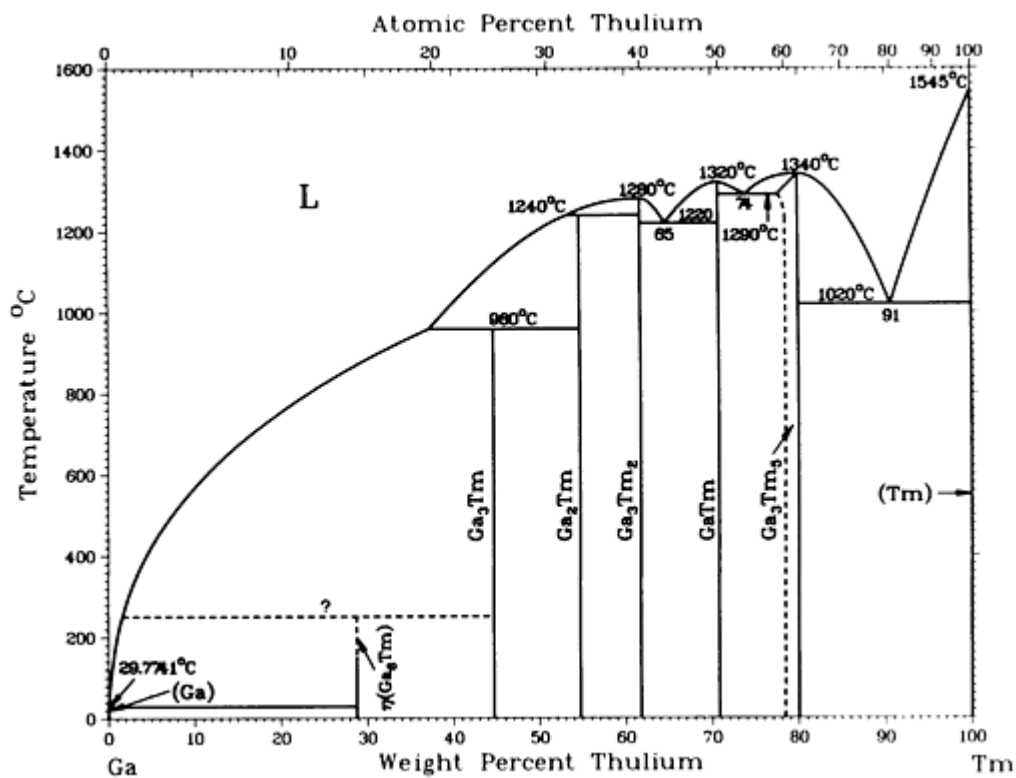

Ga-Tm phase diagram

Ga-Tm crystallographic data

Phase	Composition, wt% Tm	Pearson symbol	Space group
(Ga)	0	<i>oC8</i>	<i>Cmca</i>
Ga ₆ Tm	28.8	<i>tP14</i>	<i>P4/nbm</i>
Ga ₃ Tm	45	<i>cP4</i>	<i>Pm$\bar{3}m$</i>
Ga ₂ Tm	54.7	<i>oI12</i>	<i>Imma</i>
Ga ₃ Tm ₂	62
GaTm	70.8	<i>oC8</i>	<i>Cmcm</i>
Ga ₃ Tm ₅	? to 80.2	<i>oP32</i>	<i>Pnma</i>

(Tm) 100 hP2 P6₃/mmc

Reference cited in this section

11. [Moffatt]: W.G. Moffatt, Ed., *Handbook of Binary Phase Diagrams*, Business Growth Services, General Electric Co., Schenectady, NY (1976).

Ga-U (Gallium - Uranium)

K.H.J. Buschow, 1973

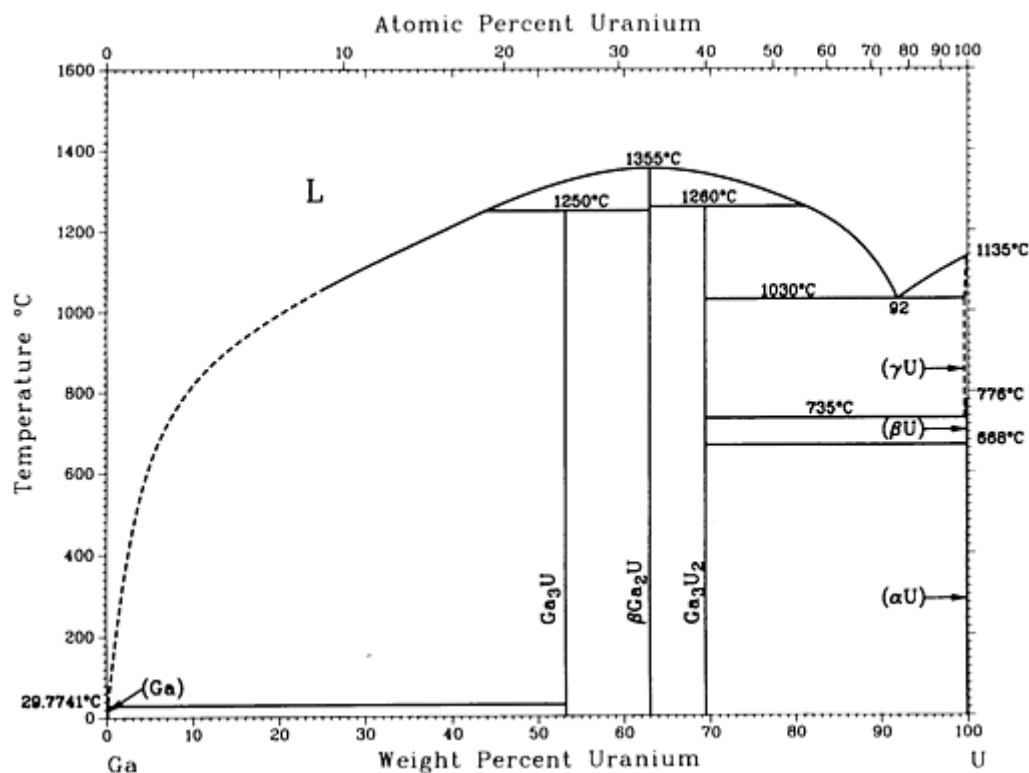

Ga-U phase diagram

Ga-U crystallographic data

Phase	Composition, wt% U	Pearson symbol	Space group
(Ga)	0	<i>oC8</i>	<i>Cmca</i>
Ga ₃ U	53	<i>cP4</i>	<i>Pm</i> $\bar{3}$ <i>m</i>
βGa ₂ U	63.0	<i>hP3</i>	<i>P6/mmm</i>

$\alpha\text{Ga}_2\text{U}^{(a)}$	63.0	oC^*	$Cmmm$
Ga_3U_2	70	$oC32$	$Cmcm$
(γU)	? to 100	$cI2$	$Im\bar{3}m$
(βU)	100	$tP30$	PA_2/mnm
(αU)	100	$oC4$	$Cmcm$

(a) Below the Curie temperature (-148 °C)

Ga-V (Gallium - Vanadium)

J.F. Smith, 1989

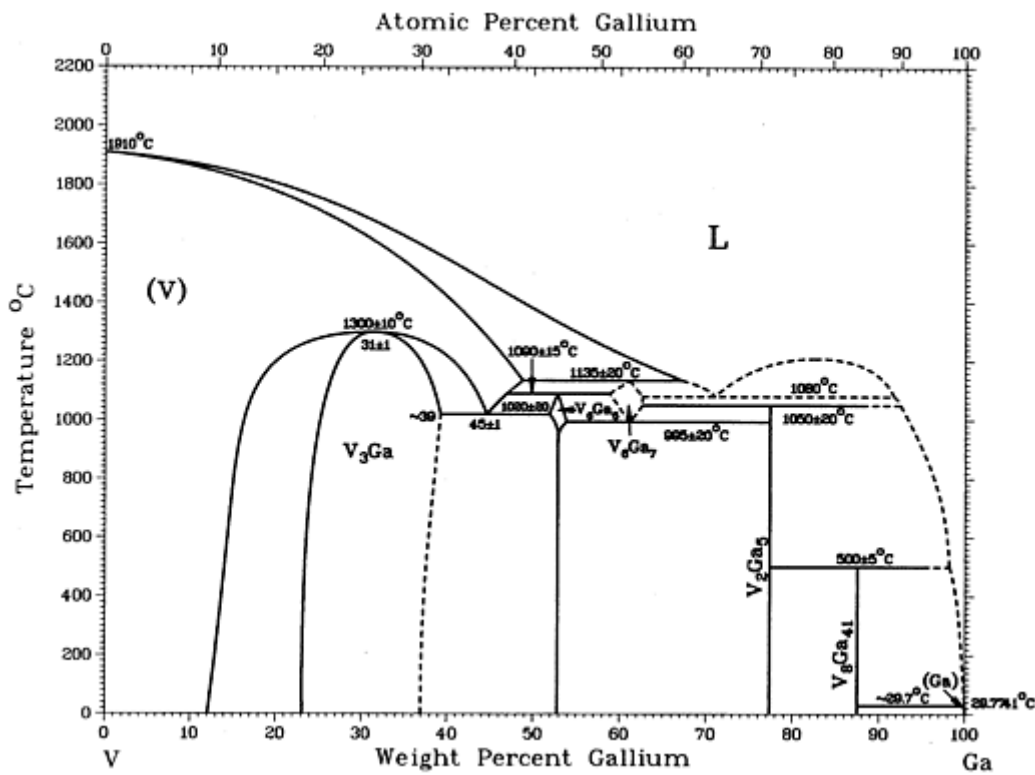

Ga-V phase diagram

Ga-V crystallographic data

Phase	Composition, wt% Ga	Pearson symbol	Space group
-------	---------------------	----------------	-------------

(V)	0 to 49	<i>cI2</i>	$Im\bar{3}m$
V ₃ Ga	~23 to ~39	<i>cP8</i>	$Pm\bar{3}n$
V ₆ Ga ₅	~53.3	<i>hP22</i>	...
V ₆ Ga ₇	~59 to ~63	<i>cI52</i>	$I\bar{4}3m$
V ₂ Ga ₅	77.4	<i>tP14</i>	...
V ₈ Ga ₄₁	87.5	<i>hR49</i>	...
(Ga)	100	<i>oC8</i>	<i>Cmca</i>

Ga-Y (Gallium - Yttrium)

S.P. Yatsenko, 1977

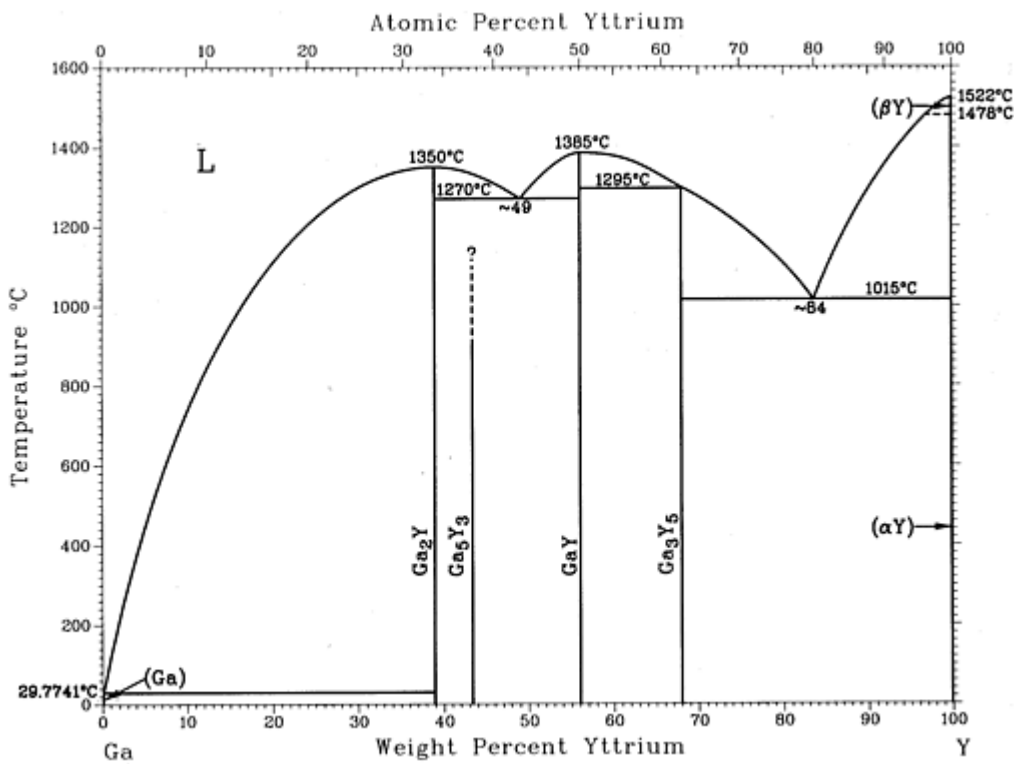

Ga-Y phase diagram

Ga-Y crystallographic data

Phase	Composition, wt% Y	Pearson symbol	Space group
(Ga)	0	<i>oC8</i>	<i>Cmca</i>
Ga ₂ Y	38.9
Ga ₅ Y ₃	43.3	<i>oP32</i>	<i>Pnma</i>
GaY	56.0	<i>oC8</i>	<i>Cmcm</i>
Ga ₃ Y ₅	68.0	<i>hP16</i>	<i>P6₃/mcm</i>
(βY)	100	<i>cI2</i>	<i>Im$\bar{3}m$</i>
(αY)	100	<i>hP2</i>	<i>P6₃/mmc</i>

Ga-Yb (Gallium - Ytterbium)

A. Palenzona and S. Cirafici, 1992

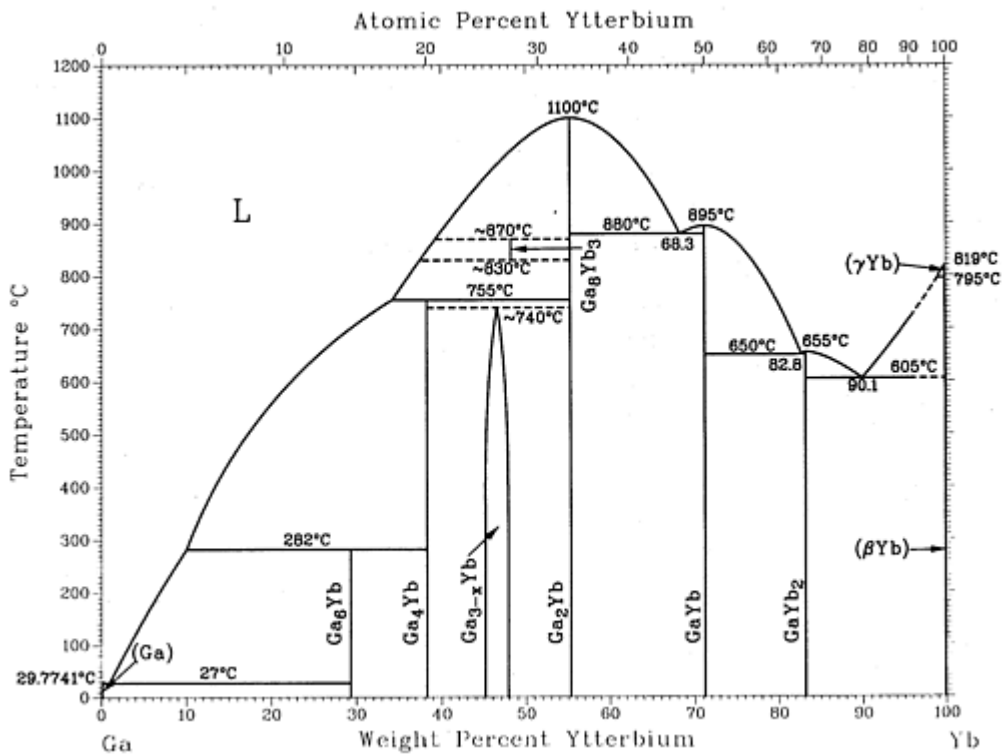

Ga-Yb phase diagram

Ga-Yb crystallographic data

Phase	Composition, wt% Yb	Pearson symbol	Space group
(α Ga)	~ 0	<i>oC8</i>	<i>Cmca</i>
Ga₆Yb	29.3	<i>tP14</i>	<i>P4/nbm</i>
Ga₄Yb	38	<i>mC10</i>	<i>C2/m</i>
Ga_{3-x}Yb^(a)	45 to 48.5	<i>hP54.3</i>	<i>P6/mmm</i>
Ga₈Yb₃	48.2	<i>oI22</i>	<i>Immm</i>
Ga₂Yb	55.3	<i>hP6</i>	<i>P6₃/mmc</i>
GaYb	71.3	<i>tP4</i>	<i>P4/mmm</i>
GaYb₂	83.3	<i>oP12</i>	<i>Pnma</i>
(γ Yb)	~ 100	<i>cI2</i>	<i>Im$\bar{3}m$</i>
(β Yb)	~ 100	<i>cF4</i>	<i>Fm$\bar{3}m$</i>
(α Yb)	~ 100	<i>hP2</i>	<i>P6₃/mmc</i>

(a) $0 \leq x \leq 0.36$

Ga-Zn (Gallium - Zinc)

J. Dutkiewicz, Z. Moser, L. Zabdyr, D.D. Gohil, T.G. Chart, I. Ansara, and C. Girard, 1990

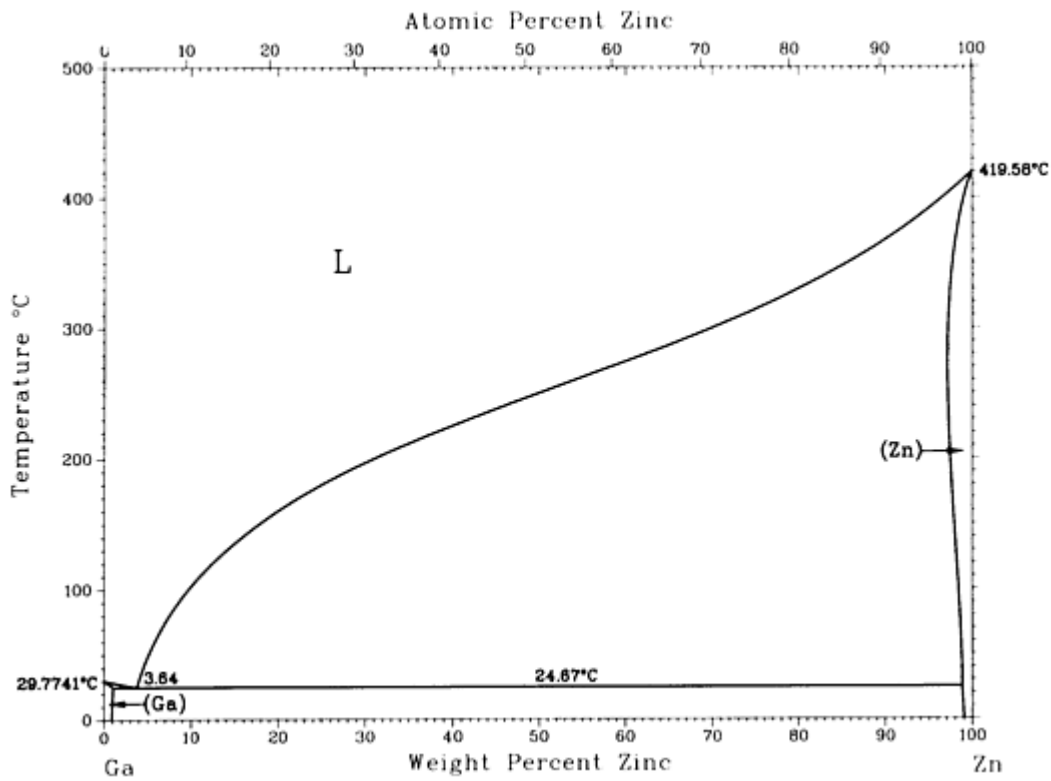

Ga-Zn phase diagram

Ga-Zn crystallographic data

Phase	Composition, wt% Zn	Pearson symbol	Space group
(Ga)	0 to 0.75	<i>oC8</i>	<i>Cmca</i>
(Zn)	97.49 to 100	<i>hP2</i>	<i>P6₃/mmc</i>

Ga-Zr (Gallium - Zirconium)

From [Shunk] 17

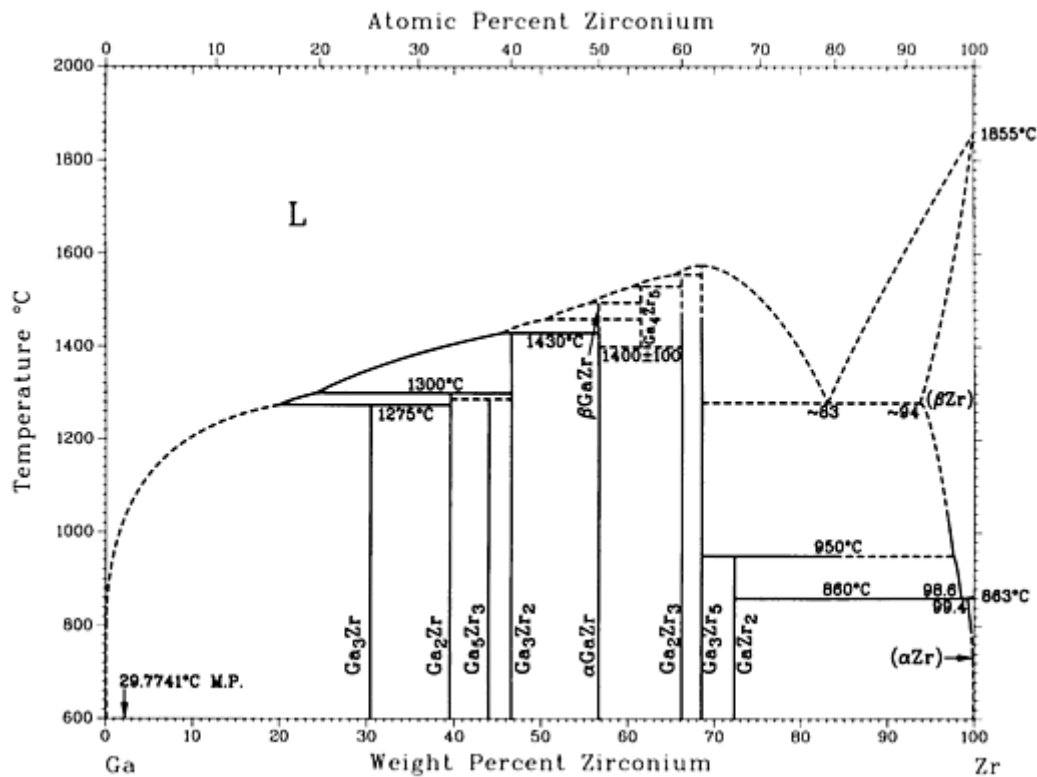

Ga-Zr phase diagram

Ga-Zr crystallographic data

Phase	Composition, wt% Zr	Pearson symbol	Space group
(Ga)	0	<i>oC8</i>	<i>Cmca</i>
Ga₃Zr	30	<i>tI16</i>	<i>I4/mmm</i>
Ga₂Zr	39.5	<i>oC12</i>	<i>Cmmm</i>
Ga₅Zr₃	44.0	<i>oC32</i>	<i>Cmcm</i>
Ga₃Zr₂	47	<i>oF40</i>	<i>Fdd2</i>
β_{GaZr}	56.7
α_{GaZr}	56.7	<i>tI16</i>	<i>I4₁/amd</i>

Ga_4Zr_5	62.1	<i>hP18</i>	<i>P6_3/mcm</i>
Ga_2Zr_3	66	<i>tP10</i>	<i>P4/mbm</i>
Ga_3Zr_5	68.6	<i>hP16</i>	<i>P6_3/mcm</i>
GaZr_2	72.4	<i>tI12</i>	<i>I4/mcm</i>
(βZr)	~94 to 100	<i>cI2</i>	<i>Im\bar{3}m</i>
(αZr)	99.4 to 100	<i>hP2</i>	<i>P6_3/mmc</i>

Reference cited in this section

17. [Shunk]: F.A. Shunk, *Constitution of Binary Alloys, Second Supplement*, McGraw-Hill, New York or General Electric Co., Business Growth Services, Schenectady, New York (1969).

Gd (Gadolinium) Binary Alloy Phase Diagrams

Introduction

THIS ARTICLE includes systems where gadolinium is the first-named element in the binary pair. Additional binary systems that include gadolinium are provided in the following locations in this Volume:

- “Ag-Gd (Silver - Gadolinium)” in the article “Ag (Silver) Binary Alloy Phase Diagrams.”
- “Al-Gd (Aluminum - Gadolinium)” in the article “Al (Aluminum) Binary Alloy Phase Diagrams.”
- “Cd-Gd (Cadmium - Gadolinium)” in the article “Cd (Cadmium) Binary Alloy Phase Diagrams.”
- “Cu-Gd (Copper - Gadolinium)” in the article “Cu (Copper) Binary Alloy Phase Diagrams.”
- “Fe-Gd (Iron - Gadolinium)” in the article “Fe (Iron) Binary Alloy Phase Diagrams.”
- “Ga-Gd (Gallium - Gadolinium)” in the article “Ga (Gallium) Binary Alloy Phase Diagrams.”

Gd-Ge (Gadolinium - Germanium)

A.B. Gokhale and G.J. Abbaschian, 1989

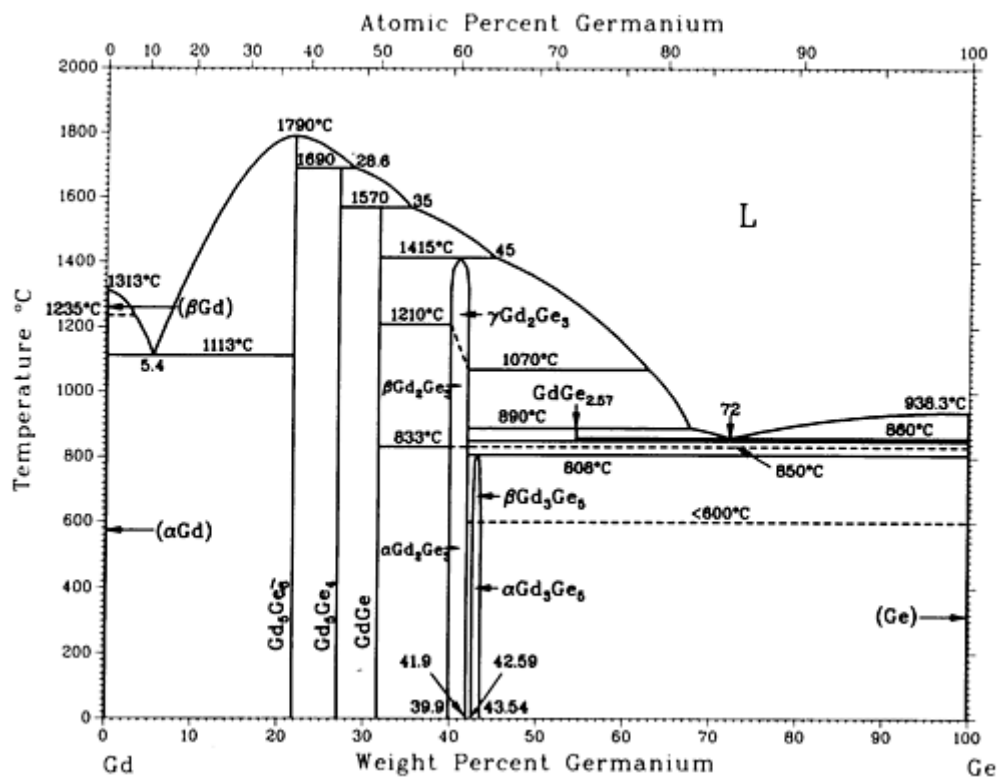

Gd-Ge phase diagram

Gd-Ge crystallographic data

Phase	Composition, wt% Ge	Pearson symbol	Space group
β Gd ^(a)	0	<i>cI2</i>	<i>Im</i> $\bar{3}m$
α Gd ^(b)	0	<i>hP2</i>	<i>P6</i> ₃ / <i>mmc</i>
Gd ₅ Ge ₃	21.7	<i>hP16</i>	<i>P6</i> ₃ / <i>mcm</i>
Gd ₅ Ge ₄	27.0	^(c)	<i>Pnma</i>
GdGe	31.6	<i>oC8</i>	<i>Cmcm</i>
γ Gd ₂ Ge ₃	40 to 42
β Gd ₂ Ge ₃	40 to 42

$\alpha\text{Gd}_2\text{Ge}_3$	40 to 42	<i>hP3</i>	<i>P6/mmm</i>
$\beta\text{Gd}_3\text{Ge}_5$ ^(d)	42.59 to 43.54	^(c)	<i>Imma</i>
$\alpha\text{Gd}_3\text{Ge}_5$	42.59 to 43.54	<i>tI12</i>	$\bar{1}4_1/amd$
$\text{GdGe}_{2.57}$	54	^(c)	<i>C222_1</i>
Ge	100	<i>cF8</i>	<i>Fd\bar{3}m</i>

(a) From 1313 to >1235 °C.

(b) From 1235 °C.

(c) Orthorhombic.

(d) Also designated "GdGe_{2-n}"

Gd-In (Gadolinium - Indium)

A. Palenzona and S. Cirafici, 1992

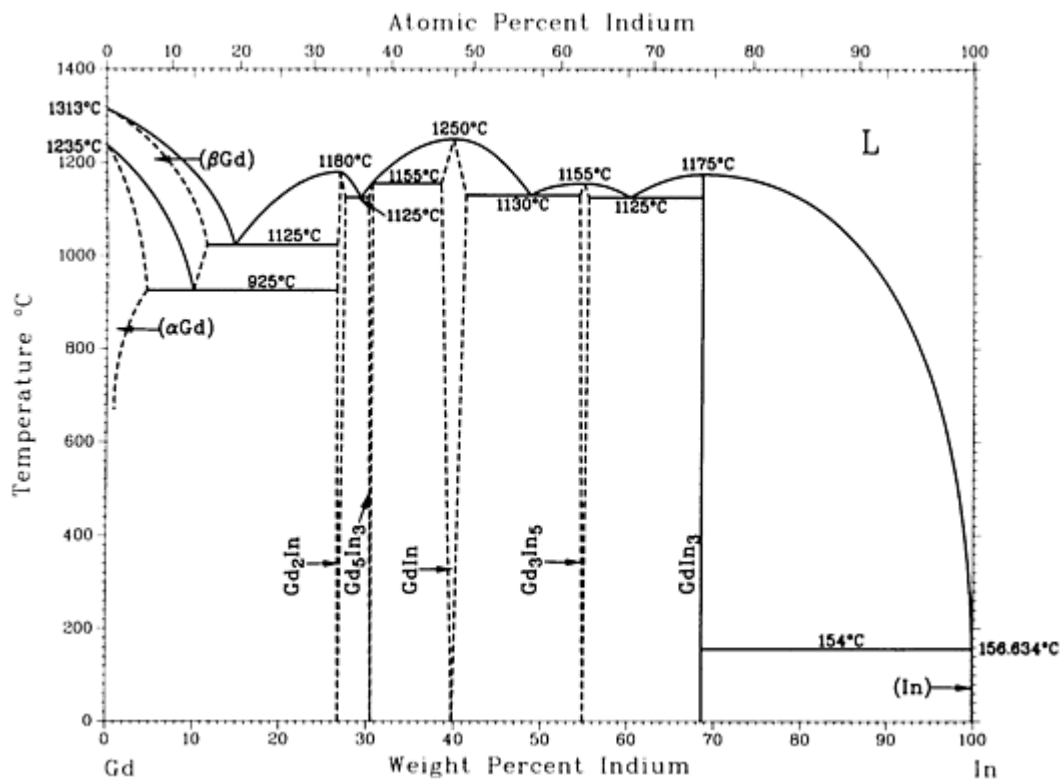

Gd-In phase diagram

Gd-In crystallographic data

Phase	Composition, wt% In	Pearson symbol	Space group
(βGd)	0 to ~11	<i>cI2</i>	<i>Im</i> $\bar{3}m$
(αGd)	0 to ~5	<i>hP2</i>	<i>P6₃/mmc</i>
Gd ₂ In	26.7 ± ~1	<i>hP6</i>	<i>P6₃/mmc</i>
Gd ₅ In ₃	30.5 ± ~1	<i>tI32</i>	<i>I4/mcm</i>
GdIn ^(a)	39 ± ~2	<i>cP2</i> or <i>cI2</i>	<i>Pm</i> $\bar{3}m$ or <i>Im</i> $\bar{3}m$
Gd ₃ In ₅	54.9 ± ~1	<i>oC32</i>	<i>Cmcm</i>
GdIn ₃	69	<i>cP4</i>	<i>Pm</i> $\bar{3}m$

(In) ~ 100 $iI2$ $I4/mmm$

(a) Possibly metastable

Gd-Mg (Gadolinium - Magnesium)

A.A. Nayeb-Hashemi and J.B. Clark, 1988

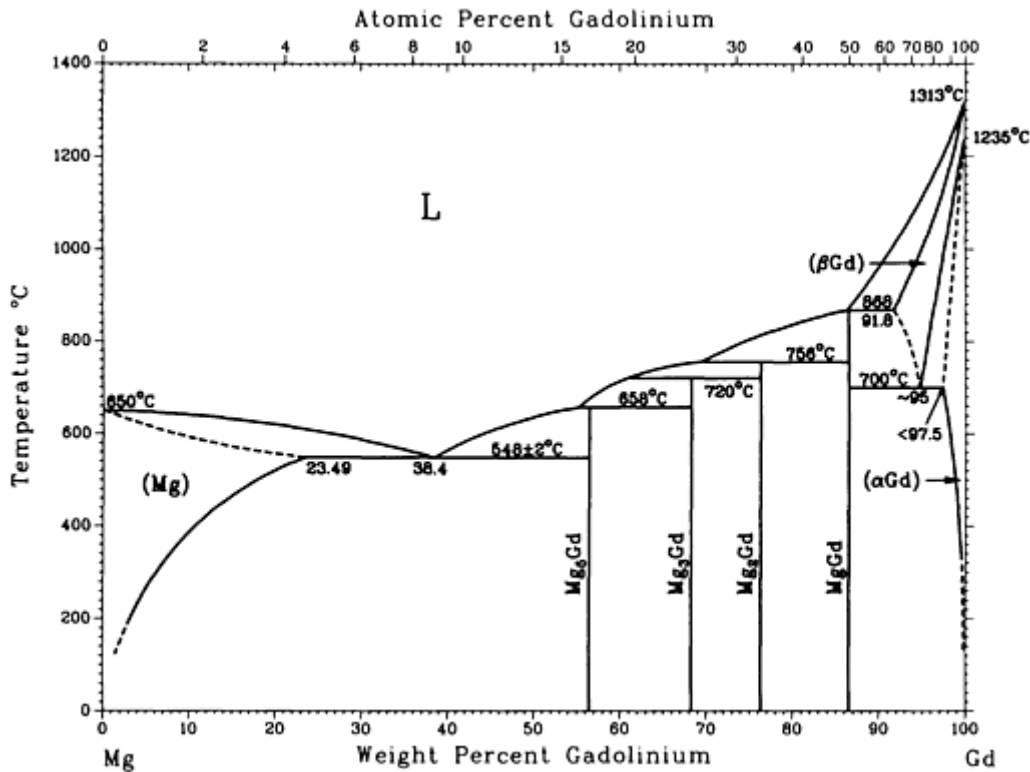

Gd-Mg phase diagram

Gd-Mg crystallographic data

Phase	Composition, wt% Gd	Pearson symbol	Space group
(Mg)	0 to 23.49	$hP2$	$P6_3/mmc$
Mg_5Gd	56.41 ^(a)	^(b)	$F\bar{4}3m$
Mg_3Gd	68	$cF16$	$Fm\bar{3}m$

Mg_2Gd	76.38	$cF24$	$Fd\bar{3}m$
MgGd	86.6	$cP2$	$Pm\bar{3}m$
(βGd)	? to 100	$cI2$	$Im\bar{3}m$
(αGd)	<97.5 to 100	$hP2$	$P6_3/mmc$

(a) There may be a small homogeneity range. The exact stoichiometry was reported as $\text{Mg}_{5.05}\text{Gd}$, closely related to that of $\text{Sm}_{11}\text{Cd}_{45}$.

(b) Cubic

Gd-Mn (Gadolinium - Manganese)

H. Okamoto, 1990

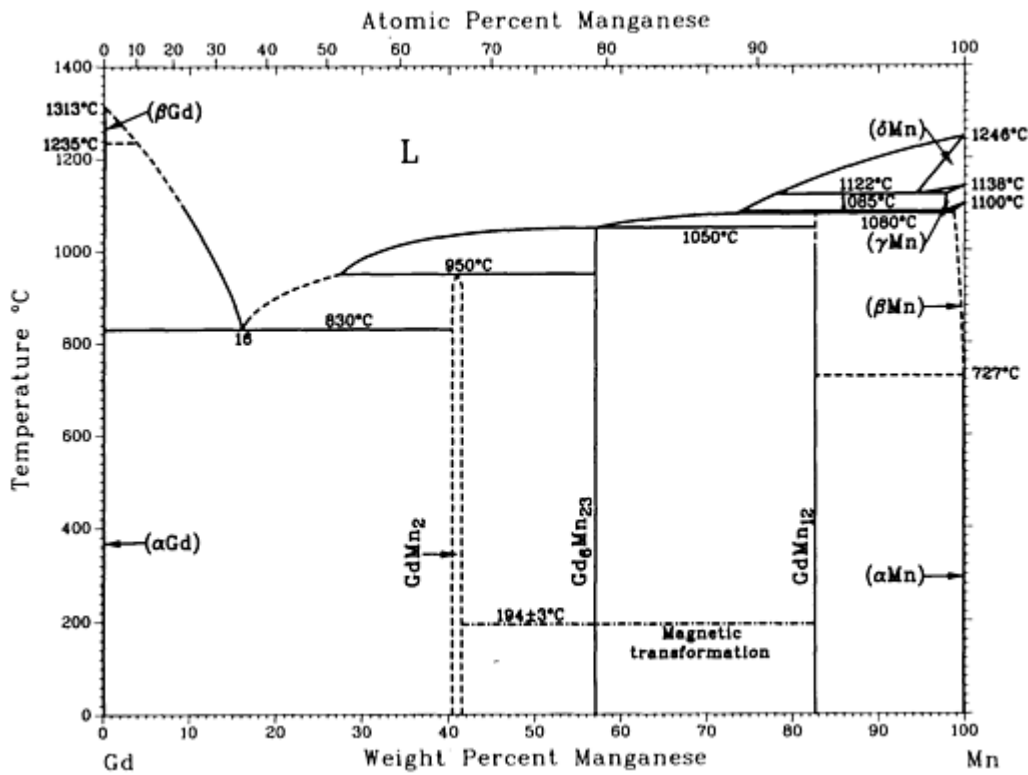

Gd-Mn phase diagram

Gd-Mn crystallographic data

Phase	Composition, wt% Mn	Pearson symbol	Space group
-------	---------------------	----------------	-------------

(βGd)	0	$cI2$	$Im\bar{3}m$
(αGd)	0	$hP2$	$P6_3/mmc$
GdMn_2	~ 41.2	$cF24$	$Fd\bar{3}m$
$\text{Gd}_6\text{Mn}_{23}$	57.2	$cF116$	$Fm\bar{3}m$
GdMn_{12}	80.7	$tI26$	$I4/mmm$
(δMn)	~ 95 to 100	$cI2$	$Im\bar{3}m$
(γMn)	~ 97 to 100	$cF4$	$Fm\bar{3}m$
(βMn)	~ 100	$cP20$	$P4_132$
(αMn)	100	$cI58$	$I\bar{4}3m$

Gd-Ni (Gadolinium - Nickel)

Y.Y. Pan and P. Nash, 1991

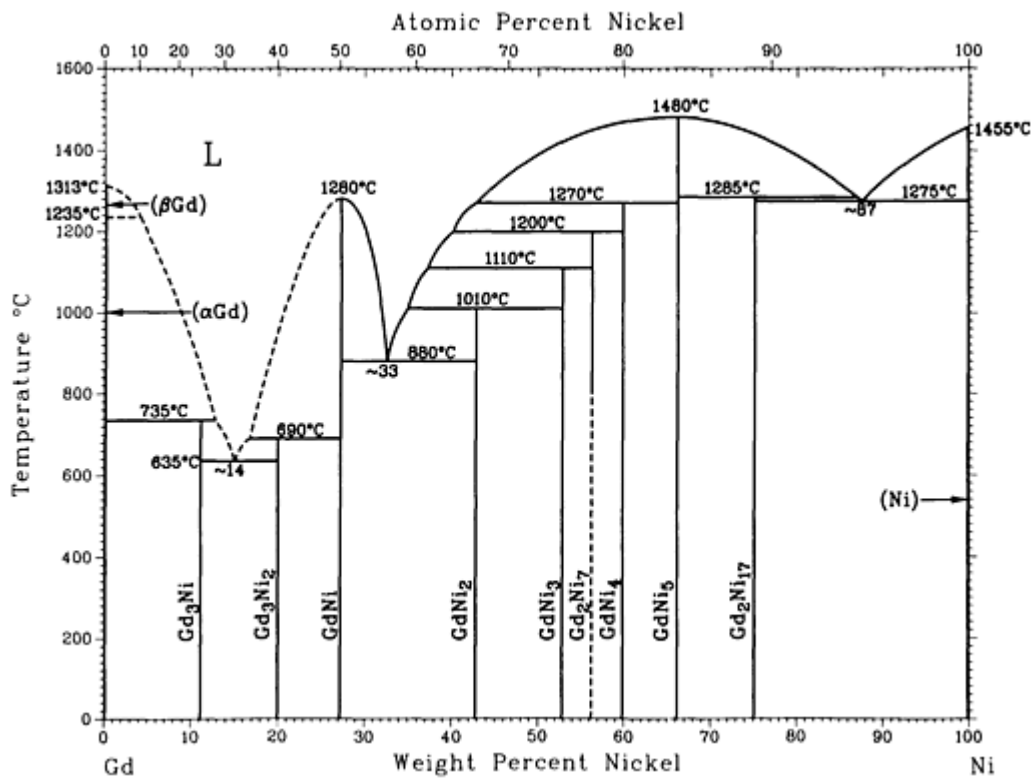

Gd-Ni phase diagram

Gd-Ni crystallographic data

Phase	Composition, wt% Ni	Pearson symbol	Space group
(β Gd)	0	<i>hP2</i>	<i>P6₃/mmc</i>
(α Gd)	0	<i>cI2</i>	<i>Im$\bar{3}m$</i>
Gd ₃ Ni	11.1	<i>oP16</i>	<i>P6/mmm</i>
Gd ₃ Ni ₂	19.9	<i>t**</i>	...
GdNi	27.2	<i>oC8</i>	<i>Cmcm</i>
GdNi ₂	42.8	<i>cF24</i>	<i>Fd$\bar{3}m$</i>
GdNi ₃	52.8	<i>hP24</i>	<i>R$\bar{3}m$</i>
Gd ₂ Ni ₇	56.7	<i>hP36^(a)</i> <i>hR54^(b)</i>	<i>P6₃/mmc</i> <i>R$\bar{3}m$</i>

GdNi_4	59.9	<i>hP6</i>	...
GdNi_5	65.1	<i>hP6</i>	<i>P6/mmm</i>
$\text{Gd}_2\text{Ni}_{17}$	76.1	<i>hP38</i>	<i>P6_3/mmc</i>
(Ni)	100	<i>cF4</i>	<i>Fm\bar{3}m</i>

(a) High-temperature form.

(b) Low-temperature form

Gd-Pb (Gadolinium - Lead)

A. Palenzona and S. Cirafici, 1991

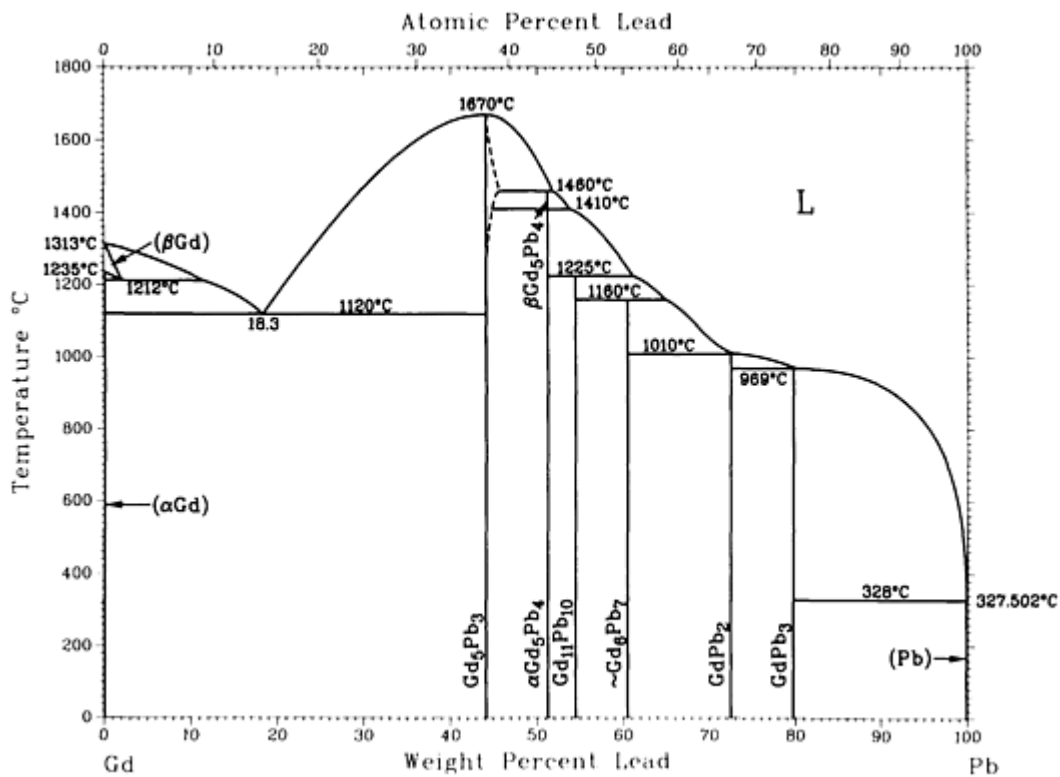

Gd-Pb phase diagram

Gd-Pb crystallographic data

Phase	Composition, wt% Pb	Pearson symbol	Space group
(β Gd)	0 to 3	<i>cI2</i>	$Im\bar{3}m$
(α Gd)	0 to 1	<i>hP2</i>	$P6_3/mmc$
Gd ₅ Pb ₃	44.2 to 46	<i>hP16</i>	$P6_3/mcm$
Gd ₅ Pb ₄	51.3	<i>oP36</i>	$Pnma$
Gd ₁₁ Pb ₁₀	54.5
GdPb ₃	80	<i>cP4</i>	$Pm\bar{3}m$
(Pb)	>99.6 to 100	<i>cF4</i>	$Fm\bar{3}m$

Gd-Pd (Gadolinium - Palladium)

H. Okamoto, 1990

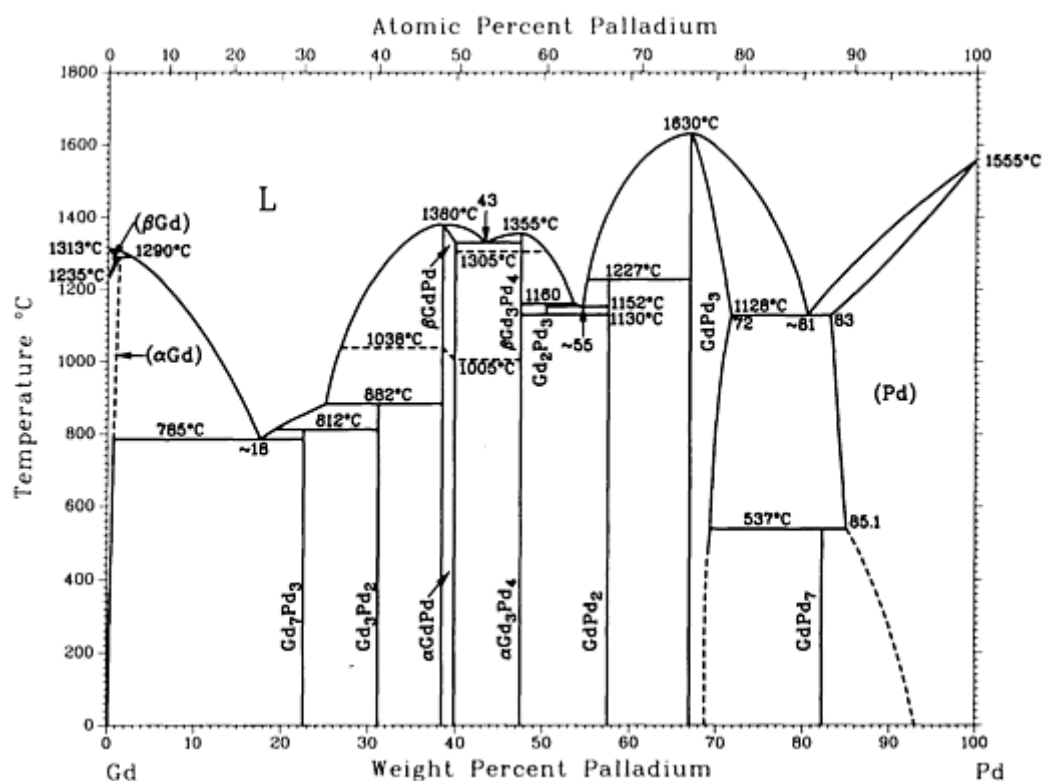

Gd-Pd phase diagram

Gd-Pd crystallographic data

Phase	Composition, wt% Pd	Pearson symbol	Space group
(β Gd)	0 to 0.68	<i>cI2</i>	<i>Im$\bar{3}m$</i>
(α Gd)	0 to 1.4	<i>hP2</i>	<i>P6$_3$/mmc</i>
Gd$_7$Pd$_3$	23	<i>hP20</i>	<i>P6$_3$mc</i>
Gd$_3$Pd$_2$	31	<i>tP10</i>	<i>P4/mbm</i>
β GdPd	\sim 40.4
α GdPd	\sim 40.4	<i>oC8</i>	<i>Cmcm</i>
Gd$_3$Pd$_4$	47.4	<i>hR14</i>	<i>R$\bar{3}$</i>
Gd$_2$Pd$_3$	50
GdPd$_3$	67 to 72	<i>cP4</i>	<i>Pm$\bar{3}m$</i>
GdPd$_7$	82.6
(Pd)	83 to 100	<i>cF4</i>	<i>Fm$\bar{3}m$</i>

Gd-Rh (Gadolinium - Rhodium)

H. Okamoto, 1990

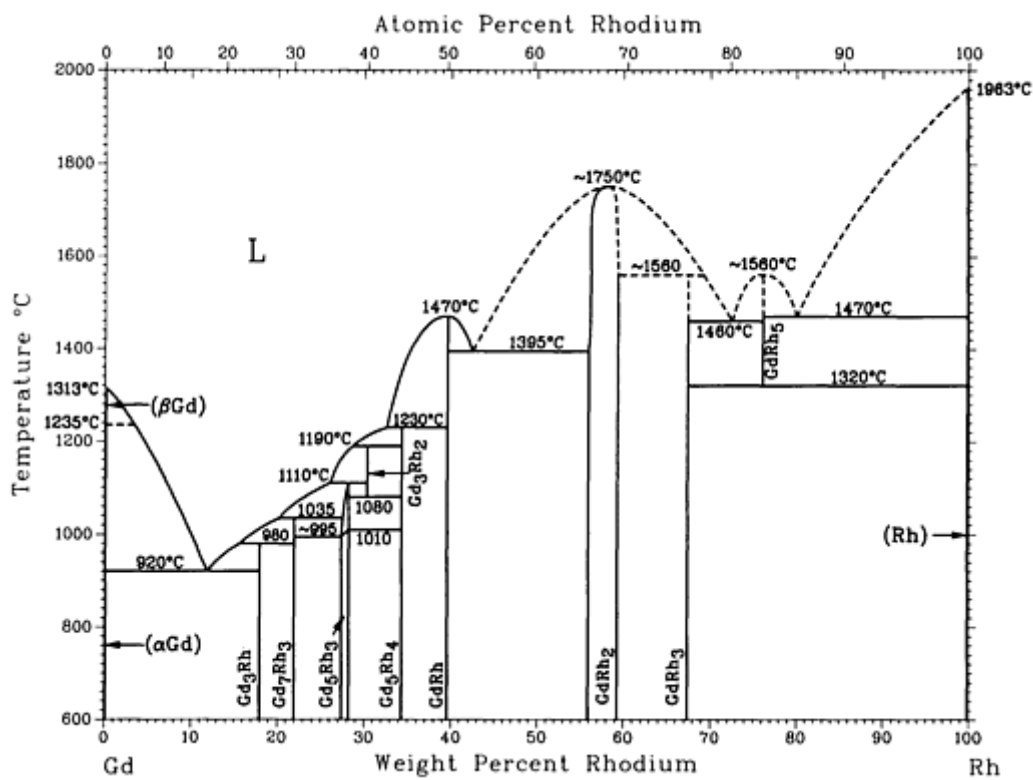

Gd-Rh phase diagram

Gd-Rh crystallographic data

Phase	Composition, wt% Rh	Pearson symbol	Space group
β Gd	0	<i>cI2</i>	$Im\bar{3}m$
α Gd	0	<i>hP2</i>	$P6_3/mmc$
Gd_3Rh	18	<i>oP16</i>	<i>Pnma</i>
Gd_7Rh_3	22	<i>hP20</i>	$P6_3mc$
β Gd_5Rh_3	~28.2	<i>hP16</i>	$P6_3/mcm$
α Gd_5Rh_3	~28.2
Gd_3Rh_2	30	<i>tI140</i>	$I4/mcm$
Gd_5Rh_4	34.3	<i>oP36</i>	<i>Pnma</i>

GdRh	39.6	<i>cP2</i>	<i>Pd$\bar{3}m$</i>
GdRh₂	56 to 59	<i>cF24</i>	<i>Fd$\bar{3}m$</i>
GdRh₃	66	<i>hP24</i>	<i>P6₃/mmc</i>
GdRh₅	76.5	<i>hP6</i>	<i>P6/mmm</i>
(Rh)	100	<i>cF4</i>	<i>Fm$\bar{3}m$</i>

Gd-Sb (Gadolinium - Antimony)

H. Okamoto, 1990

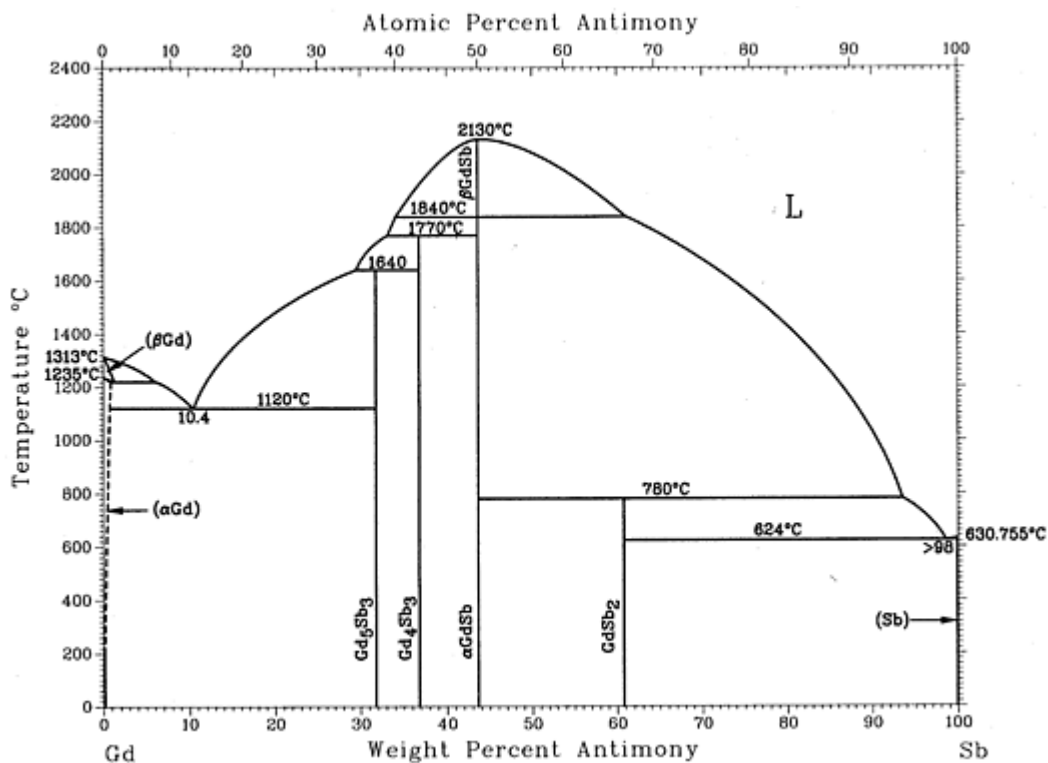

Gd-Sb phase diagram

Gd-Sb crystallographic data

Phase	Composition, wt% Sb	Pearson symbol	Space group
(β Gd)	0	<i>cI2</i>	<i>Im</i> $\bar{3}m$
(α Gd)	0	<i>hP2</i>	<i>P6</i> ₃ / <i>mmc</i>
Gd ₅ Sb ₃	31.7	<i>hP16</i>	<i>P6</i> ₃ / <i>mcm</i>
Gd ₄ Sb ₃	36.8	<i>cI28</i>	<i>I</i> $\bar{4}3d$
β GdSb	43.6
α GdSb	43.6	<i>cF8</i>	<i>Fm</i> $\bar{3}m$
GdSb ₂	60.8	<i>hP12</i>	<i>P6</i> ₃ / <i>mmc</i>
(Sb)	100	<i>hR2</i>	<i>R</i> $\bar{3}m$

Gd-Sn (Gadolinium - Tin)

A. Palenzona and S. Cirafici, 1991

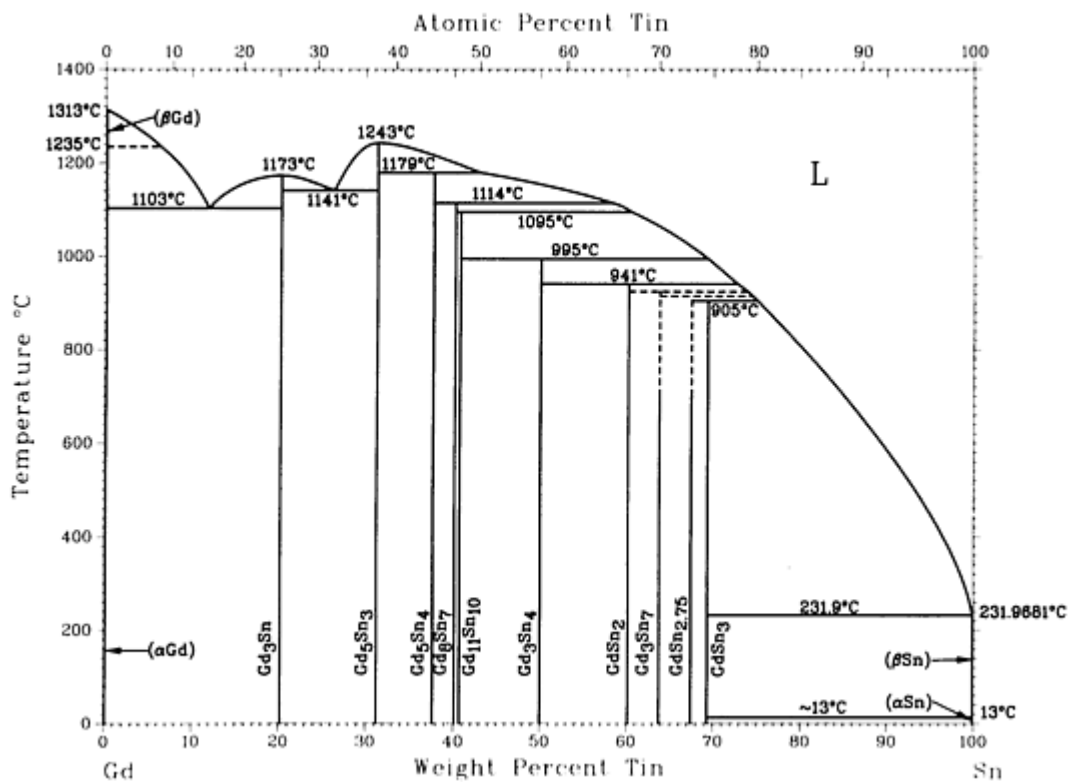

Gd-Sn phase diagram

Gd-Sn crystallographic data

Phase	Composition, wt% Sn	Pearson symbol	Space group
(β Gd)	0	<i>hP2</i>	<i>P6₃/mmc</i>
(α Gd)	0	<i>cI2</i>	<i>Im$\bar{3}m$</i>
Gd₃Sn	20
Gd₅Sn₃	31.2	<i>hP16</i>	<i>P6₃/mcm</i>
Gd₅Sn₄	37.6	<i>oP36</i>	<i>Pnma</i>
Gd₈Sn₇	39.8
Gd₁₁Sn₁₀	40.7	<i>tI84</i>	<i>I4/mmm</i>

Gd_3Sn_4	50.1
GdSn_2	60.2	<i>oC12</i>	<i>Cmcm</i>
Gd_3Sn_7	64	<i>oC20</i>	<i>Cmmm</i>
$\text{GdSn}_{2.75}$	67.5	<i>oC15</i>	<i>Amm2</i>
GdSn_3	69	<i>cP4</i>	$Pm\bar{3}m$
(β Sn)	100	<i>I4</i>	$I4_1/amd$
(α Sn)	100	<i>cF8</i>	$Fd\bar{3}m$

Gd-Te (Gadolinium - Tellurium)

H. Okamoto, 1990

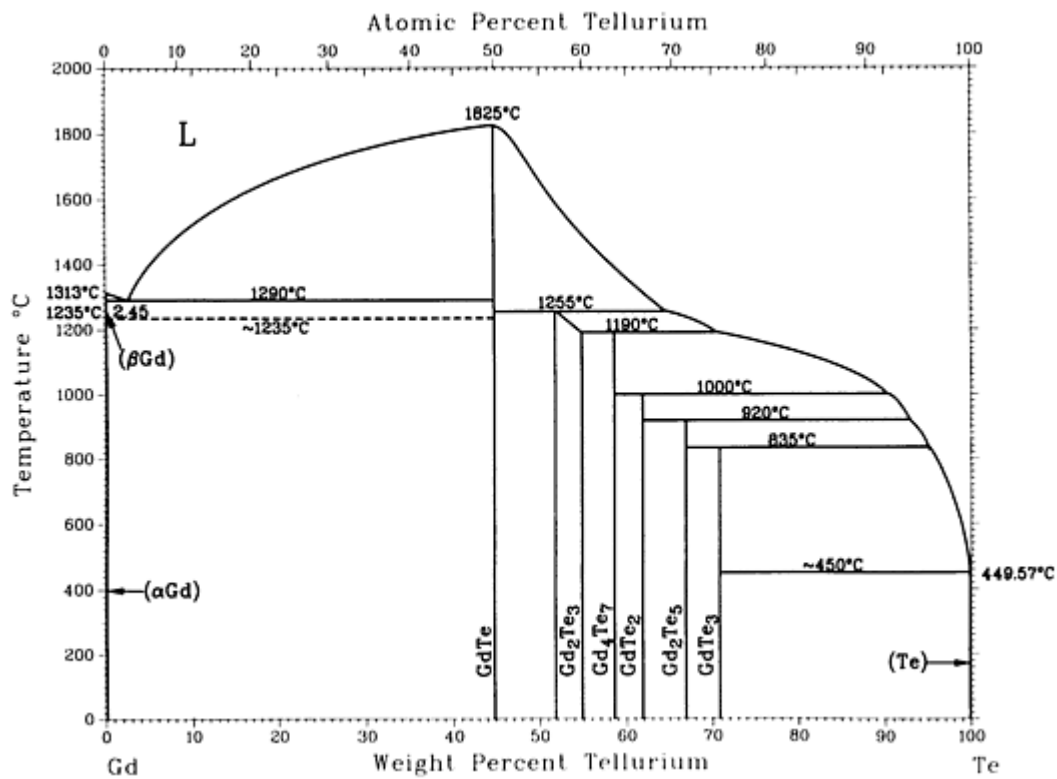

Gd-Te phase diagram

Gd-Te crystallographic data

Phase	Composition, wt% Te	Pearson symbol	Space group
(β Gd)	0	<i>cI2</i>	<i>Im$\bar{3}m$</i>
(α Gd)	0	<i>hP2</i>	<i>P6$_3$/mmc</i>
GdTe	44.8	<i>cF8</i>	<i>Fm$\bar{3}m$</i>
Gd ₂ Te ₃	52 to 55	<i>oP20</i>	<i>Pnma</i>
Gd ₄ Te ₇	58.6	<i>tP6</i>	<i>P4/nmm</i>
GdTe ₂	61.9
Gd ₂ Te ₅	67.0	<i>oC28</i>	<i>Cmcm</i>
GdTe ₃	71	<i>oC16</i>	<i>Cmcm</i>
(Te)	100	<i>hP3</i>	<i>P3$_1$21</i>

Gd-Ti (Gadolinium - Titanium)

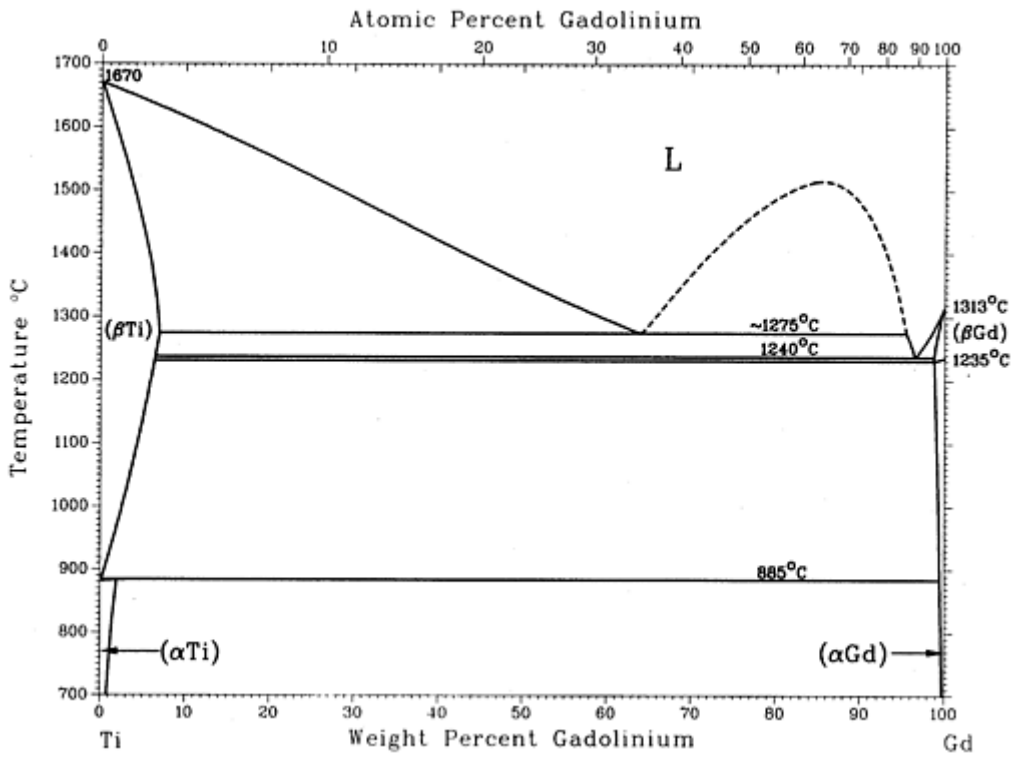

Gd-Ti phase diagram

Gd-Ti crystallographic data

Phase	Composition, wt% Gd	Pearson symbol	Space group
(βTi)	0 to ~6	<i>cI2</i>	<i>Im$\bar{3}m$</i>
(αTi)	0 to ~1.9	<i>hP2</i>	<i>P6₃/mmc</i>
(βGd)	~99 to 100	<i>cI2</i>	<i>Im$\bar{3}m$</i>
(αGd)	~99 to 100	<i>hP2</i>	<i>P6₃/mmc</i>

Gd-Tl (Gadolinium - Thallium)

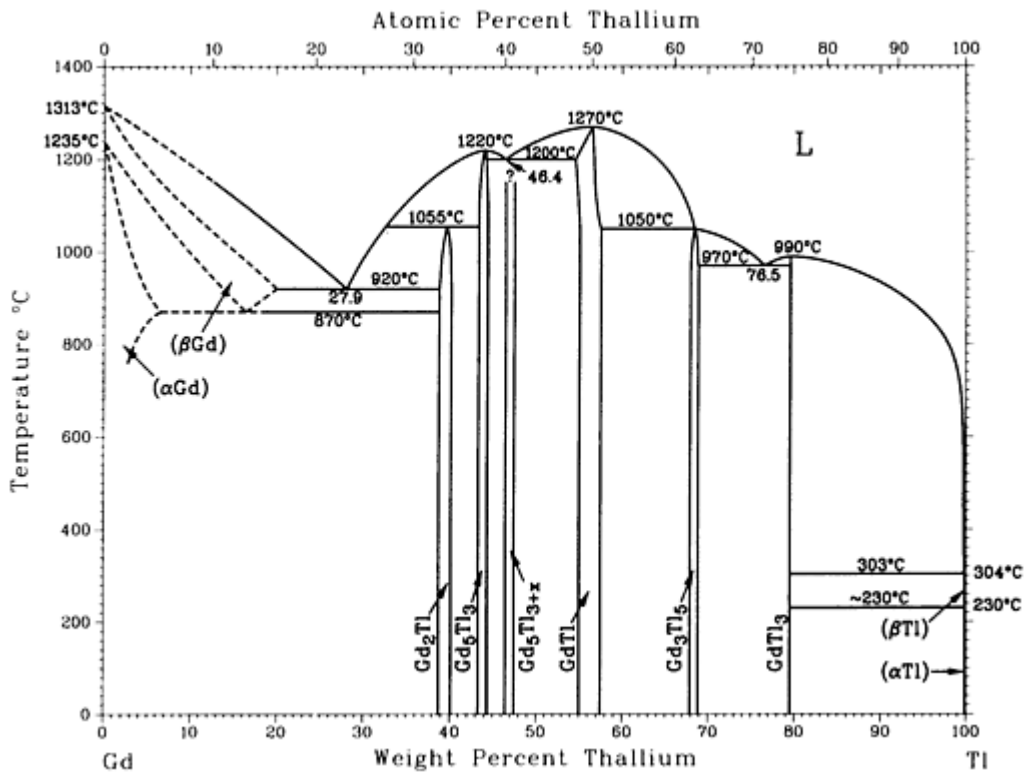

Gd-Tl phase diagram

Gd-Tl crystallographic data

Phase	Composition, wt% Tl	Pearson symbol	Space group
(αGd)	0 to ?	<i>hP2</i>	<i>P6₃/mmc</i>
(βGd)	0 to ~20	<i>cI2</i>	<i>Im$\bar{3}m$</i>
Gd_2Tl	~39 to ~40	<i>hP6</i>	<i>P6₃/mmc</i>
Gd_5Tl_3	~43 to ~44	<i>hP16</i>	<i>P6₃/mcm</i>
Gd_5Tl_{3+x}	?	<i>iI32</i>	<i>I4/mcm</i>
$GdTl^{(a)}$	~55 to ~58	<i>cP2</i> (or <i>cI2</i>)	<i>Pm$\bar{3}m$</i> <i>Im$\bar{3}m$</i>
$GdTl^{(b)}$	~55 to ~58	<i>iP2</i>	<i>P4/mmm</i>
Gd_3Tl_5	~68 to ~69	<i>oC32</i>	<i>Cmcm</i>

GdTi_3	80	$cP4$	$Pm\bar{3}m$
$(\beta\text{-Ti})$	100	$cI2$	$Im\bar{3}m$
$(\alpha\text{-Ti})$	100	$hP2$	$P6_3/mmc$

(a) Cubic structure presumed to be room- and higher-temperature phases.

(b) Tetragonal structure presumed to be lower-temperature phase.

Ge (Germanium) Binary Alloy Phase Diagrams

Introduction

THIS ARTICLE includes systems where germanium is the first-named element in the binary pair. Additional binary systems that include germanium are provided in the following locations in this Volume:

- “Ag-Ge (Silver - Germanium)” in the article “Ag (Silver) Binary Alloy Phase Diagrams.”
- “Al-Ge (Aluminum - Germanium)” in the article “Al (Aluminum) Binary Alloy Phase Diagrams.”
- “As-Ge (Arsenic - Germanium)” in the article “As (Arsenic) Binary Alloy Phase Diagrams.”
- “Au-Ge (Gold - Germanium)” in the article “Au (Gold) Binary Alloy Phase Diagrams.”
- “Ba-Ge (Barium - Germanium)” in the article “Ba (Barium) Binary Alloy Phase Diagrams.”
- “Bi-Ge (Bismuth - Germanium)” in the article “Bi (Bismuth) Binary Alloy Phase Diagrams.”
- “Ca-Ge (Calcium - Germanium)” in the article “Ca (Calcium) Binary Alloy Phase Diagrams.”
- “Cd-Ge (Cadmium - Germanium)” in the article “Cd (Cadmium) Binary Alloy Phase Diagrams.”
- “Ce-Ge (Cerium - Germanium)” in the article “Ce (Cerium) Binary Alloy Phase Diagrams.”
- “Co-Ge (Cobalt - Germanium)” in the article “Co (Cobalt) Binary Alloy Phase Diagrams.”
- “Cr-Ge (Chromium - Germanium)” in the article “Cr (Chromium) Binary Alloy Phase Diagrams.”
- “Cs-Ge (Cesium - Germanium)” in the article “Cs (Cesium) Binary Alloy Phase Diagrams.”
- “Cu-Ge (Copper - Germanium)” in the article “Cu (Copper) Binary Alloy Phase Diagrams.”
- “Dy-Ge (Dysprosium - Germanium)” in the article “Dy (Dysprosium) Binary Alloy Phase Diagrams.”
- “Er-Ge (Erbium - Germanium)” in the article “Er (Erbium) Binary Alloy Phase Diagrams.”
- “Eu-Ge (Europium - Germanium)” in the article “Eu (Europium) Binary Alloy Phase Diagrams.”
- “Fe-Ge (Iron - Germanium)” in the article “Fe (Iron) Binary Alloy Phase Diagrams.”
- “Gd-Ge (Gadolinium - Germanium)” in the article “Gd (Gadolinium) Binary Alloy Phase Diagrams.”

Ge-Ho (Germanium - Holmium)

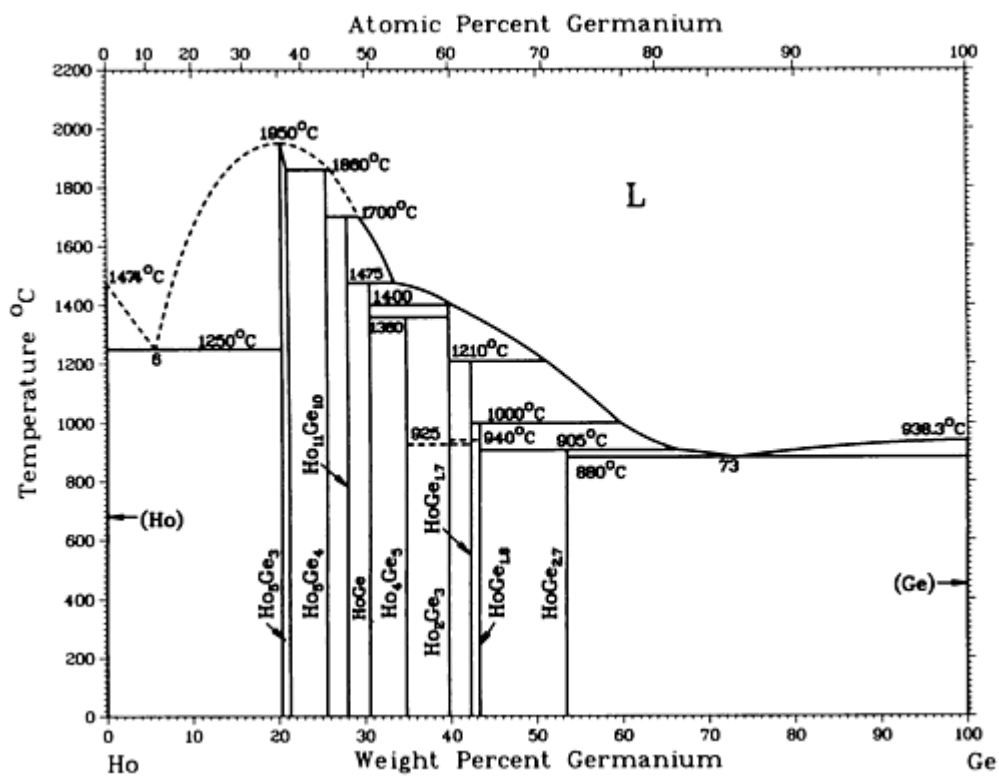

Ge-Ho phase diagram

Ge-Ho crystallographic data

Phase	Composition, wt% Ge	Pearson symbol	Space group
(Ho)	0	<i>hP2</i>	<i>P6₃/mmc</i>
Ho ₅ Ge ₃	~20.9	<i>hP16</i>	<i>P6₃/mcm</i>
Ho ₅ Ge ₄	26.0	<i>oP36</i>	<i>Pnma</i>
Ho ₁₁ Ge ₁₀	28.6	<i>tI84</i>	<i>I4/mmm</i>
HoGe	30.6	<i>oC8</i>	<i>Cmcm</i>
Ho ₄ Ge ₅	35.5
β-Ho ₂ Ge ₃	40	<i>oC12</i>	<i>Cmmm</i>
α-Ho ₂ Ge ₃	40	<i>hP3</i>	<i>P6/mmm</i>

β HoGe _{1.7}	43
α HoGe _{1.7}	43	<i>tI12</i>	<i>I4₁/amd</i>
HoGe _{1.8}	44.2
HoGe _{2.7}	54	<i>o**</i>	...
(Ge)	100	<i>cF8</i>	<i>Fd$\bar{3}m$</i>

Ge-In (Germanium - Indium)

R.W. Olesinski, N. Kanani, and G.J. Abbaschian, 1992

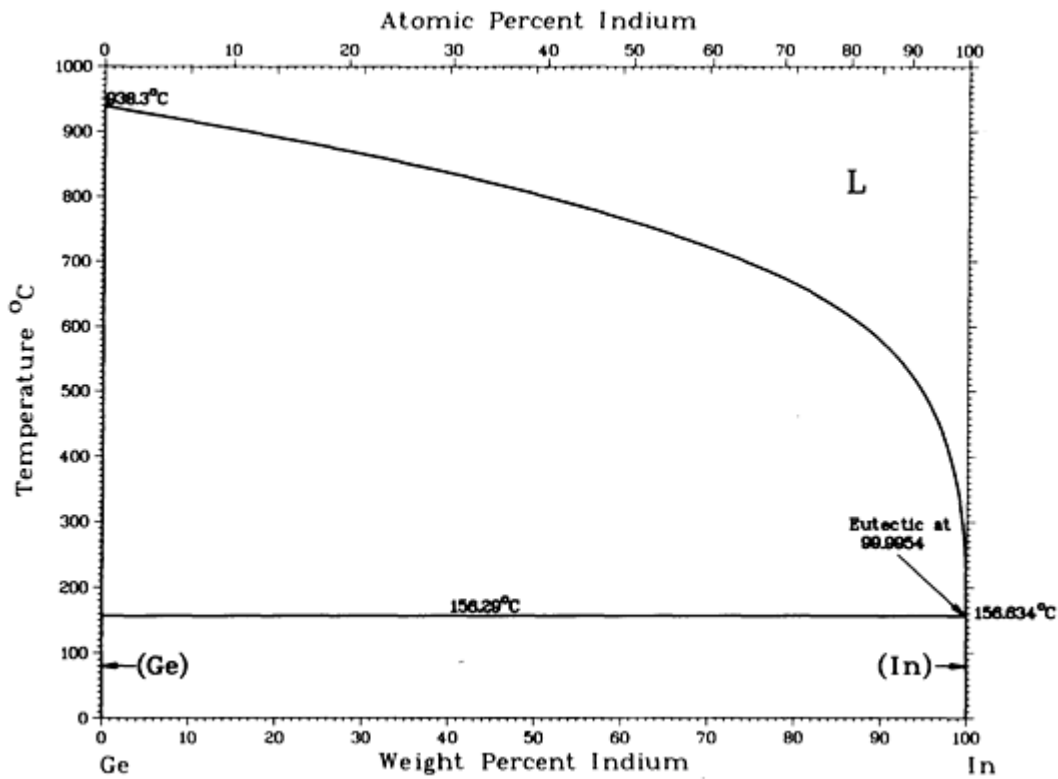

Ge-In phase diagram

Ge-In crystallographic data

Phase	Composition, wt% In	Pearson symbol	Space group
-------	---------------------	----------------	-------------

(Ge)	0	<i>cF8</i>	<i>Fd</i> $\bar{3}m$
(In)	100	<i>iI2</i>	<i>I4/mmm</i>

Ge-K (Germanium - Potassium)

H. Okamoto, 1990

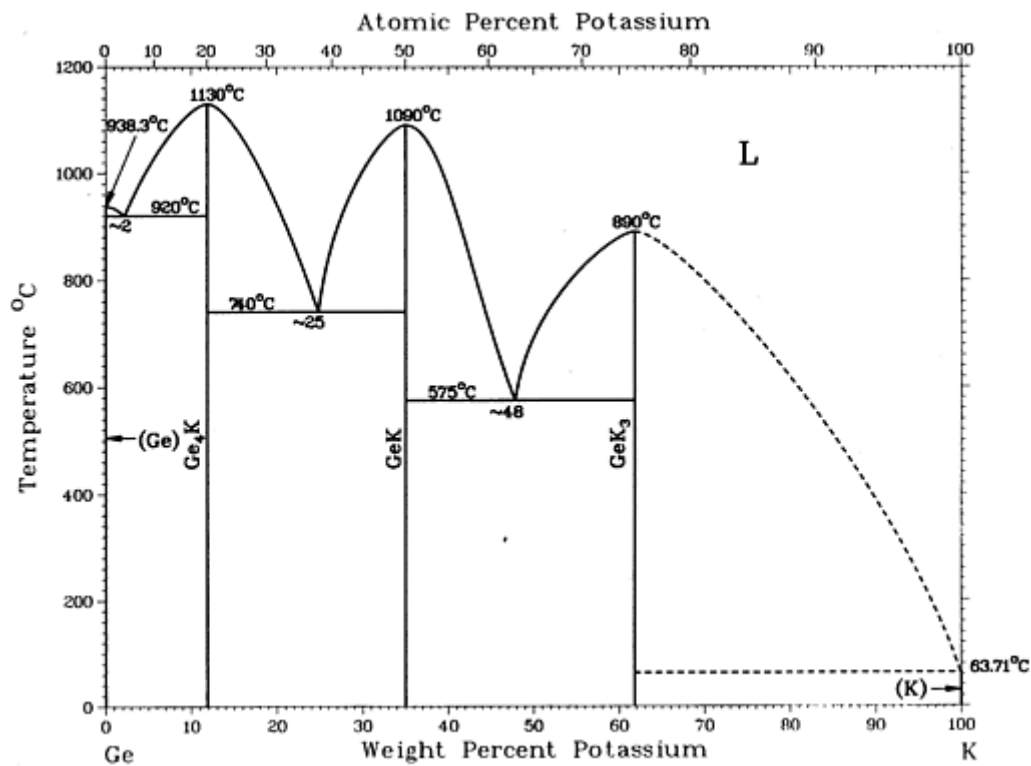

Ge-K phase diagram

Ge-K crystallographic data

Phase	Composition, wt% K	Pearson symbol	Space group
(Ge)	0	<i>cF8</i>	<i>Fd</i> $\bar{3}m$
$Ge_{23}K_4$ ^(a)	8.6	<i>cP54</i>	<i>Pm</i> $\bar{3}n$
Ge_4K	12
GeK	35.0	<i>cP64</i>	<i>P</i> $\bar{4}3m$

GeK_3	62
(K)	100	$cI2$	$Im\bar{3}m$

(a) Not shown in the phase diagram

Ge-La (Germanium - Lanthanum)

A.B. Gokhale and G.J. Abbaschian, 1989

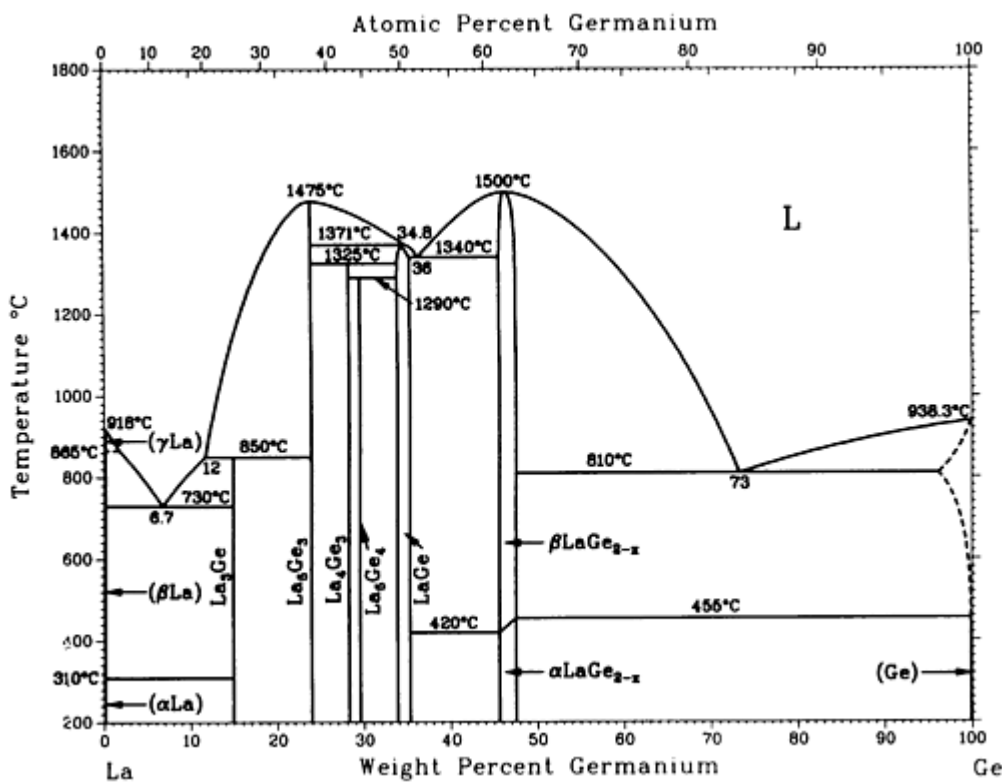

Ge-La phase diagram

Ge-La crystallographic data

Phase	Composition, wt% Ge	Pearson symbol	Space group
(γ La)	0	$cI2$	$Im\bar{3}m$
(β La)	0	$cF4$	$Fm\bar{3}m$
(α La)	0	$hP4$	$P6_3/mmc$

La₃Ge	15	<i>t</i> **	...
La₅Ge₃	23.9	<i>hP</i> 16	<i>P</i> 6 ₃ / <i>mcm</i>
La₄Ge₃	28.2	<i>cI</i> 28	<i>I</i> 4 ₃ <i>d</i>
La₅Ge₄	29.5	<i>oP</i> *	<i>Pnma</i>
LaGe	33 to 35	<i>oP</i> 8	<i>Pnma</i>
αLaGe_{2-x}	45.5 to 46.4	<i>oI</i> *	<i>Imma</i>
βLaGe_{2-x}	45.5 to 46.4	<i>iI</i> 12	<i>I</i> 4 ₁ / <i>amd</i>
(Ge)	? to 100	<i>cF</i> 8	<i>Fd</i> 3 _{<i>m</i>}

Ge-Li (Germanium - Lithium)

H. Okamoto, 1990

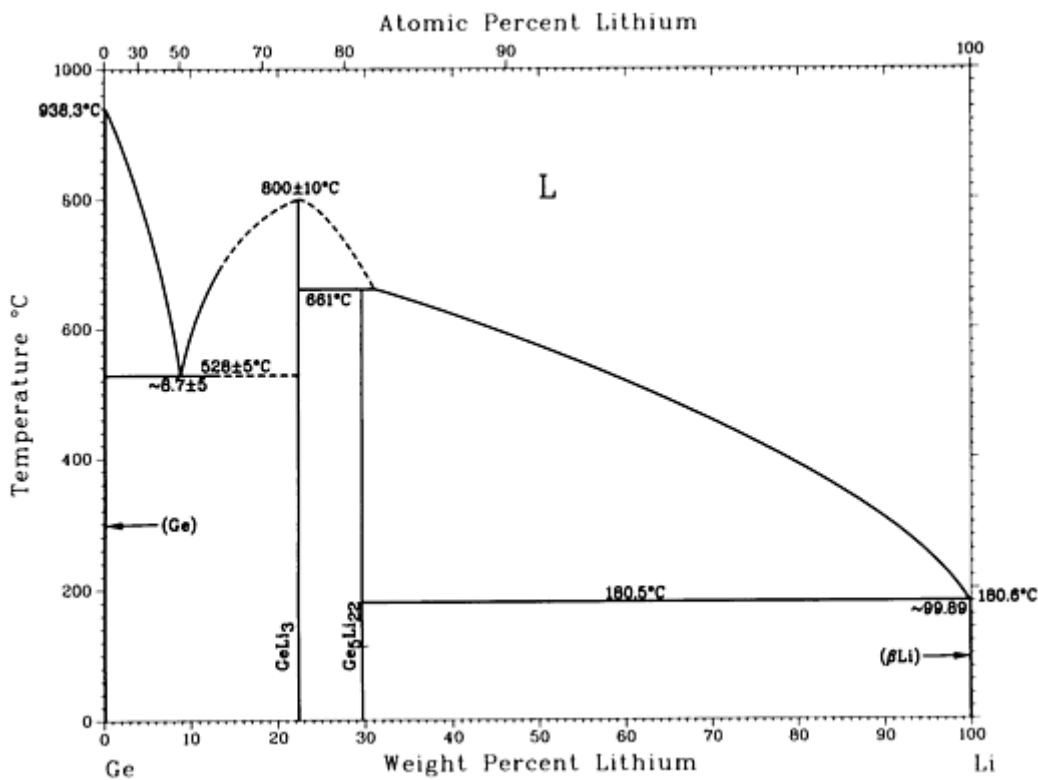

Ge-Li phase diagram

Ge-Li crystallographic data

Phase	Composition, wt% Li	Pearson symbol	Space group
(Ge)	0	<i>cF8</i>	<i>Fd$\bar{3}m$</i>
GeLi ^(a)	8.7	<i>tI32</i>	<i>I4₁/a</i>
Ge₆Li₁₁ ^(a)	14.9	<i>oC68</i>	<i>Cmcm</i>
GeLi₂ ^(a)	16.1
GeLi₃	22
Ge₂Li₇ ^(a)	25.1	<i>oC36</i>	<i>Cmmm</i>
Ge₄Li₁₅ ^(a)	26.3	<i>cI76</i>	<i>I$\bar{4}3d$</i>
Ge₃Li₂₂	29.6	<i>cF432</i>	<i>F23</i>
(β -Li)	100	<i>cI2</i>	<i>Im$\bar{3}m$</i>

(a) Not shown in the diagram

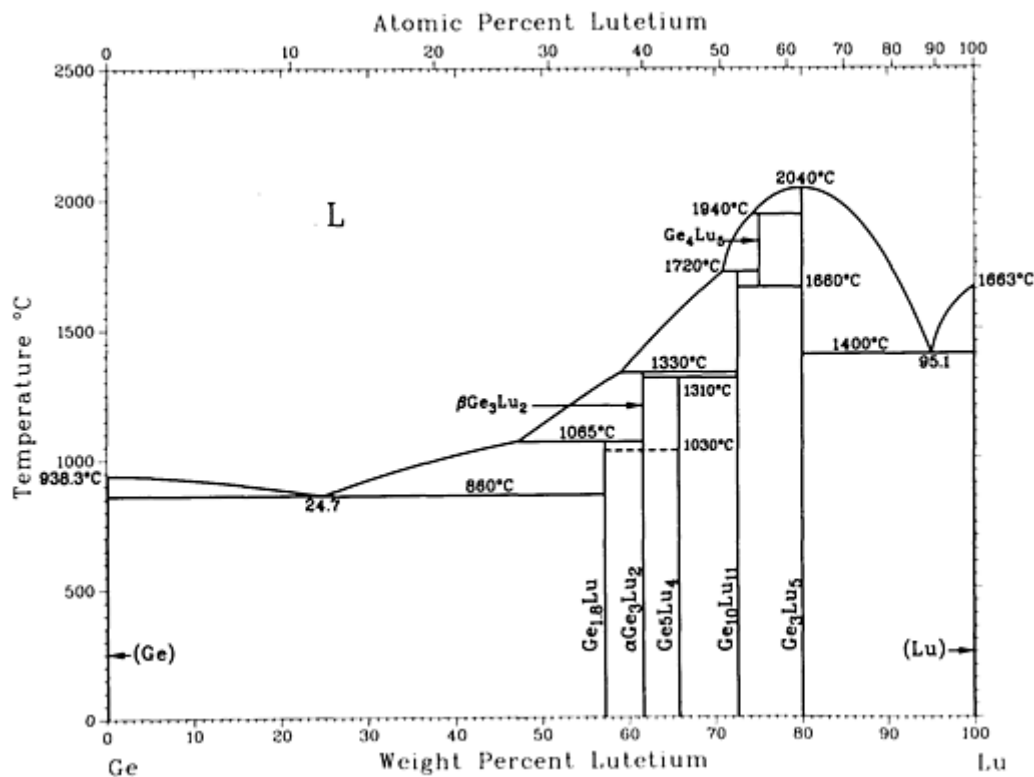

Ge-Lu phase diagram

Ge-Lu crystallographic data

Phase	Composition, wt% Lu	Pearson symbol	Space group
(Ge)	0	<i>cF8</i>	<i>Fd</i> $\bar{3}m$
Ge _{1.8} Lu	57.2	<i>oC12</i>	<i>Cmcm</i>
Ge ₃ Lu ₂	62	<i>hP3</i>	<i>P6/mmm</i>
Ge ₅ Lu ₄	65.8
Ge ₁₀ Lu ₁₁	72.6	<i>tI84</i>	<i>I4/mmm</i>
Ge ₄ Lu ₂	75.1	<i>oP36</i>	<i>Pnma</i>
Ge ₃ Lu ₅	80.1	<i>hP16</i>	<i>P6₃/mcm</i>
(Lu)	100	<i>hP2</i>	<i>P6₃/mmc</i>

Ge-Mg (Germanium - Magnesium)

A.A. Nayeab-Hashemi, R.W. Olesinski, G.J. Abbaschian, and J.B. Clark, 1988

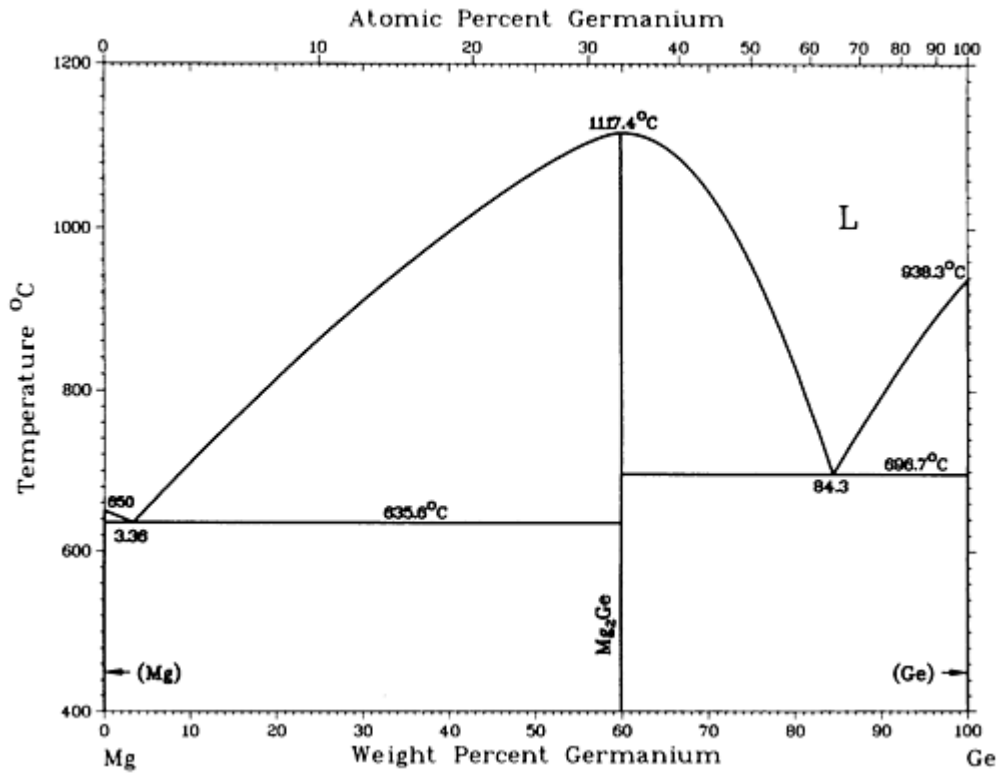

Ge-Mg phase diagram

Ge-Mg crystallographic data

Phase	Composition, wt% Ge	Pearson symbol	Space group
(Mg)	~0	<i>hP2</i>	<i>P6₃/mmc</i>
Mg_2Ge	59.90	<i>cF12</i>	<i>Fm$\bar{3}m$</i>
(Ge)	~100	<i>cF8</i>	<i>Fd$\bar{3}m$</i>

Ge-Mn (Germanium - Manganese)

A.B. Gokhale and G.J. Abbaschian, 1990

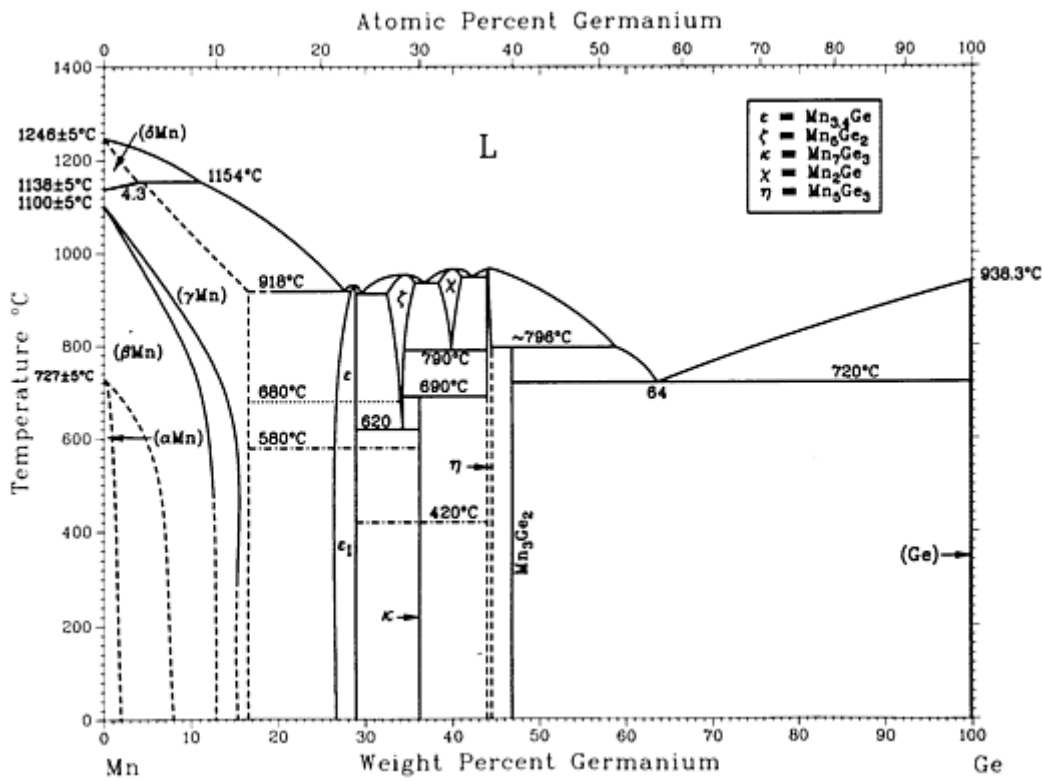

Ge-Mn phase diagram

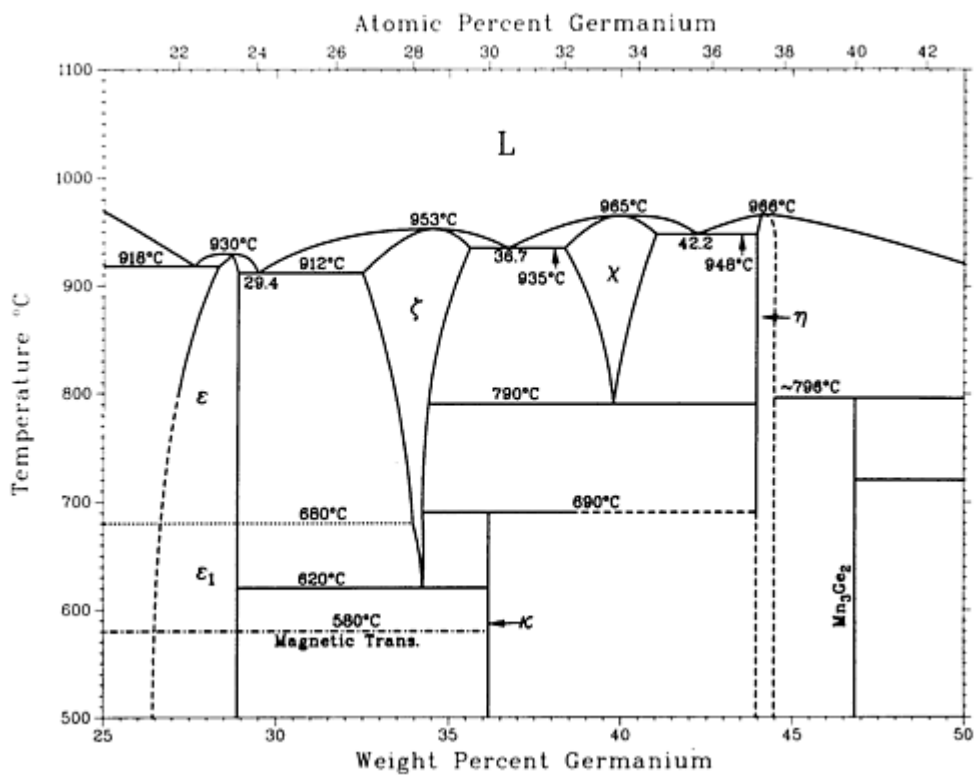

Enlarged region of the Mn-Ge system

Ge-Mn crystallographic data

Phase	Composition, wt% Ge	Pearson symbol	Space group
(δ Mn)	0 to 4.3	<i>cI2</i>	<i>Im</i> $\bar{3}m$
(γ Mn)	0 to \sim 16	<i>cF4</i>	<i>Fm</i> $\bar{3}m$
(β Mn)	0 to \sim 13	<i>cP20</i>	<i>P4</i> ₁ <i>32</i>
(α Mn)	0 to \sim 2.0	<i>cI58</i>	<i>I</i> $\bar{4}3m$
ϵ	\sim 28.0	<i>hP8</i>	<i>P6</i> ₃ / <i>mmc</i>
ϵ_1	\sim 28.0	<i>tI8</i>	<i>I4/mmm</i>
ξ	\sim 34.6	<i>hP128</i>	<i>P8c1</i>
κ	36	<i>o**</i>	...
χ	\sim 39.9	<i>hP6</i>	<i>P6</i> ₃ / <i>mmc</i>
η	\sim 44.2	<i>hP16</i>	<i>P6</i> ₃ / <i>mcm</i>
Mn₃Ge₂	47
(Ge)	100	<i>cF8</i>	<i>Fd</i> $\bar{3}m$

Ge-Mo (Germanium - Molybdenum)

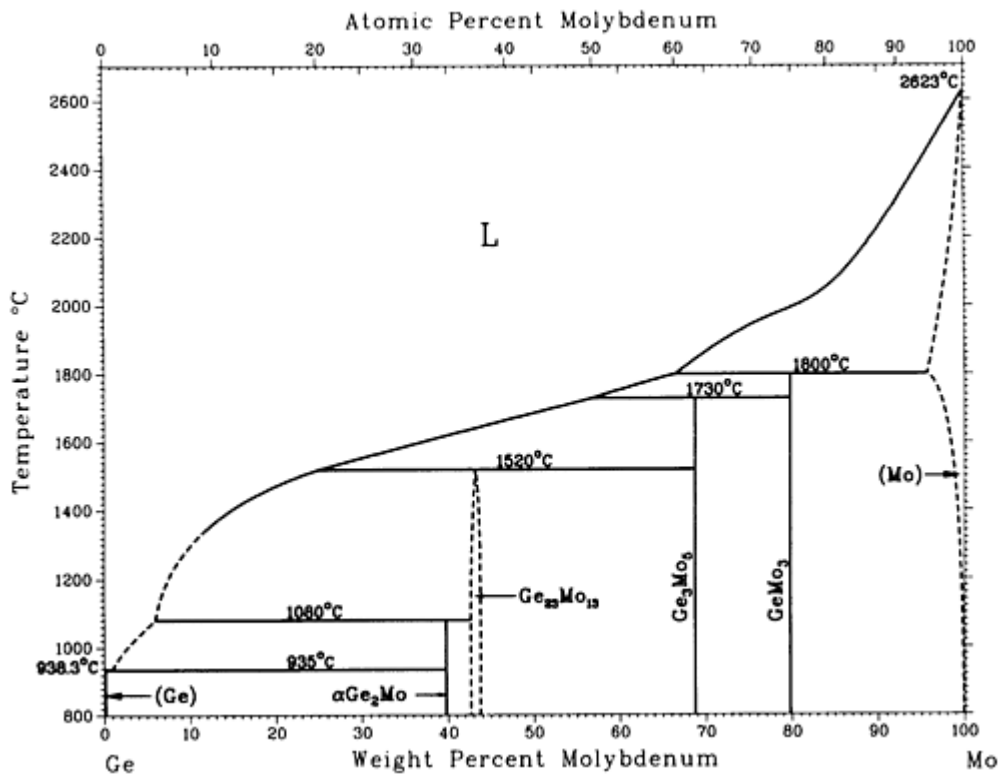

Ge-Mo phase diagram

Ge-Mo crystallographic data

Phase	Composition, wt% Mo	Pearson symbol	Space group
(Ge)	0	<i>cF8</i>	$Fd\bar{3}m$
$\alpha\text{Ge}_2\text{Mo}$	39.7	<i>oP12</i>	<i>Pnma</i>
$\beta\text{Ge}_2\text{Mo}$ (HP)	...	<i>tI8</i>	<i>I4/mmm</i>
$\text{Ge}_{23}\text{Mo}_{13}$ ^(a)	43 to 44	<i>tP144</i>	$P\bar{4}n2$
Ge_3Mo_5	68.8	<i>hP16</i>	$P6_3/mcm$
GeMo_3	80	<i>cP8</i>	$Pm\bar{3}n$
(Mo)	? to 100	<i>cI2</i>	$Im\bar{3}m$

(a) Also reported as $\text{Ge}_{41}\text{Mo}_{23}$ and $\text{Ge}_{16}\text{Mo}_9$ or $\text{Ge}_{1.7}\text{Mo}$

Ge-Na (Germanium - Sodium)

H. Okamoto, 1990

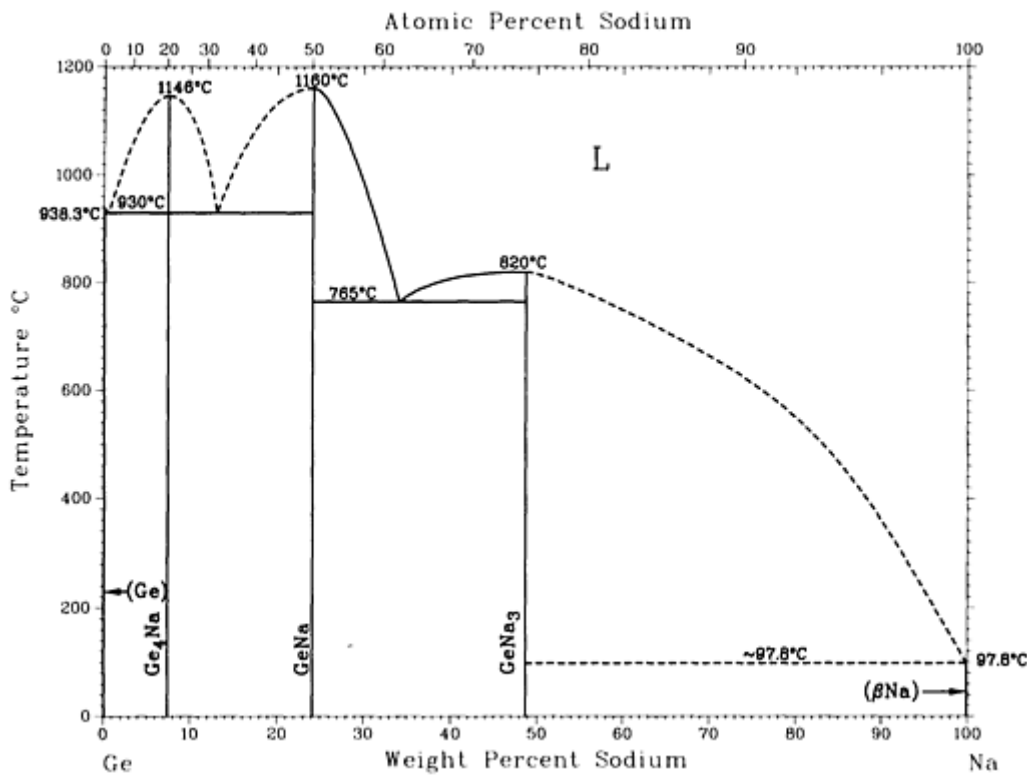

Ge-Na phase diagram

Ge-Na crystallographic data

Phase	Composition, wt% Na	Pearson symbol	Space group
(Ge)	0	$cF8$	$Fd\bar{3}m$
Ge_4Na	7	cP^*	$Pm\bar{3}n$
GeNa	24.0	$mP32$	$P2_1/c$
GeNa_3	49
(Na)	100	$cI2$	$Im\bar{3}m$

Ge-Nb (Germanium - Niobium)

From [Moffatt] 11

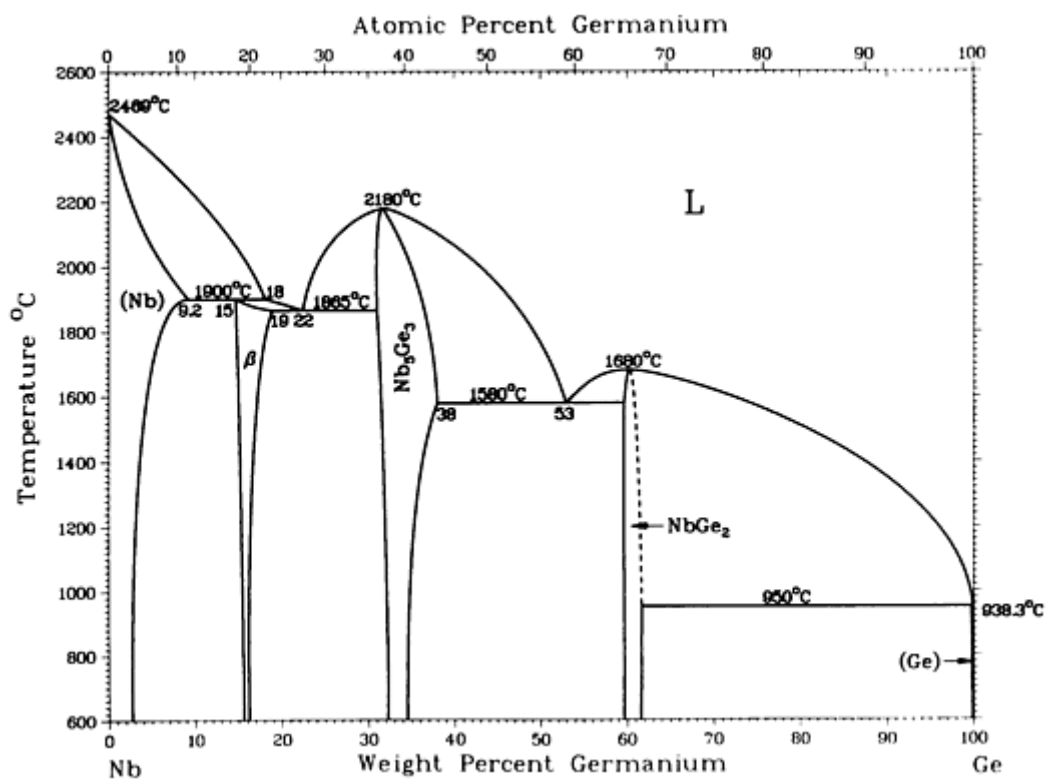

Ge-Nb phase diagram

Ge-Nb crystallographic data

Phase	Composition, wt% Ge	Pearson symbol	Space group
(Nb)	0 to 9.2	<i>cI2</i>	$Im\bar{3}m$
β	15 to 19	<i>cP8</i>	$Pm\bar{3}n$
Nb_5Ge_3	32 to 38	<i>tI32</i>	$I4/mcm$
NbGe_2	~61.0	<i>hP9</i>	$P6_222$
(Ge)	100	<i>cF8</i>	$Fd\bar{3}m$

Reference cited in this section

- [Moffatt]: W.G. Moffatt, Ed., *Handbook of Binary Phase Diagrams*, Business Growth Services, General Electric Co., Schenectady, NY (1976).

Ge-Nd (Germanium - Neodymium)

A.B. Gokhale and G.J. Abbaschian, 1989

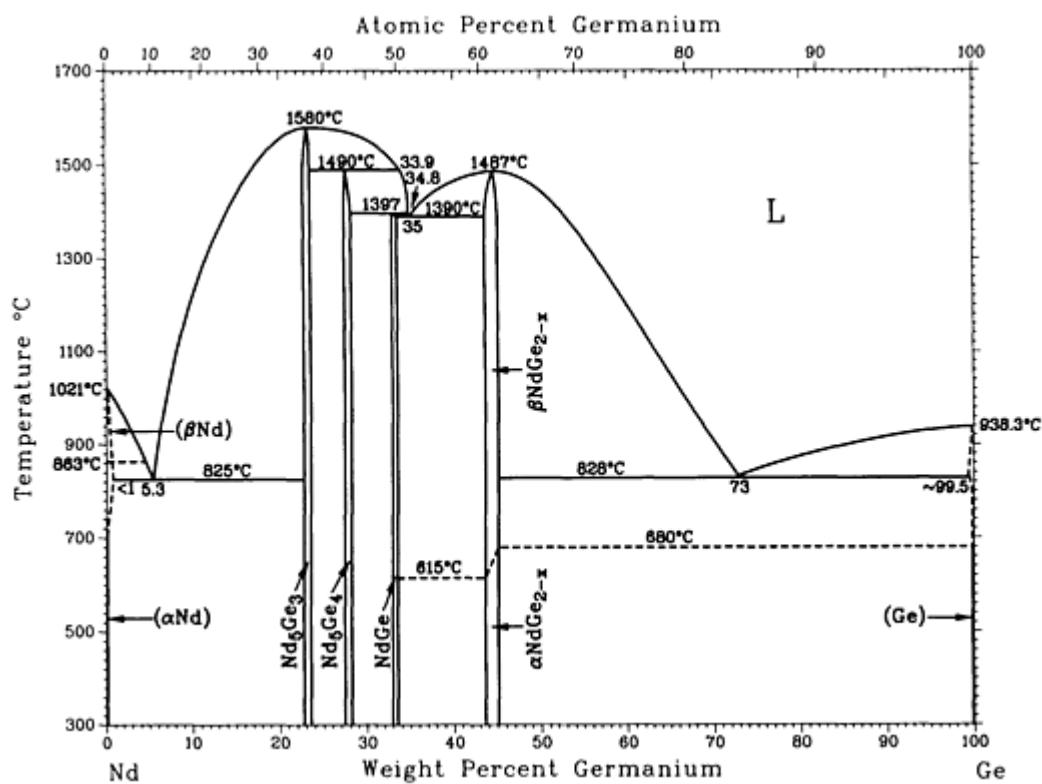

Ge-Nd phase diagram

Ge-Nd crystallographic data

Phase	Composition, wt% Ge	Pearson symbol	Space group
(α Nd)	0 to <1	<i>hP4</i>	<i>P6₃/mmc</i>
(β Nd)	0 to <1	<i>cI2</i>	<i>Im$\bar{3}m$</i>
Nd ₅ Ge ₃	22.3 to 23.2	<i>hP16</i>	<i>P6₃/mcm</i>
Nd ₅ Ge ₄	26.8 to 27.8	<i>oP*</i>	<i>Pnma</i>
NdGe	33 to 33.5	<i>oC8</i>	<i>Cmcm</i>
α NdGe _{2-x}	43 to 44.7	<i>oI*</i>	<i>Imma</i>
β NdGe _{2-x}	43 to 44.7	<i>tI12</i>	<i>I4₁/amd</i>
(Ge)	100	<i>cF8</i>	<i>Fd$\bar{3}m$</i>

Ge-Ni (Germanium - Nickel)

A. Nash and P. Nash, 1991

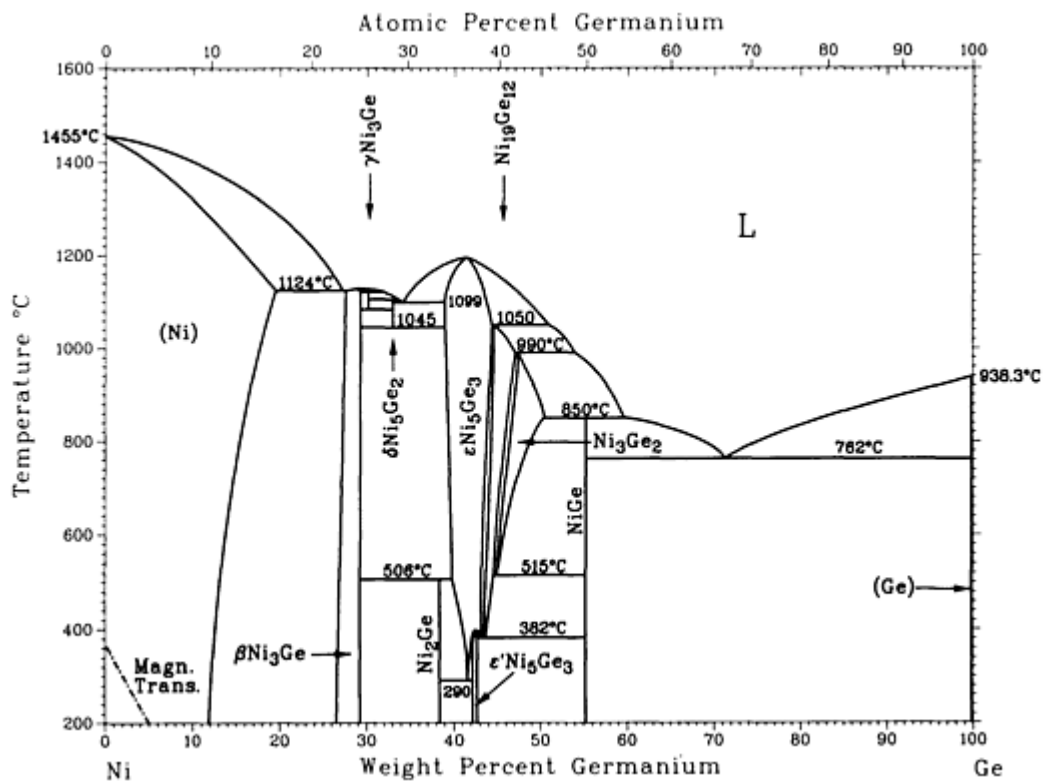

Ge-Ni phase diagram

Ge-Ni crystallographic data

Phase	Composition, wt% Ge	Pearson symbol	Space group
(Ni)	0 to 19	<i>cF4</i>	<i>Fm</i> $\bar{3}m$
β -Ni ₃ Ge	26.4 to 29	<i>cP4</i>	<i>Pm</i> $\bar{3}m$
γ -Ni ₃ Ge	29.9
δ -Ni ₅ Ge ₂	33	<i>hP84</i>	<i>P6</i> ₃ / <i>mmc</i>
Ni ₂ Ge	38.4	<i>oP12</i>	<i>Pnma</i>
ϵ' -Ni ₅ Ge ₃	~42	<i>mC32</i>	<i>C2</i>
ϵ -Ni ₅ Ge ₃	40 to 49	<i>hP4</i>	<i>P6</i> ₃ / <i>mmc</i>

$\text{Ni}_{19}\text{Ge}_{12}$	43 to 46	<i>mC62</i>	<i>C2</i>
Ni_3Ge_2	46 to 48	<i>hP4</i>	<i>P6_3/mmc</i>
NiGe	55.3	<i>oP8</i>	<i>Pnma</i>
(Ge)	100	<i>cF8</i>	<i>Fd\bar{3}m</i>

Ge-P (Germanium - Phosphorus)

R.W. Olesinski, N. Kanani, and G.J. Abbaschian, 1985

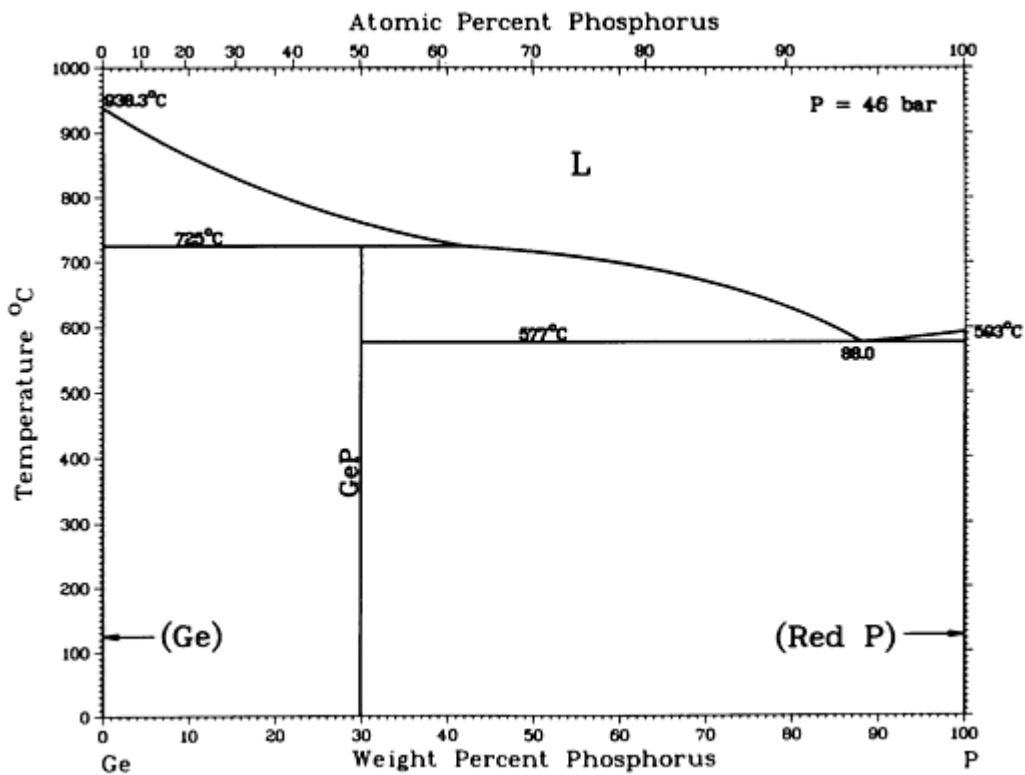

Ge-P phase diagram

Ge-P crystallographic data

Phase	Composition, wt% P	Pearson symbol	Space group
(Ge)	0 to 0.07	<i>cF8</i>	<i>Fd\bar{3}m</i>
GeP	29.9	(a)	<i>C2/m</i>

GeP^(b)	29.9	^(c)	<i>I4/m</i>
GeP₃^(b)	56	<i>hR2</i>	<i>R$\bar{3}$m</i>
GeP₅^(b)	68.0	<i>hR2</i>	<i>R$\bar{3}$m</i>
Red P	100
White P	100
Black P	100	<i>oC8</i>	<i>Cmca</i>

(a) Orthorhombic.

(b) High-temperature phase.

(c) Tetragonal

Ge-Pb (Germanium - Lead)

R.W. Olesinski and G.J. Abbaschian, 1984

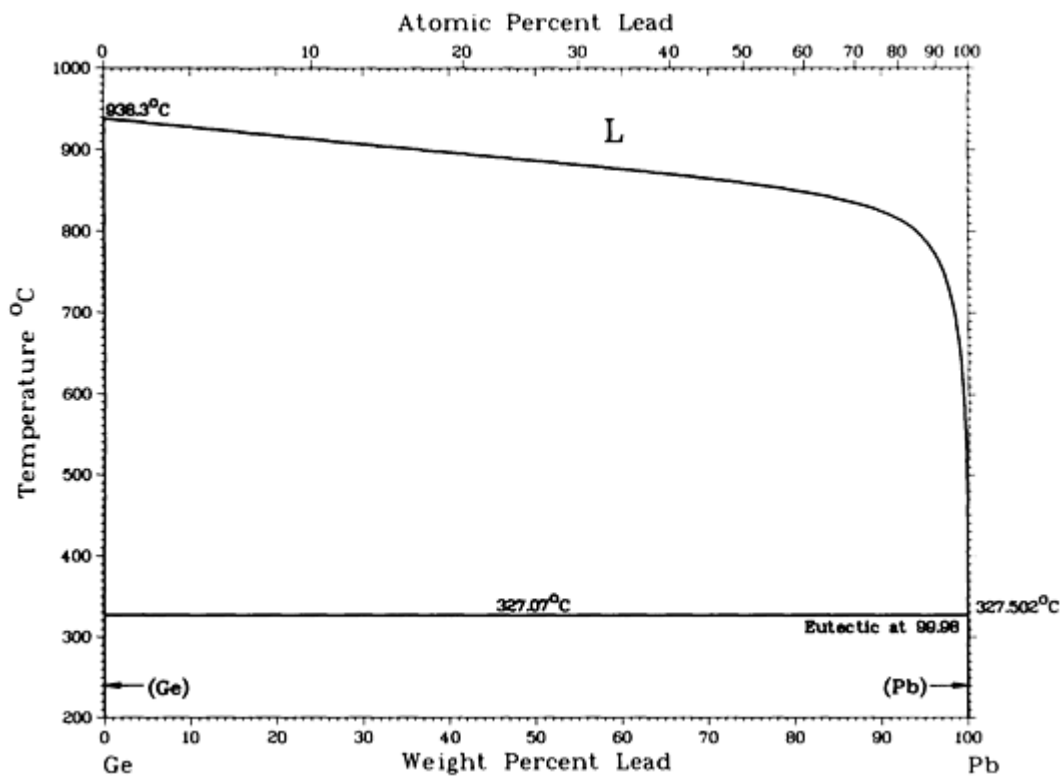

Ge-Pb phase diagram

Ge-Pb crystallographic data

Phase	Composition, wt% Pb	Pearson symbol	Space group
(Ge)	0	$cF8$	$Fd\bar{3}m$
(Pb)	100	$cF4$	$Fm\bar{3}m$

Ge-Pd (Germanium - Palladium)

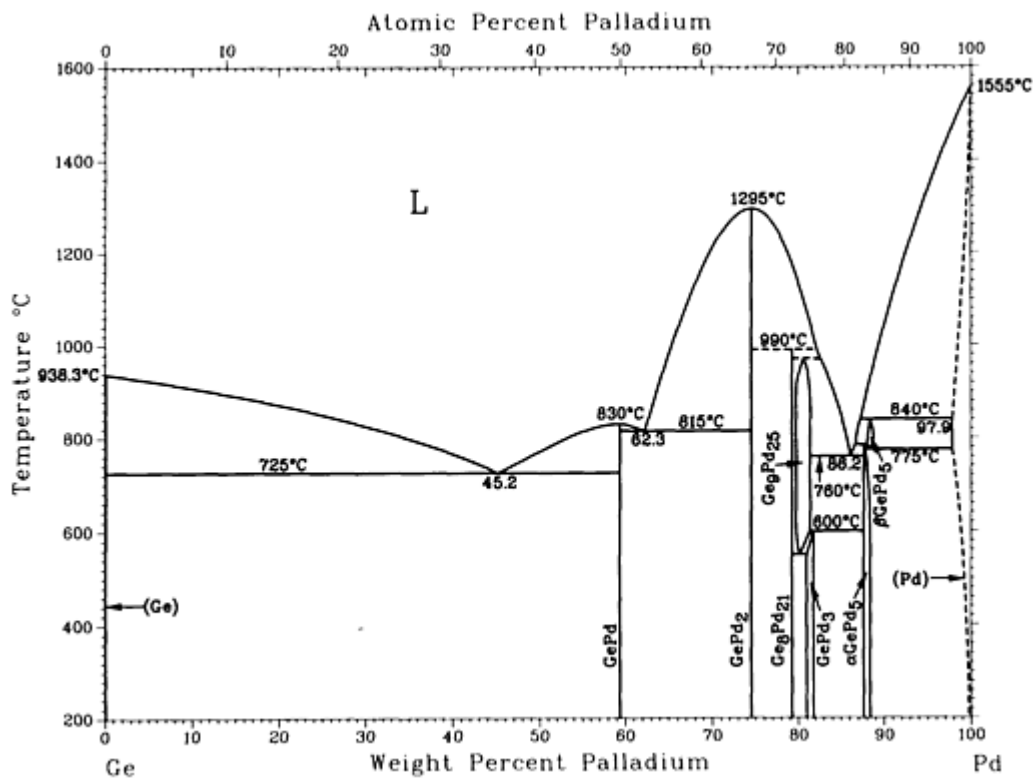

Ge-Pd phase diagram

Ge-Pd crystallographic data

Phase	Composition, wt% Pd	Pearson symbol	Space group
(Ge)	0	<i>cF8</i>	$Fd\bar{3}m$
GePd	59.4	<i>oP8</i>	<i>Pnma</i>
GePd ₂	74.6	<i>hP9</i>	$P\bar{6}2m$
Ge ₈ Pd ₂₁	79.4	<i>tI116</i>	$I4_1/a$
Ge ₉ Pd ₂₅	80 to 81.5	<i>hP34</i>	$P\bar{3}$
GePd ₃	81.1 to 81.9
β GePd ₅	88.1 to 88.9	<i>cI2</i>	$Im\bar{3}m$
α GePd ₅	87.7 to 88.5	<i>mC24</i>	<i>C2</i>

(Pd) 97.9 to 100 $cF4$ $Fm\bar{3}m$

Ge-Pr (Germanium - Praseodymium)

A.B. Gokhale, A. Munitz, and G.J. Abbaschian, 1989

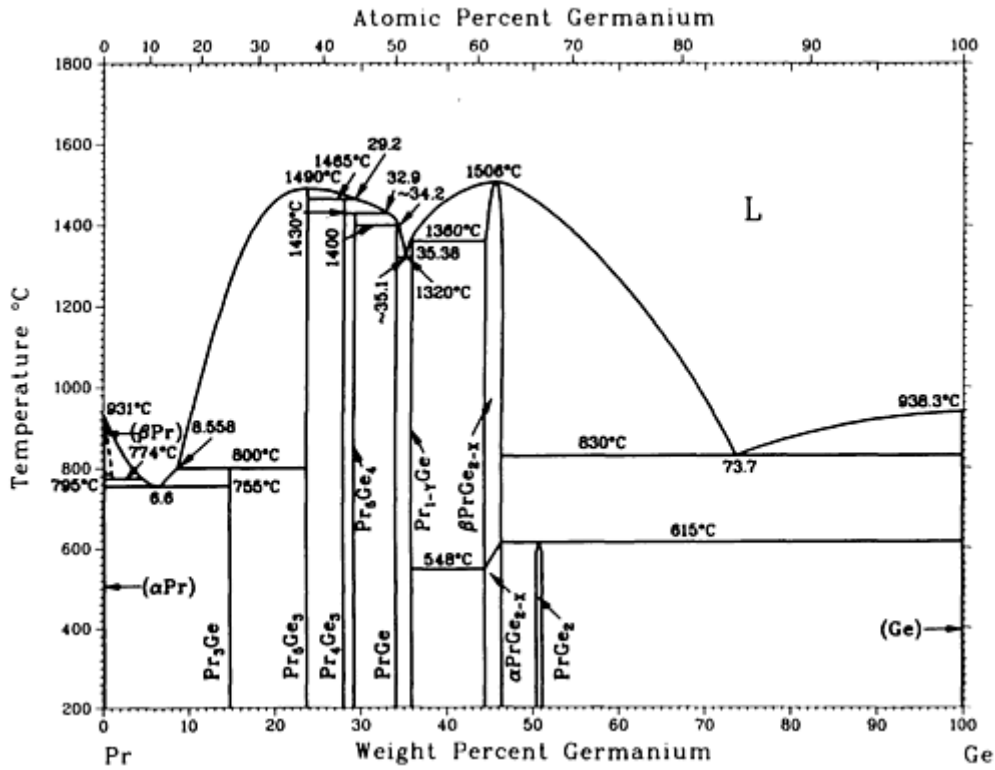

Ge-Pr phase diagram

Ge-Pr crystallographic data

Phase	Composition, wt% Ge	Pearson symbol	Space group
(β Pr)	0 to ?	$cI2$	$Im\bar{3}m$
(α Pr)	0	$hP4$	$P6_3/mmc$
Pr_3Ge	15	t^{**}	...
Pr_5Ge_3	23.8	$hP16$	$P6_3/mcm$
Pr_4Ge_3	27.9	$cI28$	$I\bar{4}d$

Pr_5Ge_4	29.2	oP^*	$Pnma$
PrGe	34.0	$oC8$	$Cmcm$
Pr_{1-y}Ge	35.5	$oP8$	$Pnma$
αPrGe_{2-x}	45 to 46.3	oI^*	$Imma$
βPrGe_{2-x}	45 to 46.3	$tI12$	$I4_1/amd$
PrGe_2	~ 50.8	$tI12$	$I4_1/amd$
(Ge)	100	$cF8$	$Fd\bar{3}m$

Ge-Pt (Germanium - Platinum)

H. Okamoto, 1992

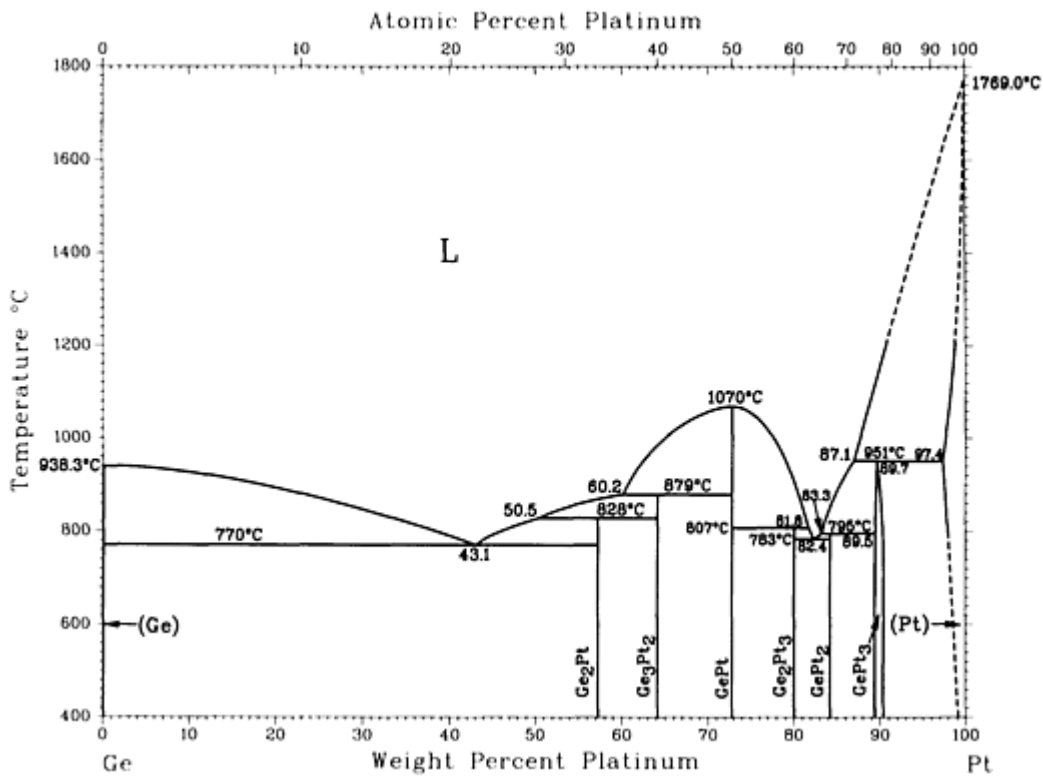

Ge-Pt phase diagram

Ge-Pt crystallographic data

Phase	Composition, wt% Pt	Pearson symbol	Space group
(Ge)	0	<i>cF8</i>	<i>Fd$\bar{3}m$</i>
Ge₂Pt	57.3	<i>oP6</i>	<i>Pnmm</i>
Ge₃Pt₂	64	<i>oP20</i>	<i>Pnma</i>
GePt	72.9	<i>oP8</i>	<i>Pnma</i>
Ge₂Pt₃	80	<i>oP40</i>	<i>Pnma</i>
GePt₂	84.3	<i>hP9</i>	<i>P$\bar{6}2m$</i>
GePt₃	90 to 91	<i>mC16</i>	<i>C2/m</i>
(Pt)	97.4 to 100	<i>cF4</i>	<i>Fm$\bar{3}m$</i>
Metastable phase			
GePt₃	90 to 91	<i>tI16</i>	<i>I4/mcm</i>

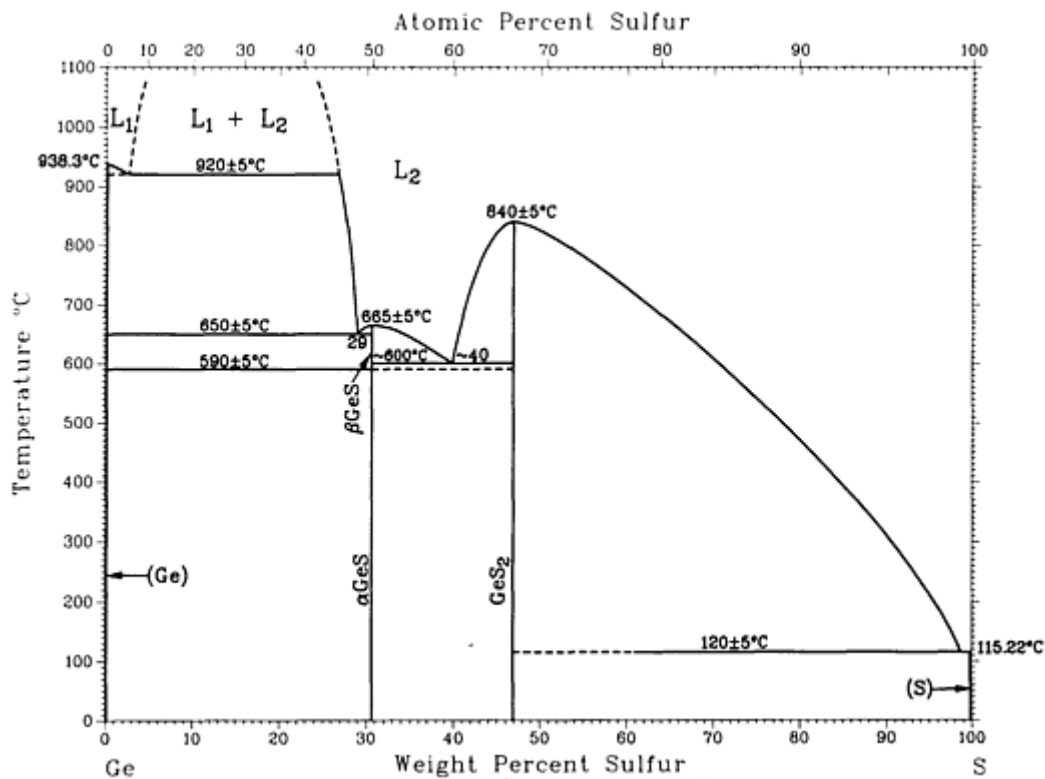

Ge-S phase diagram

Ge-S crystallographic data

Phase	Composition, wt% S	Pearson symbol	Space group
(Ge)	0	<i>cF8</i>	<i>Fd$\bar{3}m$</i>
β GeS	30.6	<i>h**</i>	...
α GeS	30.6	<i>oP8</i>	<i>Pnma</i>
GeS ₂	46.9	<i>oF72</i>	<i>Fdd2</i>

Ge-Sb (Germanium - Antimony)

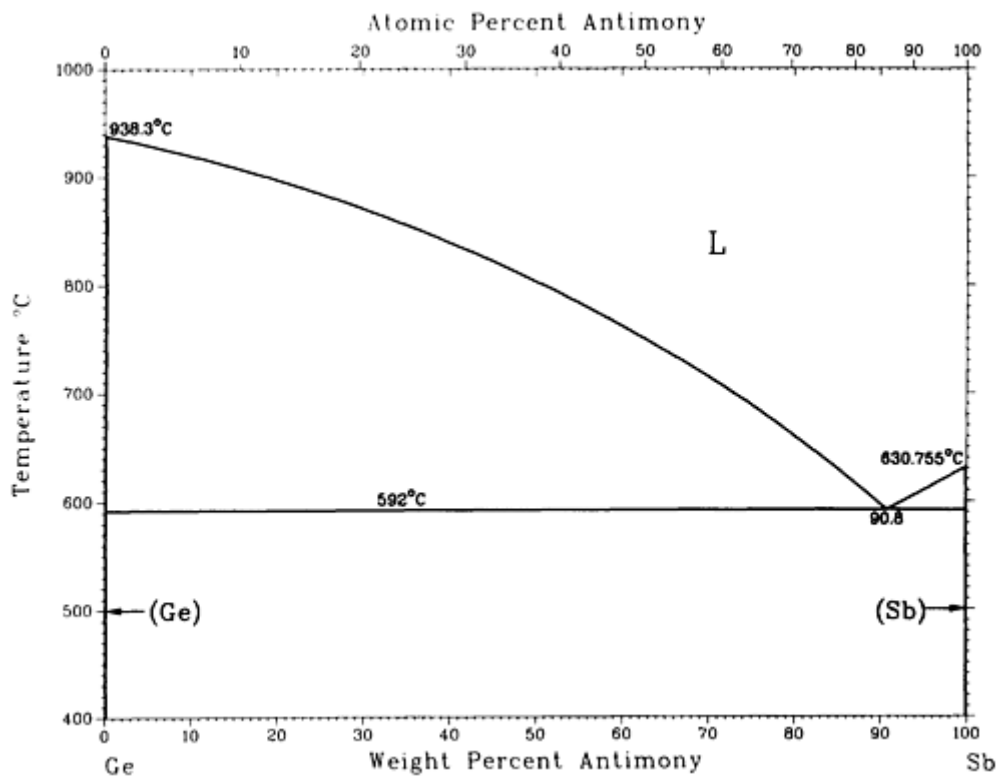

Ge-Sb phase diagram

Ge-Sb crystallographic data

Phase	Composition, wt% Sb	Pearson symbol	Space group
(Ge)	0	<i>cF8</i>	$Fd\bar{3}m$
(Sb)	100	<i>hR2</i>	$R\bar{3}m$

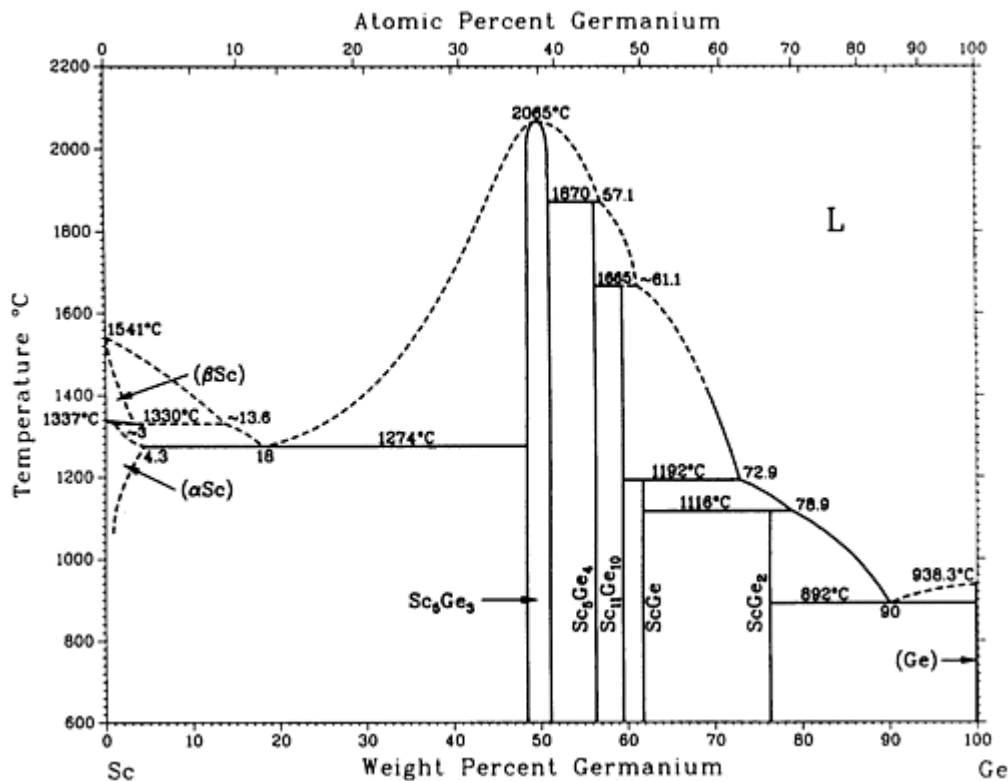

Ge-Sc phase diagram

Ge-Sc crystallographic data

Phase	Composition, wt% Ge	Pearson symbol	Space group
(βSc)	0 to ~3	cI2	$Im\bar{3}m$
(αSc)	0 to 4.3	hP2	$P6_3/mmc$
Sc ₅ Ge ₃	48.1 to 50.3	hP16	$P6_3/mcm$
Sc ₅ Ge ₄	56.4
Sc ₁₁ Ge ₁₀	59.5	...	$I4/mmm$
ScGe	61.8	oC8	$Cmcm$
ScGe ₂	76.4	oC12	$Cmcm$
(Ge)	~100	cF8	$Fd\bar{3}m$

Ge-Se (Germanium - Selenium)

A.B. Gokhale and G.J. Abbaschian, 1990

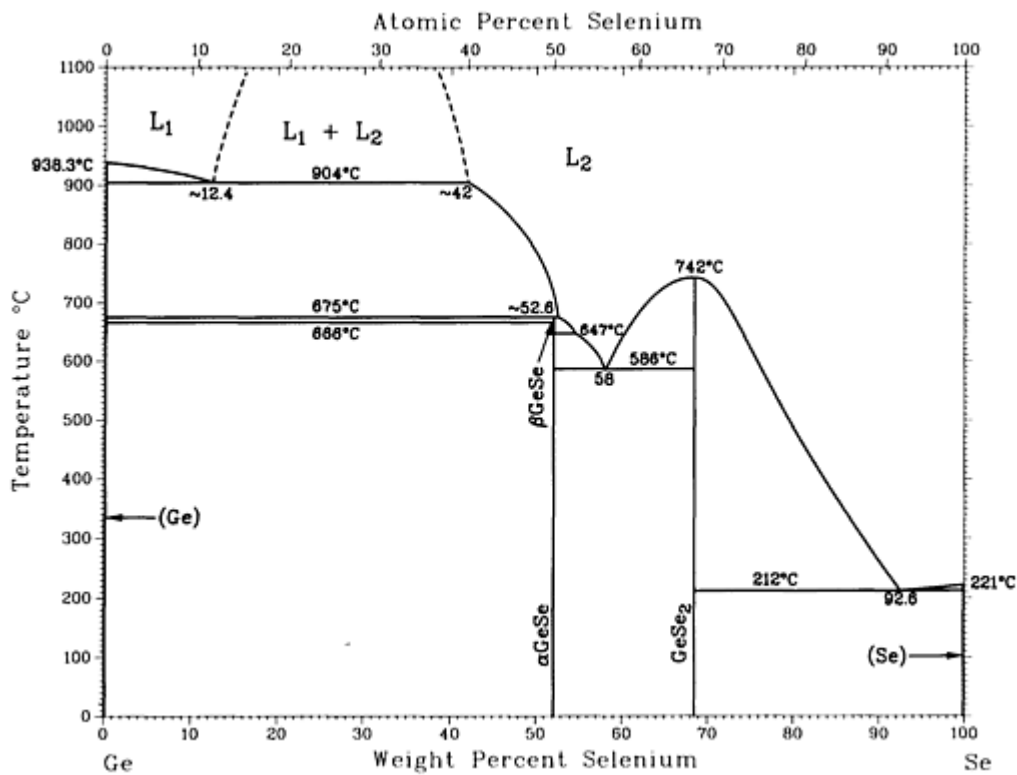

Ge-Se phase diagram

Ge-Se crystallographic data

Phase	Composition, wt% Se	Pearson symbol	Space group
(Ge)	0	<i>cF8</i>	<i>Fd</i> $\bar{3}m$
α-GeSe	52.1	<i>oC8</i>	<i>Cmca</i>
β-GeSe	52.1	<i>cF8</i>	<i>Fm</i> $\bar{3}m$
GeSe ₂	68.51
(Se)	100	<i>hP3</i>	<i>P3</i> ₁ 21

(a) Note: Crystal structures of the low-temperature α and β forms

of Se are not known.

Ge-Si (Germanium - Silicon)

R.W. Olesinski and G.J. Abbaschian, 1984

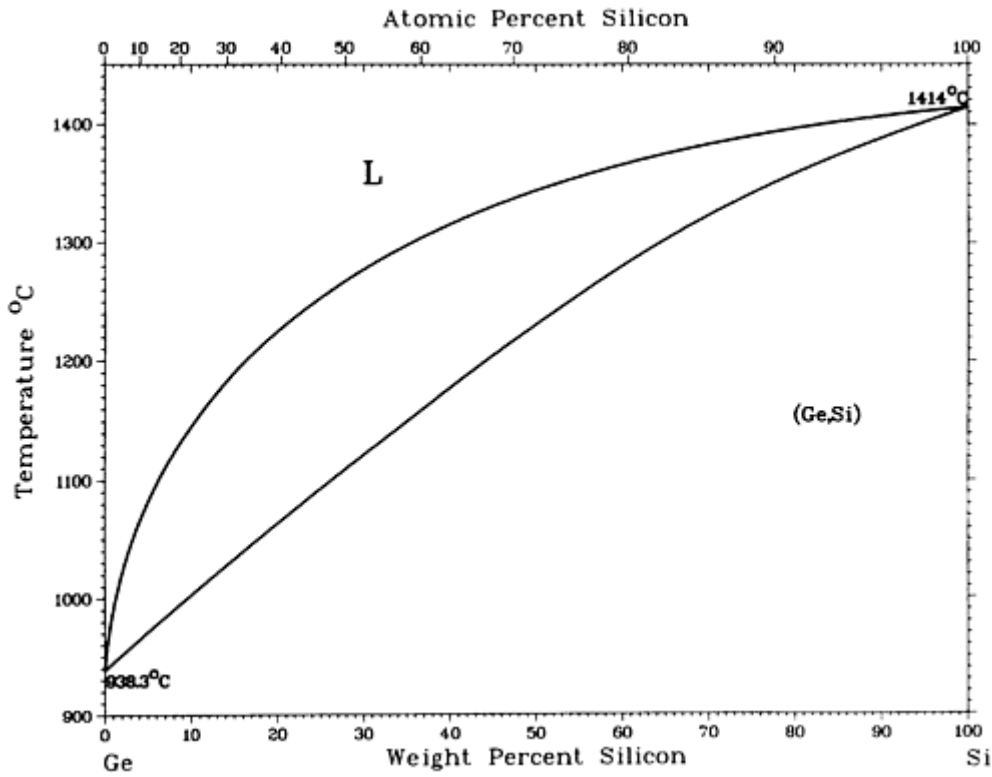

Ge-Si phase diagram

Ge-Si crystallographic data

Phase	Composition, wt% Si	Pearson symbol	Space group
(Ge,Si)	0 to 100	<i>cF8</i>	$Fd\bar{3}m$
High-pressure phases			
GeII	...	<i>tI4</i>	$I4_1/amd$
SiII	...	<i>tI4</i>	$I4_1/amd$

Ge-Sm (Germanium - Samarium)

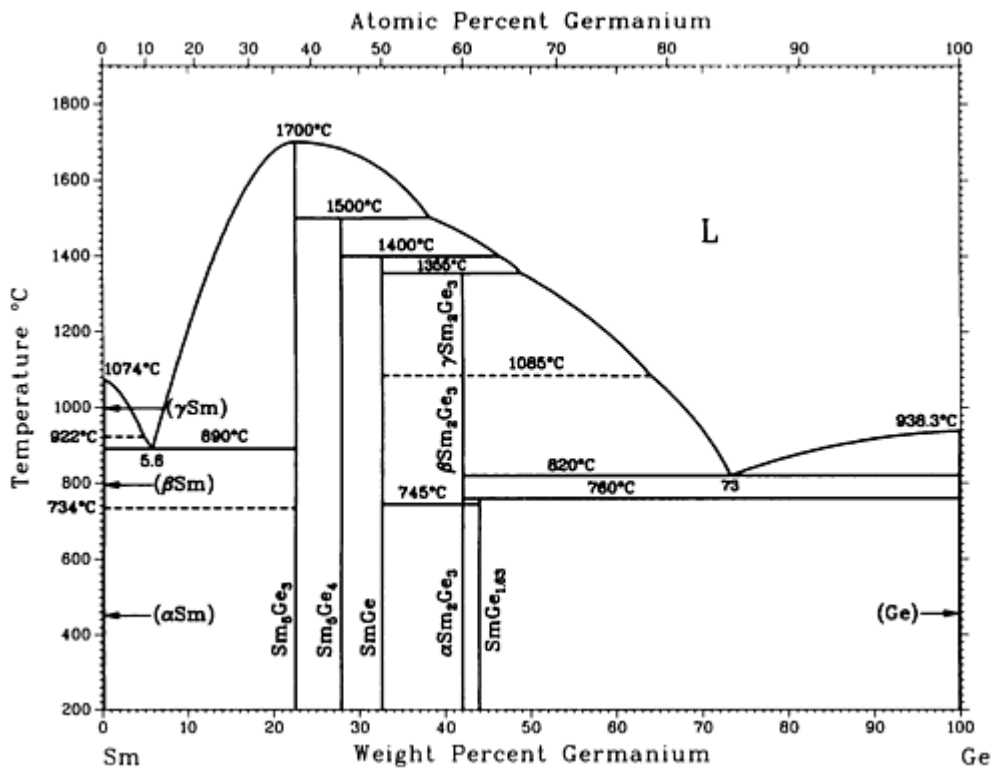

Ge-Sm phase diagram

Ge-Sm crystallographic data

Phase	Composition, wt% Ge	Pearson symbol	Space group
(γSm)	0	<i>cI2</i>	<i>Im</i> $\bar{3}m$
(βSm)	0	<i>hP2</i>	<i>P6</i> ₃ / <i>mmc</i>
(αSm)	0	<i>hR3</i>	<i>R</i> $\bar{3}m$
Sm ₅ Ge ₃	22.5	<i>hP16</i>	<i>P6</i> ₃ / <i>mcm</i>
Sm ₅ Ge ₄	27.9	<i>oP*</i>	<i>Pnma</i>
SmGe	32.6	<i>oC8</i>	<i>Cmcm</i>
γSm ₂ Ge ₃	42
βSm ₂ Ge ₃	42

$\alpha\text{Sm}_2\text{Ge}_3$	42	<i>hP3</i>	<i>P6/mmm</i>
$\text{SmGe}_{1.63}$	44	<i>tI12</i>	<i>I4_1/amd</i>
(Ge)	100	<i>cF8</i>	<i>Fd\bar{3}m</i>

Ge-Sn (Germanium - Tin)

R.W. Olesinski and G.J. Abbaschian, 1984

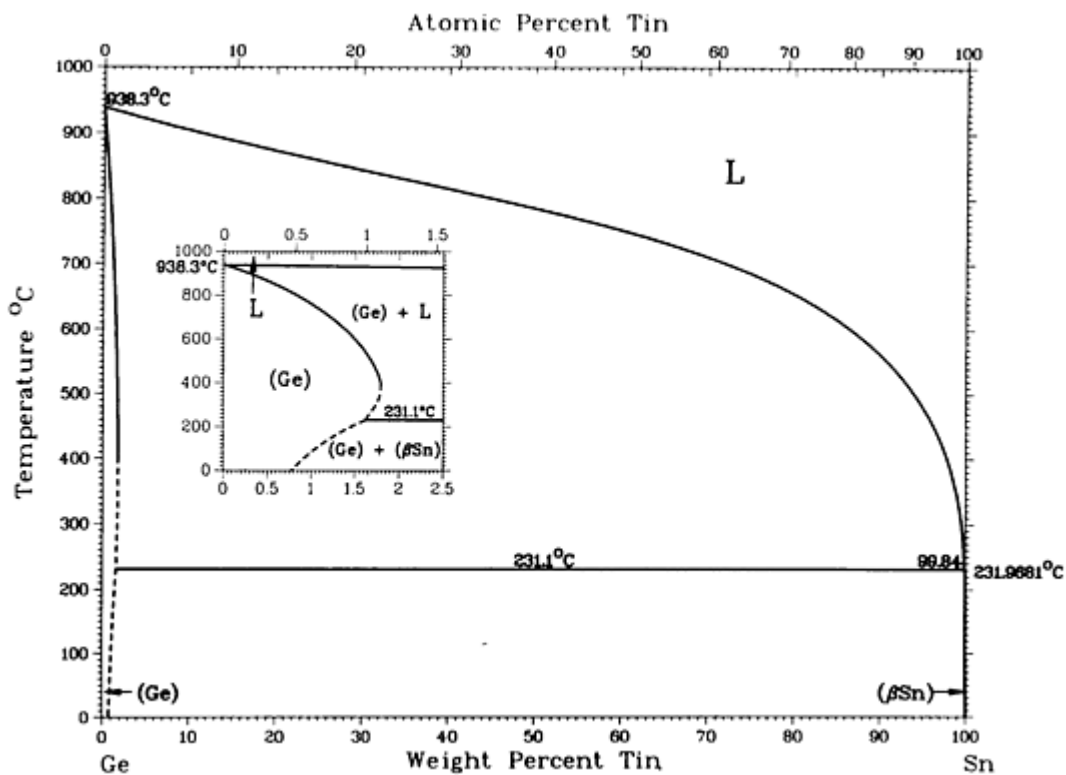

Ge-Sn phase diagram

Ge-Sn crystallographic data

Phase	Composition, wt% Sn	Pearson symbol	Space group
(Ge)	0 to 1.8	<i>cF8</i>	<i>Fd\bar{3}m</i>
(β Sn)	100	<i>tI4</i>	<i>I4_1/amd</i>
(α Sn)	100	<i>cF8</i>	<i>Fd\bar{3}m</i>

Pressure stabilized phase			
GeII	0 to 15	<i>tI4</i>	<i>I4₁/amd</i>
Crystallized from amorphous phase			
Ge_ySn_{1-y}	42 to 62.0	<i>cF8</i>	<i>F4_{3m}</i>

Ge-Sr (Germanium - Strontium)

P.R. Subramanian, 1990

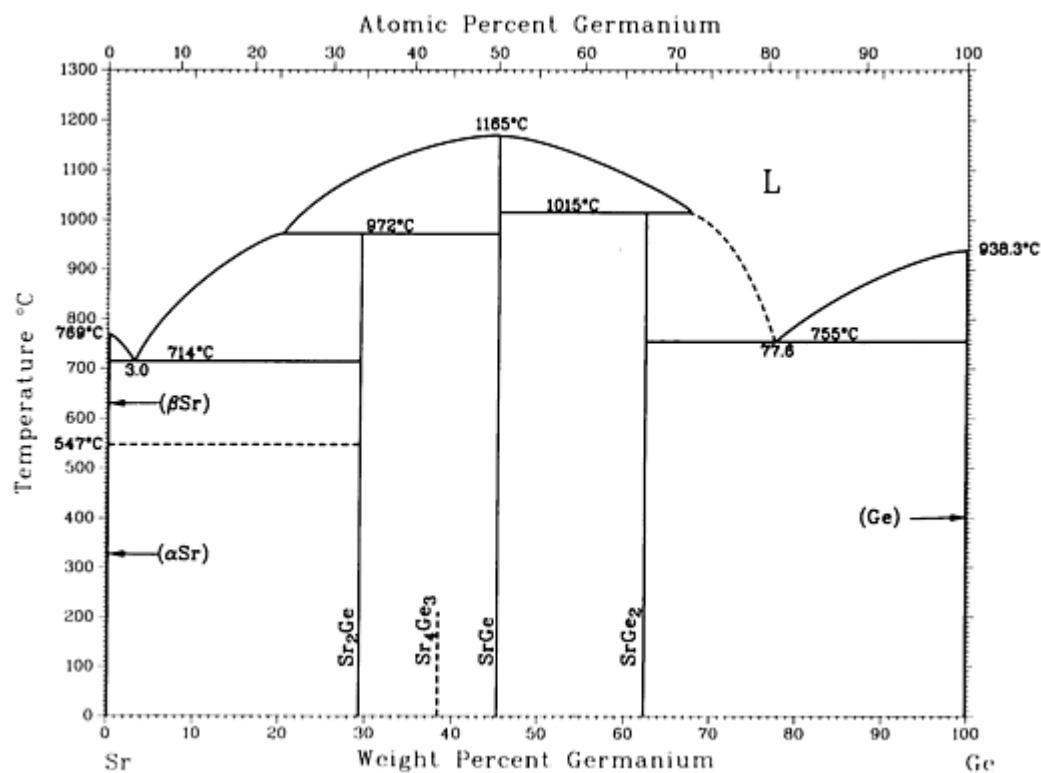

Ge-Sr phase diagram

Ge-Sr crystallographic data

Phase	Composition, wt% Ge	Pearson symbol	Space group
(αSr)	0	<i>cF4</i>	<i>Fm3̄m</i>
(βSr)	0	<i>cI2</i>	<i>Im3̄m</i>

Sr₂Ge	29.3	<i>oP12</i>	<i>Pnma</i>
Sr₄Ge₃	~38.4	<i>oI40</i>	<i>Immm</i>
SrGe	45.3	<i>oC8</i>	<i>Cmcm</i>
SrGe₂	62.4	<i>oP24</i>	<i>Pnma</i>
(Ge)	100	<i>cF8</i>	<i>Fd$\bar{3}m$</i>

Ge-Tb (Germanium - Terbium)

H. Okamoto, 1990

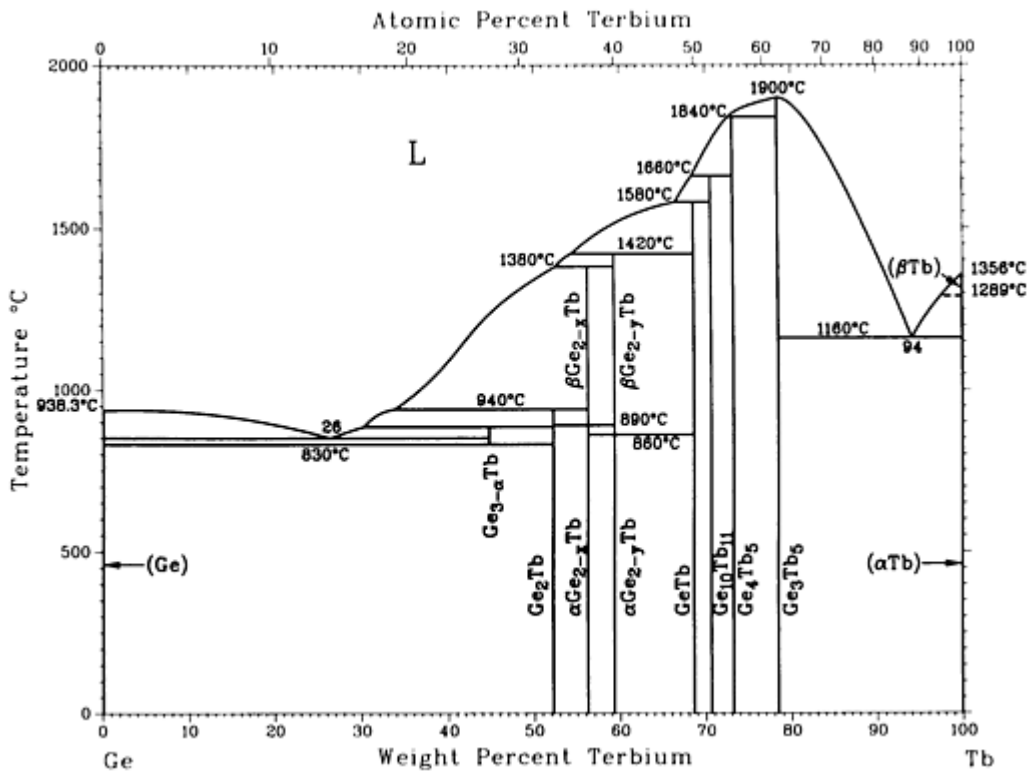

Ge-Tb phase diagram

Ge-Tb crystallographic data

Phase	Composition, wt% Tb	Pearson symbol	Space group
(Ge)	0	<i>cF8</i>	<i>Fd$\bar{3}m$</i>

Ge₃-αTb	45	<i>oC18</i>	<i>C222₁</i>
Ge₂Tb	52.2
<i>β</i> Ge _{2-x} Tb	56	<i>tI12</i>	<i>I4₁/amd</i>
<i>α</i> Ge _{2-x} Tb	56
<i>β</i> Ge _{2-y} Tb	59	<i>hP3</i>	<i>P6/mmm</i>
<i>α</i> Ge _{2-y} Tb	59
GeTb	68.6	<i>oC8</i>	<i>Cmcm</i>
Ge₁₀Tb₁₁	70.7	<i>tI84</i>	<i>I4/mmm</i>
Ge₄Tb₅	73.3	<i>oP36</i>	<i>Pnma</i>
GeTb₅	78.5	<i>hP16</i>	<i>P6₃/mcm</i>
(Tb)	100	<i>hP2</i>	<i>P6₃/mmc</i>

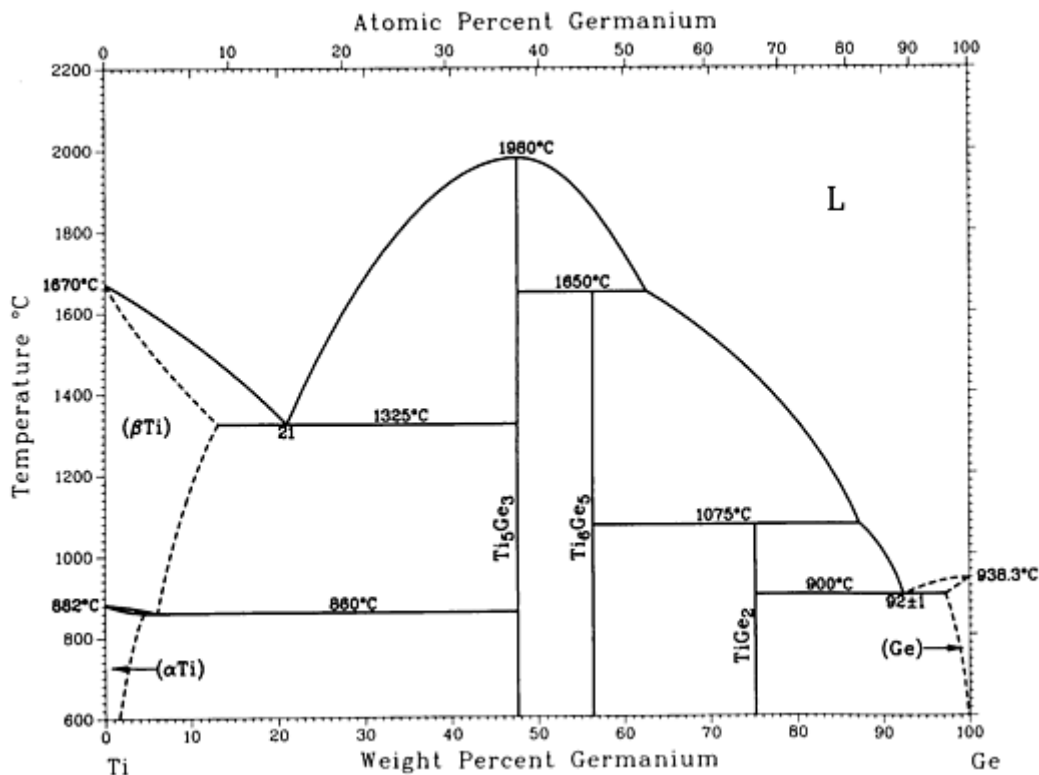

Ge-Ti phase diagram

Ge-Ti crystallographic data

Phase	Composition, wt% Ge	Pearson symbol	Space group
(βTi)	0 to ?	<i>cI2</i>	<i>Im</i> $\bar{3}m$
(αTi)	0 to ?	<i>hP2</i>	<i>P6₃/mmc</i>
Ti ₅ Ge ₃	47.6	<i>hP16</i>	<i>P6₃/mcm</i>
Ti ₆ Ge ₅	55.9	<i>oI44</i>	<i>Immm</i>
TiGe ₂	75.2	<i>oF24</i>	<i>Fddd</i>
(Ge)	100	<i>cF8</i>	<i>Fm</i> $\bar{3}m$

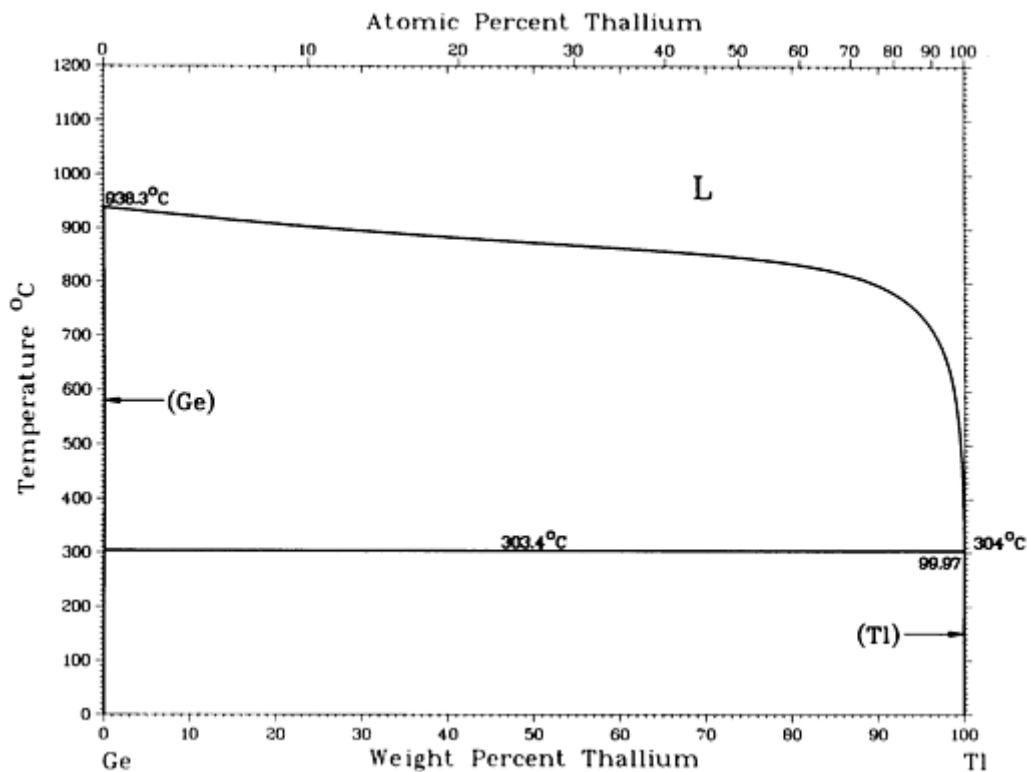

Ge-Tl phase diagram

Ge-Tl crystallographic data

Phase	Composition, wt% Tl	Pearson symbol	Space group
(Ge)	0.06	<i>cF8</i>	$Fd\bar{3}m$
(β Tl)	99.97 to 100	<i>cI2</i>	$Im\bar{3}m$
(α Tl)	100	<i>hP2</i>	$P6_3/mmc$

Ge-Tm (Germanium - Thulium)

H. Okamoto, 1990

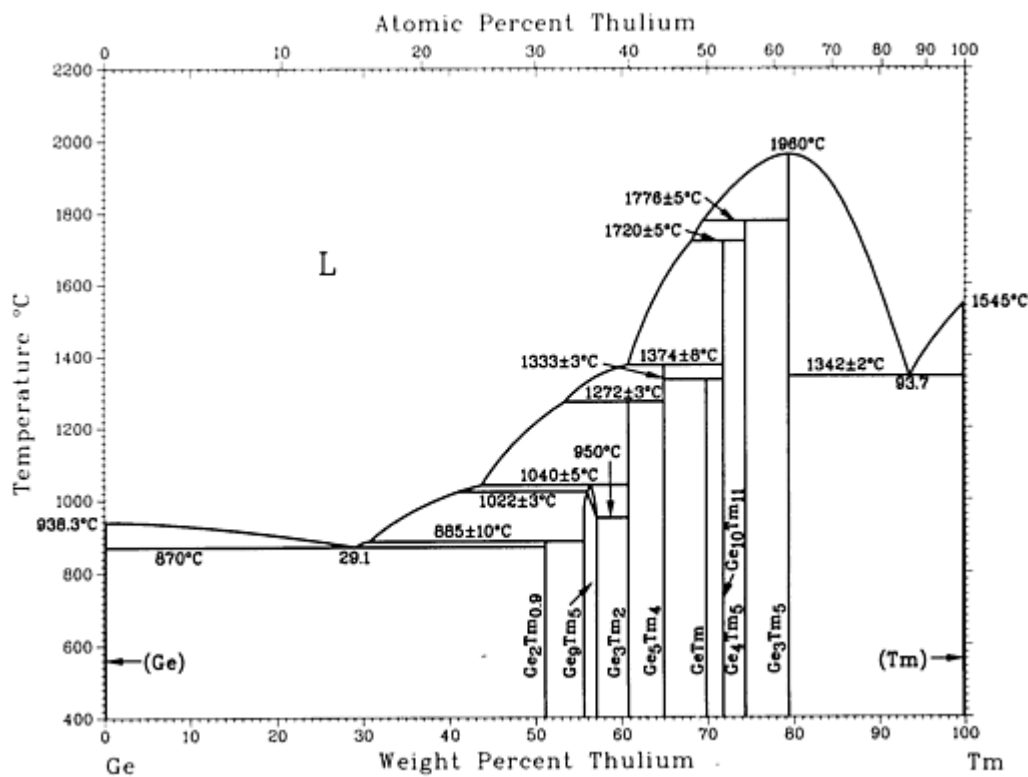

Ge-Tm phase diagram

Ge-Tm crystallographic data

Phase	Composition, wt% Tm	Pearson symbol	Space group
(Ge)	0	<i>cF8</i>	<i>Fd$\bar{3}m$</i>
$\text{Ge}_2\text{Tm}_{0.9}$	51	<i>oC12</i>	<i>Cmcm</i>
$\beta\text{Ge}_9\text{Tm}_5$	56.4
$\alpha\text{Ge}_9\text{Tm}_5$	56.4
Ge_3Tm_2	61	<i>hP3</i>	<i>P6/mmm</i>
Ge_5Tm_4	65.0
GeTm	69.9	<i>oC8</i>	<i>Cmcm</i>

$\text{Ge}_{10}\text{Tm}_{11}$	71.9	<i>tI84</i>	<i>I4/mmm</i>
Ge_4Tm_5	74.4	<i>oP36</i>	<i>Pnma</i>
Ge_3Tm_5	79.5	<i>hP16</i>	<i>P6_3/mcm</i>
(Tm)	100	<i>hP2</i>	<i>P6_3/mmc</i>

Ge-U (Germanium - Uranium)

V.S. Lyashenko and V. Bykov, 1960

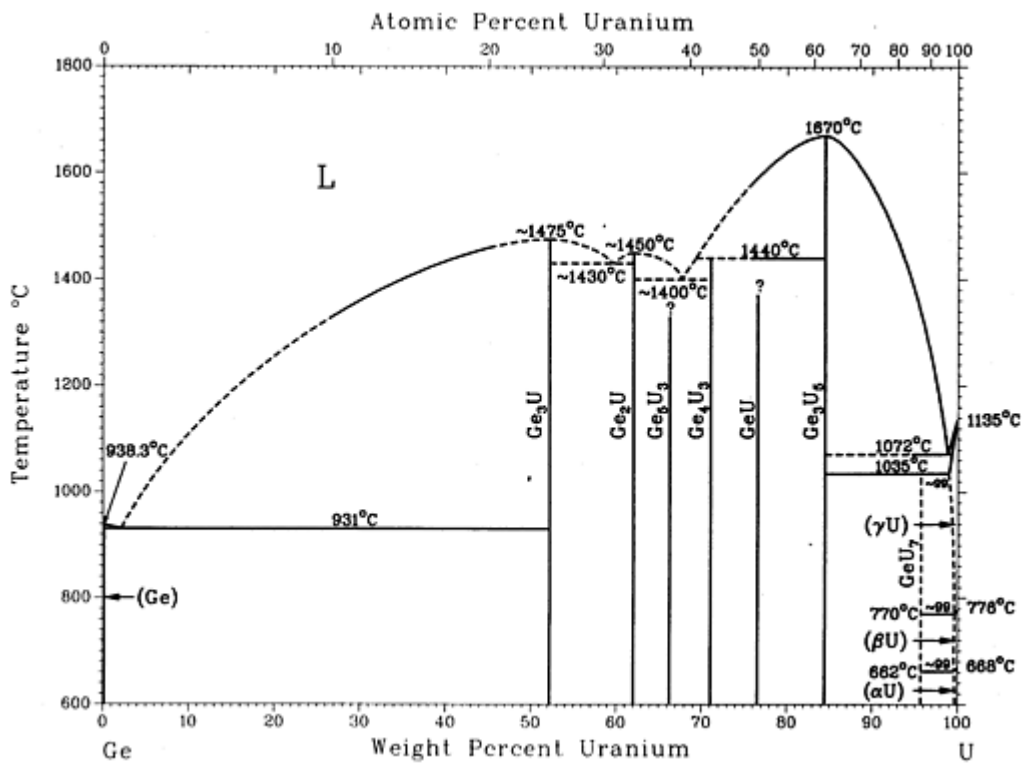

Ge-U phase diagram

Ge-U crystallographic data

Phase	Composition, wt% U	Pearson symbol	Space group
(Ge)	0	<i>cF8</i>	$Fd\bar{3}m$
Ge_3U	52	<i>cP4</i>	$Pm\bar{3}m$

Ge_2U	62.1	$hP3$ or $oC12$	$P6/mmm$ $Cmcm$
Ge_5U_3	66.3
Ge_4U_3	71.1	o^{**}	...
GeU	76.6
Ge_3U_5	84.5	$hP16$	$P6_3/mcm$
GeU_7	95.8
(γU)	~ 99 to 100	$cI2$	$Im\bar{3}m$
(βU)	~ 99 to 100	$tP30$	PA_2/mnm
(αU)	~ 99 to 100	$oC4$	$Cmcm$

Ge-Y (Germanium - Yttrium)

A.B. Gokhale and G.J. Abbaschian, 1988

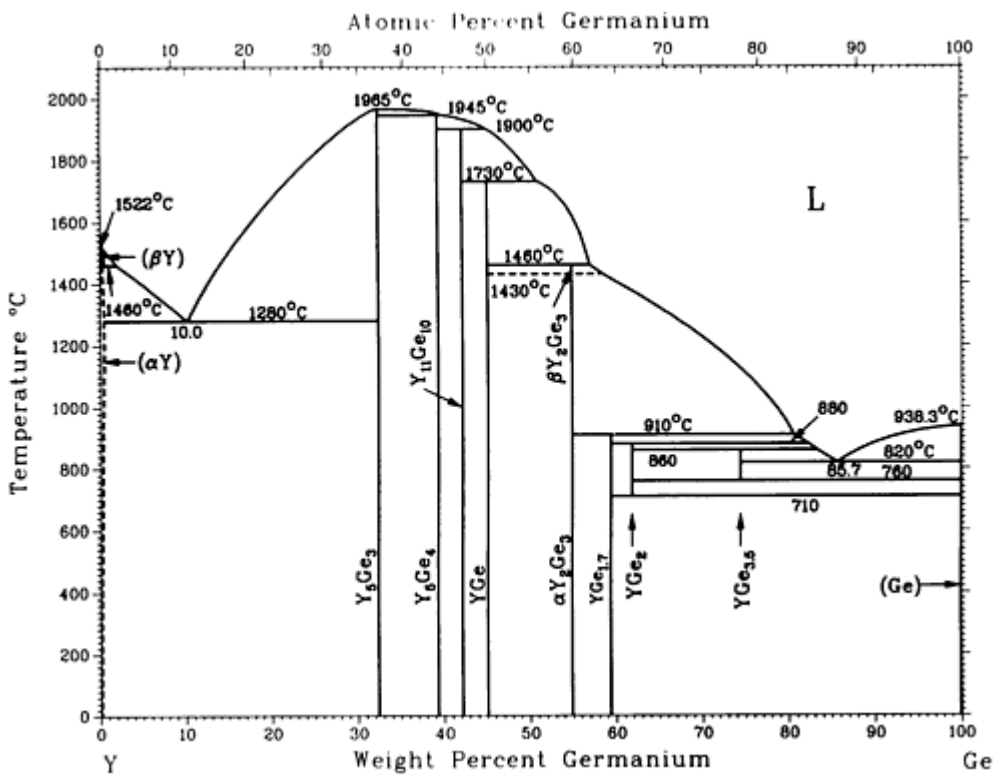

Ge-Y phase diagram

Ge-Y crystallographic data

Phase	Composition, wt% Ge	Pearson symbol	Space group
(α Y)	0 to \sim 0.81	<i>hP2</i>	<i>P6₃/mmc</i>
(β Y)	0 to \sim 0.81	<i>cI2</i>	<i>Im$\bar{3}m$</i>
Y ₅ Ge ₃	32.9	<i>hP16</i>	<i>P6₃/mcm</i>
Y ₅ Ge ₄	39.52	<i>oP36</i>	<i>Pnma</i>
Y ₁₁ Ge ₁₀	42.6	<i>tI84</i>	<i>I4/mmm</i>
YGe	45.0	<i>oC8</i>	<i>Cmcm</i>
β Y ₂ Ge ₃	55	...	<i>Pccm</i> ^(a)
α Y ₂ Ge ₃	55	<i>hP3</i>	<i>P6/mmm</i>
β Y ₃ Ge ₅	57.6	<i>oF72</i>	<i>Fdd2</i>
α Y ₃ Ge ₅	57.6	<i>tI12</i>	<i>I4₁/amd</i>
YGe ₂	62.03	<i>oC12</i>	<i>Cmcm</i>
Y ₂ Ge ₇	74.09	...	<i>C222₁</i> ^(a)
(Ge)	0 to \sim 0.4	<i>cF8</i>	<i>Fd$\bar{3}m$</i>

(a) Tentative

Ge-Yb (Germanium - Ytterbium)

V.N. Eremenko, K.A. Meleshevich, and Yu.I. Buyanov, 1983

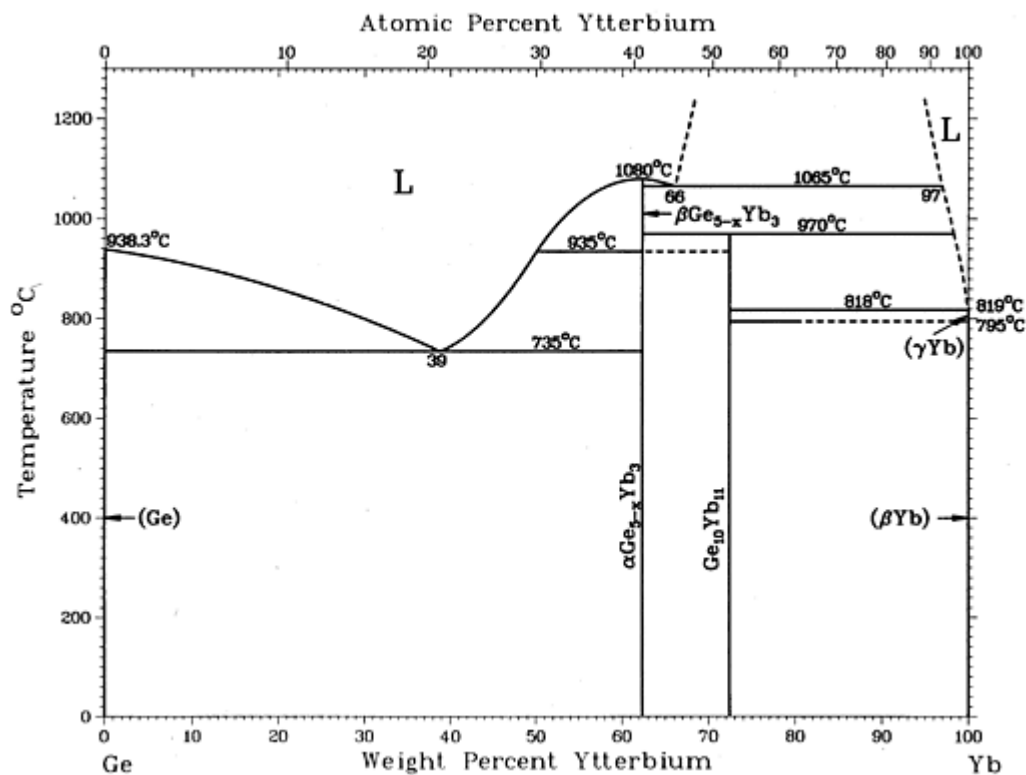

Ge-Yb phase diagram

Ge-Yb crystallographic data

Phase	Composition, wt% Yb	Pearson symbol	Space group
(Ge)	0	<i>cF8</i>	$Fd\bar{3}m$
$\beta\text{Ge}_{5-x}\text{Yb}$	~61	<i>hP3</i>	<i>P6/mmm</i>
$\alpha\text{Ge}_{5-x}\text{Yb}$	~61	<i>hP8</i>	$P\bar{6}2m$
$\text{Ge}_{10}\text{Yb}_{11}$	72.3	<i>tI84</i>	<i>I4/mmm</i>
(γYb)	100	<i>cI2</i>	$Im\bar{3}m$
(βYb)	100	<i>cF4</i>	$Fm\bar{3}m$
(αYb)	100	<i>hP2</i>	$P6_3/mmc$

Ge-Zn (Germanium - Zinc)

R.W. Olesinski and G.J. Abbaschian, 1985

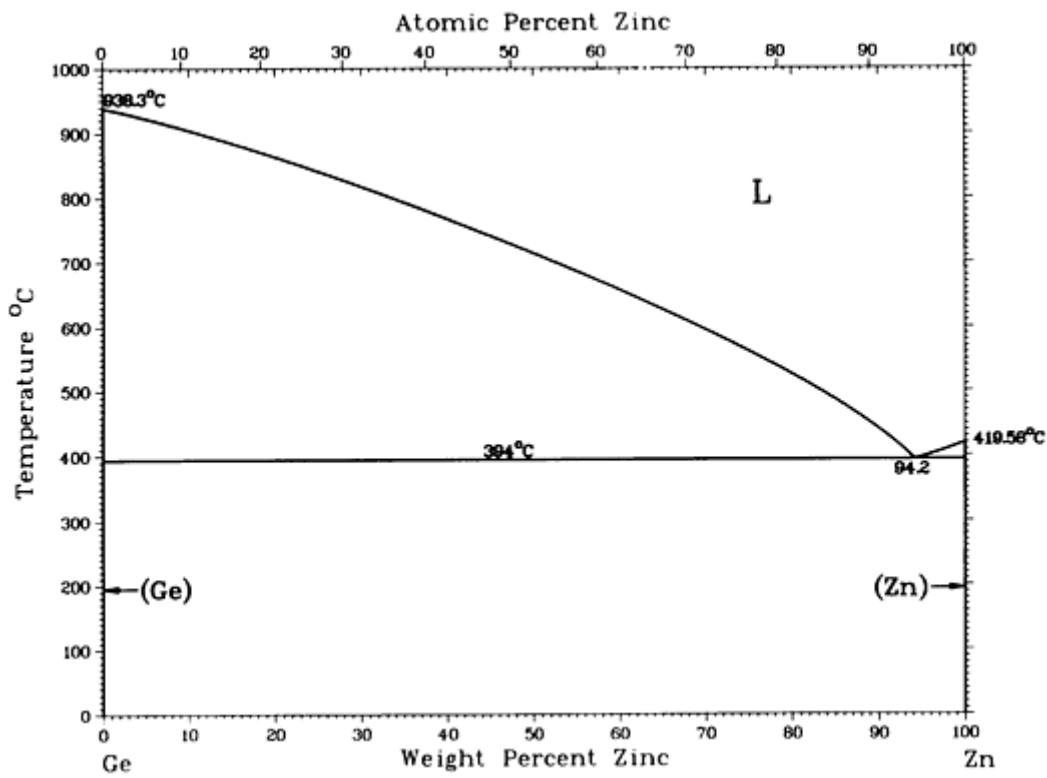

Ge-Zn phase diagram

Ge-Zn crystallographic data

Phase	Composition, wt% Zn	Pearson symbol	Space group
(Ge)	0	$cF8$	$Fd\bar{3}m$
(Zn)	100	$hP2$	$P6_3/mmc$

H (Hydrogen) Binary Alloy Phase Diagrams

Introduction

THIS ARTICLE includes systems where hydrogen is the first-named element in the binary pair. Additional binary systems that include hydrogen are provided in the following locations in this Volume:

- “Al-H (Aluminum - Hydrogen)” in the article “Al (Aluminum) Binary Alloy Phase Diagrams.”
- “Ba-H (Barium - Hydrogen)” in the article “Ba (Barium) Binary Alloy Phase Diagrams.”
- “Cu-H (Copper - Hydrogen)” in the article “Cu (Copper) Binary Alloy Phase Diagrams.”
- “Fe-H (Iron - Hydrogen)” in the article “Fe (Iron) Binary Alloy Phase Diagrams.”

H-La (Hydrogen - Lanthanum)

D. Khatamian and F.D. Manchester, 1990

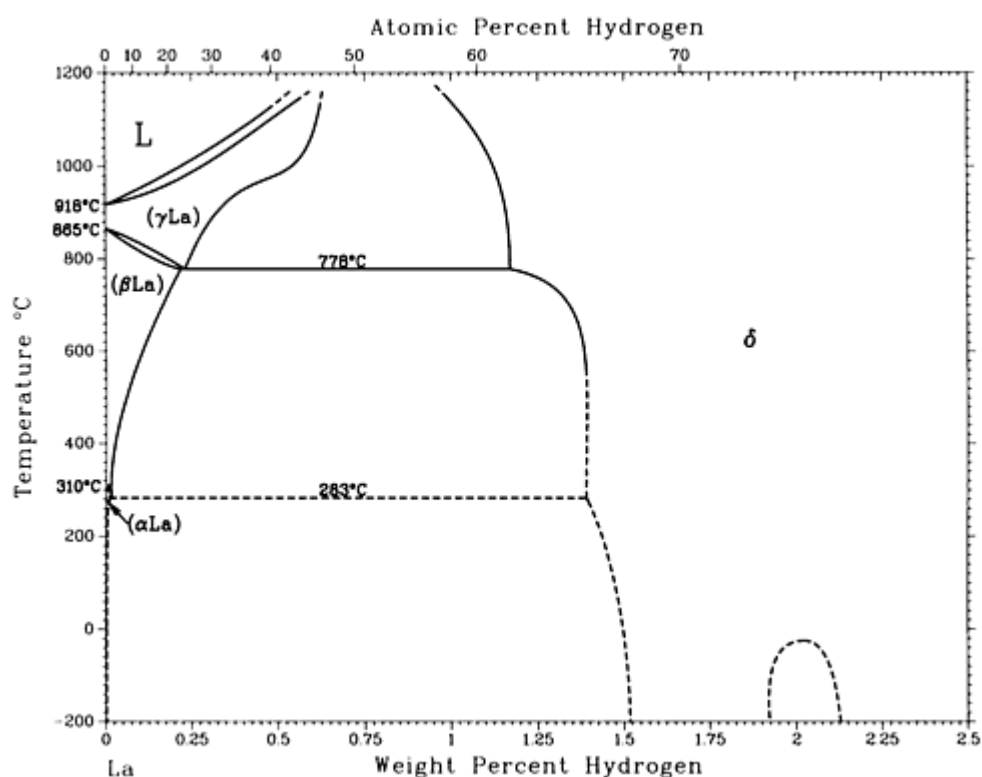

H-La phase diagram

H-La crystallographic data

Phase	Composition, wt% H	Pearson symbol	Space group
(γ La) ^(a)	0 to 0.6	<i>cI2</i>	<i>Im$\bar{3}m$</i>
(β La) ^(b)	0 to 0.2	<i>cF4</i>	<i>Fm$\bar{3}m$</i>
(α La) ^(c)	0 to 0.01	<i>hP4</i>	<i>P6</i> ₃ / <i>mmc</i>

δ	1 to 2	$cF16$	$Fm\bar{3}m$
----------	--------	--------	--------------

- (a) From 865 to 918 °C at 0 at.% H.
- (b) From 310 to <865 °C at 0 at.% H.
- (c) Up to <310 °C at 0 at.% H

H-Nb (Hydrogen - Niobium)

J.F. Smith, 1983

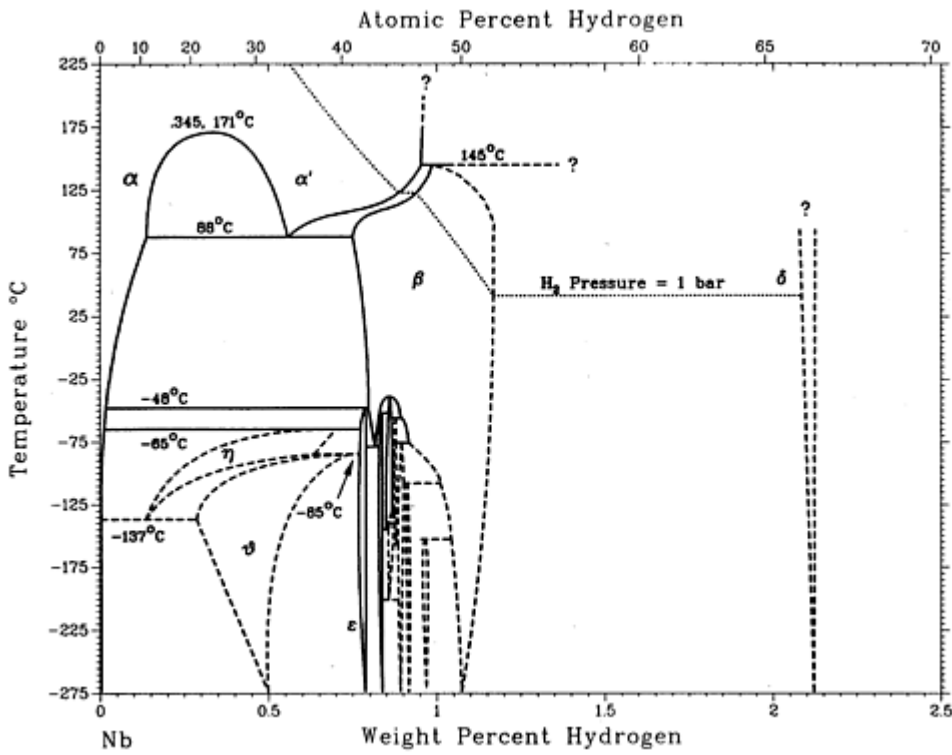

H-Nb phase diagram

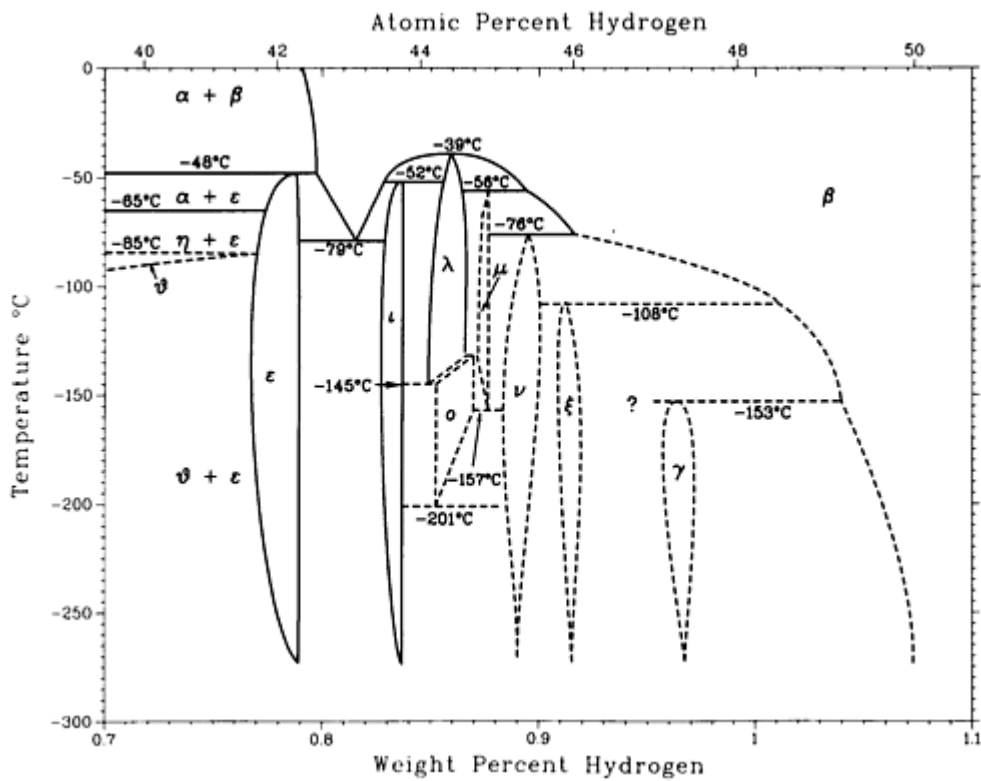

Peritectoid cascade region of the Nb-H phase diagram

H-Nb crystallographic data

Phase	Composition, wt% H	Pearson symbol	Space group
α, α'	0 to 470.95	<i>cI2</i>	$Im\bar{3}m$
η	~ 0.13 to ~ 0.69
θ	~ 0.29 to ~ 0.75
β	0.75 to ~ 1.2	<i>oP8</i>	...
ϵ	~ 0.78	<i>oP28</i>	;
$\iota, \lambda, \omicron, \mu, \nu, \xi$	~ 0.83 to 0.92	(a)	...
γ	~ 0.96	(b)	...
δ	~ 2.13	<i>cF12</i>	$Fm\bar{3}m$

- (a) H-deficient β structure having ordering of H atoms.
- (b) Possibly a face-centered tetragonal structure

H-Nd (Hydrogen - Neodymium)

P.R. Subramanian, 1990

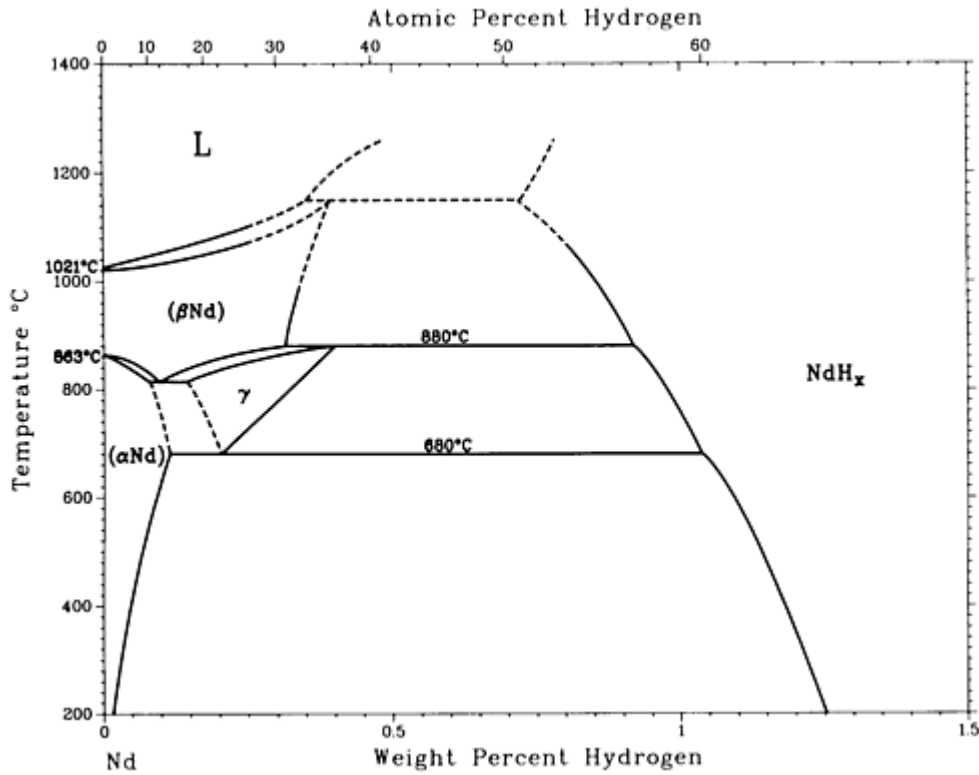

H-Nd phase diagram

H-Nd crystallographic data

Phase	Composition, wt% H	Pearson symbol	Space group
(β Nd)	0	<i>cI2</i>	<i>Im</i> $\bar{3}m$
(α Nd)	0	<i>hP4</i>	<i>P6</i> $\bar{3}/mmc$
$\gamma^{(a)}$	~0.15 to 0.43
NdH ₂ ^(b)	~1.38	<i>cF12</i>	<i>Fm</i> $\bar{3}m$

$\text{Nd}_2\text{H}_5^{(b) (c)}$	~ 1.6	$tI28$ $tI40$	$I4_1md$ $I4_1md$
-----------------------------------	------------	------------------	----------------------

(a) High-temperature phase; exists between 680 and 880 °C.

(b) Not shown in the phase diagram.

(c) Ideal stoichiometry; structure based on neutron-diffraction studies on samples with the composition $\text{NdD}_{2.36}$

H-Ni (Hydrogen - Nickel)

M.L. Wayman and G.C. Weatherly, 1991

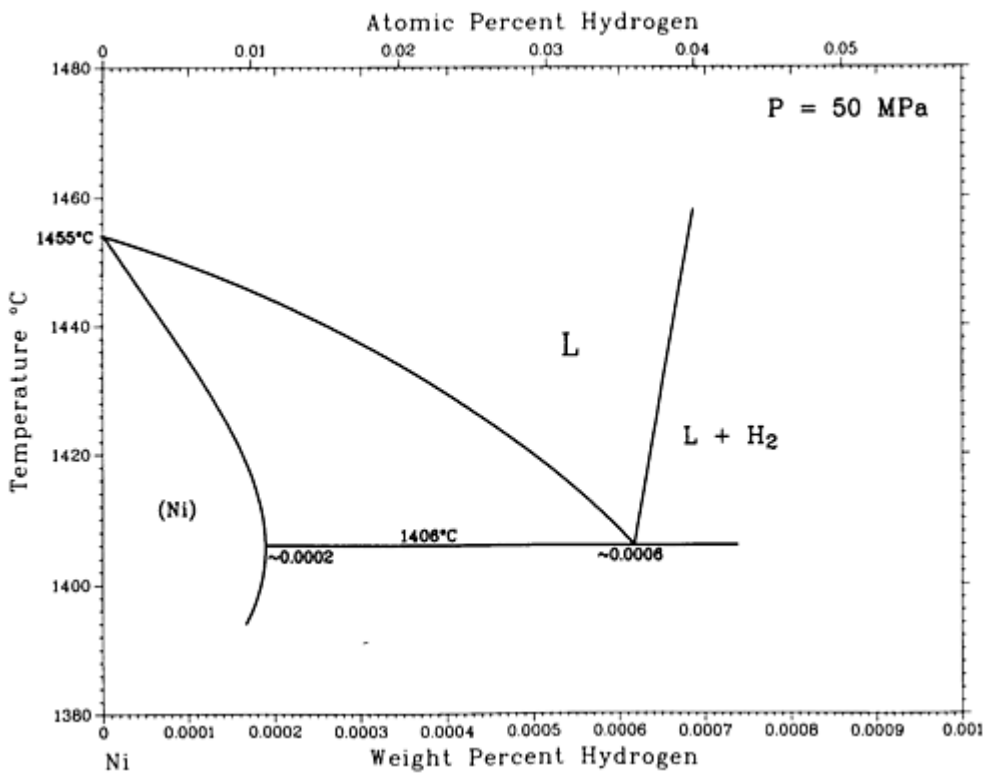

H-Ni phase diagram

H-Ni crystallographic data

Phase	Composition, wt% H	Pearson symbol	Space group
(Ni)	0 to ~ 0.0002	$cF4$	$Fm\bar{3}m$

H-Pd (Hydrogen - Palladium)

A. San-Martin and F.D. Manchester, unpublished

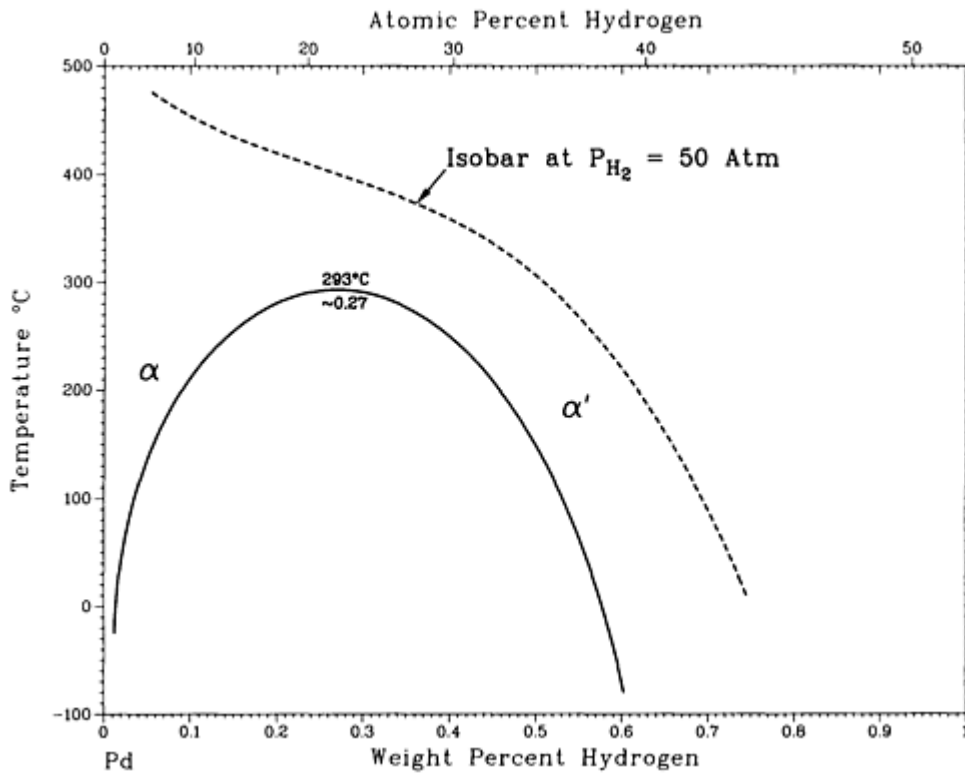

H-Pd phase diagram

H-Pd crystallographic data

Phase	Composition, wt% H	Pearson symbol	Space group
(Pd)	0	$cF4$	$Fm\bar{3}m$
α or (Pd)	0 to 0.019 ^(a)	$cF8$	$Fm\bar{3}m$
α' or (Pd)	~ 0.567 ^(a)	^(b)	...
Low-temperature phases ^(c)			
A_2B_2	0.601	...	$I4_1/amd$
A_4B	0.715	$tI10$	$I4/m$

(a) At 25 °C.

(b) fcc.

(c) Below 100 K

H-Sr (Hydrogen - Strontium)

D.T. Peterson and R.P. Colburn, 1964

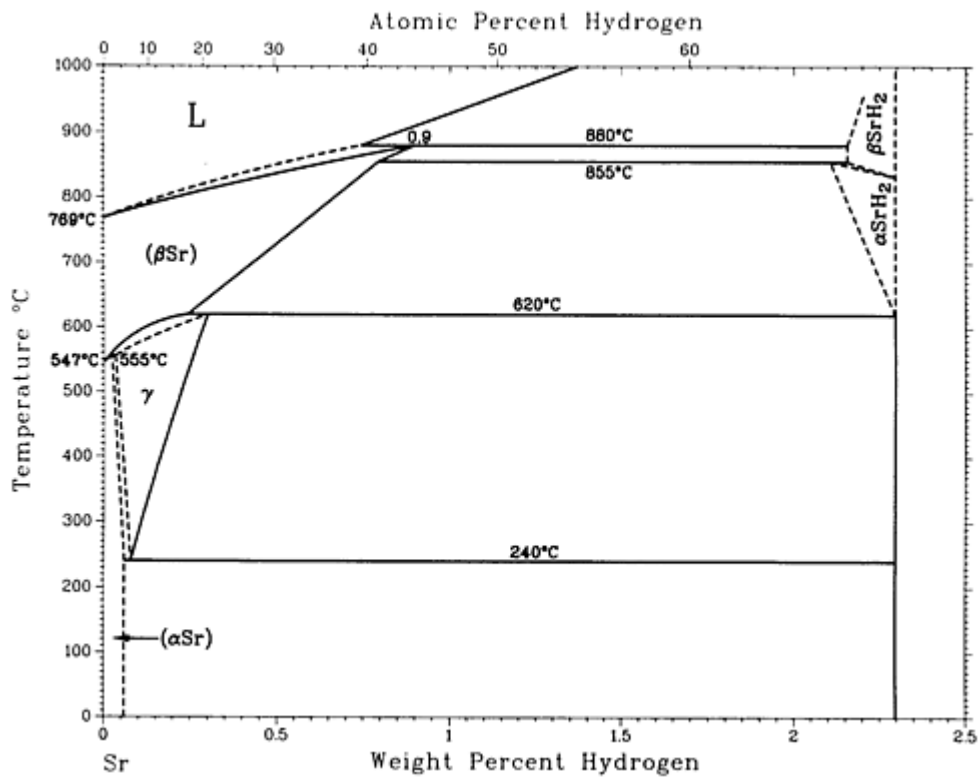

H-Sr phase diagram

H-Sr crystallographic data

Phase	Composition, wt% H	Pearson symbol	Space group
(βSr)	0 to 0.9	<i>cI2</i>	<i>Im</i> $\bar{3}m$
(αSr)	0 to ?	<i>cF4</i>	<i>Fm</i> $\bar{3}m$
γ	? to 0.3	<i>hP*</i>	...
βSrH ₂	2.3

αSrH_2	2.3	<i>oP12</i>	<i>Pnma</i>
----------------------	-----	-------------	-------------

H-Ta (Hydrogen - Tantalum)

A.San-Martin and F.D. Manchester, 1991

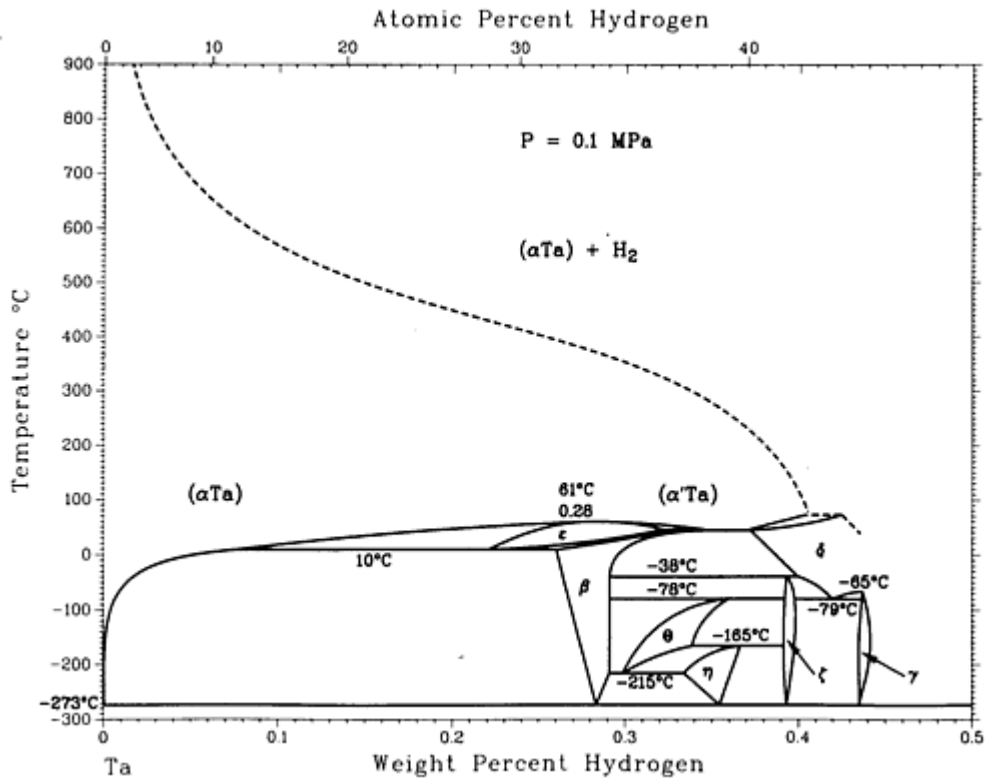

H-Ta phase diagram

H-Ta crystallographic data

Phase	Composition, wt% H	Pearson symbol	Space group
(α Ta)	0 to 0.28	<i>cI2</i>	$Im\bar{3}m$
(α' Ta)	0.28 to 0.42	<i>cI2</i>	$Im\bar{3}m$
ϵ	0.22 to 0.32	<i>mC*</i>	<i>C222</i>
β	0.26 to 0.35	<i>mC*</i>	<i>C222</i>
θ	0.30 to 0.36
η	0.34 to ~0.37

δ	0.37 to 0.438	oP^*	$Pnmm$
ζ	0.395 to ~ 0.398
γ	0.436 to 0.439

H-Ti (Hydrogen - Titanium)

H. Okamoto, 1992

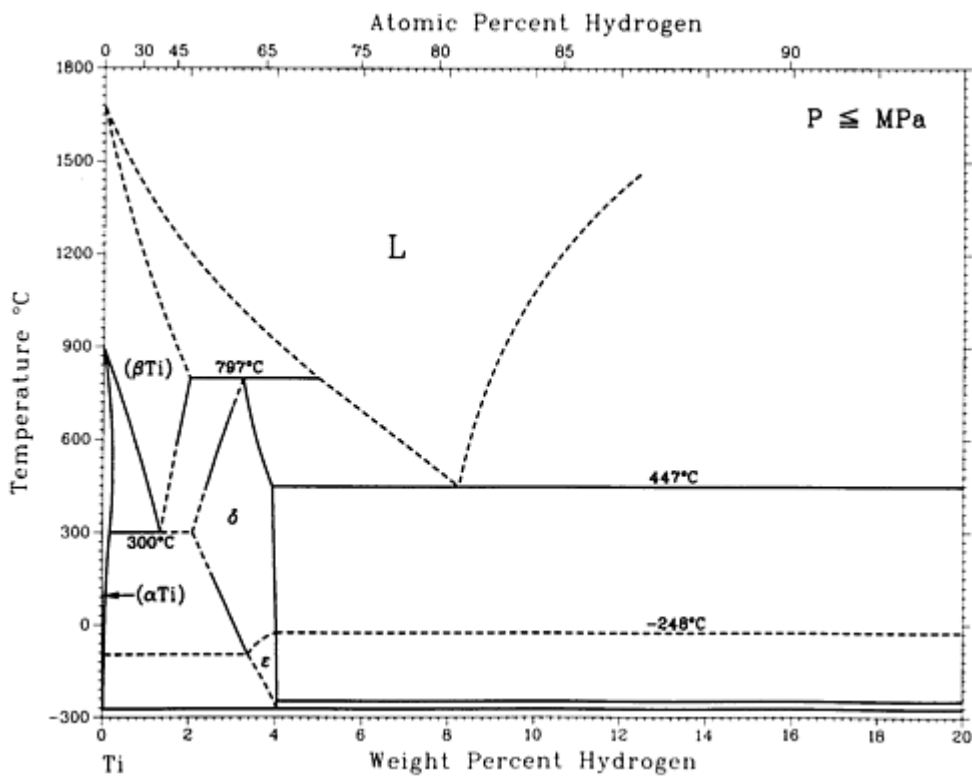

H-Ti phase diagram

H-Ti crystallographic data

Phase	Composition, wt% H	Pearson symbol	Space group
(β Ti)	0 to 2.06	$cI2$	$Im\bar{3}m$
(α Ti)	0 to 0.2	$hP2$	$P6_3/mmc$
δ	2.06 to 4.05	$cF12$	$Fm\bar{3}m$
ϵ	3.06 to 4.05	$tI6$	$I4/mmm$

H-U (Hydrogen - Uranium)

A. San-Martin and F.D. Manchester, unpublished

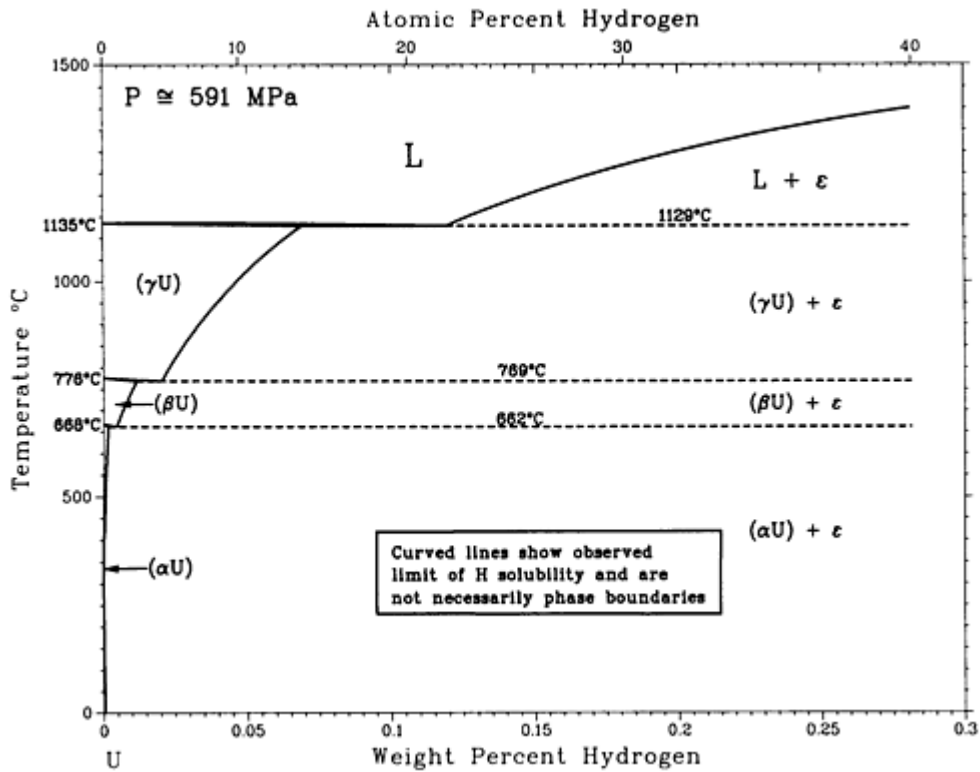

H-U phase diagram

H-U crystallographic data

Phase	Composition, wt% H	Pearson symbol	Space group
(γU)	0 to 0.069	$cI2$	$Im\bar{3}m$
(βU)	0 to 0.011	$tP30$	$P4_2/mnm$
(αU)	0 to 0.0014	$oC4$	$Cmcm$
ϵ	1.25	$cP32$	$Pm3n$
$\delta^{(a)}$	1.25	$cP8$	$Pm3n$

(a) Metastable phase

H-V (Hydrogen - Vanadium)

J.F. Smith and D.T. Peterson, 1989

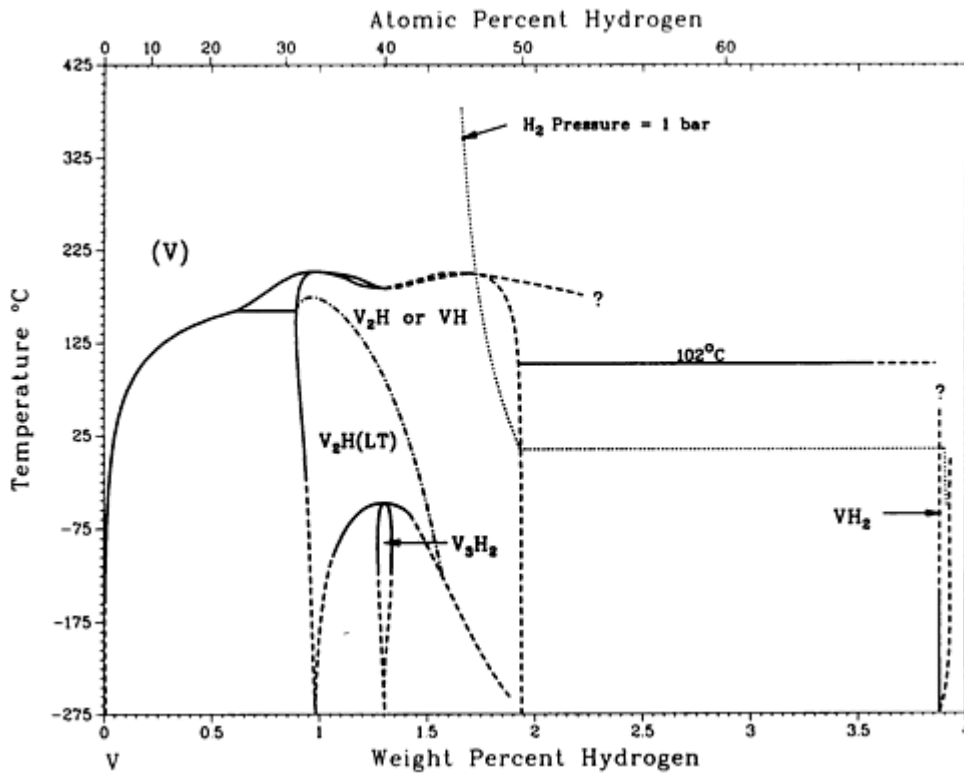

H-V phase diagram

H-V crystallographic data

Phase	Composition, wt% H	Pearson symbol	Space group
α or (V)	0 to ?	$cI2$	$Im\bar{3}m$
β_1 or $V_2H(LT)$	~ 0.97	$mC6$	$C2/m$
β_2 or V_2H or VH	~ 0.97 to 1.94	$tF6, tF8?$...
δ or V_3H_2	~ 1.30	$mC10$...
γ or VH_2	3.81	$cF12$	$Fm\bar{3}m$

H-Zr (Hydrogen - Zirconium)

E.Zuzek, J.P. Abriata, A. San-Martin, and F.D. Manchester, 1990

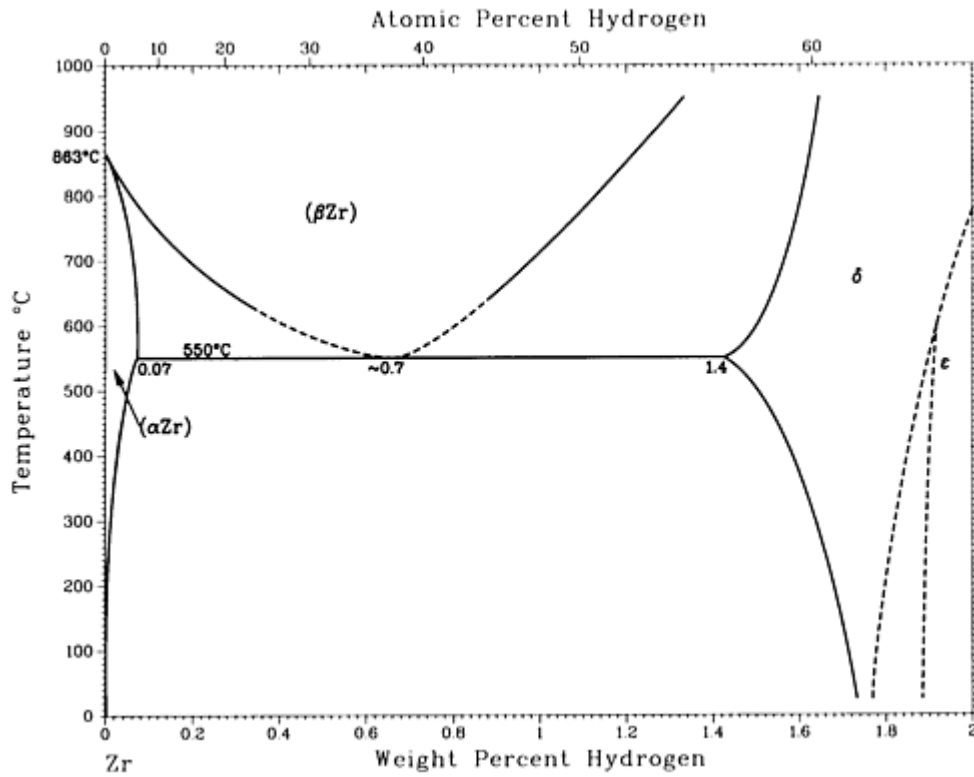

H-Zr phase diagram

H-Zr crystallographic data

Phase	Composition, wt% H	Pearson symbol	Space group
α or (α Zr)	0 to 0.07	<i>hP2</i>	<i>P6₃/mmc</i>
β or (β Zr)	0 to ~1.28?	<i>cI2</i>	<i>Im$\bar{3}m$</i>
δ	1.4 to ~2.1?	<i>cF12</i>	<i>Fm$\bar{3}m$</i>
ϵ	1.89	<i>tI6</i>	<i>I4/mmm</i>
Metastable phase			
γ	~0.011	<i>tP6</i>	<i>P4₂/n</i>

Introduction

THIS ARTICLE includes systems where hafnium is the first-named element in the binary pair. Additional binary systems that include hafnium are provided in the following locations in this Volume:

- “Be-Hf (Beryllium - Hafnium)” in the article “Be (Beryllium) Binary Alloy Phase Diagrams.”
- “C-Hf (Carbon - Hafnium)” in the article “C (Carbon) Binary Alloy Phase Diagrams.”
- “Co-Hf (Cobalt - Hafnium)” in the article “Co (Cobalt) Binary Alloy Phase Diagrams.”
- “Cr-Hf (Chromium - Hafnium)” in the article “Cr (Chromium) Binary Alloy Phase Diagrams.”
- “Cu-Hf (Copper - Hafnium)” in the article “Cu (Copper) Binary Alloy Phase Diagrams.”
- “Fe-Hf (Iron - Hafnium)” in the article “Fe (Iron) Binary Alloy Phase Diagrams.”

Hf-Ir (Hafnium - Iridium)

H. Okamoto, 1990

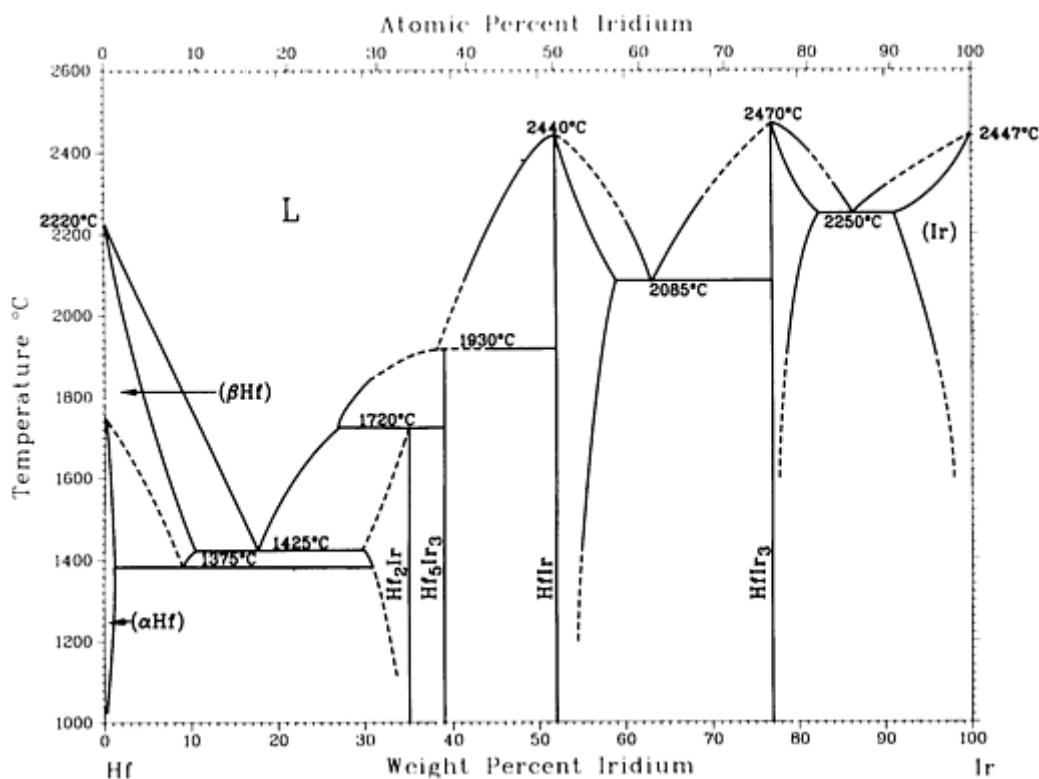

Hf-Ir phase diagram

Hf-Ir crystallographic data

Phase	Composition, wt% Ir	Pearson symbol	Space group
(β _{Hf})	0 to ~10.5	cI2	<i>Im</i> $\bar{3}m$

(α Hf)	0 to \sim 1.5	<i>hP2</i>	$P6_3/mmc$
Hf ₂ Ir	\sim 28 to 35.0	<i>cF96</i>	$Fd\bar{3}m$
Hf ₅ Ir ₃	39.3	<i>hP16</i>	$P6_3/mcm$
HfIr	51.9 to 59	<i>o**</i>	...
HfIr ₃	76 to 82	<i>cP4</i>	$Pm\bar{3}m$
(Ir)	\sim 91 to 100	<i>cF4</i>	$Fm\bar{3}m$

Hf-Mn (Hafnium - Manganese)

H. Okamoto, unpublished

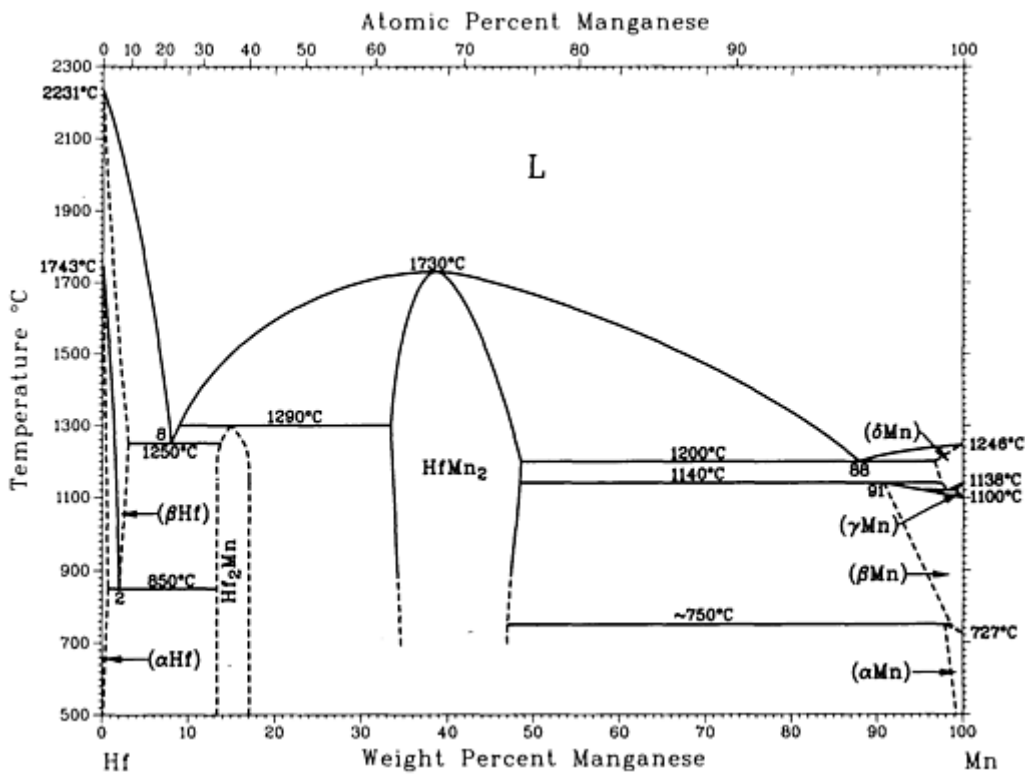

Hf-Mn phase diagram

Hf-Mn crystallographic data

Phase	Composition, wt% Mn	Pearson symbol	Space group
(α Hf)	0 to \sim 1.5	<i>hP2</i>	$P6_3/mmc$
Hf ₂ Ir	\sim 28 to 35.0	<i>cF96</i>	$Fd\bar{3}m$
Hf ₅ Ir ₃	39.3	<i>hP16</i>	$P6_3/mcm$
HfIr	51.9 to 59	<i>o**</i>	...
HfIr ₃	76 to 82	<i>cP4</i>	$Pm\bar{3}m$
(Ir)	\sim 91 to 100	<i>cF4</i>	$Fm\bar{3}m$

(β_{Hf})	0 to 3	$cI2$	$Im\bar{3}m$
(α_{Hf})	0 to 0.62	$hP2$	$P6_3/mmc$
Hf_2Mn	13.3 to ?	$cF96$	$Fd\bar{3}m$
β_{HfMn_2}	?	$hP24$	$P6_3/mmc$
α_{HfMn_2}	33 to 48.7	$hP12$	$P6_3/mmc$
(δ_{Mn})	97.4 to 100	$cI2$	$Im\bar{3}m$
(γ_{Mn})	99.0 to 100	$cF4$	$Fm\bar{3}m$
(β_{Mn})	91 to 100	$cP20$	$P4_32$
(α_{Mn})	99.4 to 100	$cI58$	$I\bar{4}3m$

Hf-Mo (Hafnium - Molybdenum)

From [Molybdenum] 12

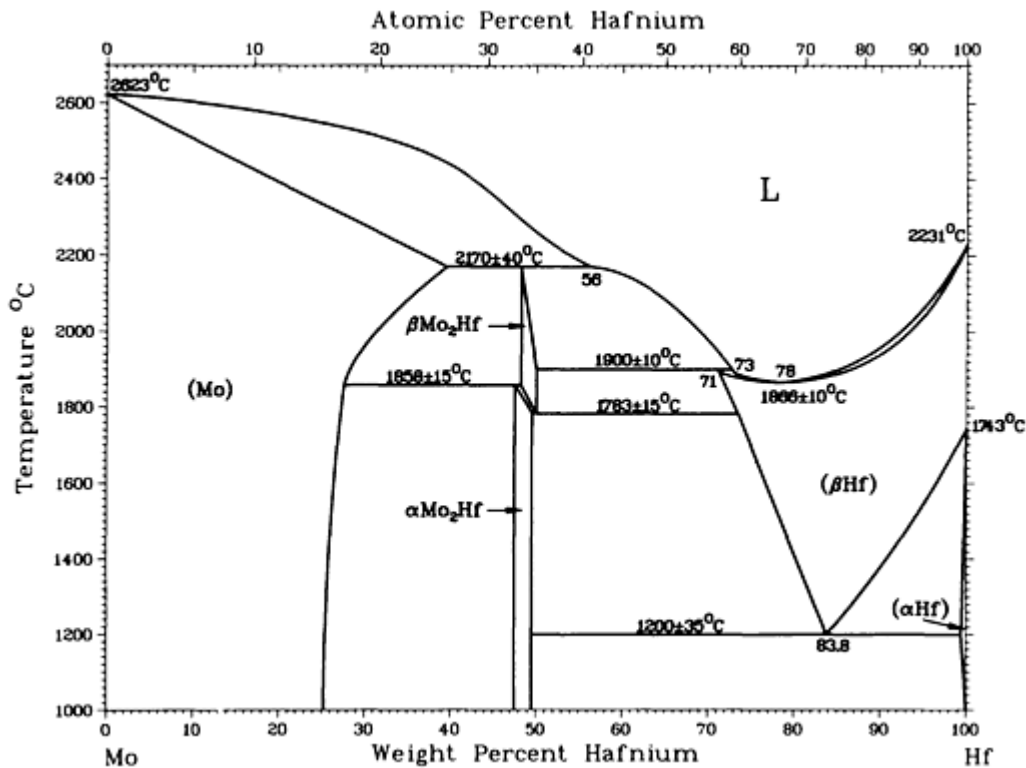

Hf-Mo phase diagram

Hf-Mo crystallographic data

Phase	Composition, wt% Hf	Pearson symbol	Space group
(Mo)	0 to 38	<i>cI2</i>	<i>Im$\bar{3}m$</i>
$\beta_{\text{Mo}_2\text{Hf}}$	~ 48.2	<i>hP24</i>	<i>P6$_3$/mmc</i>
$\alpha_{\text{Mo}_2\text{Hf}}$	~ 48.2	<i>cF25</i>	<i>Fd$\bar{3}m$</i>
(β_{Hf})	71 to 100	<i>cI2</i>	<i>Im$\bar{3}m$</i>
(α_{Hf})	~ 100	<i>hP2</i>	<i>P6$_3$/mmc</i>

Reference cited in this section

12. [Molybdenum]: L. Brewer, *Molybdenum: Physico-Chemical Properties of Its Compounds and Alloys*, O. Kubaschewski, Ed., Atomic Energy Review Special Issue No.7, International Atomic Energy Agency, Vienna (1980).

Hf-N (Hafnium - Nitrogen)

H. Okamoto, 1990

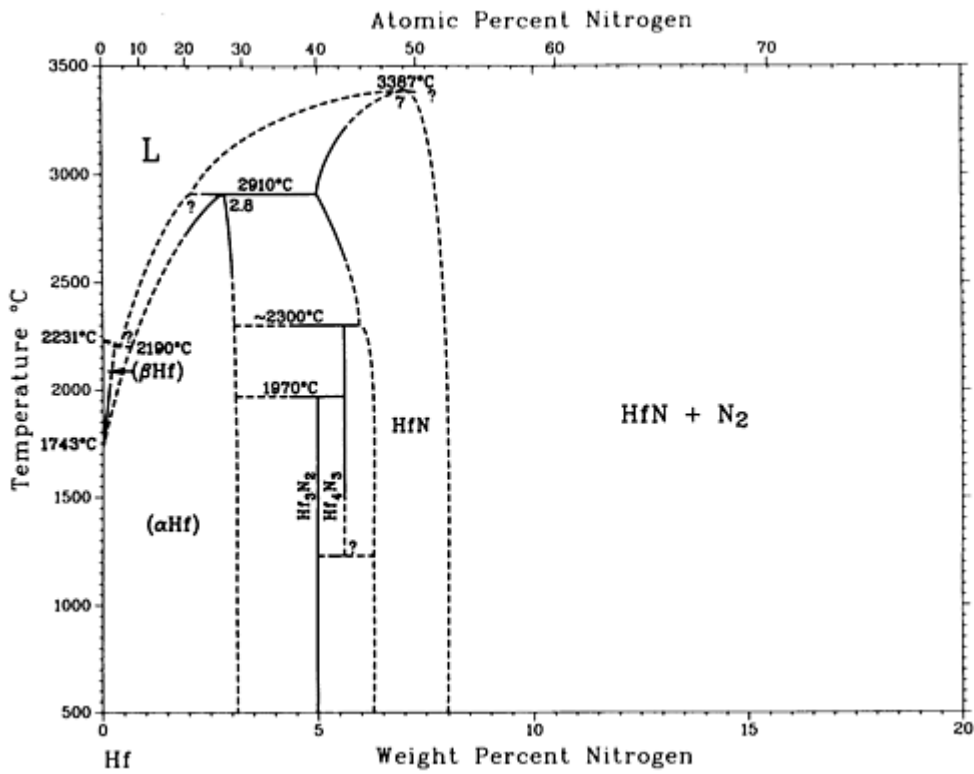

Hf-N phase diagram

Hf-N crystallographic data

Phase	Composition, wt% N	Pearson symbol	Space group
(β _{Hf})	0 to ?	<i>cI2</i>	<i>Im</i> $\bar{3}m$
(α _{Hf})	0 to 3.1	<i>hP2</i>	<i>P6</i> ₃ / <i>mmc</i>
Hf ₃ N ₂	4.97	<i>hR6</i>	<i>R</i> $\bar{3}m$
Hf ₄ N ₃	5.57	<i>hR8</i>	<i>R</i> $\bar{3}m$
HfN	4.59 to 7.98	<i>cF8</i>	<i>Fm</i> $\bar{3}m$
(α _N)	100	<i>cP8</i>	<i>Pa</i> 3

Hf-Nb (Hafnium - Niobium)

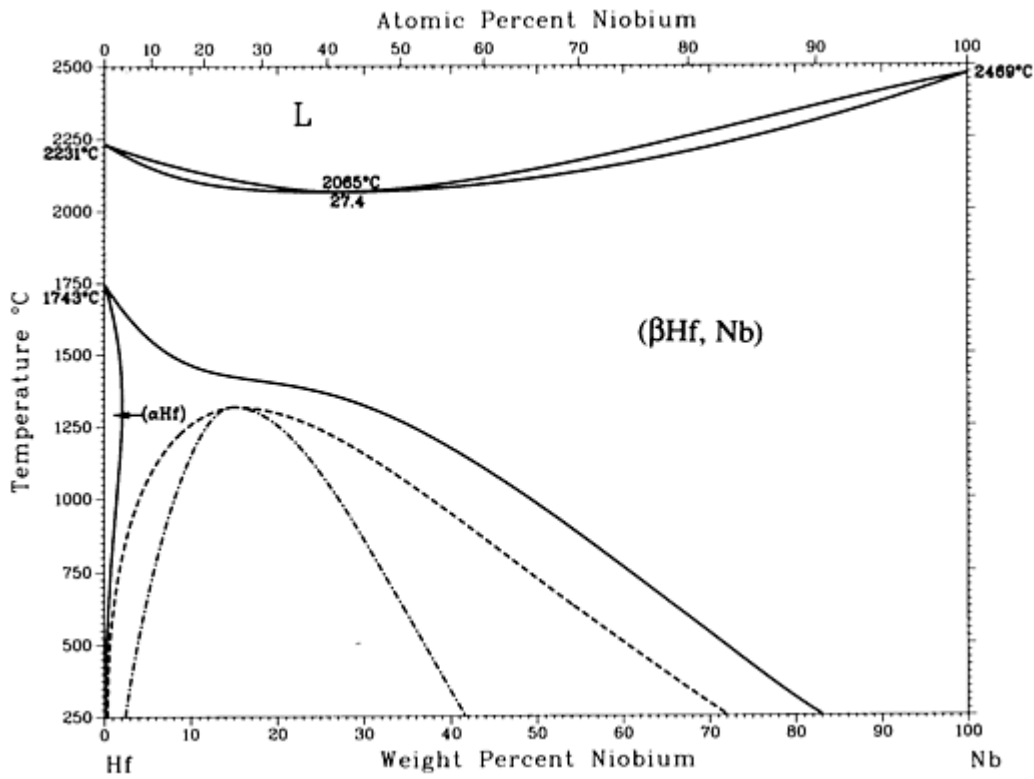

Hf-Nb phase diagram

Hf-Nb crystallographic data

Phase	Composition, wt% Nb	Pearson symbol	Space group
(β _{Hf,Nb})	0 to 100	<i>cI2</i>	<i>Im</i> $\bar{3}m$
(αHf)	0 to 2.4	<i>hP2</i>	<i>P6₃/mmc</i>

Hf-Ni (Hafnium - Nickel)

P. Nash and A. Nash, 1991

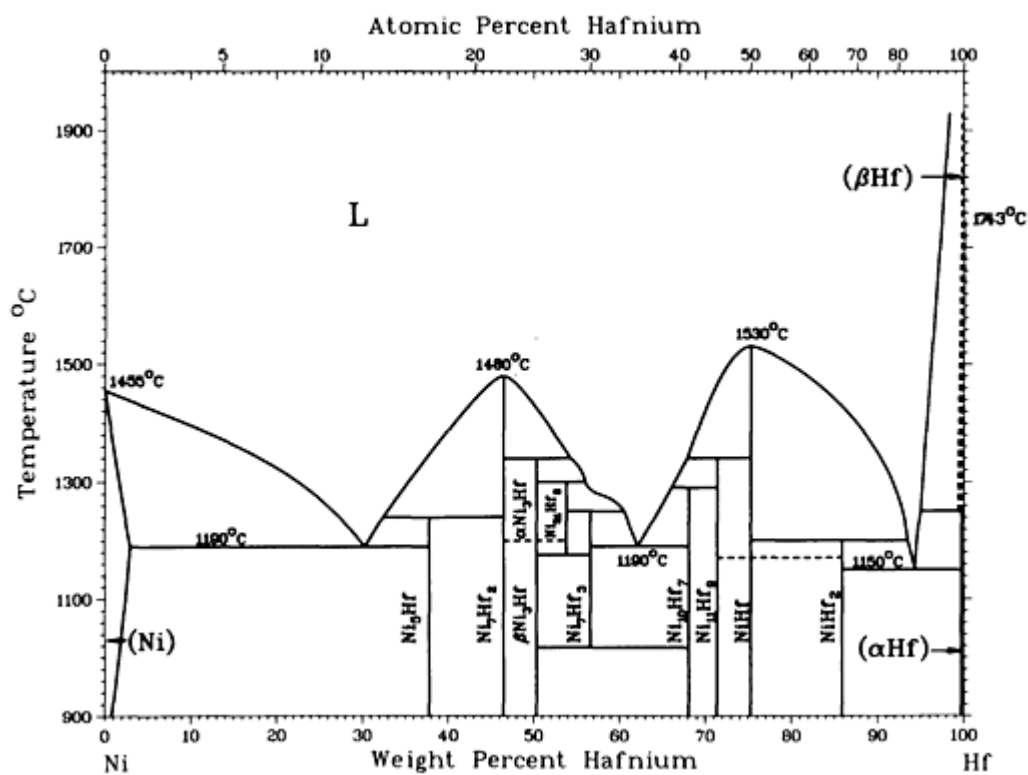

Hf-Ni phase diagram

Hf-Ni crystallographic data

Phase	Composition, wt% Hf	Pearson symbol	Space group
(Ni)	0 to 3	<i>cF4</i>	<i>Fm$\bar{3}m$</i>
Ni ₅ Hf	37.9	<i>cF24</i>	<i>F$\bar{4}3m$</i>
Ni ₇ Hf ₂	46.5	<i>m**</i>	...
β -Ni ₃ Hf	50	<i>hP40</i>	<i>P6₃/mmc</i>
α -Ni ₃ Hf	50	<i>hR12</i>	<i>R$\bar{3}m$</i>
Ni ₂₁ Hf ₆	53.7	<i>aP29</i>	<i>P$\bar{1}$</i>
Ni ₇ Hf ₃	57	<i>aP20</i>	<i>P$\bar{1}$</i>
Ni ₁₀ Hf ₇	68.1	<i>oC68</i>	<i>C2ca</i>

Ni ₁₁ Hf ₉	71	<i>tI*</i>	<i>I4/m</i>
NiHf	75.3	<i>oC8</i>	<i>Cmcm</i>
NiHf ₂	85.9	<i>tI12</i>	<i>I4/mcm</i>
(β -Hf)	99.3 to 100	<i>cI2</i>	<i>Im$\bar{3}m$</i>
(α -Hf)	99.7 to 100	<i>hP2</i>	<i>P6₃/mmc</i>

Hf-O (Hafnium - Oxygen)

From [Hafnium] 5

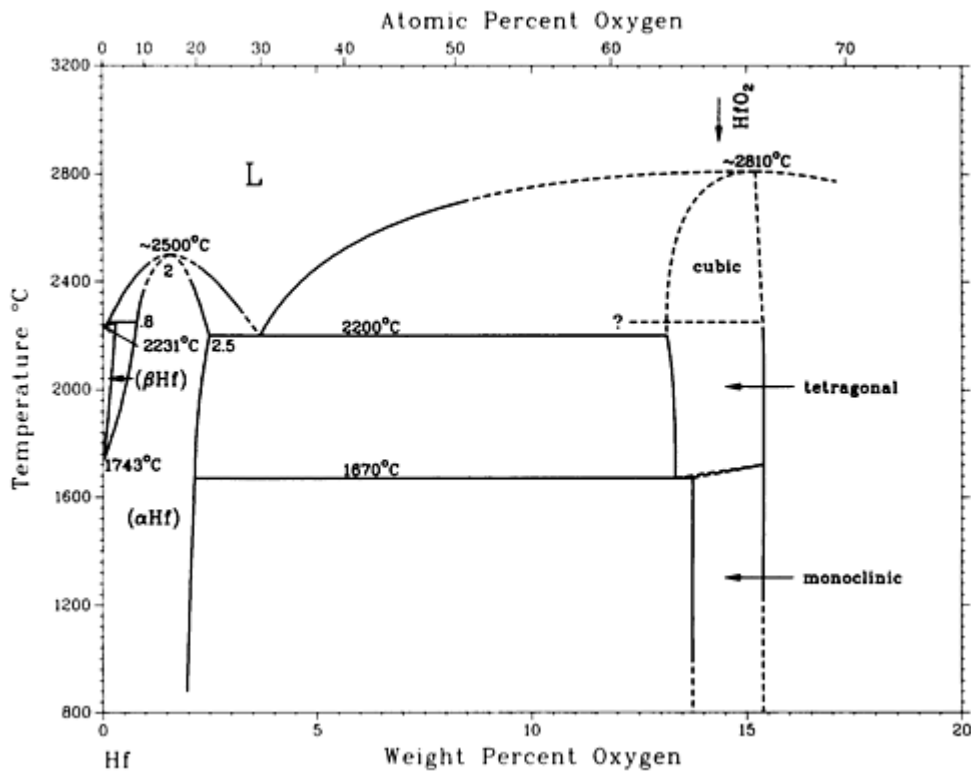

Hf-O phase diagram

Hf-O crystallographic data

Phase	Composition, wt% O	Pearson symbol	Space group
(β _{Hf})	0 to 0.8	<i>cI2</i>	<i>Im</i> $\bar{3}m$
(α _{Hf})	0 to 2.5	<i>hP2</i>	<i>P6</i> ₃ / <i>mmc</i>
HfO ₂	~13.2 to 15.4 ~13.2 to 15.4 ~13.7 to 15.4	<i>cF12</i> <i>t**</i> <i>mP12</i>	<i>Fm</i> $\bar{3}m$ <i>P2</i> ₁ / <i>c</i>

Reference cited in this section

5. [Hafnium]: P.J. Spencer, O. von Goldbeck, R. Ferro, R. Marazza, K. Girgis, and O. Kubaschewski, *Hafnium: Physico-Chemical Properties of Its Compounds and Alloys*, K.L. Komerek, Ed., Atomic Energy Review Special Issue No.8, International Atomic Energy Agency, Vienna (1981).

Hf-Os (Hafnium - Osmium)

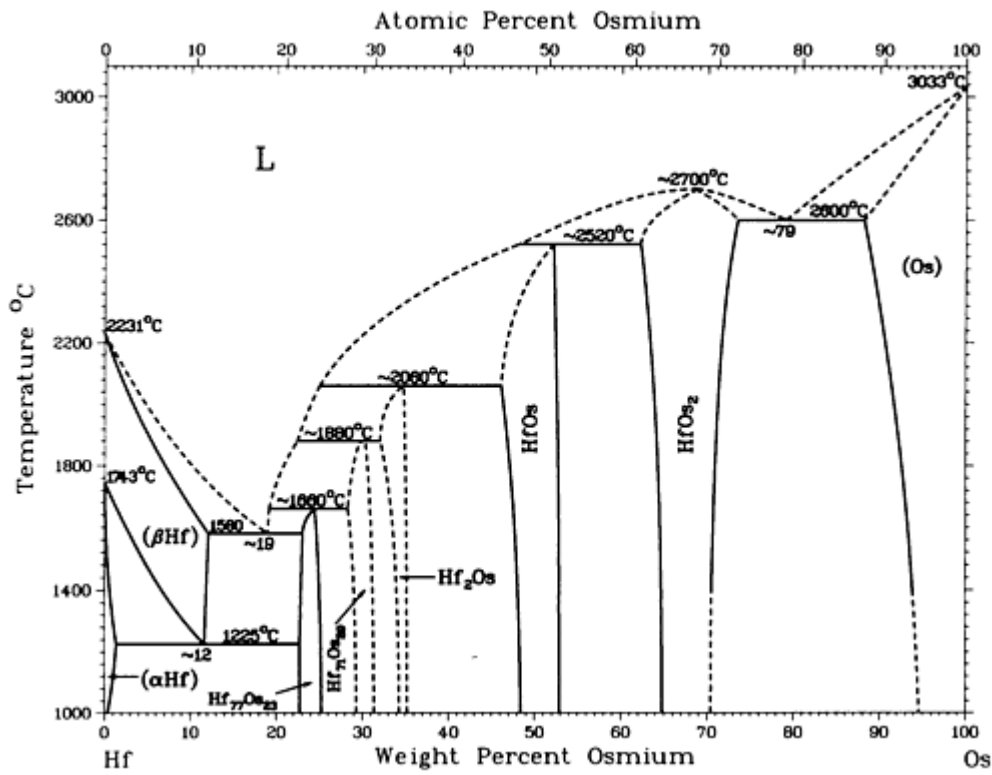

Hf-Os phase diagram

Hf-Os crystallographic data

Phase	Composition, wt% Os	Pearson symbol	Space group
(βHf)	0 to 13	<i>cI2</i>	<i>Im</i> $\bar{3}m$
(αHf)	0 to 2	<i>hP2</i>	<i>P6</i> $\bar{3}/mmc$
θ	~24
ζ	~30
Hf ₂ O _s	~35
HfOs	~47 to 54	<i>cP2</i>	<i>Pm</i> $\bar{3}m$
HfOs ₂	~64 to 73	<i>cF96</i> <i>hP12</i>	<i>Fd</i> $\bar{3}m$ <i>P6</i> $\bar{3}/mmc$
(Os)	100	<i>hP2</i>	<i>P6</i> $\bar{3}/mmc$

Hf-Rh (Hafnium - Rhodium)

H. Okamoto, 1990

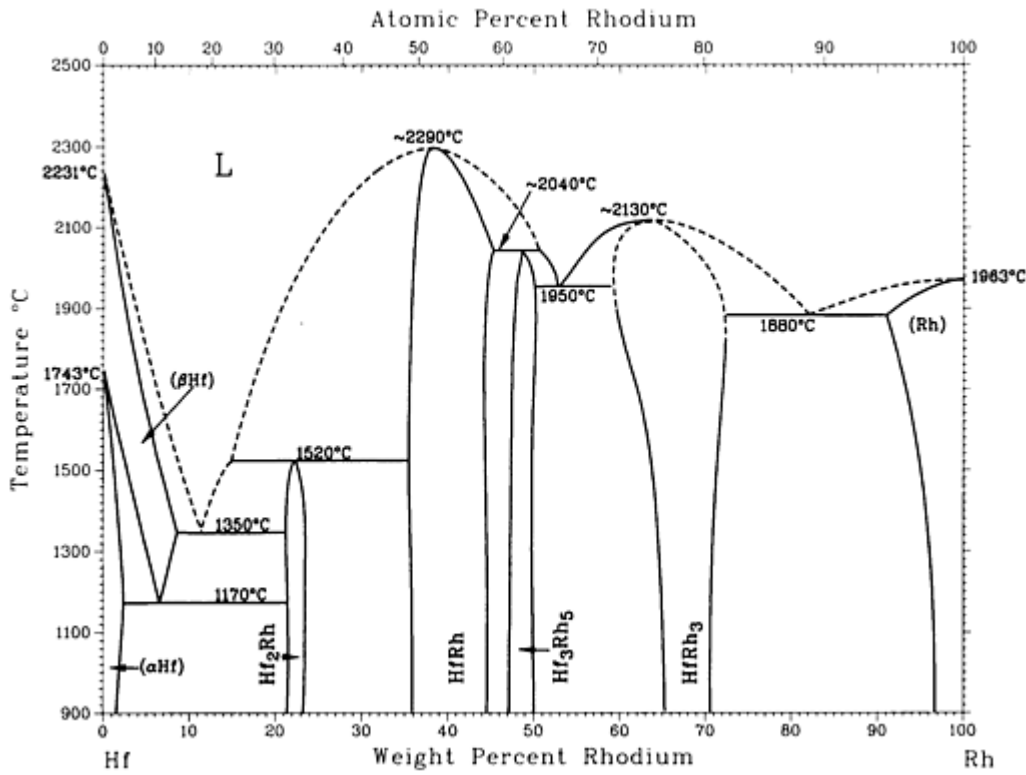

Hf-Rh phase diagram

Hf-Rh crystallographic data

Phase	Composition, wt% Rh	Pearson symbol	Space group
(βHf)	0	<i>cI2</i>	<i>Im</i> $\bar{3}m$
(αHf)	0	<i>hP2</i>	<i>P6</i> ₃ / <i>mmc</i>
Hf ₂ Rh	22 to 23	<i>cF96</i>	<i>Fd</i> $\bar{3}m$
HfRh	36 to 44	<i>cP2</i>	<i>Pm</i> $\bar{3}m$
Hf ₃ Rh ₅	47 to 51	<i>oP16</i>	<i>Pbam</i>
HfRh ₃	59 to 72	<i>cP4</i>	<i>Pm</i> $\bar{3}m$
(Rh)	100	<i>cF4</i>	<i>Fm</i> $\bar{3}m$

Hf-Si (Hafnium - Silicon)

A.B Gokhale and G.J. Abbaschian, 1989

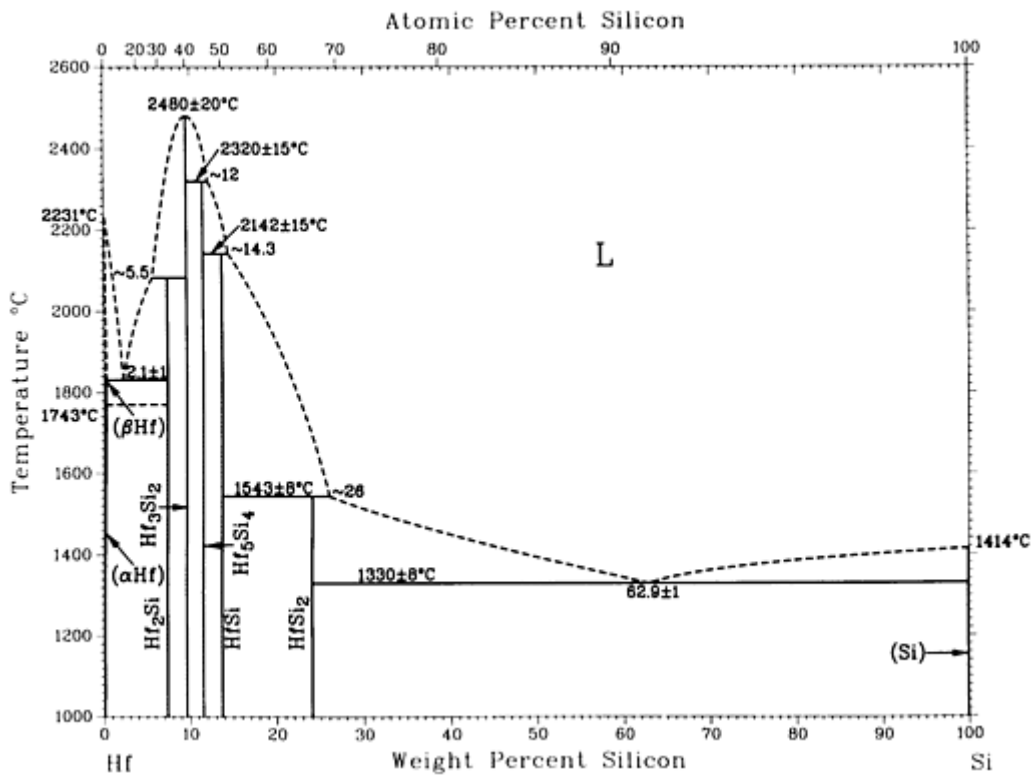

Hf-Si phase diagram

Hf-Si crystallographic data

Phase	Composition, wt% Si	Pearson symbol	Space group
(αHf)	~0	<i>hP2</i>	<i>P6₃/mmc</i>
(β _{Hf})	~0	<i>cI2</i>	<i>Im$\bar{3}m$</i>
Hf ₂ Si	7.3	<i>tI12</i>	<i>I4/mcm</i>
Hf ₃ Si ₂	9	<i>tP10</i>	<i>P4/mbm</i>
Hf ₅ Si ₄	11.2	...	<i>P4₁2₁2</i>
HfSi	13.6	<i>oP8</i>	<i>Pnma</i>

HfSi ₂	24.0	<i>oC12</i>	<i>Cmcm</i>
(Si)	100	<i>cF8</i>	<i>Fd$\bar{3}m$</i>

Note: The presence of Mn₅Si₃-type (*D*8₈) Hf₅Si₃ has been reported. However, the phase occurs only in the presence of interstitial impurities.

Hf-Ta (Hafnium - Tantalum)

R. Krishnan, S.P. Garg, and N. Krishnamurthy, 1989

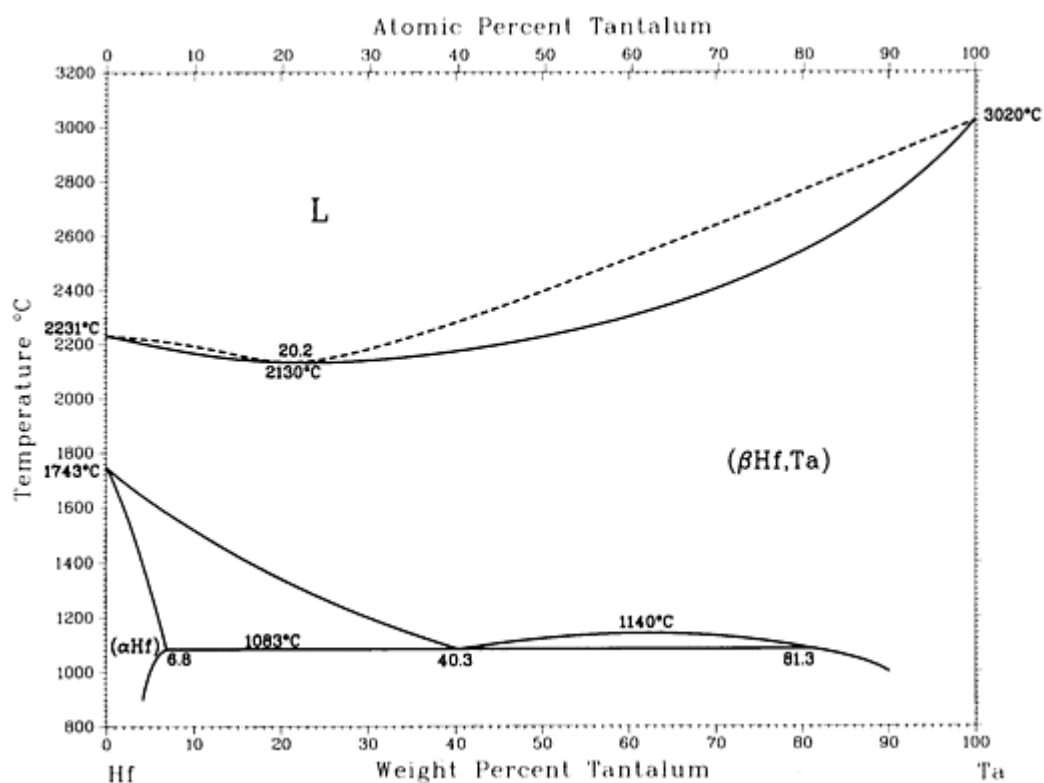

Hf-Ta phase diagram

Hf-Ta crystallographic data

Phase	Composition, wt% Ta	Pearson symbol	Space group
(β _{Hf,Ta})	0 to 100	<i>cI2</i>	<i>Im$\bar{3}m$</i>
(αHf)	0 to 6.8	<i>hP2</i>	<i>P6₃/mmc</i>

Hf-U (Hafnium - Uranium)

D.T. Peterson and D.J. Beerntsen, 1960

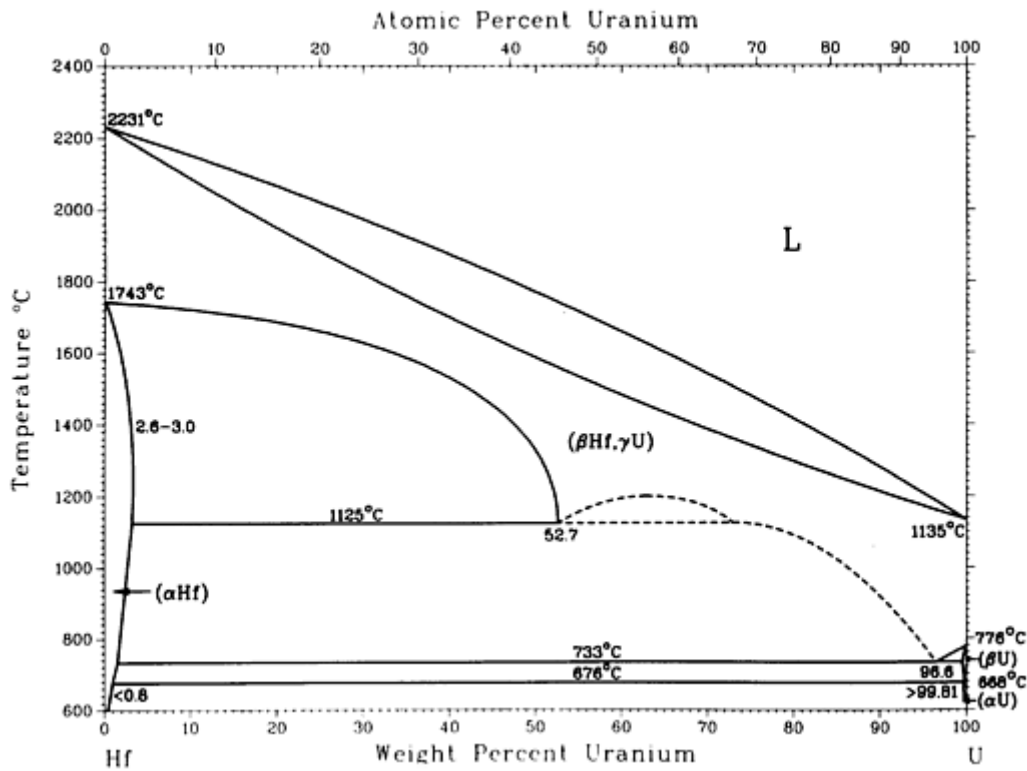

Hf-U phase diagram

Hf-U crystallographic data

Phase	Composition, wt% U	Pearson symbol	Space group
(β _{Hf} , γ _U)	0 to 100	<i>cI2</i>	<i>Im</i> $\bar{3}m$
(αHf)	0 to ~3	<i>hP2</i>	<i>P6</i> ₃ <i>/mmc</i>
(β _U)	100	<i>tP30</i>	<i>P4</i> ₂ <i>/mnm</i>
(αU)	100	<i>oC4</i>	<i>Cmcm</i>

Hf-V (Hafnium - Vanadium)

J.F. Smith, 1989

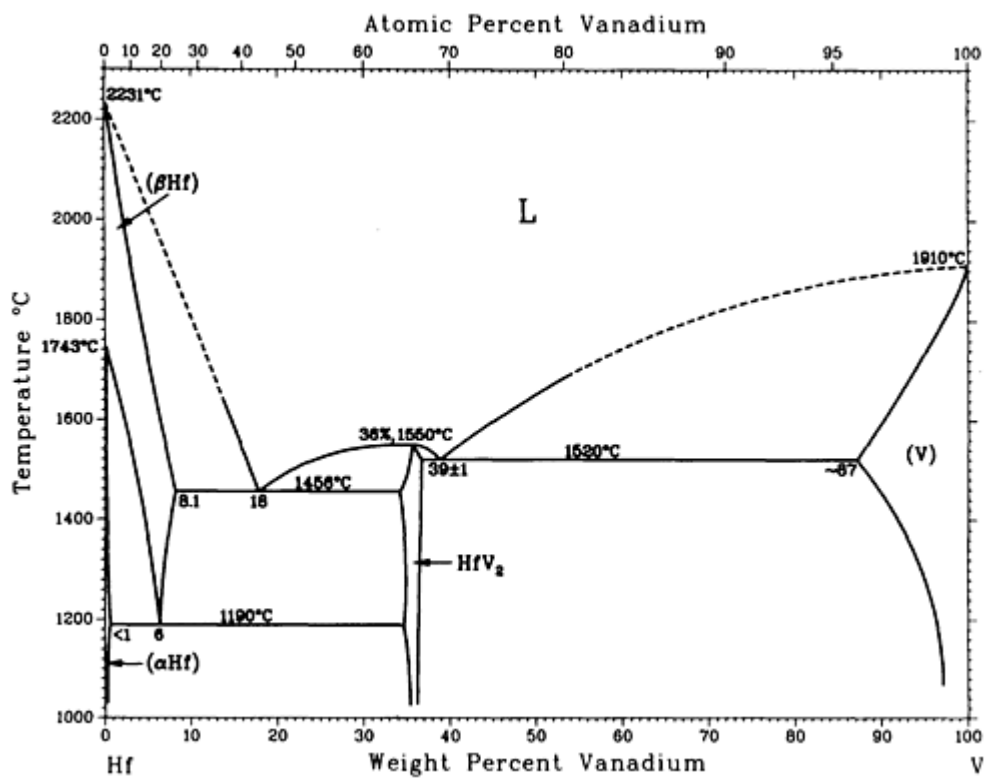

Hf-V phase diagram

Hf-V crystallographic data

Phase	Composition, wt% V	Pearson symbol	Space group
(β _{Hf})	0 to 8.1	<i>cI2</i>	<i>Im</i> $\bar{3}m$
(α _{Hf})	0 to <1	<i>hP2</i>	<i>P6</i> ₃ / <i>mmc</i>
HfV ₂	~36.4	<i>cF24</i>	<i>Fd</i> $\bar{3}m$
(V)	~87 to 100	<i>cI2</i>	<i>Im</i> $\bar{3}m$

Hf-W (Hafnium - Tungsten)

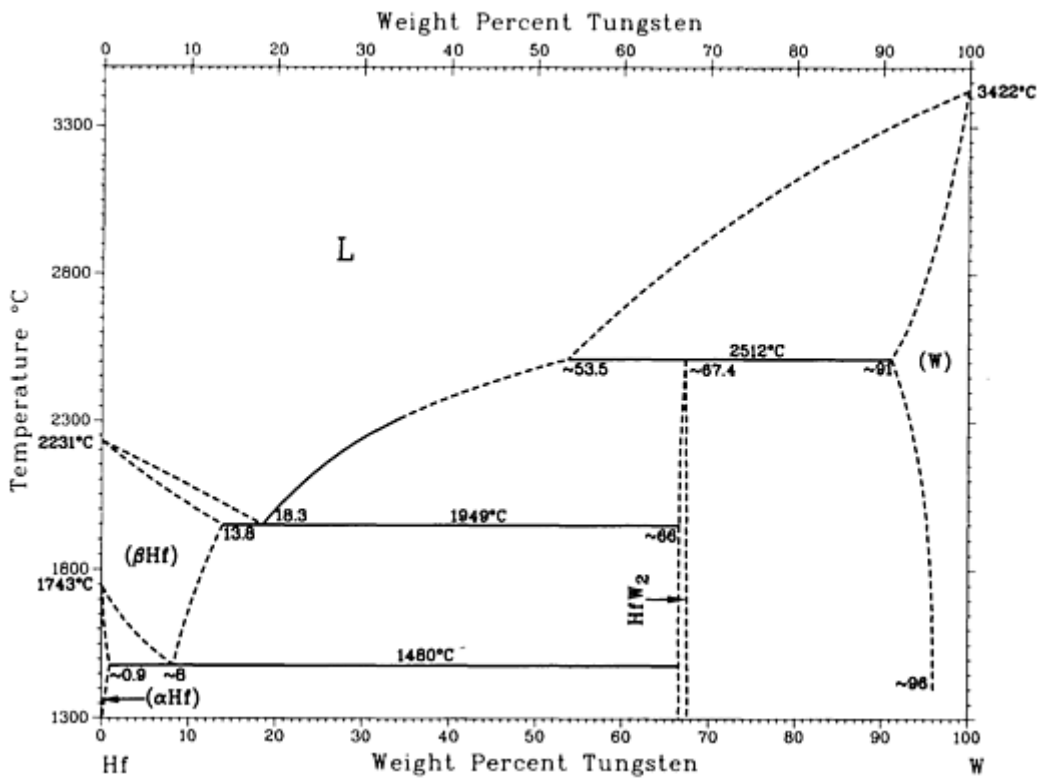

Hf-W phase diagram

Hf-W crystallographic data

Phase	Composition, wt% W	Pearson symbol	Space group
(β_{Hf})	0 to 13.8	$cI2$	$Im\bar{3}m$
(α_{Hf})	0 to ~0.9	$hP2$	$P6_3/mmc$
HfW_2	~67.4	$cF24$	$Fd\bar{3}m$
(W)	~91 to 100	$cI2$	$Im\bar{3}m$

Hf-Zr (Hafnium - Zirconium)

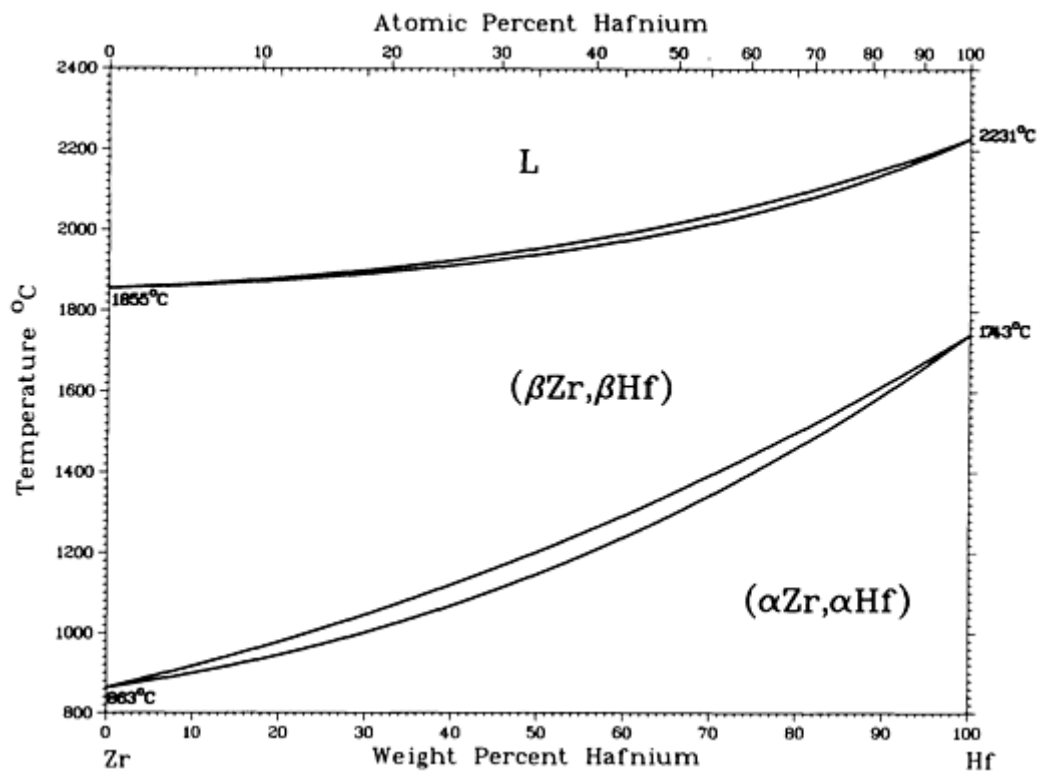

Hf-Zr phase diagram

Hf-Zr crystallographic data

Phase	Composition, wt% Hf	Pearson symbol	Space group
(αZr,αHf)	0 to 100	<i>hP2</i>	<i>P6₃/mmc</i>
(βZr,βHf)	0 to 100	<i>cI2</i>	<i>Im-3m</i>
ω ^(a)	0 to 100	<i>hP3</i>	<i>P-3m1</i> (<i>P6/mmm?</i>)

(a) Metastable at room temperature and zero pressure

Hg (Mercury) Binary Alloy Phase Diagrams

Introduction

THIS ARTICLE includes systems where mercury is the first-named element in the binary pair. Additional binary systems that include mercury are provided in the following locations in this Volume:

- “Ag-Hg (Silver - Mercury.” in the article “Ag (Silver) Binary Alloy Phase Diagrams.”
- “Al-Hg (Aluminum - Mercury.” in the article “Al (Aluminum) Binary Alloy Phase Diagrams.”
- “Au-Hg (Gold - Mercury.” in the article “Au (Gold) Binary Alloy Phase Diagrams.”
- “Ba-Hg (Barium - Mercury.” in the article “Ba (Barium) Binary Alloy Phase Diagrams.”
- “Bi-Hg (Bismuth - Mercury.” in the article “Bi (Bismuth) Binary Alloy Phase Diagrams.”
- “Ca-Hg (Calcium - Mercury.” in the article “Ca (Calcium) Binary Alloy Phase Diagrams.”
- “Cd-Hg (Cadmium - Mercury.” in the article “Cd (Cadmium) Binary Alloy Phase Diagrams.”
- “Cl-Hg (Chlorine - Mercury.” in the article “Cl (Chlorine) Binary Alloy Phase Diagrams.”
- “Cs-Hg (Cesium - Mercury.” in the article “Cs (Cesium) Binary Alloy Phase Diagrams.”
- “Cu-Hg (Copper - Mercury.” in the article “Cu (Copper) Binary Alloy Phase Diagrams.”

Hg-In (Mercury - Indium)

H. Okamoto, 1992

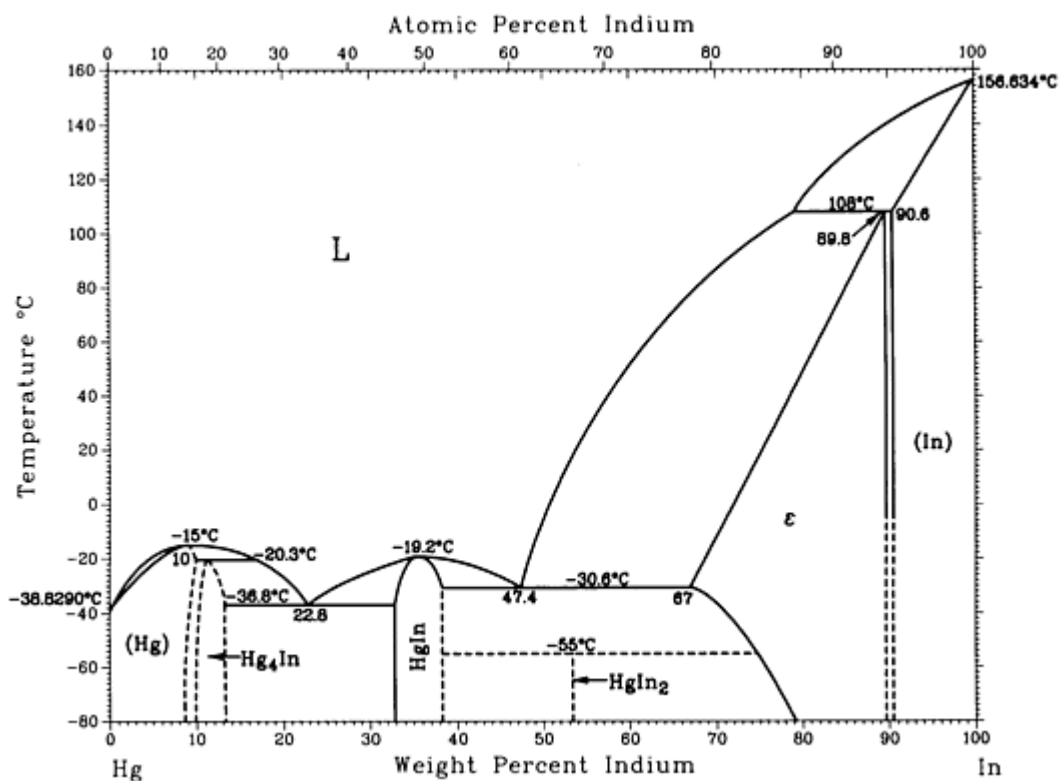

Hg-In phase diagram

Hg-In crystallographic data

Phase	Composition, wt% In	Pearson symbol	Space group
(Hg)	0 to ~10	<i>hR1</i>	$R\bar{3}m$

Hg ₄ In	10 to 14	<i>oF8</i>	<i>Fddd</i>
HgIn	33 to 38	<i>hR2</i>	<i>R$\bar{3}m$</i>
HgIn ₂	53.4
ϵ	67 to 89.8	<i>cF4</i>	<i>Fm$\bar{3}m$</i>
(In)	90.6 to 100	<i>tI2</i>	<i>I4/mmm</i>

Hg-K (Mercury - Potassium)

A.E. Vol and I.K. Kagan, 1979

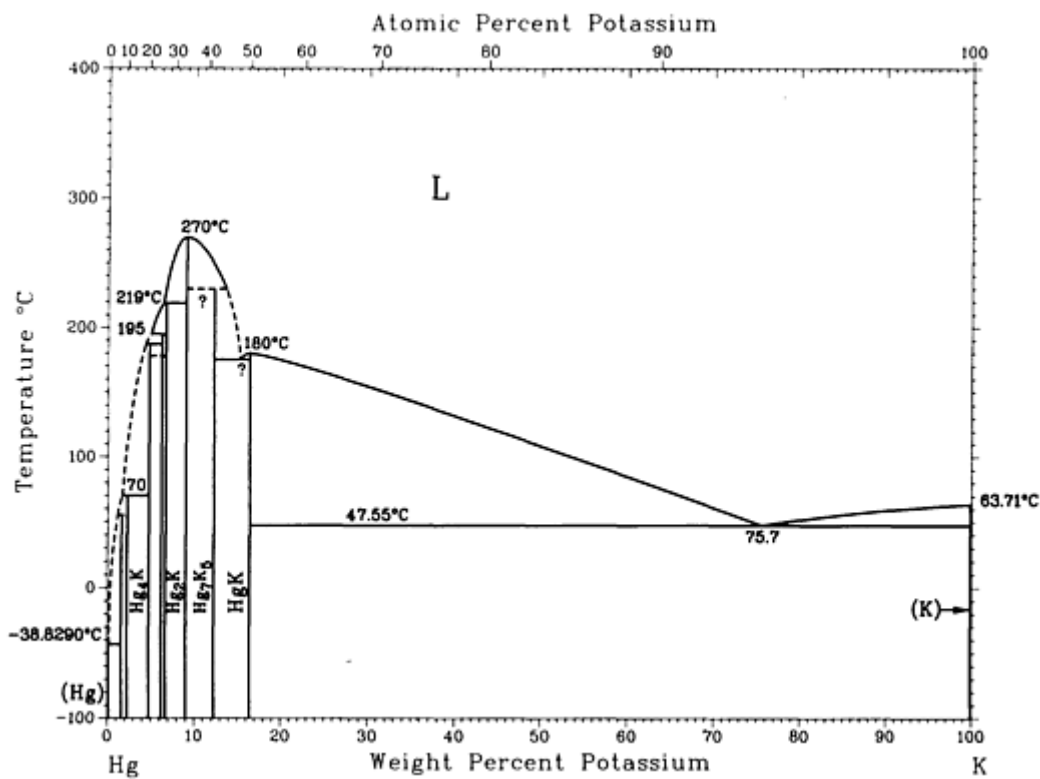

Hg-K phase diagram

Hg-K crystallographic data

Phase	Composition, wt% K	Pearson symbol	Space group
(Hg)	0	<i>hR1</i>	<i>R$\bar{3}m$</i>

Hg ₁₁ K	1.7	<i>cP36</i>	<i>Pm$\bar{3}m$</i>
Hg ₉ K	2.1
Hg ₄ K	4.6
Hg ₃ K	6.1
Hg _{2.7} K	6.7
Hg ₂ K	8.9	<i>oI12</i>	<i>Imma</i>
Hg ₇ K ₅	12.2	<i>oP48</i>	<i>Pbcm</i>
HgK	16.3	<i>aP8</i>	<i>P1</i>
(K)	100	<i>cI2</i>	<i>Im$\bar{3}m$</i>

Hg-La (Mercury - Lanthanum)

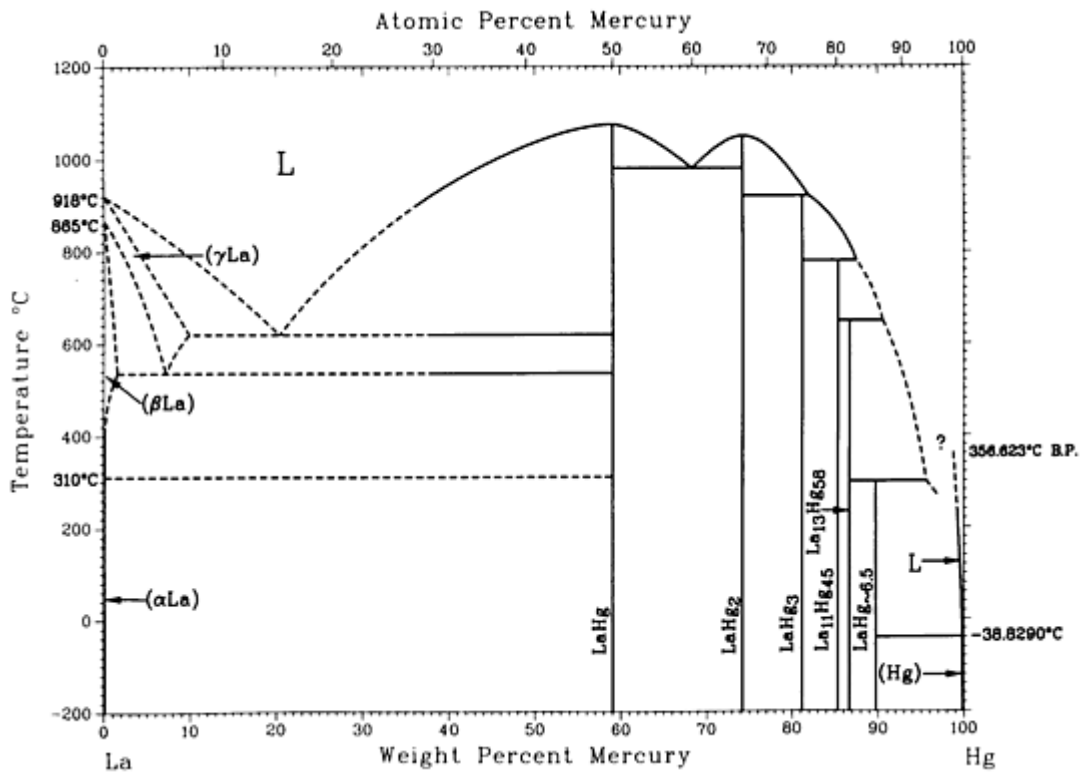

Hg-La phase diagram

Hg-La crystallographic data

Phase	Composition, wt% Hg	Pearson symbol	Space group
(γ La)	0	<i>cI2</i>	<i>Im</i> $\bar{3}m$
(β La)	0	<i>cF4</i>	<i>Fm</i> $\bar{3}m$
(α La)	0	<i>hP4</i>	<i>P6</i> ₃ / <i>mmc</i>
LaHg	59.1	<i>cP2</i>	<i>Pm</i> $\bar{3}m$
LaHg ₂	74.3	<i>hP3</i>	<i>P6</i> / <i>mmm</i>
LaHg ₃	81	<i>hP8</i>	<i>P6</i> ₃ / <i>mmc</i>
La ₁₁ Hg ₄₅	85.5	<i>cF448</i>	<i>F</i> $\bar{4}3m$
La ₁₃ Hg ₅₈	87	<i>hP142</i>	<i>P6</i> ₃ / <i>mmc</i>

LaHg~6.5	91	<i>o</i> **	<i>Cmcm</i> or <i>C2cm</i> or <i>Cmc2₁</i>
(Hg)	100	<i>hR1</i>	<i>R$\bar{3}m$</i>

Hg-Li (Mercury - Lithium)

From [Hansen] 6

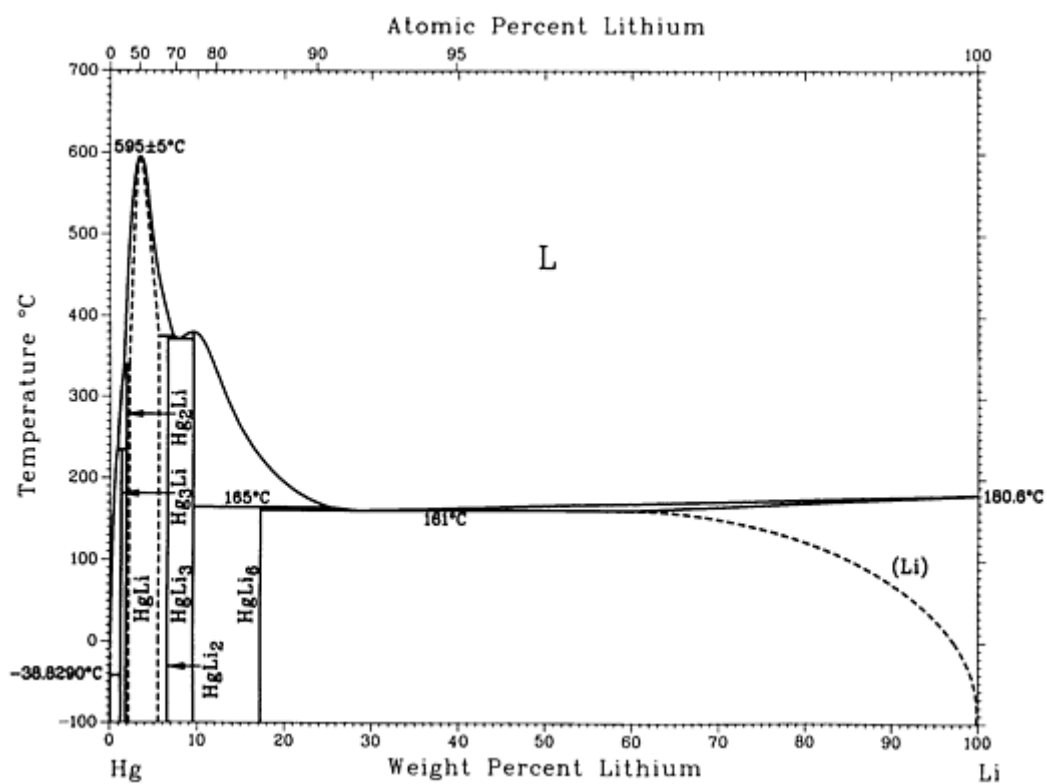

Hg-Li phase diagram

Hg-Li crystallographic data

Phase	Composition, wt% Li	Pearson symbol	Space group
(Hg)	0	<i>hR1</i>	<i>R$\bar{3}m$</i>
Hg ₃ Li	1.1	<i>hP8</i>	<i>P6₃/mmc</i>
Hg ₂ Li	1.7
HgLi	~2.08 to 5.6	<i>cP2</i>	<i>Pm$\bar{3}m$</i>

HgLi ₂	6.5
HgLi ₃	9.4	cF16	Fm $\bar{3}m$
HgLi ₆	17.2
(Li)	? to 100	cI2	Im $\bar{3}m$

Reference cited in this section

6. [Hansen]: M. Hansen and K. Anderko, *Constitution of Binary Alloys*, McGraw-Hill, New York or General Electric Co., Business Growth Services, Schenectady, New York (1958).

Hg-Mg (Mercury - Magnesium)

A.A. Nayeb-Hashemi and J.B. Clark, 1988

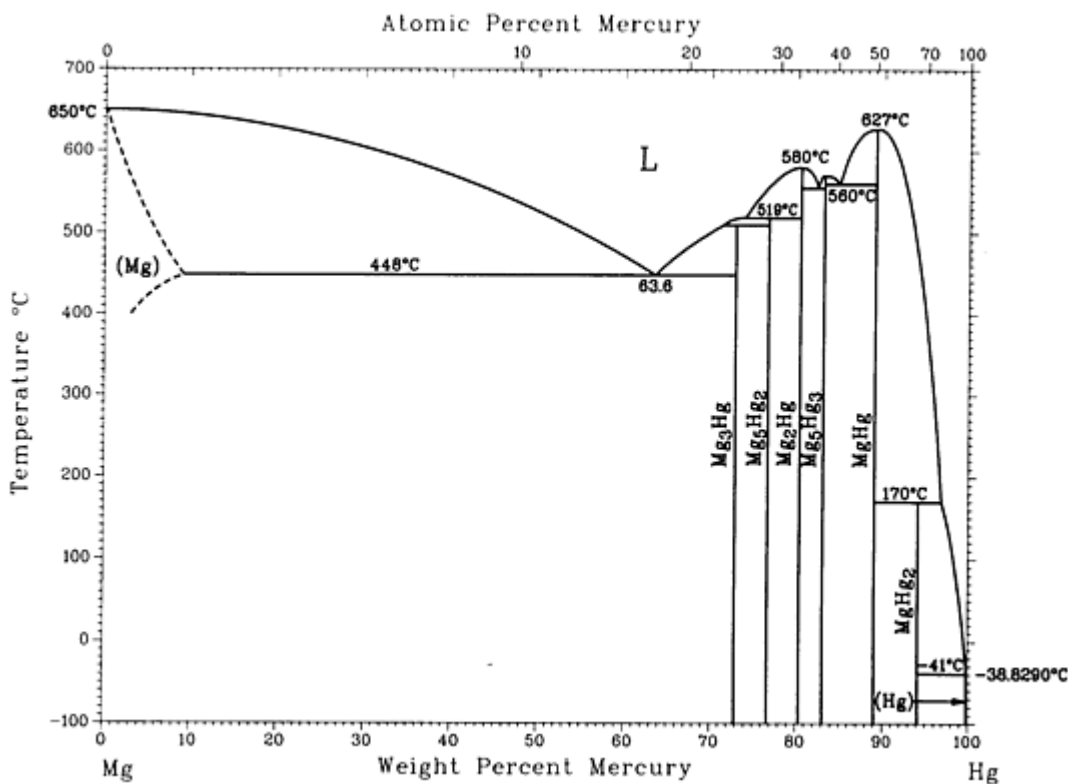

Hg-Mg phase diagram

Hg-Mg crystallographic data

Phase	Composition, wt% Hg	Pearson symbol	Space group
-------	---------------------	----------------	-------------

(Mg)	0 to ~9.1	<i>hP2</i>	<i>P6₃/mmc</i>
Mg ₃ Hg	73	<i>hP8</i>	<i>P6₃/mmc</i>
Mg ₅ Hg ₂	76.8
Mg ₂ Hg	80.5
Mg ₅ Hg ₃	83.2	<i>hP16</i>	<i>P6₃/mmc</i>
MgHg	89.2	<i>cP2</i>	<i>Pm$\bar{3}m$</i>
MgHg ₂	94.3	<i>I4</i>	<i>I4/mmm</i>
(Hg)	100	<i>hR1</i>	<i>R$\bar{3}m$</i>

Hg-Na (Mercury - Sodium)

H. Okamoto, 1990

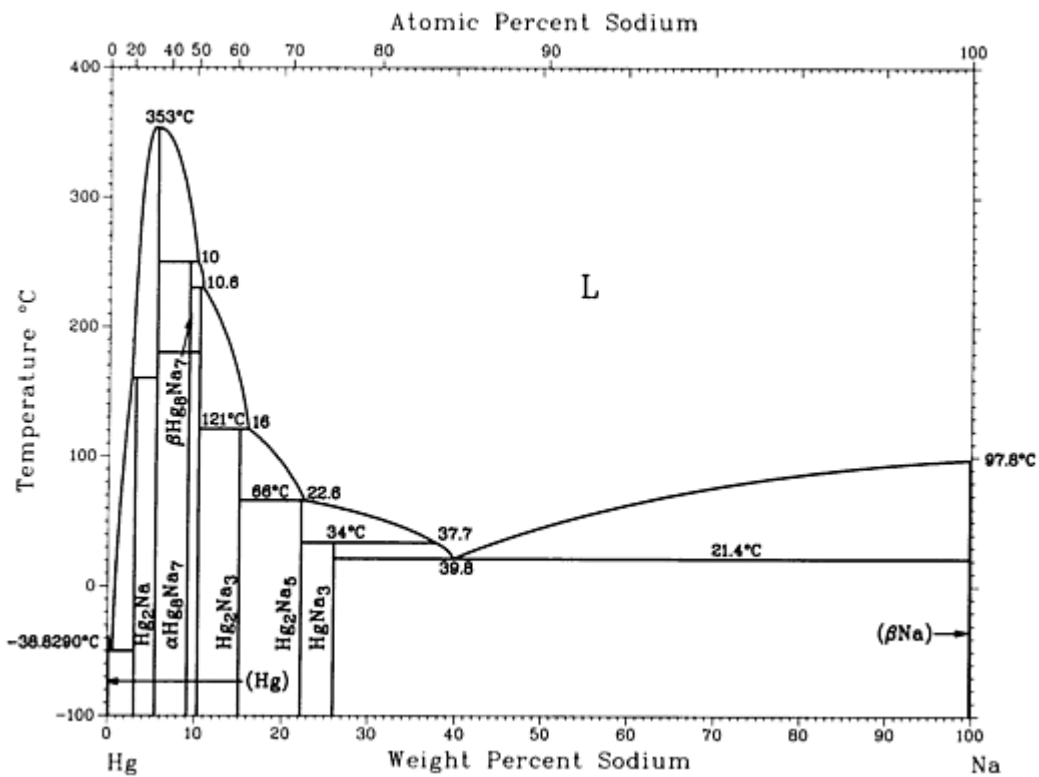

Hg-Na phase diagram

Hg-Na crystallographic data

Phase	Composition, wt% Na	Pearson symbol	Space group
(Hg)	~0	<i>hR1</i>	$R\bar{3}m$
Hg ₄ Na	3	<i>h**</i>	...
Hg ₂ Na	5.4	<i>hP3</i>	<i>P6/mmm</i>
β -Hg ₈ Na ₇	~9.1
α -Hg ₈ Na ₇	~9.1
HgNa	10.3	<i>oC16</i>	<i>Cmcm</i>
Hg ₂ Na ₃	15	<i>tP20</i>	<i>P4₂/mnm</i>
Hg ₂ Na ₅	~22.2	<i>hR*</i>	...
HgNa ₃	26
(β -Na)	~100	<i>cI2</i>	<i>Im\bar{3}m</i>

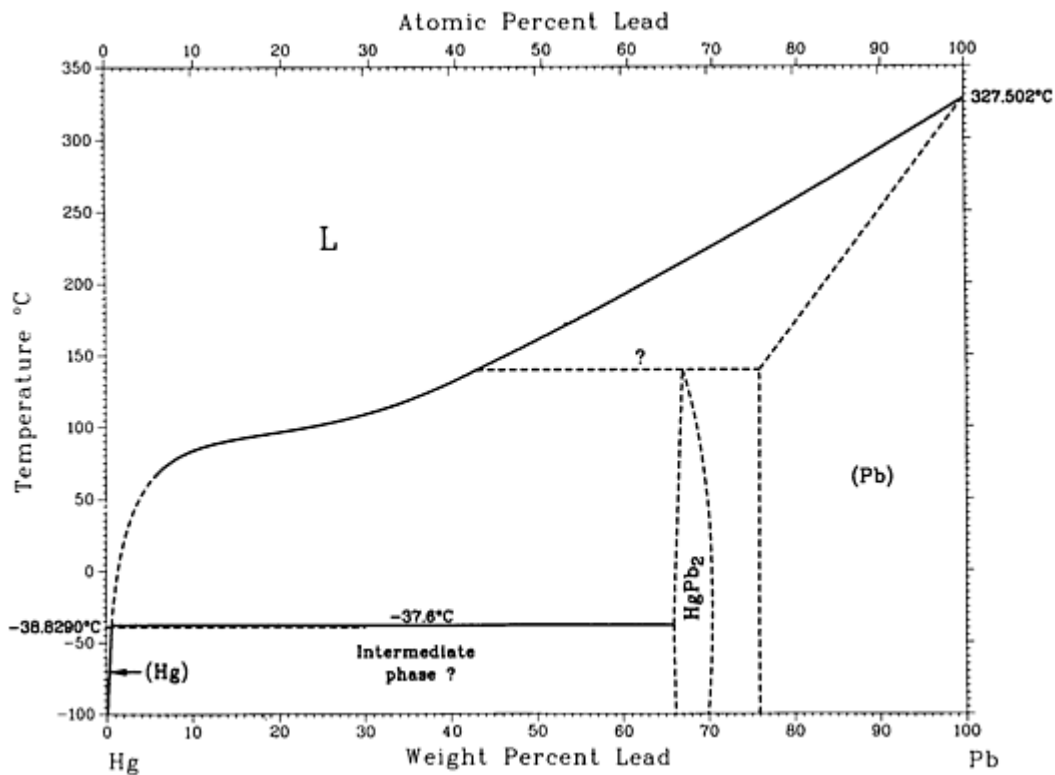

Hg-Pb phase diagram

Hg-Pb crystallographic data

Phase	Composition, wt% Pb	Pearson symbol	Space group
(Hg)	0	<i>hR1</i>	$R\bar{3}m$
HgPb ₂	~66 to ~71	<i>tP2</i>	$P4/mmm$
(Pb)	~76 to 100	<i>cF4</i>	$Fm\bar{3}m$

Reference cited in this section

6. [Hansen]: M. Hansen and K. Anderko, *Constitution of Binary Alloys*, McGraw-Hill, New York or General Electric Co., Business Growth Services, Schenectady, New York (1958).

Hg-S (Mercury - Sulfur)

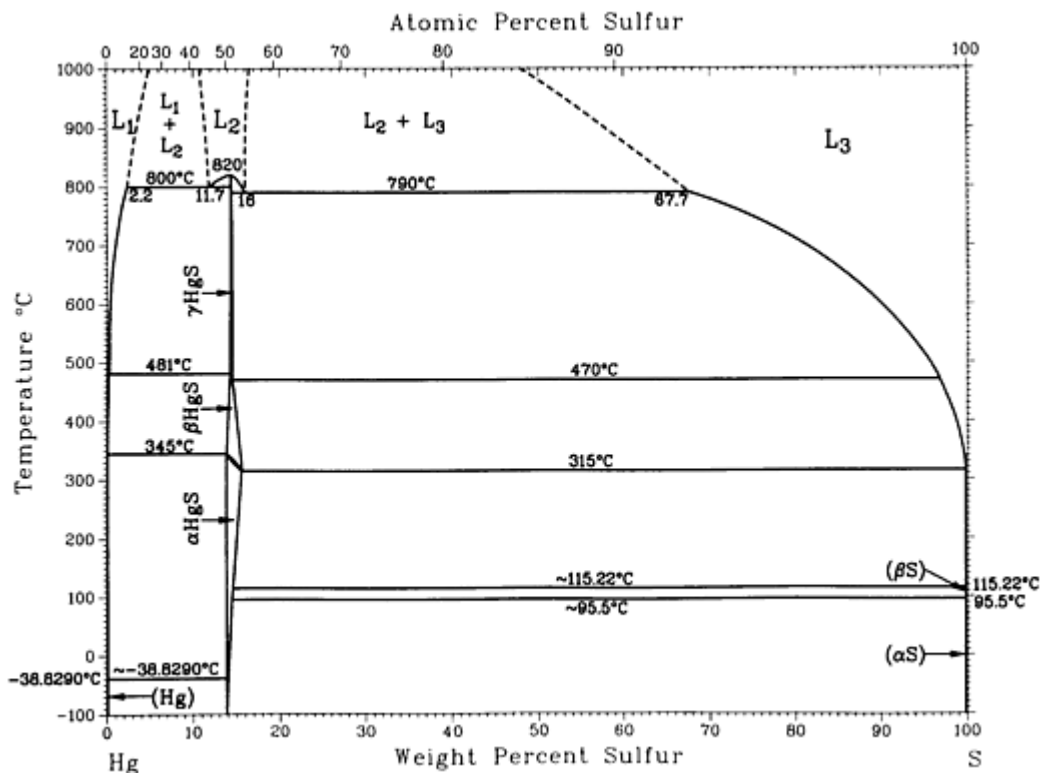

Hg-S phase diagram

Hg-S crystallographic data

Phase	Composition, wt% S	Pearson symbol	Space group
Hg	0	<i>hR1</i>	$R\bar{3}m$
γ_{HgS}	14.19 to 14.47	^(a)	...
β_{HgS}	13.8 to 15.61	<i>cF8</i>	$F\bar{4}3m$
α_{HgS}	13.8 to 15.5	<i>hP6</i>	$P3_121$
$\delta_{\text{HgS}}^{(b)}$	13.8	<i>cF8</i>	$Fm\bar{3}m$
$(\beta_{\text{S}})^{(c)}$	100	<i>mP*</i>	$P2_1/a$
$(\alpha_{\text{S}})^{(d)}$	100	<i>oF128</i>	$Fddd$

- (a) Hexagonal.
- (b) Above 13 GPa.
- (c) From 95.5 to 115.22 °C.
- (d) At <95.5 °C

Hg-Se (Mercury - Selenium)

R.C. Sharma, Y.A. Chang, and C. Guminski, 1992

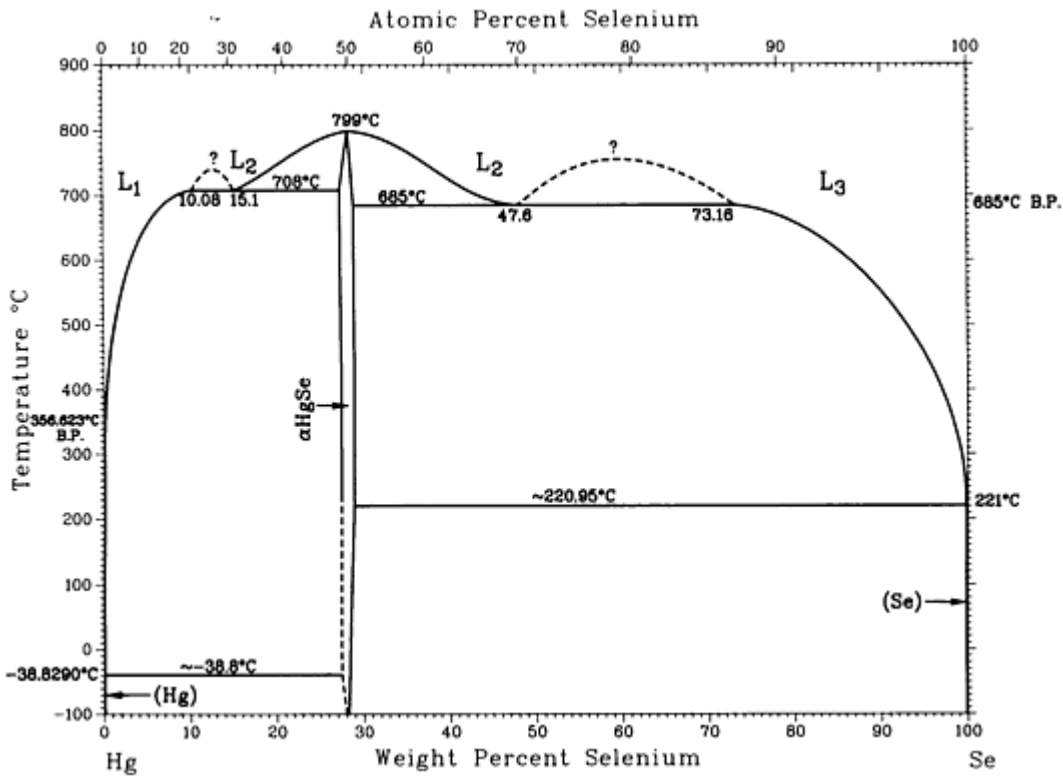

Hg-Se phase diagram

Hg-Se crystallographic data

Phase	Composition, wt% Se	Pearson symbol	Space group
(Hg)	0	<i>hR1</i>	$R\bar{3}m$
αHgSe	27.3 to 28.86	<i>cF8</i>	$F\bar{4}3m$

(γ_{Se})	100	<i>hP3</i>	<i>P3₁21</i>
(β_{Se})	100	<i>mP64</i>	<i>P2₁/c</i>
(α_{Se})	100	<i>mP32</i>	<i>P2₁/n</i>
High-pressure phases			
$\beta_{\text{HgSe}}^{(a)}$	28.2	<i>hP6</i>	<i>P3₁21</i>
$\gamma_{\text{HgSe}}^{(b)}$	28.2	<i>cF8</i>	<i>Fm$\bar{3}m$</i>
$\delta_{\text{HgSe}}^{(c)}$	28.2	<i>tI4</i>	<i>I$\bar{4}m2$</i>

(a) Between 0.30 and ~ 7 GPa.

(b) Between ~ 7 GPa and 13.3 GPa.

(c) Above 13.3 GPa

Hg-Sn (Mercury - Tin)

H. Okamoto, 1990

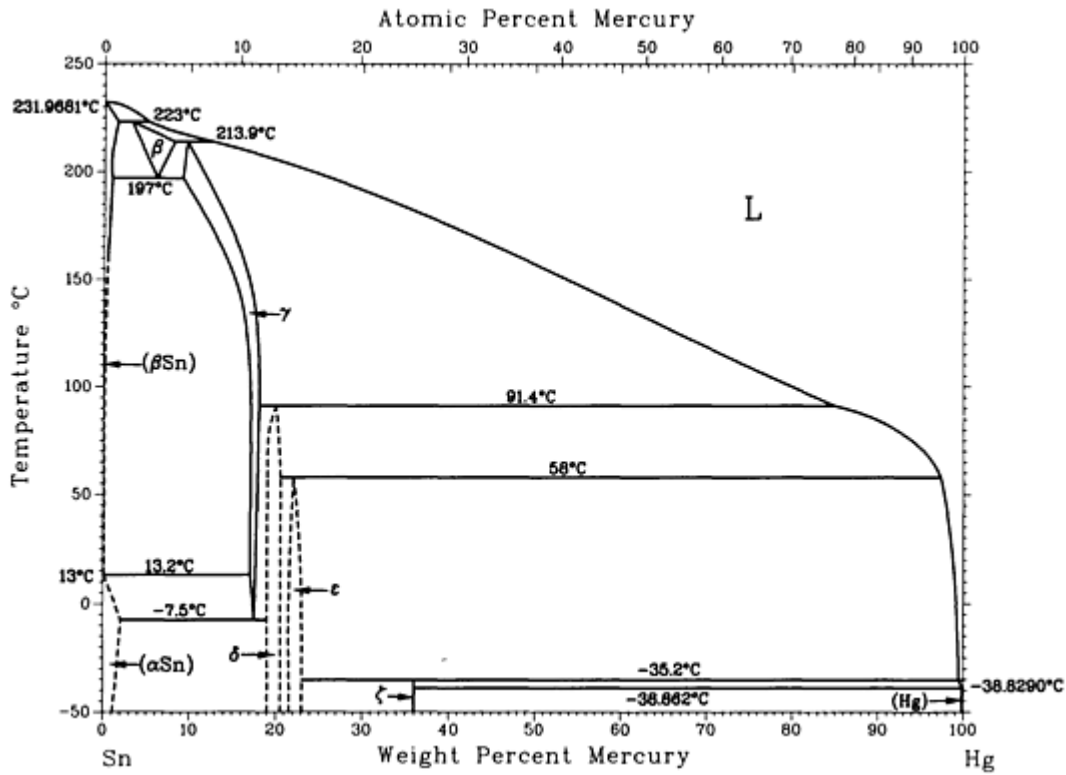

Hg-Sn phase diagram

Hg-Sn crystallographic data

Phase	Composition, wt% Hg	Pearson symbol	Space group
(β _{Sn})	0 to <0.8	<i>tI4</i>	<i>I4₁amd</i>
(α _{Sn})	0 to <2	<i>cF8</i>	<i>Fd$\bar{3}m$</i>
β	~3 to 8	<i>h**</i>	...
γ	~10 to 19	<i>hP2</i>	<i>P6₃/mmc</i>
δ	~20
ε	~22 to 23
ζ	36

(Hg)	~100	<i>hR1</i>	$R\bar{3}m$
------	------	------------	-------------

Hg-Sr (Mercury - Strontium)

P.R. Subramanian, 1990

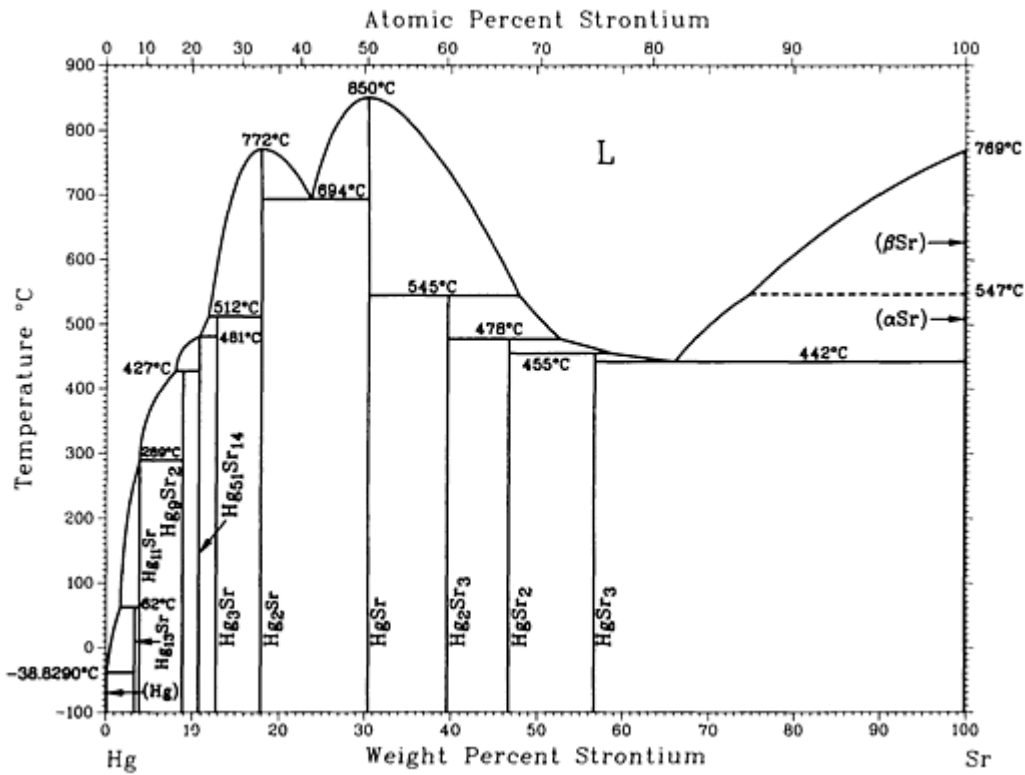

Hg-Sr phase diagram

Hg-Sr crystallographic data

Phase	Composition, wt% Sr	Pearson symbol	Space group
(Hg)	0	<i>hR1</i>	$R\bar{3}m$
Hg ₁₃ Sr	~3.2
Hg ₁₁ Sr	~3.8	<i>cP36</i>	$Pm\bar{3}m$
Hg ₉ Sr ₂	~8.8	<i>hP142</i>	$P6_3mc$
Hg ₅₁ Sr ₁₄	~10.7	<i>hP58</i>	$P6/m$

Hg ₃ Sr	13	<i>hP8</i>	<i>P6₃/mmc</i>
Hg ₂ Sr	17.9	<i>oI12</i> <i>hP3</i>	<i>Immc</i> <i>P6/mmm</i>
HgSr	30.4	<i>cP2</i>	<i>Pm$\bar{3}m$</i>
Hg ₂ Sr ₃	40	<i>tP10</i>	<i>P4/mbm</i>
HgSr ₂	46.7
HgSr ₃	57	<i>oP16</i>	<i>Pnma</i>
(β Sr)	100	<i>cI2</i>	<i>Im$\bar{3}m$</i>
(α Sr)	100	<i>cF4</i>	<i>Fm$\bar{3}m$</i>

Hg-Te (Mercury - Tellurium)

R.C. Sharma and Y.A. Chang, unpublished

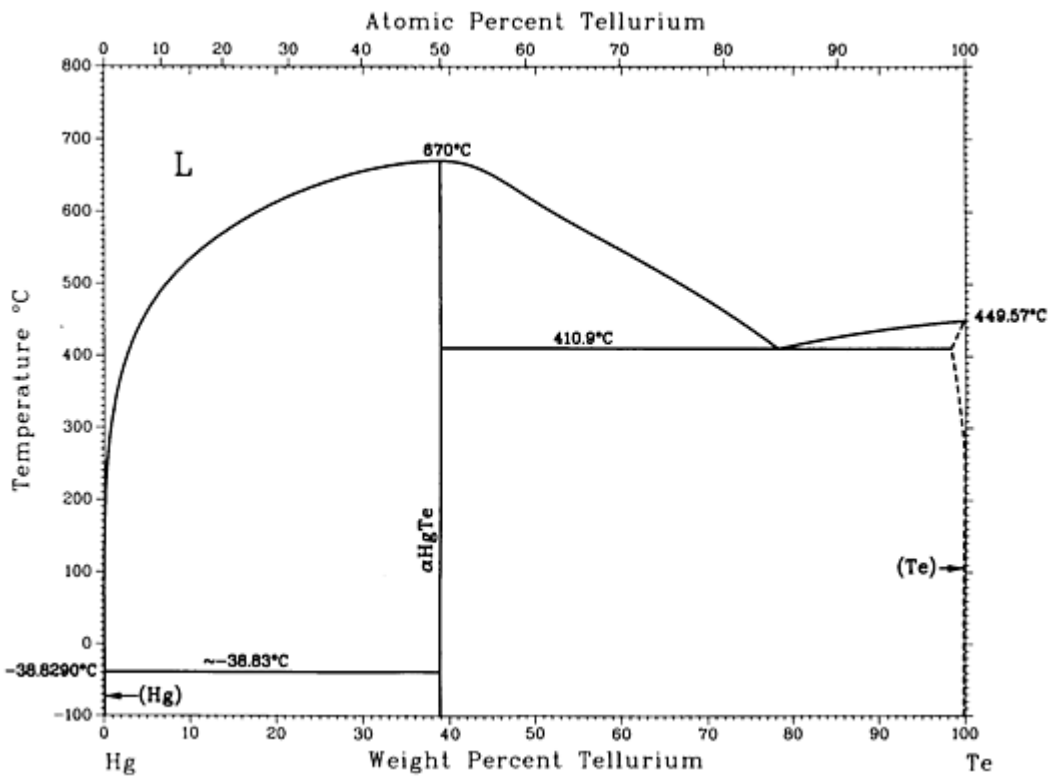

Hg-Te phase diagram

Hg-Te crystallographic data

Phase	Composition, wt% Te	Pearson symbol	Space group
(Hg)	0	<i>hR1</i>	$R\bar{3}m$
α HgTe	30.9	<i>cF8</i>	$F\bar{4}3m$
β HgTe ^(a)	38.9	<i>hP6</i>	$P3_121$
(Te)	~98 to 100	<i>hP3</i>	$P3_121$

(a) High-pressure form

Hg-Tl (Mercury - Thallium)

C. Guminski, unpublished

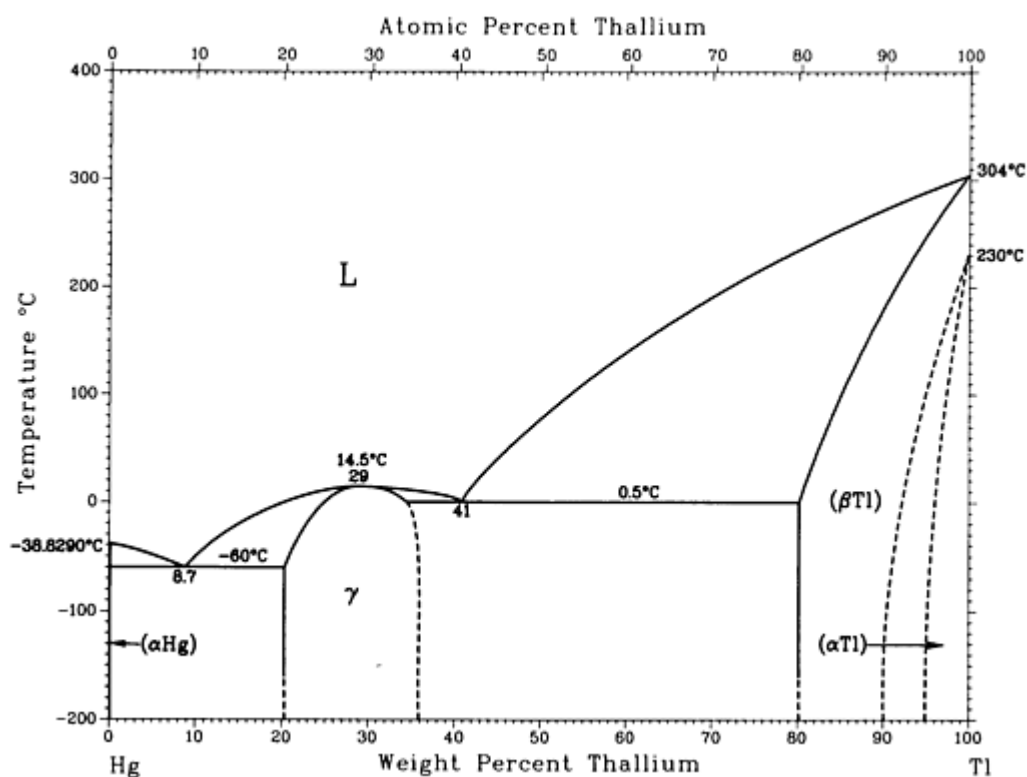

Hg-Tl phase diagram

Hg-Tl crystallographic data

Phase	Composition, wt% Tl	Pearson symbol	Space group
(α Hg)	0	<i>hR1</i>	<i>R$\bar{3}m$</i>
γ or Hg ₅ Tl ₂	~29	<i>cF4</i>	<i>Fm$\bar{3}m$</i>
(β Tl)	80 to 100	<i>cI2</i>	<i>Im$\bar{3}m$</i>
(α Tl)	? to 100	<i>hP2</i>	<i>P6₃/mmc</i>

Hg-Zn (Mercury - Zinc)

L.A. Zabdyr and C. Guminski, unpublished

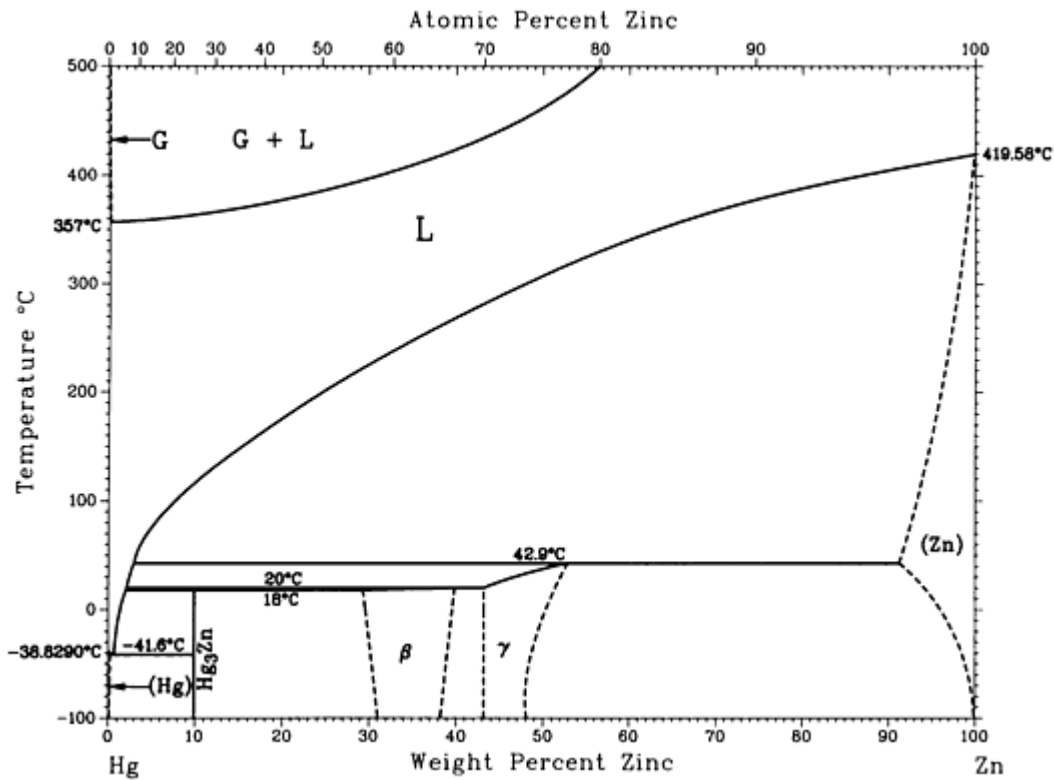

Hg-Zn phase diagram

Hg-Zn crystallographic data

Phase	Composition, wt% Zn	Pearson symbol	Space group
(Hg)	0 to 0.1	<i>hR1</i>	$R\bar{3}m$
Hg ₃ Zn	10
β	~29 to ~40
γ ^(a)	~43 to ~52	<i>oC4</i>	<i>Cmc2₁</i>
(Zn)	~95.0 to 100	<i>hP2</i>	<i>P6₃/mmc</i>

(a) Possibly a hexagonal structure

Ho (Holmium) Binary Alloy Phase Diagrams

Introduction

THIS ARTICLE includes systems where holmium is the first-named element in the binary pair. Additional binary systems that include holmium are provided in the following locations in this Volume:

- “Ag-Ho (Silver - Holmium)” in the article “Ag (Silver) Binary Alloy Phase Diagrams.”
- “Al-Ho (Aluminum - Holmium)” in the article “Al (Aluminum) Binary Alloy Phase Diagrams.”
- “Co-Ho (Cobalt - Holmium)” in the article “Co (Cobalt) Binary Alloy Phase Diagrams.”
- “Fe-Ho (Iron - Holmium)” in the article “Fe (Iron) Binary Alloy Phase Diagrams.”
- “Ga-Ho (Gallium - Holmium)” in the article “Ga (Gallium) Binary Alloy Phase Diagrams.”
- “Ge-Ho (Germanium - Holmium)” in the article “Ge (Germanium) Binary Alloy Phase Diagrams.”

Ho-In (Holmium - Indium)

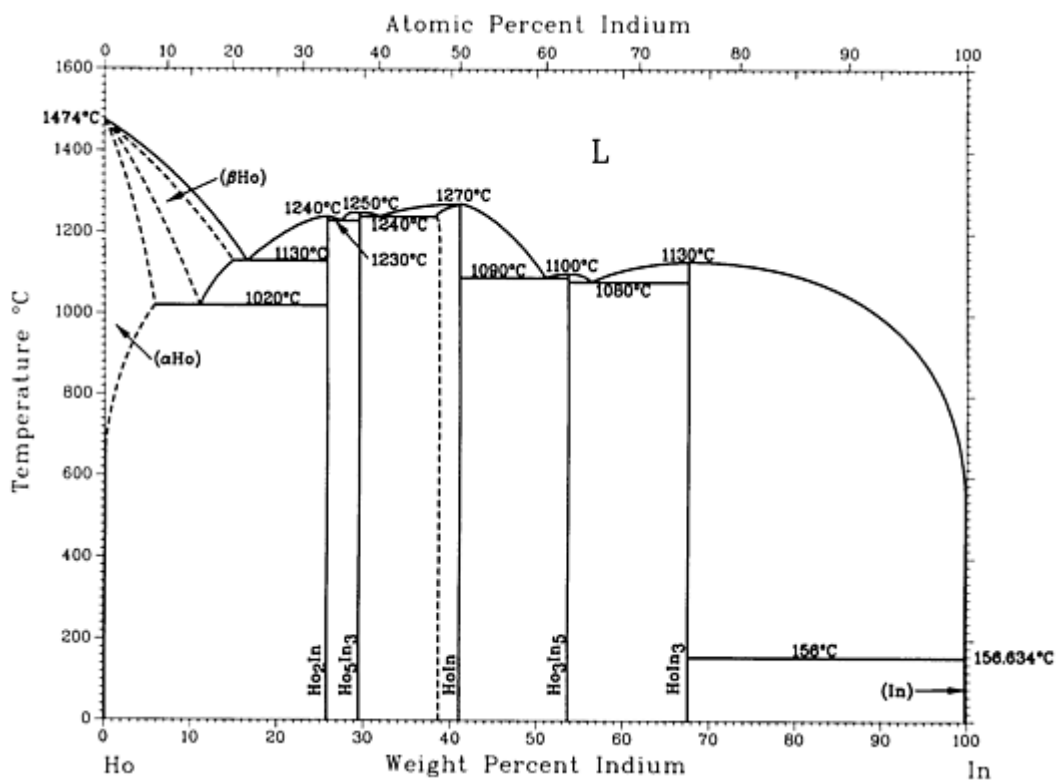

Ho-In phase diagram

Ho-In crystallographic data

Phase	Composition, wt% In	Pearson symbol	Space group
(αHo)	0 to ~6	<i>hP2</i>	<i>P6₃/mmc</i>
(β _{Ho})	0 to 15	<i>cI2</i>	<i>Im$\bar{3}m$</i>
Ho ₂ In	25.8	<i>hP6</i>	<i>P6₃/mmc</i>
β _{Ho₅In₃}	29.5	<i>hP16</i>	<i>P6₃/mcm</i>
α _{Ho₅In₃}	29.5	<i>tI32</i>	<i>I4/mcm</i>
HoIn	33 to 41.0	<i>cP2</i> <i>t**</i>	<i>Pm$\bar{3}m$</i> ...
Ho ₃ In ₅	53.7	<i>oC32</i>	<i>Cmcm</i>
HoIn ₃	68	<i>cP4</i>	<i>Pm$\bar{3}m$</i>

(In)	100	<i>tI2</i>	<i>I4/mmm</i>
------	-----	------------	---------------

Ho-Mn (Holmium - Manganese)

H.R. Kirchmayr and W. Lugscheider, 1967

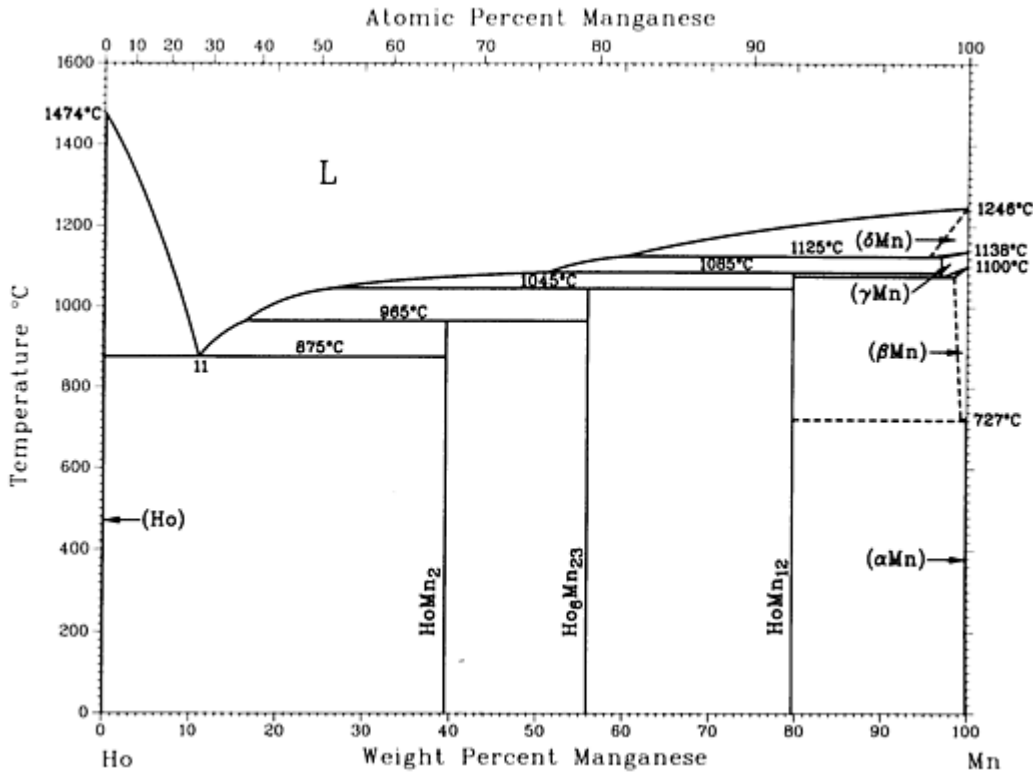

Ho-Mn phase diagram

Ho-Mn crystallographic data

Phase	Composition, wt% Mn	Pearson symbol	Space group
(Ho)	~0	<i>hP2</i>	<i>P6₃/mmc</i>
HoMn_2	40.0	<i>cF24</i>	<i>Fd\bar{3}m</i>
$\text{Ho}_6\text{Mn}_{23}$	~56.1	<i>cF116</i>	<i>Fm\bar{3}m</i>
HoMn_{12}	~80.0	<i>tI26</i>	<i>I4/mmm</i>
(δMn)	~97 to 100	<i>cI2</i>	<i>Im\bar{3}m</i>

(γ_{Mn})	~ 97 to 100	$cF4$	$Fm\bar{3}m$
(β_{Mn})	>97 to 100	$cP20$	$P4_132$
(α_{Mn})	~ 100	$cI58$	$I4\bar{3}m$

Ho-Pd (Holmium - Palladium)

H. Okamoto, 1991

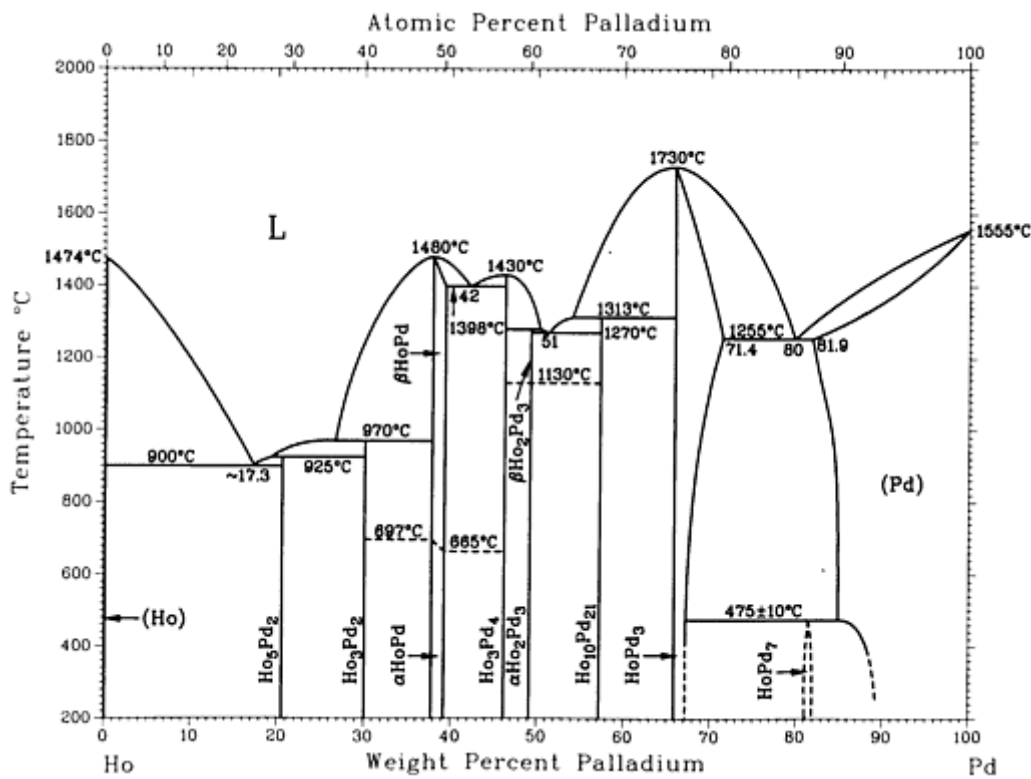

Ho-Pd phase diagram

Ho-Pd crystallographic data

Phase	Composition, wt% Pd	Pearson symbol	Space group
(Ho)	0	<i>hP2</i>	<i>P6₃/mmc</i>
Ho ₃ Pd ₂	20.5	<i>tI49</i>	<i>I4₁a</i>
Ho ₃ Pd ₂	30	<i>tP10</i>	<i>P4/mbm</i>
β HoPd	~39.2	<i>cP2</i>	<i>Pm$\bar{3}m$</i>
α HoPd	~39.2	<i>oP8</i>	<i>Pnma</i>
Ho ₃ Pd ₄	46.2	<i>hR14</i>	<i>R$\bar{3}$</i>
β Ho ₂ Pd ₃	49.2
α Ho ₂ Pd ₃	49.2

Ho ₁₀ Pd ₂₁ ^(a)	57.5	<i>mC124</i>	<i>C2/m</i>
HoPd ₃	66 to 71.4	<i>cP4</i>	<i>Pm$\bar{3}m$</i>
HoPd ₇	81.9	<i>c**</i>	...
(Pd)	81.9 to 100	<i>cF4</i>	<i>Fm$\bar{3}m$</i>

(a) Similarity to Sm₁₀Pd₂₁ is assumed.

Ho-Sb (Holmium - Antimony)

H. Okamoto, 1990

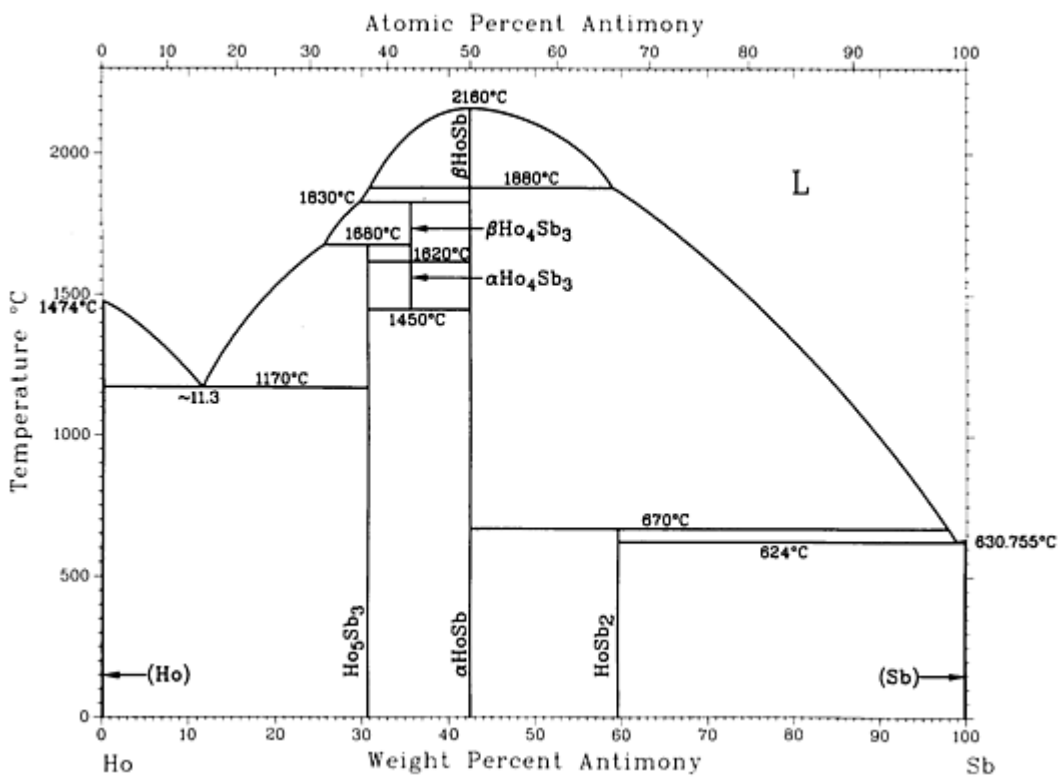

Ho-Sb phase diagram

Ho-Sb crystallographic data

Phase	Composition, wt% Sb	Pearson symbol	Space group
(Ho)	0	<i>hP2</i>	<i>P6₃/mmc</i>

Ho_5Sb_3	30.7	<i>hP16</i>	<i>P6₃/mcm</i>
$\beta\text{Ho}_4\text{Sb}_3$	35.7
$\alpha\text{Ho}_4\text{Sb}_3$	35.7	<i>cI28</i>	<i>I4₃d</i>
βHoSb	42.5	...	
αHoSb	42.5	<i>cF8</i>	<i>Fm3\bar{m}</i>
$\text{HoSb}_2^{(a)}$	59.7	<i>oC6</i>	<i>C222</i>
(Sb)	100	<i>hR2</i>	<i>R3\bar{m}</i>

(a) Synthesized under high pressure

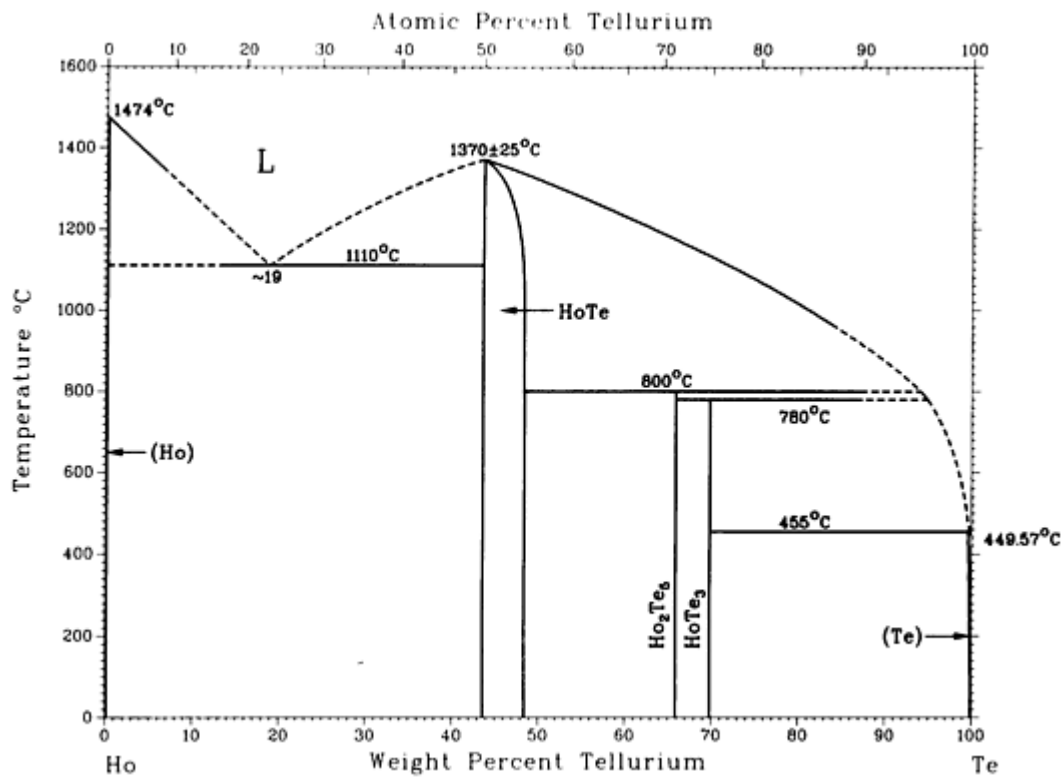

Ho-Te phase diagram

Ho-Te crystallographic data

Phase	Composition, wt% Te	Pearson symbol	Space group
(Ho)	~0	<i>hP2</i>	<i>P6₃/mmc</i>
HoTe	44 to <49	<i>cF8</i>	<i>Fm$\bar{3}m$</i>
Ho ₂ Te ₅	~65.9	<i>oC28</i>	<i>Cmcm</i>
HoTe ₃	70	<i>oC16</i>	<i>Cmcm</i>
(Te)	~100	<i>hP3</i>	<i>P3₁21</i>

Ho-Tl (Holmium - Thallium)

S. Delfino, A. Saccone, A. Palenzona, and R. Ferro, unpublished

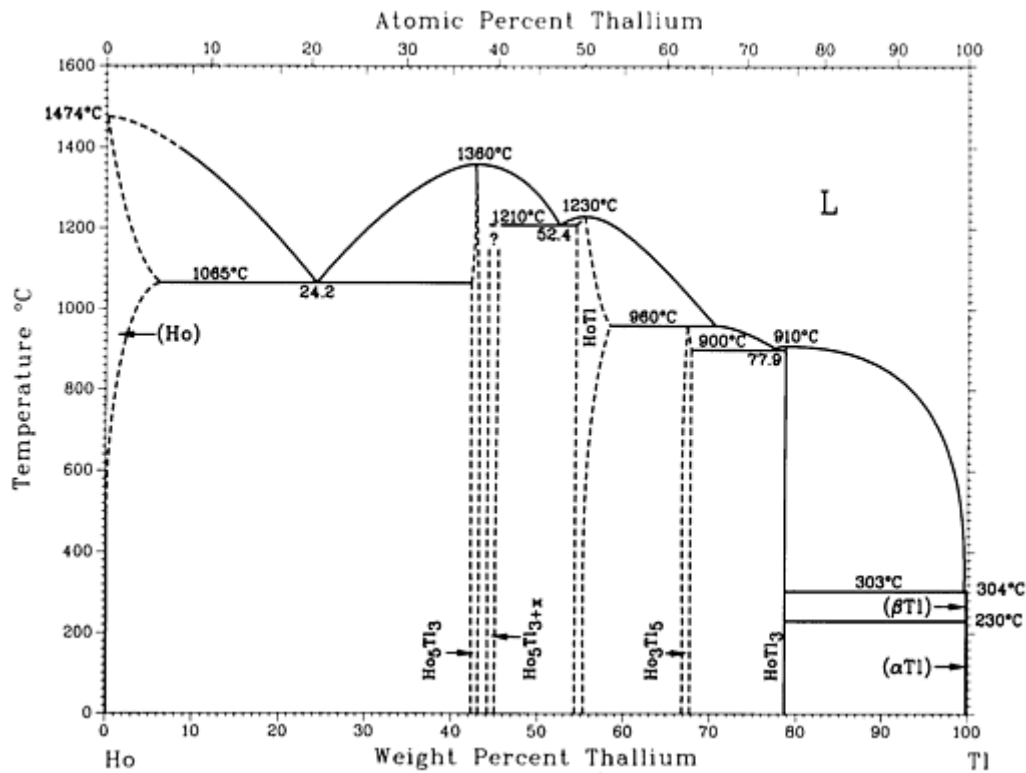

Ho-Tl phase diagram

Ho-Tl crystallographic data

Phase	Composition, wt% Tl	Pearson symbol	Space group
(Ho)	0 to ~6	<i>hP2</i>	<i>P6₃/mmc</i>
Ho ₅ Tl ₃	~42 to ~43	<i>hP16</i>	<i>P6₃/mcm</i>
Ho ₅ Tl _{3+x}	?	<i>tI32</i>	<i>I4/mcm</i>
HoTl ^(a)	~54 to ~58	<i>cP2</i> (or <i>cI2</i>)	<i>Pm$\bar{3}m$</i> <i>Im$\bar{3}m$</i>
HoTl ^(b)	~54 to ~58	<i>tP2</i>	<i>P4/mmm</i>
Ho ₃ Tl ₅	~67 to ~68	<i>oC32</i>	<i>Cmcm</i>
HoTl ₃	79	<i>cP4</i>	<i>Pm$\bar{3}m$</i>

(βTl)	100	$cI2$	$Im\bar{3}m$
(αTl)	100	$hP2$	$P6_3/mmc$

- (a) Cubic structure presumed to be room- and higher-temperature phase.
- (b) Tetragonal structure presumed to be lower-temperature phase

In (Indium) Binary Alloy Phase Diagrams

Introduction

THIS ARTICLE includes systems where indium is the first-named element in the binary pair. Additional binary systems that include indium are provided in the following locations in this Volume:

- “Ag-In (Silver - Indium)” in the article “Ag (Silver) Binary Alloy Phase Diagrams.”
- “Al-In (Aluminum - Indium)” in the article “Al (Aluminum) Binary Alloy Phase Diagrams.”
- “As-In (Arsenic - Indium)” in the article “As (Arsenic) Binary Alloy Phase Diagrams.”
- “Au-In (Gold - Indium)” in the article “Au (Gold) Binary Alloy Phase Diagrams.”
- “Ba-In (Barium - Indium)” in the article “Ba (Barium) Binary Alloy Phase Diagrams.”
- “Bi-In (Bismuth - Indium)” in the article “Bi (Bismuth) Binary Alloy Phase Diagrams.”
- “Ca-In (Calcium - Indium)” in the article “Ca (Calcium) Binary Alloy Phase Diagrams.”
- “Cd-In (Cadmium - Indium)” in the article “Cd (Cadmium) Binary Alloy Phase Diagrams.”
- “Ce-In (Cerium - Indium)” in the article “Ce (Cerium) Binary Alloy Phase Diagrams.”
- “Cl-In (Chlorine - Indium)” in the article “Cl (Chlorine) Binary Alloy Phase Diagrams.”
- “Cs-In (Cesium - Indium)” in the article “Cs (Cesium) Binary Alloy Phase Diagrams.”
- “Cu-In (Copper - Indium)” in the article “Cu (Copper) Binary Alloy Phase Diagrams.”
- “Dy-In (Dysprosium - Indium)” in the article “Dy (Dysprosium) Binary Alloy Phase Diagrams.”
- “Er-In (Erbium - Indium)” in the article “Er (Erbium) Binary Alloy Phase Diagrams.”
- “Eu-In (Europium - Indium)” in the article “Eu (Europium) Binary Alloy Phase Diagrams.”
- “Ga-In (Gallium - Indium)” in the article “Ga (Gallium) Binary Alloy Phase Diagrams.”
- “Gd-In (Gadolinium - Indium)” in the article “Gd (Gadolinium) Binary Alloy Phase Diagrams.”
- “Ge-In (Germanium - Indium)” in the article “Ge (Germanium) Binary Alloy Phase Diagrams.”
- “Hg-In (Mercury - Indium)” in the article “Hg (Mercury) Binary Alloy Phase Diagrams.”
- “Ho-In (Holmium - Indium)” in the article “Ho (Holmium) Binary Alloy Phase Diagrams.”

Introduction

THIS ARTICLE includes systems where iridium is the first-named element in the binary pair. Additional binary systems that include iridium are provided in the following locations in this Volume:

- “Ce-Ir (Cerium - Iridium)” in the article “Ce (Cerium) Binary Alloy Phase Diagrams.”
- “Cr-Ir (Chromium - Iridium)” in the article “Cr (Chromium) Binary Alloy Phase Diagrams.”
- “Cu-Ir (Copper - Iridium)” in the article “Cu (Copper) Binary Alloy Phase Diagrams.”
- “Fe-Ir (Iron - Iridium)” in the article “Fe (Iron) Binary Alloy Phase Diagrams.”
- “Hf-Ir (Hafnium - Iridium)” in the article “Hf (Hafnium) Binary Alloy Phase Diagrams.”

Ir-La (Iridium - Lanthanum)

H. Okamoto, 1991

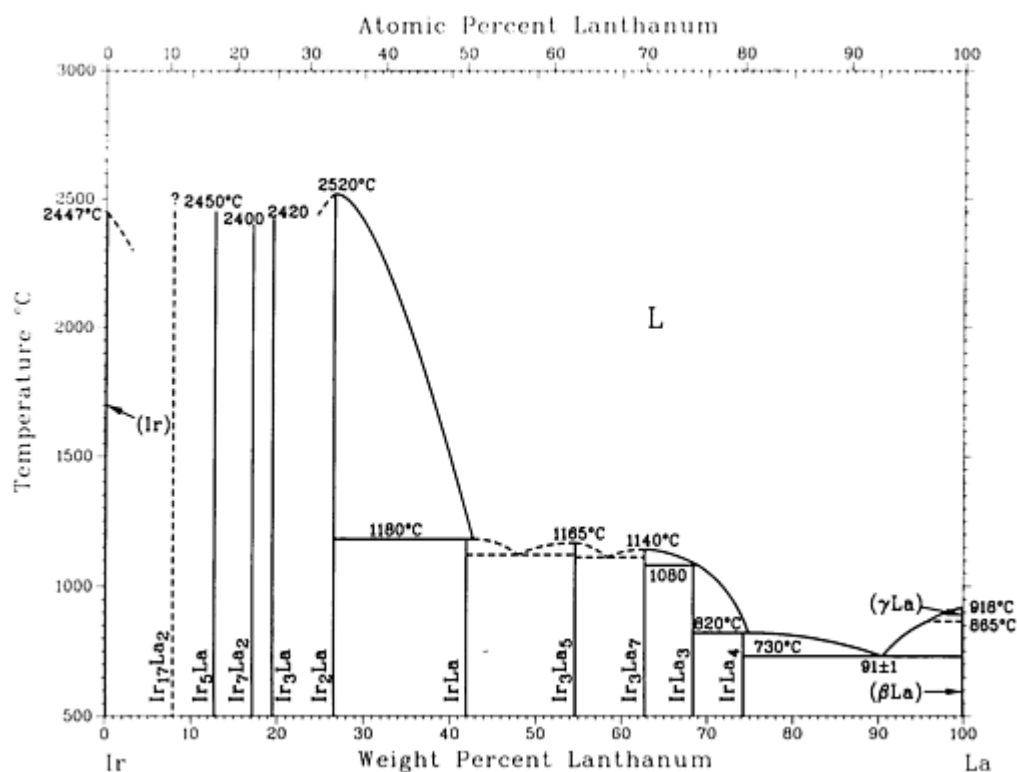

Ir-La phase diagram

Ir-La crystallographic data

Phase	Composition, wt% La	Pearson symbol	Space group
(Ir)	0	<i>cF4</i>	<i>Fm</i> $\bar{3}m$

$\text{Ir}_{17}\text{La}_2?$	7.8
Ir_3La	12.7	$hP6$	$P6/mmm$
Ir_7La_2	17.1	$hP36$	$P6_3/mmc$
Ir_3La	19	$hR12$	$R\bar{3}m$
Ir_2La	26.5	$cF24$	$Fd\bar{3}m$
$\text{IrLa}?$	41.9
Ir_3La_5	54.6	$tP32$	$P4/ncc$
Ir_3La_7	63	$hP20$	$P6_3mc$
IrLa_3	68	$oP16$	$Pnma$
IrLa_4	74
(γLa)	100	$cI2$	$Im\bar{3}m$
(βLa)	100	$cF4$	$Fm\bar{3}m$
(αLa)	100	$hP4$	$P6_3/mmc$

Ir-Mo (Iridium - Molybdenum)

From [Molybdenum] 12

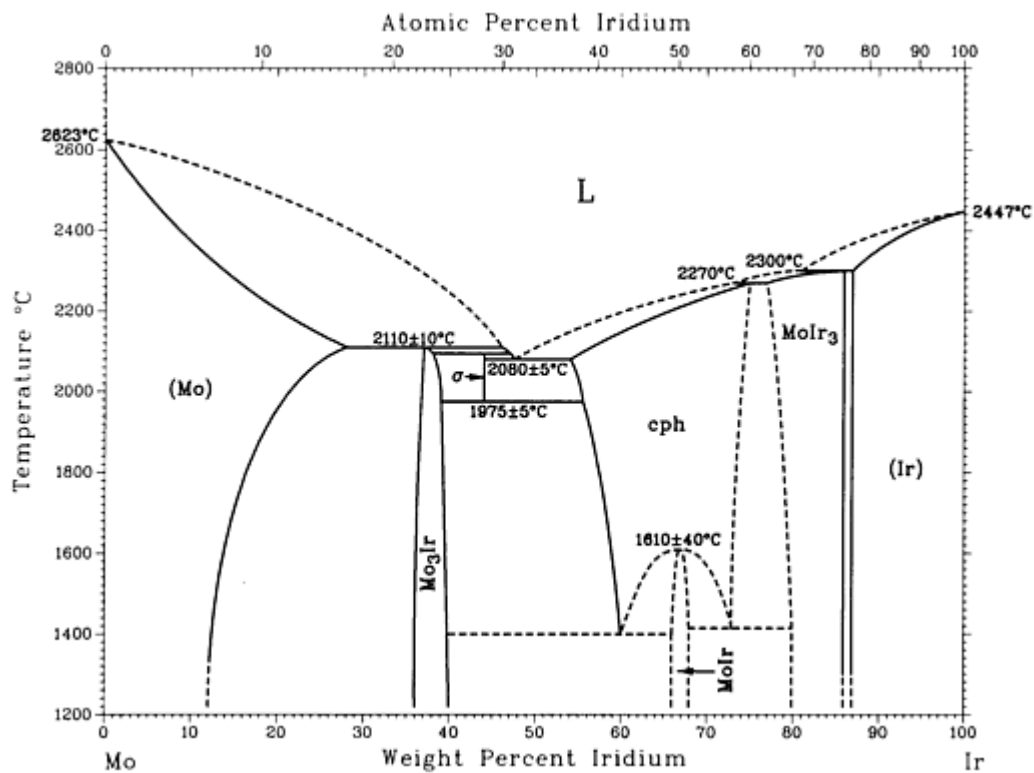

Ir-Mo phase diagram

Ir-Mo crystallographic data

Phase	Composition, wt% Ir	Pearson symbol	Space group
(Mo)	0 to ~28	<i>cI2</i>	<i>Im</i> $\bar{3}m$
Mo_3Ir	<36 to 40	<i>cP8</i>	<i>Pm</i> $\bar{3}n$
σ	~44	<i>tP30</i>	<i>P4</i> $_2/mnm$
MoIr (cph)	~54 to >75	<i>hP2</i>	<i>P6</i> $_3/mmc$
MoIr (LT)	~66 to 68	<i>oP4</i>	<i>Pmma</i>
MoIr_3	~77 to 86	<i>hP8</i>	<i>P6</i> $_3/mmc$
(Ir)	~87 to 100	<i>cF4</i>	<i>Fm</i> $\bar{3}m$

Reference cited in this section

12. [Molybdenum]: L. Brewer, *Molybdenum: Physico-Chemical Properties of Its Compounds and Alloys*, O. Kubaschewski, Ed., Atomic Energy Review Special Issue No.7, International Atomic Energy Agency, Vienna (1980).

Ir-Nb (Iridium - Niobium)

H. Okamoto, unpublished

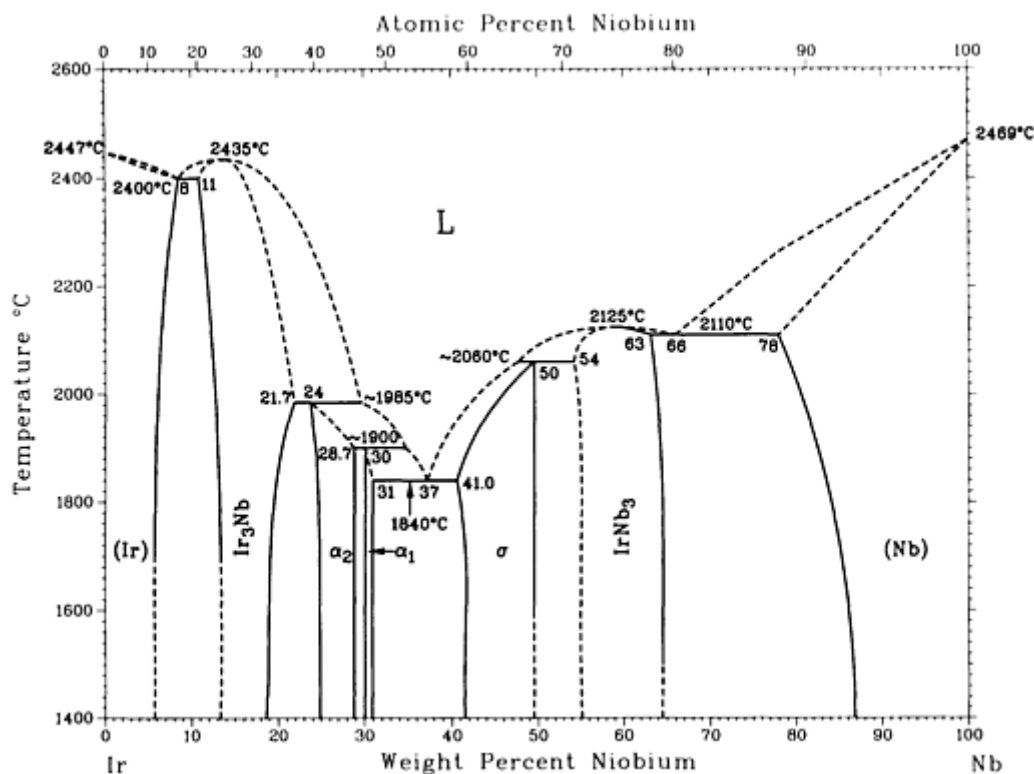

Ir-Nb phase diagram

Ir-Nb crystallographic data

Phase	Composition, wt% Nb	Pearson symbol	Space group
(Ir)	0 to 8	<i>cF4</i>	<i>Fm</i> $\bar{3}m$
Ir ₃ Nb	11 to 21.7	<i>cP4</i>	<i>Pm</i> $\bar{3}m$
α ₂	24 to 28.7	<i>oP12</i>	<i>Pmma</i>
α ₁	30 to 31	<i>tP2</i>	<i>P4/mmm</i>

σ	41.0 to 50	<i>tP30</i>	<i>P4₂/mnm</i>
IrNb ₃	54 to 63	<i>cP8</i>	<i>Pm$\bar{3}n$</i>
(Nb)	78 to 100	<i>cI2</i>	<i>Im$\bar{3}m$</i>

Ir-Ni (Iridium - Nickel)

S.C. Yang, N. Chen, and P. Nash, 1991

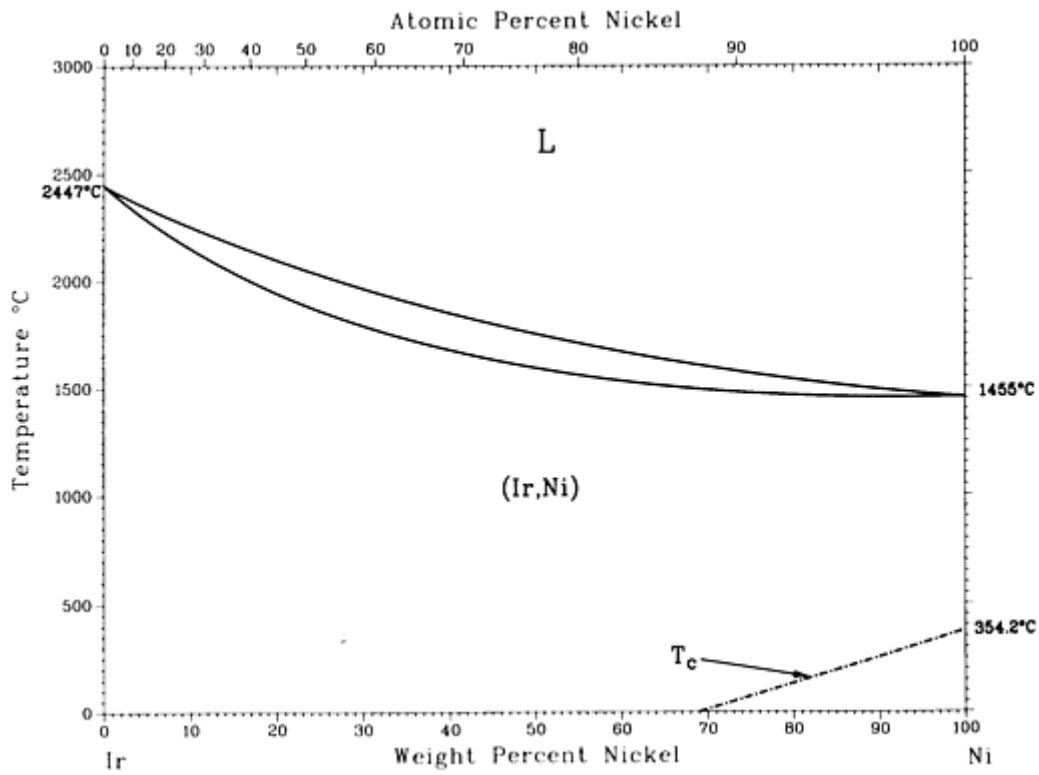

Ir-Ni phase diagram

Ir-Ni crystallographic data

Phase	Composition, wt% Ni	Pearson symbol	Space group
(Ir,Ni)	0 to 100	<i>cF4</i>	<i>Fm</i> $\bar{3}m$

Ir-Pd (Iridium - Palladium)

S.N. Tripathi, S.R. Bharadwaj, and M.S. Chandrasekharaiah, 1991

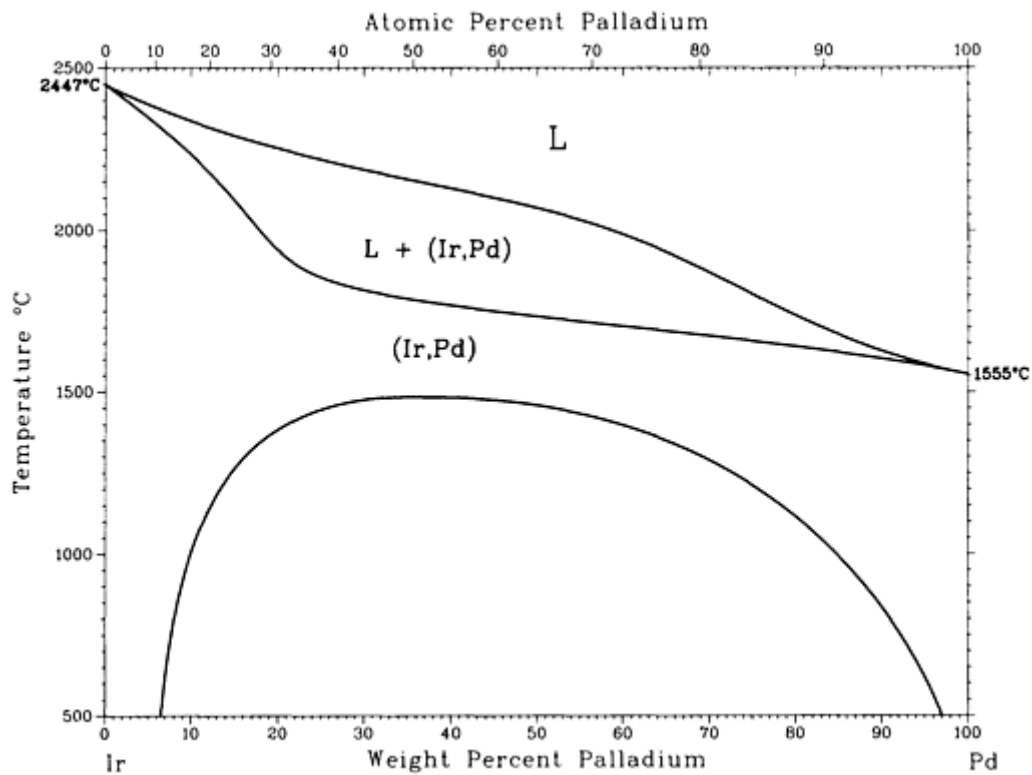

Ir-Pd phase diagram

Ir-Pd crystallographic data

Phase	Composition, wt% Pd	Pearson symbol	Space group
(Ir,Pd)	0 to 100	$cF4$	$Fm\bar{3}m$

Ir-Pt (Iridium - Platinum)

L. Muller, 1930; and E. Raub and W. Plate, 1956

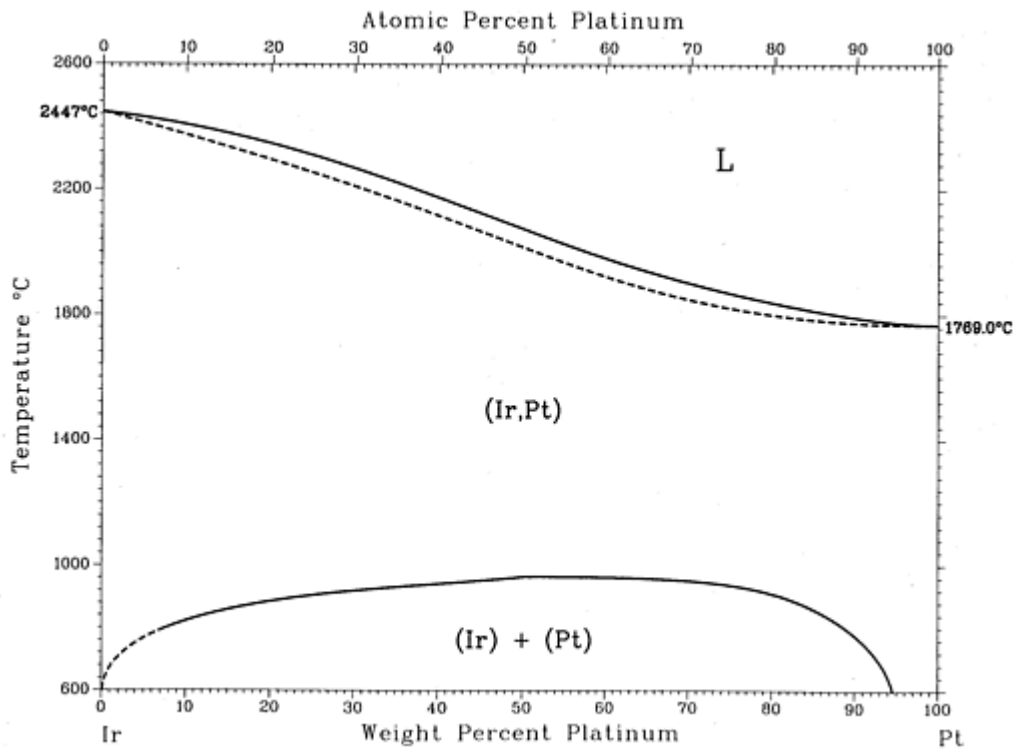

Ir-Pt phase diagram

Ir-Pt crystallographic data

Phase	Composition, wt% Pt	Pearson symbol	Space group
(Ir,Pt)	0 to 100	$cF4$	$Fm\bar{3}m$

Ir-Rh (Iridium - Rhodium)

S.N. Tripathi, S.R. Bharadwaj, and M.S. Chandrasekharaiah, 1991

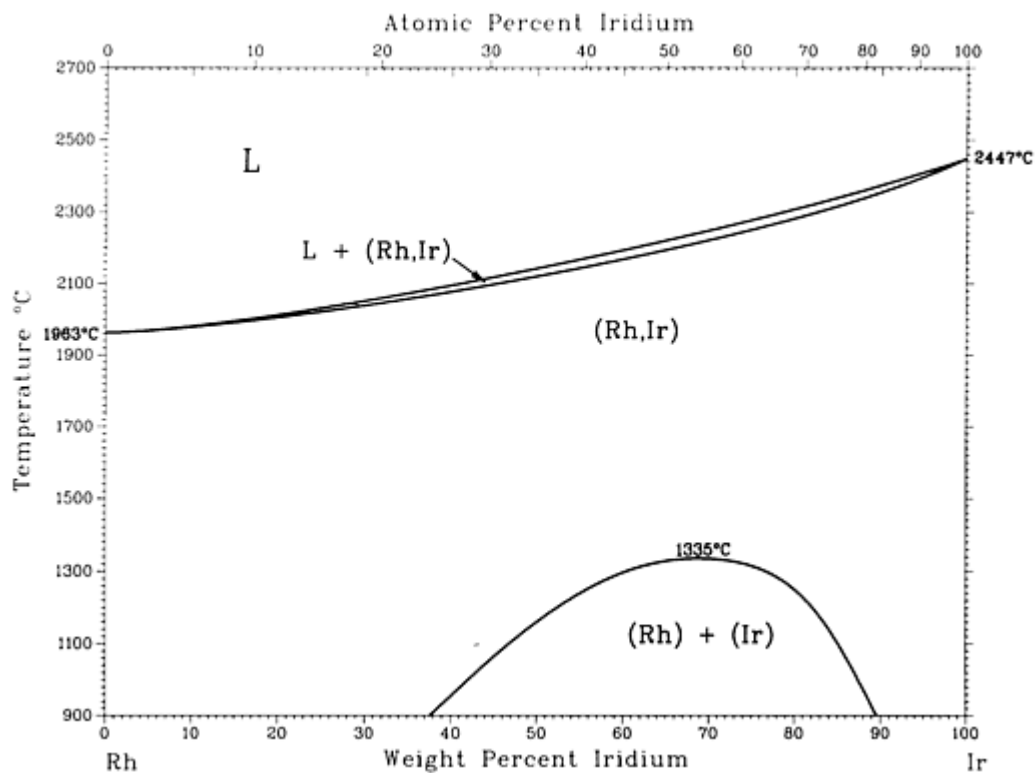

Ir-Rh phase diagram

Ir-Rh crystallographic data

Phase	Composition, wt% Ir	Pearson symbol	Space group
(Ir,Rh)	0 to 100	$cF4$	$Fm\bar{3}m$

Ir-Ru (Iridium - Ruthenium)

H. Okamoto, 1992

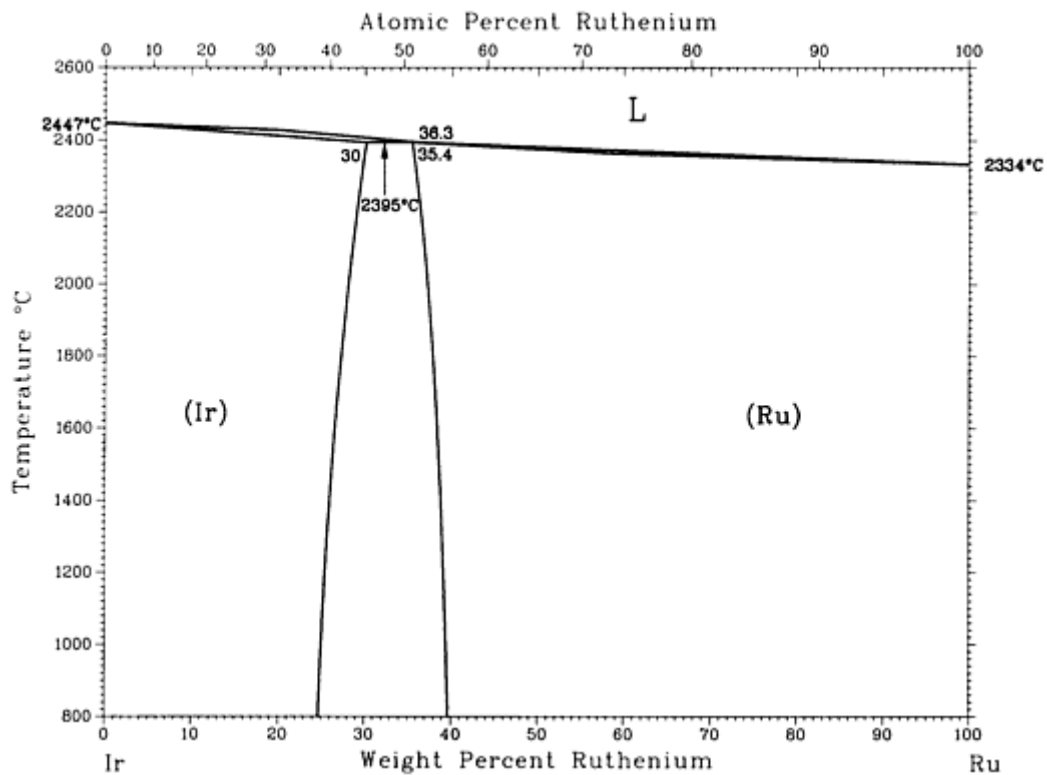

Ir-Ru phase diagram

Ir-Ru crystallographic data

Phase	Composition, wt% Ru	Pearson symbol	Space group
(Ir)	0 to 30	<i>cF4</i>	<i>Fm$\bar{3}m$</i>
(Ru)	35.4 to 100	<i>hP2</i>	<i>P6₃/mmc</i>

Ir-Ta (Iridium - Tantalum)

From [Metals] 10

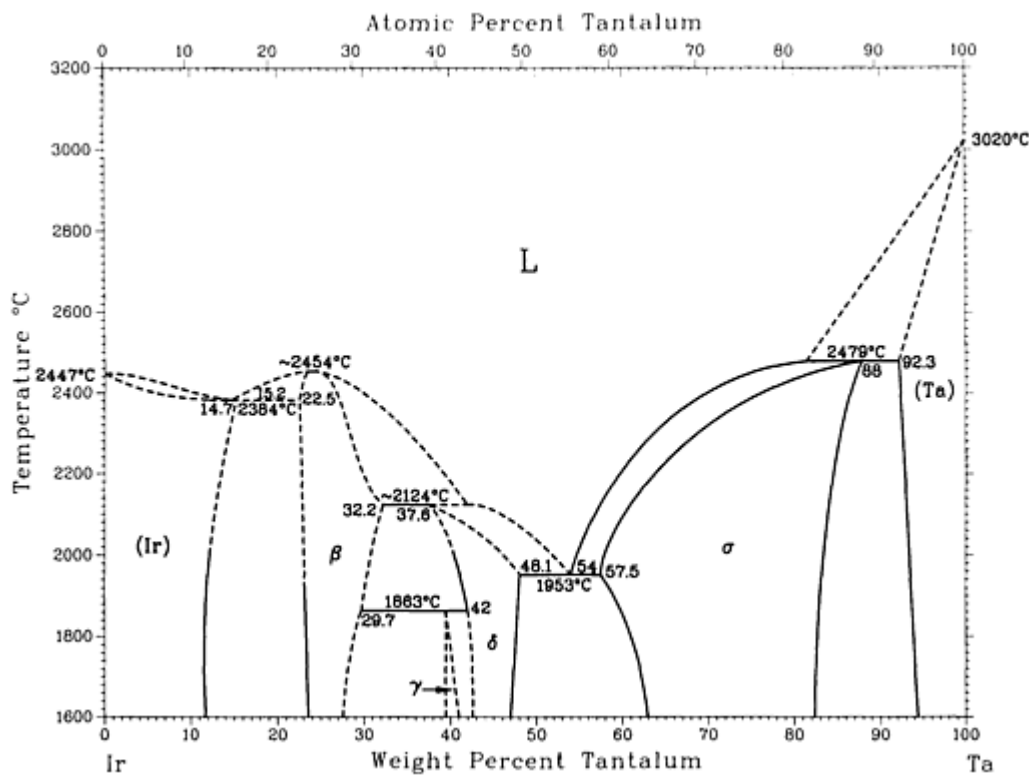

Ir-Ta phase diagram

Ir-Ta crystallographic data

Phase	Composition, wt% Ta	Pearson symbol	Space group
(Ir)	0 to 15.2	<i>cF4</i>	<i>Fm$\bar{3}m$</i>
β	22.5 to 32.2	<i>cP4</i>	<i>Pm$\bar{3}m$</i>
γ	~41	<i>tI2</i>	<i>I4/mmm</i>
δ	37.6 to 48.1	<i>oP12</i>	<i>Pmma</i>
σ	57.5 to 88.0	<i>tP30</i>	<i>P4₂/mnm</i>
(Ta)	92.3 to 100	<i>cI2</i>	<i>Im$\bar{3}m$</i>

Reference cited in this section

10. [Metals]: *Metals Handbook*, Metallography, Structures and Phase Diagrams, Vol.8, 8th ed., American Society for Metals, Metals Park, OH (1973).

Ir-Th (Iridium - Thorium)

H. Okamoto, 1991

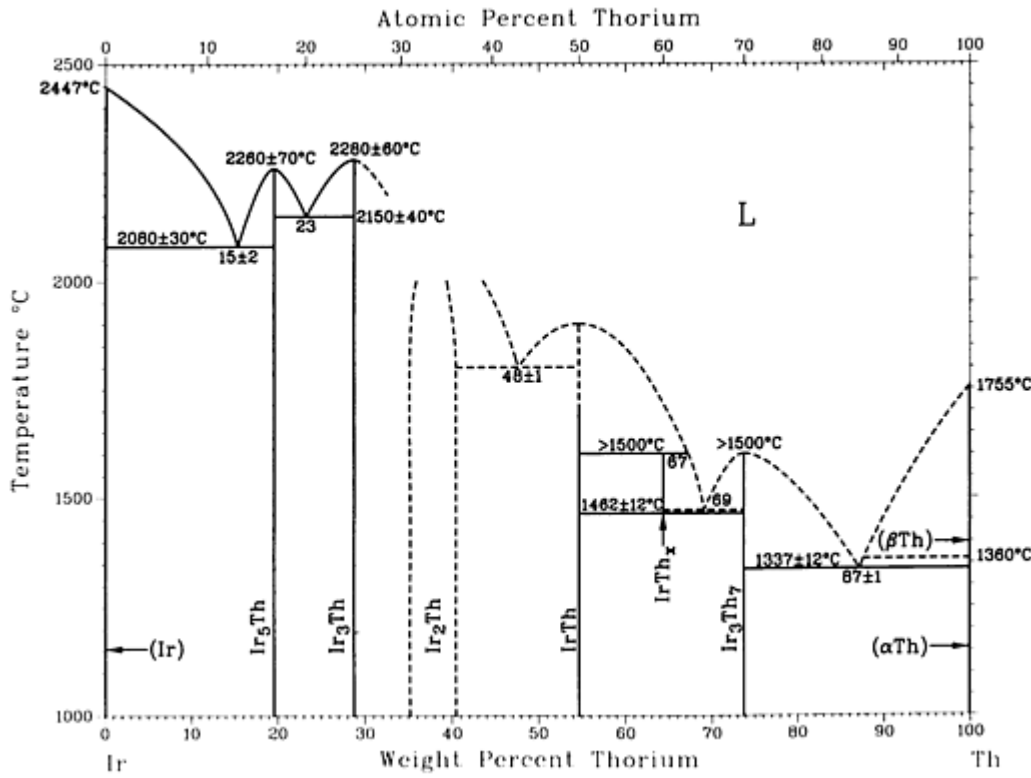

Ir-Th phase diagram

Ir-Th crystallographic data

Phase	Composition, wt% Th	Pearson symbol	Space group
(Ir)	0	$cF4$	$Fm\bar{3}m$
Ir_5Th	19.5	$hP6$	$P6/mmm$
Ir_3Th	29
Ir_2Th	35 to 40	$cF24$	$Fd\bar{3}m$
$IrTh$	54.7	$oC8$	$Cmcm$

IrTh _x	~64
Ir ₃ Th ₇	74	<i>hP20</i>	<i>P6₃mc</i>
(β _{Th})	100	<i>cI2</i>	<i>Im$\bar{3}m$</i>
(α _{Th})	100	<i>cF4</i>	<i>Fm$\bar{3}m$</i>

Ir-Ti (Iridium - Titanium)

H. Okamoto, 1992

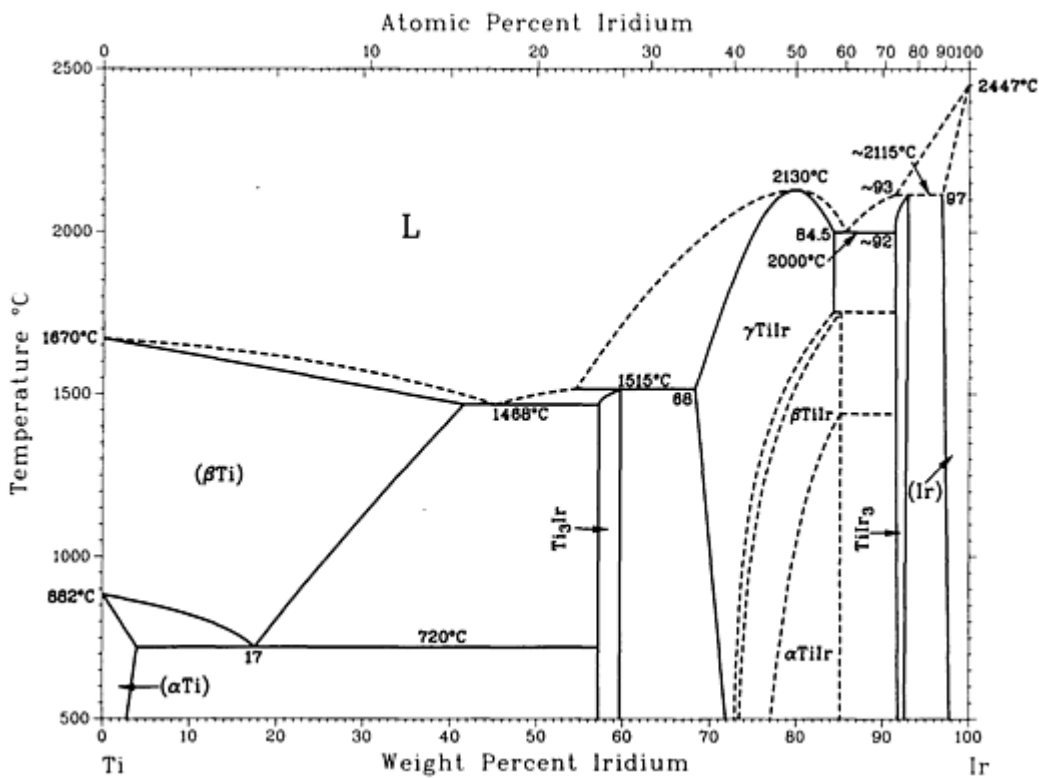

Ir-Ti phase diagram

Ir-Ti crystallographic data

Phase	Composition, wt% Ir	Pearson symbol	Space group
(β _{Ti})	0 to 4	<i>cI2</i>	<i>Im$\bar{3}m$</i>
(α _{Ti})	0 to 40.5	<i>hP2</i>	<i>P6₃/mmc</i>

Ti ₃ Ir	57 to 60	cP8	$Pm\bar{3}n$
γ TiIr	68 to 84	cP2	$Pm\bar{3}m$
β TiIr	73 to ?	tP2	$P4/mmm$
α TiIr	77 to ?	c**	...
TiIr ₃	~92 to ~93	cP4	$Pm\bar{3}m$
(Ir)	~97 to 100	cF4	$Fm\bar{3}m$

Ir-U (Iridium - Uranium)

H. Okamoto, 1992

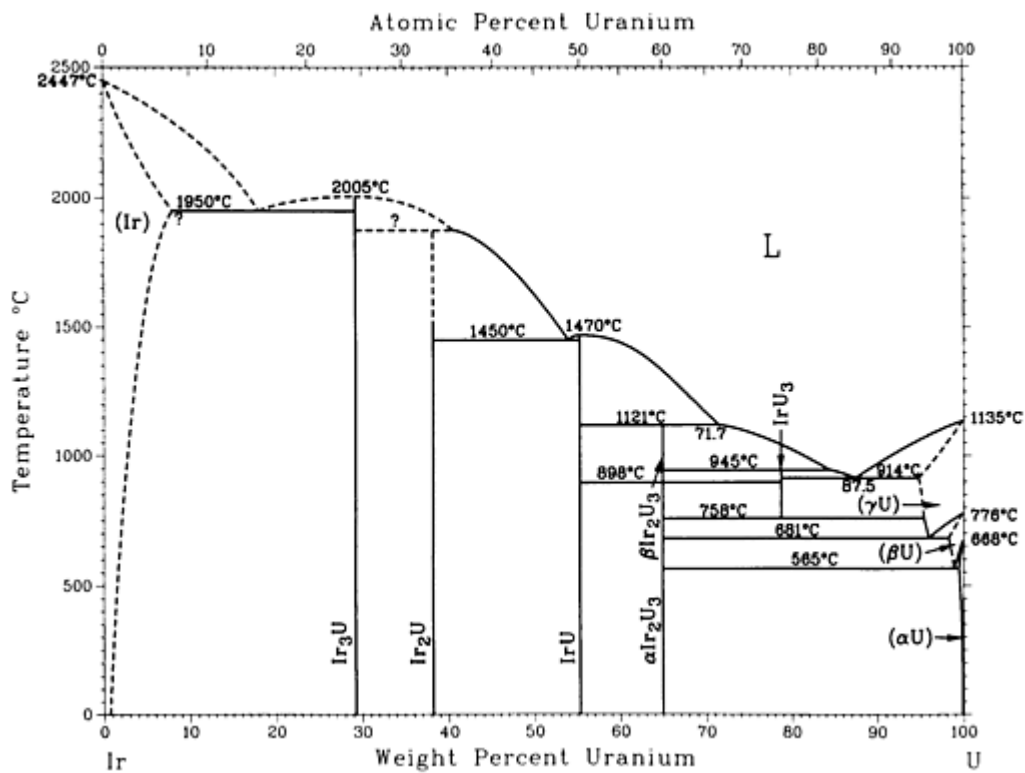

Ir-U phase diagram

Ir-U crystallographic data

Phase	Composition, wt% U	Pearson symbol	Space group
-------	--------------------	----------------	-------------

(Ir)	0 to ?	<i>cF4</i>	<i>Fm$\bar{3}m$</i>
Ir ₃ U	29	<i>cP4</i>	<i>Pm$\bar{3}m$</i>
Ir ₂ U	38.2	<i>cF24</i>	<i>Fd$\bar{3}m$</i>
IrU	55.3
β Ir ₂ U ₃	65
α Ir ₂ U ₃	65
IrU ₃	79
(γ U)	? to 100	<i>cI2</i>	<i>Im$\bar{3}m$</i>
(β U)	? to 100	<i>tP30</i>	<i>P4₂/mnm</i>
(α U)	? to 100	<i>oC4</i>	<i>Cmcm</i>
Possible phase			
IrU ₂	71.3	<i>m**</i>	...

Ir-V (Iridium - Vanadium)

J.F. Smith, 1989

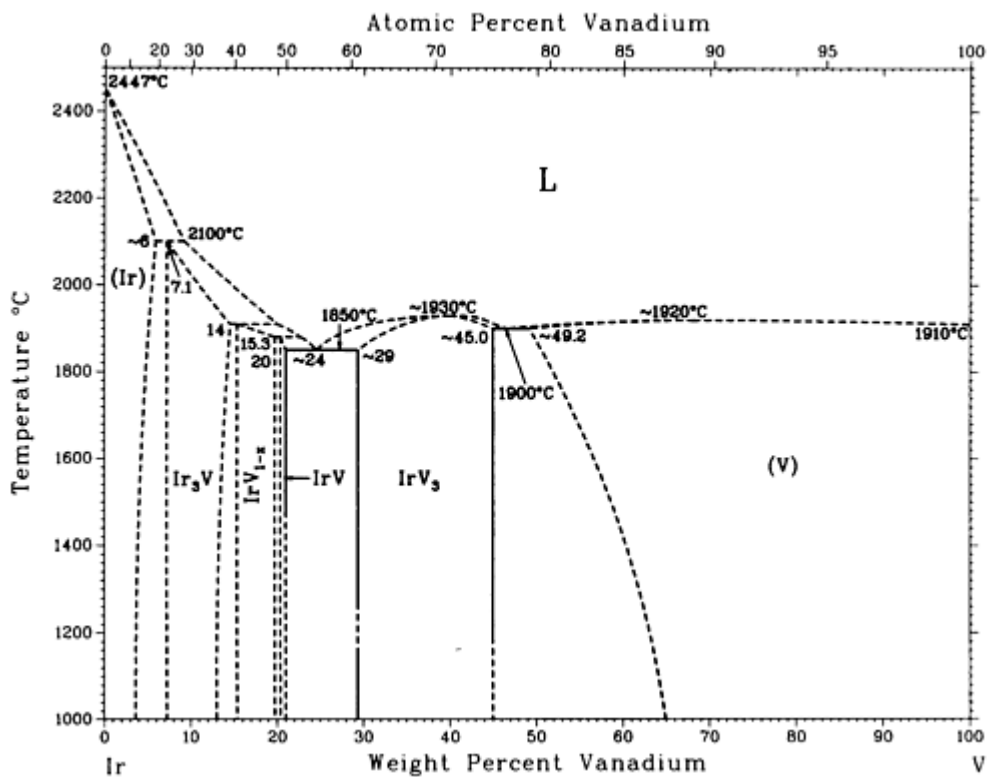

Ir-V phase diagram

Ir-V crystallographic data

Phase	Composition, wt% V	Pearson symbol	Space group
(Ir)	0 to ~6	<i>cF4</i>	<i>Fm</i> $\bar{3}m$
Ir_3V	7.1 to 14	<i>cP4</i>	<i>Pm</i> $\bar{3}m$
IrV_{1-x}	15.3 to 20	<i>tP2</i>	<i>P4/mmm</i>
IrV	~20.9	<i>oC8</i>	<i>Cmmm</i>
IrV_3	~29 to ~45.0	<i>cP8</i>	<i>Pm</i> $\bar{3}n$
(V)	~49.2 to 100	<i>cI2</i>	<i>Im</i> $\bar{3}m$

Ir-W (Iridium - Tungsten)

S.V. Nagender Naidu, A.M. Sriramamurthy, and P. Rama Rao, 1991

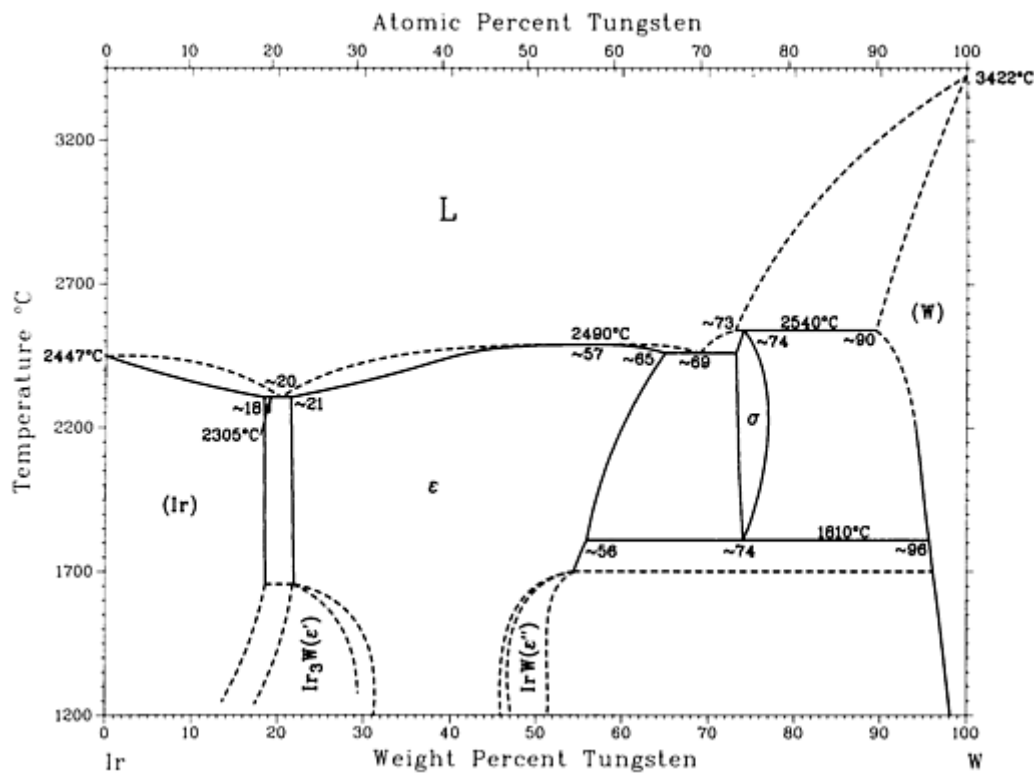

Ir-W phase diagram

Ir-W crystallographic data

Phase	Composition, wt% W	Pearson symbol	Space group
(Ir)	0 to ~18	<i>cF4</i>	<i>Fm</i> $\bar{3}m$
ε	~21 to ~65	<i>hP2</i>	<i>P6</i> ₃ / <i>mmc</i>
Ir ₃ W(ε')	~24 ^(a)	<i>hP8</i>	<i>P6</i> ₃ / <i>mmc</i>
IrW(ε'')	48.9 ^(a)	<i>oP4</i>	<i>Pmma</i>
σ	74	<i>tP30</i>	<i>P4</i> ₂ / <i>mnm</i>
(W)	~90 to 100	<i>cI2</i>	<i>Im</i> $\bar{3}m$

(a) Ordered

Ir-Zr (Iridium - Zirconium)

H. Okamoto, 1992

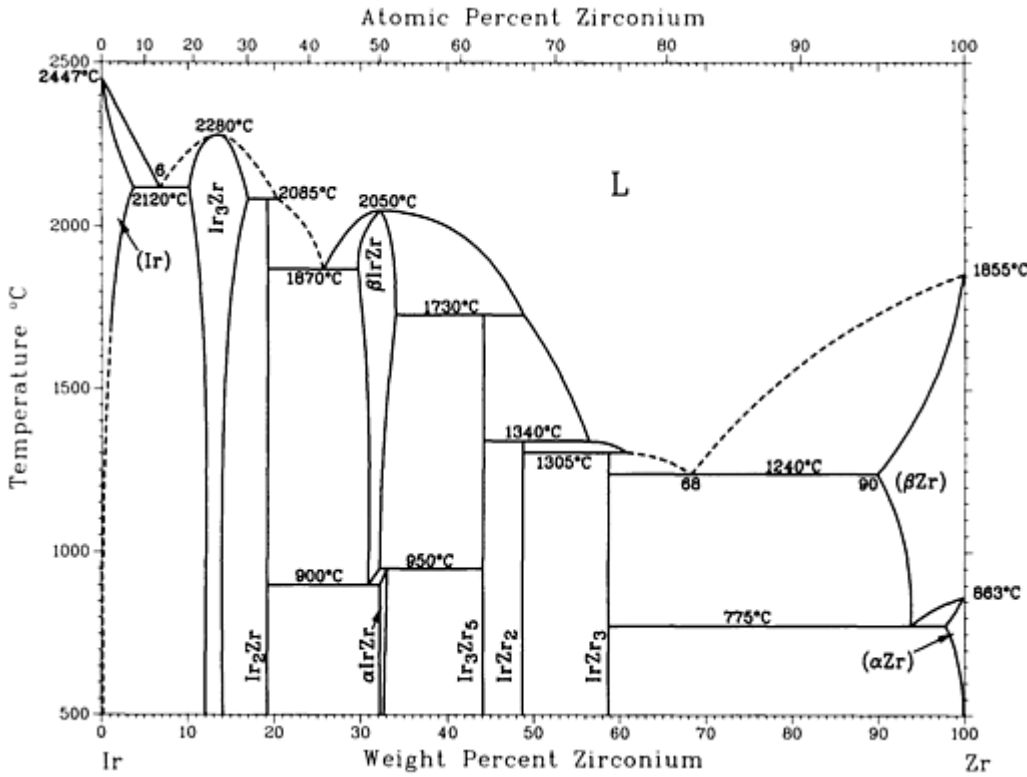

Ir-Zr phase diagram

Ir-Zr crystallographic data

Phase	Composition, wt% Zr	Pearson symbol	Space group
(Ir)	0 to 3	<i>cF4</i>	<i>Fm</i> $\bar{3}m$
Ir ₃ Zr	10 to 17	<i>cP4</i>	<i>Pm</i> $\bar{3}m$
Ir ₂ Zr	19.2	<i>cF24</i>	<i>Fd</i> $\bar{3}m$
βIrZr	30 to 34	<i>cP2</i>	<i>Pm</i> $\bar{3}m$
αIrZr	32.2 to 33	(a)	...
Ir ₃ Zr ₅	44.2	<i>hP16</i>	<i>P6</i> ₃ / <i>mcm</i>

IrZr ₂	48.7	<i>tI12</i>	<i>I4/mcm</i>
IrZr ₃	59	<i>tI32</i>	<i>I4₂/m</i>
(β _{Zr})	90 to 100	<i>cI2</i>	<i>Im3m</i>
(α _{Zr})	98 to 100	<i>hP2</i>	<i>P6₃/mmc</i>

(a)

Complex

K (Potassium) Binary Alloy Phase Diagrams

Introduction

THIS ARTICLE includes systems where potassium is the first-named element in the binary pair. Additional binary systems that include potassium are provided in the following locations in this Volume:

- “As-K (Arsenic - Potassium)” in the article “As (Arsenic) Binary Alloy Phase Diagrams.”
- “Au-K (Gold - Potassium)” in the article “Au (Gold) Binary Alloy Phase Diagrams.”
- “Bi-K (Bismuth - Potassium)” in the article “Bi (Bismuth) Binary Alloy Phase Diagrams.”
- “Cs-K (Cesium - Potassium)” in the article “Cs (Cesium) Binary Alloy Phase Diagrams.”
- “Ge-K (Germanium - Potassium)” in the article “Ge (Germanium) Binary Alloy Phase Diagrams.”
- “Hg-K (Mercury - Potassium)” in the article “Hg (Mercury) Binary Alloy Phase Diagrams.”
- “In-K (Indium - Potassium)” in the article “In (Indium) Binary Alloy Phase Diagrams.”

K (Potassium) Binary Alloy Phase Diagrams

K-Na (Potassium - Sodium)

C.W. Bale, 1982

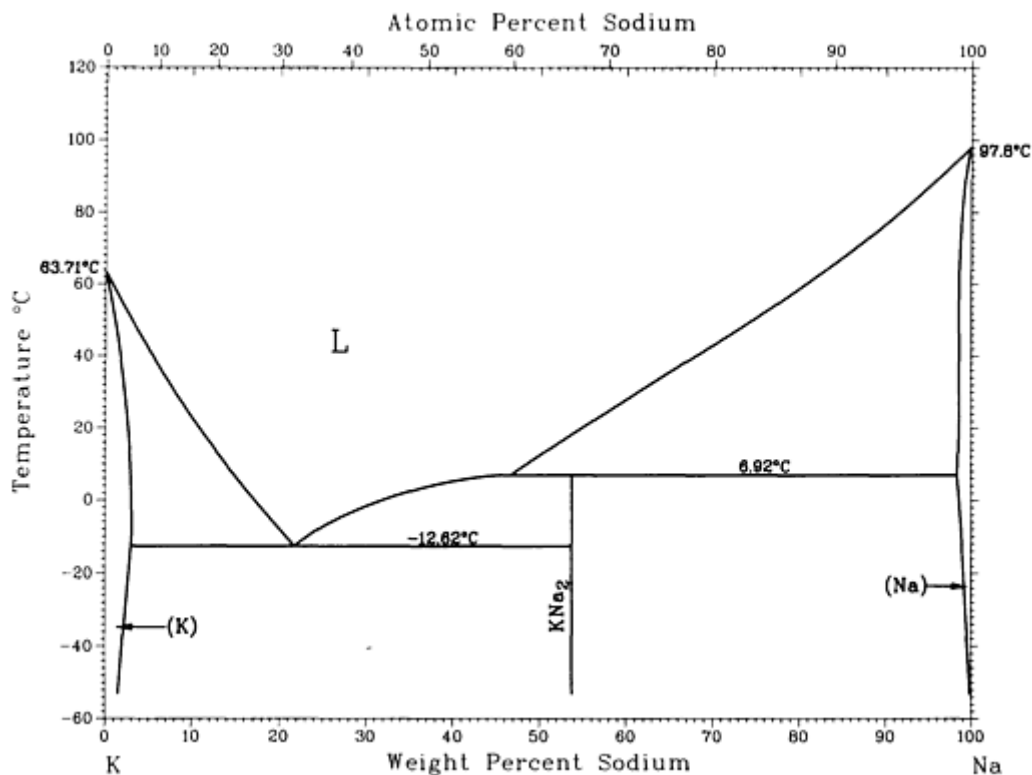

K-Na phase diagram

K-Na crystallographic data

Phase	Composition, wt% Na	Pearson symbol	Space group
(K)	0	<i>cI2</i>	<i>Im$\bar{3}m$</i>
K ₂ Na ^(a)	22.72
KNa ₂	54.05	<i>hP12</i>	<i>P6₃/mmc</i>
(Na)	100	<i>cI2</i>	<i>Im$\bar{3}m$</i>

(a) Possible phase (not shown in diagram)

K-Pb (Potassium - Lead)

H. Okamoto, 1990

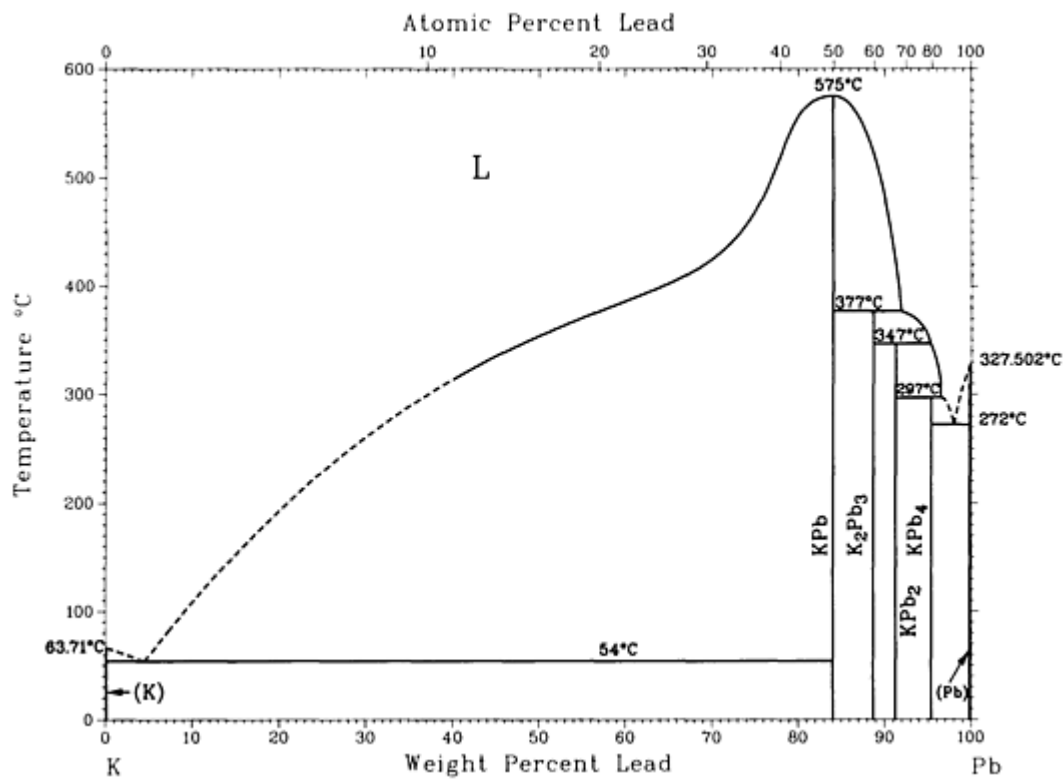

K-Pb phase diagram

K-Pb crystallographic data

Phase	Composition, wt% Pb	Pearson symbol	Space group
(K)	0	<i>hP2</i>	<i>P6₃/mmc</i>
KPb	84.1	<i>tI64</i>	<i>I4₁/acd</i>
K ₂ Pb ₃	89
KPb ₂	91.4	<i>hP12</i>	<i>P6₃/mmc</i>
KPb ₄	96	<i>cI*</i>	...
(Pb)	100	<i>cF4</i>	<i>Fm$\bar{3}$m</i>

K-Rb (Potassium - Rubidium)

C.W. Bale and A.D. Pelton, 1983

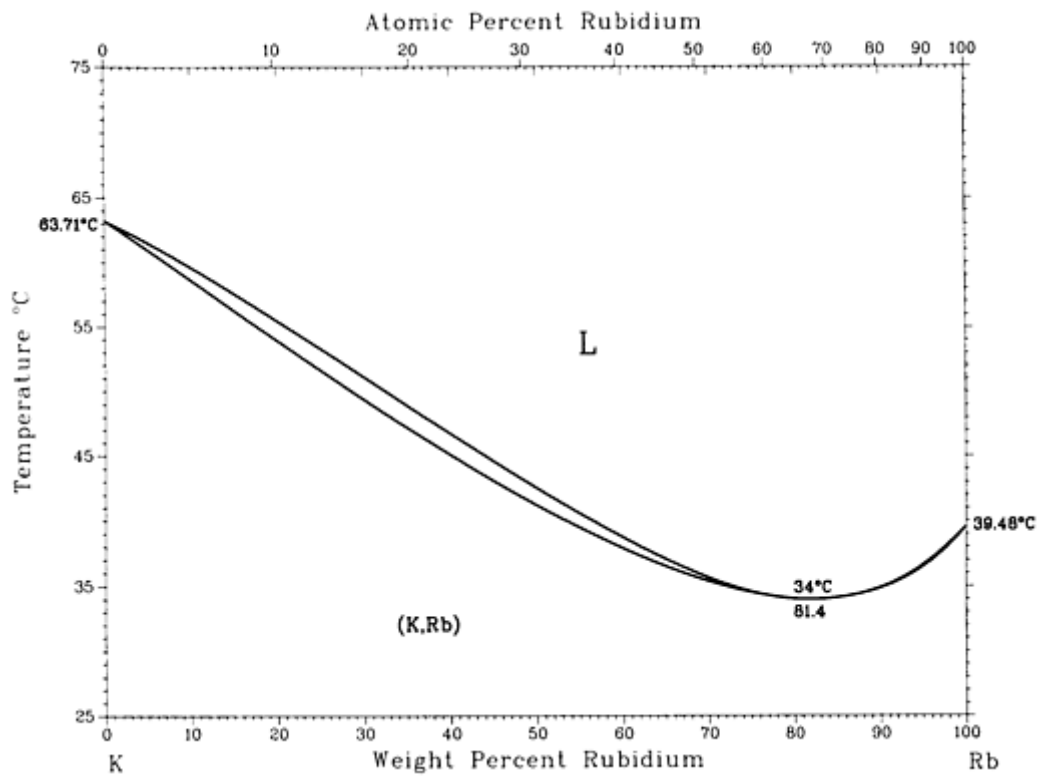

K-Rb phase diagram

K-Rb crystallographic data

Phase	Composition, wt% Rb	Pearson symbol	Space group
(K,Rb)	0 to 100	<i>cI2</i>	<i>Im</i> $\bar{3}m$

K-Sb (Potassium - Antimony)

F.W. Dorn and W. Klemm, 1961

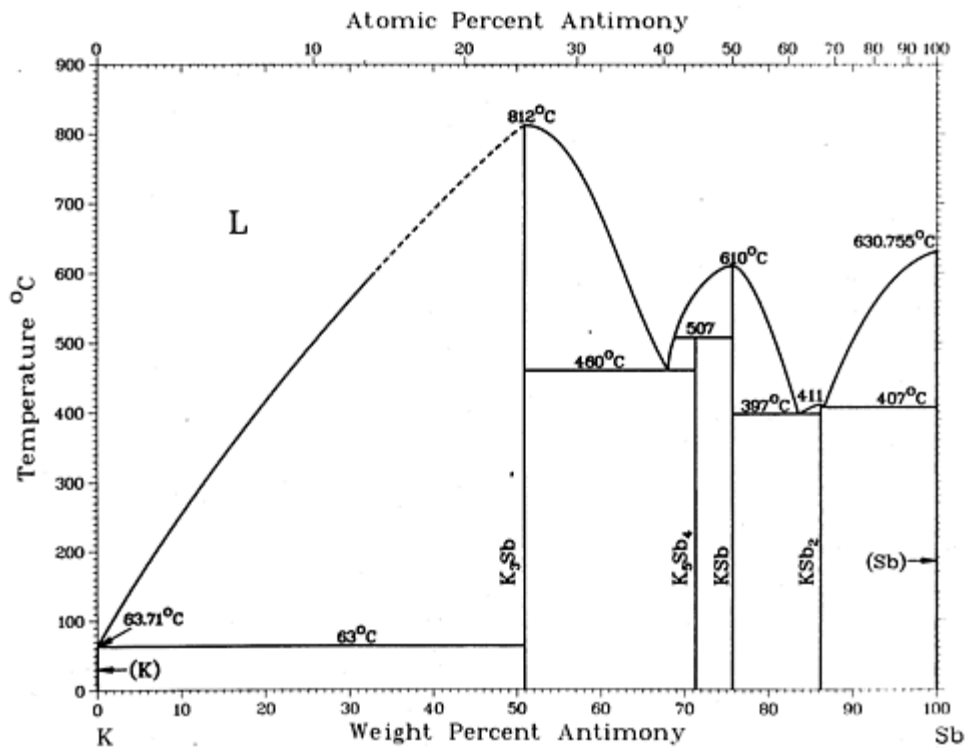

K-Sb phase diagram

K-Sb crystallographic data

Phase	Composition, wt% Sb	Pearson symbol	Space group
(K)	~0	<i>cI2</i>	<i>Im</i> $\bar{3}m$
K ₃ Sb	51	<i>hP8</i>	<i>P6</i> ₃ / <i>mmc</i>
K ₅ Sb ₄	71.3
KSb	75.7	<i>mP16</i>	<i>P2</i> ₁ / <i>c</i>
KSb ₂	86.2
(Sb)	~100	<i>hR2</i>	<i>R</i> $\bar{3}m$

K-Se (Potassium - Selenium)

H. Okamoto, 1990

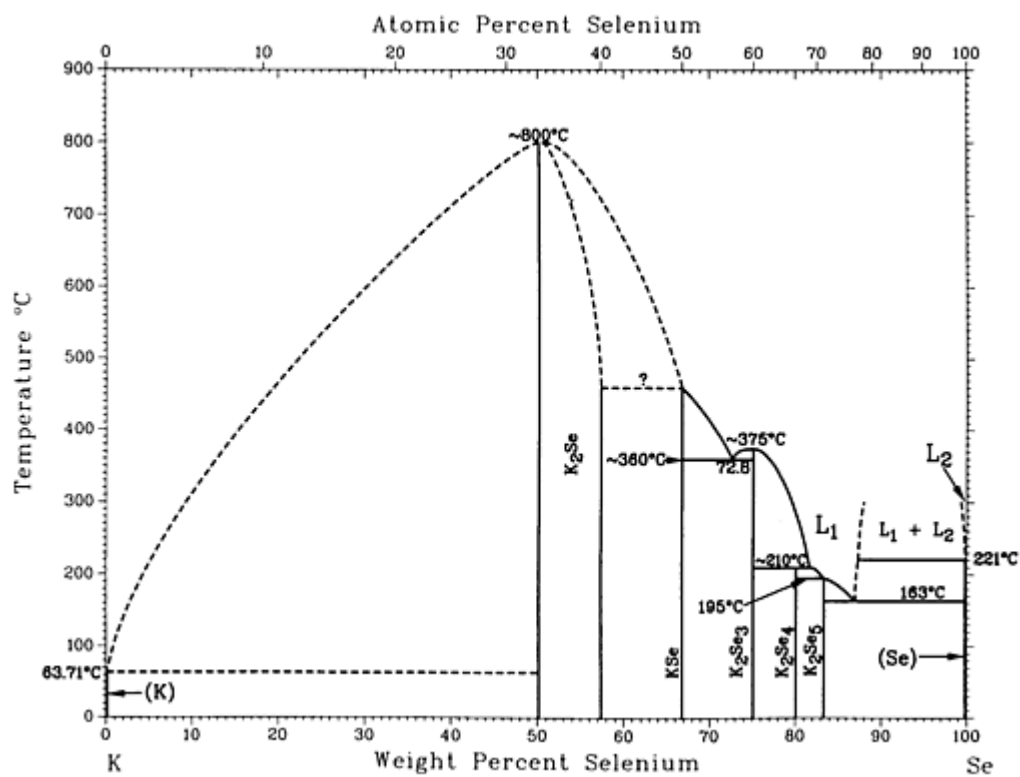

K-Se phase diagram

K-Se crystallographic data

Phase	Composition, wt% Se	Pearson symbol	Space group
(K)	0	<i>hP2</i>	<i>P6₃/mmc</i>
K ₂ Se	50.2 to 57	<i>cF12</i>	<i>Fm$\bar{3}$m</i>
KSe	66.9
K ₂ Se ₃	75	<i>oC20</i>	<i>Cmc2₁</i>
KSe ₂	80.2
K ₂ Se ₅	83.4

(Se)	100	hP3	P3 ₁ 21
------	-----	-----	--------------------

K-Sn (Potassium - Tin)

H. Okamoto, 1990

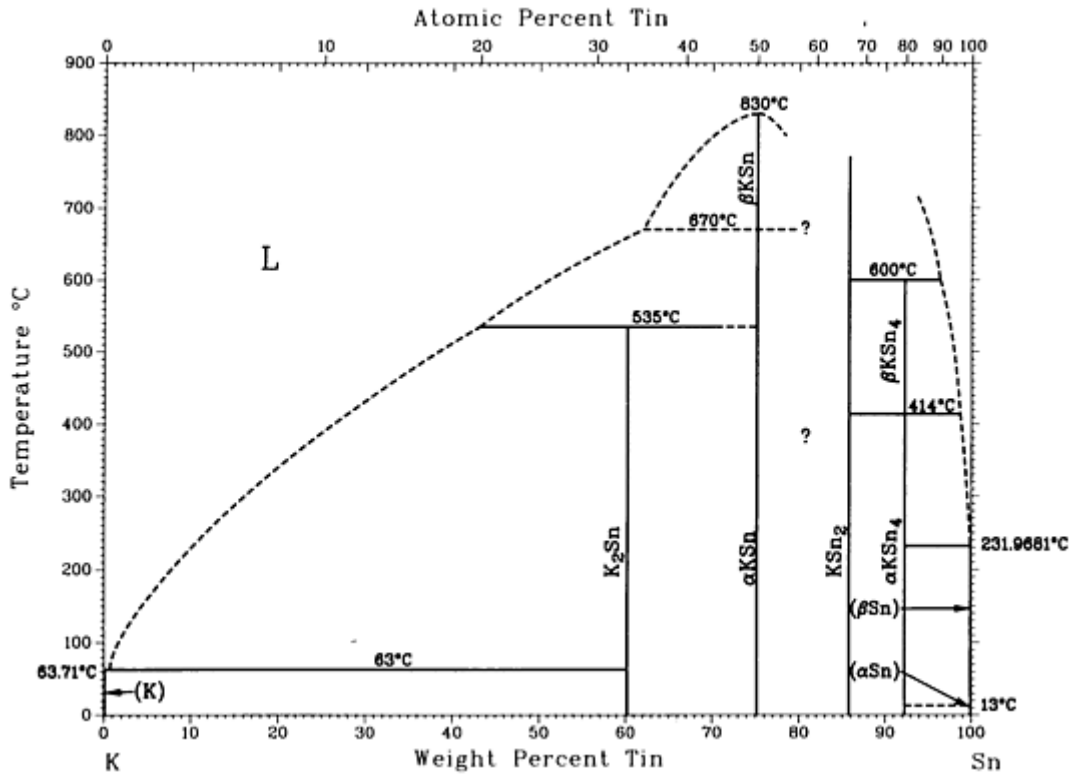

K-Sn phase diagram

K-Sn crystallographic data

Phase	Composition, wt% Sn	Pearson symbol	Space group
(K)	~0	<i>cI2</i>	<i>Im</i> $\bar{3}m$
K ₂ Sn	~60.3
β _{KSn}	75.2
α _{KSn}	75.2	<i>tI64</i>	<i>I4</i> ₁ <i>acd</i>
KSn ₂	85.9

β_{KSn_4}	92
α_{KSn_4}	92
(β_{Sn})	~ 100	$tI4$	$I4_1/amd$
(α_{Sn})	~ 100	$cF8$	$Fd\bar{3}m$
Other reported phase			
K_4Sn_{23}	~ 94.6	$cP54$	$Pm\bar{3}n$

K-Te (Potassium - Tellurium)

A. Petric and A.D. Pelton, 1990

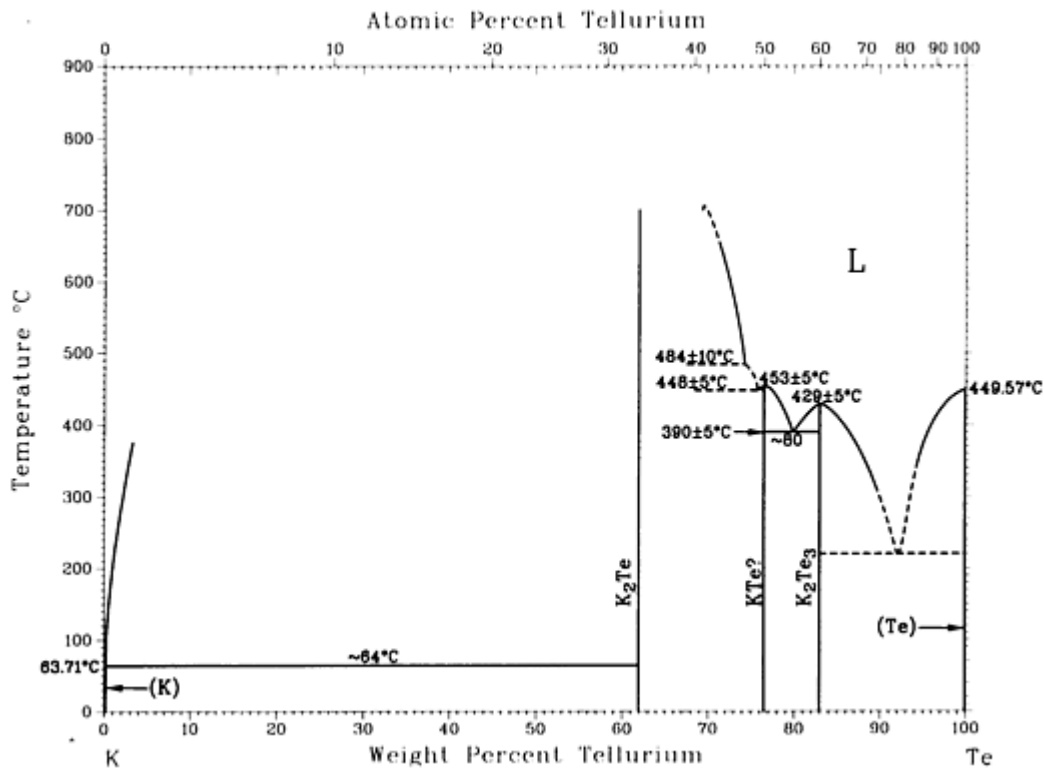

K-Te phase diagram

K-Te crystallographic data

Phase	Composition, wt% Te	Pearson symbol	Space group

(K)	0	<i>cI2</i>	<i>Im</i> $\bar{3}m$
K ₂ Te	62.0 to 72.3 ^(a)	<i>cF12</i>	<i>Fm</i> $\bar{3}m$
KTe	76.5
K ₂ Te ₃	83	<i>oP20</i>	<i>Pnma</i>
(Te)	100	<i>hP3</i>	<i>P3</i> ₁ <i>2</i> ₁

(a) Homogeneity range subject to verification

K-Tl (Potassium - Thallium)

H. Okamoto, 1990

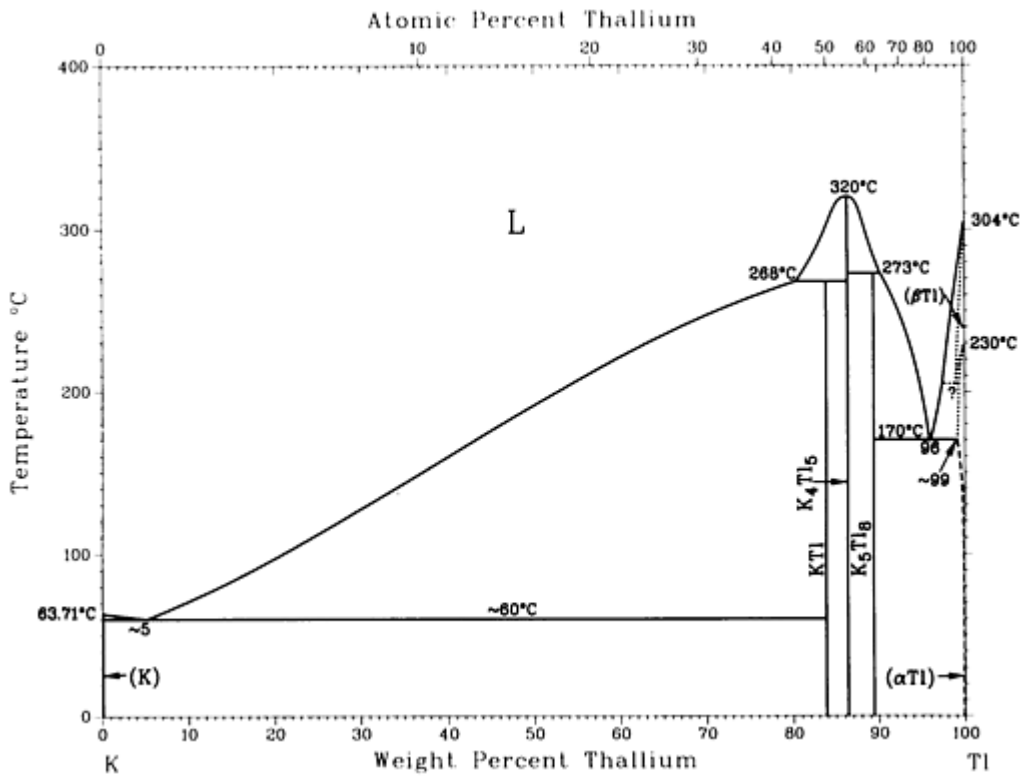

K-Tl phase diagram

K-Tl crystallographic data

Phase	Composition, wt% Tl	Pearson symbol	Space group
(K)	0	<i>cI2</i>	<i>Im</i> $\bar{3}m$
K ₂ Te	62.0 to 72.3 ^(a)	<i>cF12</i>	<i>Fm</i> $\bar{3}m$
KTe	76.5
K ₂ Te ₃	83	<i>oP20</i>	<i>Pnma</i>
(Te)	100	<i>hP3</i>	<i>P3</i> ₁ <i>2</i> ₁

(K)	0	<i>cI2</i>	<i>Im$\bar{3}m$</i>
KTl	83.9	^(a)	...
K ₄ Tl ₅	86.7
K ₅ Tl ₈	89.3
(β Tl)	? to 100	<i>cI2</i>	<i>Im$\bar{3}m$</i>
(α Tl)	~99.8 to 100	<i>hP2</i>	<i>P6₃/mmc</i>

(a) Crystal structure neither the β brass or NaCl type

La (Lanthanum) Binary Alloy Phase Diagrams

Introduction

THIS ARTICLE includes systems where lanthanum is the first-named element in the binary pair. Additional binary systems that include lanthanum are provided in the following locations in this Volume:

- “Ag-La (Silver - Lanthanum)” in the article “Ag (Silver) Binary Phase Diagrams.”
- “Al-La (Aluminum - Lanthanum)” in the article “Al (Aluminum) Binary Phase Diagrams.”
- “Au-La (Gold - Lanthanum)” in the article “Au (Gold) Binary Phase Diagrams.”
- “Bi-La (Bismuth - Lanthanum)” in the article “Bi (Bismuth) Binary Phase Diagrams.”
- “C-La (Carbon - Lanthanum)” in the article “C (Carbon) Binary Phase Diagrams.”
- “Cd-La (Cadmium - Lanthanum)” in the article “Cd (Cadmium) Binary Phase Diagrams.”
- “Cu-La (Copper - Lanthanum)” in the article “Cu (Copper) Binary Phase Diagrams.”
- “Fe-La (Iron - Lanthanum)” in the article “Fe (Iron) Binary Phase Diagrams.”
- “Ga-La (Gallium - Lanthanum)” in the article “Ga (Gallium) Binary Phase Diagrams.”
- “Ge-La (Germanium - Lanthanum)” in the article “Ge (Germanium) Binary Phase Diagrams.”
- “H-La (Hydrogen - Lanthanum)” in the article “H (Hydrogen) Binary Phase Diagrams.”
- “Hg-La (Mercury - Lanthanum)” in the article “Hg (Mercury) Binary Phase Diagrams.”
- “In-La (Indium - Lanthanum)” in the article “In (Indium) Binary Phase Diagrams.”
- “Ir-La (Iridium - Lanthanum)” in the article “Ir (Iridium) Binary Phase Diagrams.”

La-Mg (Lanthanum - Magnesium)

A.A. Nayeb-Hashemi and J.B. Clark, 1988

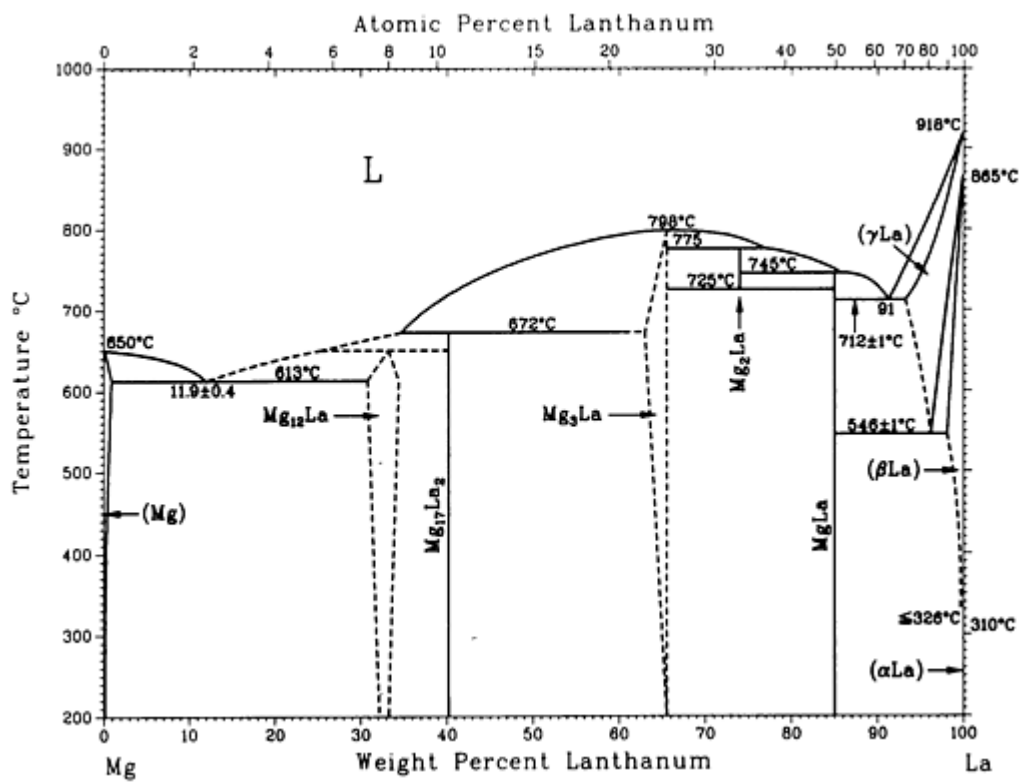

La-Mg phase diagram

La-Mg crystallographic data

Phase	Composition, wt% La	Pearson symbol	Space group
(Mg)	0 to 0.79	<i>hP2</i>	<i>P6₃/mmc</i>
$Mg_{12}La$	30.53 to 34.18 ^(a)	<i>oI338^(b)</i>	<i>(Immm)^(b)</i>
$Mg_{17}La_2$	40.21	<i>hP38</i>	<i>P6₃/mmc</i>
Mg_3La	? to 66	<i>cF16</i>	<i>Fm$\bar{3}m$</i>
Mg_2La	74.07	<i>cF24</i>	<i>Fd$\bar{3}m$</i>

MgLa	85.1	<i>cP2</i>	<i>Pm</i> $\bar{3}m$
(γ La)	~93 to 100	<i>cI2</i>	<i>Im</i> $\bar{3}m$
(β La)	~98.2 to 100	<i>cF4</i>	<i>Fm</i> $\bar{3}m$
(α La)	? to 100	<i>hP4</i>	<i>P6</i> $_3/mmc$

(a) Homogeneity range estimated from lattice parameters.

(b) This proposed crystal structure is based on the similarities of the lattice parameters of Mg₁₂La with those of Mg₁₂Ce(II).

La-Mn (Lanthanum - Manganese)

A. Palenzona and S. Cirafici, 1990

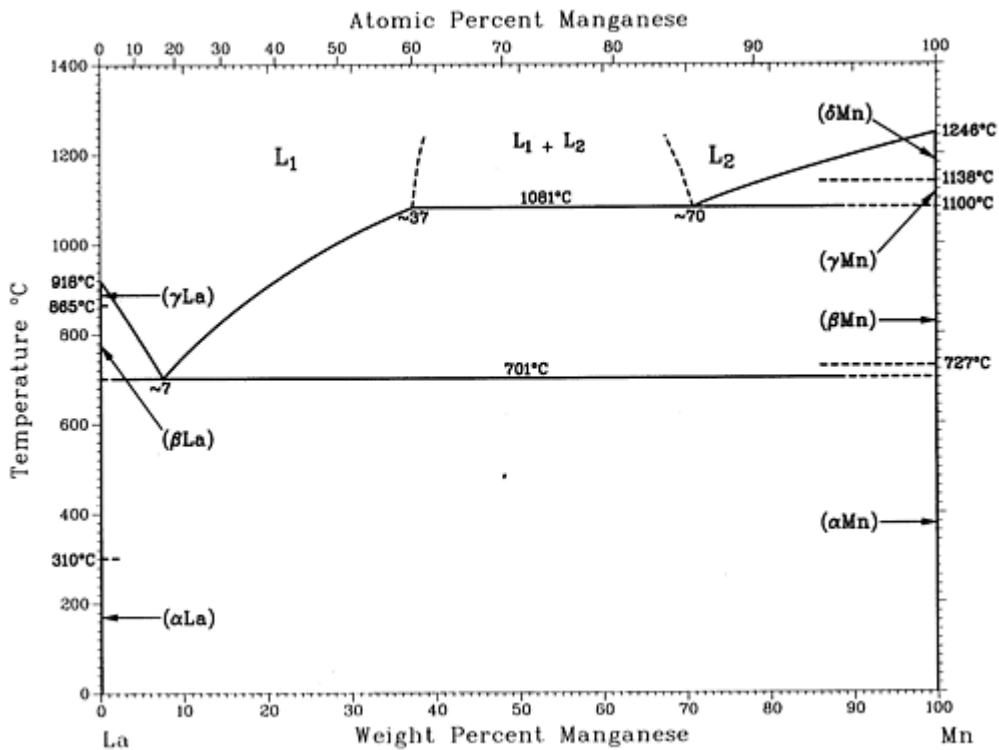

La-Mn phase diagram

La-Mn crystallographic data

Phase	Composition, wt% Mn	Pearson symbol	Space group
(αLa)	?	<i>hP4</i>	<i>P6</i> $_3/mmc$
(βLa)	~98.2 to 100	<i>cF4</i>	<i>Fm</i> $\bar{3}m$
(γLa)	~93 to 100	<i>cI2</i>	<i>Im</i> $\bar{3}m$
MgLa	85.1	<i>cP2</i>	<i>Pm</i> $\bar{3}m$

(γ_{La})	0	$cI2$	$Im\bar{3}m$
(β_{La})	0	$cF4$	$Fm\bar{3}m$
(α_{La})	0	$hP4$	$P6_3/mmc$
(δ_{Mn})	~ 100	$cI2$	$Im\bar{3}m$
(γ_{Mn})	~ 100	$cI4$	$Im\bar{3}m$
(β_{Mn})	~ 100	$cP20$	$P4_132$
(α_{Mn})	~ 100	$cI58$	$I\bar{4}3m$

La-Ni (Lanthanum - Nickel)

H. Okamoto, 1991

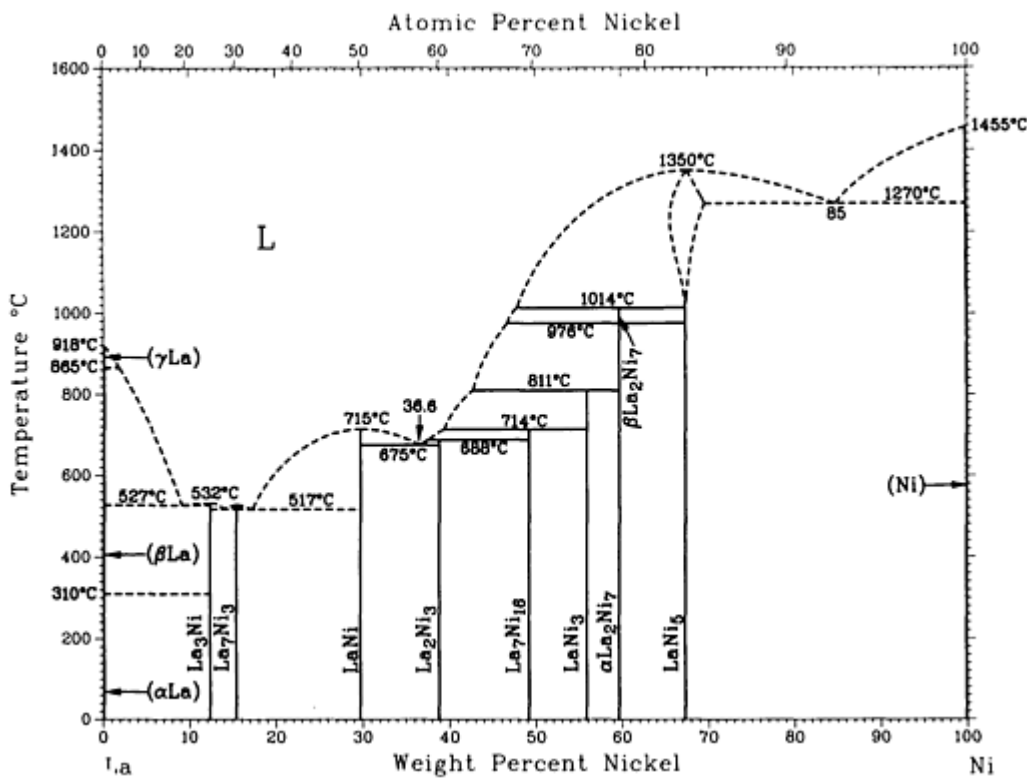

La-Ni phase diagram

La-Ni crystallographic data

Phase	Composition, wt% Ni	Pearson symbol	Space group
(γ La)	0	<i>cI2</i>	<i>Im$\bar{3}m$</i>
(β La)	0	<i>cF4</i>	<i>Fm$\bar{3}m$</i>
(α La)	0	<i>hP4</i>	<i>P6$_3$/mmc</i>
La ₃ Ni	12.3	<i>oP16</i>	<i>Pnma</i>
La ₇ Ni ₃	15.3	<i>hP20</i>	<i>P6$_3$/mc</i>
LaNi	29.7	<i>oC8</i>	<i>Cmcm</i>
La ₂ Ni ₃	39.0	<i>oC20</i>	<i>Cmca</i>
La ₇ Ni ₁₆	49.2	<i>tI46</i>	<i>I$\bar{4}2m$</i>
LaNi ₃	55.9	<i>hR24</i>	<i>R$\bar{3}m$</i>
β La ₂ Ni ₇	59.7	<i>hR18</i>	<i>R$\bar{3}m$</i>
α La ₂ Ni ₇	59.7	<i>hP36</i>	<i>P6$_3$/mmc</i>
LaNi ₅	67.8	<i>hP6</i>	<i>P6/mmm</i>
(Ni)	100	<i>cF4</i>	<i>Fm$\bar{3}m$</i>
Metastable phase			
LaNi ₂	66.7	<i>cF24</i>	<i>Fd$\bar{3}m$</i>

La-Pb (Lanthanum - Lead)

A. Palenzona and S. Cirafici, 1992

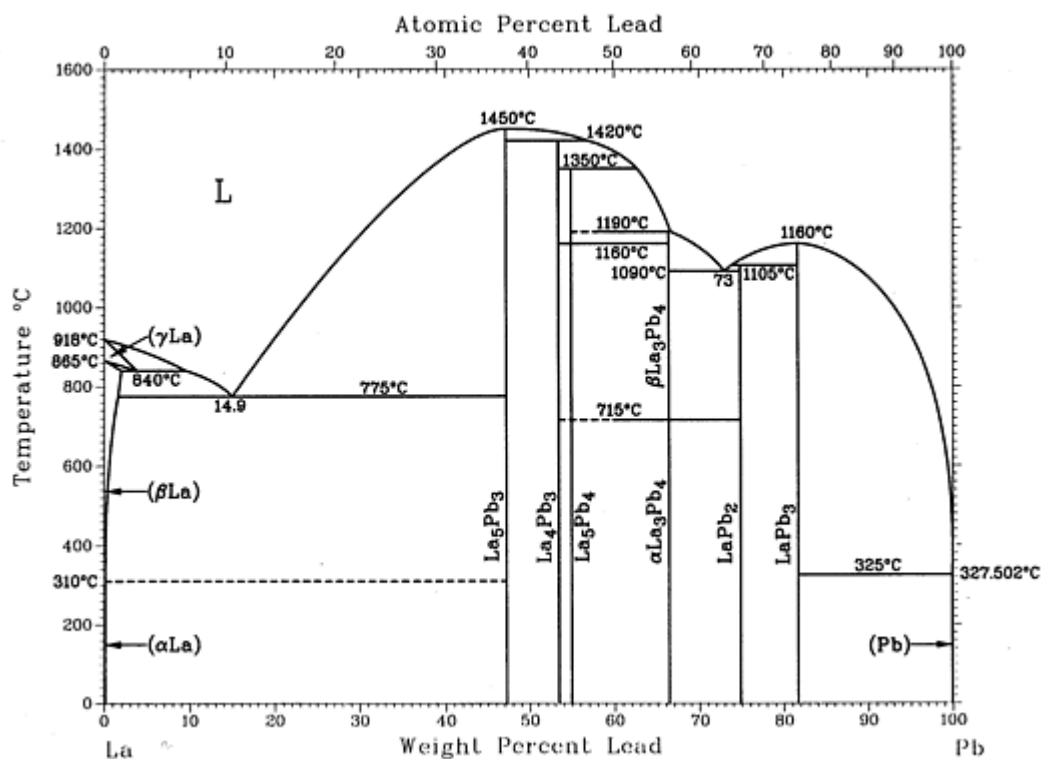

La-Pb phase diagram

La-Pb crystallographic data

Phase	Composition, wt% Pb	Pearson symbol	Space group
(γLa)	3.7	cI2	$Im\bar{3}m$
(βLa)	0 to <1.5	cF4	$Fm\bar{3}m$
(αLa)	0	hP4	$P6_3/mmc$
La ₅ Pb ₃	47.2	hP16	$P6_3/mcm$

$\text{La}_4\text{Pb}_3^{(a)}$	52.8	$cI28$	$I\bar{4}3d$
La_5Pb_4	54.4	$oP36$	$Pnma$
$\beta\text{La}_3\text{Pb}_4$	66.5
$\alpha\text{La}_3\text{Pb}_4$	66.5
LaPb_2	74.9
LaPb_3	81.7	$cP4$	$Pm\bar{3}m$
(Pb)	~99.9 to 100	$cF4$	$Fm\bar{3}m$

(a) Low temperature modification

La-S (Lanthanum - Sulfur)

H.F. Franzen, unpublished

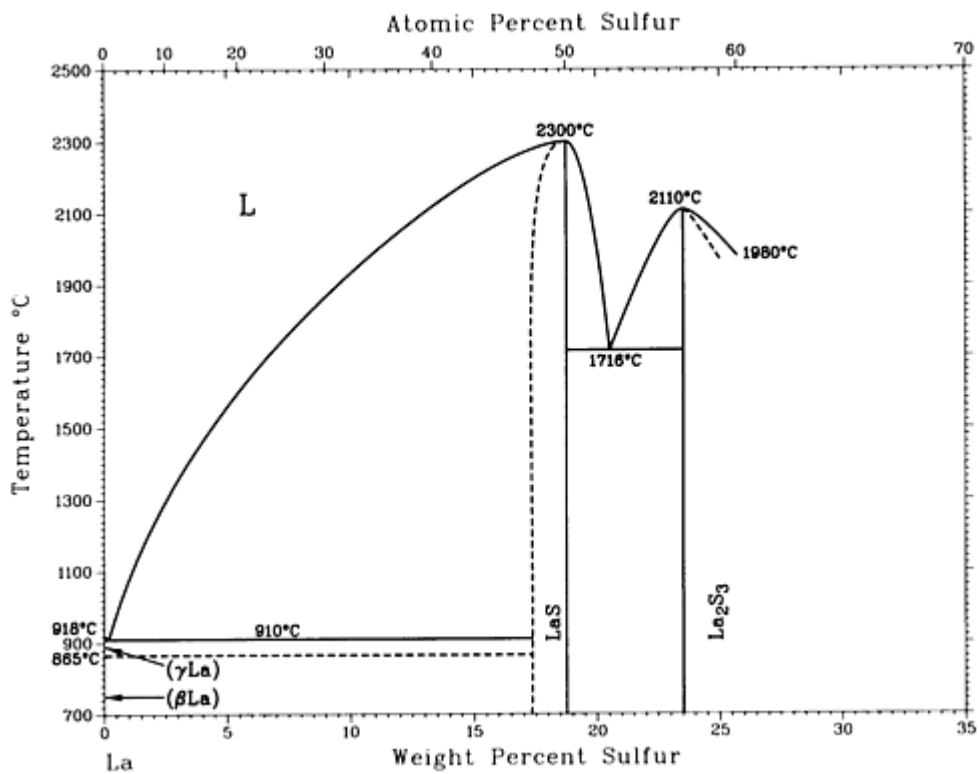

La-S phase diagram

La-S crystallographic data

Phase	Composition, wt% S	Pearson symbol	Space group
(γ La)	0	<i>cI2</i>	<i>Im</i> $\bar{3}m$
(β La)	0	<i>cF4</i>	<i>Fm</i> $\bar{3}m$
LaS	17 to 18.8	<i>cF8</i>	<i>Fm</i> $\bar{3}m$
γ La ₂ S ₃	23.5 to 26	<i>cI28</i>	<i>I</i> $\bar{4}3d$

La-Sb (Lanthanum - Antimony)

R. Vogel and H. Klose, 1954

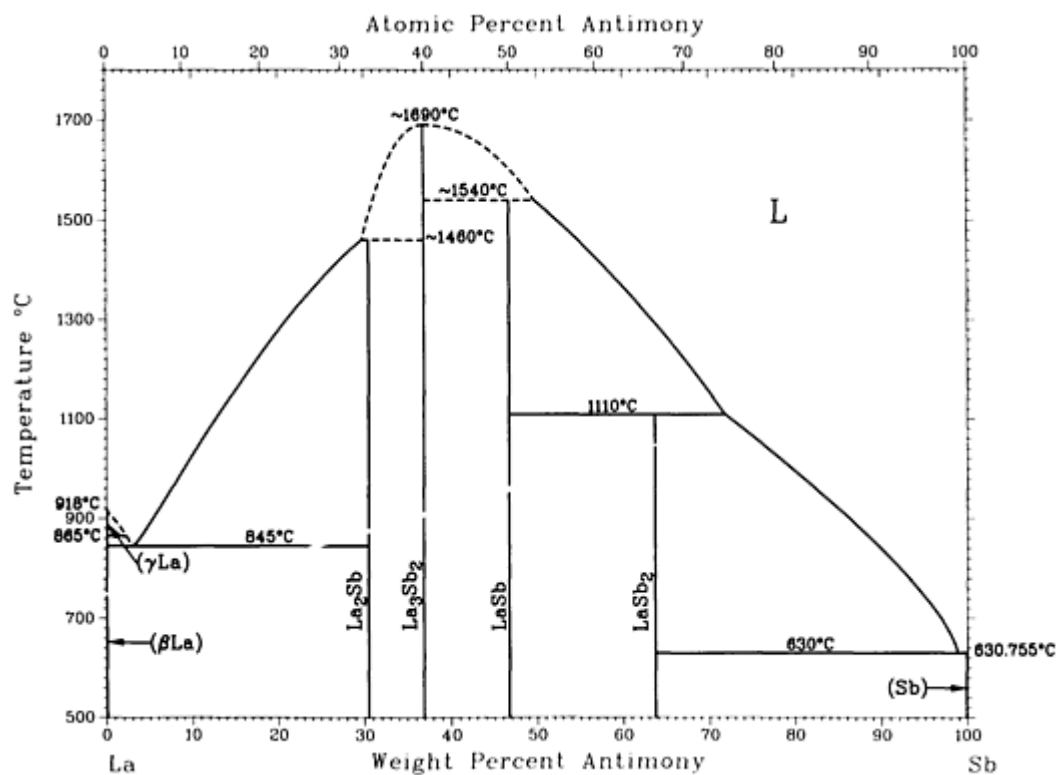

La-Sb phase diagram

La-Sb crystallographic data

Phase	Composition, wt% Sb	Pearson symbol	Space group
-------	---------------------	----------------	-------------

(γ_{La})	~ 0	$cI2$	$I\bar{m}\bar{3}m$
(β_{La})	~ 0	$cF4$	$Fm\bar{3}m$
La_2Sb	30.4	$tI12$	$I4/mmm$
La_3Sb_2	37
LaSb	46.7	$cF8$	$Fm\bar{3}m$
LaSb_2	63.7	$oC24$	$Cmca$
(Sb)	~ 100	$hR2$	$R\bar{3}m$
Other reported phases			
La_5Sb_3	34.9	$hP16$	$P6_3/mcm$
La_4Sb_3	39.7	$cI28$	$I\bar{4}3d$

La-Sc (Lanthanum - Scandium)

K.A. Gschneidner, Jr. and F.W. Calderwood, 1982

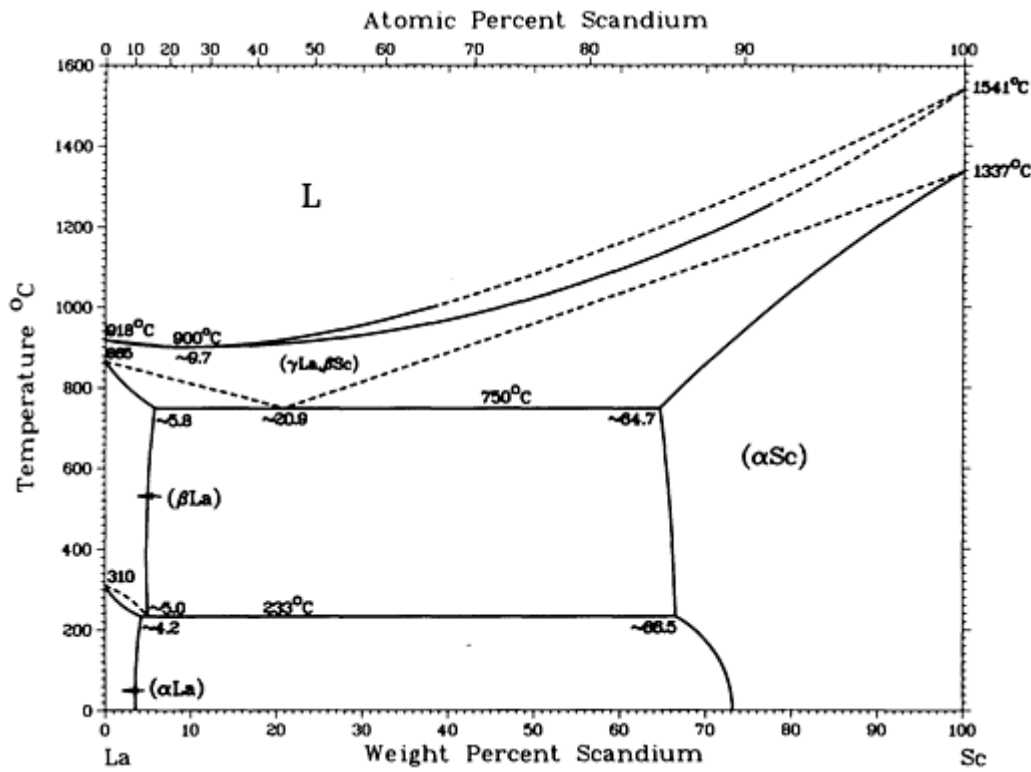

La-Sc phase diagram

La-Sc crystallographic data

Phase	Composition, wt% Sc	Pearson symbol	Space group
(αLa)	0 to ~4.2	<i>hP4</i>	<i>P6₃/mmc</i>
(βLa)	0 to ~5.8	<i>cF4</i>	<i>Fm$\bar{3}m$</i>
(γLa, βSc)	0 to 100	<i>cI2</i>	<i>Im$\bar{3}m$</i>
(αSc)	~64.7 to 100	<i>hP2</i>	<i>P6₃/mmc</i>

La-Se (Lanthanum - Selenium)

H. Okamoto, 1990

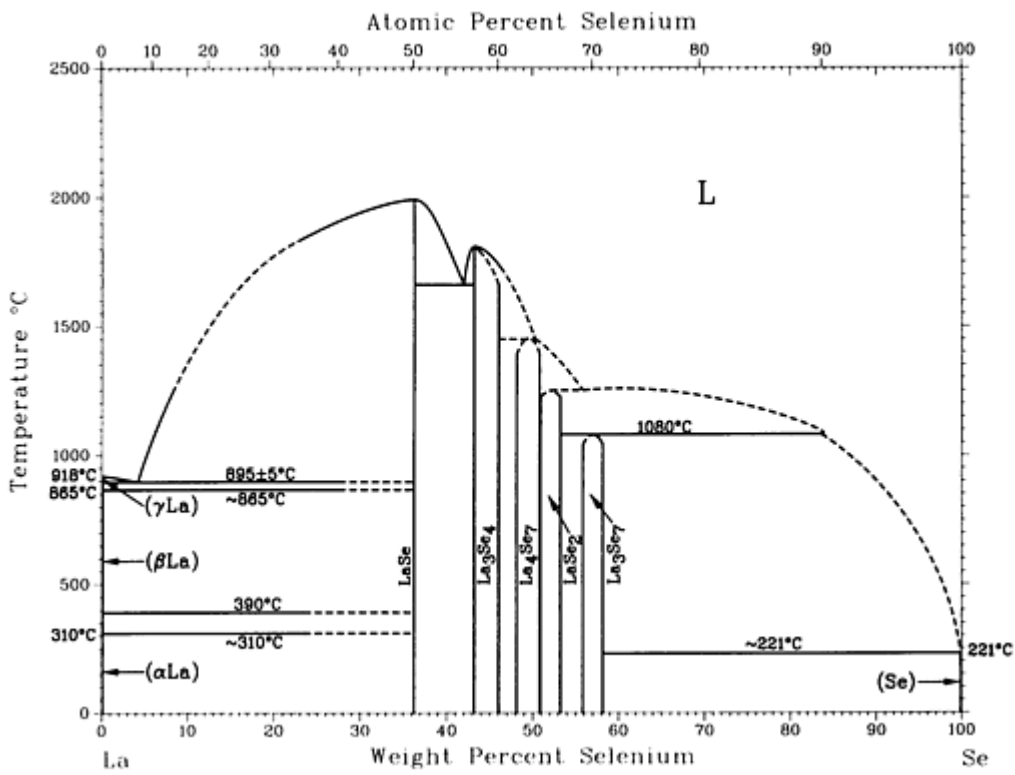

La-Se phase diagram

La-Se crystallographic data

Phase	Composition, wt% Se	Pearson symbol	Space group
(γ La)	0	<i>cI2</i>	<i>Im</i> $\bar{3}m$
(β La)	0	<i>cF4</i>	<i>Fm</i> $\bar{3}m$
(α La)	0	<i>hP4</i>	<i>P6</i> ₃ <i>/mmc</i>
LaSe	36.2	<i>cF8</i>	<i>Fm</i> $\bar{3}m$
La ₃ Se ₄	43.2 to 46	<i>cI28</i>	<i>I</i> $\bar{4}3d$
La ₄ Se ₇	48 to 50.8	<i>mP6</i>	<i>P2/c</i>
LaSe ₂	50.9 to 53.2	<i>tP6</i>	<i>P4/nmm</i>
La ₃ Se ₇	56 to 58	<i>t**</i>	...

(Se)	100	hP3	P3 ₁ 21
------	-----	-----	--------------------

La-Sn (Lanthanum - Tin)

A. Palenzona and S. Cirafici, 1992

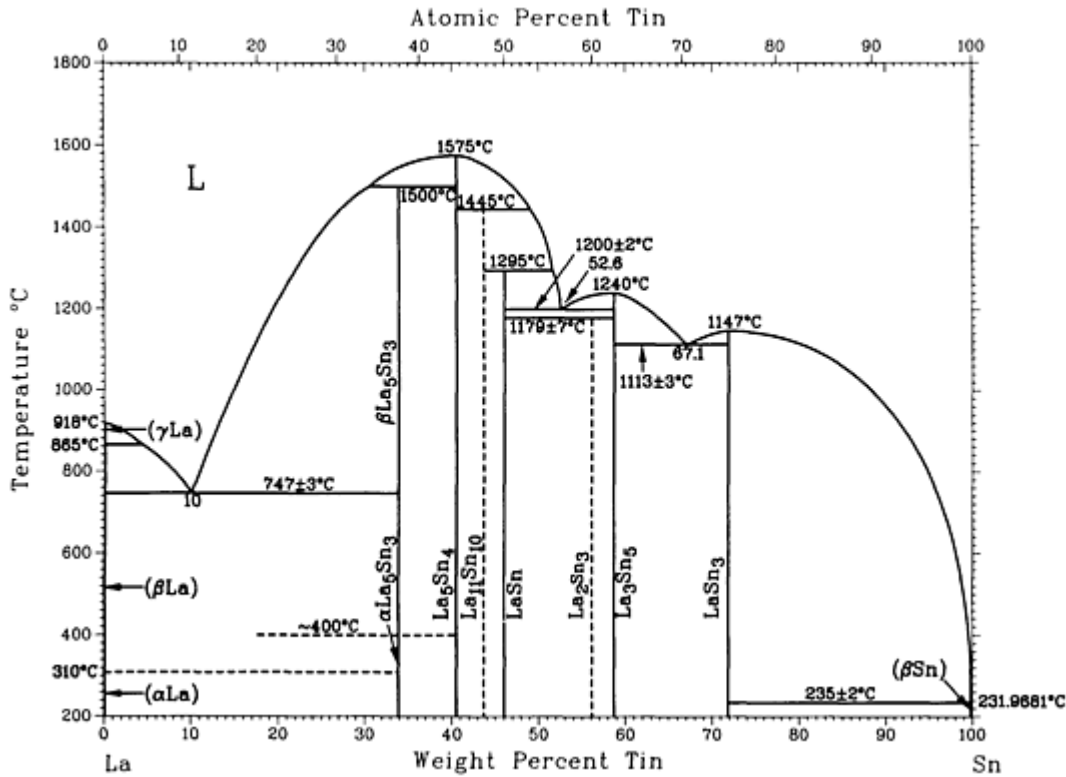

La-Sn phase diagram

La-Sn crystallographic data

Phase	Composition, wt% Sn	Pearson symbol	Space group
$\gamma_{\text{La}}^{(a)}$	0	<i>cI2</i>	<i>Im</i> $\bar{3}m$
$\beta_{\text{La}}^{(b)}$	0	<i>cF4</i>	<i>Fm</i> $\bar{3}m$
$\alpha_{\text{La}}^{(c)}$	0	<i>hP4</i>	<i>P6</i> ₃ <i>/mmc</i>
$\text{La}_3\text{Sn}^{(d)}$	22	<i>cP4</i>	<i>Pm</i> $\bar{3}m$
$\beta_{\text{La}_5\text{Sn}_3}$	33.9	<i>hP16</i>	<i>P6</i> ₃ <i>/mcm</i>

α La ₅ Sn ₃	33.9	<i>tI32</i>	<i>I4/mcm</i>
La ₅ Sn ₄	40.6	<i>oP36</i>	<i>Pnma</i>
La ₁₁ Sn ₁₀ ^(e)	43.7	<i>tI84</i>	<i>I4/mmm</i>
LaSn	46.1	<i>oC8</i>	<i>Cmcm</i>
La ₂ Sn ₃	56
La ₃ Sn ₅	58.8	<i>oC32</i>	<i>Cmcm</i>
LaSn ₃	72	<i>cP4</i>	<i>Pm$\bar{3}m$</i>
β Sn ^(f)	100	<i>tI4</i>	<i>I4₁/amd</i>
α Sn ^(g)	100	<i>cF8</i>	<i>Fd$\bar{3}m$</i>

(a) From 918 to 865 °C.

(b) From 865 to 310 °C.

(c) Up to 310 °C.

(d) High-temperature, high-pressure phase

(e) Proposed structure type.

(f) From 13 to 231.9681 °C.

(g) Up to 13 °C

La-Tl (Lanthanum - Thallium)

S. Delfino, A. Saccone, A. Palenzona, and R. Ferro, unpublished

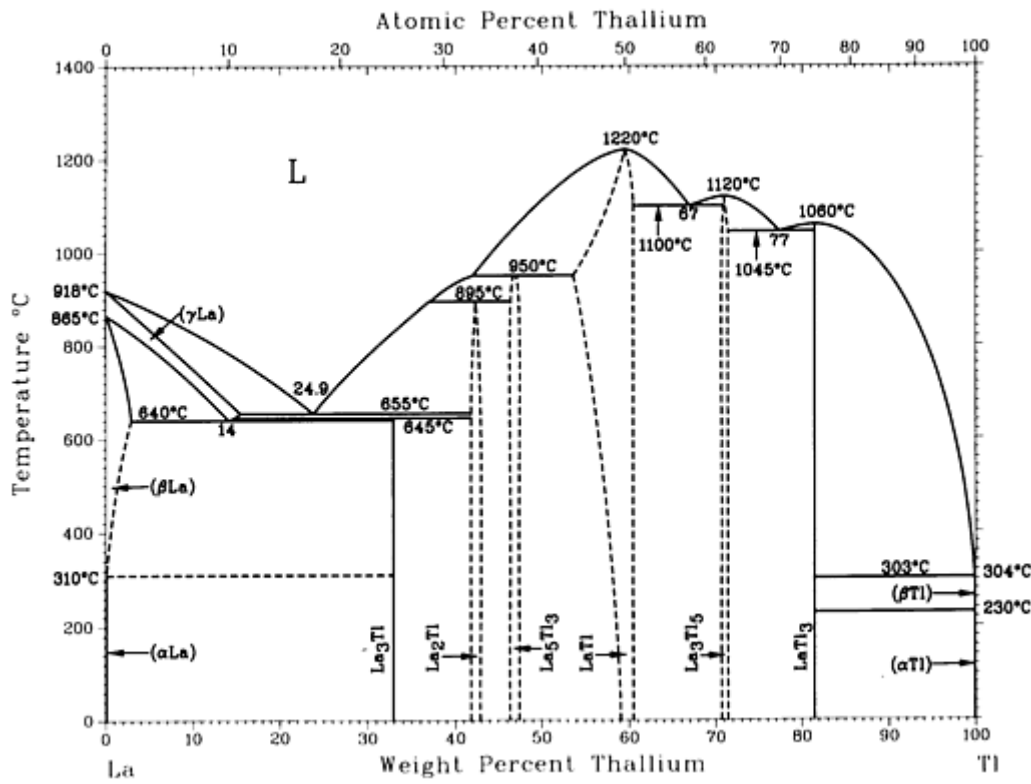

La-Tl phase diagram

La-Tl crystallographic data

Phase	Composition, wt% Tl	Pearson symbol	Space group
γ La	15.4	<i>cI2</i>	<i>Im</i> $\bar{3}m$
β La	0 to 2.8	<i>cF4</i>	<i>Fm</i> $\bar{3}m$
α La	0	<i>hP4</i>	<i>P6</i> $\bar{3}m$ <i>mmc</i>
La ₃ Tl ^(a)	33 ~33	<i>cP4</i> <i>cF4</i>	<i>Pm</i> $\bar{3}m$ <i>Fm</i> $\bar{3}m$
La ₂ Tl	~46.9
La ₅ Tl ₃	~46 to 47	<i>tI32</i>	<i>I4/mcm</i>
LaTl ^(b)	~54 to ~61	<i>cP2</i> <i>cI2</i>	<i>Pm</i> $\bar{3}m$ <i>Im</i> $\bar{3}m$

LaTl ^(c)	~54 to ~61	<i>tP2</i>	<i>P4/mmm</i>
La ₃ Tl ₅	~71 to ~72	<i>oC32</i>	<i>Cmcm</i>
LaTl ₃	82	<i>cP4</i>	<i>Pm$\bar{3}m$</i>
(β Tl)	100	<i>cI2</i>	<i>Im$\bar{3}m$</i>
(α Tl)	100	<i>hP2</i>	<i>P6₃/mmc</i>

- (a) A *cP4-cF4* order-disorder transformation in this phase has been suggested.
- (b) Cubic structure presumed to be room- and higher-temperature phases.
- (c) Tetragonal structure presumed to be lower-temperature phase

La-Zn (Lanthanum - Zinc)

L. Rolla and A. Iandelli, 1941

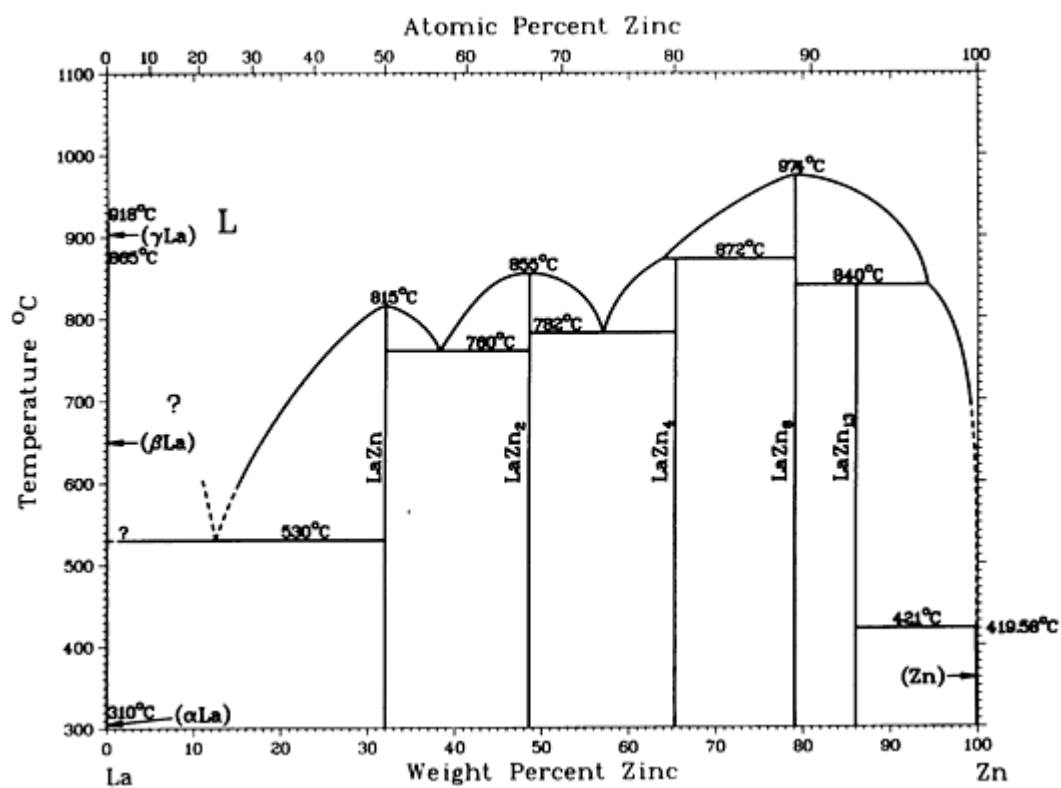

La-Zn phase diagram

La-Zn crystallographic data

Phase	Composition, wt% Zn	Pearson symbol	Space group
(γ La)	~0	<i>cI2</i>	<i>Im</i> $\bar{3}m$
(β La)	~0	<i>cF4</i>	<i>Fm</i> $\bar{3}m$
(α La)	~0	<i>hP4</i>	<i>P6</i> ₃ <i>mmc</i>
LaZn	32.0	<i>cP2</i>	<i>Pm</i> $\bar{3}m$
LaZn ₂	~48.5	<i>oI12</i>	<i>Imma</i>
LaZn ₄	~65	<i>oC20</i>	<i>Cmcm</i>
LaZn ₈ (La ₂ Zn ₁₇)	~79	<i>hR19</i>	<i>R</i> $\bar{3}m$
LaZn ₁₃	~86.0	<i>cF112</i>	<i>Fm</i> $\bar{3}c$

(Zn)	~100	<i>hP2</i>	<i>P6₃/mmc</i>
Other reported phases			
LaZn ₅	~70.1	<i>hP6</i>	<i>P6/mmm</i>
La ₃ Zn ₂₂	~78	<i>tI100</i>	<i>I4₁/amd</i>
LaZn ₁₁	~83.9	<i>tI48</i>	<i>I4₁/amd</i>

Li (Lithium) Binary Alloy Phase Diagrams

Introduction

THIS ARTICLE includes systems where lithium is the first-named element in the binary pair. Additional binary systems that include lithium are provided in the following locations in this Volume:

- “Ag-Li (Silver - Lithium)” in the article “Ag (Silver) Binary Alloy Phase Diagrams.”
- “Al-Li (Aluminum - Lithium)” in the article “Al (Aluminum) Binary Alloy Phase Diagrams.”
- “Au-Li (Gold - Lithium)” in the article “Au (Gold) Binary Alloy Phase Diagrams.”
- “Ba-Li (Barium - Lithium)” in the article “Ba (Barium) Binary Alloy Phase Diagrams.”
- “Bi-Li (Bismuth - Lithium)” in the article “Bi (Bismuth) Binary Alloy Phase Diagrams.”
- “Ca-Li (Calcium - Lithium)” in the article “Ca (Calcium) Binary Alloy Phase Diagrams.”
- “Cd-Li (Cadmium - Lithium)” in the article “Cd (Cadmium) Binary Alloy Phase Diagrams.”
- “Cu-Li (Copper - Lithium)” in the article “Cu (Copper) Binary Alloy Phase Diagrams.”
- “Ga-Li (Gallium - Lithium)” in the article “Ga (Gallium) Binary Alloy Phase Diagrams.”
- “Ge-Li (Germanium - Lithium)” in the article “Ge (Germanium) Binary Alloy Phase Diagrams.”
- “Hg-Li (Mercury - Lithium)” in the article “Hg (Mercury) Binary Alloy Phase Diagrams.”
- “In-Li (Indium - Lithium)” in the article “In (Indium) Binary Alloy Phase Diagrams.”

Li-Mg (Lithium - Magnesium)

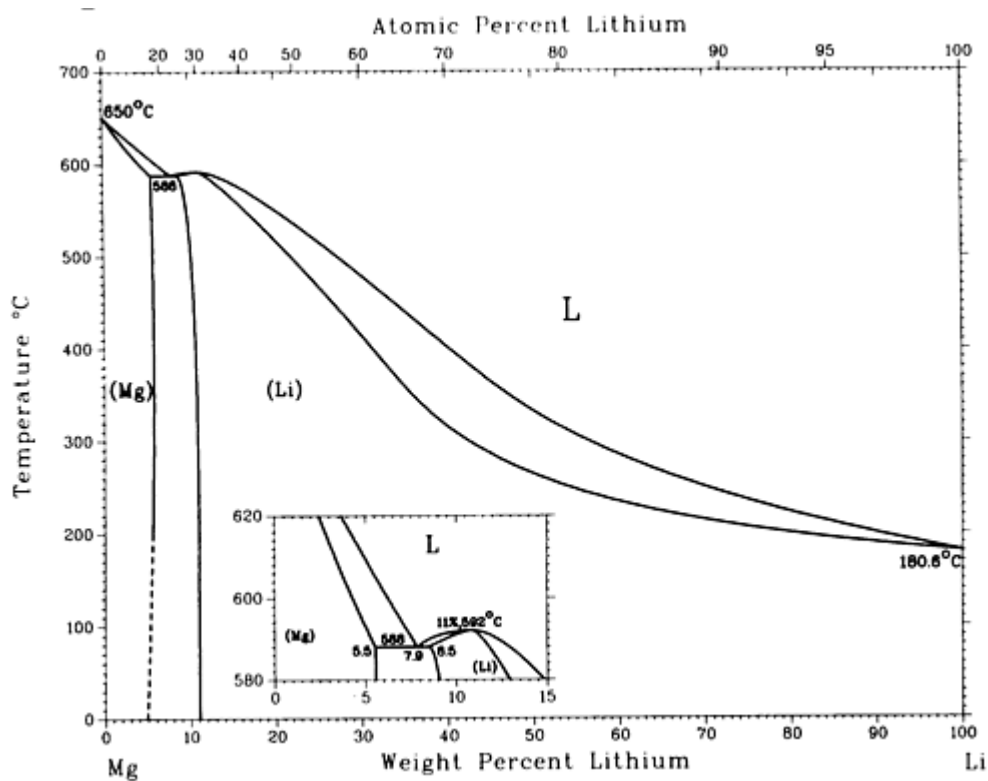

Li-Mg phase diagram

Li-Mg crystallographic data

Phase	Composition, wt% Li	Pearson symbol	Space group
(Mg)	0 to 6	<i>hP2</i>	<i>P6₃/mmc</i>
(β_{Li})	8.5 to 100	<i>cI2</i>	<i>Im$\bar{3}m$</i>
(α_{Li}) ^(a)	100	<i>hP2</i>	<i>P6₃/mmc</i>
Cold worked stabilized phase ^(b)			
(γ_{Li})	100	<i>cF4</i>	<i>Fm$\bar{3}m$</i>

(a) Below -193 °C.

(b) Nonequilibrium

Li-Na (Lithium - Sodium)

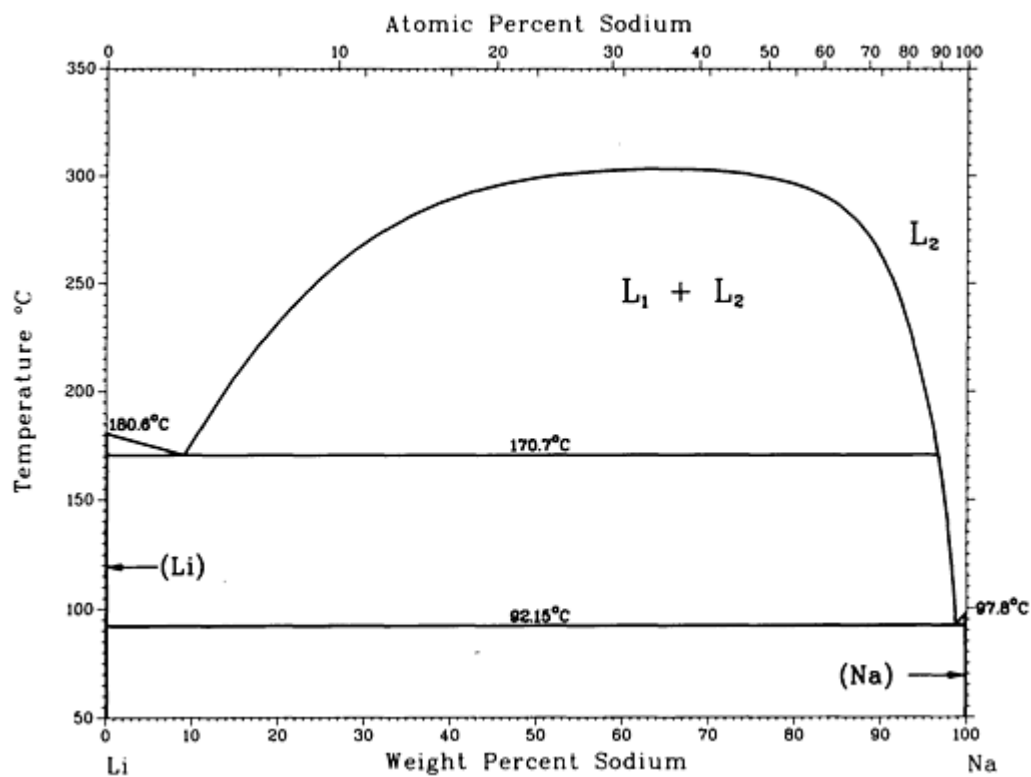

Li-Na phase diagram

Li-Na crystallographic data

Phase	Composition, wt% Na	Pearson symbol	Space group
(β_{Li})	0	<i>cI2</i>	<i>Im</i> $\bar{3}m$
(α_{Li}) ^(a)	0	<i>hP2</i>	<i>P6</i> ₃ / <i>mmc</i>
(β_{Na})	100	<i>cI2</i>	<i>Im</i> $\bar{3}m$
(α_{Na})	100	<i>hP2</i>	<i>P6</i> ₃ / <i>mmc</i>

(a) Below -193 °C

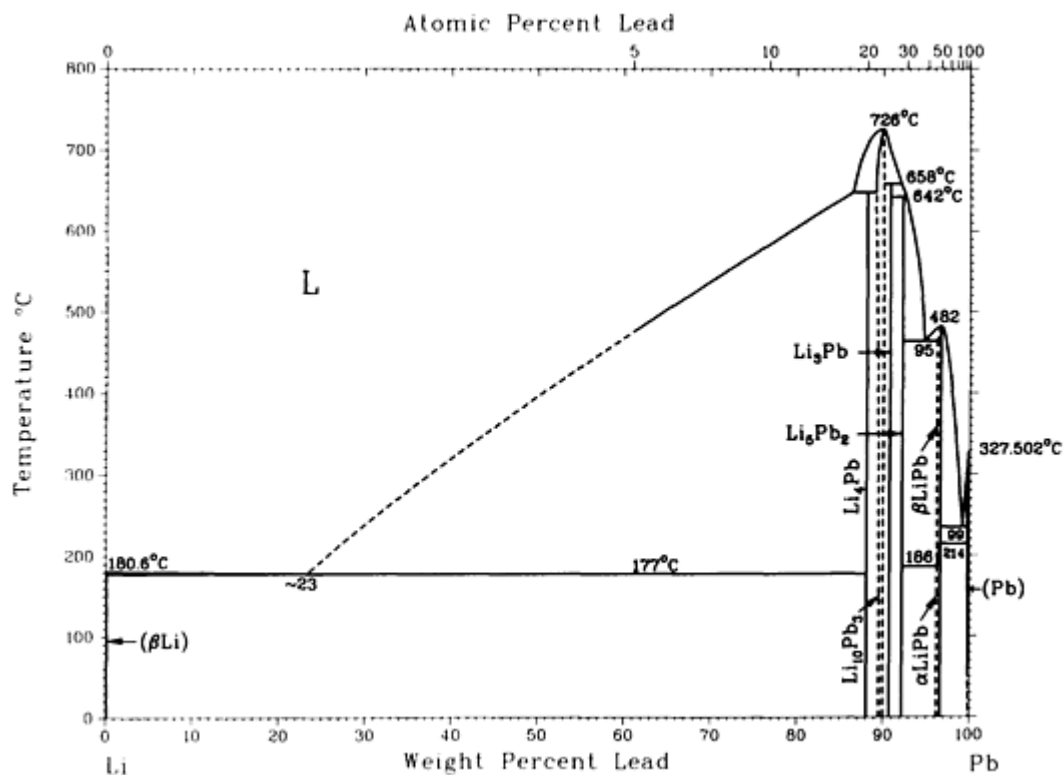

Li-Pb phase diagram

Li-Pb crystallographic data

Phase	Composition, wt% Pb	Pearson symbol	Space group
(β _{Li})	~0	<i>cI2</i>	<i>Im</i> $\bar{3}m$
(α _{Li}) ^(a)	0	<i>hP2</i>	<i>P6</i> ₃ <i>mmc</i>
Li ₄ Pb	~88
Li ₁₀ Pb ₃	~89.7 to ~90.2	<i>cP52</i>	<i>P</i> $\bar{4}$ <i>3m</i>
Li ₃ Pb	~91	<i>cF16</i>	<i>Fm</i> $\bar{3}m$
Li ₅ Pb ₂	92.3
β _{LiPb}	<96 to 96.8	<i>cP2</i>	<i>Pm</i> $\bar{3}m$

α LiPb	<96 to 96.8	<i>hR2</i>	$R\bar{3}m$
(Pb)	99.9 to 100	<i>cF4</i>	$Fm\bar{3}m$
Other reported phases			
Li ₂₂ Pb ₅	~87.1	<i>cF432</i>	<i>F23</i>
Li ₇ Pb ₂	~89.5	<i>hP9</i>	<i>P321</i>
Li ₈ Pb ₃	~91.8	<i>mC22</i>	<i>C2/m</i>

(a) Below
-193
°C

Reference cited in this section

6. [Hansen]: M. Hansen and K. Anderko, *Constitution of Binary Alloys*, McGraw-Hill, New York or General Electric Co., Business Growth Services, Schenectady, New York (1958).

Li-Pd (Lithium - Palladium)

J. Sangster and A.D. Pelton, 1992

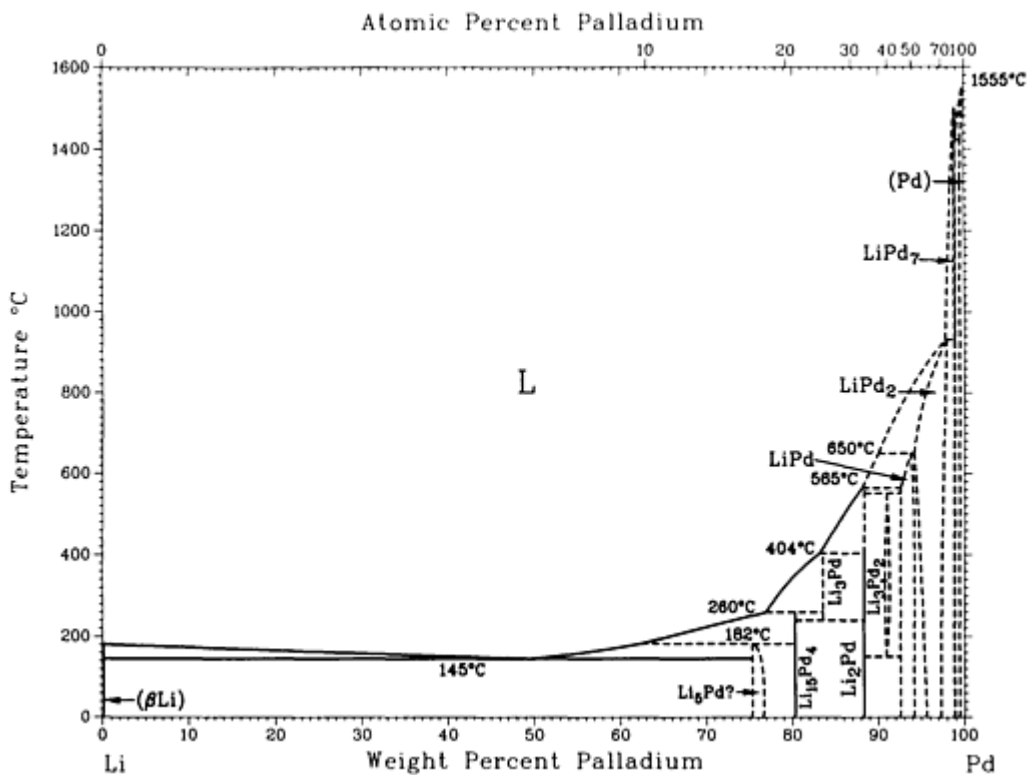

Li-Pd phase diagram

Li-Pd crystallographic data

Phase	Composition, wt% Pd	Pearson symbol	Space group
(β Li)	0	<i>cI2</i>	<i>Im$\bar{3}m$</i>
(α Li) ^(a)	0	<i>hP2</i>	<i>P6$_3$/mmc</i>
Li ₅ Pd ^(b)	75.5 ^(b)	<i>cF*</i>	...
Li ₁₅ Pd ₄	80.4	<i>cI76</i>	<i>I$\bar{4}3d$</i>
Li ₃ Pd	84	<i>cF16</i>	<i>Fm$\bar{3}m$</i>
Li ₂ Pd	88.4	<i>hP3</i>	<i>P6/mmm</i>
Li ₃ Pd ₂	90.9 to 91.5	<i>cP2(?)</i>	<i>Pm$\bar{3}m$</i>
LiPd	92.7 to 94.3	<i>hP2</i>	<i>P$\bar{6}$</i>
LiPd ₂	~94 to 98	<i>mP8</i>	<i>P2/m</i>
LiPd ₇	99.1	<i>cF32</i>	<i>Fm$\bar{3}m$</i>
(Pd)	99.7 to 100	<i>cF4</i>	<i>Fm$\bar{3}m$</i>

(a) Below -193 °C.

(b) Approximate composition

Li-S (Lithium - Sulfur)

H. Okamoto, unpublished

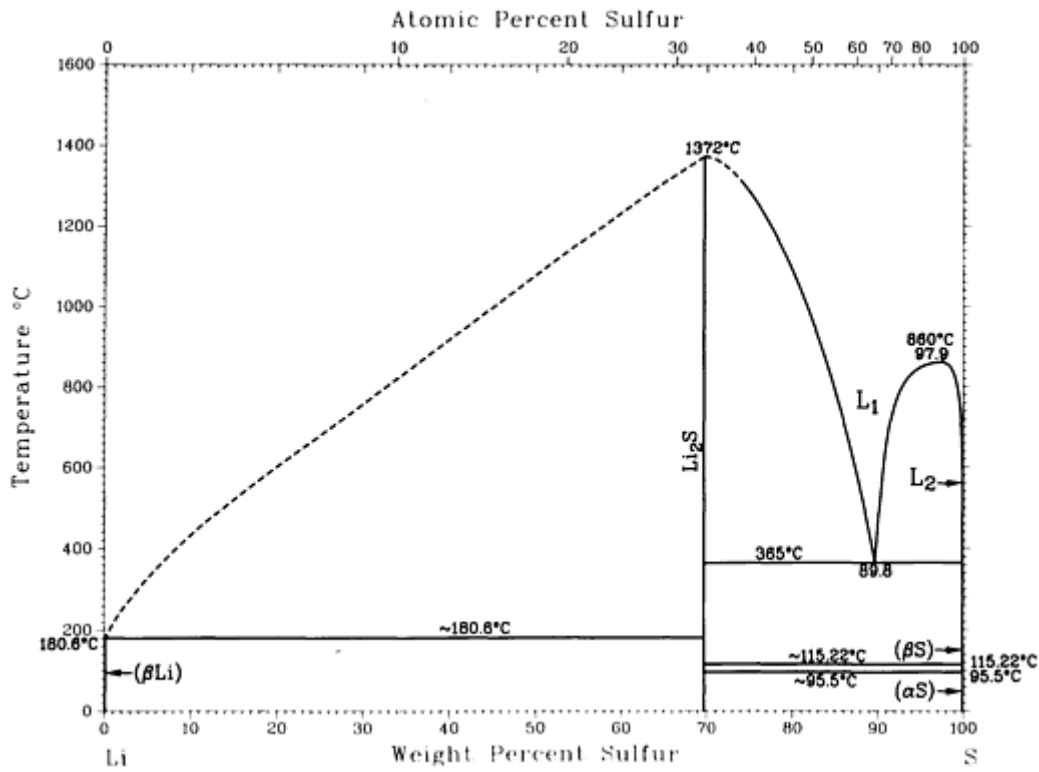

Li-S phase diagram

Li-S crystallographic data

Phase	Composition, wt% S	Pearson symbol	Space group
(βLi)	0	<i>cI2</i>	<i>Im</i> $\bar{3}m$
$(\alpha\text{Li})^{(a)}$	0	<i>hP2</i>	<i>P6</i> $_3/mmc$
Li_2S	69.8	<i>cF12</i>	<i>Fm</i> $\bar{3}m$
(βS)	100	<i>mP48</i>	<i>P2</i> $_1/a$
(αS)	100	<i>oF128</i>	<i>Fddd</i>

(a) Below -193 °C

Li-Se (Lithium - Selenium)

P.T. Cunningham, S.A. Johnson, and E.J. Cairns, 1971

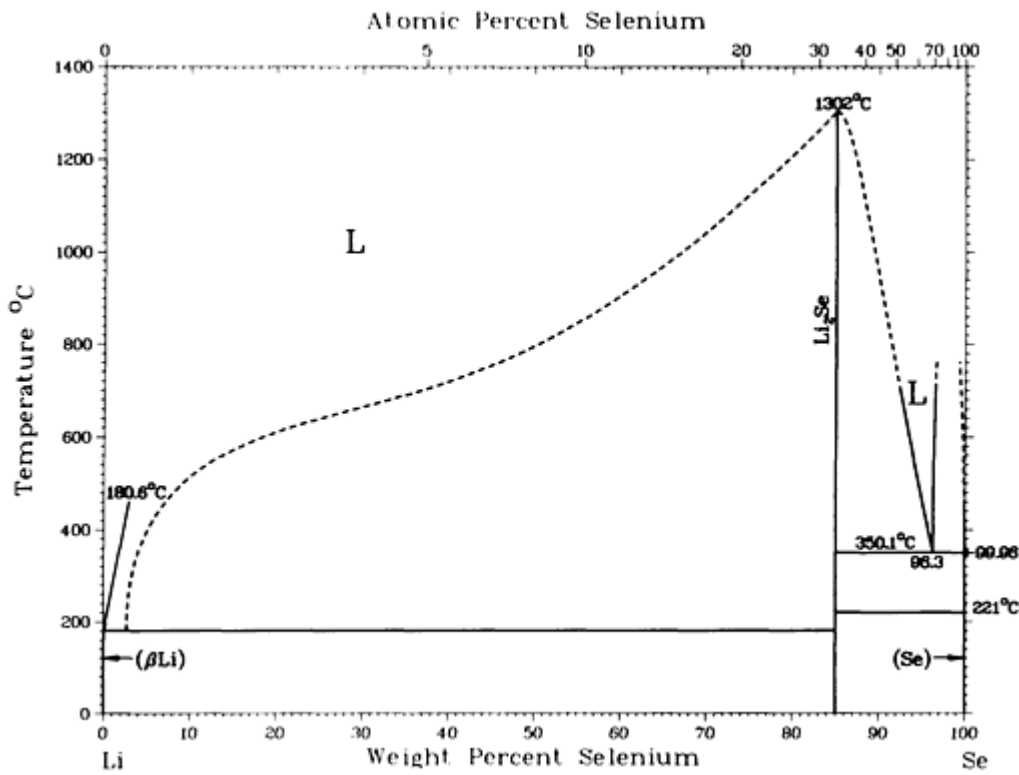

Li-Se phase diagram

Li-Se crystallographic data

Phase	Composition, wt% Se	Pearson symbol	Space group
(β_{Li})	~ 0	$cI2$	$Im\bar{3}m$
(α_{Li})	0	$hP2$	$P6_3/mmc$
Li_2Se	85.0	$cF12$	$Fm\bar{3}m$
(Se)	~ 100	$hP3$	$P3_121$

(a) Below
-193
°C

Li-Si (Lithium - Silicon)

H. Okamoto, 1990

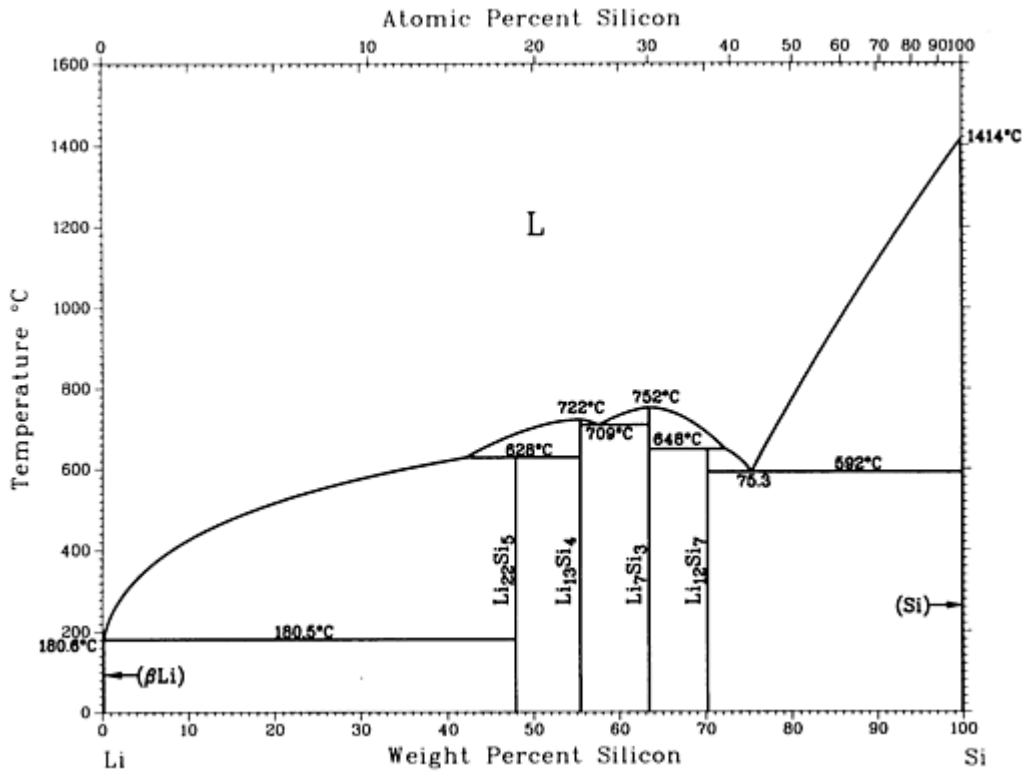

Li-Si phase diagram

Li-Si crystallographic data

Phase	Composition, wt% Si	Pearson symbol	Space group
(βLi)	0	<i>cI2</i>	<i>Fm</i> $\bar{3}m$
$(\alpha\text{Li})^{(a)}$	0	<i>hP2</i>	<i>P6</i> $_3/mmc$
$\text{Li}_{22}\text{Si}_5$	47.9	<i>cF432</i>	<i>F23</i>
$\text{Li}_{13}\text{Si}_4$	55.4	<i>oP24</i>	<i>Pbam</i>
Li_7Si_3	63	<i>hR7</i>	<i>R</i> $\bar{3}m$
$\text{Li}_{12}\text{Si}_7$	70.2	<i>oP152</i>	<i>Pnma</i>
(Si)	100	<i>cF8</i>	<i>Fd</i> $\bar{3}m$

Questionable phases			
Li ₄ Si	50	<i>oP250</i>	?
Li ₇ Si ₂	53.6	<i>oP36</i>	<i>Pbam</i>
Li ₁₀ Si ₃	54.9	<i>cF416</i>	?
Li ₂ Si	66.9	<i>mC12</i>	<i>C2/m</i>
Li ₁₃ Si ₇	69	<i>oP160</i>	<i>Pnma</i>

(a) Below -193 °C

Li-Sn (Lithium - Tin)

From [Moffatt] 11

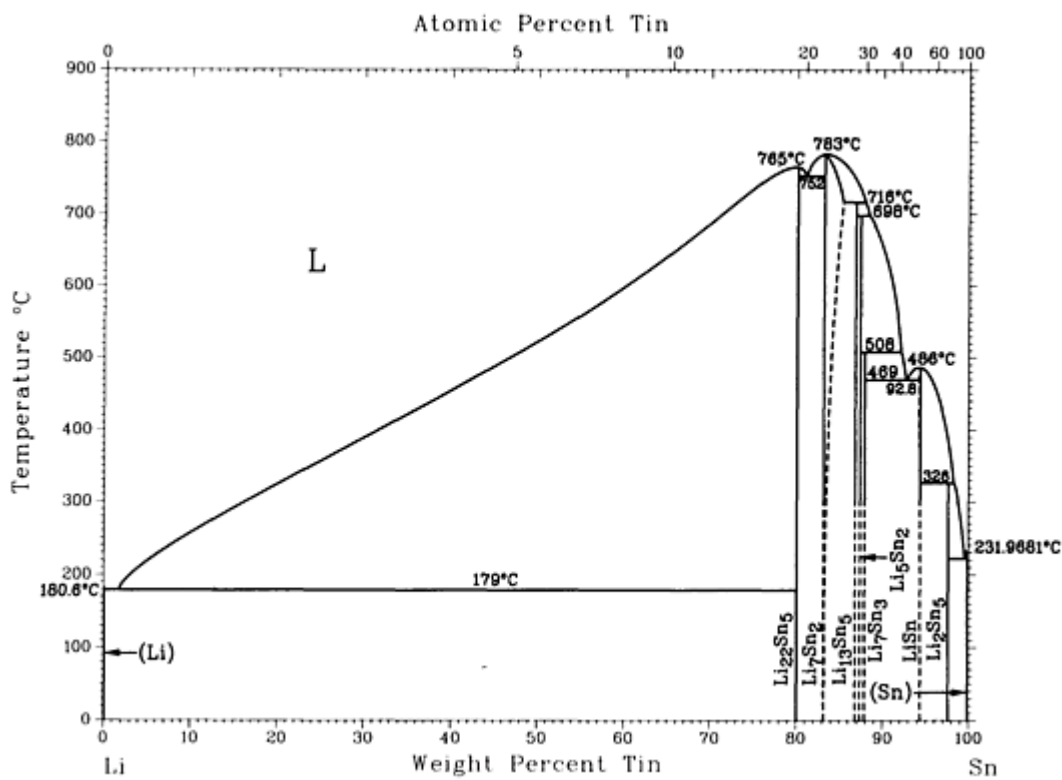

Li-Sn phase diagram

Li-Sn crystallographic data

Phase	Composition,	Pearson	Space

	wt% Sn	symbol	group
(β Li)	0	<i>cI2</i>	<i>Im$\bar{3}m$</i>
(α Li) ^(a)	0	<i>hP2</i>	<i>P6$_3$/mmc</i>
Li ₂₂ Sn ₅	79.5	<i>cF432</i>	F23
Li ₇ Sn ₂	83.0 to ?	<i>oC36</i>	<i>Cmmm</i>
Li ₁₃ Sn ₅	86.8	<i>hP18</i>	<i>P$\bar{3}m1$</i>
Li ₅ Sn ₂	87.3	<i>hR7</i>	<i>R$\bar{3}m$</i>
Li ₇ Sn ₃	88	<i>mP20</i>	<i>P2$_1$/m</i>
LiSn	94.5	<i>mP6</i>	<i>P2/m</i>
Li ₂ Sn ₅	97.7	<i>iI14</i>	<i>P4/mbm</i>
(β Sn)	100	<i>iI4</i>	<i>I4$_1$/amd</i>
(α Sn)	100	<i>cF8</i>	<i>Fd$\bar{3}m$</i>

(a) Below -193 °C

Reference cited in this section

- [Moffatt]: W.G. Moffatt, Ed., *Handbook of Binary Phase Diagrams*, Business Growth Services, General Electric Co., Schenectady, NY (1976).

Li-Sr (Lithium - Strontium)

C.W. Bale and A.D. Pelton, 1989

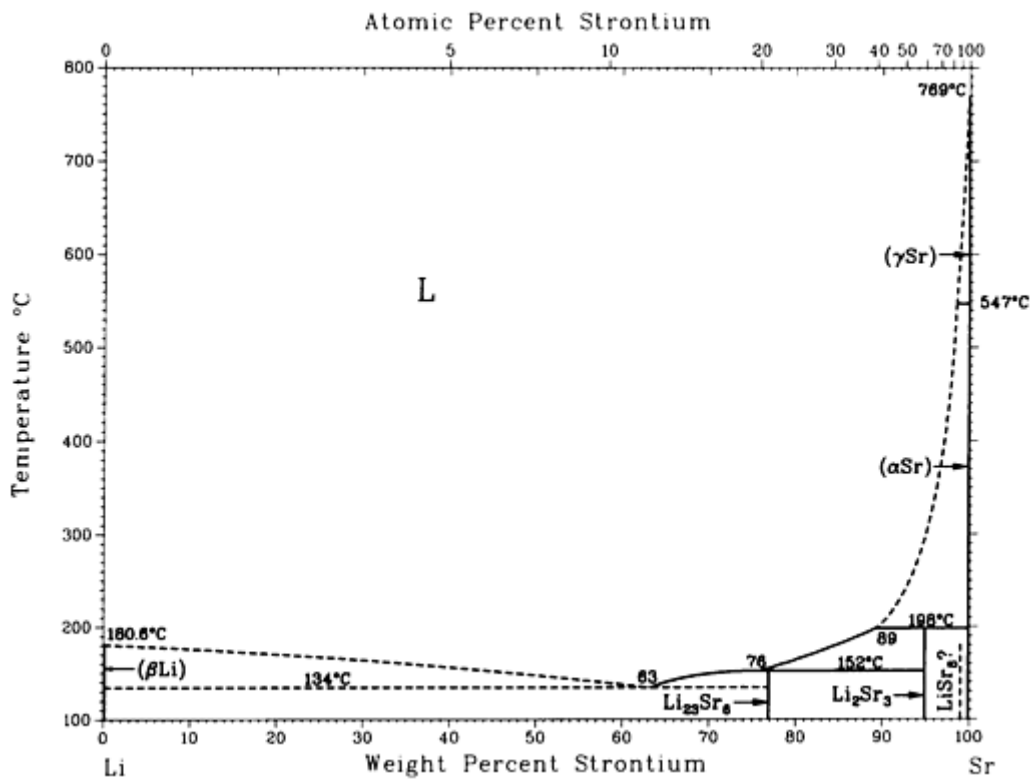

Li-Sr phase diagram

Li-Sr crystallographic data

Phase	Composition, wt% Sr	Pearson symbol	Space group
(βLi)	0	<i>cI2</i>	<i>Im</i> $\bar{3}m$
(αLi) ^(a)	0	<i>hP2</i>	<i>P6</i> ₃ / <i>mmc</i>
Li ₂₃ Sr ₆	76.7	<i>cF116</i>	<i>Fm</i> $\bar{3}m$
Li ₂ Sr ₃	95	<i>tP20</i>	<i>P4</i> ₂ / <i>mnm</i>
LiSr ₇ (?)	98.9	<i>t**</i>	...
LiSr ₈ (?)	99.0	<i>t**</i> <i>hP*</i>

(γ Sr)	100	$cI2$	$Im\bar{3}m$
(α Sr)	100	$cF4$	$Fm\bar{3}m$

(a) Below -193 °C

Li-Te (Lithium - Tellurium)

J. Sangster and A.D. Pelton, 1992

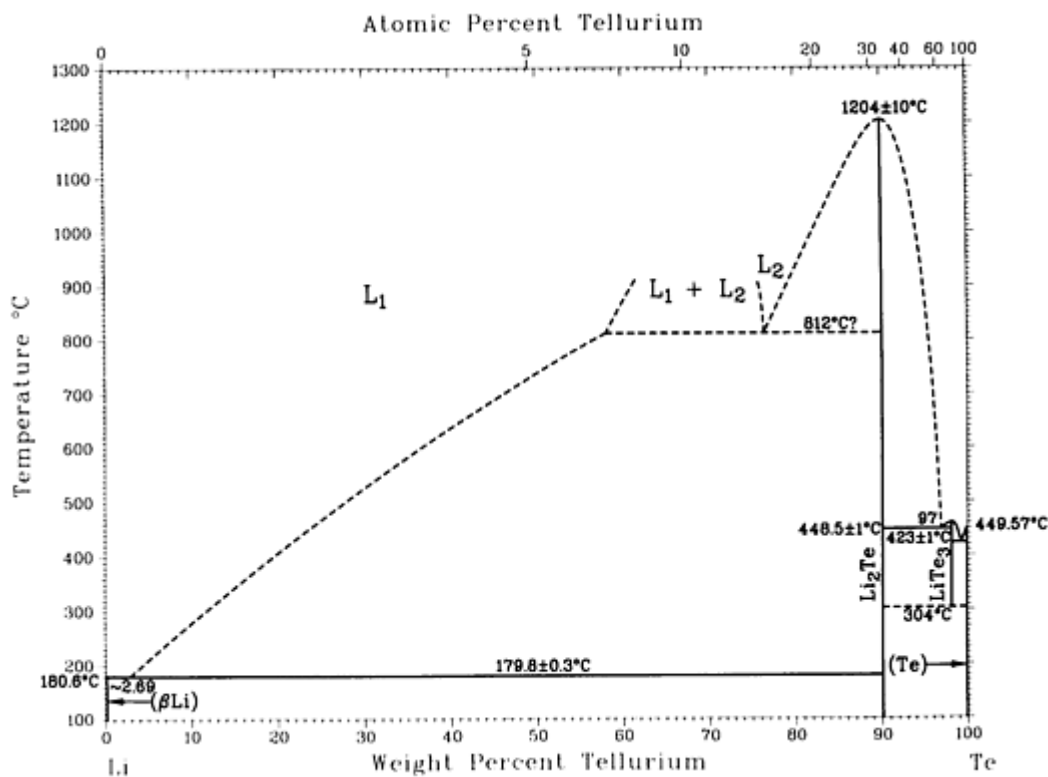

Li-Te phase diagram

Li-Te crystallographic data

Phase	Composition, wt% Te	Pearson symbol	Space group
(β Li)	0	$cI2$	$Im\bar{3}m$
(α Li) ^(a)	0	$hP2$	$P6_3/mmc$
Li ₂ Te	90.2	$cF12$	$Fm\bar{3}m$

LiTe ₃	98.2	<i>hP48</i> ^(b)	<i>P</i> $\bar{3}c1$
(α Te)	100	<i>hP3</i>	<i>P3</i> ₁ 21

(a) Below -193 °C.

(b) Rhombohedrally centered hexagonal supercell, which is imposed on a cubic pseudocell

Li-Tl (Lithium - Thallium)

G. Grube and G. Schaufler, 1934

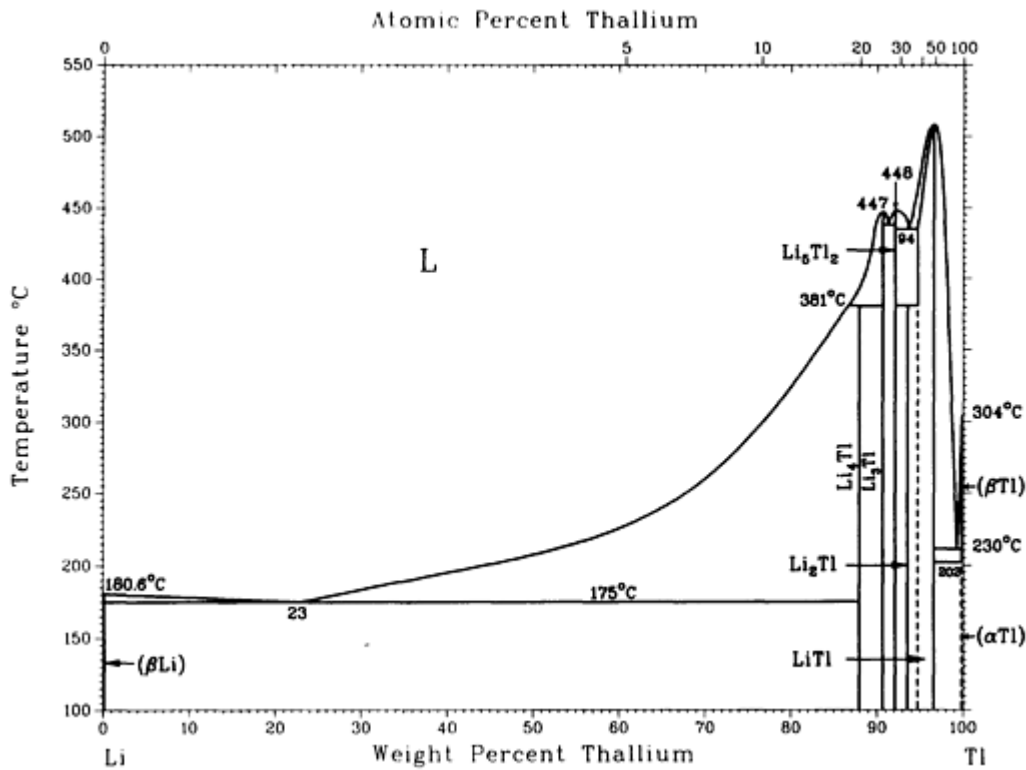

Li-Tl phase diagram

Li-Tl crystallographic data

Phase	Composition, wt% Tl	Pearson symbol	Space group
(β Li)	~0	<i>cI2</i>	<i>Im</i> $\bar{3}m$
(α Li) ^(a)	0	<i>hP2</i>	<i>P6</i> ₃ / <i>mmc</i>

Li_4Tl	88
Li_3Tl	91	<i>cF16</i>	<i>Fm\bar{3}m</i>
Li_5Tl_2	~92.1	<i>hR7</i>	<i>R\bar{3}m</i>
Li_2Tl	93.6	<i>oC12</i>	<i>Cmcm</i>
LiTl	~94.9 to 96.7	<i>cP2</i>	<i>Pm\bar{3}m</i>
$(\beta\text{-Tl})$	>99.9 to 100	<i>cI2</i>	<i>Im\bar{3}m</i>
$(\alpha\text{-Tl})$	~99.9 to 100	<i>hP2</i>	<i>P6_3/mmc</i>
Other reported phase			
$\text{Li}_{22}\text{Tl}_5$	87.0	<i>cF432</i>	<i>F23</i>

(a) Below
-193
°C

Li-Zn (Lithium - Zinc)

A.D. Pelton, 1991

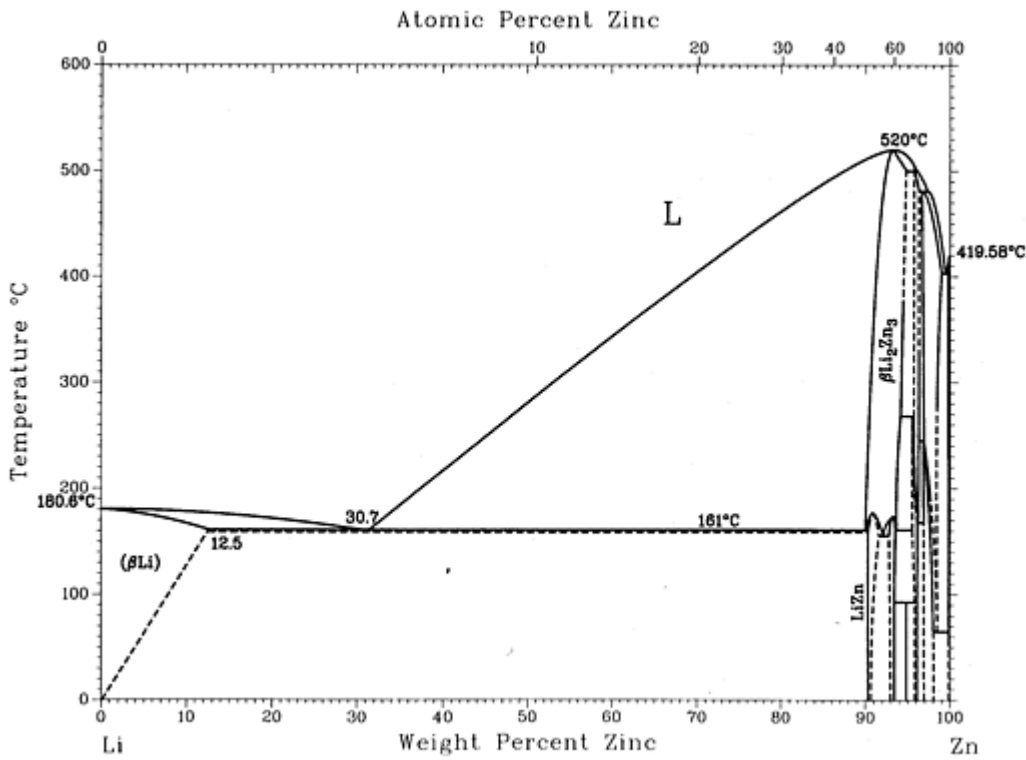

Li-Zn phase diagram

Li-Zn crystallographic data

Phase	Composition, wt% Zn	Pearson symbol	Space group
(β _{Li})	0 to 12.5	<i>cI2</i>	<i>Im</i> $\bar{3}m$
(α _{Li}) ^(a)	0	<i>hP2</i>	<i>P6</i> ₃ / <i>mmc</i>
LiZn	~90.4 to 92	<i>cF16</i>	<i>Fd</i> $\bar{3}m$
β _{Li₂Zn₃}	~90.4 to 95
α _{Li₂Zn₃}	~93 to 93	<i>c**?</i>	...
LiZn ₂	94.97
β _{Li₂Zn₅} ^(b)	95.8 to 99.1

$\alpha\text{Li}_2\text{Zn}_5^{(b)}$	95.6 to 96.2	$h^{**^{(c)}}$...
βLiZn_4	~ 96.6 to 98.8	$hP2$	$P6_3/mmc^{(d)}$
αLiZn_4	~ 96.9 to 98.2	$h^{**^{(e)}}$...
(Zn)	99.9 to 100	$hP2$	$P6_3/mmc$

(a) Below -193 °C.

(b) Possibly Li_3Zn_8 is a better designation.

(c) Pseudocell.

(d) Disordered--random distribution.

(e) Ordered

Introduction

THIS ARTICLE includes systems where lutetium is the first-named element in the binary pair.

Lu-Pb (Lutetium - Lead)

O.D. McMasters and K.A. Gschneidner, Jr., 1969

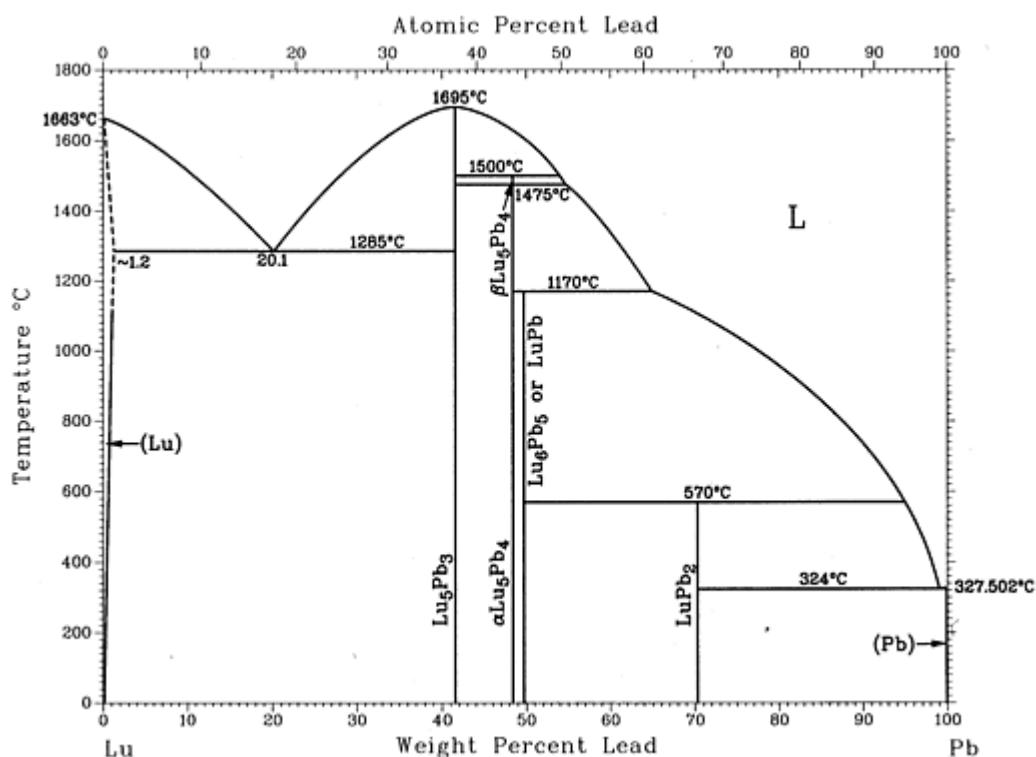

Lu-Pb phase diagram

Lu-Pb crystallographic data

Phase	Composition, wt% Pb	Pearson symbol	Space group
(Lu)	0 to ~1.2	<i>hP2</i>	<i>P6₃/mmc</i>
Lu ₅ Pb ₃	41.5	<i>hP16</i>	<i>P6₃/mcm</i>
β-Lu ₅ Pb ₄	48.6
α-Lu ₅ Pb ₄	48.6	<i>oP*</i>	<i>Pnma</i>
Lu ₆ Pb ₅ or LuPb	49.7	<i>oI*</i>	<i>Ibam</i>

LuPb ₂	70.3	<i>tI6</i>	<i>I4/mmm</i>
(Pb)	~100	<i>cF4</i>	<i>Fm$\bar{3}m$</i>

Lu-Tl (Lutetium - Thallium)

H. Okamoto, 1990

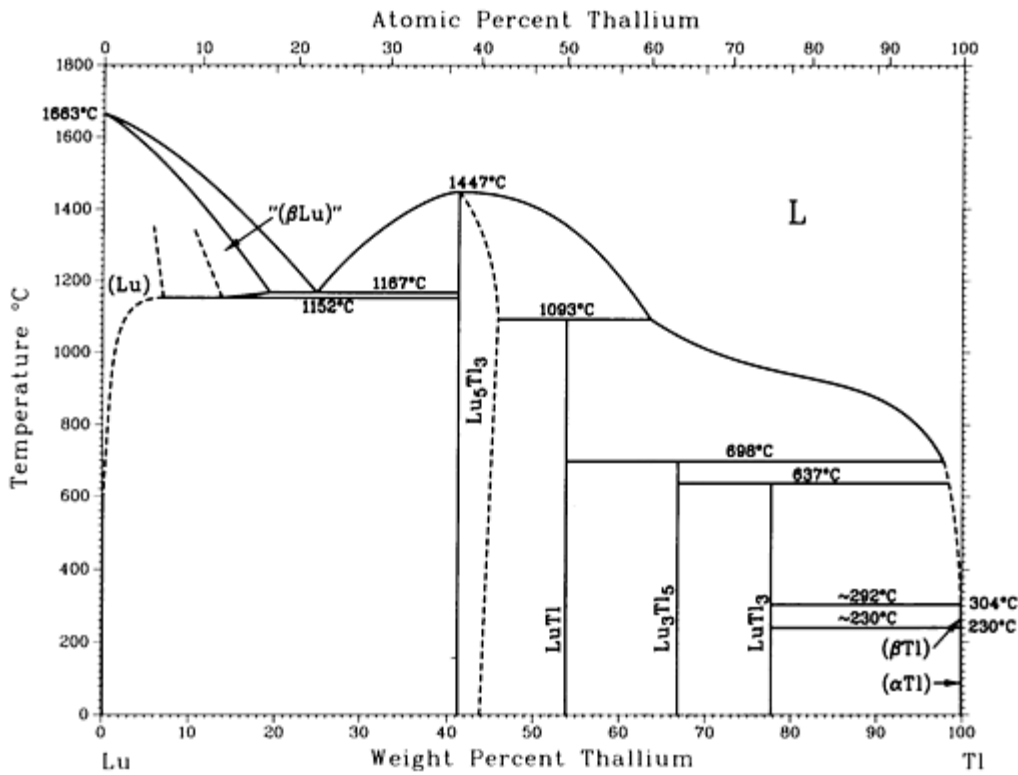

Lu-Tl phase diagram

Lu-Tl crystallographic data

Phase	Composition, wt% Tl	Pearson symbol	Space group
(Lu)	~0	<i>hP6</i>	<i>P6₃/mmc</i>
Lu ₅ Tl ₃	41.2	<i>hP16</i>	<i>P6₃/mcm</i>
LuTl	53.9
Lu ₃ Tl ₅	66.1	<i>oC32</i>	<i>Cmcm</i>

LuTl ₃	78	<i>cP4</i>	<i>Pm</i> $\bar{3}m$
(β Tl)	~100	<i>cI2</i>	<i>Im</i> $\bar{3}m$
(α Tl)	~100	<i>hP2</i>	<i>P6₃/mmc</i>

Mg (Magnesium) Binary Alloy Phase Diagrams

Introduction

THIS ARTICLE includes systems where magnesium is the first-named element in the binary pair. Additional binary systems that include magnesium are provided in the following locations in this Volume:

- “Ag-Mg (Silver - Magnesium)” in the article “Ag (Silver) Binary Alloy Phase Diagrams.”
- “Al-Mg (Aluminum - Magnesium)” in the article “Al (Aluminum) Binary Alloy Phase Diagrams.”
- “Au-Mg (Gold - Magnesium)” in the article “Au (Gold) Binary Alloy Phase Diagrams.”
- “Ba-Mg (Barium - Magnesium)” in the article “Ba (Barium) Binary Alloy Phase Diagrams.”
- “Bi-Mg (Bismuth - Magnesium)” in the article “Bi (Bismuth) Binary Alloy Phase Diagrams.”
- “Ca-Mg (Calcium - Magnesium)” in the article “Ca (Calcium) Binary Alloy Phase Diagrams.”
- “Cd-Mg (Cadmium - Magnesium)” in the article “Cd (Cadmium) Binary Alloy Phase Diagrams.”
- “Ce-Mg (Cerium - Magnesium)” in the article “Ce (Cerium) Binary Alloy Phase Diagrams.”
- “Cu-Mg (Copper - Magnesium)” in the article “Cu (Copper) Binary Alloy Phase Diagrams.”
- “Eu-Mg (Europium - Magnesium)” in the article “Eu (Europium) Binary Alloy Phase Diagrams.”
- “Ga-Mg (Gallium - Magnesium)” in the article “Ga (Gallium) Binary Alloy Phase Diagrams.”
- “Gd-Mg (Gadolinium - Magnesium)” in the article “Gd (Gadolinium) Binary Alloy Phase Diagrams.”
- “Ge-Mg (Germanium - Magnesium)” in the article “Ge (Germanium) Binary Alloy Phase Diagrams.”
- “Hg-Mg (Mercury - Magnesium)” in the article “Hg (Mercury) Binary Alloy Phase Diagrams.”
- “In-Mg (Indium - Magnesium)” in the article “In (Indium) Binary Alloy Phase Diagrams.”
- “La-Mg (Lanthanum - Magnesium)” in the article “La (Lanthanum) Binary Alloy Phase Diagrams.”
- “Li-Mg (Lithium - Magnesium)” in the article “Li (Lithium) Binary Alloy Phase Diagrams.”

Mg-Mn (Magnesium - Manganese)

A.A. Nayeb-Hashemi and J.B. Clark, 1988

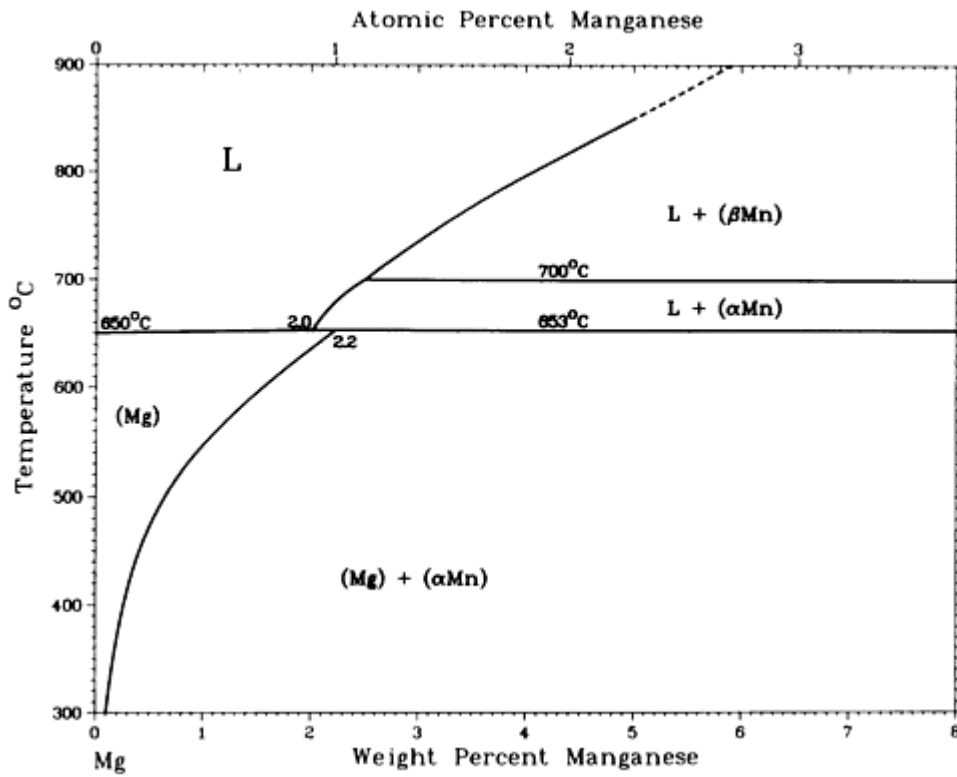

Mg-Mn phase diagram

Mg-Mn crystallographic data

Phase	Composition, wt% Mn	Pearson symbol	Space group
(Mg)	0 to 2.2	<i>hP2</i>	<i>P6₃/mmc</i>
(αMn)	100	<i>cI58</i>	<i>I4₃m</i>
(βMn)	100	<i>cP20</i>	<i>P4₁32</i>
(γMn)	100	<i>cF4</i>	<i>Fm m</i>
(δMn)	100	<i>cI2</i>	<i>Im m</i>

Mg-Ni (Magnesium - Nickel)

A.A. Nayeb-Hashemi and J.B. Clark, 1991

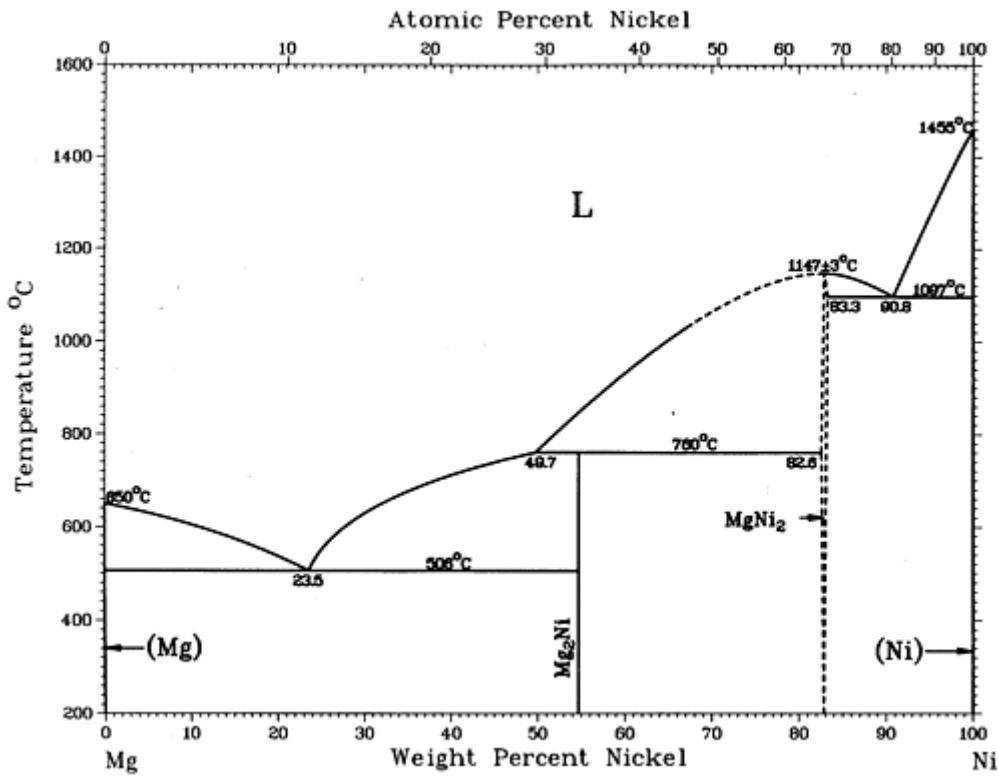

Mg-Ni phase diagram

Mg-Ni crystallographic data

Phase	Composition, wt% Ni	Pearson symbol	Space group
(Mg)	0	<i>hP2</i>	<i>P6₃/mmc</i>
Mg_2Ni	54.7	<i>hP18</i>	<i>P6₂22</i>
$MgNi_2$	82.9	<i>hP24</i>	<i>P6₃/mmc</i>
(Ni)	100	<i>cF4</i>	<i>Fm m</i>

Mg-Pb (Magnesium - Lead)

A.A. Nayeb-Hashemi and J.B. Clark, 1988

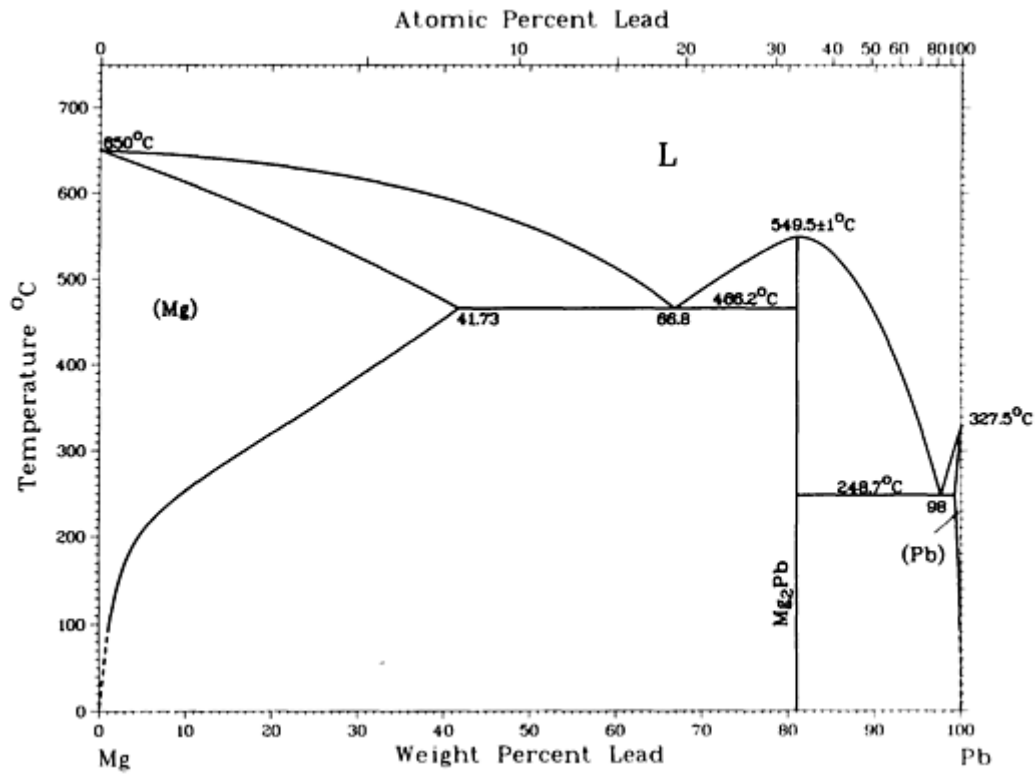

Mg-Pb phase diagram

Mg-Pb crystallographic data

Phase	Composition, wt% Pb	Pearson symbol	Space group
(Mg)	0 to 41.73	<i>hP2</i>	<i>P6₃/mmc</i>
Mg ₂ Pb	81.00	<i>cF12</i>	<i>Fm$\bar{3}m$</i>
(Pb)	~99 to 100	<i>cF4</i>	<i>Fm$\bar{3}m$</i>

Mg-Sb (Magnesium - Antimony)

A.A. Nayeb-Hashemi and J.B. Clark, 1988

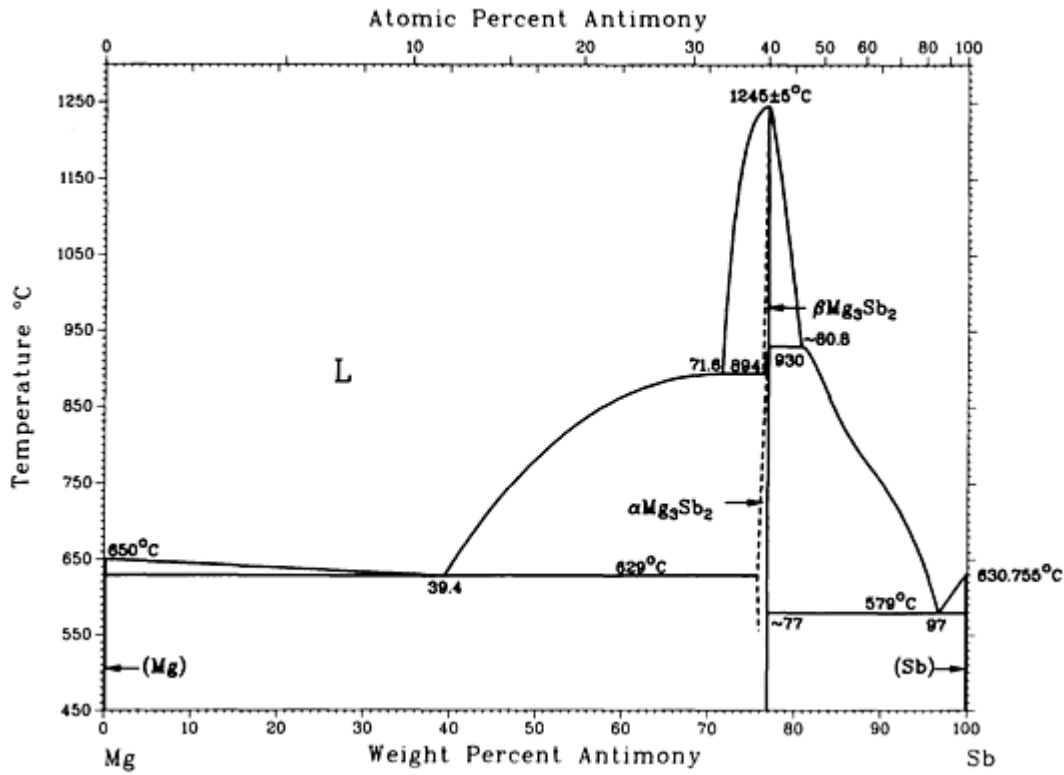

Mg-Sb phase diagram

Mg-Sb crystallographic data

Phase	Composition, wt% Sb	Pearson symbol	Space group
(Mg)	0	$hP2$	$P6_3/mmc$
β - Mg_3Sb_2	~77	$cI80$	$Ia\bar{3}$
α - Mg_3Sb_2	~77	$hP5$	$P\bar{3}m1$
(Sb)	100	$hR2$	$R\bar{3}m$

Mg-Si (Magnesium - Silicon)

A.A. Nayeb-Hashemi and J.B. Clark, 1988

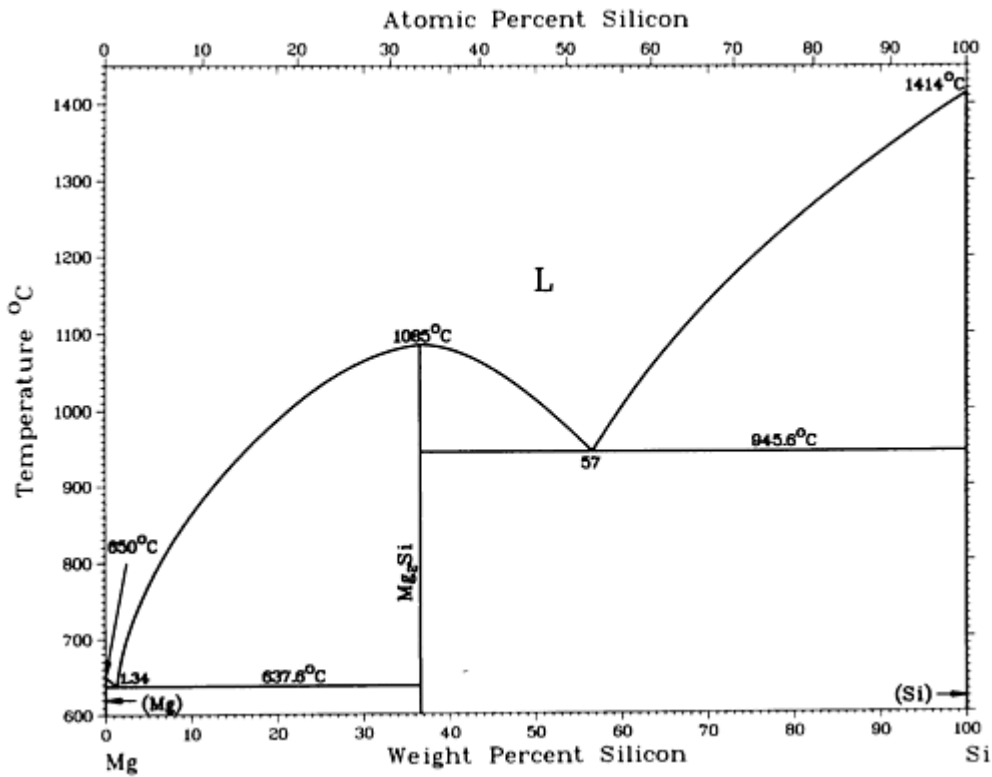

Mg-Si phase diagram

Mg-Si crystallographic data

Phase	Composition, wt% Si	Pearson symbol	Space group
(Mg)	~0	<i>hP2</i>	<i>P6₃/mmc</i>
Mg ₂ Si	36.61	<i>cF12</i>	<i>Fm$\bar{3}$m</i>
(Si)	~100	<i>cF8</i>	<i>Fd$\bar{3}$m</i>
High-pressure phases			
Mg ₂ Si ^(a)	36.61
SiII	100

(a) Above ~2.5 GPa and 900 °C, it forms a hexagonal structure.

Mg-Sm (Magnesium - Samarium)

A.A. Nayeb-Hashemi and J.B. Clark, 1988

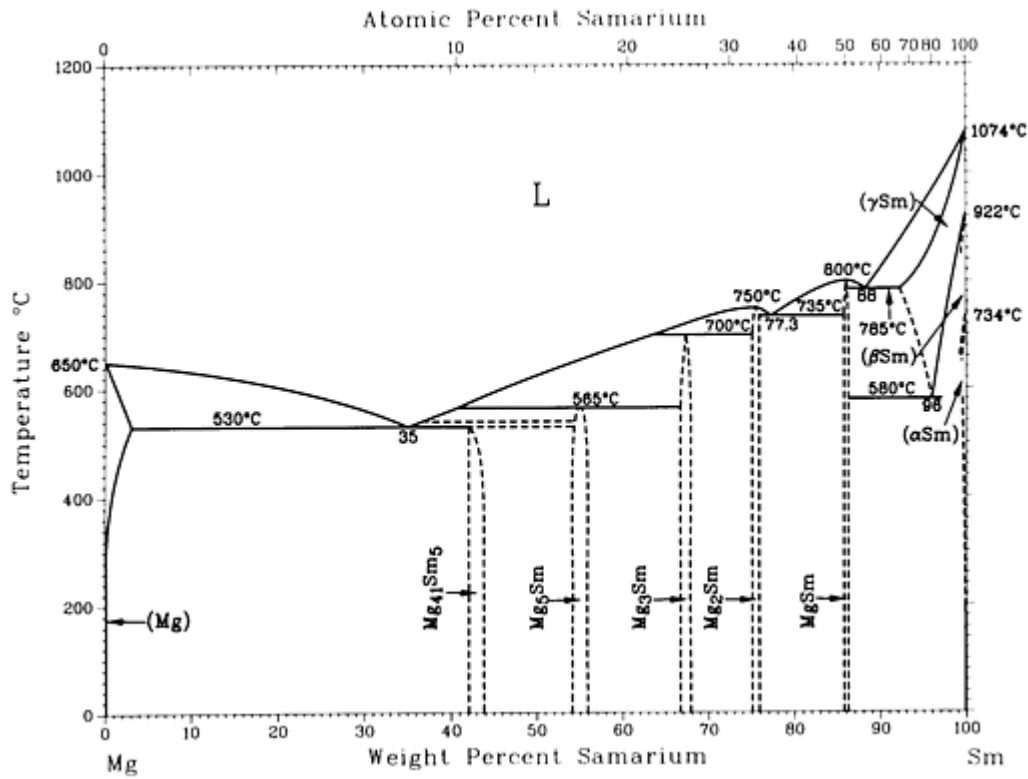

Mg-Sm phase diagram

Mg-Sm crystallographic data

Phase	Composition, wt% Sm	Pearson symbol	Space group
(Mg)	0 to ~6	<i>hP2</i>	<i>P6₃/mmc</i>
Mg ₄₁ Sm ₅	43.1	<i>tI92</i>	<i>I4/m</i>
Mg ₅ Sm	55.4	<i>cF440-448</i>	<i>F$\bar{4}3m$</i>
Mg ₃ Sm	67	<i>cF16</i>	<i>Fm$\bar{3}m$</i>
Mg ₂ Sm	75.57	<i>cF24</i>	<i>Fd$\bar{3}m$</i>
MgSm	86.1	<i>cP2</i>	<i>Pm$\bar{3}m$</i>

(γ_{Sn})	~96 to 100	<i>cI2</i>	<i>Im$\bar{3}m$</i>
(β_{Sn})	100	<i>hP2</i>	<i>P6$_3$/mmc</i>
(α_{Sn})	100	<i>hR3</i>	<i>R$\bar{3}m$</i>

Mg-Sn (Magnesium - Tin)

A.A. Nayeb-Hashemi and J.B. Clark, 1988

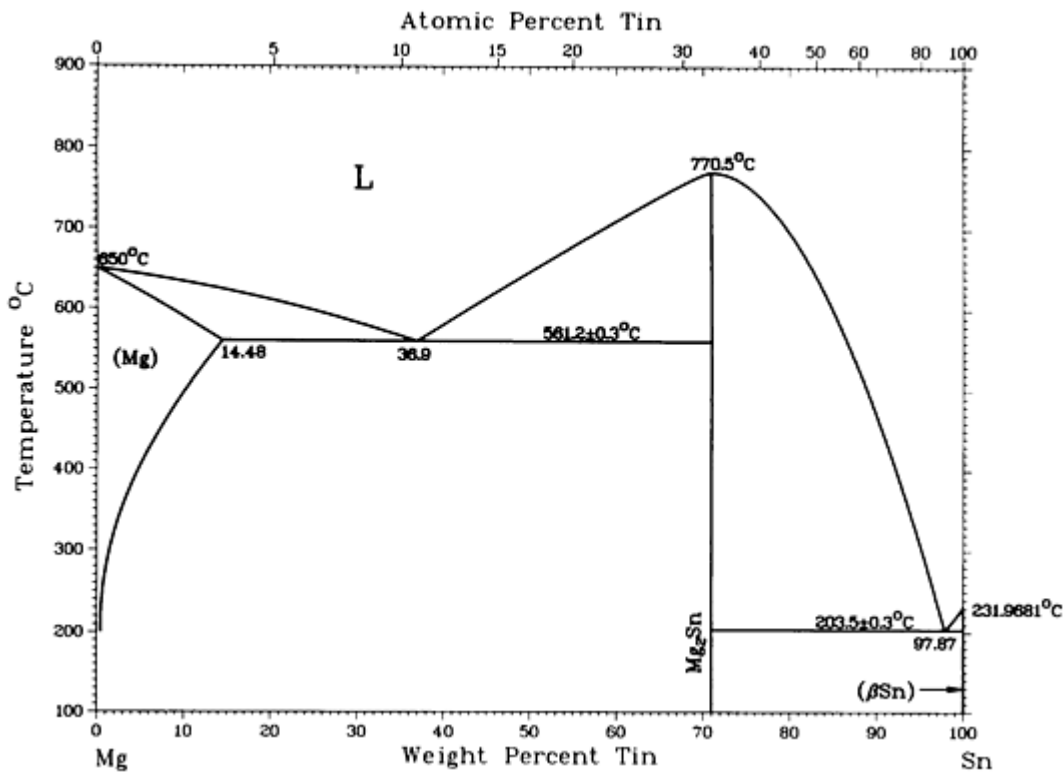

Mg-Sn phase diagram

Mg-Sn crystallographic data

Phase	Composition, wt% Sn	Pearson symbol	Space group
(Mg)	0 to 14.48	<i>hP2</i>	<i>P6$_3$/mmc</i>
Mg ₂ Sn	70.9	<i>cF12</i>	<i>Fm$\bar{3}m$</i>
(β_{Sn})	100	<i>tI4</i>	<i>I4$_1$/amd</i>

(α Sn)	100	$cF8$	$Fd\bar{3}m$
High-pressure phases			
Mg ₂ Sn	70.9	h^{**}	...
SnII	100	$tI2$...
SnIII	100	$cI2$...

Mg-Sr (Magnesium - Strontium)

A.A. Nayeb-Hashemi and J.B. Clark, 1988

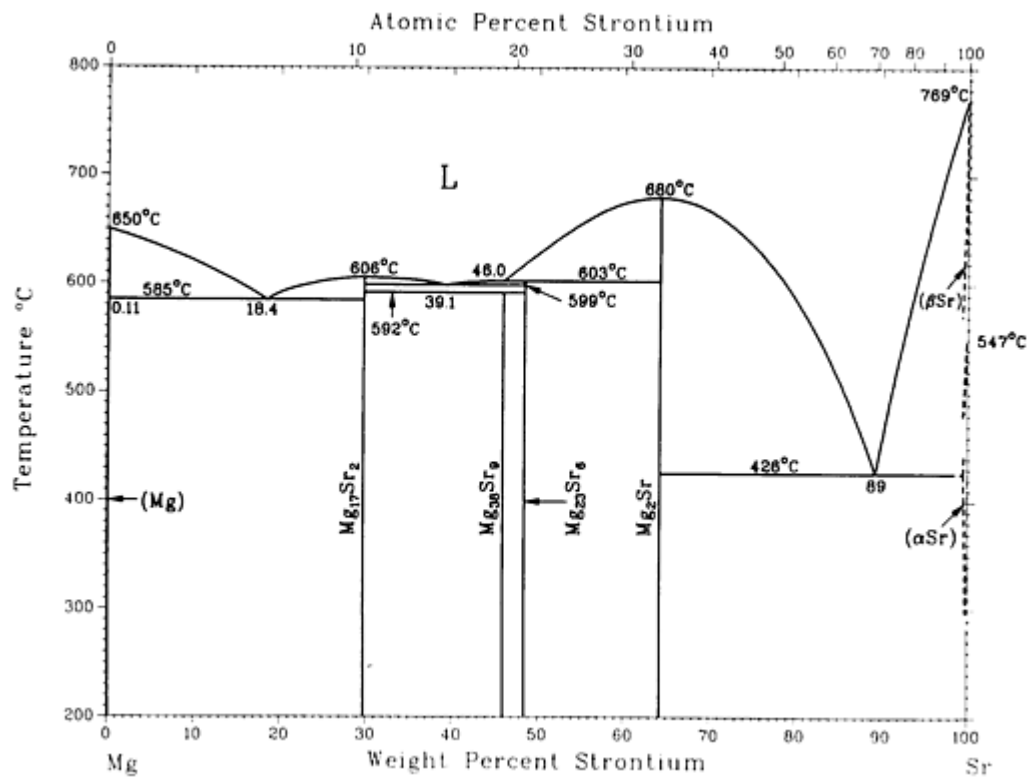

Mg-Sr phase diagram

Mg-Sr crystallographic data

Phase	Composition, wt% Sr	Pearson symbol	Space group
(Mg)	0 to 0.11	$hP2$	$P6_3/mmc$
Mg ₁₇ Sr ₂	29.79	$hP38$	$P6_3/mmc$

Mg ₃₈ Sr ₉ or Mg ₄ Sr	46.06	<i>hP94</i> or <i>hP90</i>	<i>P6₃/mmc</i>
Mg ₂₃ Sr ₆	48.47	<i>cF116</i>	<i>Fm$\bar{3}m$</i>
Mg ₂ Sr	64.31	<i>hP12</i>	<i>P6₃/mmc</i>
(γ Sr)	100	<i>cI2</i>	<i>Im$\bar{3}m$</i>
(α Sr)	? to 100	<i>cF4</i>	<i>Fm$\bar{3}m$</i>

Mg-Th (Magnesium - Thorium)

A.A. Nayeb-Hashemi and J.B. Clark, 1988

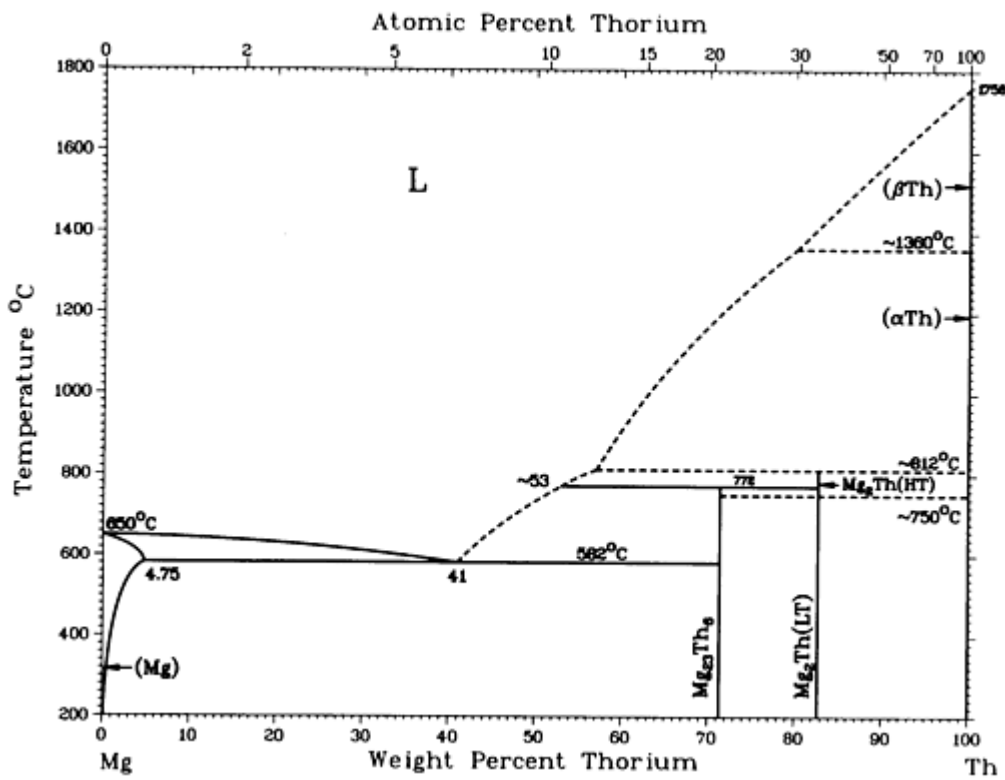

Mg-Th phase diagram

Mg-Th crystallographic data

Phase	Composition, wt% Th	Pearson symbol	Space group
(Mg)	0 to 4.75	<i>hP2</i>	<i>P6₃/mmc</i>

Mg ₂₃ Th ₆	71.35	cF116	<i>Fm</i> $\bar{3}m$
Mg ₂ Th (HT)	82.68	cF4	<i>Fd</i> $\bar{3}m$
Mg ₂ Th (LT)	82.68	hP4	<i>P6</i> ₃ / <i>mmc</i>
(β Th)	100	cI2	<i>Im</i> $\bar{3}m$
(α Th)	100	cF4	<i>Fm</i> $\bar{3}m$

Mg-Tl (Magnesium - Thallium)

A.A. Nayeb-Hashemi and J.B. Clark, 1988

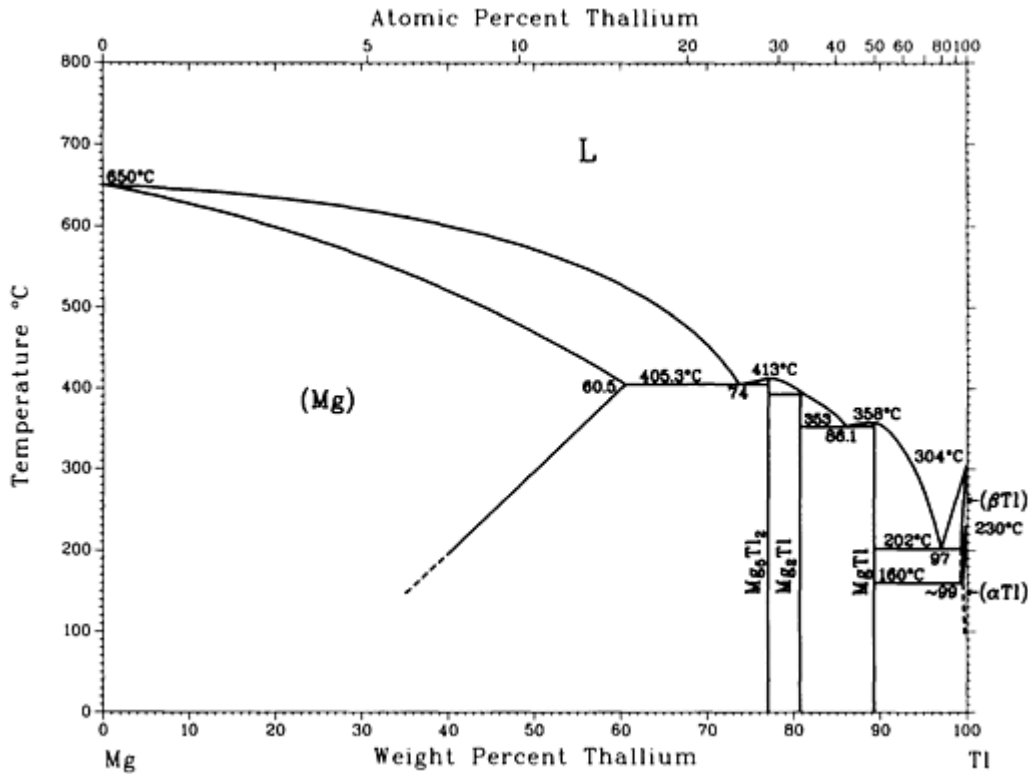

Mg-Tl phase diagram

Mg-Tl crystallographic data

Phase	Composition, wt% Tl	Pearson symbol	Space group
(Mg)	0 to 60.5	hP2	<i>P6</i> ₃ / <i>mmc</i>

Mg ₅ Tl ₂	77.08	<i>oI28</i>	<i>Ibam</i>
Mg ₂ Tl	80.78	<i>hP9</i>	<i>P$\bar{6}2m$</i>
MgTl	89.4	<i>cP2</i>	<i>Pm$\bar{3}m$</i>
(β Tl)	100	<i>cI2</i>	<i>Im$\bar{3}m$</i>
(α Tl)	100	<i>hP2</i>	<i>P6₃/mmc</i>

Mg-Y (Magnesium - Yttrium)

H. Okamoto, 1991

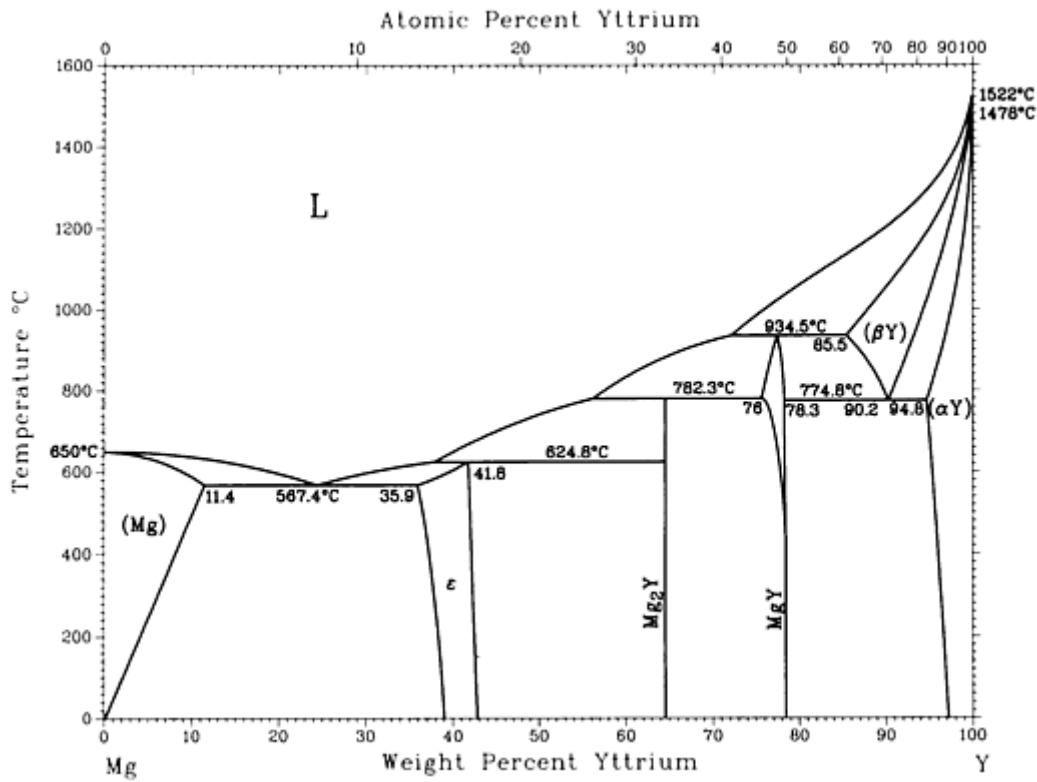

Mg-Y phase diagram

Mg-Y crystallographic data

Phase	Composition, wt% Y	Pearson symbol	Space group
(Mg)	0 to 11.4	<i>hP2</i>	<i>P6₃/mmc</i>

ϵ	35.9 to 41.8	<i>cI58</i>	$I\bar{4}3m$
Mg_2Y	64.6	<i>hP12</i>	$P6_3/mmc$
MgY	76 to 78.3	<i>cP2</i>	$Pm\bar{3}m$
(β_Y)	85.5 to 100	<i>cI2</i>	$Im\bar{3}m$
(α_Y)	94.8 to 100	<i>hP2</i>	$P6_3/mmc$

Mg-Yb (Magnesium - Ytterbium)

A.A. Nayeb-Hashemi and J.B. Clark, 1988

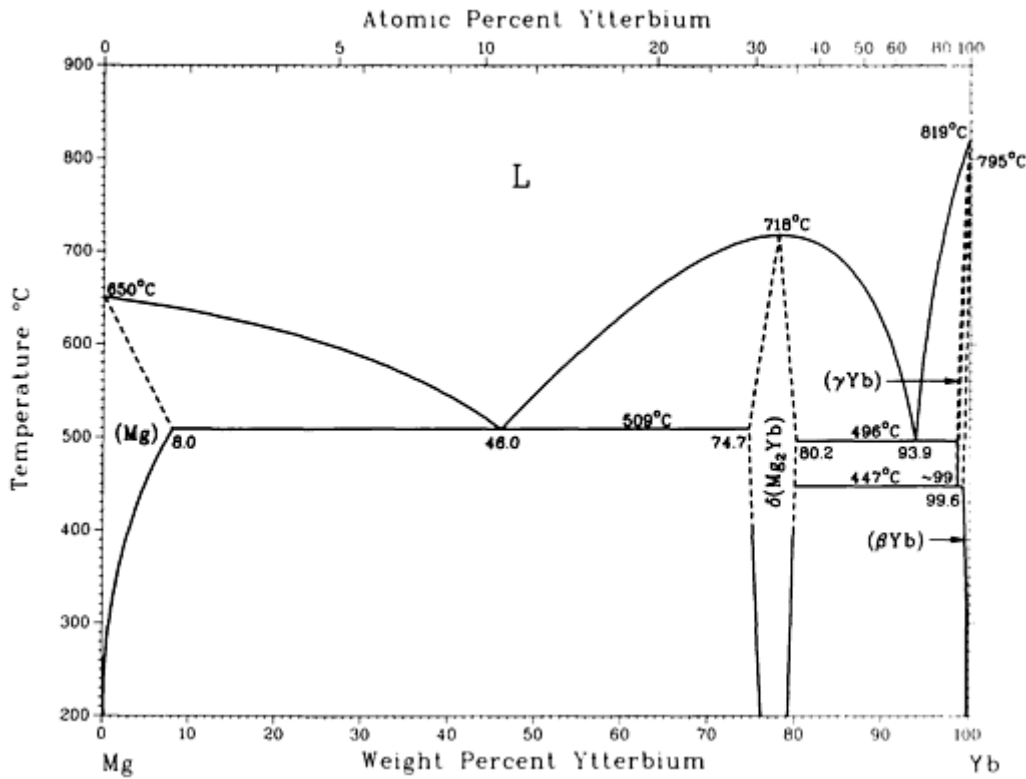

Mg-Yb phase diagram

Mg-Yb crystallographic data

Phase	Composition, wt% Yb	Pearson symbol	Space group
(Mg)	0 to 8.0	<i>hP2</i>	$P6_3/mmc$

$\delta(\text{Mg}_2\text{Yb})$	74.7 to 80.2	<i>hP12</i>	<i>P6₃/mmc</i>
(γYb)	~99 to 100	<i>cI2</i>	<i>Im$\bar{3}m$</i>
(βYb)	99.6 to 100	<i>cF4</i>	<i>Fm$\bar{3}m$</i>
(αYb)	100	<i>hP2</i>	<i>P6₃/mmc</i>

Mg-Zn (Magnesium - Zinc)

J.B. Clark, L. Zabdyr, and Z. Moser, 1988

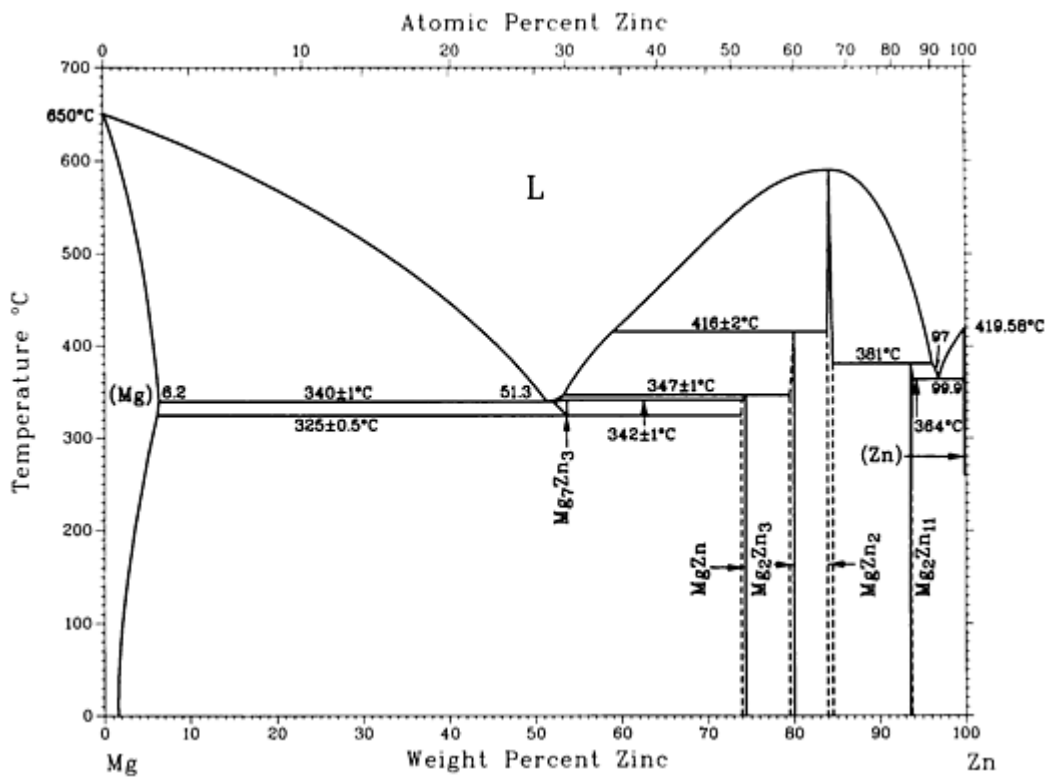

Mg-Zn phase diagram

Mg-Zn crystallographic data

Phase	Composition, wt% Zn	Pearson symbol	Space group
(Mg)	0 to 6.2	<i>hP2</i>	<i>P6₃/mmc</i>
Mg_7Zn_3	53.6	<i>oI142</i>	<i>Immm</i>

MgZn	74.0
Mg ₂ Zn ₃	80.1	<i>mC110</i>	<i>C2/m</i>
MgZn ₂	84 to 84.6	<i>hP12</i>	<i>P6₃/mmc</i>
Mg ₂ Zn ₁₁	93.7	<i>cP39</i>	<i>Pm$\bar{3}$</i>
(Zn)	99.9 to 100	<i>hP2</i>	<i>P6₃/mmc</i>

Mg-Zr (Magnesium - Zirconium)

A.A. Nayeb-Hashemi and J.B. Clark, 1988

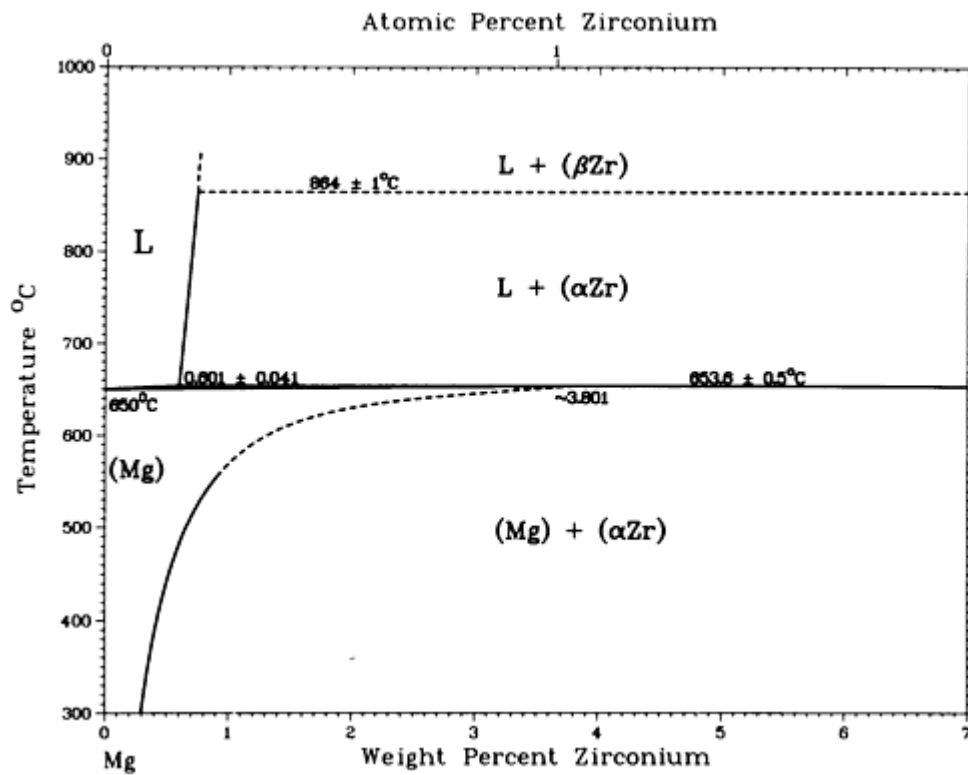

Mg-Zr phase diagram

Mg-Zr crystallographic data

Phase	Composition, wt% Zr	Pearson symbol	Space group
(Mg)	0 to ~3.801	<i>hP2</i>	<i>P6₃/mmc</i>

(αZr)	100	$hP2$	$P6_3/mmc$
(βZr)	100	$cI2$	$Im\bar{3}m$

Mn (Manganese) Binary Alloy Phase Diagrams

Introduction

THIS ARTICLE includes systems where manganese is the first-named element in the binary pair. Additional binary systems that include manganese are provided in the following locations in this Volume:

- “Al-Mn (Aluminum - Manganese)” in the article “Al (Aluminum) Binary Alloy Phase Diagrams.”
- “As-Mn (Arsenic - Manganese)” in the article “As (Arsenic) Binary Alloy Phase Diagrams.”
- “Au-Mn (Gold - Manganese)” in the article “Au (Gold) Binary Alloy Phase Diagrams.”
- “B-Mn (Boron - Manganese)” in the article “B (Boron) Binary Alloy Phase Diagrams.”
- “Bi-Mn (Bismuth - Manganese)” in the article “Bi (Bismuth) Binary Alloy Phase Diagrams.”
- “C-Mn (Carbon - Manganese)” in the article “C (Carbon) Binary Alloy Phase Diagrams.”
- “Ce-Mn (Cerium - Manganese)” in the article “Ce (Cerium) Binary Alloy Phase Diagrams.”
- “Co-Mn (Cobalt - Manganese)” in the article “Co (Cobalt) Binary Alloy Phase Diagrams.”
- “Cr-Mn (Chromium - Manganese)” in the article “Cr (Chromium) Binary Alloy Phase Diagrams.”
- “Cu-Mn (Copper - Manganese)” in the article “Cu (Copper) Binary Alloy Phase Diagrams.”
- “Dy-Mn (Dysprosium - Manganese)” in the article “Dy (Dysprosium) Binary Alloy Phase Diagrams.”
- “Er-Mn (Erbium - Manganese)” in the article “Er (Erbium) Binary Alloy Phase Diagrams.”
- “Fe-Mn (Iron - Manganese)” in the article “Fe (Iron) Binary Alloy Phase Diagrams.”
- “Ga-Mn (Gallium - Manganese)” in the article “Ga (Gallium) Binary Alloy Phase Diagrams.”
- “Gd-Mn (Gadolinium - Manganese)” in the article “Gd (Gadolinium) Binary Alloy Phase Diagrams.”
- “Ge-Mn (Germanium - Manganese)” in the article “Ge (Germanium) Binary Alloy Phase Diagrams.”>
- “Hf-Mn (Hafnium - Manganese)” in the article “Hf (Hafnium) Binary Alloy Phase Diagrams.”
- “Ho-Mn (Holmium - Manganese)” in the article “Ho (Holmium) Binary Alloy Phase Diagrams.”
- “In-Mn (Indium - Manganese)” in the article “In (Indium) Binary Alloy Phase Diagrams.”
- “La-Mn (Lanthanum - Manganese)” in the article “La (Lanthanum) Binary Alloy Phase Diagrams.”
- “Mg-Mn (Magnesium - Manganese)” in the article “Mg (Magnesium) Binary Alloy Phase Diagrams.”

Mn-Mo (Manganese - Molybdenum)

From [Molybdenum] 12

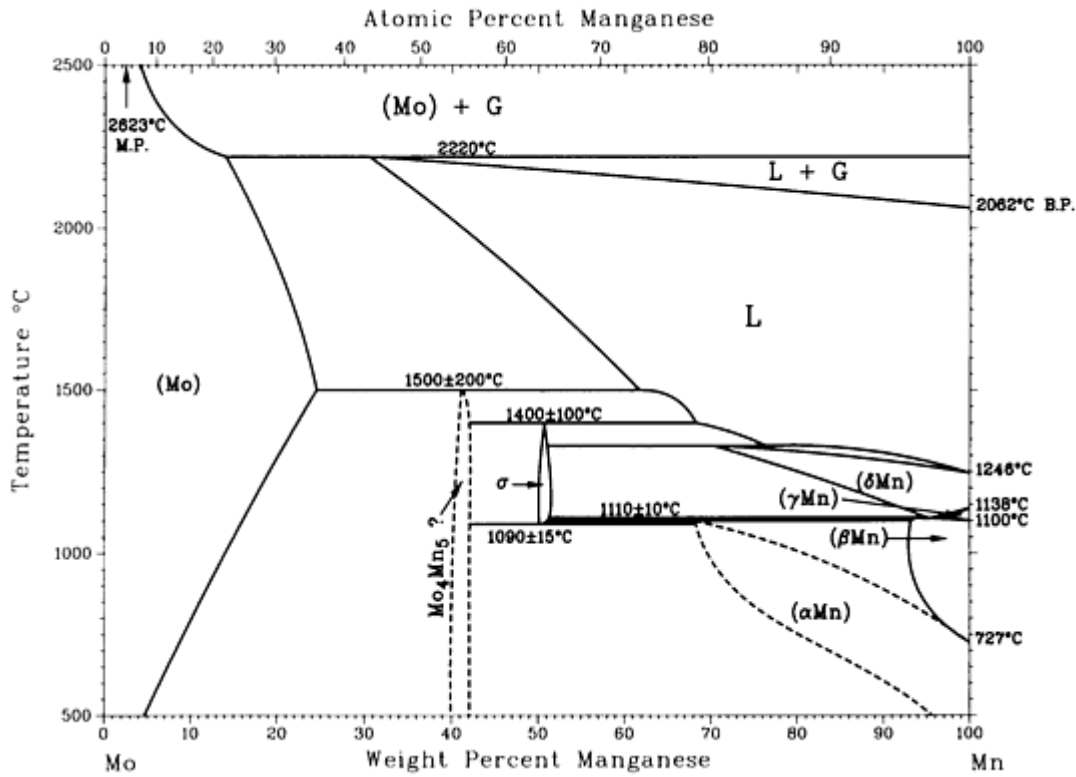

Mn-Mo phase diagram

Mn-Mo crystallographic data

Phase	Composition, wt% Mn	Pearson symbol	Space group
(Mo)	0 to 25	<i>cI2</i>	<i>Im</i> $\bar{3}m$
Mo ₄ Mn ₅	~42	<i>hR39?</i>	...
σ	~50	<i>tP30</i>	<i>P4</i> ₂ <i>/mnm</i>
(δMn)	71 to 100	<i>cI2</i>	<i>Im</i> $\bar{3}m$
(γMn)	97 to 100	<i>cF4</i>	<i>Fm</i> $\bar{3}m$
(βMn)	78 to 100	<i>cP20</i>	<i>P4</i> ₁ <i>32</i>

(α Mn)	~68 to 100	<i>cI58</i>	$I\bar{4}3m$
----------------	------------	-------------	--------------

Reference cited in this section

12. [Molybdenum]: L. Brewer, *Molybdenum: Physico-Chemical Properties of Its Compounds and Alloys*, O. Kubaschewski, Ed., Atomic Energy Review Special Issue No.7, International Atomic Energy Agency, Vienna (1980).

Mn-N (Manganese - Nitrogen)

N.A. Gokcen, 1990

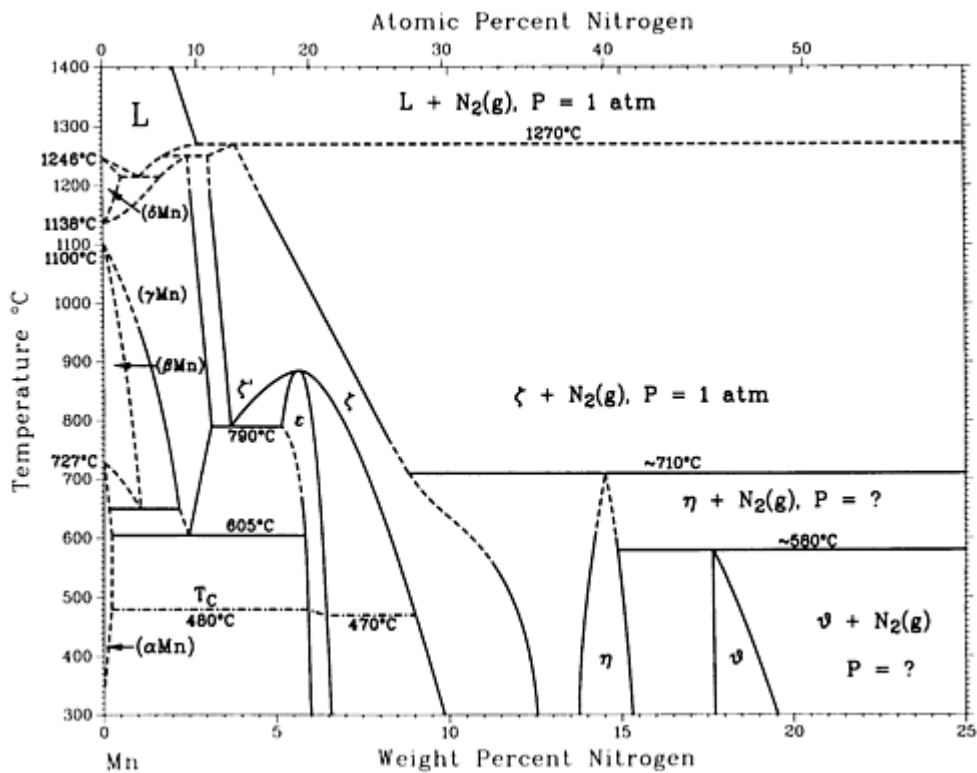

Mn-N phase diagram

Mn-N crystallographic data

Phase	Composition, wt% N	Pearson symbol	Space group
(δ Mn)	0 to ~0.5	<i>cI2</i>	$Im\bar{3}m$
(γ Mn)	0 to 3.2	<i>cF4</i>	$Fm\bar{3}m$
(β Mn)	0 to ~1	<i>cP20</i>	$P4_132$

(α Mn)	0 to \sim 0.13	<i>cI58</i>	$I\bar{4}3m$
ϵ or Mn ₄ N	5.1 to 6.6	<i>cF5</i>	$Fm\bar{3}m$
ζ	\sim 13	<i>hP12</i>	$P6_322$
ζ or Mn ₁₂ N ₅	\sim 9	<i>hP12</i>	$P6_322$
ζ or Mn ₂ N	11.0	<i>hP3</i>	$P6_3/mmc$
ζ or Mn ₂ N	\sim 11.2	<i>oP12</i>	$Pbcn$
η or Mn ₆ N ₄	\sim 14 to 15	...	$I4/mmm$
θ or Mn ₆ N ₅	\sim 17.7 to 20

Mn-Nd (Manganese - Neodymium)

H. Okamoto, 1992

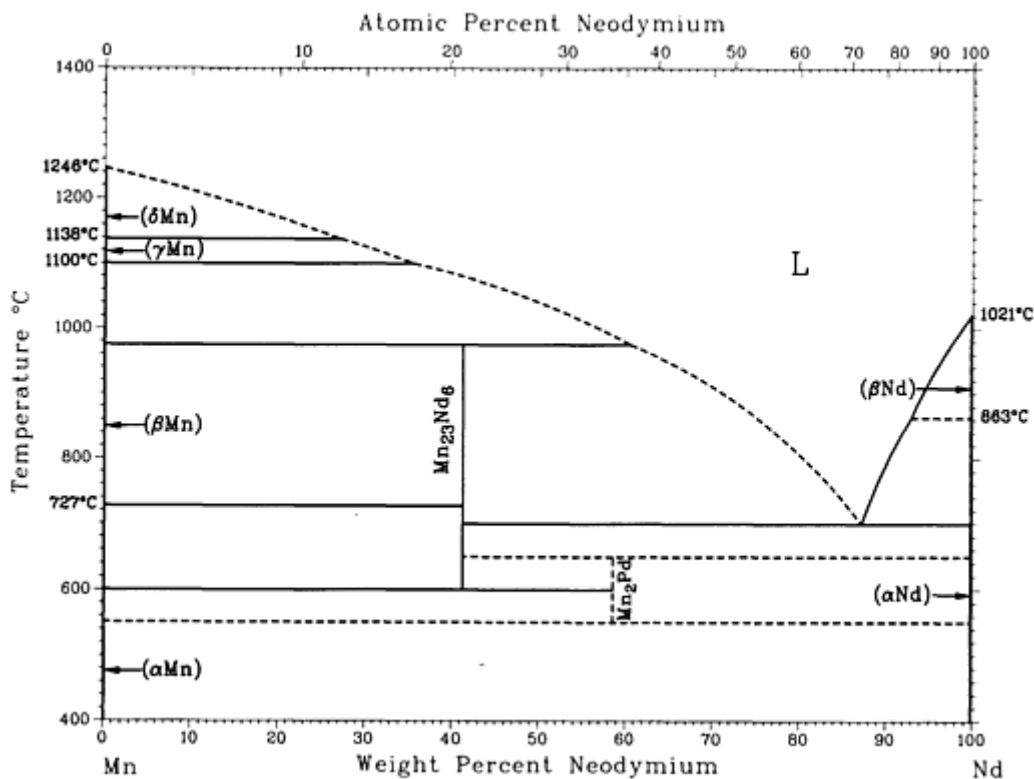

Mn-Nd phase diagram

Mn-Nd crystallographic data

Phase	Composition, wt% Nd	Pearson symbol	Space group
(δ Mn)	0	<i>cI2</i>	<i>Im$\bar{3}m$</i>
(γ Mn)	0	<i>cF4</i>	<i>Fm$\bar{3}m$</i>
(β Mn)	0	<i>cP20</i>	<i>P4$_1$$\bar{3}2$</i>
(α Mn)	0	<i>cI58</i>	<i>I$\bar{4}3m$</i>
Mn ₂₃ Nd ₆	40.7	<i>cF116</i>	<i>I4/mmm</i>
β Mn ₂ Nd	56.7	<i>hP12</i>	<i>P6$_3$/mmc</i>
α Mn ₂ Nd	56.7	<i>m**</i>	...
(β Nd)	100	<i>cI2</i>	<i>Im$\bar{3}m$</i>
(α Nd)	100	<i>hP4</i>	<i>P6$_3$/mmc</i>

Mn-Ni (Manganese - Nickel)

N.A. Gokcen, 1991

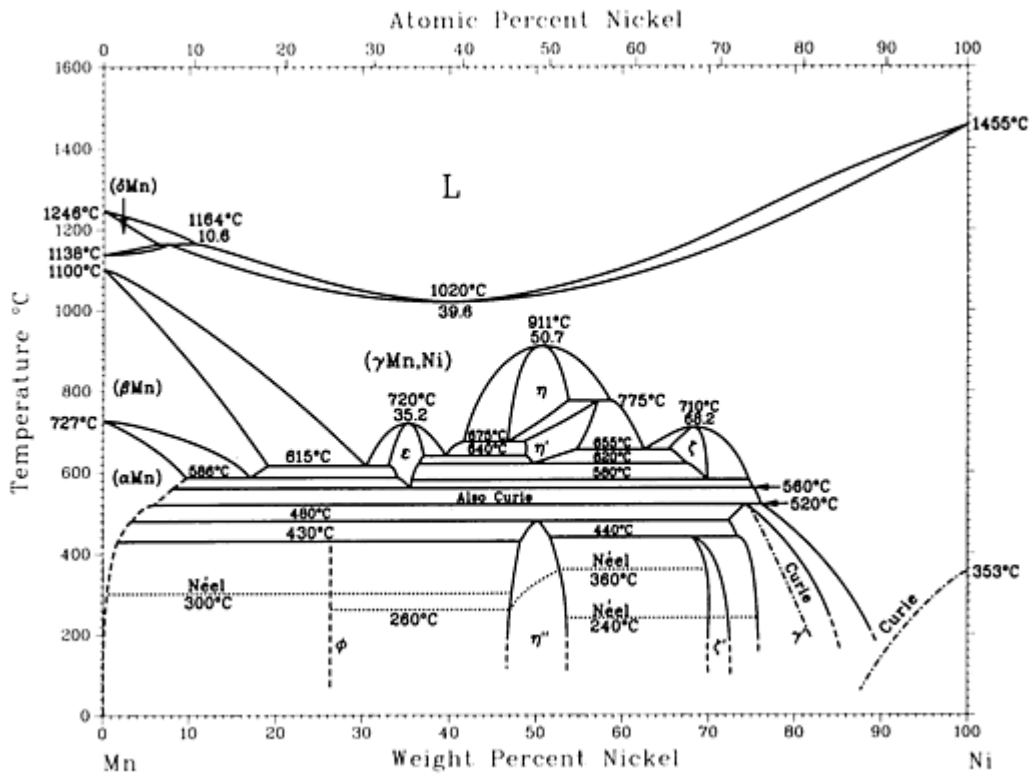

Mn-Ni phase diagram

Mn-Ni crystallographic data

Phase	Composition, wt% Ni	Pearson symbol	Space group
(δ Mn)	0 to 6	<i>cI12</i>	<i>Im$\bar{3}m$</i>
(γ Mn, Ni)	0 to 100	<i>cF4</i>	<i>Fm$\bar{3}m$</i>
(β Mn)	0 to 19	<i>cP20</i>	<i>P4$_1$32</i>
(α Mn)	0 to 10	<i>cI58</i>	<i>I$\bar{4}3m$</i>
ϕ	26
ϵ	34 to 38

$\eta^{(a)}$	47 to 54	<i>cP2</i>	$Pm\bar{3}m$
η'	49 to 57.1	<i>tP4</i>	$P4/mmm$
ζ	66 to 70
ζ'	~71
γ'	72 to 86	<i>cP4</i>	$Pm\bar{3}m$

(a) At 745 °C; this phase cannot be retained by quenching.

Mn-O (Manganese - Oxygen)

H. Okamoto, 1990

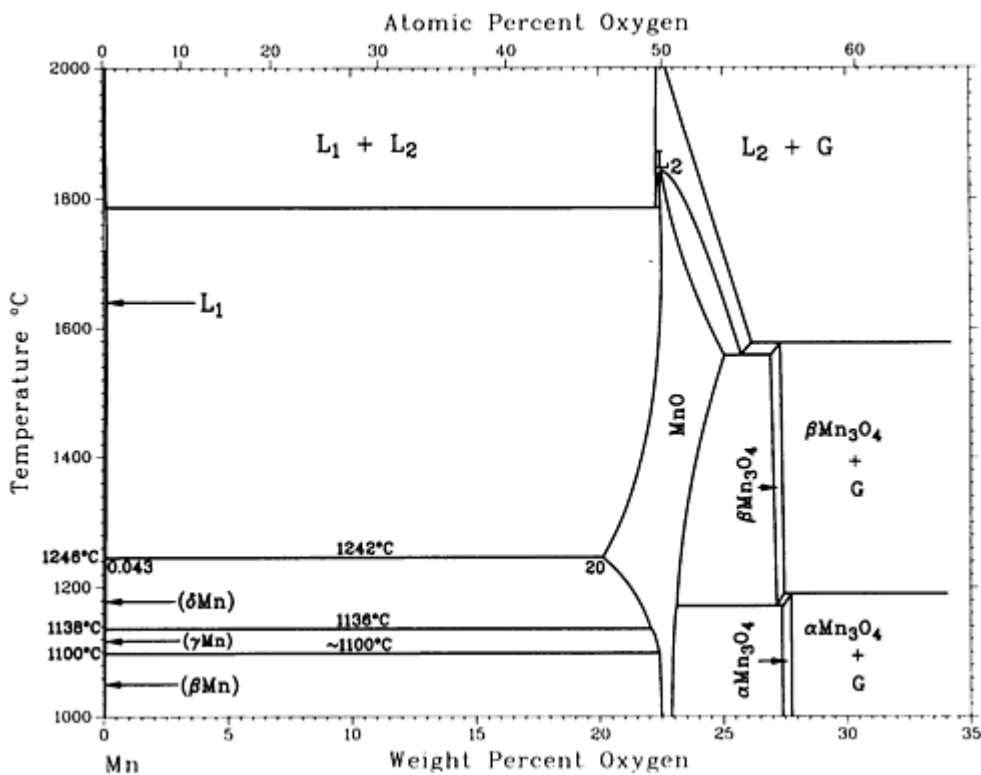

Mn-O phase diagram

Mn-O crystallographic data

Phase	Composition, wt% O	Pearson symbol	Space group

(δMn)	0	$cI2$	$Im\bar{3}m$
(γMn)	0	$cF4$	$Fm\bar{3}m$
(βMn)	0	$cP20$	$P4_132$
(αMn)	0	$cI58$	$I\bar{4}3m$
MnO	20 to 25	$cF8$	$Fm\bar{3}m$
$\beta\text{Mn}_3\text{O}_4$	~ 28
$\alpha\text{Mn}_3\text{O}_4$	~ 28	$tI28$	$I4_1/amd$

Mn-P (Manganese - Phosphorus)

J. Berak and T. Heumann, 1950

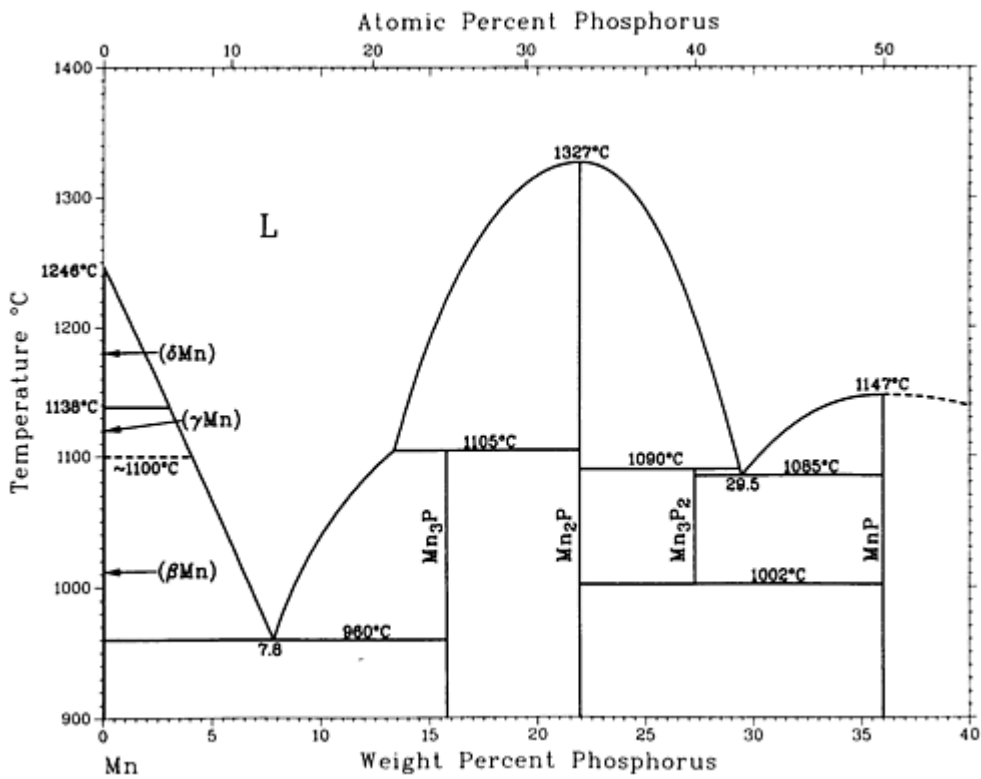

Mn-P phase diagram

Mn-P crystallographic data

Phase	Composition, wt% P	Pearson symbol	Space group
(δ Mn)	~0	<i>cI2</i>	<i>Im</i> $\bar{3}m$
(γ Mn)	~0	<i>cF4</i>	<i>Fm</i> $\bar{3}m$
(β Mn)	~0	<i>cP20</i>	<i>P4</i> $\bar{3}2$
Mn ₃ P	16	<i>tI32</i>	<i>I</i> $\bar{4}$
Mn ₂ P	22.0	<i>hP9</i>	<i>P</i> $\bar{6}2m$
Mn ₃ P ₂	27
MnP	36.1	<i>oP8</i>	<i>Pnma</i>
Other reported phase			
MnP ₄	69	<i>aP10</i> <i>aP30</i>	<i>P</i> $\bar{1}$ <i>P</i> $\bar{1}$

Mn-Pd (Manganese - Palladium)

From [Hansen] 6

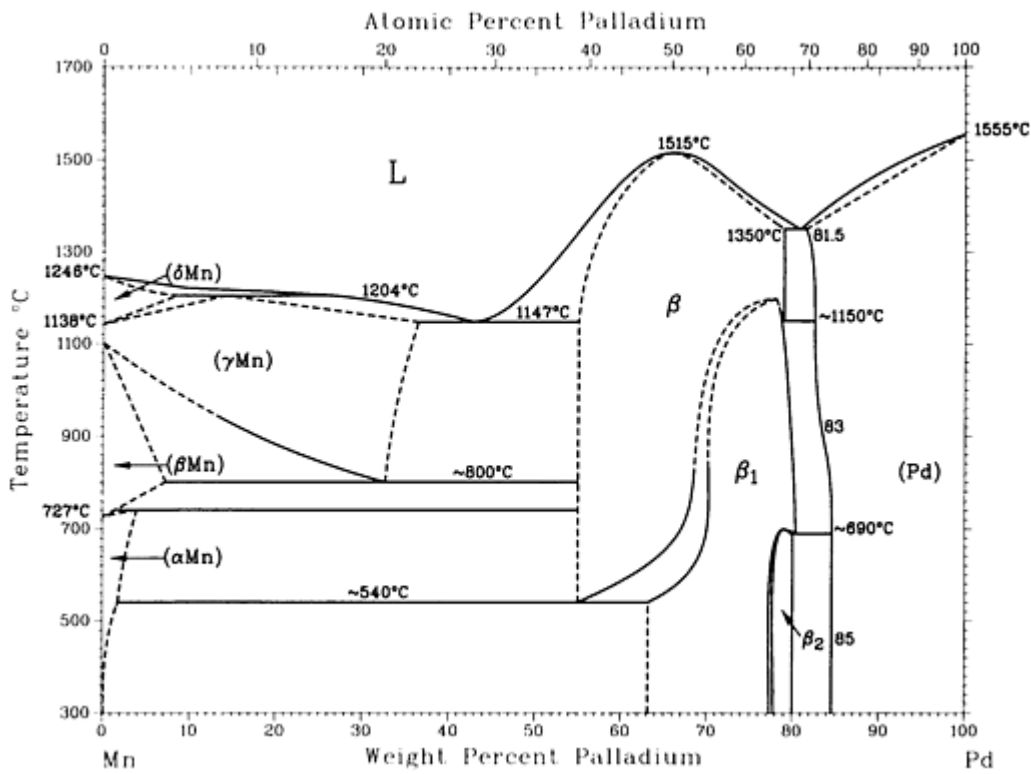

Mn-Pd phase diagram

Mn-Pd crystallographic data

Phase	Composition, wt% Pd	Pearson symbol	Space group
(δ Mn)	0 to ~9	<i>cI2</i>	<i>Im$\bar{3}m$</i>
(γ Mn)	0 to ~35	<i>cF4</i>	<i>Fm$\bar{3}m$</i>
(β _{Mn})	0 to ~8	<i>cP20</i>	<i>P4₁32</i>
(α Mn)	0 to ~4	<i>cI58</i>	<i>I$\bar{4}3m$</i>
β _(MnPd)	~54 to <79	<i>cP2</i>	<i>Pm$\bar{3}m$</i>
β ₁	~63 to <81
β ₂	~77.5 to 80.1
(Pd)	81.5 to 100	<i>cF4</i>	<i>Fm$\bar{3}m$</i>

Other reported phases			
Mn ₂ Pd ₃ (HT)	~74	<i>tP2</i>	<i>P4/mmm</i>
Mn ₂ Pd ₃ (LT)	~74	<i>t**</i>	...
Mn ₃ Pd ₅	~76.4	<i>oC16</i>	<i>Cmmm</i>
Mn ₁₁ Pd ₂₁	~78.6	<i>tP32</i>	<i>P4/mmm</i>
MnPd ₃	85	<i>tI16</i>	<i>I4mm</i>

Reference cited in this section

6. [Hansen]: M. Hansen and K. Anderko, *Constitution of Binary Alloys*, McGraw-Hill, New York or General Electric Co., Business Growth Services, Schenectady, New York (1958).

Mn-Pr (Manganese - Praseodymium)

H. Okamoto, 1990

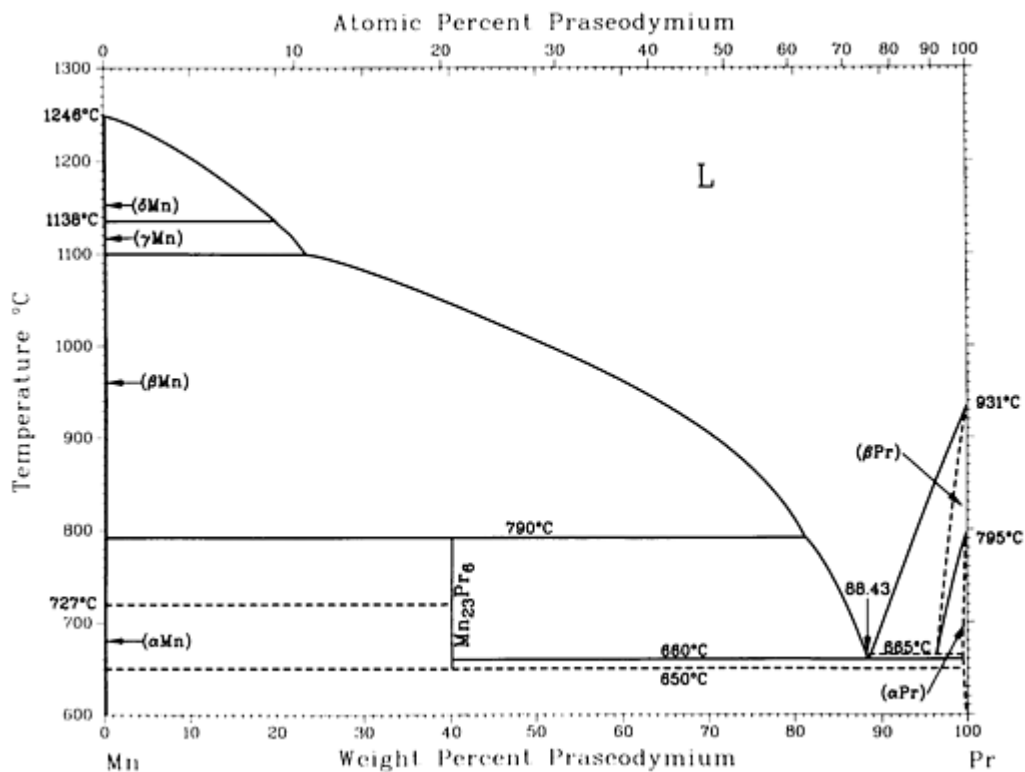

Mn-Pr phase diagram

Mn-Pr crystallographic data

Phase	Composition, wt% Pr	Pearson symbol	Space group
(δ Mn)	0	<i>cI2</i>	<i>Im</i> $\bar{3}m$
(γ Mn)	0	<i>cF4</i>	<i>Fm</i> $\bar{3}m$
(β Mn)	0	<i>cP20</i>	<i>P4</i> $\bar{3}2$
(α Mn)	0	<i>cI58</i>	<i>I</i> $\bar{4}3m$
Mn ₂₃ Pr ₆	40.1	<i>cF116</i>	<i>Fm</i> $\bar{3}m$
(β Pr)	~96.5 to 100	<i>cI2</i>	<i>Im</i> $\bar{3}m$
(α Pr)	? to 100	<i>hP4</i>	<i>P6</i> ₃ / <i>mmc</i>
Metastable phase			
Mn ₂ Pr	56.1	<i>hP12</i>	<i>P6</i> ₃ / <i>mmc</i>

Mn-Pu (Manganese - Plutonium)

S.T. Konobeevsky, 1955

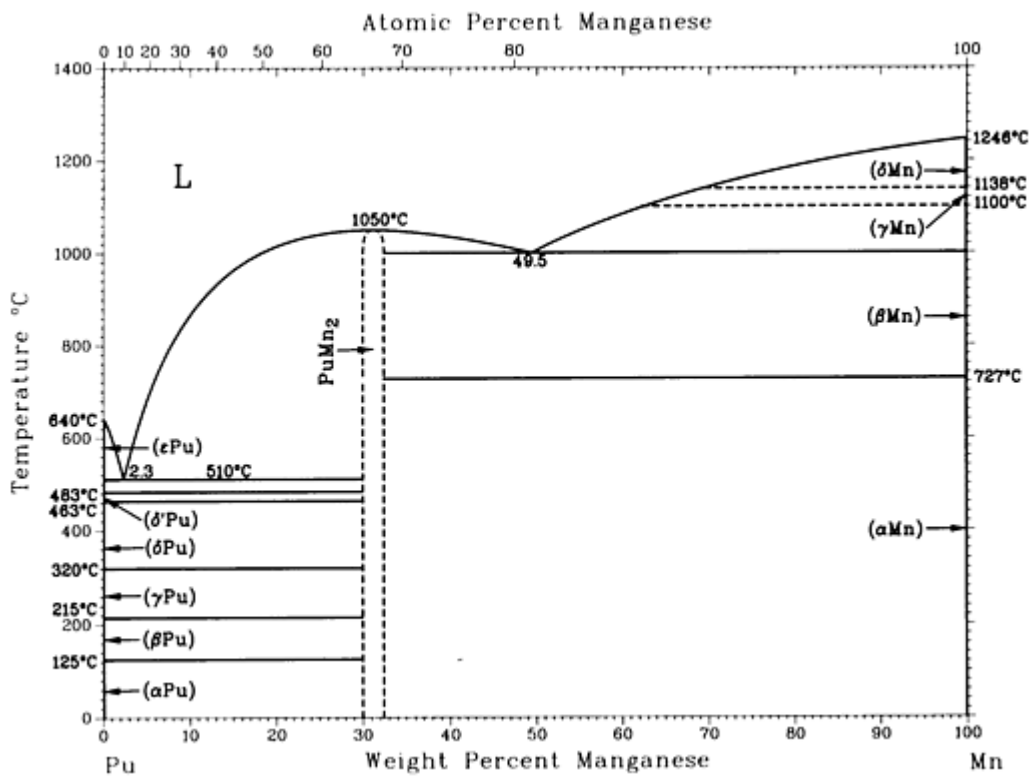

Mn-Pu phase diagram

Mn-Pu crystallographic data

Phase	Composition, wt% Mn	Pearson symbol	Space group
(εPu)	~0	<i>cI2</i>	<i>Im</i> $\bar{3}m$
(δ'Pu)	~0	<i>tI2</i>	<i>I4/mmm</i>
(δPu)	~0	<i>cF4</i>	<i>Fm</i> $\bar{3}m$
(γPu)	~0	<i>oF8</i>	<i>Fddd</i>
(βPu)	~0	<i>mC34</i>	<i>C2/m</i>
(αPu)	~0	<i>mP16</i>	<i>P2₁/m</i>
PuMn ₂	~31.1	<i>cF24</i>	<i>Fd</i> $\bar{3}m$
(δMn)	~100	<i>cI2</i>	<i>Im</i> $\bar{3}m$

(γ_{Mn})	~ 100	$cF4$	$Fm\bar{3}m$
(β_{Mn})	~ 100	$cP20$	$P4_132$
(α_{Mn})	~ 100	$cI58$	$I\bar{4}3m$

Mn-Sb (Manganese - Antimony)

H. Okamoto, 1990

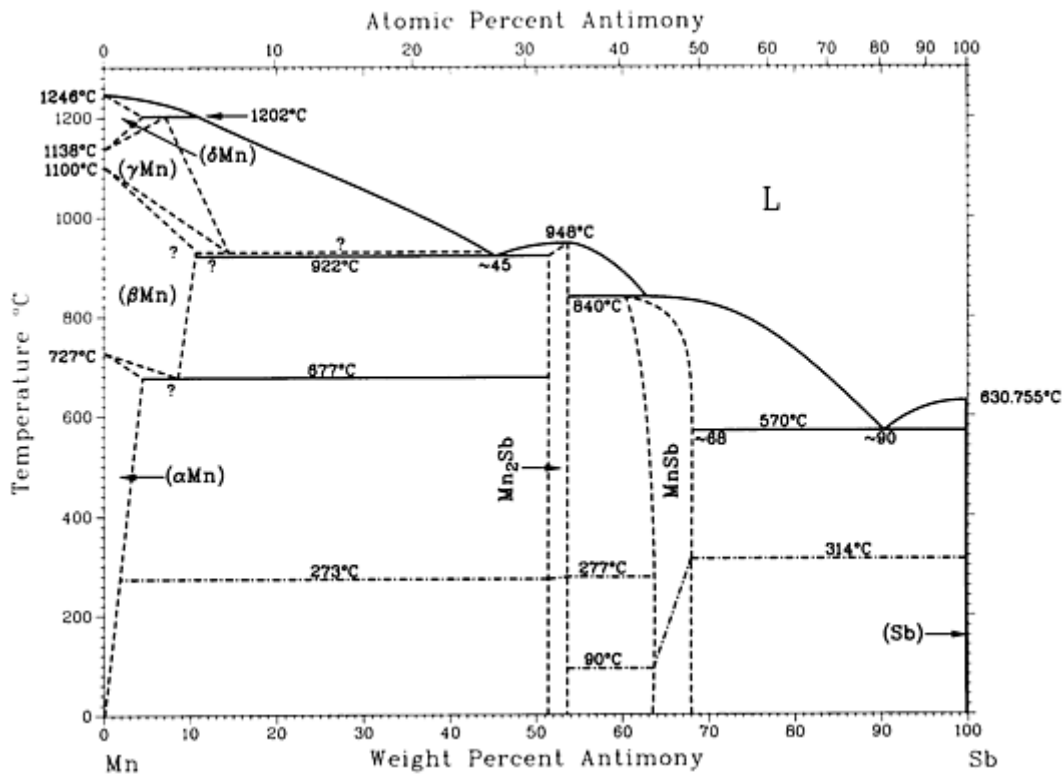

Mn-Sb phase diagram

Mn-Sb crystallographic data

Phase	Composition, wt% Sb	Pearson symbol	Space group
(δ_{Mn})	0 to ?	$cI2$	$Im\bar{3}m$
(γ_{Mn})	0 to ?	$cF4$	$Fm\bar{3}m$
(β_{Mn})	0 to ?	$cP20$	$P4_132$

(α Mn)	0 to ?	<i>cI58</i>	$I\bar{4}3m$
Mn ₂ Sb	~52.5	<i>tP6</i>	<i>P4/nmm</i>
MnSb	~61 to ~68	<i>hP4</i>	<i>P6₃/mmc</i>
(Sb)	100	<i>hR2</i>	$R\bar{3}m$

Mn-Si (Manganese - Silicon)

H. Okamoto, 1991

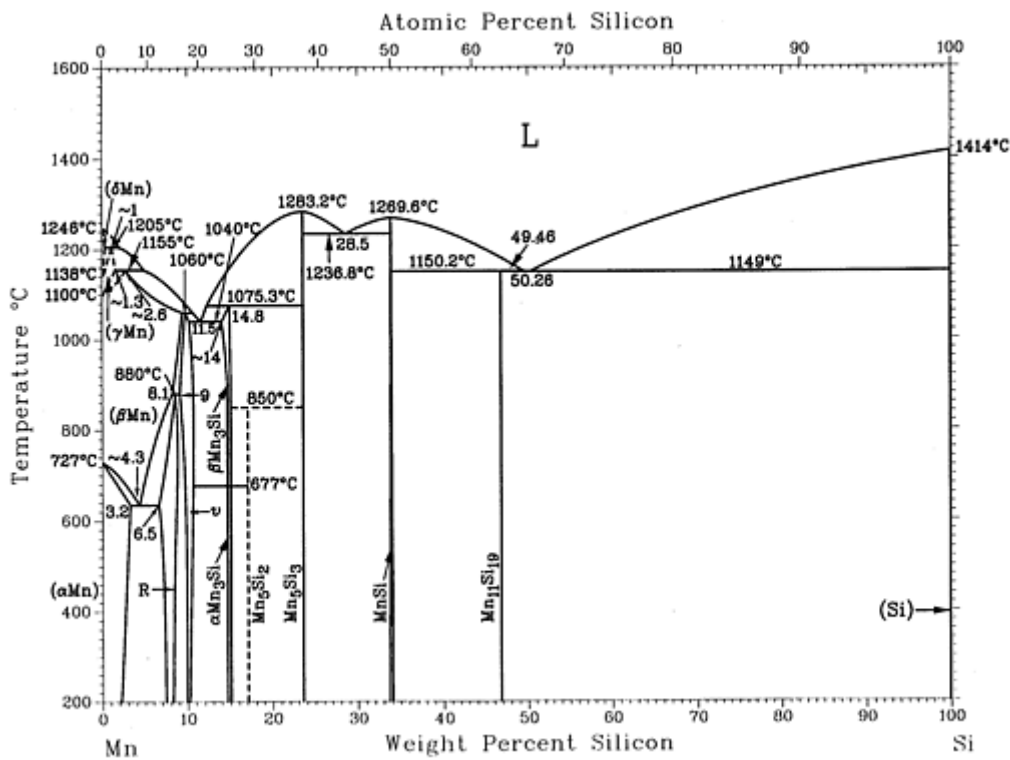

Mn-Si phase diagram

Mn-Si crystallographic data

Phase	Composition, wt% Si	Pearson symbol	Space group
(δ Mn)	0 to ~0.1	<i>cI2</i>	$Im\bar{3}m$
(γ Mn)	0 to ~1.3	<i>cF4</i>	$Fm\bar{3}m$

(β_{Mn})	0 to \sim 9.3	<i>cP</i> 20	<i>P4</i> $\bar{3}$ 2
(α_{Mn})	0 to 3.2	<i>cI</i> 58	<i>I</i> $\bar{4}$ 3 <i>m</i>
R	6.5 to 8.72	<i>hR</i> 53	<i>R</i> $\bar{3}$
ν	9.0 to 10.55	<i>oI</i> 186	<i>I</i> <i>mmm</i>
$\beta_{\text{Mn}_3\text{Si}}$	\sim 14 to 15.0	<i>cF</i> 16	<i>Fm</i> $\bar{3}$ <i>m</i>
$\alpha_{\text{Mn}_3\text{Si}}$	14.6 to 15.0		
Mn_5Si_2	17.0	<i>tP</i> 56	<i>P4</i> $\bar{2}$ $\bar{1}$ 2
Mn_5Si_3	23.5	<i>hP</i> 16	<i>P6</i> $\bar{3}$ / <i>mcm</i>
MnSi	33.4 to 34.0	<i>cP</i> 8	<i>P2</i> $\bar{1}$ 3
$\text{Mn}_{11}\text{Si}_{19}$	\sim 46.9	<i>tP</i> 120	<i>P</i> $\bar{4}$ <i>n</i> 2
(Si)	100	<i>cF</i> 8	<i>Fd</i> $\bar{3}$ <i>m</i>

Mn-Sm (Manganese - Samarium)

H.R. Kirchmayr and W. Lugscheider, 1970

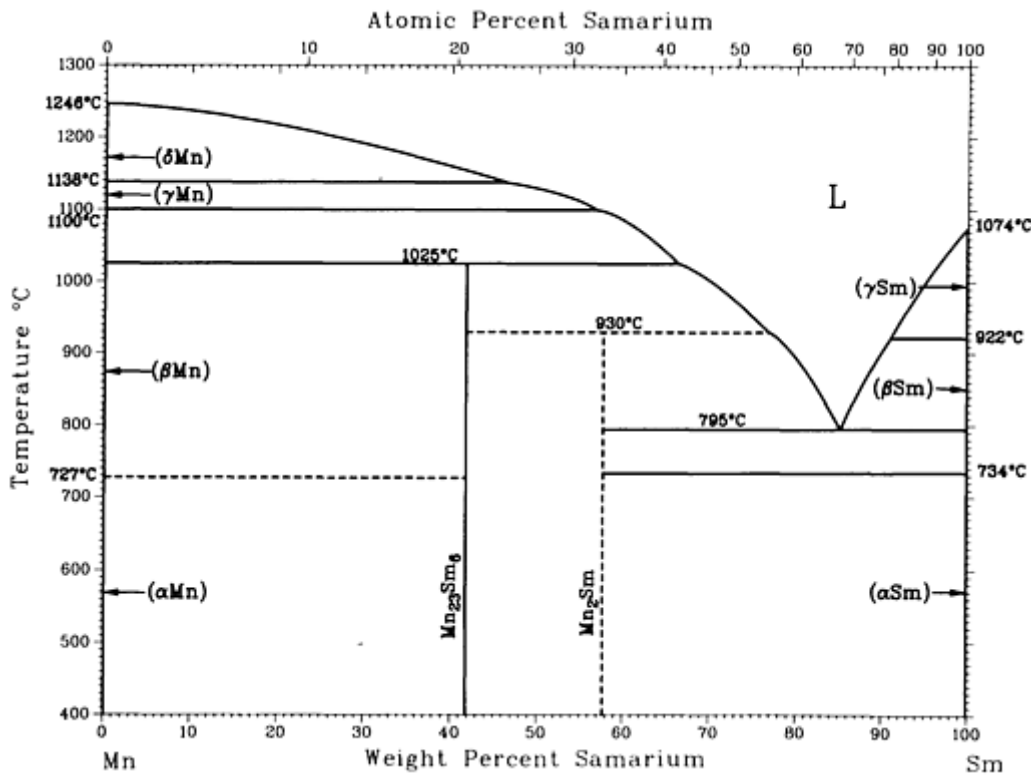

Mn-Sm phase diagram

Mn-Sm crystallographic data

Phase	Composition, wt% Sm	Pearson symbol	Space group
(δ Mn)	~0	<i>cI2</i>	<i>Im</i> $\bar{3}m$
(γ Mn)	~0	<i>cF4</i>	<i>Fm</i> $\bar{3}m$
(β Mn)	~0	<i>cP20</i>	<i>P4</i> ₁ <i>32</i>
(α Mn)	~0	<i>cI58</i>	<i>I</i> $\bar{4}3m$
Mn ₂₃ Sm ₆	~41.7	<i>cF116</i>	<i>Fm</i> $\bar{3}m$
Mn ₂ Sm	57.7	<i>hP12</i> <i>cF24</i>	<i>P6</i> ₃ / <i>m</i> <i>mc</i> <i>Fd</i> $\bar{3}m$
(δ Sm)	~100	<i>cI2</i>	<i>Im</i> $\bar{3}m$

(β_{Sn})	~ 100	$hP2$	$P6_3/mmc$
(α_{Sn})	~ 100	$hR13$	$R\bar{3}m$

Mn-Sn (Manganese - Tin)

H. Okamoto, 1990

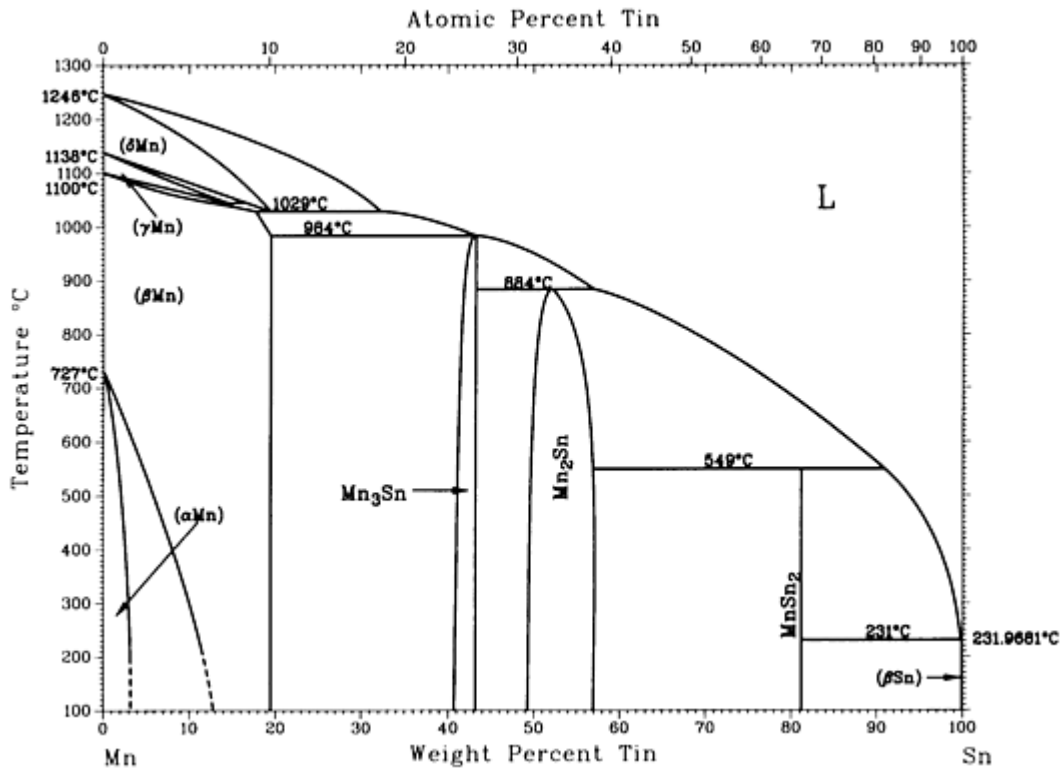

Mn-Sn phase diagram

Mn-Sn crystallographic data

Phase	Composition, wt% Sn	Pearson symbol	Space group
(δ_{Mn})	0 to 19	$cI2$	$Im\bar{3}m$
(γ_{Mn})	0 to 14	$cF4$	$Fm\bar{3}m$
(β_{Mn})	0 to 21	$cP20$	$P4_132$
(α_{Mn})	0 to 2	$cI58$	$I\bar{4}3m$

Mn ₃ Sn	41 to 43	<i>hP8</i>	<i>P6₃/mmc</i>
Mn ₂ Sn	49 to 57	<i>hP6</i>	<i>P6₃/mmc</i>
MnSn ₂	81.2	<i>tI12</i>	<i>I4/mcm</i>
(β Sn)	100	<i>tI2</i>	<i>I4₁/amd</i>
(α Sn)	100	<i>cF8</i>	<i>Fd$\bar{3}m$</i>

Mn-Ti (Manganese - Titanium)

J.L. Murray, 1987

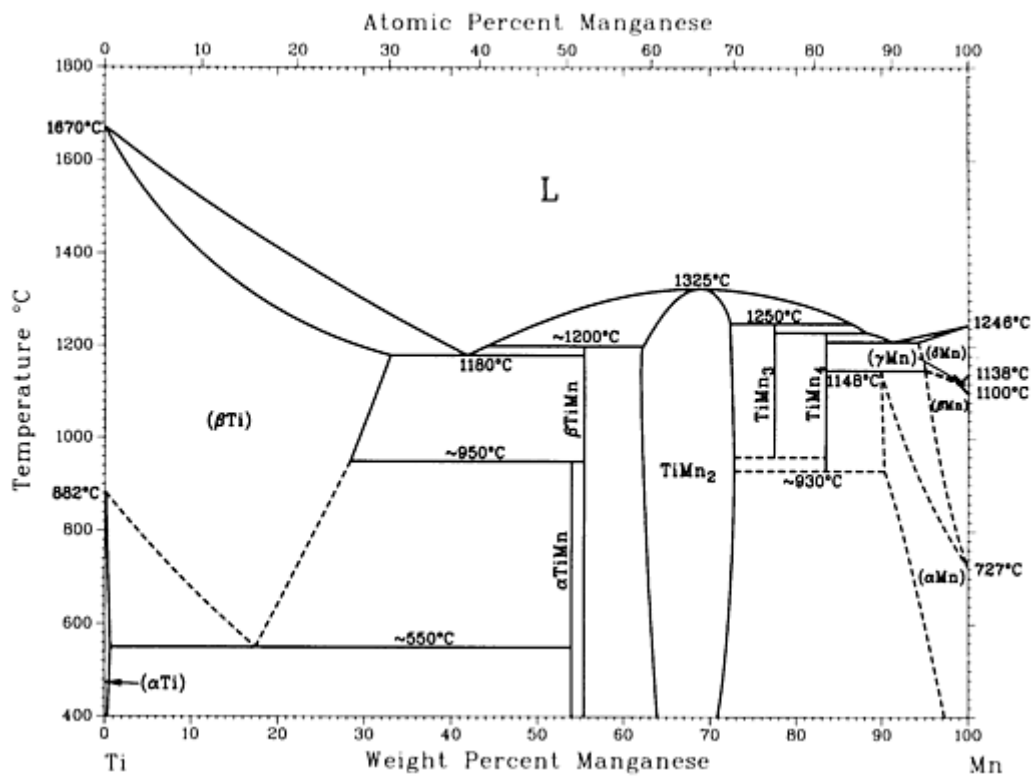

Mn-Ti phase diagram

Mn-Ti crystallographic data

Phase	Composition, wt% Mn	Pearson symbol	Space group
(β Ti)	0 to 33	<i>cI2</i>	<i>Im$\bar{3}m$</i>

(αTi)	0 to 0.5	<i>hP2</i>	<i>P6₃/mmc</i>
αTiMn	53.9	<i>t*58</i>	...
β_{TiMn}	55	(a)	...
TiMn_2	63 to 73	<i>hP12</i>	<i>P6₃/mmc</i>
TiMn_3	78	(b)	...
TiMn_4	83.5	<i>hR53</i>	<i>R$\bar{3}m$</i>
(δMn)	92 to 100	<i>cI2</i>	<i>Im$\bar{3}m$</i>
(γMn)	99.5 to 100	<i>cF4</i>	<i>Fm$\bar{3}m$</i>
(β_{Mn})	95 to 100	<i>cP20</i>	<i>P4₁32</i>
(αMn)	89 to 100	<i>cI58</i>	<i>I$\bar{4}3m$</i>
$(\alpha'\text{Ti})$	(c)	<i>hP2</i>	<i>P6₃/mmc</i>
ω	(c)	<i>hP3</i>	<i>P6/mmm</i>

(a) Undetermined.

(b) Orthorhombic.

(c) Metastable phase

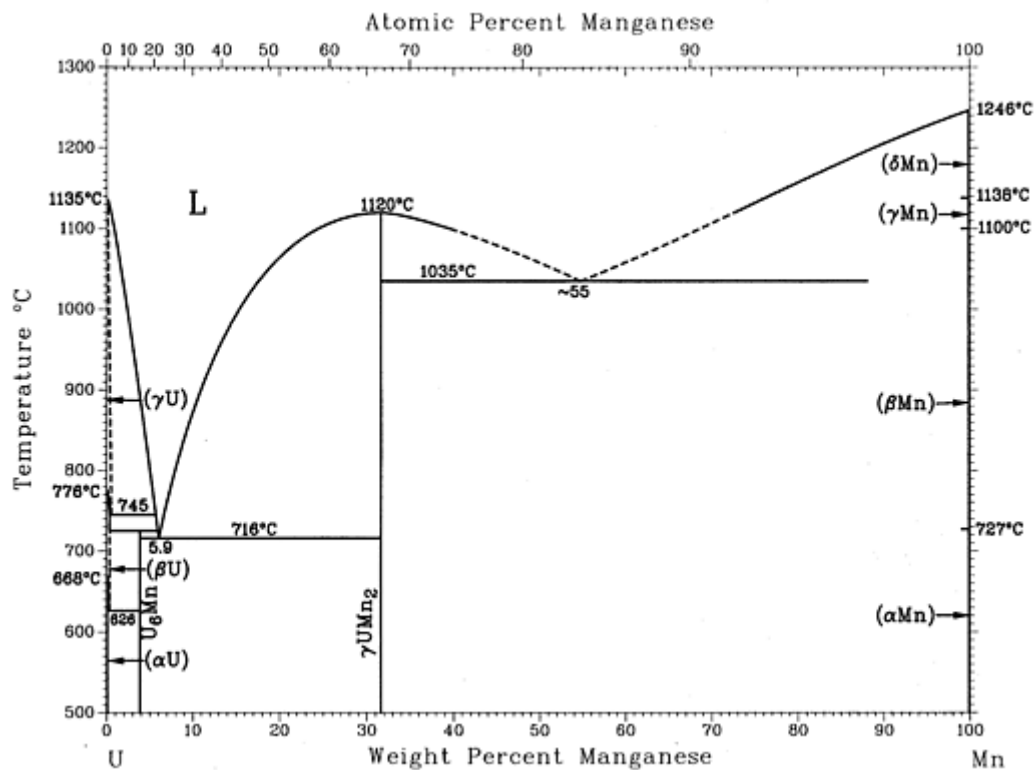

Mn-U phase diagram

Mn-U crystallographic data

Phase	Composition, wt% Mn	Pearson symbol	Space group
(γU)	0 to ~0.5	<i>cI2</i>	<i>Im</i> $\bar{3}m$
(βU)	0 to ~0.4	<i>tP30</i>	<i>P4</i> ₂ <i>/mnm</i>
(αU)	~0	<i>oC4</i>	<i>Cmcm</i>
U ₆ Mn	~3.7	<i>tI28</i>	<i>I4/mcm</i>
γUMn ₂	31.6	<i>oI12</i>	<i>Imma</i>
βUMn ₂	31.6	<i>cF24</i>	<i>Fd</i> $\bar{3}m$
αUMn ₂	31.6	<i>mC24</i>	<i>C2/m</i>

(δ Mn)	~ 100	$cI2$	$Im\bar{3}m$
(γ Mn)	~ 100	$cF4$	$Fm\bar{3}m$
(β Mn)	~ 100	$cP20$	$P4_132$
(α Mn)	~ 100	$cI58$	$I\bar{4}3m$

Reference cited in this section

6. [Hansen]: M. Hansen and K. Anderko, *Constitution of Binary Alloys*, McGraw-Hill, New York or General Electric Co., Business Growth Services, Schenectady, New York (1958).

Mn-V (Manganese - Vanadium)

H. Okamoto, 1992

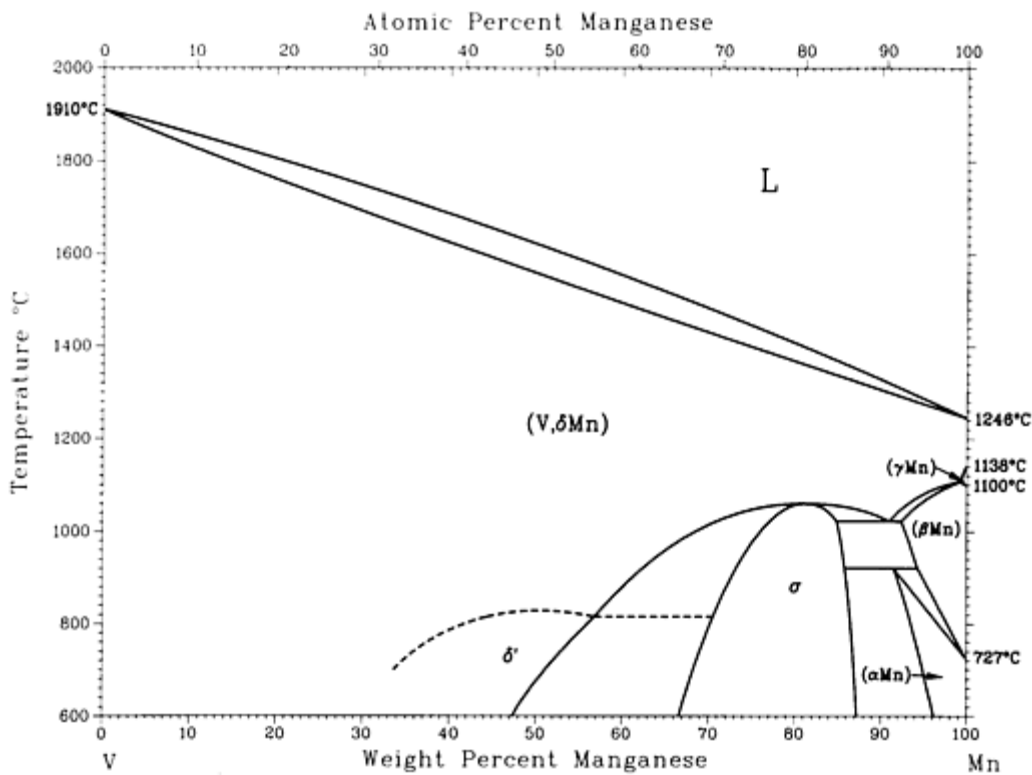

Mn-V phase diagram

Mn-V crystallographic data

Phase	Composition, wt% Mn	Pearson symbol	Space group
-------	---------------------	----------------	-------------

(V, δ_{Mn})	0 to 100	<i>cI2</i>	<i>Im$\bar{3}m$</i>
δ'	? to ~ 57	<i>cP2</i>	<i>Pm$\bar{3}m$</i>
σ	? to ?	<i>tP30</i>	<i>P4$_2$/mnm</i>
(γ_{Mn})	99 to 100	<i>cF4</i>	<i>Fm$\bar{3}m$</i>
(β_{Mn})	93 to 100	<i>cP20</i>	<i>P4$_1$32</i>
(α_{Mn})	92 to 100	<i>cI58</i>	<i>I$\bar{4}3m$</i>

Mn-Y (Manganese - Yttrium)

A. Palenzona and S. Cirafici, 1991

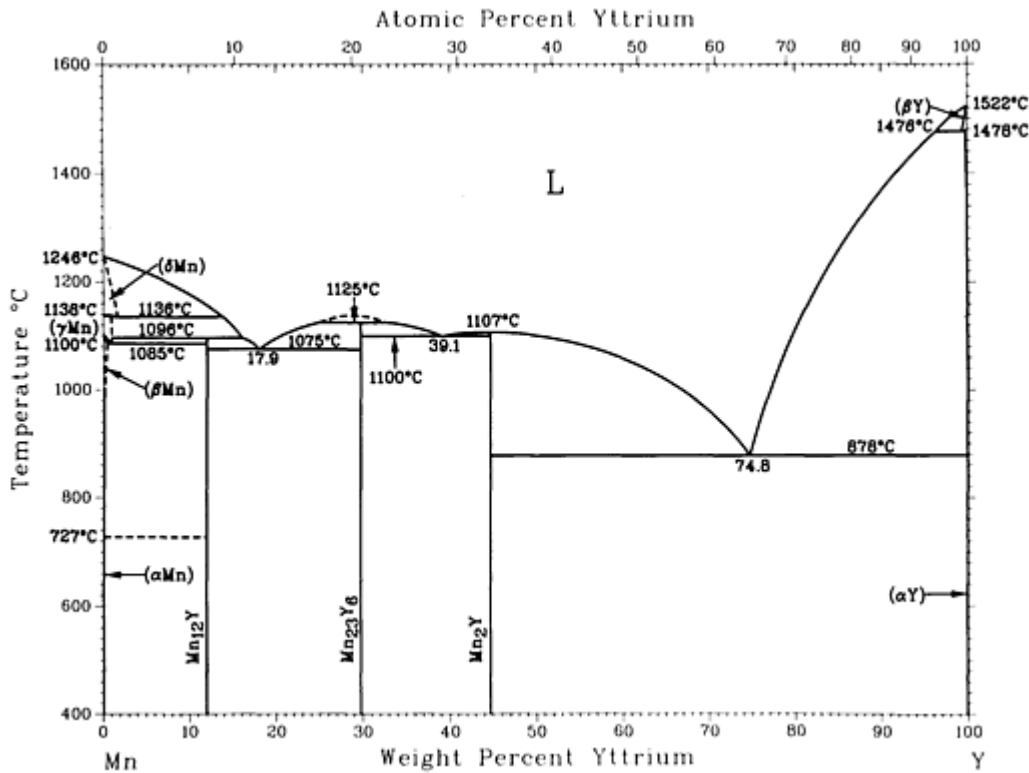

Mn-Y phase diagram

Mn-Y crystallographic data

Phase	Composition, wt% Y	Pearson symbol	Space group

(δMn)	0	$cI2$	$Im\bar{3}m$
(γMn)	0	$cF4$	$Fm\bar{3}m$
(βMn)	0	$cP20$	$P4_132$
(αMn)	0	$cI58$	$I\bar{4}3m$
Mn_{12}Y	11.9	$tI26$	$I4/mmm$
Mn_{23}Y_6	29.7	$cF116$	$Fm\bar{3}m$
Mn_2Y	44.7	$cF24$	$Fd\bar{3}m$
(βY)	100	$cI2$	$Im\bar{3}m$
(αY)	100	$hP2$	$P6_3/mmc$
Other phases			
$\text{Mn}_2\text{Y}^{(a)}$	44.7	$hP12$	$P6_3/mmc$
$\text{Mn}_2\text{Y}^{(b)}$	44.7

(a) Synthesized under high temperature (1300 °C) and high pressure (40 kbar).

(b) Distorted tetragonal Cu_2Mg type obtained below 100 K

Mn-Zn (Manganese - Zinc)

H. Okamoto and L.E. Tanner, 1990

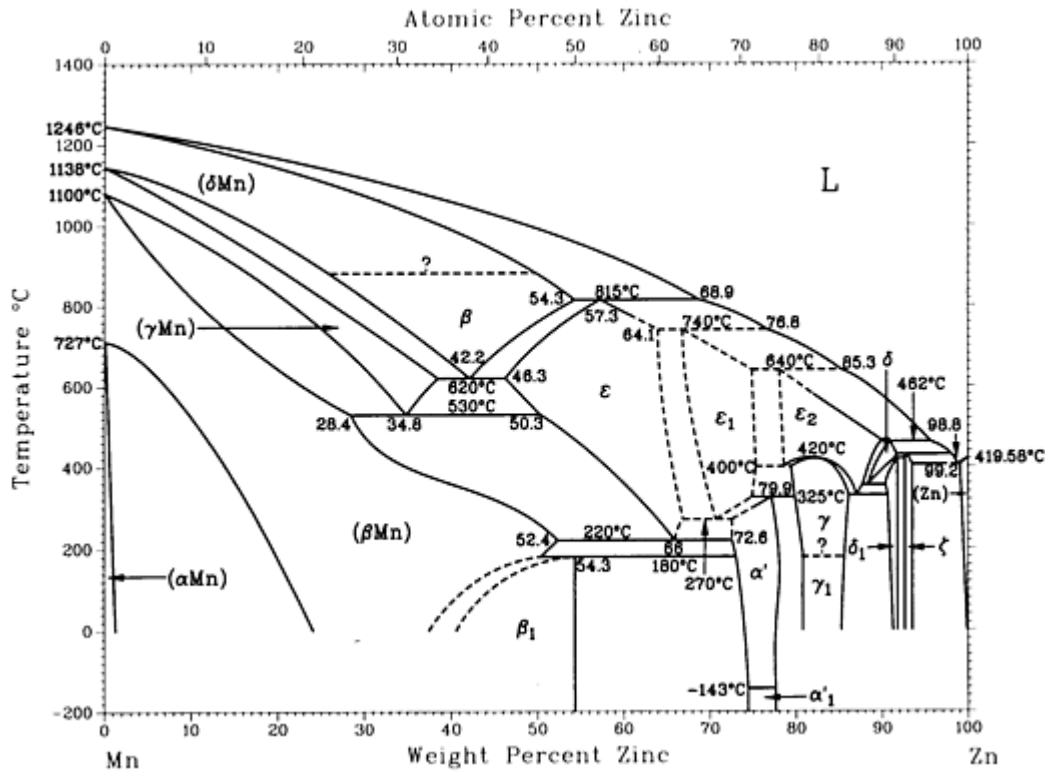

Mn-Zn phase diagram

Mn-Zn crystallographic data

Phase	Composition, wt% Zn	Pearson symbol	Space group
(δ Mn)	0 to 54.3	<i>cI2</i>	<i>Im$\bar{3}m$</i>
(γ Mn)	0 to 38	<i>cF4</i>	<i>Fm$\bar{3}m$</i>
(γ Mn ₁)	0 to ?	<i>tI2</i>	<i>I4/mmm</i>
(β Mn)	0 to 52.4	<i>cP20</i>	<i>P4₁31</i>
(α Mn)	0 to 2.0	<i>cI58</i>	<i>I$\bar{4}3m$</i>
β	? to 54.3	<i>cP2</i>	<i>Pm$\bar{3}m$</i>

β_1	47.8 to 54.3	<i>cP2</i>	<i>Pm$\bar{3}m$</i>
ϵ	46.3 to 67	<i>hP2</i>	<i>P6$_3$/mmc</i>
ϵ_1	67 to 75	<i>hP8</i>	<i>P6$_3$/mmc</i>
ϵ_2	78 to 90.2	<i>hP*</i>	...
α'	72.6 to 78	<i>cP4</i>	<i>Pm$\bar{3}m$</i>
α'_1	74 to 78	<i>tP2</i>	<i>P4/mmm</i>
γ	79.9 to 86.6	<i>cI52</i>	...
γ_1	...	<i>cI550 \pm 8</i>	...
δ	88.4 to 92.0	<i>hP*</i>	...
δ_1	90.5 to 92.2	<i>hP*</i>	...
$\zeta_{(MnZn_{13})}$	93.7 to 94.0	<i>mC28</i>	<i>P2/m</i>
(Zn)	99.2 to 100	<i>hP2</i>	<i>P6$_3$/mmc</i>

Mn-Zr (Manganese - Zirconium)

M. Lasocka, unpublished

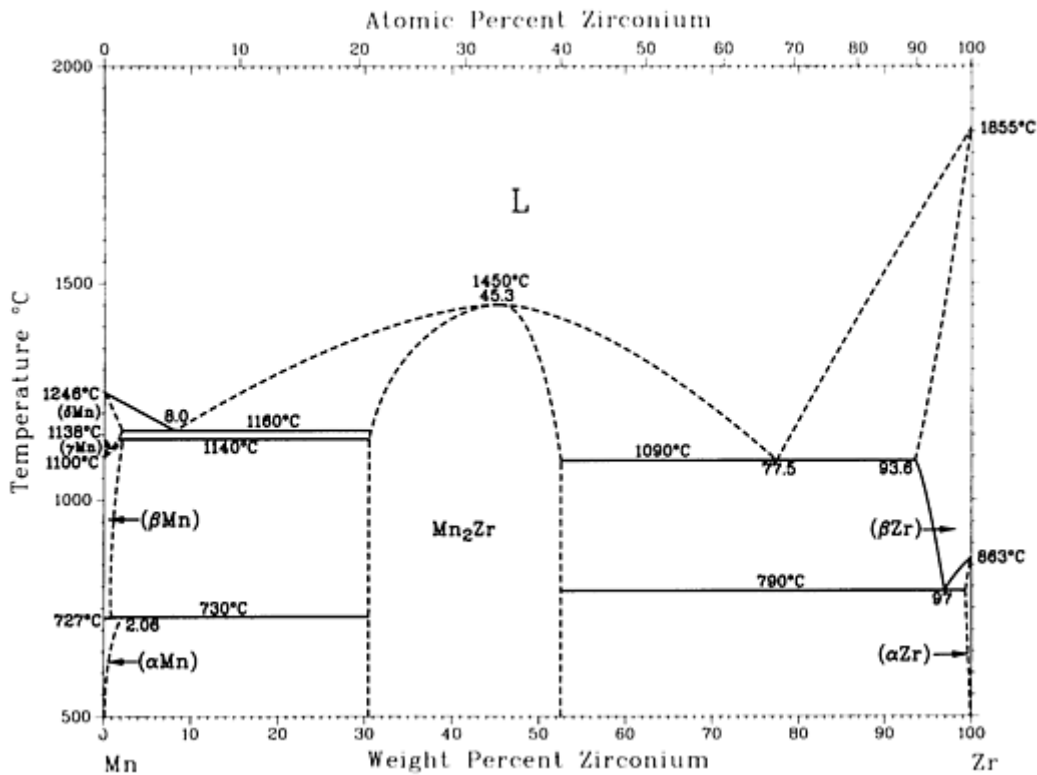

Mn-Zr phase diagram

Mn-Zr crystallographic data

Phase	Composition, wt% Zr	Pearson symbol	Space group
(δMn)	0 to 2.06	<i>cI2</i>	<i>Im</i> $\bar{3}m$
(γMn)	0	<i>cF4</i>	<i>Fm</i> $\bar{3}m$
(βMn)	0 to ~2	<i>cP20</i>	<i>P4</i> ₁ <i>32</i>
(αMn)	0 to 2.06	<i>cI58</i>	<i>I</i> $\bar{4}3m$
Mn ₂ Zr	30.40 to 53	<i>hP12</i>	<i>P6</i> ₃ <i>/mmc</i>
(βZr)	93.6 to 100	<i>cI2</i>	<i>Im</i> $\bar{3}m$

(α Zr)	100	<i>hP2</i>	<i>P6₃/mmc</i>
----------------	-----	------------	---------------------------

Mo (Molybdenum) Binary Alloy Phase Diagrams

Introduction

THIS ARTICLE includes systems where molybdenum is the first-named element in the binary pair. Additional binary systems that include molybdenum are provided in the following locations in this Volume:

- “Ag-Mo (Silver - Molybdenum)” in the article “Ag (Silver) Binary Alloy Phase Diagrams”
- “B-Mo (Boron - Molybdenum)” in the article “B (Boron) Binary Alloy Phase Diagrams”
- “C-Mo (Carbon - Molybdenum)” in the article “C (Carbon) Binary Alloy Phase Diagrams”
- “Co-Mo (Cobalt - Molybdenum)” in the article “Co (Cobalt) Binary Alloy Phase Diagrams”
- “Cr-Mo (Chromium - Molybdenum)” in the article “Cr (Chromium) Binary Alloy Phase Diagrams”
- “Fe-Mo (Iron - Molybdenum)” in the article “Fe (Iron) Binary Alloy Phase Diagrams”
- “Ga-Mo (Gallium - Molybdenum)” in the article “Ga (Gallium) Binary Alloy Phase Diagrams”
- “Ge-Mo (Germanium - Molybdenum)” in the article “Ge (Germanium) Binary Alloy Phase Diagrams”
- “Hf-Mo (Hafnium - Molybdenum)” in the article “Hf (Hafnium) Binary Alloy Phase Diagrams”
- “Ir-Mo (Iridium - Molybdenum)” in the article “Ir (Iridium) Binary Alloy Phase Diagrams”
- “Mn-Mo (Manganese - Molybdenum)” in the article “Mn (Manganese) Binary Alloy Phase Diagrams”

Mo-Nb (Molybdenum - Niobium)

H. Okamoto, 1991

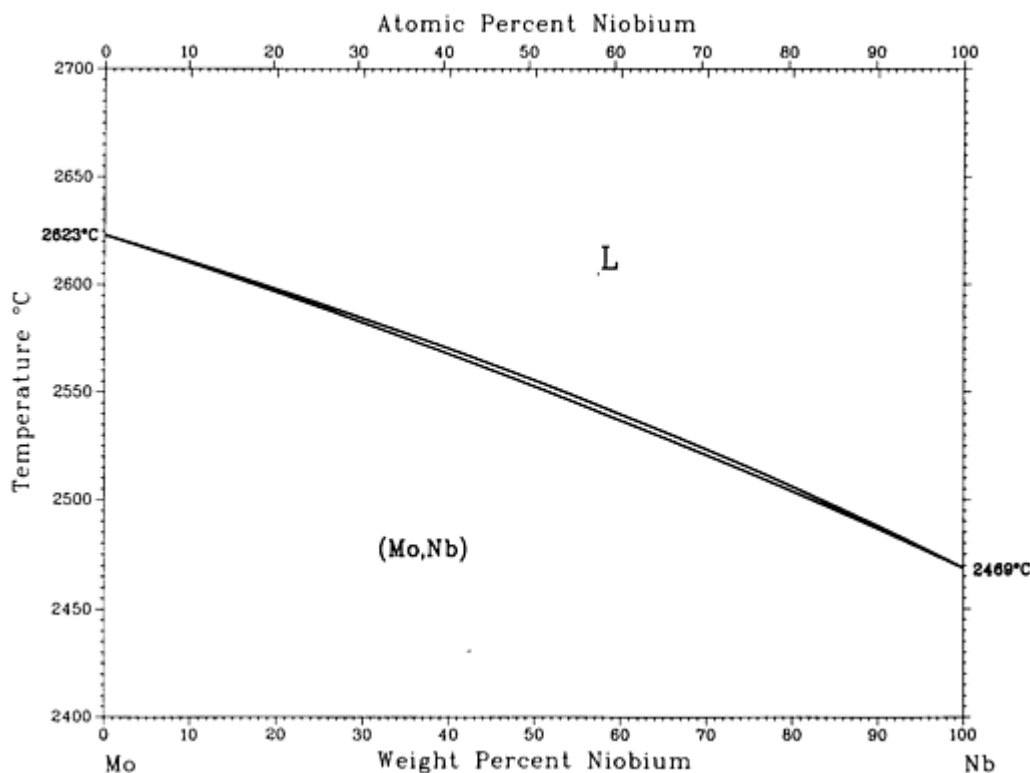

Mo-Nb phase diagram

Mo-Nb crystallographic data

Phase	Composition, wt% Nb	Pearson symbol	Space group
(Mo,Nb)	0 to 100	<i>cI2</i>	<i>Im$\bar{3}m$</i>

Mo-Ni (Molybdenum - Nickel)

H. Okamoto, 1991

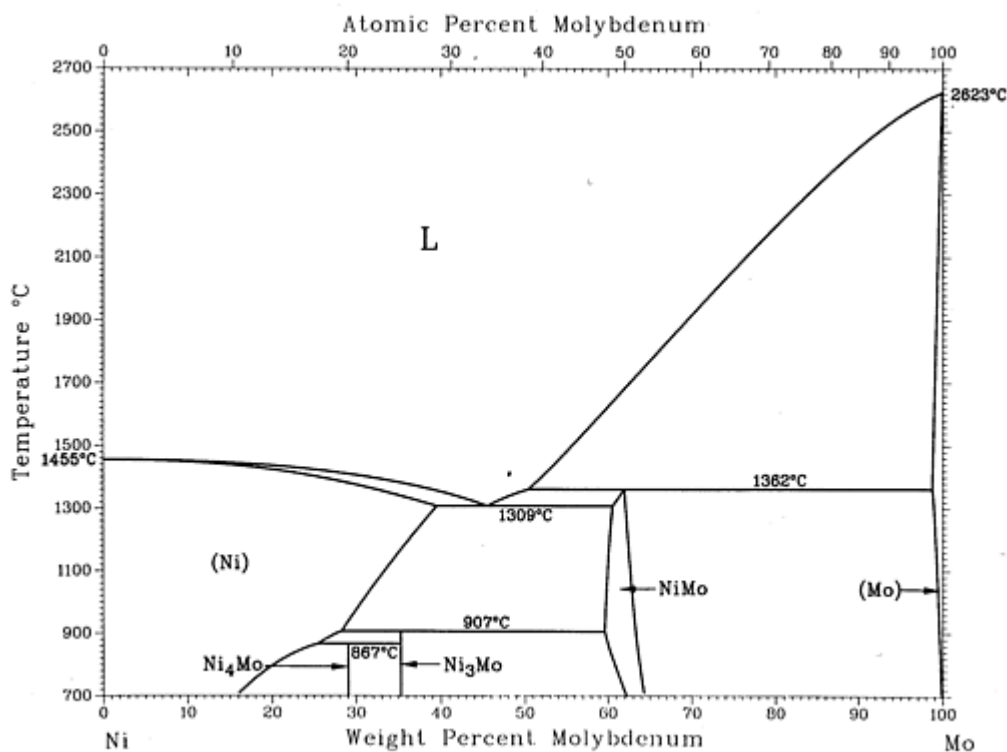

Mo-Ni phase diagram

Mo-Ni crystallographic data

Phase	Composition, wt% Mo	Pearson symbol	Space group
(Ni)	0 to 38 ^(a)	<i>cF4</i>	<i>Fm$\bar{3}m$</i>
Ni ₄ Mo	29.0	<i>tI10</i>	<i>I4/m</i>
Ni ₃ Mo	35.3	<i>oP8</i>	<i>Pmnn</i>

NiMo	63.9 to 65.7	<i>oP112</i>	<i>P2₁2₁2₁</i>
(Mo)	98.9 to 100 ^(b)	<i>cI2</i>	<i>Im$\bar{3}m$</i>
Metastable phases			
Ni ₂ Mo	...	<i>oI6</i>	...
Ni ₃ Mo	...	<i>tI8</i>	<i>I4/mmm</i>
Ni ₄ Mo	...	<i>tI10, cF4</i>	...
Ni ₁₇ Mo ₅

(a) At 1317 °C.

(b) At 1362 °C

Mo-O (Molybdenum - Oxygen)

L. Brewer and R.H. Lamoreaux, 1980

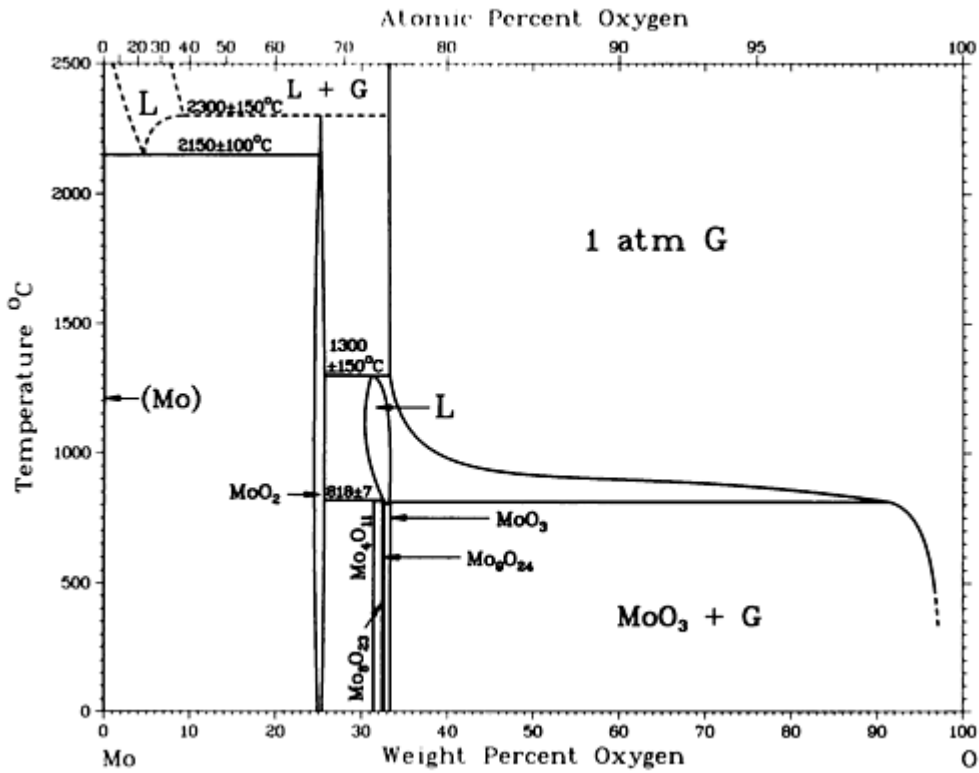

Mo-O phase diagram

Mo-O crystallographic data

Phase	Composition, wt% O	Pearson symbol	Space group
(Mo)	0	<i>cI2</i>	<i>Im</i> $\bar{3}m$
MoO ₂	~25.0	<i>mP12</i> <i>tP6</i>	<i>P2</i> ₁ / <i>c</i> ^(a) <i>P4</i> ₂ / <i>mnn</i>
Mo ₄ O ₁₁	31.4	<i>oP60</i>	<i>Pna2</i> ₁
Mo ₈ O ₂₃	32.4	<i>mP124</i> <i>mP62</i>	<i>Pc</i> <i>P2</i> / <i>c</i>
Mo ₉ O ₂₄ ^(b)	32.5	<i>mC280</i> <i>mP70</i>	<i>C2</i> / <i>c</i> <i>P2</i> / <i>c</i>
MoO ₃	33	<i>oP128</i>	<i>Pba2</i>

(a) Or *P2*₁.

(b) Might be Mo₉O₂₆

Reference cited in this section

- [Molybdenum]: L. Brewer, *Molybdenum: Physico-Chemical Properties of Its Compounds and Alloys*, O. Kubaschewski, Ed., Atomic Energy Review Special Issue No.7, International Atomic Energy Agency, Vienna (1980).

Mo-P (Molybdenum - Phosphorus)

From [Molybdenum] 12

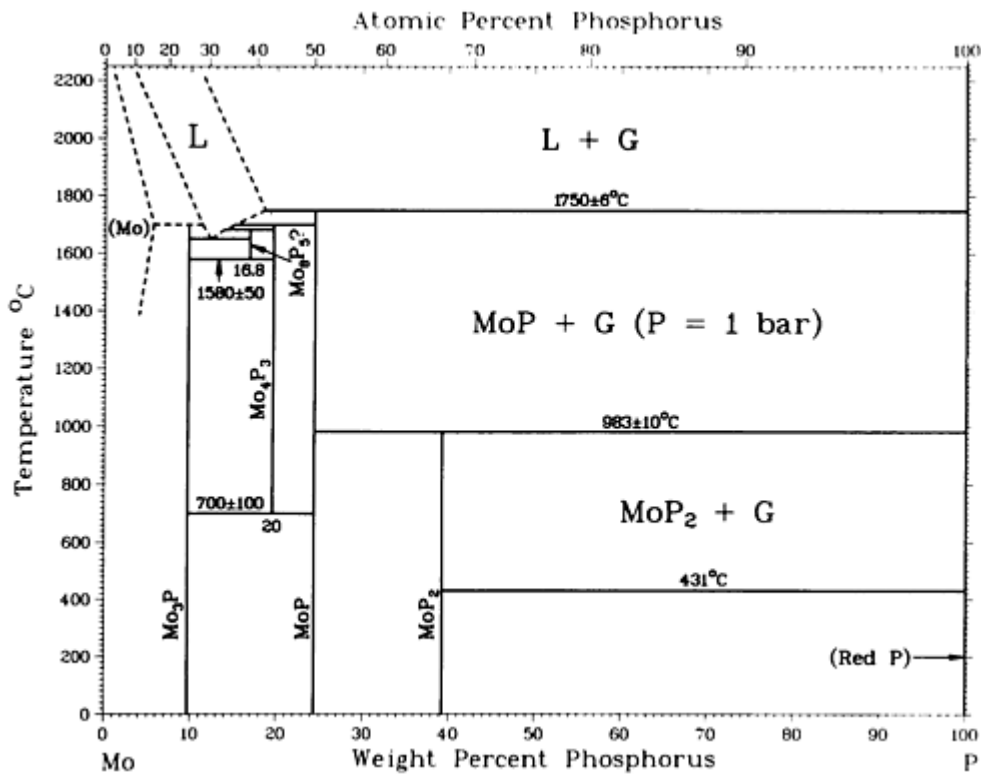

Mo-P phase diagram

Mo-P crystallographic data

Phase	Composition, wt% P	Pearson symbol	Space group
(Mo)	0 to >5	<i>cI2</i>	<i>Im</i> $\bar{3}m$
Mo ₃ P	10	<i>tI32</i>	<i>I</i> $\bar{4}2m$
Mo ₈ P ₅	16.8	<i>mP13</i>	<i>Pm</i>
Mo ₄ P ₃	20	<i>oP56</i>	<i>Pnma</i>
MoP	24.4	<i>hP2</i>	<i>P</i> $\bar{6}m2$

MoP ₂	39.3	<i>oC12</i>	<i>Cmc2</i> ₁
(P) (red)	~100
Other reported phase			
Mo ₅ P ₃	~16.2	<i>h**</i>	...

Reference cited in this section

12. [Molybdenum]: L. Brewer, *Molybdenum: Physico-Chemical Properties of Its Compounds and Alloys*, O. Kubaschewski, Ed., Atomic Energy Review Special Issue No.7, International Atomic Energy Agency, Vienna (1980).

Mo-Pd (Molybdenum - Palladium)

H. Okamoto, 1992

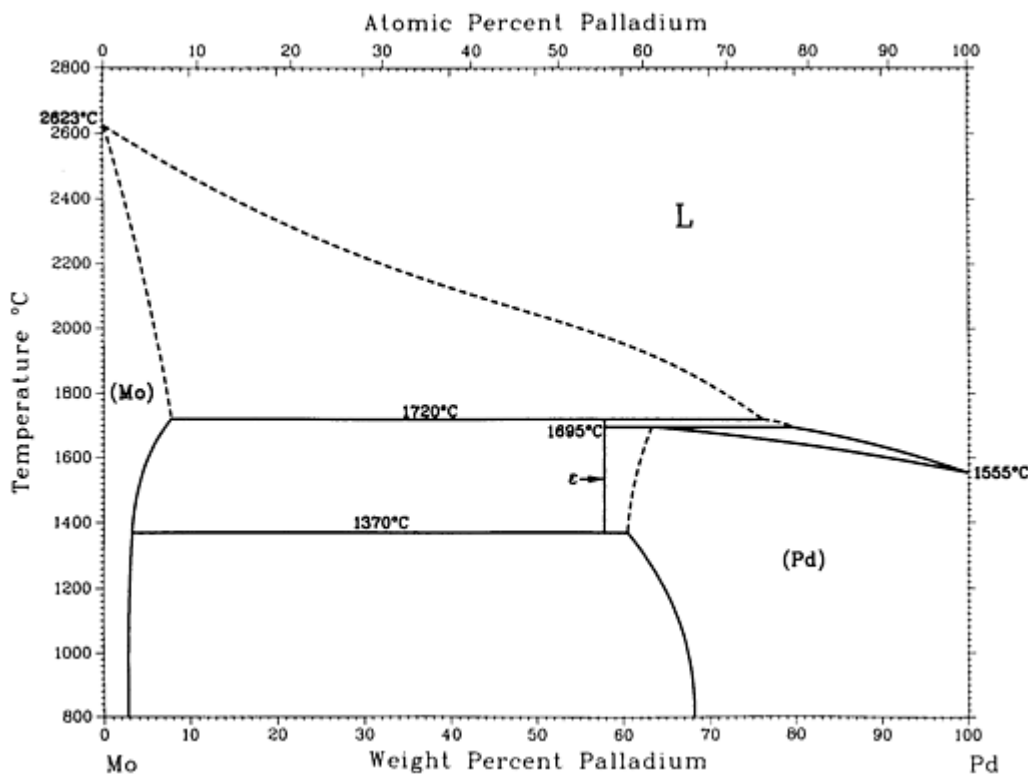

Mo-Pd phase diagram

Mo-Pd crystallographic data

Phase	Composition, wt% Pd	Pearson symbol	Space group
-------	---------------------	----------------	-------------

(Mo)	0 to 8	<i>cI2</i>	<i>Im$\bar{3}m$</i>
ϵ	~ 58	<i>hP2</i>	<i>P6$_3$/mmc</i>
(Pd)	61 to 100	<i>cF4</i>	<i>Fm$\bar{3}m$</i>

Mo-Pd (Molybdenum - Palladium)

H. Okamoto, 1992

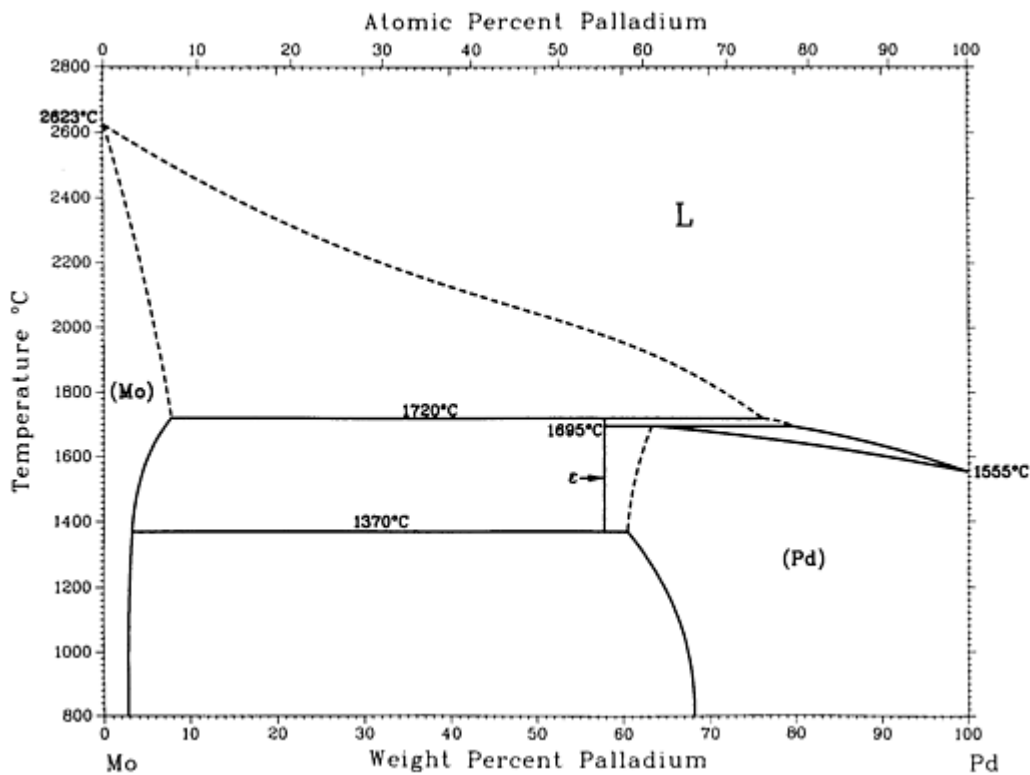

Mo-Pd phase diagram

Mo-Pd crystallographic data

Phase	Composition, wt% Pd	Pearson symbol	Space group
(Mo)	0 to 8	<i>cI2</i>	<i>Im$\bar{3}m$</i>
ϵ	~ 58	<i>hP2</i>	<i>P6$_3$/mmc</i>
(Pd)	61 to 100	<i>cF4</i>	<i>Fm$\bar{3}m$</i>

Mo-Pt (Molybdenum - Platinum)

L. Brewer and R.H. Lamoreaux, 1980

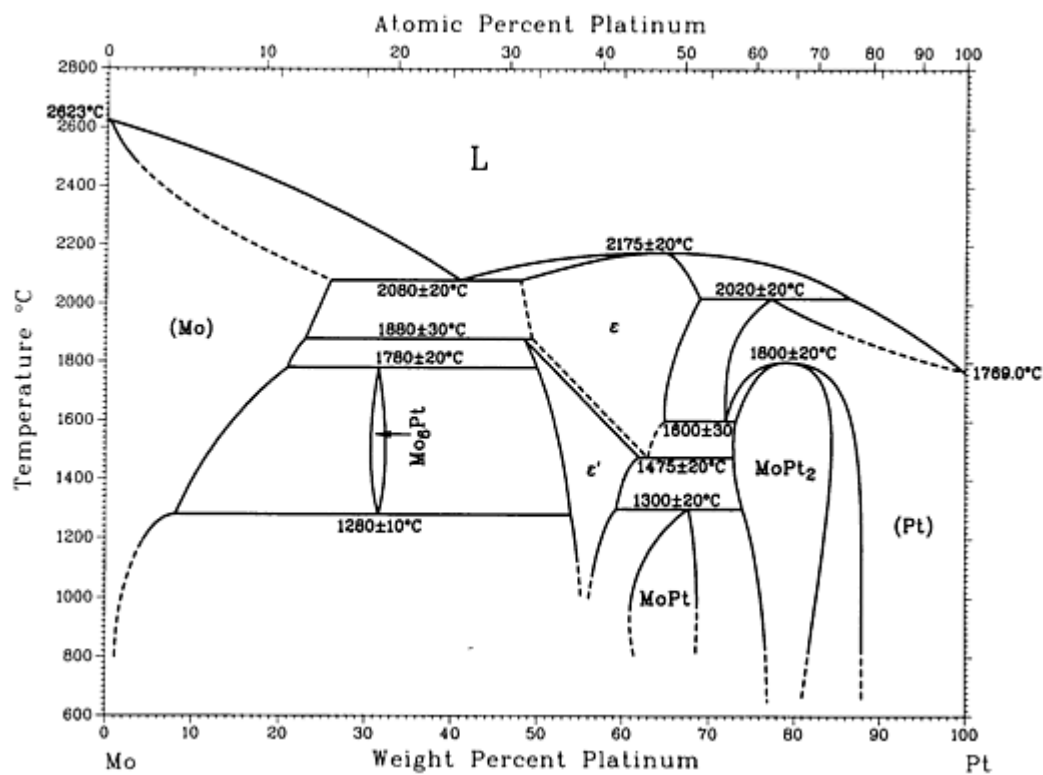

Mo-Pt phase diagram

Mo-Pt crystallographic data

Phase	Composition, wt% Pt	Pearson symbol	Space group
(Mo)	0 to 26 ± 2	<i>cI2</i>	<i>Im$\bar{3}m$</i>
Mo ₆ Pt	31.6 ± 0.7	<i>cP8</i>	<i>Pm$\bar{3}n$</i>
ε?	48 ± 1 to 71 ± 2	<i>hP2</i>	<i>P6₃/mmc</i>
ε'	48.4 ± 1 to 62 ± 2	<i>hP8</i>	<i>P6₃/mmc</i>
MoPt	61 ± 2 to 70 ± 2	<i>oP4</i>	<i>Pmma</i>

MoPt ₂	74 ± 2 to 84 ± 1	<i>oI6</i>	<i>Immm</i>
(Pt)	72 ± 2 to 100	<i>cF4</i>	<i>Fm$\bar{3}m$</i>

Mo-Pu (Molybdenum - Plutonium)

From [Molybdenum] 12

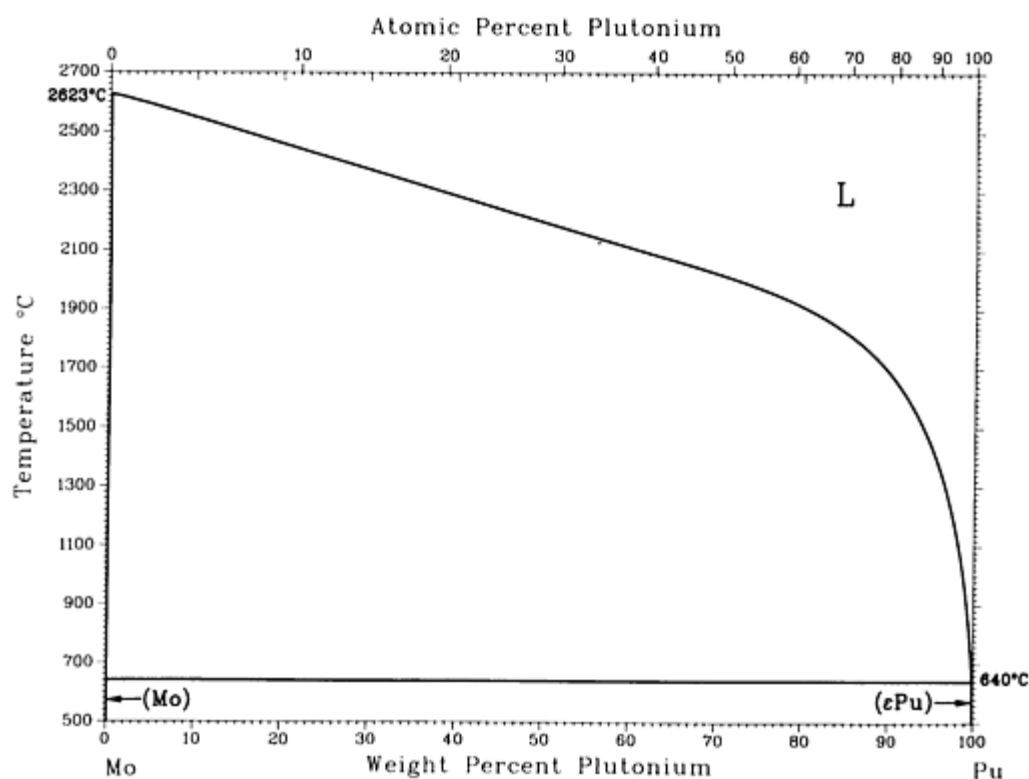

Mo-Pu phase diagram

Mo-Pu crystallographic data

Phase	Composition, wt% Pu	Pearson symbol	Space group
(Mo)	0	<i>cI2</i>	<i>Im$\bar{3}m$</i>
(εPu)	100	<i>cI2</i>	<i>Im$\bar{3}m$</i>

Reference cited in this section

- [Molybdenum]: L. Brewer, *Molybdenum: Physico-Chemical Properties of Its Compounds and Alloys*, O. Kubaschewski, Ed., Atomic Energy Review Special Issue No.7, International Atomic Energy Agency, Vienna (1980).

Mo-Rh (Molybdenum - Rhodium)

From [Molybdenum] 12

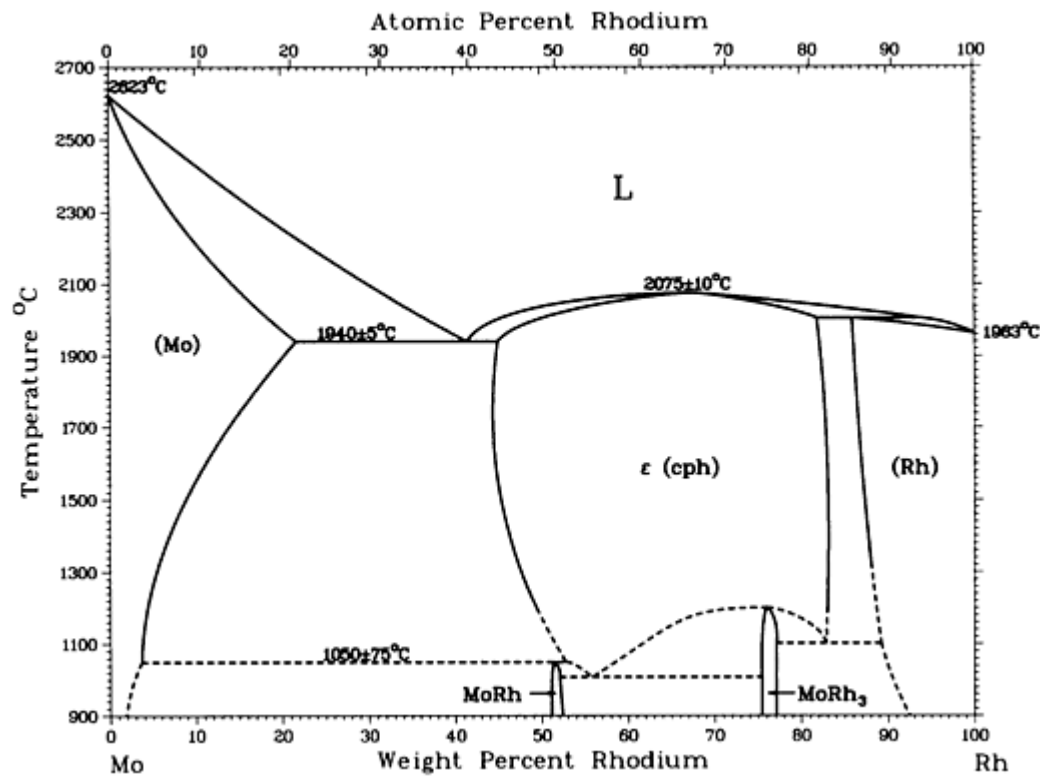

Mo-Rh phase diagram

Mo-Rh crystallographic data

Phase	Composition, wt% Rh	Pearson symbol	Space group
(Mo)	0 to 21	<i>cI2</i>	<i>Im</i> $\bar{3}m$
MoRh	~51.8	<i>oP4</i>	<i>Pmma</i>
ε	~44 to 83	<i>hP2</i>	<i>P6₃/mmc</i>
MoRh ₃	~76
(Rh)	86 to 100	<i>cF4</i>	<i>Fm</i> $\bar{3}m$

Reference cited in this section

12. [Molybdenum]: L. Brewer, *Molybdenum: Physico-Chemical Properties of Its Compounds and Alloys*, O. Kubaschewski, Ed., Atomic Energy Review Special Issue No.7, International Atomic Energy Agency, Vienna (1980).

Mo-Rh (Molybdenum - Rhodium)

From [Molybdenum] 12

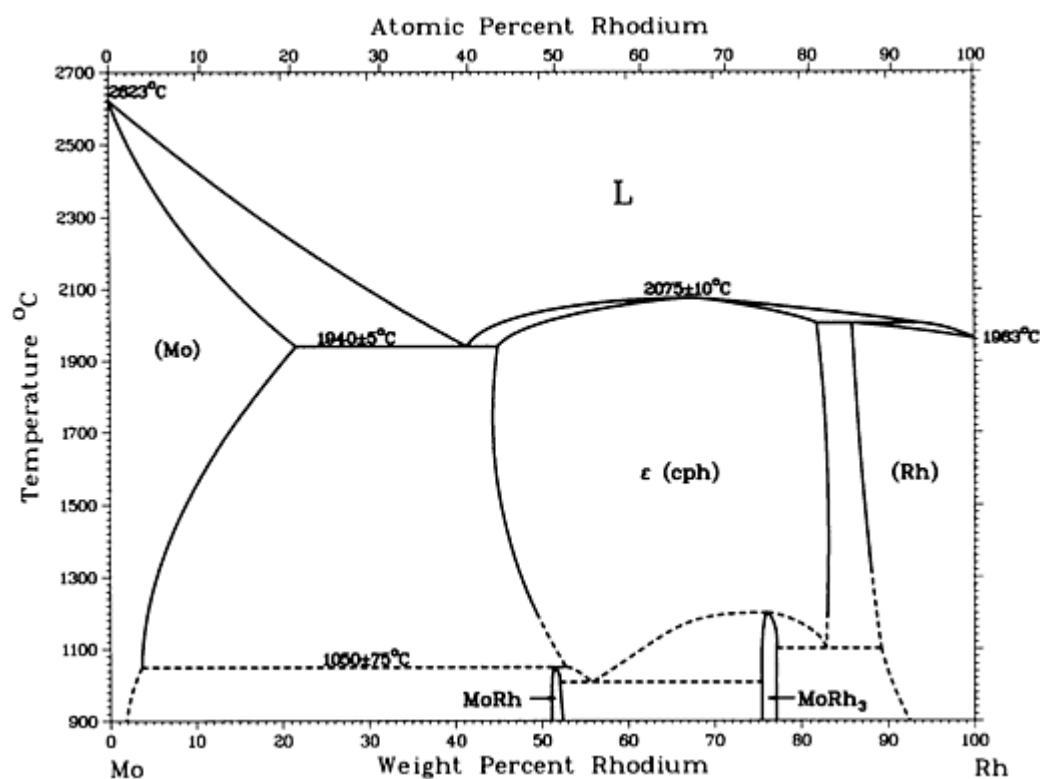

Mo-Rh phase diagram

Mo-Rh crystallographic data

Phase	Composition, wt% Rh	Pearson symbol	Space group
(Mo)	0 to 21	<i>cI2</i>	<i>Im$\bar{3}m$</i>
MoRh	~51.8	<i>oP4</i>	<i>Pmma</i>
ε	~44 to 83	<i>hP2</i>	<i>P6₃/mmc</i>
MoRh ₃	~76

(Rh)	86 to 100	<i>cF4</i>	<i>Fm$\bar{3}m$</i>
------	-----------	------------	--------------------------------

Reference cited in this section

12. [Molybdenum]: L. Brewer, *Molybdenum: Physico-Chemical Properties of Its Compounds and Alloys*, O. Kubaschewski, Ed., Atomic Energy Review Special Issue No.7, International Atomic Energy Agency, Vienna (1980).

Mo-Ru (Molybdenum - Ruthenium)

H. Okamoto, 1990

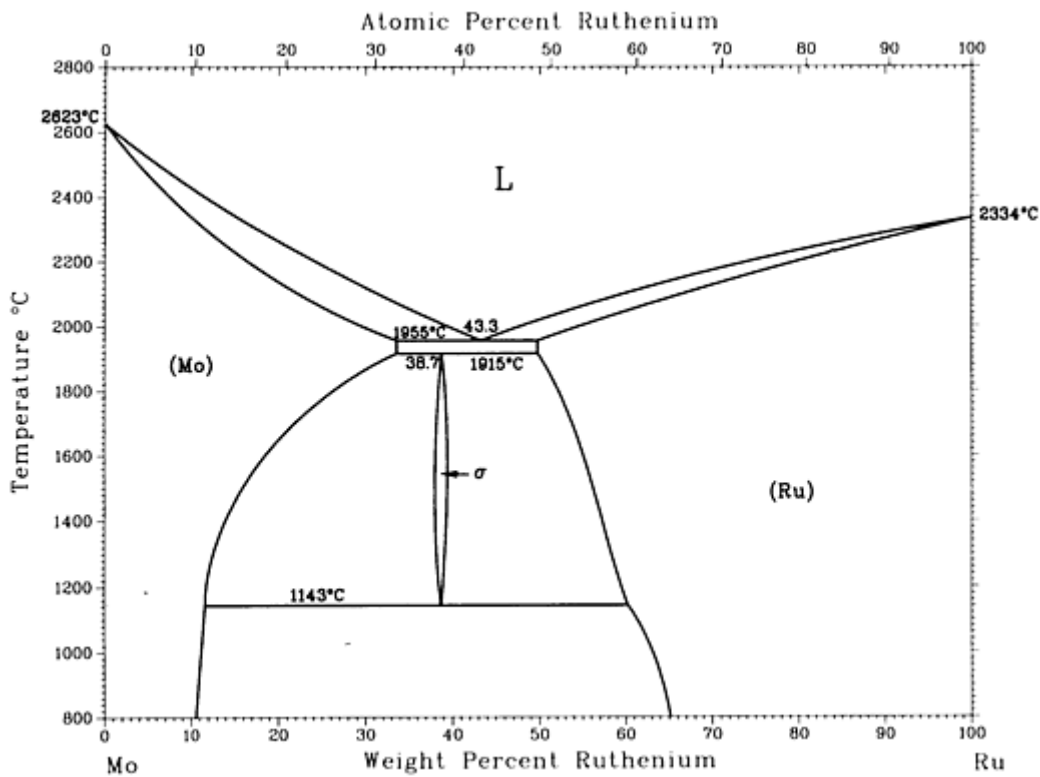

Mo-Ru phase diagram

Mo-Ru crystallographic data

Phase	Composition, wt% Ru	Pearson symbol	Space group
(Mo)	0 to 33.6	<i>cI2</i>	<i>Im$\bar{3}m$</i>
σ	37.9 to 40.7	<i>tP30</i>	<i>P4₂/mnm</i>

(Ru)	49.8 to 100	<i>hP2</i>	<i>P6₃/mmc</i>
------	-------------	------------	---------------------------

Mo-S (Molybdenum - Sulfur)

L. Brewer and R.H. Lamoreaux, 1980

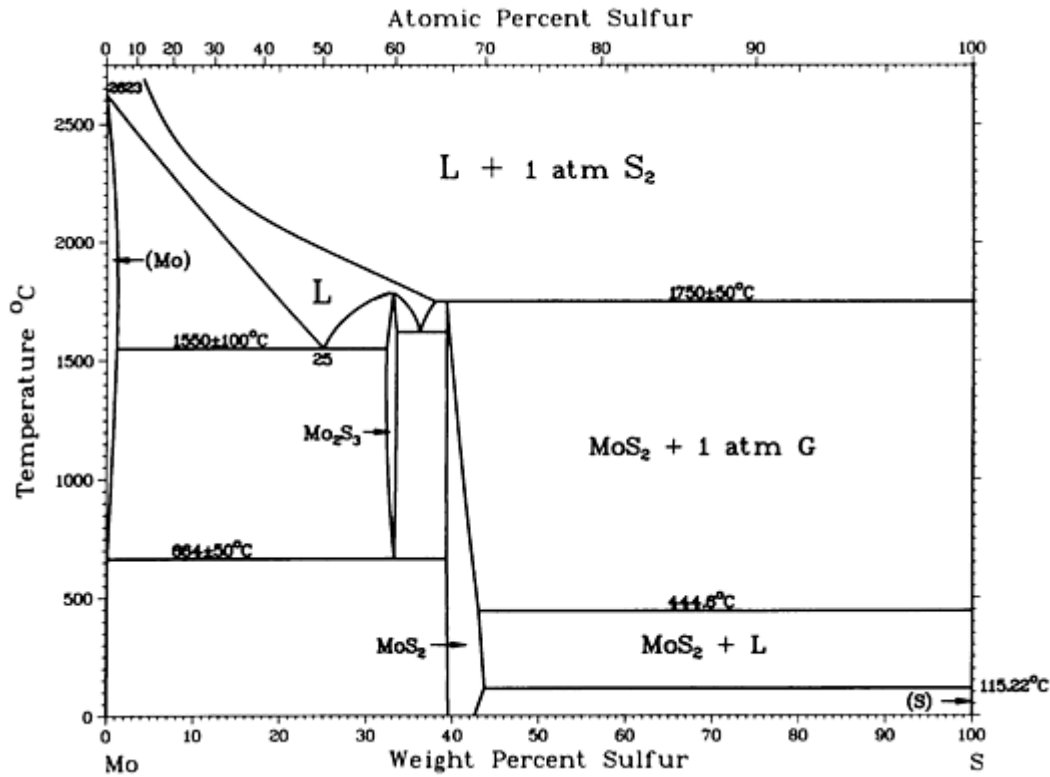

Mo-S phase diagram

Mo-S crystallographic data

Phase	Composition, wt% S	Pearson symbol	Space group
(Mo)	0 to 1	<i>cI2</i>	<i>Im$\bar{3}m$</i>
Mo ₂ S ₃	~33	<i>mP10</i>	<i>P2₁/m</i>
MoS ₂	39 to 44	<i>hP6</i> <i>hR3</i>	<i>P6₃/mmc</i> <i>R$\bar{3}m$</i>

(β_S)	100	mP^*	$P2_1/c$
$(\alpha_S)^{(a)}$	100	$oF128$	$Fddd$

(a) Below 95.5 °C

Mo-Ta (Molybdenum - Tantalum)

R. Krishnan, S.P. Garg, and N. Krishnamurthy, 1986

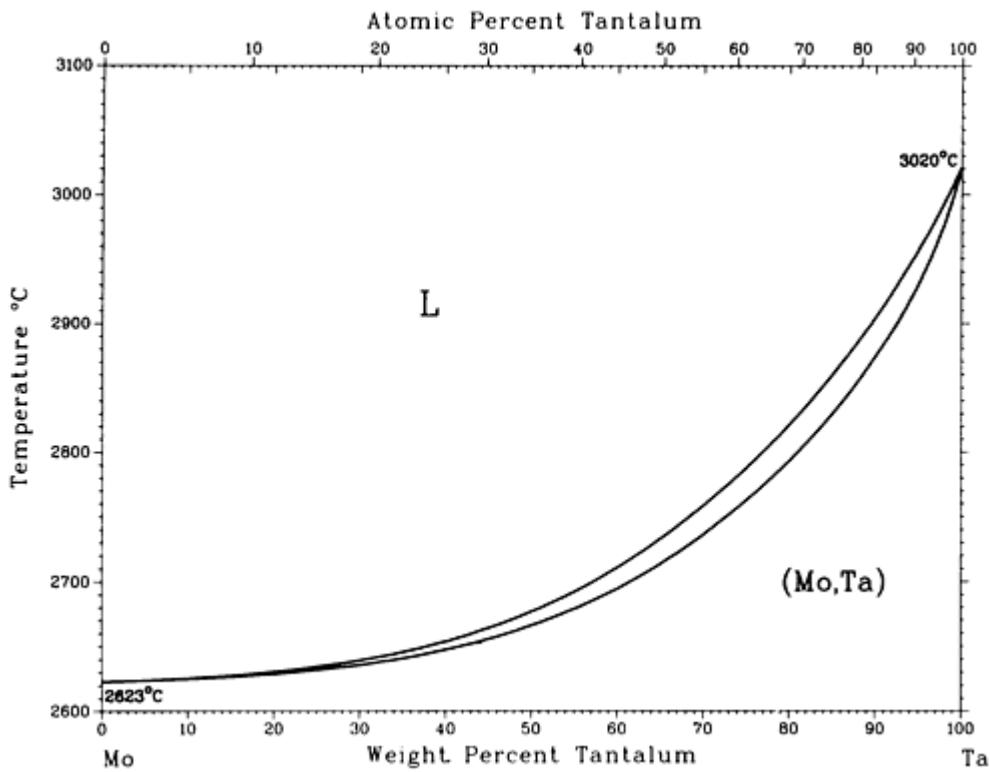

Mo-Ta phase diagram

Mo-Ta crystallographic data

Phase	Composition, wt% Ta	Pearson symbol	Space group
(Mo,Ta)	0 to 100	$cI2$	$Im\bar{3}m$

Mo-Ti (Molybdenum - Titanium)

J.L. Murray, 1987

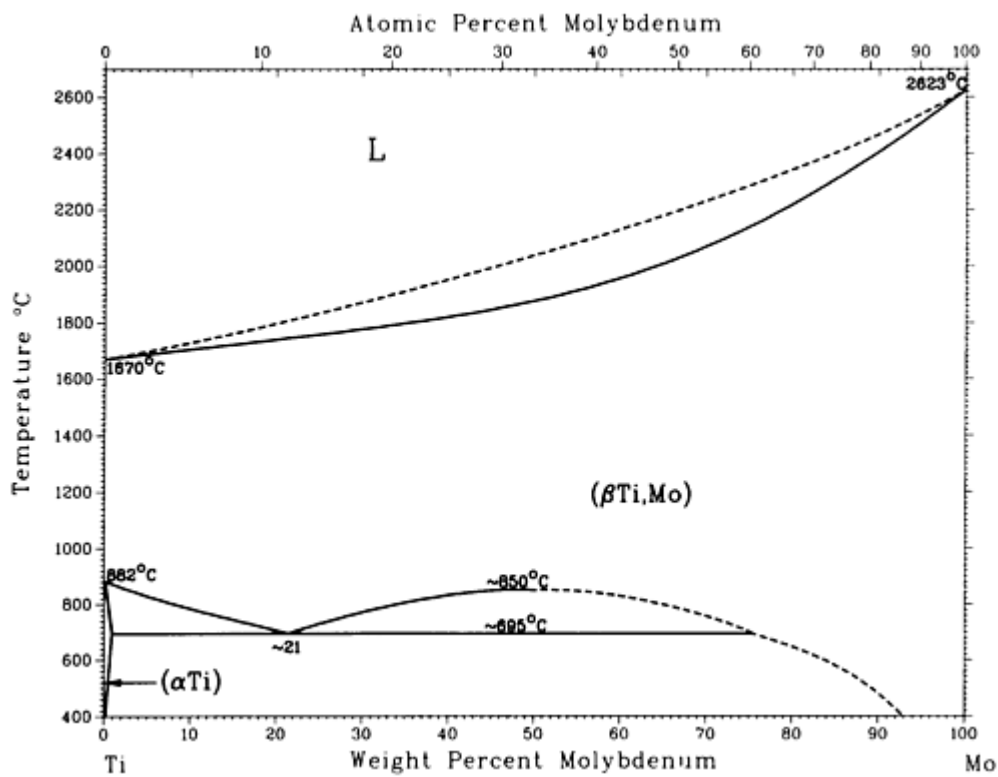

Mo-Ti phase diagram

Mo-Ti crystallographic data

Phase	Composition, wt% Mo	Pearson symbol	Space group
(β _{Ti,Mo})	0 to 100	<i>cI2</i>	<i>Im</i> $\bar{3}m$
(αTi)	0 to 0.8	<i>hP2</i>	<i>P6</i> ₃ / <i>mmc</i>
α'	^(a)	<i>hP2</i>	<i>P6</i> ₃ / <i>mmc</i>

α''	(a)	<i>oC4</i>	<i>Cmcm</i>
ω	(a)	<i>hP3</i>	<i>P6/mmm</i>

(a) Metastable

Mo-U (Molybdenum - Uranium)

H. Okamoto, 1990

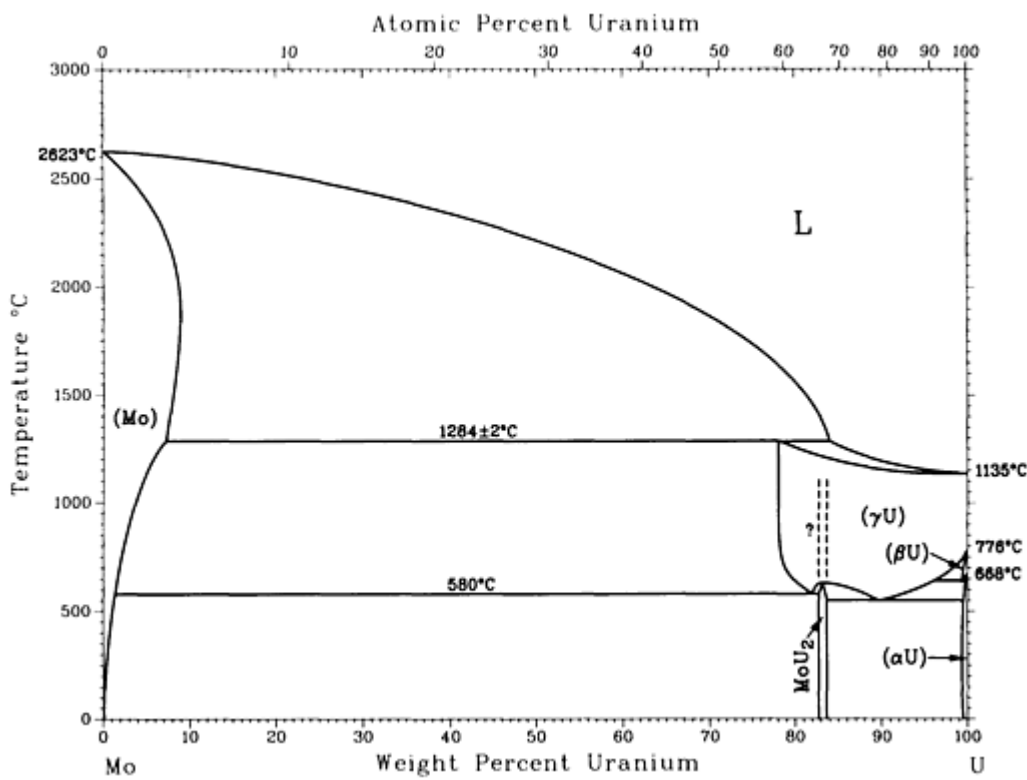

Mo-U phase diagram

Mo-U crystallographic data

Phase	Composition, wt% U	Pearson symbol	Space group
(Mo)	0 to 9	<i>cI2</i>	<i>Im$\bar{3}m$</i>
MoU ₂	83.2	<i>tI6</i>	<i>I4/mmm</i>

(γ_U)	98 to 100	<i>cI2</i>	<i>Im\bar{3}m</i>
(β_U)	99 to 100	<i>tP30</i>	<i>P4_2/mnm</i>
(α_U)	99 to 100	<i>oC4</i>	<i>Cmcm</i>

Mo-V (Molybdenum - Vanadium)

J.F. Smith, 1989

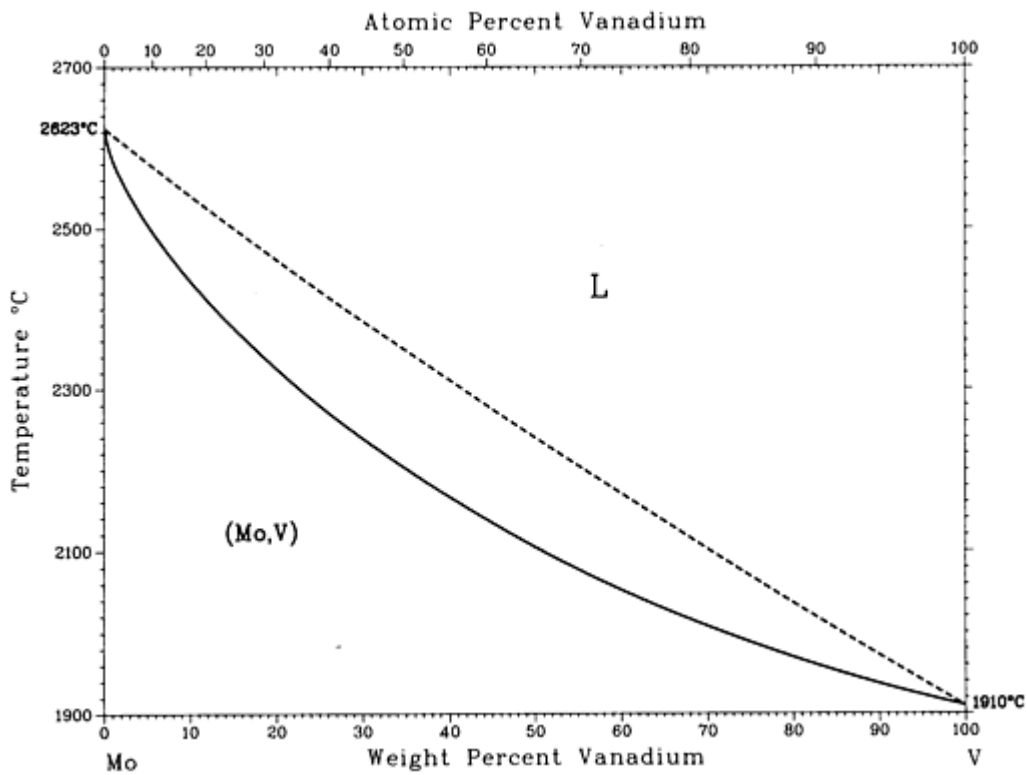

Mo-V phase diagram

Mo-V crystallographic data

Phase	Composition, wt% V	Pearson symbol	Space group
(Mo,V)	0 to 100	<i>cI2</i>	<i>Im\bar{3}m</i>

Mo-W (Molybdenum - Tungsten)

S.V. Nagender Naidu, A.M. Sriramamurthy, and P. Rama Rao, 1984

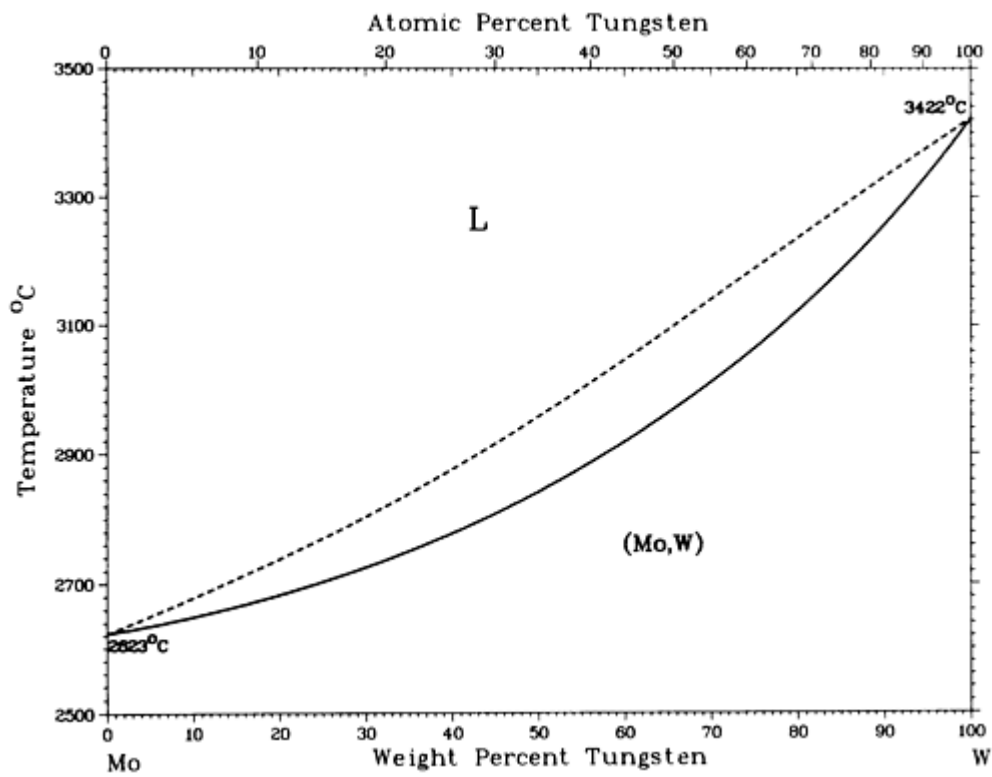

Mo-W phase diagram

Mo-W crystallographic data

Phase	Composition, wt% W	Pearson symbol	Space group
(Mo,W)	0 to 100	$cI2$	$Im\bar{3}m$

Mo-Zr (Molybdenum - Zirconium)

From [Zirconium] 21

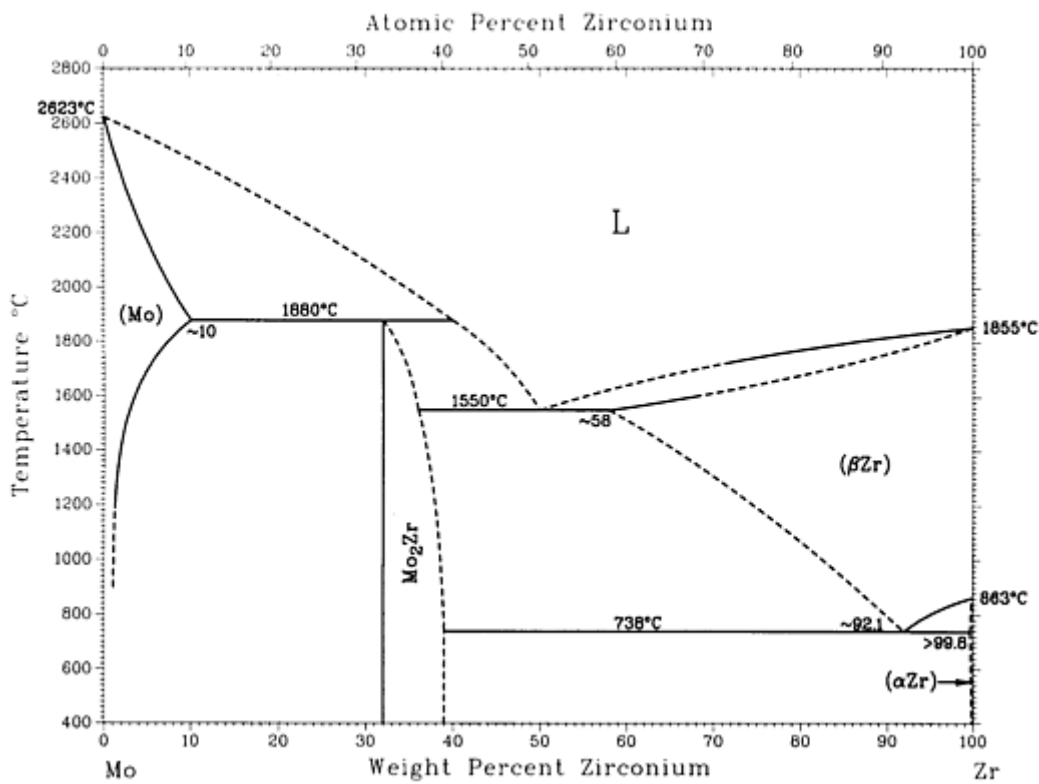

Mo-Zr phase diagram

Mo-Zr crystallographic data

Phase	Composition, wt% Zr	Pearson symbol	Space group
(Mo)	0		
(βZr)	0-100		
(αZr)	0-100		

(Mo)	0 to ~10	<i>cI2</i>	<i>Im</i> $\bar{3}m$
Mo ₂ Zr	32 to 39	<i>cF24</i>	<i>Fd</i> $\bar{3}m$
(β Zr)	~58 to 100	<i>cI2</i>	<i>Im</i> $\bar{3}m$
(α Zr)	~100	<i>hP2</i>	<i>P6₃/mmc</i>

Reference cited in this section

21. [**Zirconium**]: C.B. Alcock, K.T. Jacob, S. Zador, O. von Goldbeck, H. Nowotny, K. Seifert, and O. Kubaschewski, *Zirconium: Physico-Chemical Properties of Its Compounds and Alloys*, O. Kubaschewski, Ed., Atomic Energy Review Special Issue No.6, International Atomic Energy Agency, Vienna (1976).

N (Nitrogen) Binary Alloy Phase Diagrams

Introduction

THIS ARTICLE includes systems where nitrogen is the first-named element in the binary pair. Additional binary systems that include nitrogen are provided in the following locations in this Volume:

- “Fe-N (Iron - Nitrogen)” in the article “Fe (Iron) Binary Alloy Phase Diagrams.”
- “Hf-N (Hafnium - Nitrogen)” in the article “Hf (Hafnium) Binary Alloy Phase Diagrams.”
- “Mn-N (Manganese - Nitrogen)” in the article “Mn (Manganese) Binary Alloy Phase Diagrams.”
- “Mo-N (Molybdenum - Nitrogen)” in the article “Mo (Molybdenum) Binary Alloy Phase Diagrams.”

N (Nitrogen) Binary Alloy Phase Diagrams

N-Nb (Nitrogen - Niobium)

Yu.V. Levinskiy, 1974

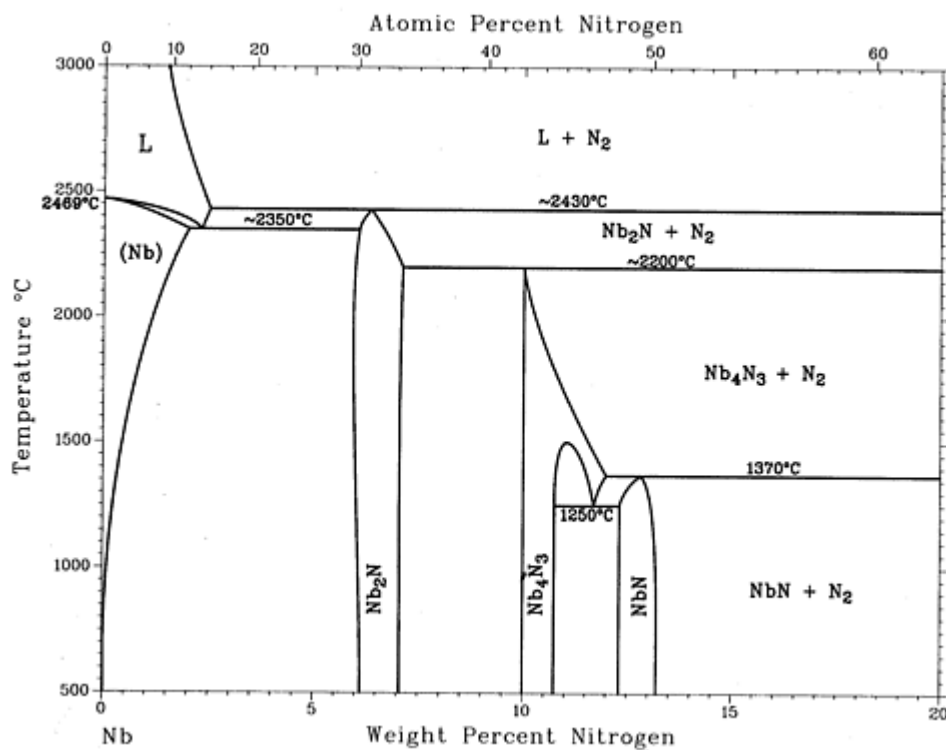

N-Nb phase diagram

N-Nb crystallographic data

Phase	Composition, wt% N	Pearson symbol	Space group
(Nb)	0 to <3	<i>cI2</i>	<i>Im</i> $\bar{3}m$
Nb ₂ N	~5.9 to 7	<i>hP9</i>	<i>P</i> $\bar{3}1m$

Nb ₄ N ₃	~10.2	<i>tI14</i>	<i>I4/mmm</i>
NbN	~13.1	<i>hP8</i>	<i>P6₃/mmc</i>
Other reported phases			
Nb ₃ N	5	<i>tP58</i>	<i>P4/m</i>
Nb ₁₀ N ₉	12.0	<i>hP2</i>	<i>P6₃m2</i>
NbN	13.1	<i>hP4</i>	<i>P6₃/mmc</i>
Nb ₅ N ₆	15.3	<i>hP22</i>	<i>P6₃/mcm</i>
Nb ₄ N ₅	15.9	<i>tI18</i>	<i>I4/m</i>

N-Ni (Nitrogen - Nickel)

H.A. Wriedt, 1991

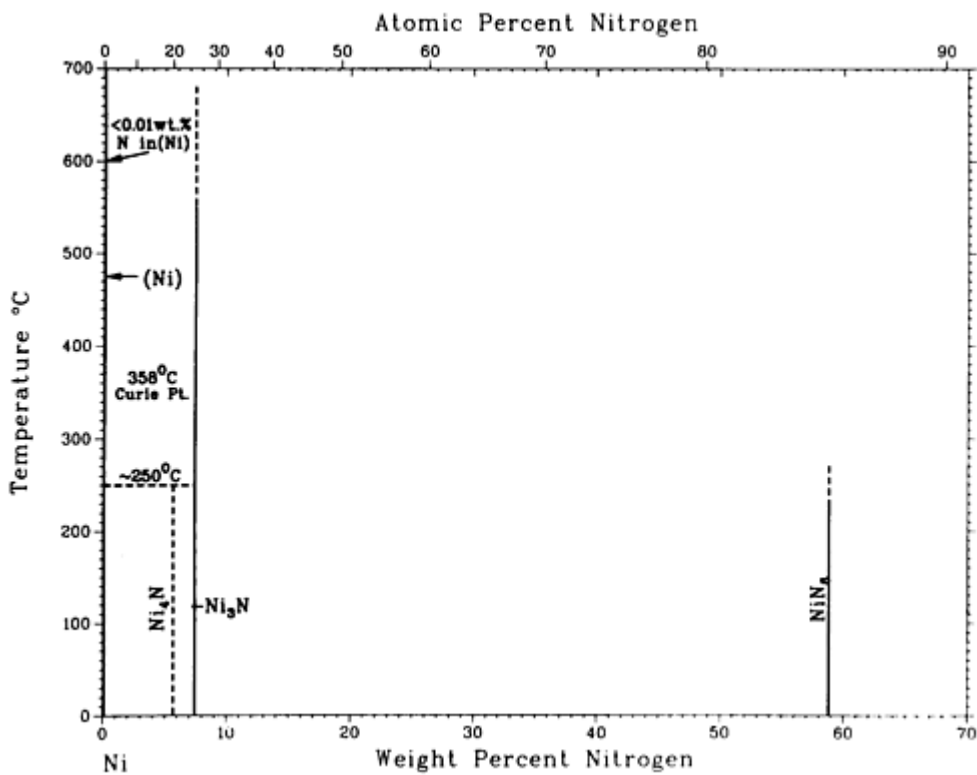

N-Ni phase diagram

N-Ni crystallographic data

Phase	Composition, wt% N	Pearson symbol	Space group
Stable phases			
(Ni) ^(a)	~0	<i>cF4</i>	<i>Fm$\bar{3}m$</i>
Ni ₃ N	7	<i>hP*</i>	<i>P6₃22</i> or <i>P312</i>
Ni(N ₃) ₂	58.9
Other phases			
Ni ₄ N,I	6	<i>c**</i>	...
Ni ₄ N,II	6	<i>t**</i>	...
Ni ₂ N	10.6	<i>t**</i>	...
Ni ₃ N ₂ ^(b)	14

(a) At 25 °C.

(b) Existence questionable

N-Ta (Nitrogen - Tantalum)

J. Gatterer, D. Dufek, P. Ettmayer, and R. Kieffer, 1975

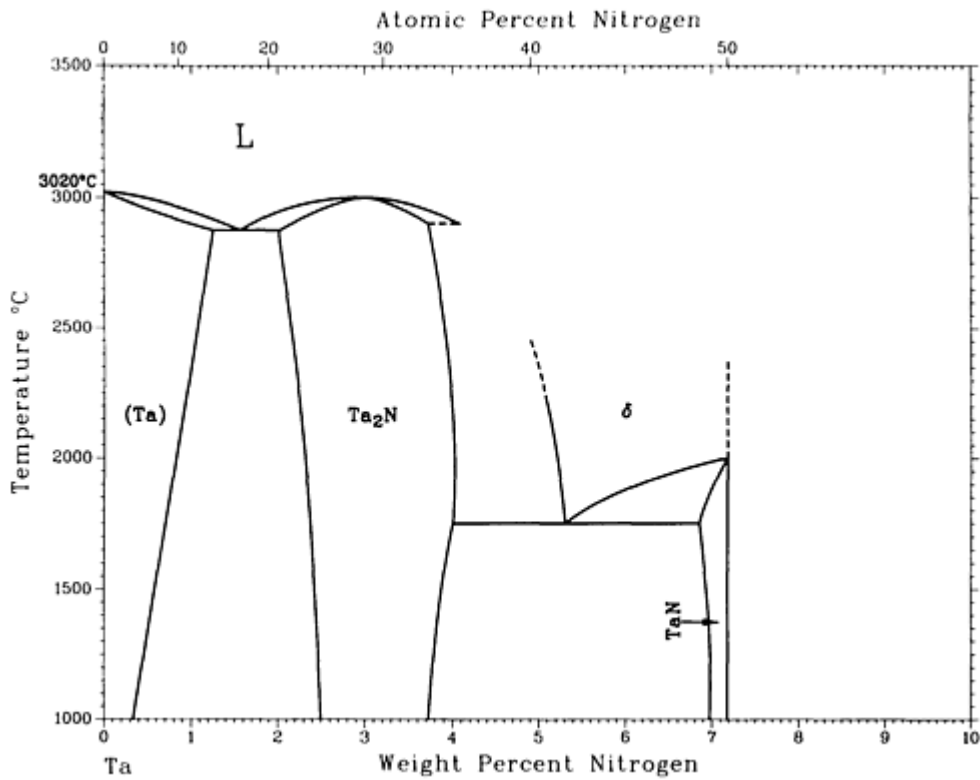

N-Ta phase diagram

N-Ta crystallographic data

Phase	Composition, wt% N	Pearson symbol	Space group
(Ta)	0 to 1.5	<i>cI2</i>	<i>Im</i> $\bar{3}m$
Ta ₂ N	2.1 to 4.0	<i>hP3</i>	<i>P6₃/mmc</i>
δ	\sim 4.9 to 7.2	<i>cF8</i>	<i>Fm</i> $\bar{3}m$
TaN	7.2	<i>c**</i>	...
Other reported phases			
Ta ₉ N ₂	\sim 1.7	<i>c**</i>	...
Ta ₄ (HT?)	\sim 1.9	<i>o**</i>	...

Ta ₂ N	~3.7	<i>hP9</i>	$P\bar{3}1m$
TaN	7.2	<i>hP8</i>	$P6_3/mmc$
Ta ₅ N ₆	~8.5	<i>hP22</i>	$P6_3/mcm$
Ta ₄ N ₅	~8.8	<i>tI18</i>	$I4/m$
Ta ₃ N ₅	~11.4	<i>t**</i> <i>oC32</i> <i>mC32</i>	\dots <i>Cmcm</i> <i>C2/m</i>

N-Th (Nitrogen - Thorium)

H. Okamoto, 1990

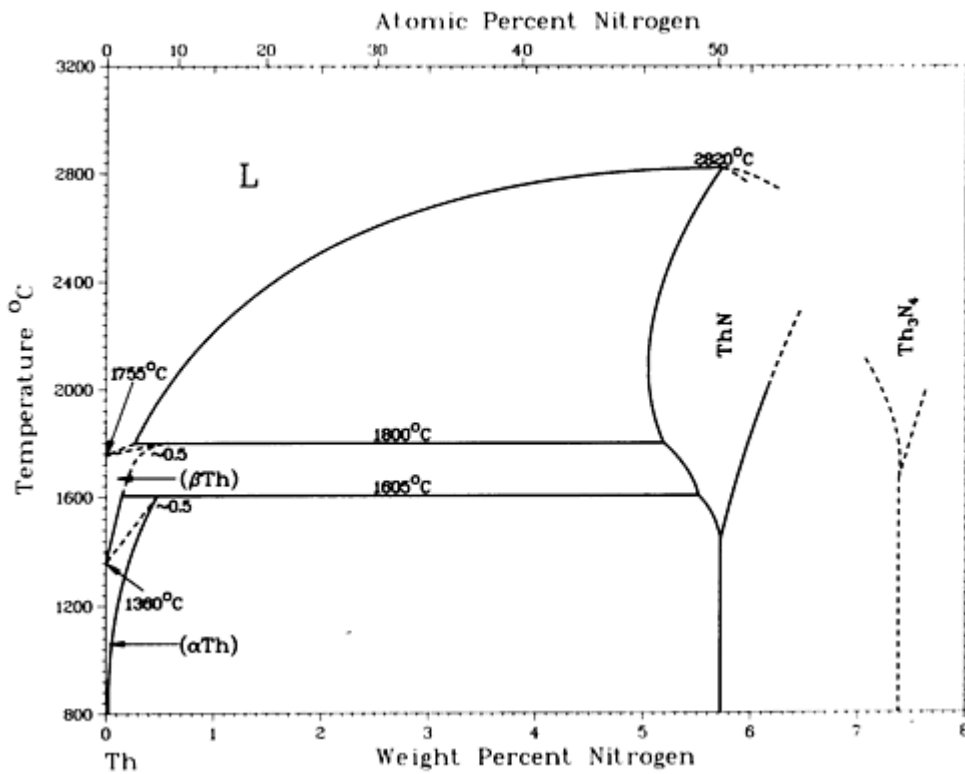

N-Th phase diagram

N-Th crystallographic data

Phase	Composition, wt% N	Pearson symbol	Space group
(β _{Th})	0	<i>cI2</i>	$Im\bar{3}m$

(α Th)	0	<i>cF4</i>	<i>Fm</i> $\bar{3}m$
ThN	~ 5.7	<i>cF8</i>	<i>Fm</i> $\bar{3}m$
Th ₃ N ₄	~ 7.4	<i>mC4</i> <i>o*18</i> <i>hR7</i>	<i>Cm</i> \dots <i>R</i> $\bar{3}m$
Th ₂ N ₃	8.3	<i>hP5</i>	<i>P</i> $\bar{3}m1$

N-Ti (Nitrogen - Titanium)

H.A. Wriedt and J.L. Murray, 1987

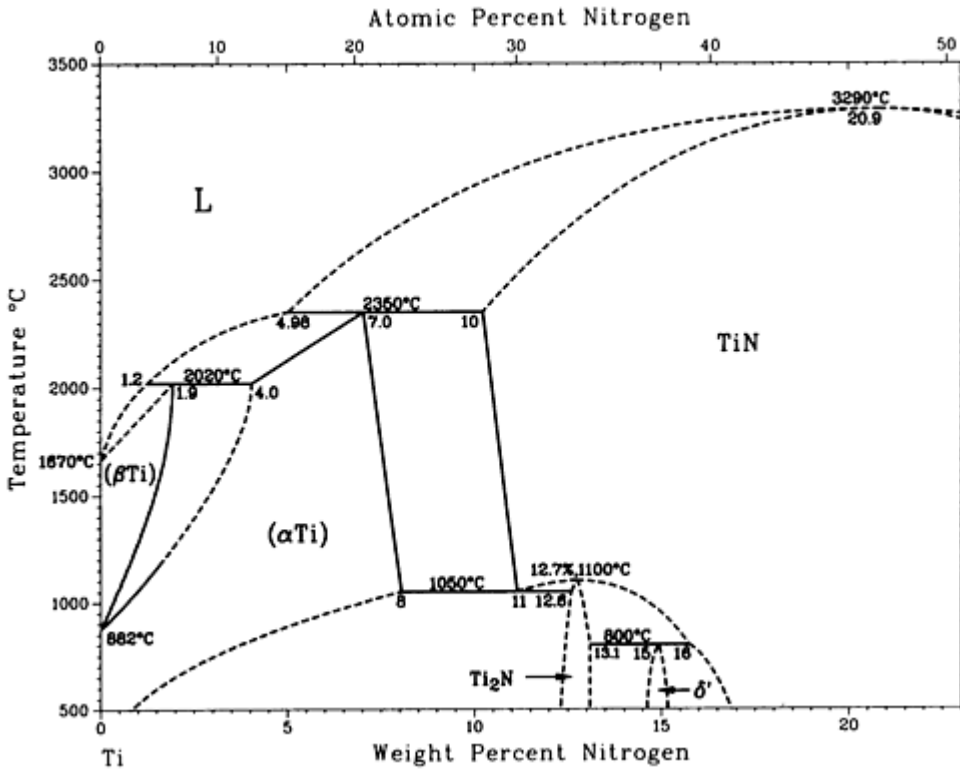

N-Ti phase diagram

N-Ti crystallographic data

Phase	Composition, wt% N	Pearson symbol	Space group
Stable phases			
(α Ti)	0 to 8	<i>hP2</i>	<i>P6</i> ₃ / <i>mmc</i>

(β_{Ti})	0 to 1.9	$cI2$	$Im\bar{3}m$
Ti ₂ N	~13	$tP6$	$P4_2/mnm$
TiN	10 to >22.6	$cF8$	$Fm\bar{3}m$
δ'	~15	$tI12$	$I4_1/amd$
ω	~0	h^{**}	...
Metastable phase			
α'	...	$tP6$	$P4_2/mnm$

N-U (Nitrogen - Uranium)

From [Metals] 10

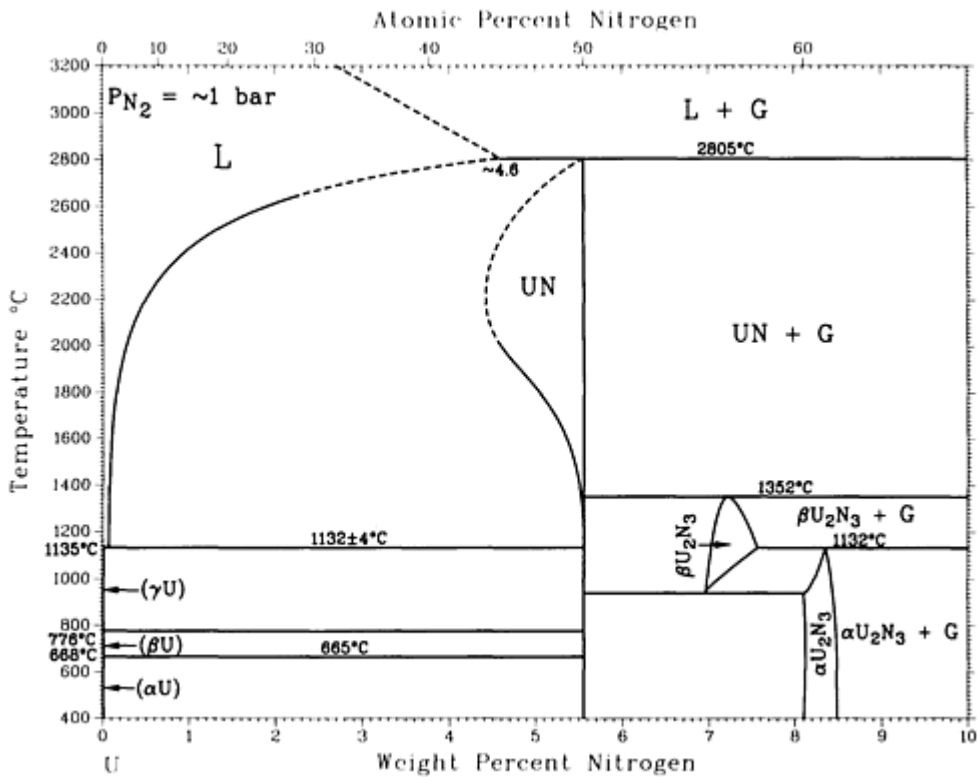

N-U phase diagram

N-U crystallographic data

Phase	Composition,	Pearson	Space
-------	--------------	---------	-------

	wt% N	symbol	group
(γ U)	~ 0	<i>cI2</i>	<i>Im$\bar{3}m$</i>
(β U)	~ 0	<i>tP30</i>	<i>P4₂/mnm</i>
(α U)	~ 0	<i>oC4</i>	<i>Cmcm</i>
UN	~ 4.4 to 5.6	<i>cF8</i>	<i>Fm$\bar{3}m$</i>
β U ₂ N ₃	~ 7 to 7.5	<i>hP5</i>	<i>P$\bar{3}m1$</i>
α U ₂ N ₃	~ 8 to 8.4	<i>cI80</i>	<i>Ia$\bar{3}$</i>
Other reported phases			
U ₄ N ₇	~ 9.3	<i>hR*</i>	...
UN ₂	~ 10.5	<i>cF12</i>	<i>Fm$\bar{3}m$</i>

Reference cited in this section

10. [Metals]: *Metals Handbook*, Metallography, Structures and Phase Diagrams, Vol.8, 8th ed., American Society for Metals, Metals Park, OH (1973).

N-Zr (Nitrogen - Zirconium)

From [Zirconium] 21

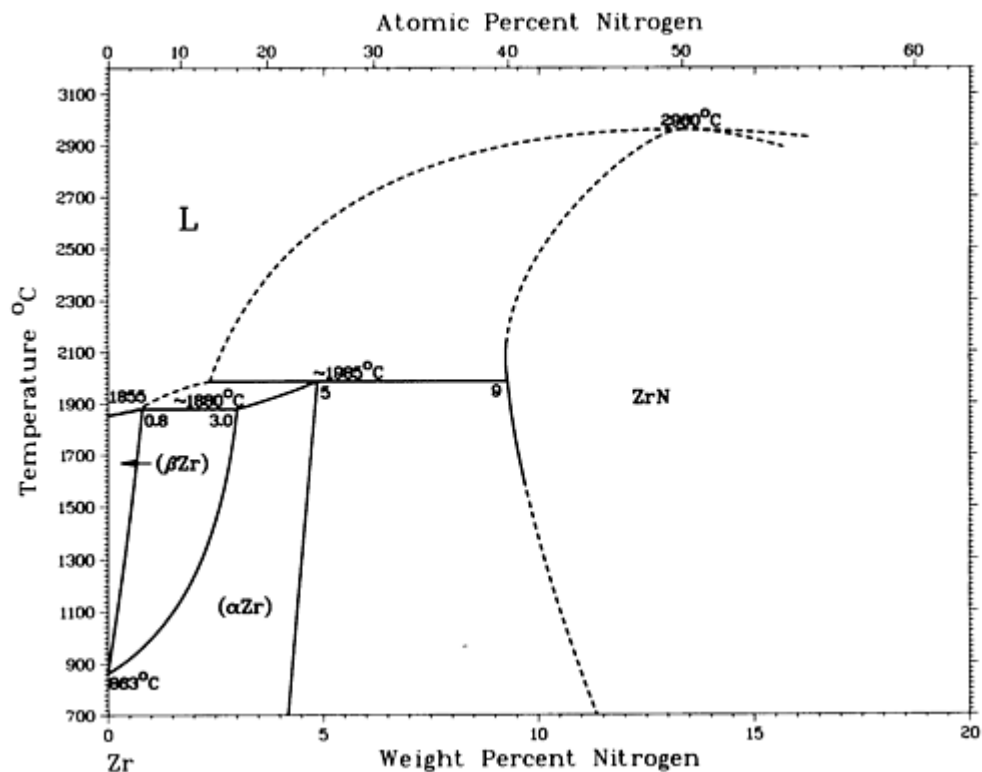

N-Zr phase diagram

N-Zr crystallographic data

Phase	Composition, wt% N	Pearson symbol	Space group
(β _{Zr})	0 to 0.7	cI2	$Im\bar{3}m$
(α _{Zr})	0 to 5	hP2	$P6_3/mmc$
ZrN	9 to ?	cF8	$Fm\bar{3}m$

Reference cited in this section

21. [Zirconium]: C.B. Alcock, K.T. Jacob, S. Zador, O. von Goldbeck, H. Nowotny, K. Seifert, and O. Kubaschewski, *Zirconium: Physico-Chemical Properties of Its Compounds and Alloys*, O. Kubaschewski, Ed., Atomic Energy Review Special Issue No.6, International Atomic Energy Agency, Vienna (1976).

Introduction

THIS ARTICLE includes systems where sodium is the first-named element in the binary pair. Additional binary systems that include sodium are provided in the following locations in this Volume:

- “Ag-Na (Silver - Sodium)” in the article “Ag (Silver) Binary Alloy Phase Diagrams.”
- “Au-Na (Gold - Sodium)” in the article “Au (Gold) Binary Alloy Phase Diagrams.”
- “Ba-Na (Barium - Sodium)” in the article “Ba (Barium) Binary Alloy Phase Diagrams.”
- “Bi-Na (Bismuth - Sodium)” in the article “Bi (Bismuth) Binary Alloy Phase Diagrams.”
- “Ca-Na (Calcium - Sodium)” in the article “Ca (Calcium) Binary Alloy Phase Diagrams.”
- “Cd-Na (Cadmium - Sodium)” in the article “Cd (Cadmium) Binary Alloy Phase Diagrams.”
- “Cl-Na (Chlorine - Sodium)” in the article “Cl (Chlorine) Binary Alloy Phase Diagrams.”
- “Cs-Na (Cesium - Sodium)” in the article “Cs (Cesium) Binary Alloy Phase Diagrams.”
- “Ga-Na (Gallium - Sodium)” in the article “Ga (Gallium) Binary Alloy Phase Diagrams.”
- “Ge-Na (Germanium - Sodium)” in the article “Ge (Germanium) Binary Alloy Phase Diagrams.”
- “Hg-Na (Mercury - Sodium)” in the article “Hg (Mercury) Binary Alloy Phase Diagrams.”
- “In-Na (Indium - Sodium)” in the article “In (Indium) Binary Alloy Phase Diagrams.”
- “K-Na (Potassium - Sodium)” in the article “K (Potassium) Binary Alloy Phase Diagrams.”
- “Li-Na (Lithium - Sodium)” in the article “Li (Lithium) Binary Alloy Phase Diagrams.”

Na-O (Sodium - Oxygen)

H.A. Wriedt, 1987

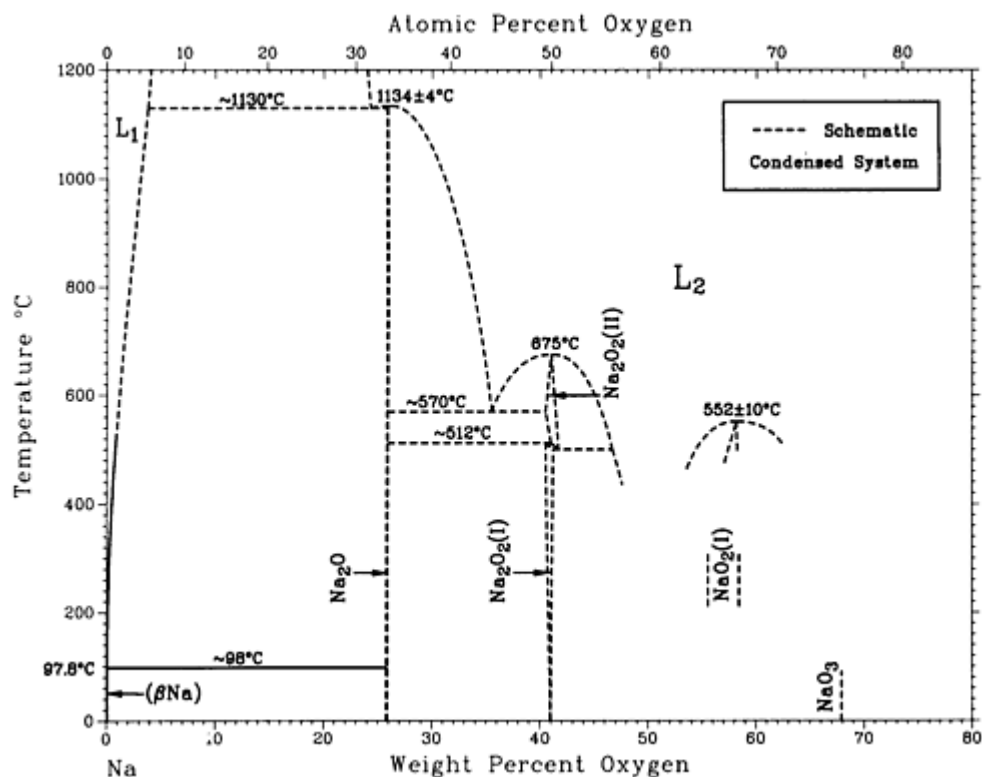

Na-O phase diagram

Na-O crystallographic data

Phase	Composition, wt% O	Pearson symbol	Space group
(β Na)	0	<i>cI2</i>	<i>Im$\bar{3}m$</i>
(α Na)	0	<i>hP2</i>	<i>P6$_3$/mmc</i>
Na ₂ O	25.8	<i>cF12</i>	<i>Fm$\bar{3}m$</i>
Na ₂ O ₂ -II	41.0
Na ₂ O ₂ -I	41.0	<i>hP9</i>	<i>P$\bar{6}2m$</i> ^(a)
NaO ₂ (I)	58.2	<i>cF8</i>	<i>Fm$\bar{3}m$</i>
NaO ₂ (II)	58.2	<i>cP12</i>	<i>Pa$\bar{3}$</i>
NaO ₂ (III)	58.2	<i>oP6</i>	<i>Pnm</i>
NaO ₃	68	bct	<i>I4/mmm</i>
Other phase			
Na ₂ O ₂ -Q ^(b)	41.0

(a) Might be *C $\bar{6}2m$* .

(b) Noncubic

Na-Pb (Sodium - Lead)

From [Metals] 10

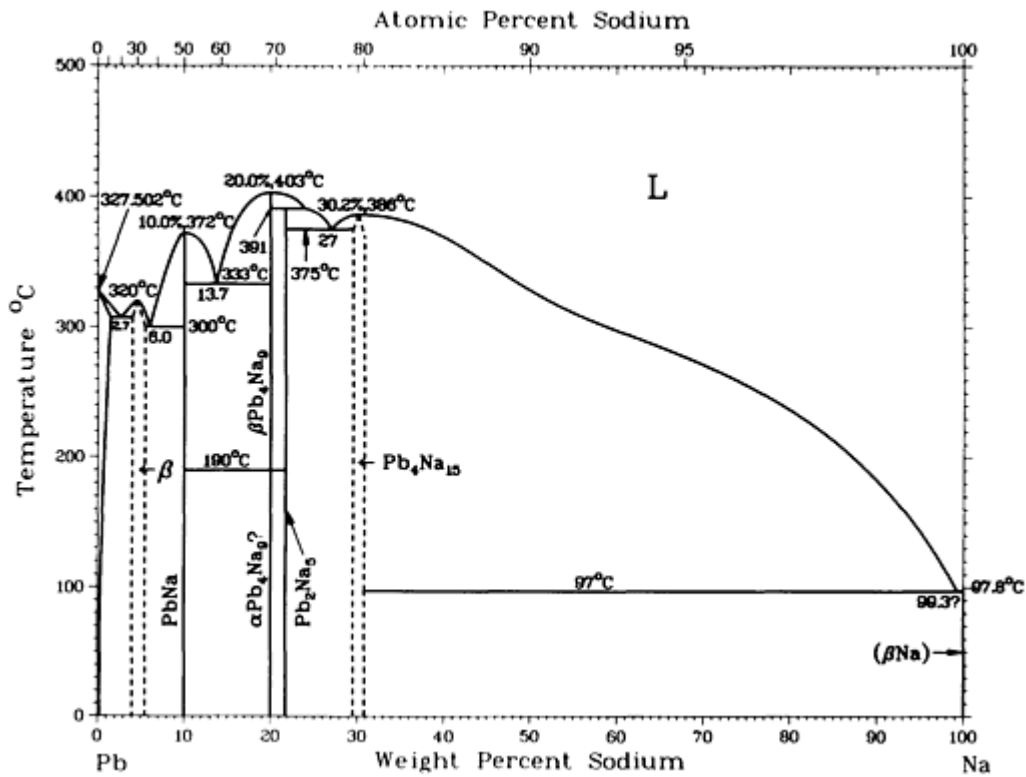

Na-Pb phase diagram

Na-Pb crystallographic data

Phase	Composition, wt% Na	Pearson symbol	Space group
(Pb)	0 to 2.7	<i>cF4</i>	<i>Fm</i> $\bar{3}m$
β (Pb ₃ Na)	>4 to >5	<i>cP4</i>	<i>Pm</i> $\bar{3}m$
PbNa	10.0	<i>tI64</i>	<i>I4</i> ₁ <i>acd</i>
Pb ₄ Na ₉	~20.0	<i>hP26</i>	<i>P6</i> ₃ <i>mmc</i>
Pb ₂ Na ₅	~21.7	<i>hR7</i>	<i>R</i> $\bar{3}m$
Pb ₄ Na ₁₅	~29 to 31	<i>cI76</i>	<i>I</i> $\bar{4}3d$
(β Na)	~100	<i>cI2</i>	<i>Im</i> $\bar{3}m$

Other reported phases			
Pb ₅ Na ₁₃	~22.4	<i>hP36</i>	<i>P6₃/mmc</i>
PbNa ₅	~36.5	<i>hP*</i>	...

Reference cited in this section

10. [Metals]: *Metals Handbook*, Metallography, Structures and Phase Diagrams, Vol.8, 8th ed., American Society for Metals, Metals Park, OH (1973).

Na-Rb (Sodium - Rubidium)

C.W. Bale, 1982

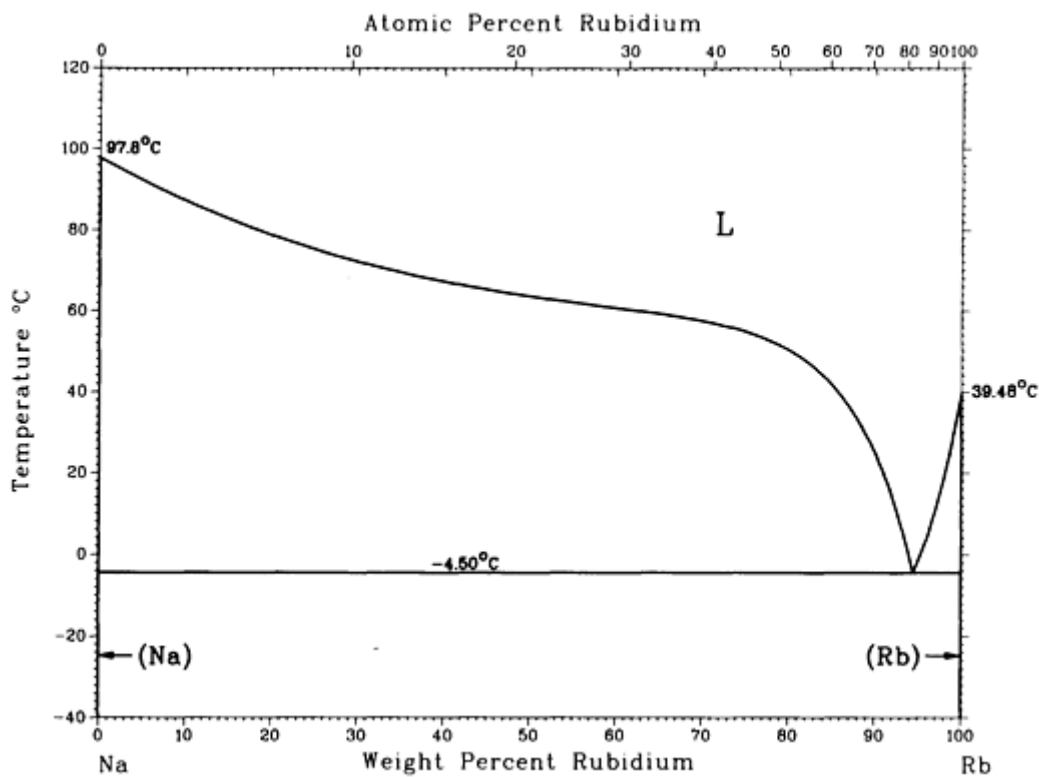

Na-Rb phase diagram

Na-Rb crystallographic data

Phase	Composition, wt% Rb	Pearson symbol	Space group
(Na)	0	<i>cI2</i>	<i>Im$\bar{3}m$</i>

(Rb)	100	<i>cI2</i>	<i>Im</i> $\bar{3}m$
------	-----	------------	----------------------

Na-S (Sodium - Sulfur)

H. Okamoto, 1990

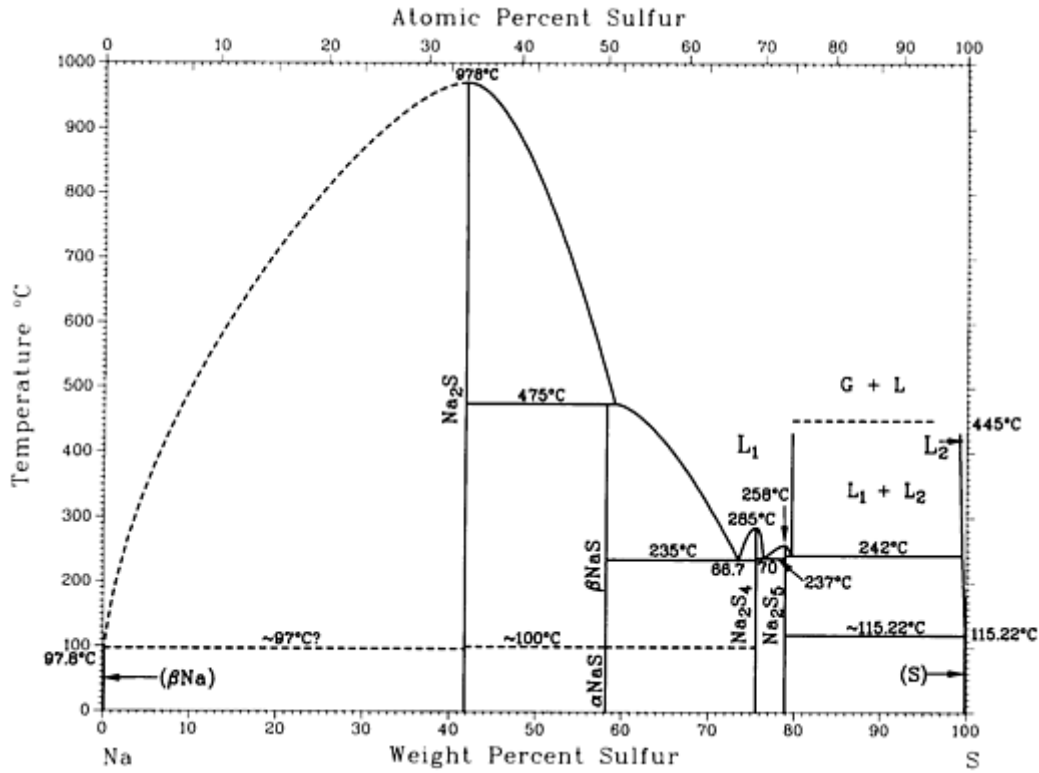

Na-S phase diagram

Na-S crystallographic data

Phase	Composition, wt% S	Pearson symbol	Space group
(βNa)	0	<i>cI2</i>	<i>Im</i> $\bar{3}m$
Na ₂ S	41.0	<i>cF12</i>	<i>Fm</i> $\bar{3}m$
βNaS	58.2	<i>hP8</i>	<i>P6₃/mmc</i>
αNaS	58.2	<i>hP12</i>	<i>P</i> $\bar{6}2m$
Na ₂ S ₄	73.6	<i>tI48</i>	<i>I</i> $\bar{4}2d$

Na ₃ S ₅	~78	<i>oP28</i>	<i>Pnma</i>
(S)	0	<i>mP64</i>	<i>P2₁/c</i>

Na-Sb (Sodium - Antimony)

C.H. Mathewson, 1906

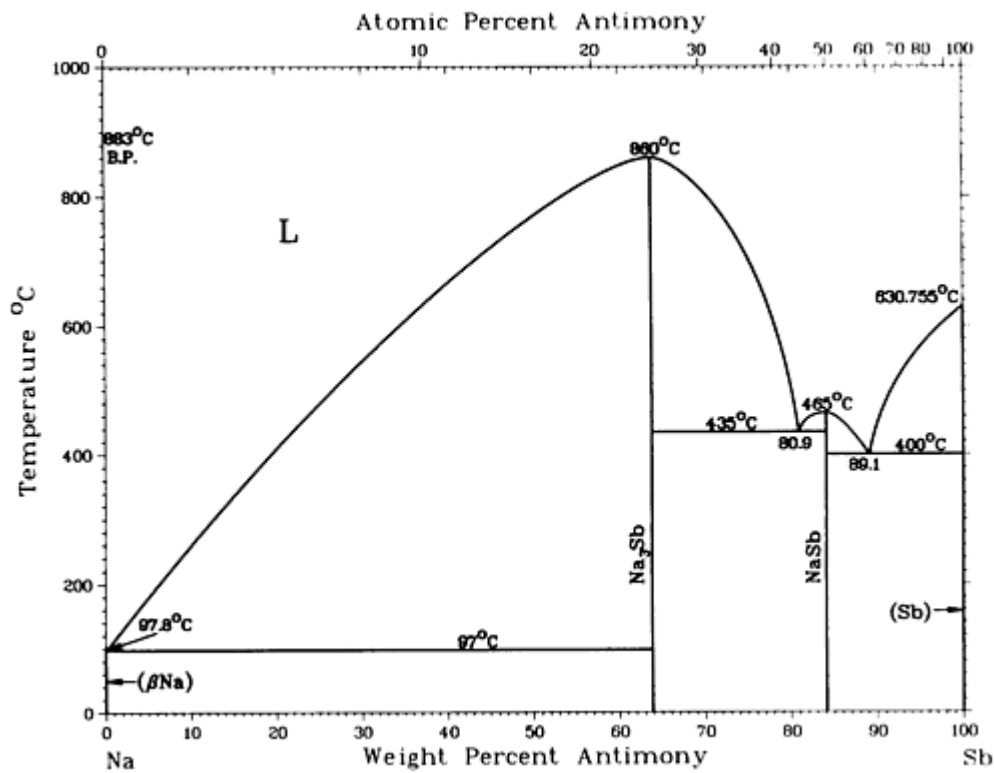

Na-Sb phase diagram

Na-Sb crystallographic data

Phase	Composition, wt% Sb	Pearson symbol	Space group
(βNa)	~0	<i>cI2</i>	<i>Im$\bar{3}m$</i>
Na ₃ Sb	64	<i>hP8</i>	<i>P6₃/mmc</i>
NaSb	84.1	<i>mP16</i>	<i>P2₁/c</i>
(Sb)	~100	<i>hR2</i>	<i>R$\bar{3}m$</i>

Na-Se (Sodium - Selenium)

H. Okamoto, 1990

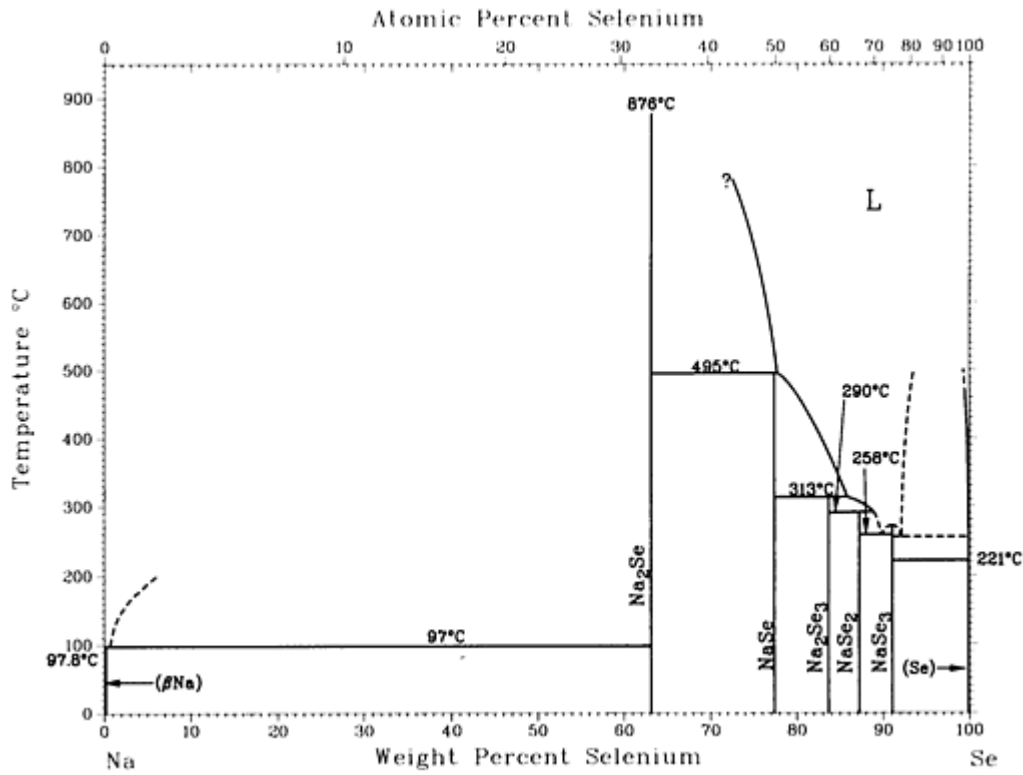

Na-Se phase diagram

Na-Se crystallographic data

Phase	Composition, wt% Se	Pearson symbol	Space group
(βNa)	0	<i>cI2</i>	<i>Im</i> $\bar{3}m$
Na ₂ Se	63.2	<i>cF12</i>	<i>Fm</i> $\bar{3}m$
NaSe	77.4	<i>hP8</i>	<i>P6</i> ₃ <i>/mmc</i>
Na ₂ Se ₃	84
NaSe ₂	87.3
NaSe ₃	91
(Se)	100	<i>hP3</i>	<i>P3</i> ₁ <i>21</i>

Na-Sn (Sodium - Tin)

H. Okamoto, 1990

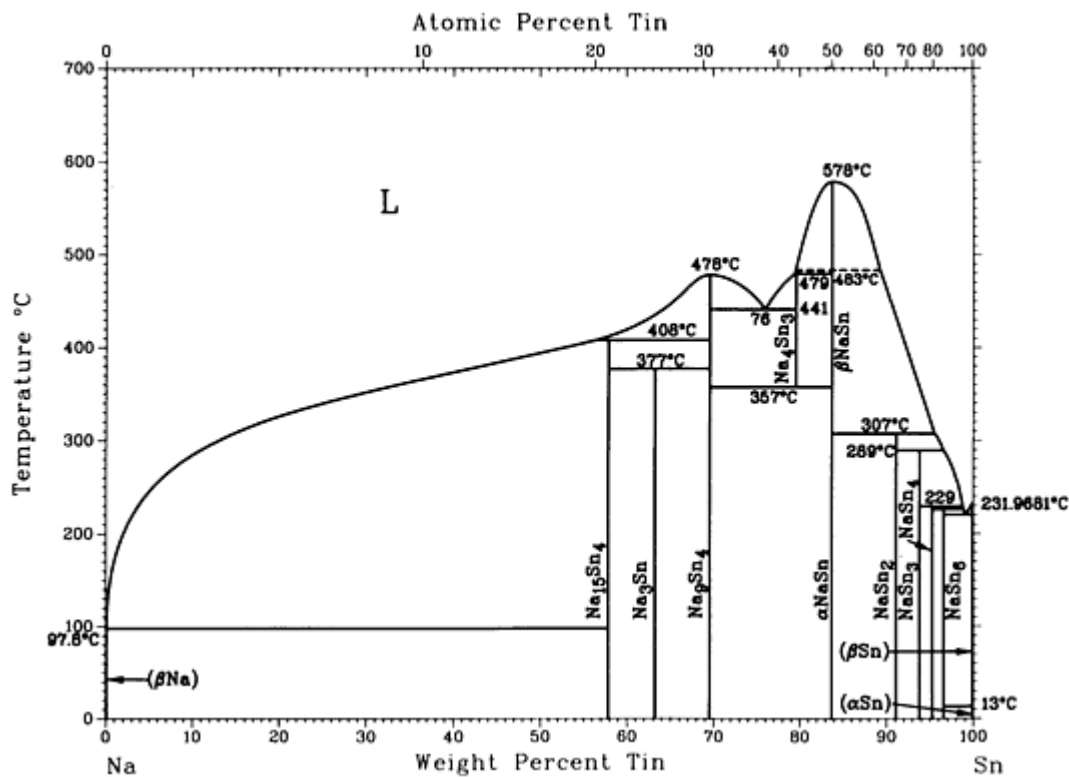

Na-Sn phase diagram

Na-Sn crystallographic data

Phase	Composition, wt% Sn	Pearson symbol	Space group
β Na	0	<i>cI2</i>	$Im\bar{3}m$
$\text{Na}_{15}\text{Sn}_4$	58	<i>cI76</i> <i>oP40</i>	$I\bar{4}3d$ $Pnma$
Na_3Sn	63
Na_9Sn_4	69.7	<i>oC52</i>	$Cmcm$
Na_4Sn_3	79.5
βNaSn	83.8

α NaSn	83.8	<i>tI64</i>	<i>I4₁/acd</i>
NaSn ₂	91.2
NaSn ₃	94
NaSn ₄	95
NaSn ₆	96.9
(β Sn)	100	<i>tI2</i>	<i>I4₁/amd</i>
(α Sn)	100	<i>cF8</i>	<i>Fd$\bar{3}m$</i>

Na-Sr (Sodium - Strontium)

A.D. Pelton, 1985

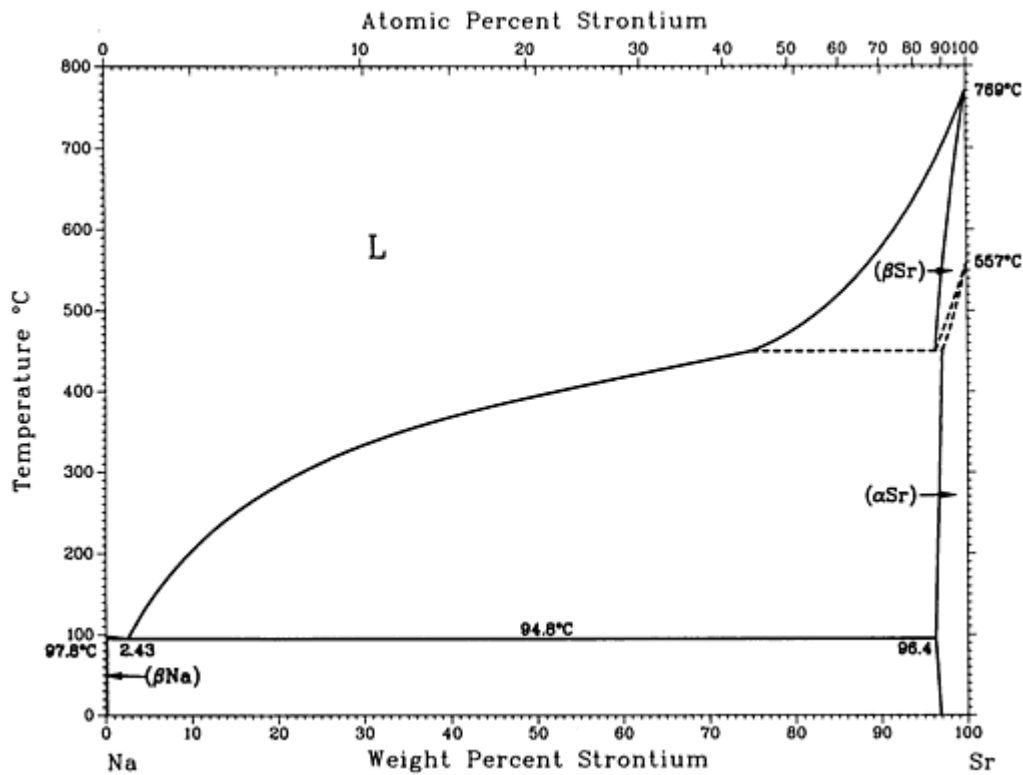

Na-Sr phase diagram

Na-Sr crystallographic data

Phase	Composition,	Pearson	Space
-------	--------------	---------	-------

	wt% Sr	symbol	group
(β Na)	0	<i>cI2</i>	<i>Im</i> $\bar{3}m$
(α Na)	0	<i>hP2</i>	<i>P6</i> $\bar{3}/mmc$
(β Sr)	97.2 to 100	<i>cI2</i>	<i>Im</i> $\bar{3}m$
(α Sr)	96.4 to 100	<i>cF4</i>	<i>Fm</i> $\bar{3}m$

Na-Te (Sodium - Tellurium)

A.D. Pelton and A. Petric, 1990

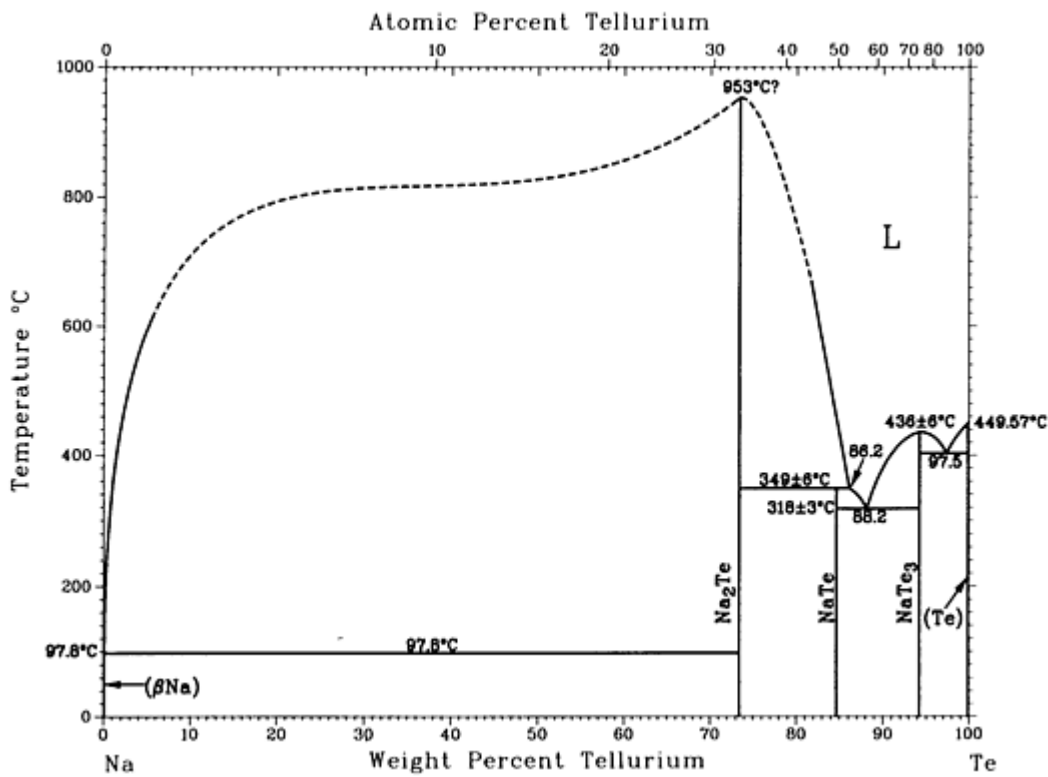

Na-Te phase diagram

Na-Te crystallographic data

Phase	Composition, wt% Te	Pearson symbol	Space group
(β Na)	0	<i>cI2</i>	<i>Im</i> $\bar{3}m$

(α Na)	0	<i>hP2</i>	<i>P6₃/mmc</i>
Na ₂ Te	73.5	<i>cF12</i>	<i>Fm$\bar{3}m$</i>
NaTe	84.7
NaTe ₃	94
(Te)	100	<i>hP3</i>	<i>P3₁21</i>

Na-Tl (Sodium - Thallium)

G. Grube and A. Schmidt, 1936

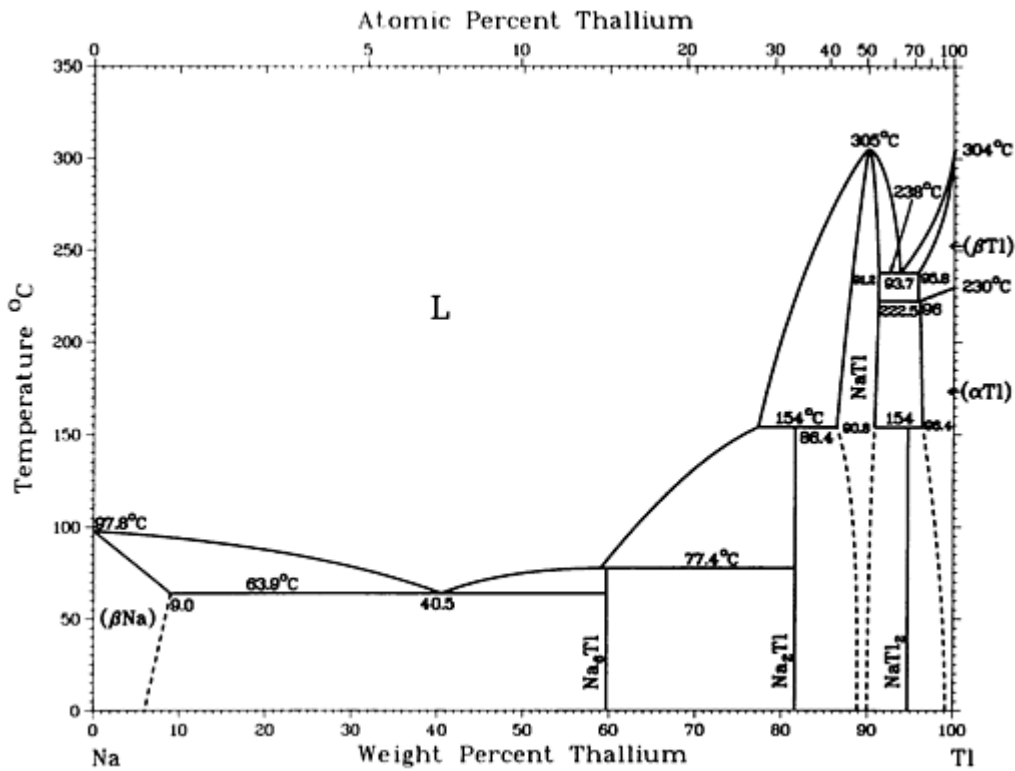

Na-Tl phase diagram

Na-Tl crystallographic data

Phase	Composition, wt% Tl	Pearson symbol	Space group
(β Na)	0 to 9.0	<i>cI2</i>	<i>Im$\bar{3}m$</i>

Na ₆ Tl	~59.7	cF400	<i>F</i> $\bar{4}3m$
Na ₂ Tl	81.6	oC48	<i>C</i> 222 ₁
NaTl	86.4 to 91.2	cF16	<i>Fd</i> $\bar{3}m$
NaTl ₂	94.7
(β Tl)	95.8 to 100	cI2	<i>Im</i> $\bar{3}m$
(α Tl)	96 to 100	hP2	<i>P</i> 6 ₃ /mmc

Nb (Niobium) Binary Alloy Phase Diagrams

Introduction

THIS ARTICLE includes systems where niobium is the first-named element in the binary pair. Additional binary systems that include niobium are provided in the following locations in this Volume:

- “Al-Nb (Aluminum - Niobium)” in the article “Al (Aluminum) Binary Alloy Phase Diagrams.”
- “Au-Nb (Gold - Niobium)” in the article “Au (Gold) Binary Alloy Phase Diagrams.”
- “B-Nb (Boron - Niobium)” in the article “B (Boron) Binary Alloy Phase Diagrams.”
- “Be-Nb (Beryllium - Niobium)” in the article “Be (Beryllium) Binary Alloy Phase Diagrams.”
- “Co-Nb (Cobalt - Niobium)” in the article “Co (Cobalt) Binary Alloy Phase Diagrams.”
- “Cr-Nb (Chromium - Niobium)” in the article “Cr (Chromium) Binary Alloy Phase Diagrams.”
- “Cu-Nb (Copper - Niobium)” in the article “Cu (Copper) Binary Alloy Phase Diagrams.”
- “Fe-Nb (Iron - Niobium)” in the article “Fe (Iron) Binary Alloy Phase Diagrams.”
- “Ga-Nb (Gallium - Niobium)” in the article “Ga (Gallium) Binary Alloy Phase Diagrams.”
- “Ge-Nb (Germanium - Niobium)” in the article “Ge (Germanium) Binary Alloy Phase Diagrams.”
- “H-Nb (Hydrogen - Niobium)” in the article “H (Hydrogen) Binary Alloy Phase Diagrams.”
- “Hf-Nb (Hafnium - Niobium)” in the article “Hf (Hafnium) Binary Alloy Phase Diagrams.”
- “In-Nb (Indium - Niobium)” in the article “In (Indium) Binary Alloy Phase Diagrams.”
- “Ir-Nb (Iridium - Niobium)” in the article “Ir (Iridium) Binary Alloy Phase Diagrams.”
- “Mo-Nb (Molybdenum - Niobium)” in the article “Mo (Molybdenum) Binary Alloy Phase Diagrams.”
- “N-Nb (Nitrogen - Niobium)” in the article “N (Nitrogen) Binary Alloy Phase Diagrams.”

Nb-Ni (Niobium - Nickel)

H. Okamoto, 1992

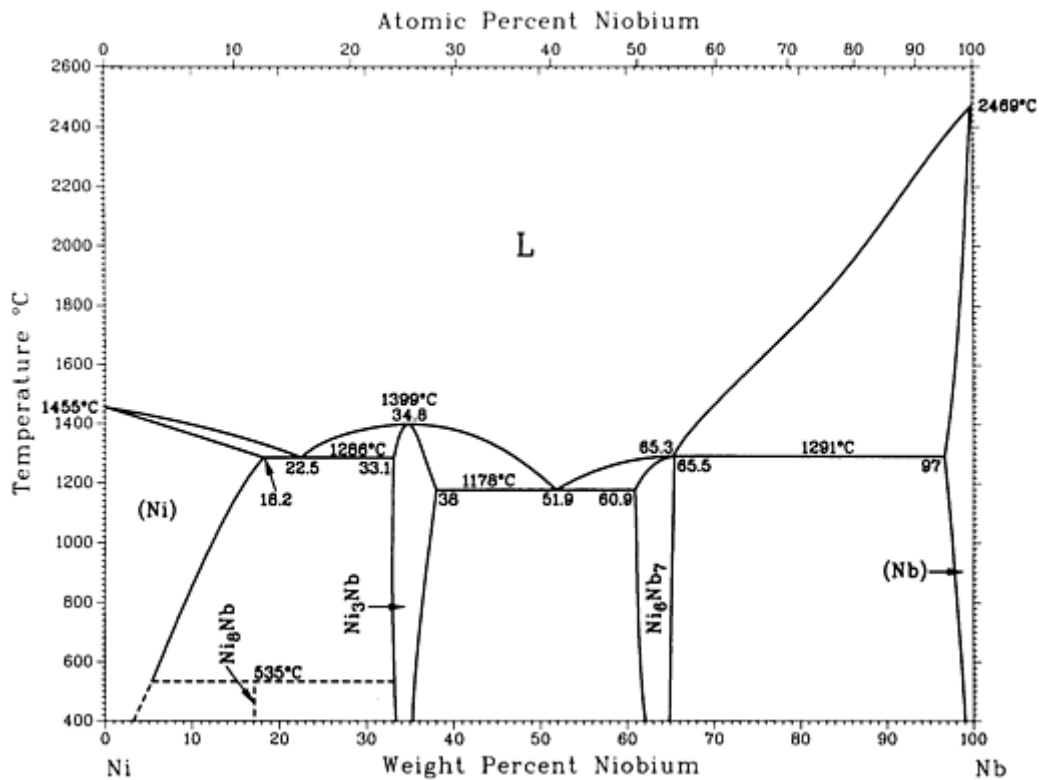

Nb-Ni phase diagram

Nb-Ni crystallographic data

Phase	Composition, wt% Nb	Pearson symbol	Space group
(Ni)	0 to 18.2	<i>cF4</i>	<i>Fm</i> $\bar{3}m$
Ni ₈ Nb	16.5	<i>tI36</i>	...
Ni ₃ Nb	33.1 to 38.0	<i>oP8</i>	<i>Pmmn</i>
Ni ₆ Nb ₇	60.9 to 65.5	<i>hR13</i>	<i>R</i> $\bar{3}m$
(Nb)	97 to 100	<i>cI2</i>	<i>Im</i> $\bar{3}m$

Nb-Os (Niobium - Osmium)

R.M. Waterstrat and R.C. Manuszewski, 1977

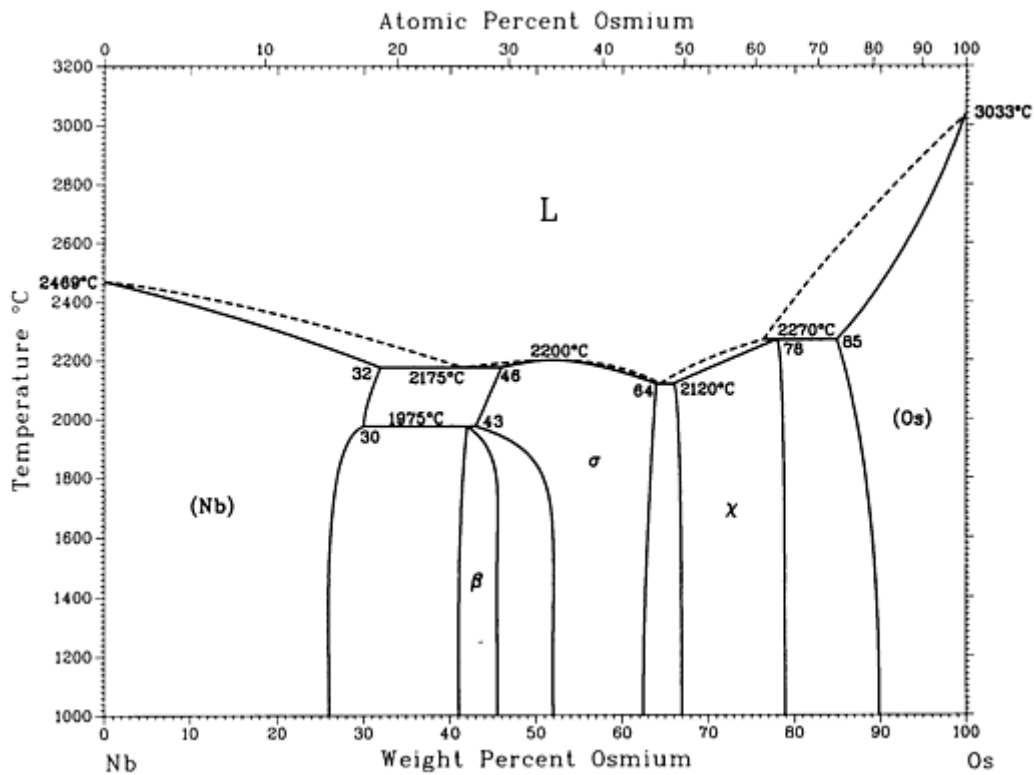

Nb-Os phase diagram

Nb-Os crystallographic data

Phase	Composition, wt% Os	Pearson symbol	Space group
(Nb)	0 to 32	<i>cI2</i>	$Im\bar{3}m$
β	>41 to ~46	<i>cP8</i>	$Pm\bar{3}n$
σ	43 to 64	<i>tP30</i>	$P4_2/mnm$
χ	66 to 78	<i>cI58</i>	$I\bar{4}3m$
(Os)	85 to 100	<i>hP2</i>	$P6_3/mmc$

Nb-Pd (Niobium - Palladium)

M.S. Chandrasekharaiah, 1988

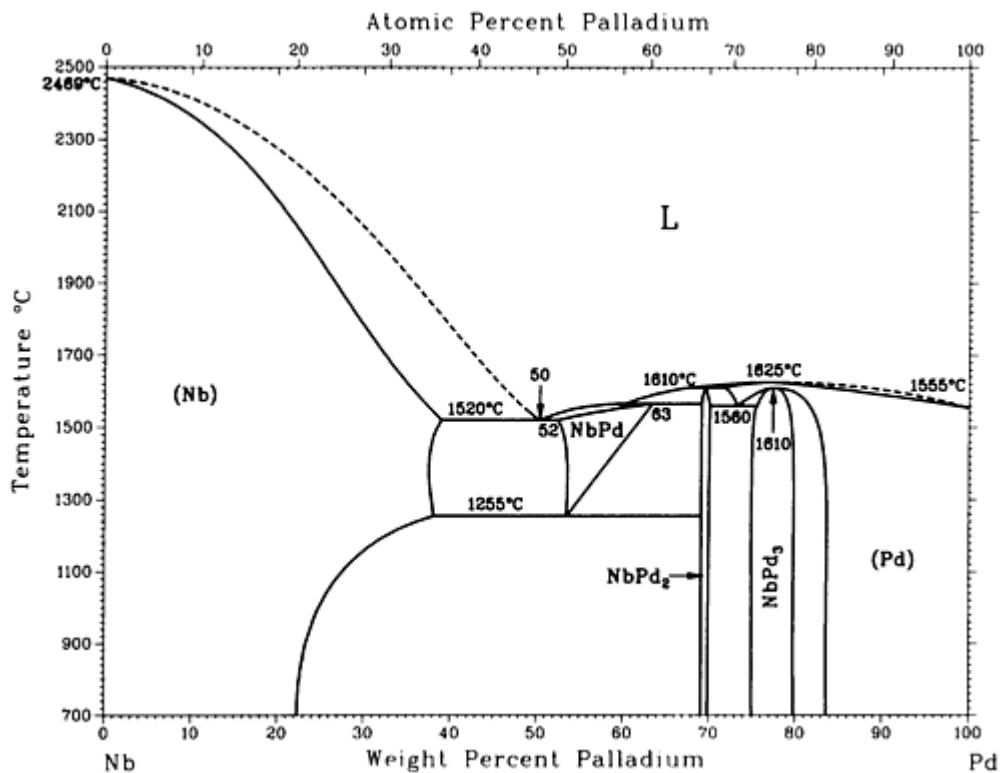

Nb-Pd phase diagram

Nb-Pd crystallographic data

Phase	Composition, wt% Pd	Pearson symbol	Space group
(Nb)	0 to 39	<i>cI2</i>	<i>Im</i> $\bar{3}m$
NbPd ^(a)	52 to 63	<i>cF4</i>	<i>Fm</i> $\bar{3}m$
NbPd ₂	69.2 to 70.1	<i>oI14</i>	<i>Immm</i>
α NbPd ₃	78 ^(b)	<i>tI8</i>	<i>I4/mmm</i>
β NbPd ₃	76 to 78	...	<i>Pmmn</i>
(Pd)	73 to 100	<i>cF4</i>	<i>Fm</i> $\bar{3}m$

(a) Data from rapidly quenched samples.

(b) At 1300 °C

Nb-Pt (Niobium - Platinum)

H. Okamoto, 1990

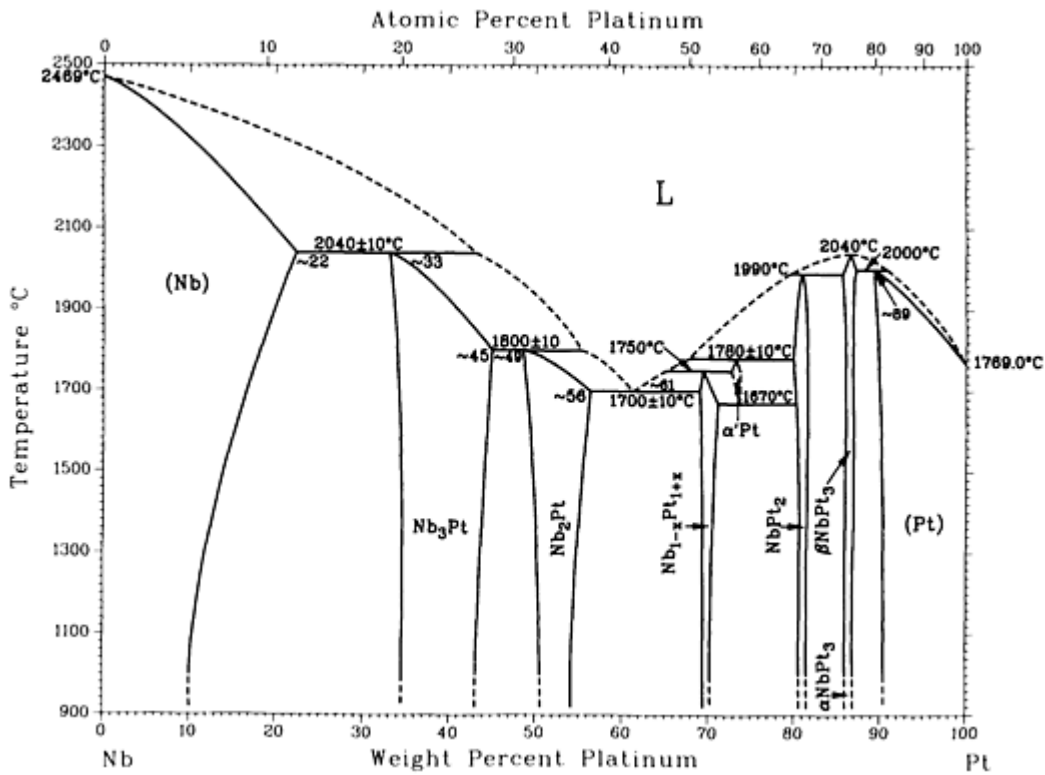

Nb-Pt phase diagram

Nb-Pt crystallographic data

Phase	Composition, wt% Pt	Pearson symbol	Space group
(Nb)	0 to ~22	<i>cI2</i>	<i>Im</i> $\bar{3}m$
Nb ₃ Pt	~33 to ~45	<i>cP8</i>	<i>Pm</i> $\bar{3}n$
Nb ₂ Pt	~49 to ~56	<i>tP30</i>	<i>P4</i> ₂ / <i>mmm</i>
Nb _{1-x} Pt _{1+x}	69 to 70	<i>oP4</i>	<i>Pmma</i>

α' Pt	~74
NbPt ₂	~81	<i>oI6</i>	<i>Immm</i>
β NbPt ₃	~87	<i>mP48</i>	<i>P2₁/m</i>
α NbPt ₃	~87	<i>oP8</i>	<i>Pmmm</i>
(Pt)	~89 to 100	<i>cF4</i>	<i>Fm$\bar{3}m$</i>

Nb-Rh (Niobium - Rhodium)

D.L. Ritter, B.C. Giessen, and N.J. Grant, 1964

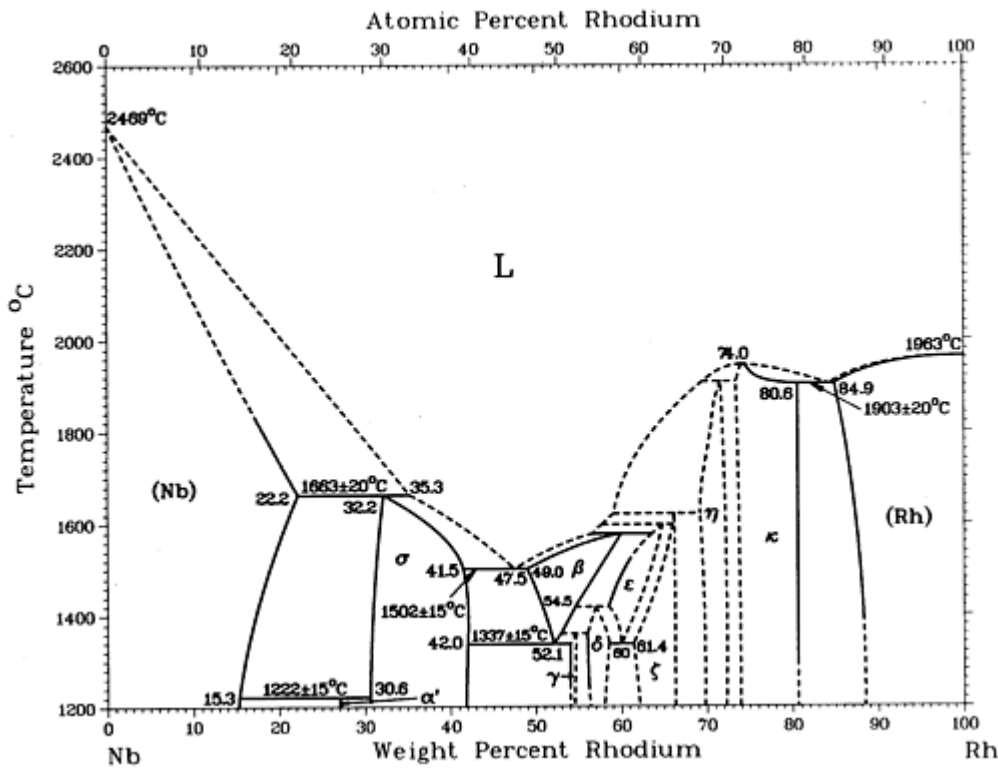

Nb-Rh phase diagram

Nb-Rh crystallographic data

Phase	Composition, wt% Rh	Pearson symbol	Space group
(Nb)	0 to 22.2	<i>cI2</i>	<i>Im$\bar{3}m$</i>

α' (Nb ₃ Rh)	27	<i>cP8</i>	<i>Pm</i> $\bar{3}n$
σ (Nb ₁₃ Rh ₇)	30.6 to 42.0	<i>tP30</i>	<i>P4</i> ₂ / <i>mnm</i>
β	49.0 to \sim 61
γ	\sim 54.0 to 55	<i>tP2</i>	<i>P4</i> / <i>mmm</i>
δ	\sim 56.0 to 59	<i>o**</i>	...
ϵ (Nb ₂ Rh ₃)	\sim 59 to 64	<i>oP4</i>	<i>Pmma</i>
ζ (Nb ₂ Rh ₃)	61 to \sim 66	<i>mP18</i>	<i>P2</i> / <i>m</i>
η (Nb ₁₃ Rh ₂₇)	\sim 69 to 72	<i>hP24</i>	<i>P</i> $\bar{6}$ <i>m2</i>
κ (NbRh ₃)	\sim 73 to 80.6	<i>cP4</i>	<i>Pm</i> $\bar{3}m$
(Rh)	84.9 to 100	<i>cF4</i>	<i>Fm</i> $\bar{3}m$
Other reported phases			
NbRh	\sim 52.6	<i>tP2</i> <i>oP4</i>	<i>P4</i> / <i>mmm</i> <i>Pnma</i>
Nb ₉ Rh ₁₁	58	<i>oP12</i>	<i>Pnma</i>

Nb-Ru (Niobium - Ruthenium)

H. Okamoto, 1990

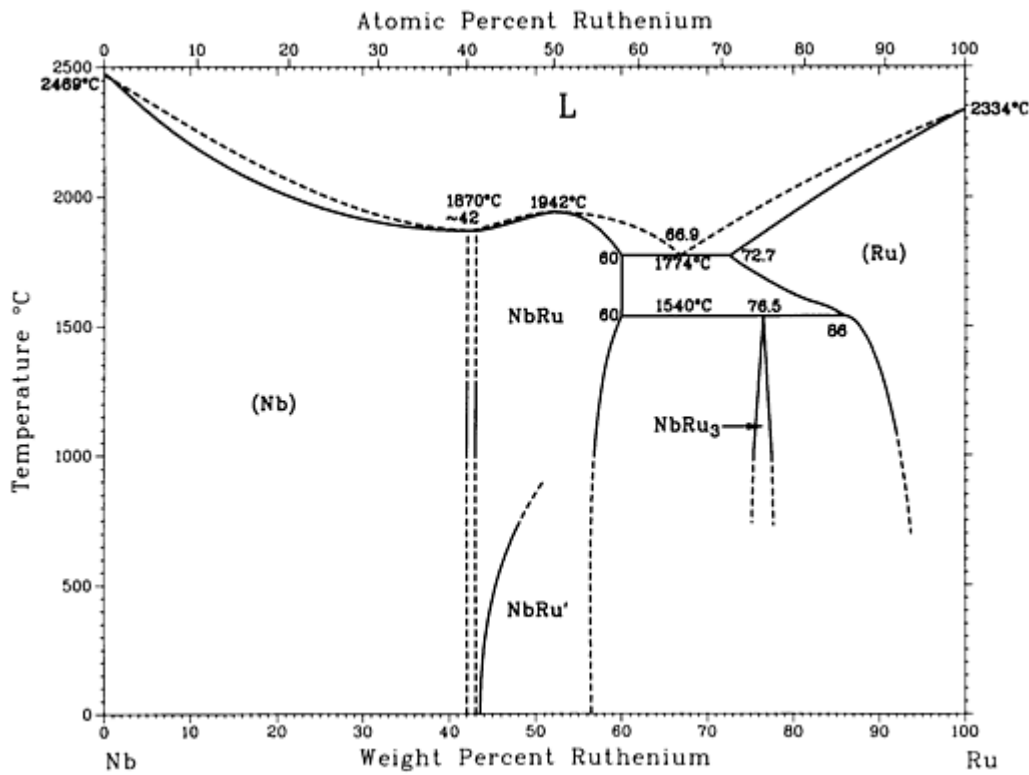

Nb-Ru phase diagram

Nb-Ru crystallographic data

Phase	Composition, wt% Ru	Pearson symbol	Space group
(Nb)	0	<i>cI2</i>	<i>Im</i> $\bar{3}m$
NbRu	43 to 60	<i>cP2</i>	<i>Pm</i> $\bar{3}m$
NbRu'	?	<i>tP2</i>	<i>P4/mmm</i>
NbRu ₃	76.5	<i>cP4</i>	<i>Pm</i> $\bar{3}m$
(Ru)	72.7 to 100	<i>hP2</i>	<i>P6₃/mmc</i>

Nb-Si (Niobium - Silicon)

H. Okamoto, A.B. Gokhale, and G.J. Abbaschian, unpublished

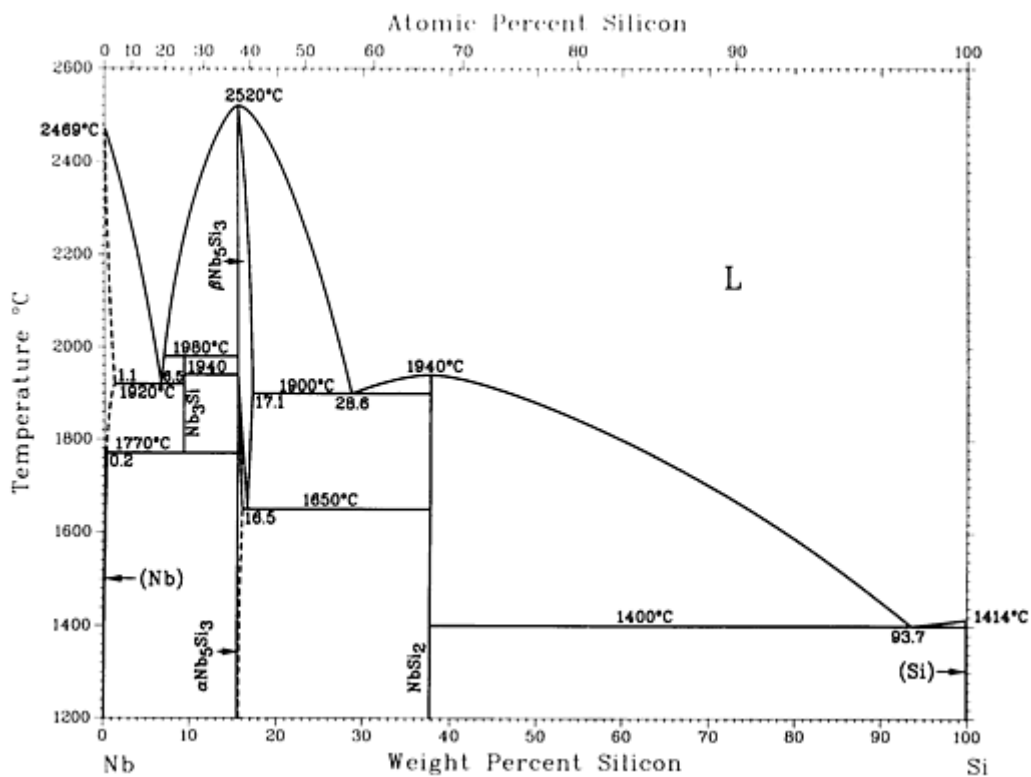

Nb-Si phase diagram

Nb-Si crystallographic data

Phase	Composition, wt% Si	Pearson symbol	Space group
(Nb)	0 to 1.1	<i>cI2</i>	<i>Im</i> $\bar{3}m$
Nb ₃ Si	9	<i>tP32</i>	<i>P4</i> ₂ / <i>n</i>
β-Nb ₅ Si ₃	15.4 to 17.1	<i>tI32</i>	<i>I4/mcm</i>
α-Nb ₅ Si ₃	15.4 to 15.9	<i>tI32</i>	<i>I4/mcm</i>

NbSi ₂	37.7	<i>hP9</i>	<i>P6₄22</i>
(Si)	100	<i>cF8</i>	<i>Fd$\bar{3}m$</i>
Metastable phases			
Nb ₇ Si	2.9 to 4.3	<i>c**</i>	...
Nb ₃ Si-m	3.2 to 7.9	<i>cP8</i>	<i>Pm$\bar{3}n$</i>
Nb ₃ Si-m'	3.2 to 10.1	<i>cF4</i>	<i>Fm$\bar{3}m$</i>
Nb ₃ Si-m''	9.2	<i>cF4</i>	<i>Pm$\bar{3}m$</i>
γ Nb ₅ Si ₃	15.4	<i>hP16</i>	<i>P6₃/mcm</i>
High-pressure phase			
Nb ₃ Si-I	9.2	<i>t**</i>	...

Nb-Ta (Niobium - Tantalum)

R. Krishnan, S.P. Garg, and N. Krishnamurthy, 1982

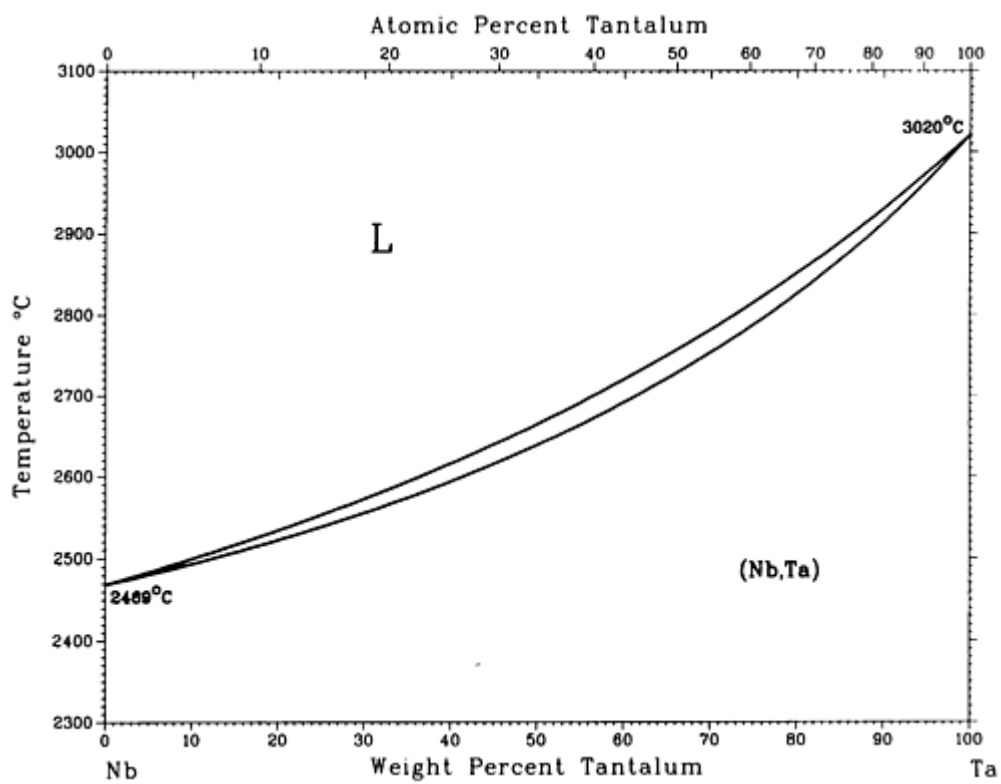

Nb-Ta phase diagram

Nb-Ta crystallographic data

Phase	Composition, wt% Ta	Pearson symbol	Space group
(Nb,Ta)	0 to 100	<i>cI2</i>	<i>Im</i> $\bar{3}m$

Nb-Th (Niobium - Thorium)

O.N. Carlson, J.M. Dickerson, H.E. Lunt, and H.A. Wilhelm, 1956

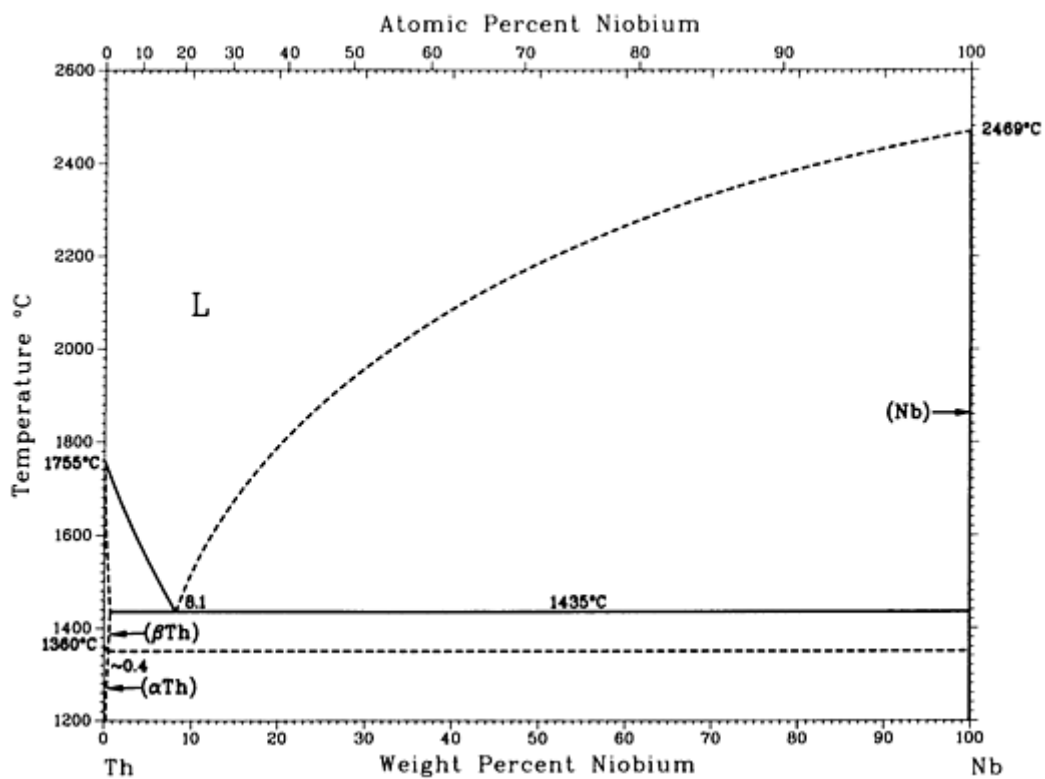

Nb-Th phase diagram

Nb-Th crystallographic data

Phase	Composition, wt% Nb	Pearson symbol	Space group
(βTh)	0 to ~0.6	<i>cI2</i>	<i>Im</i> $\bar{3}m$
(αTh)	0 to ~0.4	<i>cF4</i>	<i>Fm</i> $\bar{3}m$
(Nb)	100	<i>cI2</i>	<i>Im</i> $\bar{3}m$

Nb-Ti (Niobium - Titanium)

J.L. Murray, 1987

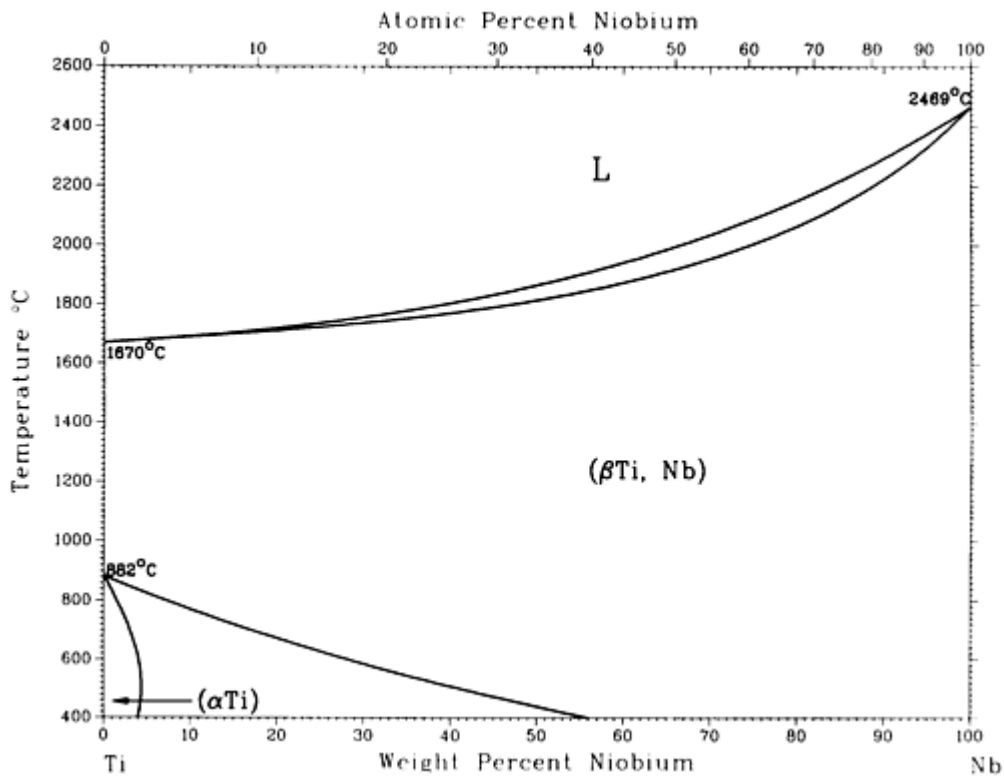

Nb-Ti phase diagram

Nb-Ti crystallographic data

Phase	Composition, wt% Nb	Pearson symbol	Space group
($\beta_{\text{Ti,Nb}}$)	0 to 100	<i>cI2</i>	<i>Im$\bar{3}m$</i>
(α_{Ti})	0 to 4.7	<i>hP2</i>	<i>P6$_3$/mmc</i>
Metastable phases			
(α' Ti)	0 to ~9	<i>hP2</i>	<i>P6$_3$/mmc</i>
(α'' Ti)	~14 to 43	<i>oC4</i>	<i>Cmcm</i>
ω	16 to 45	<i>hP3</i>	<i>P6/mmm</i>
τ	26 to 41	(a)	...

(a) bct

Nb-U (Niobium - Uranium)

H. Okamoto, 1990

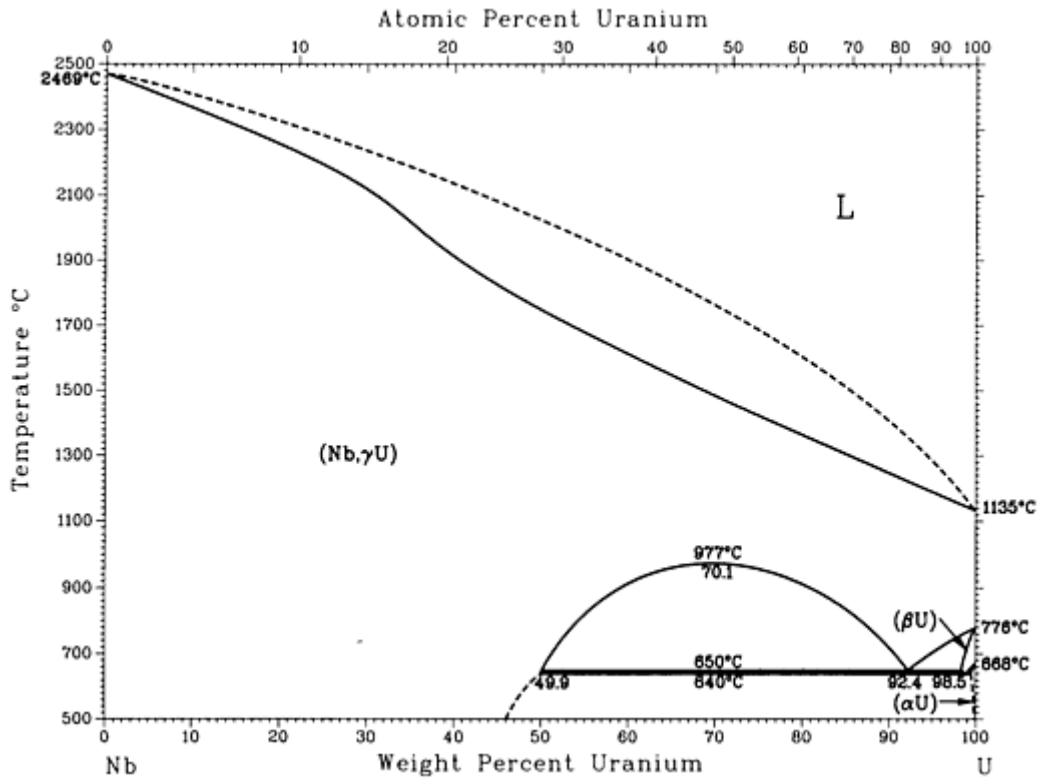

Nb-U phase diagram

Nb-U crystallographic data

Phase	Composition, wt% U	Pearson symbol	Space group
(Nb, γ U)	0 to 100	<i>cI2</i>	<i>Im</i> $\bar{3}m$
(β U)	98.5 to 100	<i>cF4</i>	<i>Fm</i> $\bar{3}m$
(α U)	\sim 100	<i>hP2</i>	<i>P6</i> $_3/mmc$

Nb-V (Niobium - Vanadium)

J.F. Smith and O.N. Carlson, 1989

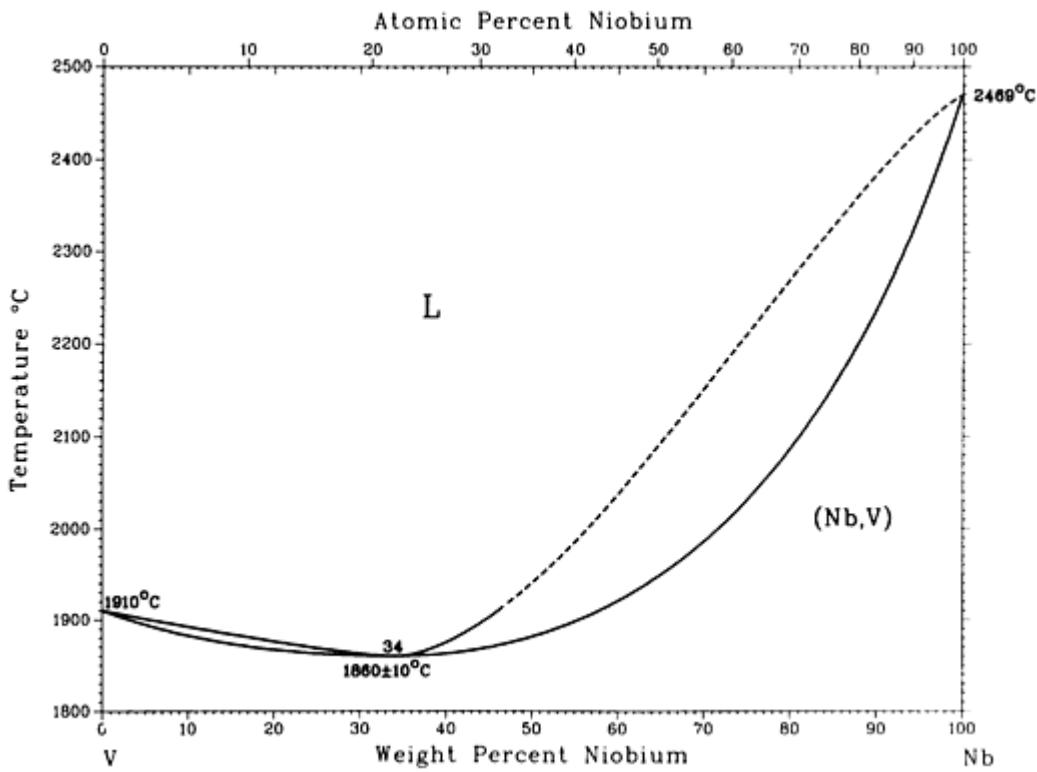

Nb-V phase diagram

Nb-V crystallographic data

Phase	Composition, wt% Nb	Pearson symbol	Space group
(V,Nb)	0 to 100	<i>cI2</i>	<i>Im$\bar{3}m$</i>

Nb-W (Niobium - Tungsten)

S.V. Nagender Naidu, A.M. Sriramamurthy, and P. Rama Rao, 1988

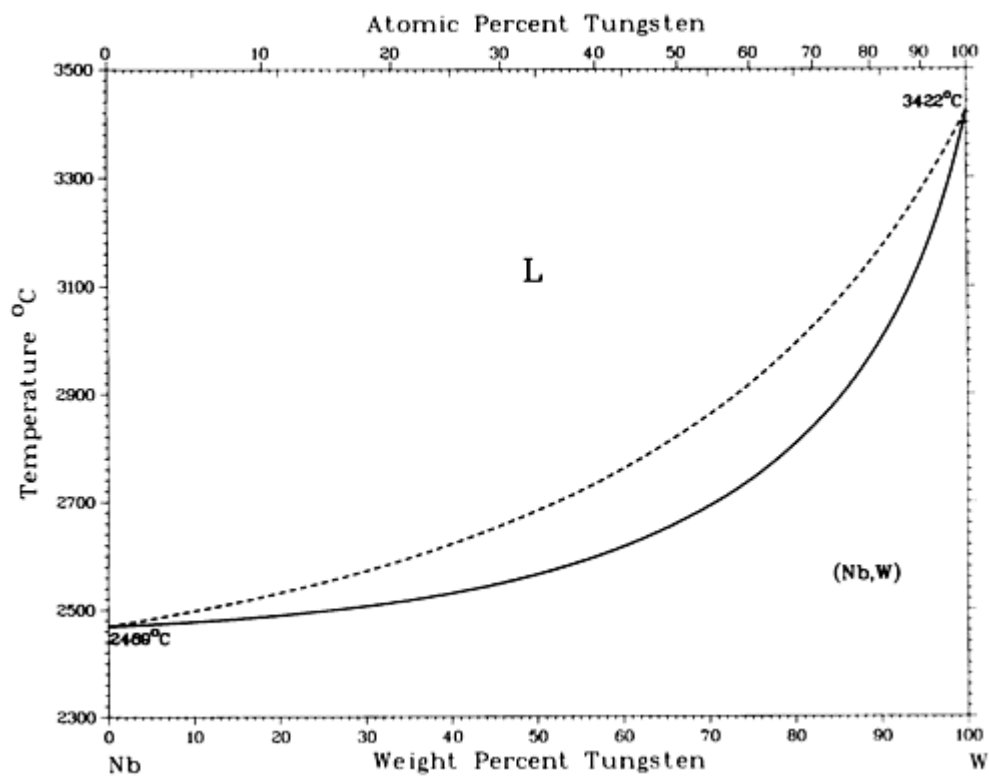

Nb-W phase diagram

Nb-W crystallographic data

Phase	Composition, wt% W	Pearson symbol	Space group
(Nb,W)	0 to 100	<i>cI2</i>	<i>Im</i> $\bar{3}m$

Nb-Zr (Niobium - Zirconium)

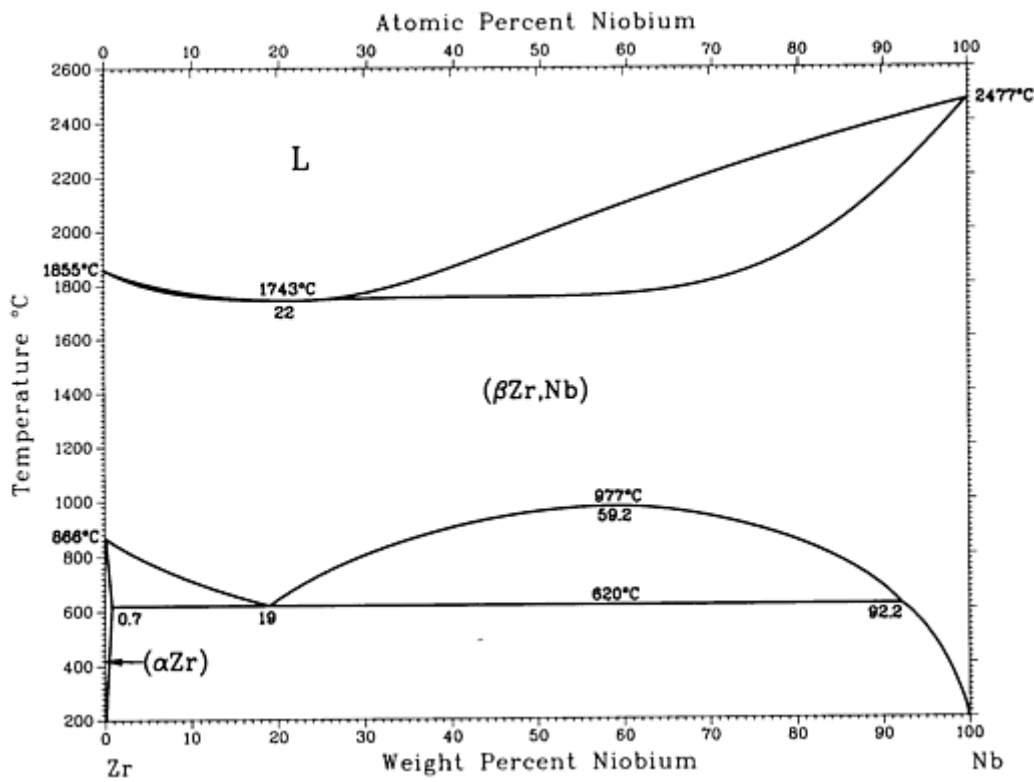

Nb-Zr phase diagram

Nb-Zr crystallographic data

Phase	Composition, wt% Nb	Pearson symbol	Space group
(β _{Zr,Nb})	0 to 100	<i>cI2</i>	<i>Im</i> $\bar{3}m$
(αZr)	0 to 0.7	<i>hP2</i>	<i>P6</i> ₃ / <i>mmc</i>
Metastable phase			
ω	...	<i>hP3</i>	(a)

(a) Changes from *P6*/*mmm* to *P* $\bar{3}$ *m1* with increasing Nb content

Nd (Neodymium) Binary Alloy Phase Diagrams

Introduction

THIS ARTICLE includes systems where Neodymium is the first-named element in the binary pair. Additional binary systems that include Neodymium are provided in the following locations in this Volume:

- “Ag-Nd (Silver)-Nd (Silver - Neodymium)” in the article “Ag (Silver) Binary Alloy Phase Diagrams.”
- “Al-Nd (Aluminum - Neodymium)” in the article “Al (Aluminum) Binary Alloy Phase Diagrams.”
- “As-Nd (Arsenic - Neodymium)” in the article “As (Arsenic) Binary Alloy Phase Diagrams.”
- “Bi-Nd (Bismuth - Neodymium)” in the article “Bi (Bismuth) Binary Alloy Phase Diagrams.”
- “Ca-Nd (Calcium - Neodymium)” in the article “Ca (Calcium) Binary Alloy Phase Diagrams.”
- “Co-Nd (Cobalt - Neodymium)” in the article “Co (Cobalt) Binary Alloy Phase Diagrams.”
- “Cu-Nd (Copper - Neodymium)” in the article “Cu (Copper) Binary Alloy Phase Diagrams.”
- “Fe-Nd (Iron - Neodymium)” in the article “Fe (Iron) Binary Alloy Phase Diagrams.”
- “Ga-Nd (Gallium - Neodymium)” in the article “Ga (Gallium) Binary Alloy Phase Diagrams.”
- “Ge-Nd (Germanium - Neodymium)” in the article “Ge (Germanium) Binary Alloy Phase Diagrams.”
- “H-Nd (Hydrogen - Neodymium)” in the article “H (Hydrogen) Binary Alloy Phase Diagrams.”
- “In-Nd (Indium - Neodymium)” in the article “In (Indium) Binary Alloy Phase Diagrams.”
- “Mn-Nd (Manganese - Neodymium)” in the article “Mn (Manganese) Binary Alloy Phase Diagrams.”

Nd-Ni (Neodymium - Nickel)

H. Okamoto, 1992

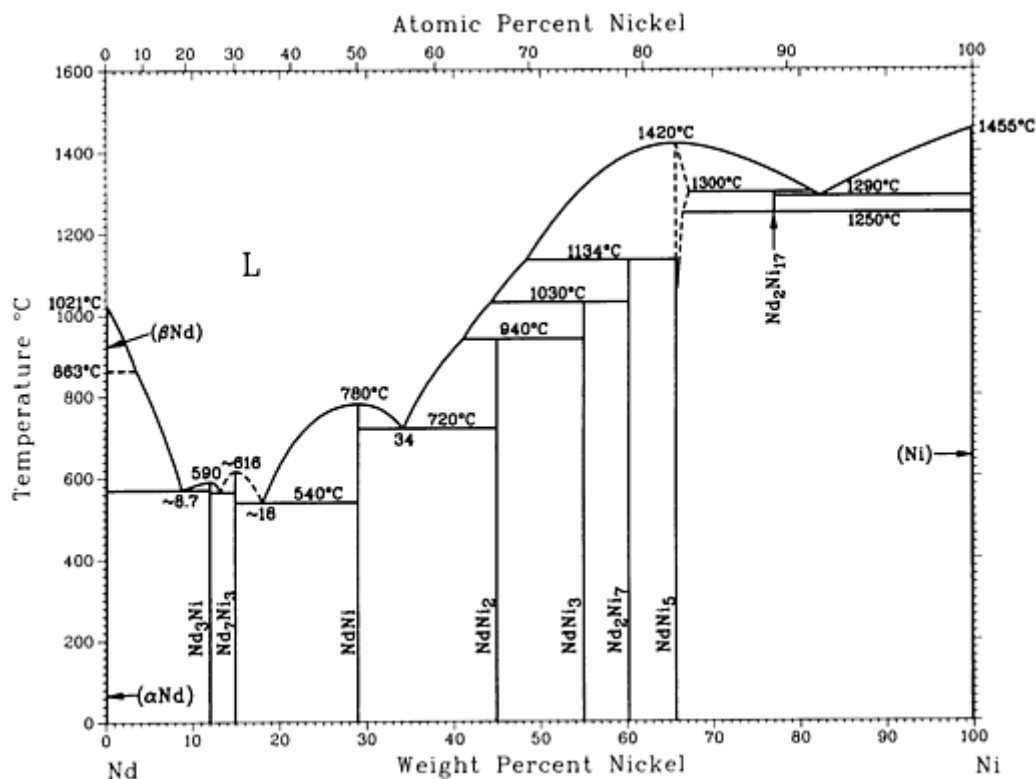

Nd-Ni phase diagram

Nd-Ni crystallographic data

Phase	Composition, wt% Ni	Pearson symbol	Space group

(β Nd)	0	<i>cI2</i>	<i>Im$\bar{3}m$</i>
(α Nd)	0	<i>hP4</i>	<i>P6$_3$/mmc</i>
Nd ₃ Ni	11.9	<i>oP16</i>	<i>Pnma</i>
Nd ₇ Ni ₃	14.8	<i>hP20</i>	<i>P6$_3$mc</i>
NdNi	28.9	<i>oC8</i>	<i>Cmcm</i>
NdNi ₂	44.9	<i>cF24</i>	<i>Fd$\bar{3}m$</i>
NdNi ₃	55.0	<i>hR12</i>	<i>R$\bar{3}m$</i>
Nd ₂ Ni ₇	58.8	<i>hP36</i> <i>hR18</i>	<i>P6$_3$/mmc</i> <i>R$\bar{3}m$</i>
NdNi ₅	67.0	<i>hP6</i>	<i>P6/mmm</i>
Nd ₂ Ni ₁₇	77.6	<i>hP38</i>	<i>P6$_3$/mmc</i>
(Ni)	100	<i>cF4</i>	<i>Fm$\bar{3}m$</i>

Nd-Pt (Neodymium - Platinum)

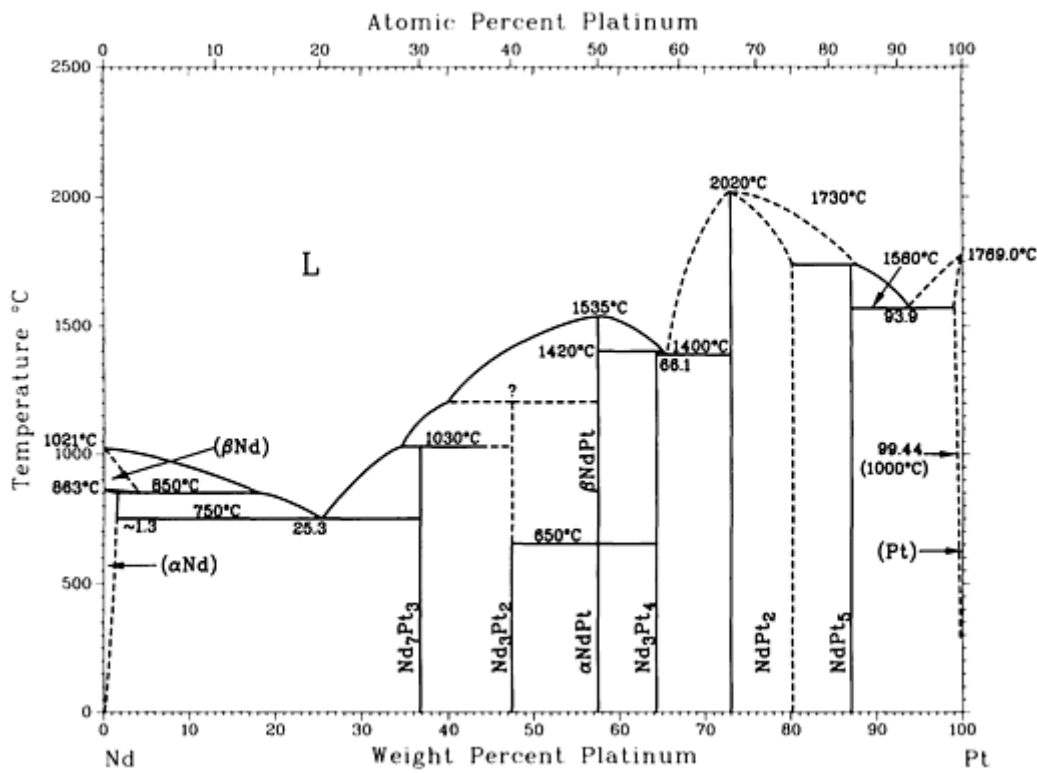

Nd-Pt phase diagram

Nd-Pt crystallographic data

Phase	Composition, wt% Pt	Pearson symbol	Space group
(βNd)	0 to ~4	<i>cI2</i>	<i>Im</i> $\bar{3}m$
(αNd)	0 to ~1.3	<i>hP4</i>	<i>P6</i> ₃ / <i>mmc</i>
Nd ₇ Pt ₃	37	<i>hP20</i>	<i>P6</i> ₃ / <i>mc</i>
Nd ₃ Pt ₂	47	<i>hR15</i>	<i>R</i> $\bar{3}$
βNdPt	57.5	<i>oC8</i>	<i>Cmcm</i>
αNdPt	57.5	<i>oP8</i>	<i>Pnma</i>
Nd ₃ Pt ₄	64.3	<i>hR14</i>	<i>R</i> $\bar{3}$
NdPt ₂	73.0 to 80	<i>cF24</i>	<i>Fd</i> $\bar{3}m$

NdPt ₅	87.1	<i>hP6</i>	<i>P6/mmm</i>
(Pt)	~100	<i>cF4</i>	<i>Fm$\bar{3}m$</i>

Nd-Rh (Neodymium - Rhodium)

H. Okamoto, 1990

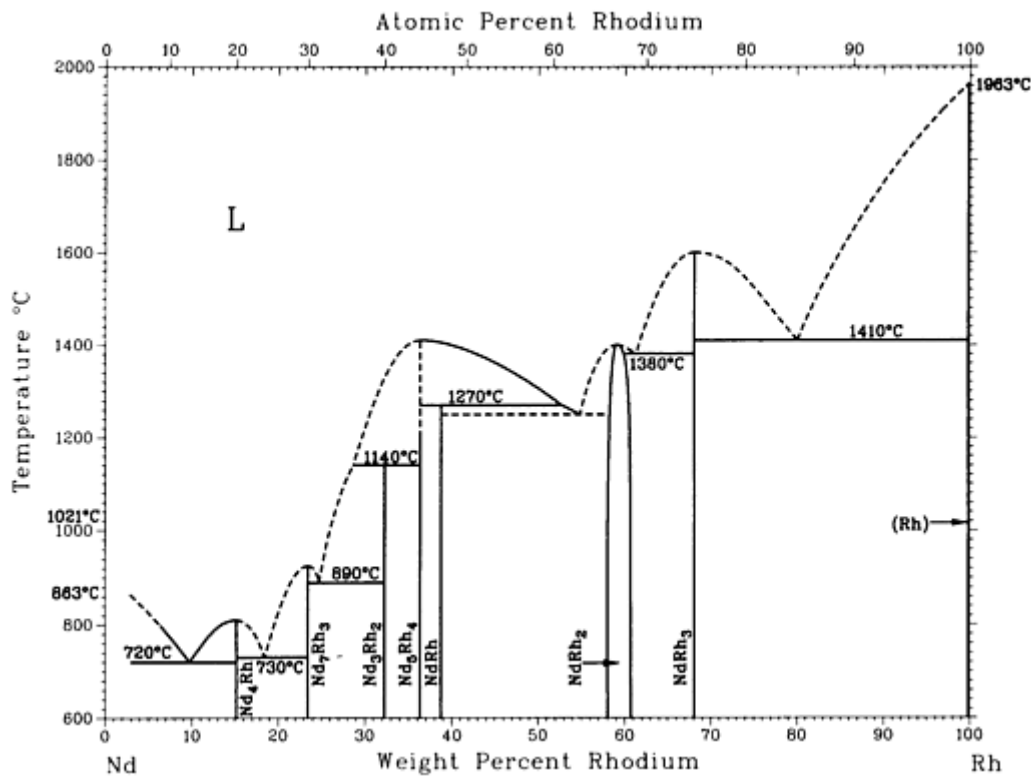

Nd-Rh phase diagram

Nd-Rh crystallographic data

Phase	Composition, wt% Rh	Pearson symbol	Space group
(β Nd)	0	<i>cI2</i>	<i>Im$\bar{3}m$</i>
(α Nd)	0	<i>hP4</i>	<i>P6₃/mmc</i>
Nd ₄ Rh	15	<i>oP16</i>	<i>Pnma</i>
Nd ₇ Rh ₃	23	<i>hP20</i>	<i>P6₃mc</i>

β Nd ₃ Rh ₂	32
α Nd ₃ Rh ₂	32	<i>hR15</i>	$R\bar{3}$
Nd ₅ Rh ₄	36.3	<i>oP36</i>	<i>Pnma</i>
NdRh	39	<i>oC8</i>	<i>Cmcm</i>
NdRh ₂	58 to 60.8	<i>cF24</i>	<i>Fd\bar{3}m</i>
NdRh ₃	68	<i>hP24</i>	<i>P6₃/mmc</i>
(Rh)	100	<i>cF4</i>	<i>Fm\bar{3}m</i>

Nd-Sb (Neodymium - Antimony)

H. Okamoto, 1990

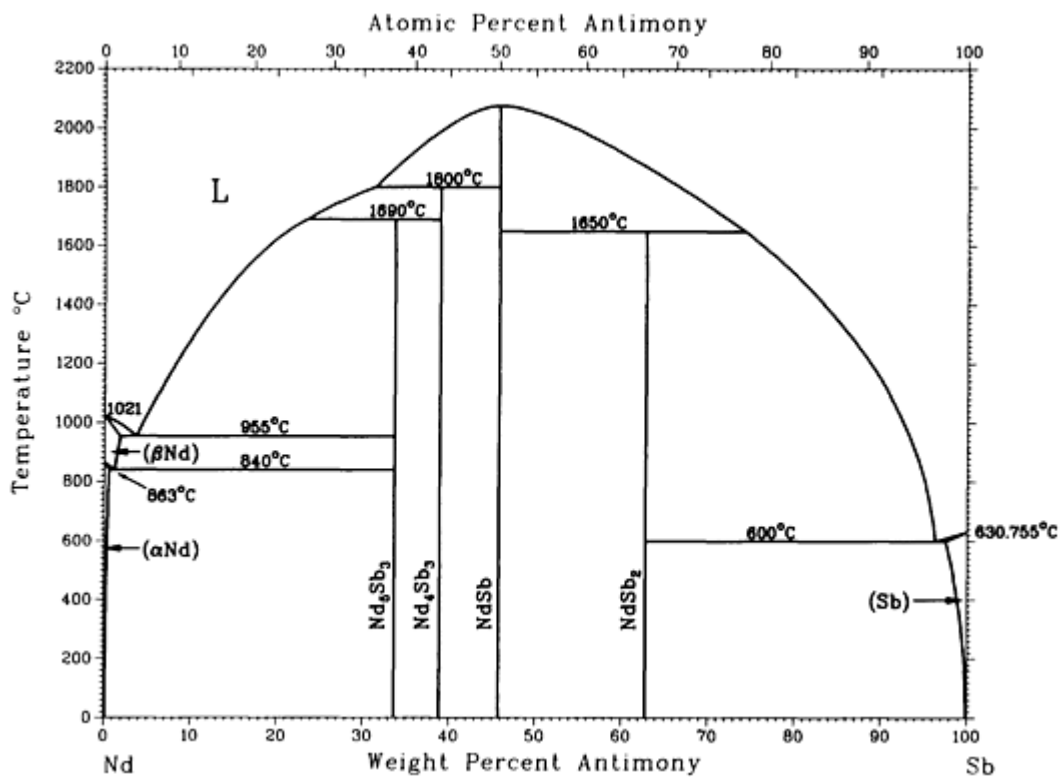

Nd-Sb phase diagram

Nd-Sb crystallographic data

Phase	Composition, wt% Sb	Pearson symbol	Space group
(β Nd)	0 to 1.7	<i>cI2</i>	<i>Im</i> $\bar{3}m$
(α Nd)	0 to 0.8	<i>hP4</i>	<i>P6</i> $\bar{3}/mnc$
Nd ₃ Sb ₃	33.6	<i>hP16</i>	<i>P6</i> $\bar{3}/mcm$
Nd ₄ Sb ₃	38.8	<i>cI28</i>	<i>I</i> $\bar{4}3d$
NdSb	45.8	<i>cF8</i>	<i>Fm</i> $\bar{3}m$
NdSb ₂	62.8	<i>oC24</i>	<i>Cmca</i>
(Sb)	97.6 to 100	<i>hR2</i>	<i>R</i> $\bar{3}m$

Nd-Si (Neodymium - Silicon)

A.B. Gokhale, A. Munitz, and G.J. Abbaschian, 1989

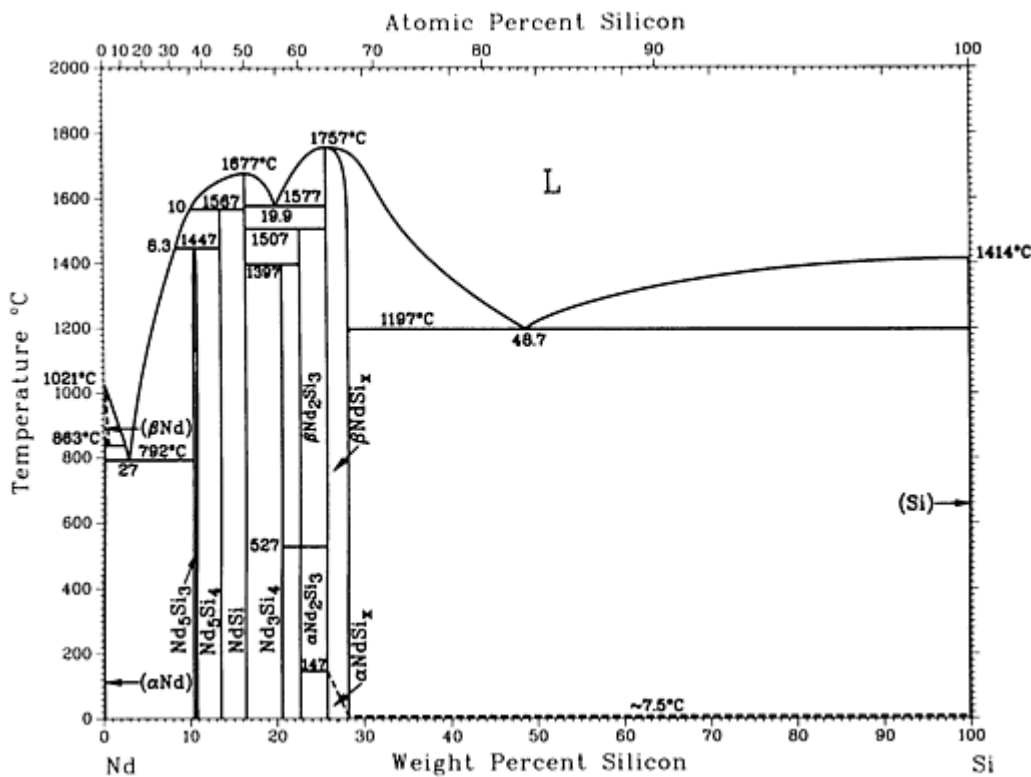

Nd-Si phase diagram

Nd-Si crystallographic data

Phase	Composition, wt% Si	Pearson symbol	Space group
(β_{Nd})	0	<i>cI2</i>	<i>Im$\bar{3}m$</i>
(α_{Nd})	0	<i>hP4</i>	<i>P6$_3$/mmc</i>
Nd ₅ Si ₃	~10.3 to ~10.7	<i>tI32</i>	<i>I4/mcm</i>
Nd ₅ Si ₄	13.48	...	<i>P4$_1$2$_1$2</i>
NdSi	16.3	<i>oP8</i>	<i>Pnma</i>
Nd ₃ Si ₄	21
$\beta_{\text{Nd}_2\text{Si}_3}$	23
$\alpha_{\text{Nd}_2\text{Si}_3}$	22.6	<i>hP3</i>	<i>P6/mmm</i>
β_{NdSi_x}	28.14	<i>tI12</i>	<i>I4$_1$/amd</i>
α_{NdSi_x}	25.7 to 28.14	...	<i>Imma</i>
(Si)	100	<i>cF8</i>	<i>Fd$\bar{3}m$</i>

Nd-Sn (Neodymium - Tin)

H. Okamoto, 1990

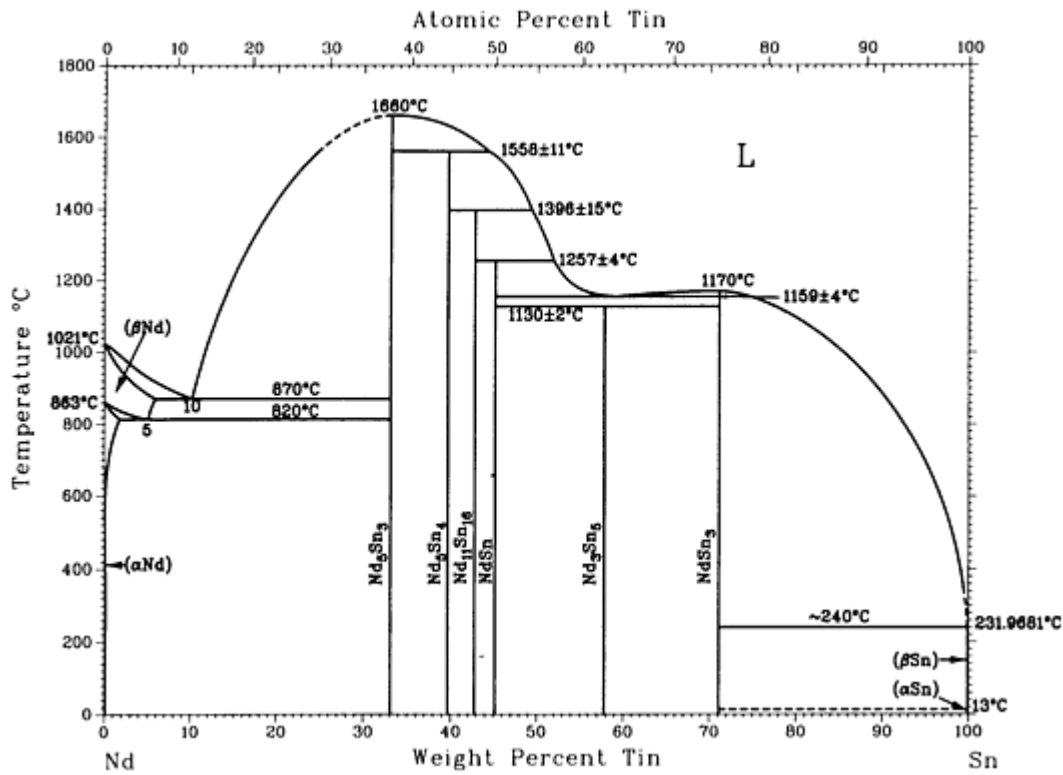

Nd-Sn phase diagram

Nd-Sn crystallographic data

Phase	Composition, wt% Sn	Pearson symbol	Space group
(βNd)	0 to 6	<i>cI2</i>	<i>Im</i> $\bar{3}m$
(αNd)	0 to 2	<i>hP4</i>	<i>P6</i> ₃ / <i>mmc</i>
Nd ₅ Sn ₃	33.1	<i>hP16</i>	<i>P6</i> ₃ / <i>mcm</i>
Nd ₅ Sn ₄	39.7	<i>oP36</i>	<i>Pnma</i>
Nd ₁₁ Sn ₁₀	42.8	<i>tI84</i>	<i>I4/mmm</i>
NdSn	45.1
Nd ₃ Sn ₅	57.8

NdSn ₃	71	<i>cP4</i>	<i>Pm</i> $\bar{3}m$
(β Sn)	100	<i>tI4</i>	<i>I4</i> ₁ <i>amd</i>
(α Sn)	100	<i>cF8</i>	<i>Fd</i> $\bar{3}m$

Nd-Te (Neodymium - Tellurium)

H. Okamoto, 1990

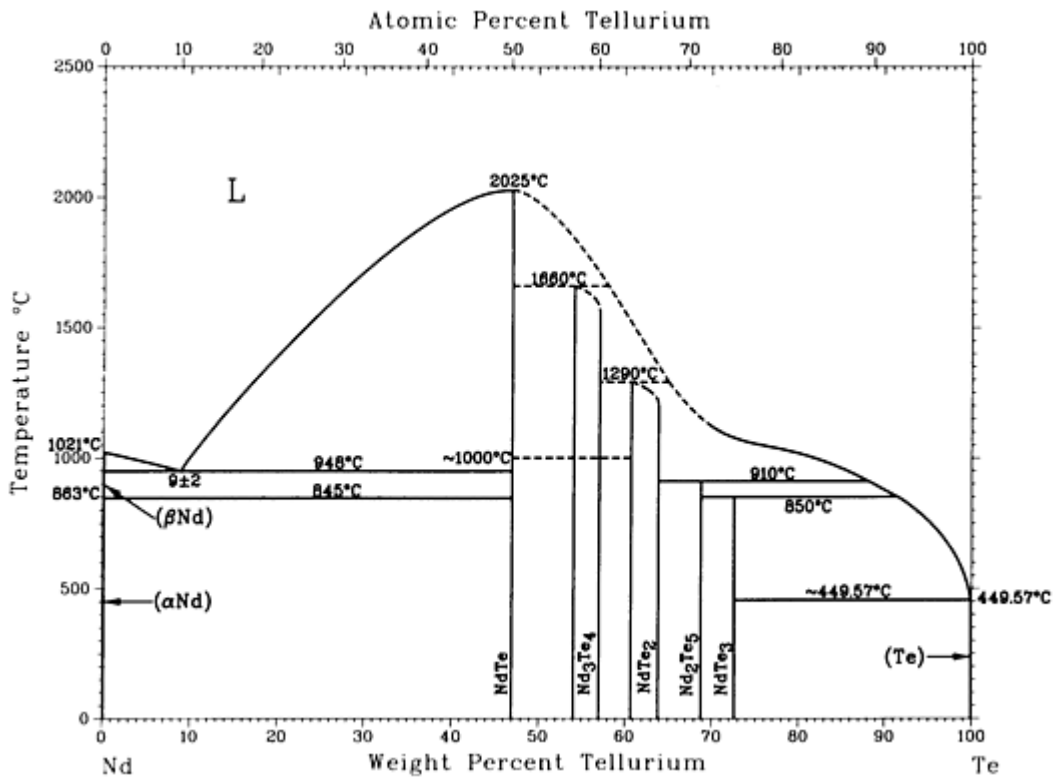

Nd-Te phase diagram

Nd-Te crystallographic data

Phase	Composition, wt% Te	Pearson symbol	Space group
(β Nd)	0	<i>cI2</i>	<i>Im</i> $\bar{3}m$
(α Nd)	0	<i>hP4</i>	<i>P6</i> ₃ <i>mmc</i>
NdTe	46.9	<i>cF8</i>	<i>Fm</i> $\bar{3}m$

Nd ₃ Te ₄ ^(a)	54 to 57?	<i>cI28</i>	<i>I4̄3d</i>
Nd ₂ Te ₃ ^(a)	57	<i>oP20</i>	<i>Pnma</i>
NdTe ₂	60.7 to 63.9	<i>tP6</i>	<i>P4/nmm</i>
Nd ₂ Te ₅	68.8	<i>oC28</i>	<i>Cmcm</i>
NdTe ₃	73	<i>oP16</i>	<i>Cmcm</i>
(Te)	100	<i>hP3</i>	<i>P3₁21</i>

(a) The phase relationships between Nd₃Te₄ and Nd₂Te₃, and the homogeneity range of each, are unknown.

Nd-Ti (Neodymium - Titanium)

J.L. Murray, 1987

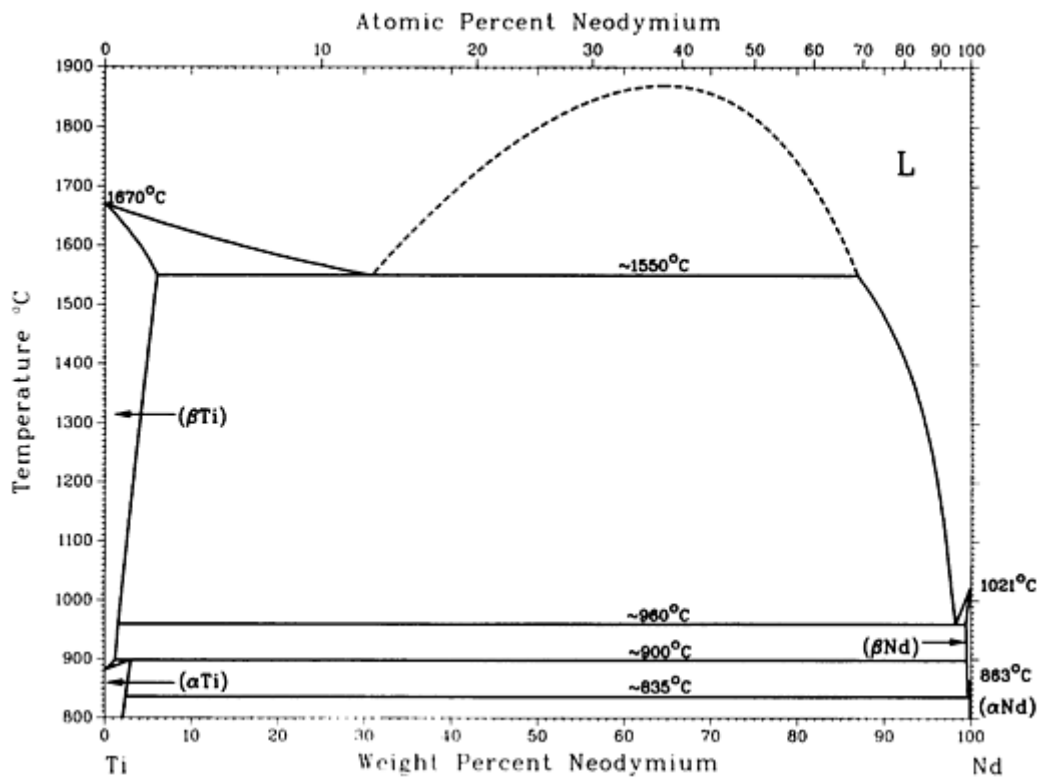

Nd-Ti phase diagram

Nd-Ti crystallographic data

Phase	Composition,	Pearson	Space
-------	--------------	---------	-------

	wt% Nd	symbol	group
(β Ti)	0 to \sim 9	<i>cI2</i>	$Im\bar{3}m$
(α Ti)	0 to \sim 3	<i>hP2</i>	$P6_3/mmc$
(β Nd)	? to 100	<i>cI2</i>	$Im\bar{3}m$
(α Nd)	\sim 100	<i>hP2</i>	$P6_3/mmc$

Nd-Tl (Neodymium - Thallium)

S. Delfino, A. Saccone, A. Palenzona, and R. Ferro, unpublished

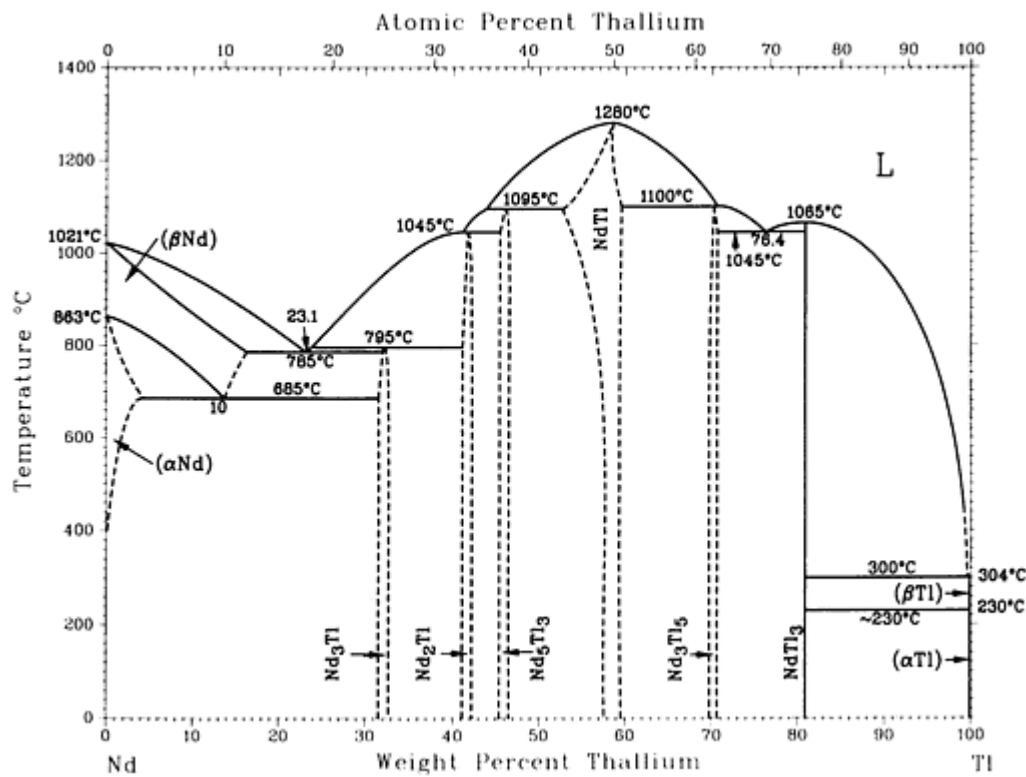

Nd-Tl phase diagram

Nd-Tl crystallographic data

Phase	Composition, wt% Tl	Pearson symbol	Space group
(β Nd)	0 to \sim 16	<i>cI2</i>	$Im\bar{3}m$

(α Nd)	0 to \sim 4	<i>hP4</i>	<i>P6₃/mmc</i>
Nd ₃ Tl ^(a)	\sim 31.5 to 32.7 \sim 32.1	<i>cP4</i> <i>cF4</i>	<i>Pm</i> $\bar{3}m$ <i>Fm</i> $\bar{3}m$
Nd ₂ Tl	\sim 41 to \sim 42	<i>hP6</i>	<i>P6₃/mmc</i>
Nd ₅ Tl ₃	\sim 45 to \sim 47	<i>tI32</i>	<i>I4/mcm</i>
NdTI ^(b)	\sim 53 to \sim 60	<i>cP2</i> (or <i>cI2</i>)	<i>Pm</i> $\bar{3}m$ <i>Im</i> $\bar{3}m$
NdTI ^(c)	\sim 53 to \sim 60	<i>tP2</i>	<i>P4/mmm</i>
Nd ₃ Tl ₅	\sim 70 to \sim 71	<i>oC32</i>	<i>Cmcm</i>
NdTI ₃	81	<i>cP4</i>	<i>Pm</i> $\bar{3}m$
(β Tl)	100	<i>cI2</i>	<i>Im</i> $\bar{3}m$
(α Tl)	100	<i>hP2</i>	<i>P6₃/mmc</i>

(a) A *cP4-cF4* order-disorder transformation in this phase has been suggested.

(b) Cubic structure presumed to be room- and higher-temperature phases.

(c) Tetragonal structure presumed to be lower-temperature phase

Nd-Zn (Neodymium - Zinc)

J.T. Mason and P. Chiotti, 1972

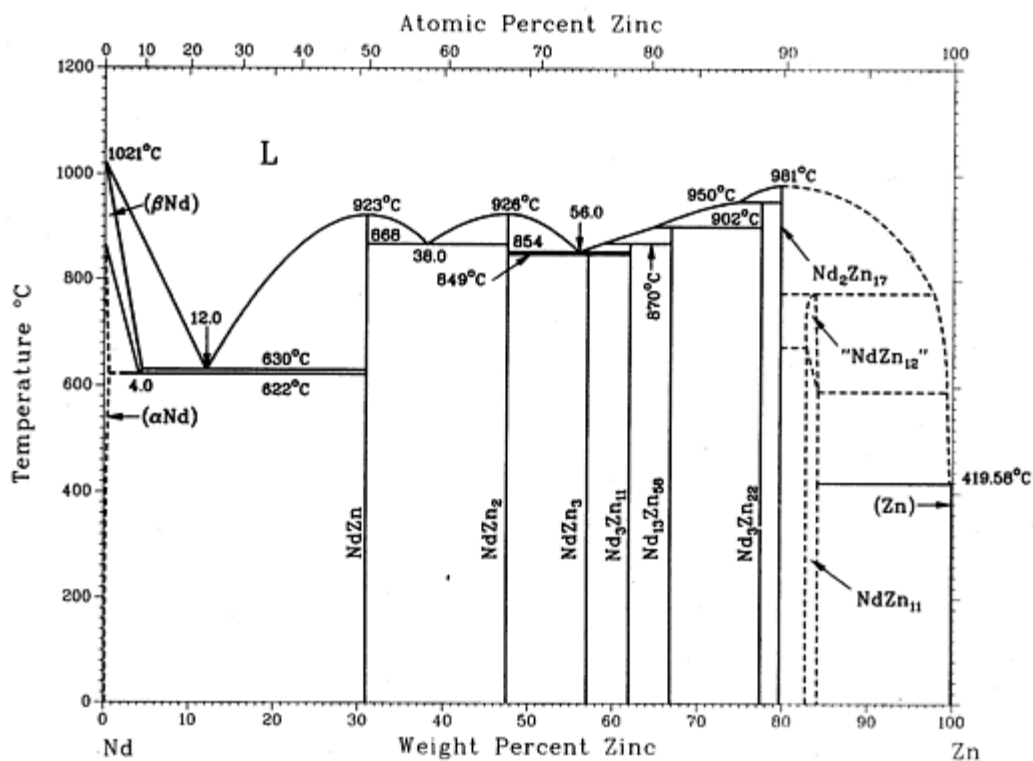

Nd-Zn phase diagram

Nd-Zn crystallographic data

Phase	Composition, wt% Zn	Pearson symbol	Space group
(βNd)	0 to 4.0	<i>cI2</i>	<i>Im</i> $\bar{3}m$
(αNd)	0 to >0.5	<i>hP4</i>	<i>P6₃/mmc</i>
NdZn	31.2	<i>cP2</i>	<i>Pm</i> $\bar{3}m$
NdZn ₂	47.6	<i>oI12</i>	<i>Imma</i>
NdZn ₃	~57.0	<i>oP16</i>	<i>Pnma</i>

Nd ₃ Zn ₁₁	~62.5	<i>oI28</i>	<i>Immm</i>
Nd ₁₃ Zn ₅₈	~66.9	<i>hP142</i>	<i>P6₃mc</i>
Nd ₃ Zn ₂₂	>77	<i>tI100</i>	<i>I4₁/amd</i>
Nd ₂ Zn ₁₇	~79.4	<i>hP38</i> <i>hR19</i>	<i>P6₃/mmc</i> <i>R$\bar{3}$m</i>
NdZn ₁₁	~83.4	<i>tI48</i>	<i>I4₁/amd</i>
"NdZn ₁₂ "	~84.5
(Zn)	~100	<i>hP2</i>	<i>P6₃/mmc</i>
Other reported phase			
NdZn ₅	~69.3	<i>hP6</i>	<i>P6/mmm</i>

Ni (Nickel) Binary Alloy Phase Diagrams

Introduction

THIS ARTICLE includes systems where nickel is the first-named element in the binary pair. Additional binary systems that include nickel are provided in the following locations in this Volume:

- "Ag-Ni (Silver - Nickel)" in the article "Ag (Silver) Binary Alloy Phase Diagrams."
- "Al-Ni (Aluminum - Nickel)" in the article "Al (Aluminum) Binary Alloy Phase Diagrams."
- "As-Ni (Arsenic - Nickel)" in the article "As (Arsenic) Binary Alloy Phase Diagrams."
- "Au-Ni (Gold - Nickel)" in the article "Au (Gold) Binary Alloy Phase Diagrams."
- "B-Ni (Boron - Nickel)" in the article "B (Boron) Binary Alloy Phase Diagrams."
- "Be-Ni (Beryllium - Nickel)" in the article "Be (Beryllium) Binary Alloy Phase Diagrams."
- "Bi-Ni (Bismuth - Nickel)" in the article "Bi (Bismuth) Binary Alloy Phase Diagrams."
- "C-Ni (Carbon - Nickel)" in the article "C (Carbon) Binary Alloy Phase Diagrams."
- "Ca-Ni (Calcium - Nickel)" in the article "Ca (Calcium) Binary Alloy Phase Diagrams."
- "Cd-Ni (Cadmium - Nickel)" in the article "Cd (Cadmium) Binary Alloy Phase Diagrams."
- "Ce-Ni (Cerium - Nickel)" in the article "Ce (Cerium) Binary Alloy Phase Diagrams."
- "Co-Ni (Cobalt - Nickel)" in the article "Co (Cobalt) Binary Alloy Phase Diagrams."
- "Cr-Ni (Chromium - Nickel)" in the article "Cr (Chromium) Binary Alloy Phase Diagrams."
- "Cu-Ni (Copper - Nickel)" in the article "Cu (Copper) Binary Alloy Phase Diagrams."
- "Dy-Ni (Dysprosium - Nickel)" in the article "Dy (Dysprosium) Binary Alloy Phase Diagrams."
- "Er-Ni (Erbium - Nickel)" in the article "Er (Erbium) Binary Alloy Phase Diagrams."
- "Fe-Ni (Iron - Nickel)" in the article "Fe (Iron) Binary Alloy Phase Diagrams."
- "Ga-Ni (Gallium - Nickel)" in the article "Ga (Gallium) Binary Alloy Phase Diagrams."
- "Gd-Ni (Gadolinium - Nickel)" in the article "Gd (Gadolinium) Binary Alloy Phase Diagrams."
- "Ge-Ni (Germanium - Nickel)" in the article "Ge (Germanium) Binary Alloy Phase Diagrams."

- “H-Ni (Hydrogen - Nickel)” in the article “H (Hydrogen) Binary Alloy Phase Diagrams.”
- “Hf-Ni (Hafnium - Nickel)” in the article “Hf (Hafnium) Binary Alloy Phase Diagrams.”
- “In-Ni (Indium - Nickel)” in the article “In (Indium) Binary Alloy Phase Diagrams.”
- “Ir-Ni (Iridium - Nickel)” in the article “Ir (Iridium) Binary Alloy Phase Diagrams.”
- “La-Ni (Lanthanum - Nickel)” in the article “La (Lanthanum) Binary Alloy Phase Diagrams.”
- “Mg-Ni (Magnesium - Nickel)” in the article “Mg (Magnesium) Binary Alloy Phase Diagrams.”
- “Mn-Ni (Manganese - Nickel)” in the article “Mn (Manganese) Binary Alloy Phase Diagrams.”
- “Mo-Ni (Molybdenum - Nickel)” in the article “Mo (Molybdenum) Binary Alloy Phase Diagrams.”
- “N-Ni (Nitrogen - Nickel)” in the article “N (Nitrogen) Binary Alloy Phase Diagrams.”
- “Nb-Ni (Niobium - Nickel)” in the article “Nb (Niobium) Binary Alloy Phase Diagrams.”
- “Nd-Ni (Neodymium - Nickel)” in the article “Nd (Neodymium) Binary Alloy Phase Diagrams.”

Ni-O (Nickel - Oxygen)

J.P. Neumann, T. Zhong, and Y.A. Chang, 1991

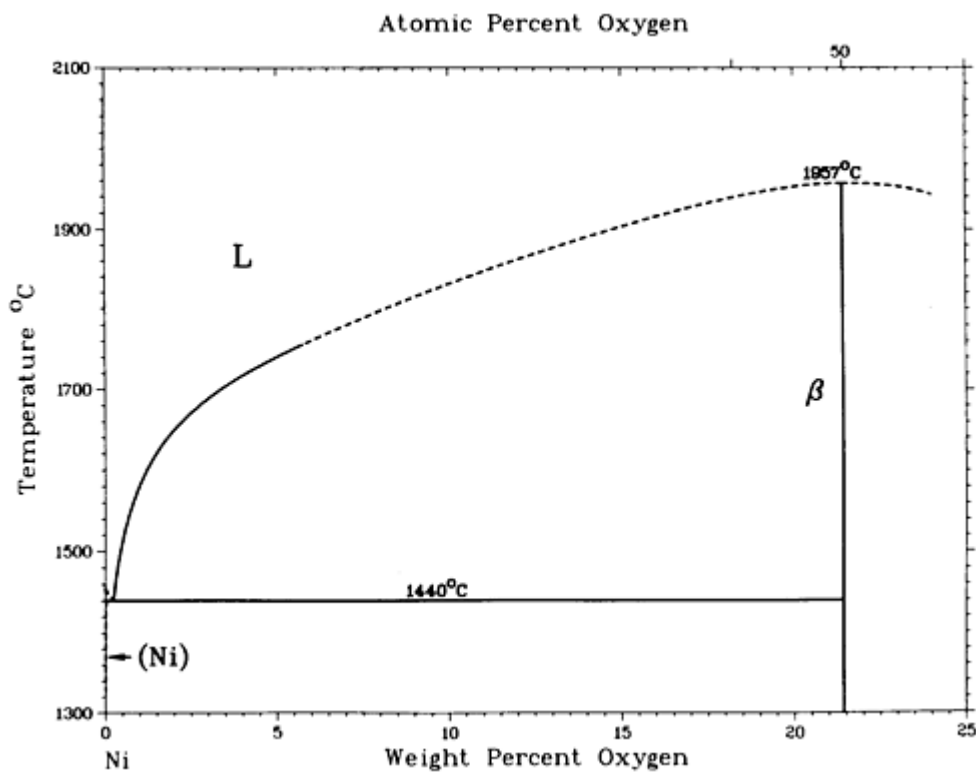

Ni-O phase diagram

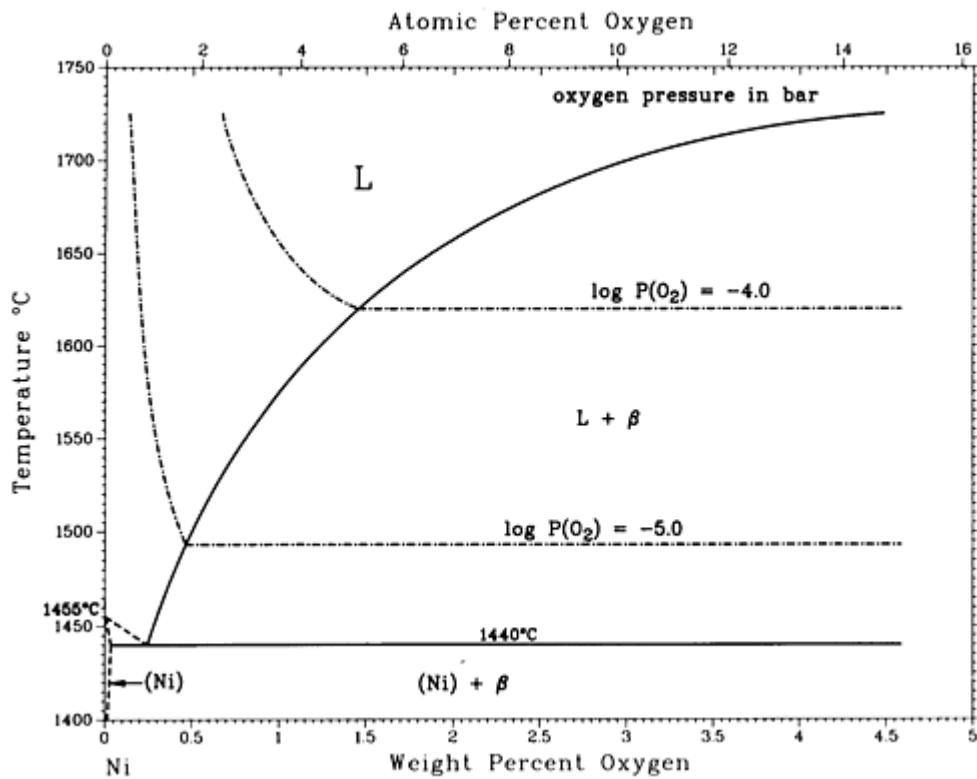

Ni-rich region of the Ni-O phase diagram

Ni-O crystallographic data

Phase	Composition, wt% O	Pearson symbol	Space group
(Ni)	0 to 0.01	<i>cF4</i>	<i>Fm</i> $\bar{3}m$
NiO(HT) or β	21.4	<i>cF8</i>	<i>Fm</i> $\bar{3}m$
NiO(LT)	21.4	<i>rP2</i> ^(a)	...
Ni ₃ O ₄	27
Ni ₂ O ₃	29
NiO ₂	35.3

(a) The *rP2* designation for NiO(LT) is an alternative to *hR2*.

Ni-Os (Nickel - Osmium)

P. Nash, 1991

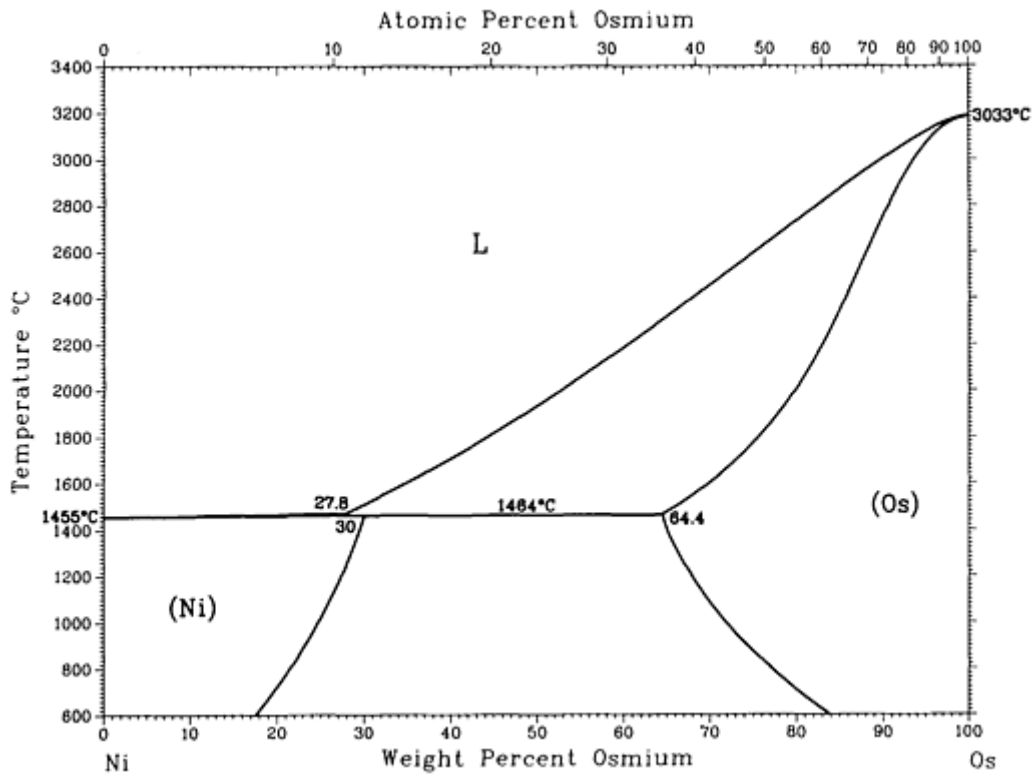

Ni-Os phase diagram

Ni-Os crystallographic data

Phase	Composition, wt% Os	Pearson symbol	Space group
(Ni)	0 to 30	<i>cF4</i>	<i>Fm</i> $\bar{3}m$
(Os)	64.4 to 100	<i>hP2</i>	<i>P6₃/mmc</i>

Ni-P (Nickel - Phosphorus)

K.J. Lee and P. Nash, 1991

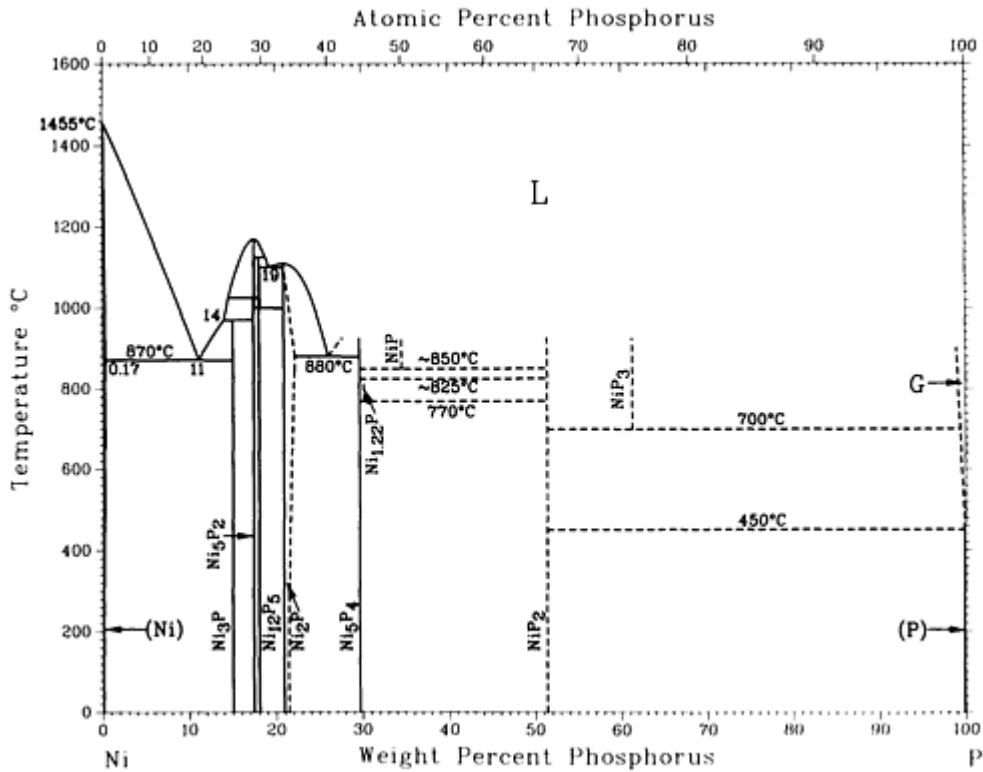

Ni-P phase diagram

Ni-P crystallographic data

Phase	Composition, wt% P	Pearson symbol	Space group
(Ni)	0 to 0.17	<i>cF4</i>	<i>Fm</i> $\bar{3}m$
Ni ₃ P	15	<i>tI32</i>	<i>I</i> $\bar{4}$
β -Ni ₃ P ₂	17.5
α -Ni ₃ P ₂	17.5	<i>hP168</i> ^(a)	<i>P</i> $\bar{3}$
δ -Ni ₁₂ P ₅	18.0
γ -Ni ₁₂ P ₅	18.0	<i>tI34</i>	<i>I4/m</i>

Ni ₂ P	20.9 to ?	<i>hP9</i>	$P\bar{6}2m$ <i>P3₂1</i>
Ni ₅ P ₄	29.6	<i>hP36</i>	<i>P6₃mc</i>
Ni _{1.22} P	30.2
NiP	34.5	<i>oP16</i>	<i>Pcba</i>
NiP ₂	51.4	<i>mC12</i>	<i>C2/c</i>
NiP ₃	61	<i>cI32</i>	<i>Im\bar{3}</i>
P (red)	100
High-pressure phase			
NiP ₂	51.4	<i>cP12</i>	<i>Pa\bar{3}</i>
Metastable phases			
"Ni ₅ P ₂ "	11 to 18	<i>h**</i>	...
α	8 to 15	<i>c**</i>	...
α_1	8 to 15	<i>h**</i>	...
α_2	8 to 15	<i>h**</i>	...
α_3	8 to 15	<i>h**</i>	...
" α Ni ₃ P"	15	<i>t**</i>	...
" β Ni ₃ P"	15	<i>h**</i>	...
" γ Ni ₃ P"	15	<i>c**</i>	...
α (amorphous)	~15	(b)	...

β (amorphous)	~15	(c)	...
---------------------	-----	-----	-----

(a) Might be *hP336*.

(b) Liquid-like.

(c) Molecular cluster

Ni-Pb (Nickel - Lead)

P. Nash, 1991

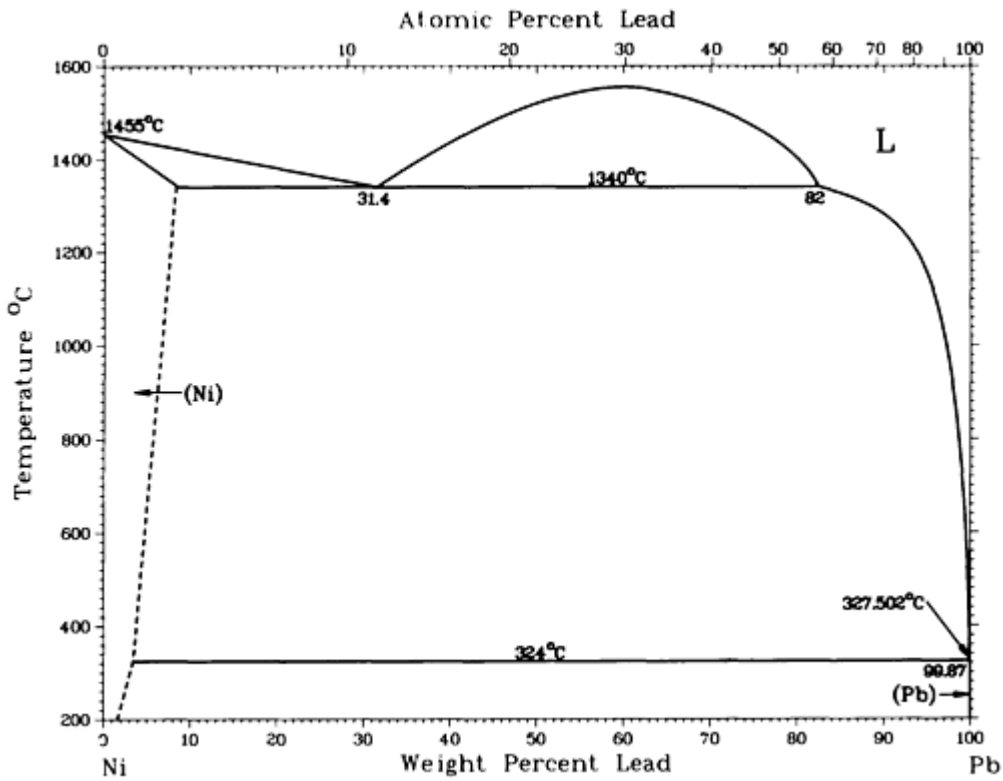

Ni-Pb phase diagram

Ni-Pb crystallographic data

Phase	Composition, wt% Pb	Pearson symbol	Space group
(Ni)	0 to ~4.1	<i>cF4</i>	<i>Fm</i> $\bar{3}m$
(Pb)	99.9 to 100	<i>cF4</i>	<i>Fm</i> $\bar{3}m$

Metastable phase			
NiPb	77.9	<i>hP4</i>	<i>P6₃/mmc</i>

Ni-Pd (Nickel - Palladium)

A. Nash and P. Nash, 1991

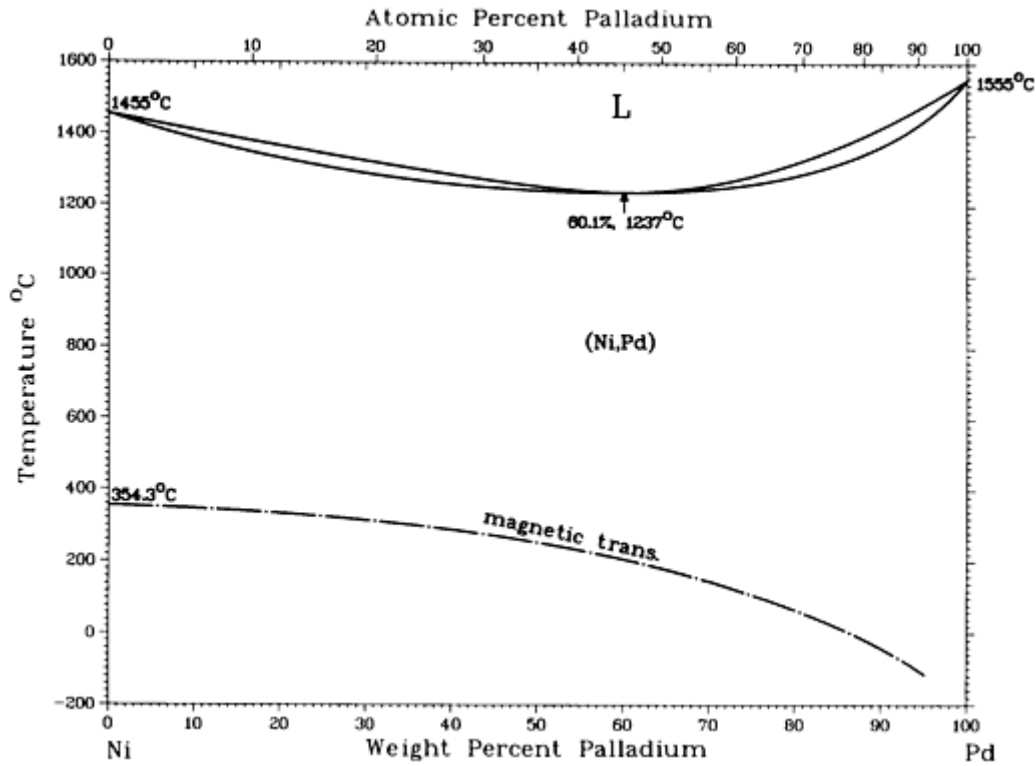

Ni-Pd phase diagram

Ni-Pd crystallographic data

Phase	Composition, wt% Pd	Pearson symbol	Space group
(Ni,Pd)	0 to 100	<i>cF4</i>	<i>Fm</i> $\bar{3}m$

Ni-Pr (Nickel - Praseodymium)

Y.Y. Pan and P. Nash, 1991

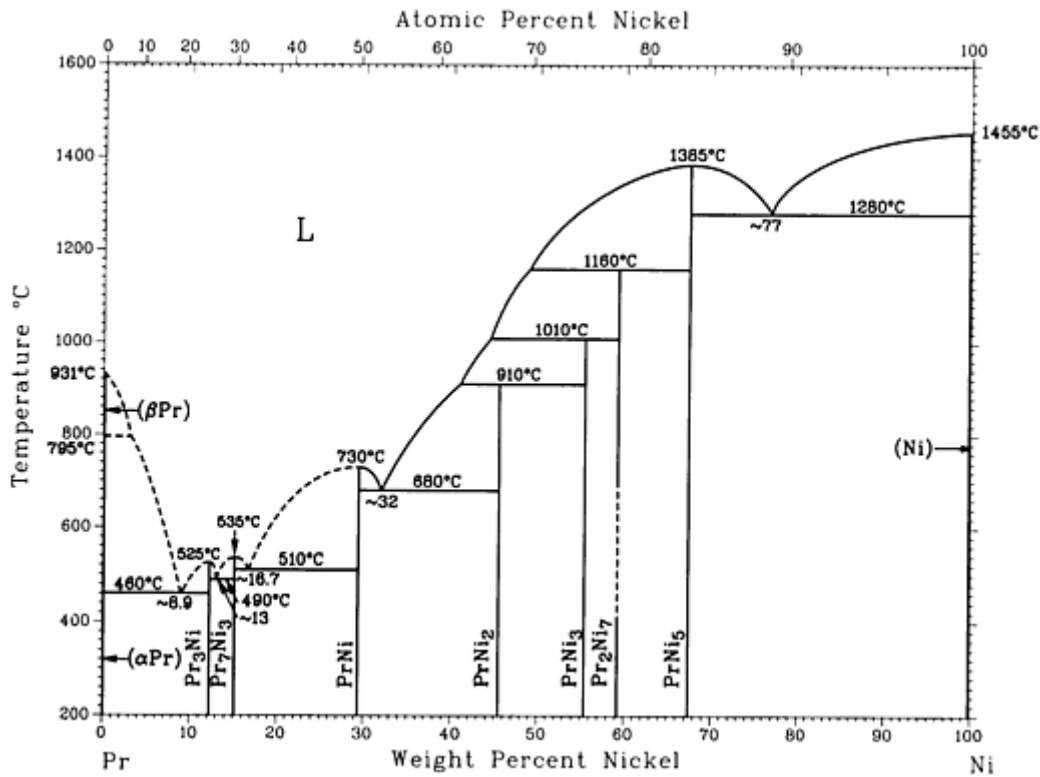

Ni-Pr phase diagram

Ni-Pr crystallographic data

Phase	Composition, wt% Ni	Pearson symbol	Space group
(βPr)	0	<i>hP4</i>	<i>P6₃/mmc</i>
(αPr)	0	<i>cI2</i>	<i>Im$\bar{3}m$</i>
Pr ₃ Ni	12.2	<i>oP16</i>	<i>Pnma</i>
Pr ₇ Ni ₃	15.1	<i>hP20</i>	<i>P6₃mc</i>
PrNi	29.4	<i>oC8</i>	<i>Cmcm</i>
PrNi ₂	45.5	<i>cF24</i>	<i>Fd$\bar{3}m$</i>

PtNi ₃	55.5	<i>hR24</i>	<i>R$\bar{3}m$</i>
Pt ₂ Ni ₇	59.3	<i>hP36</i> <i>hR54</i>	<i>P6₃/mmc</i> <i>R$\bar{3}m$</i>
PtNi ₅	67.5	<i>hP6</i>	<i>P6/mmm</i>
(Ni)	100	<i>cF4</i>	<i>Fm$\bar{3}m$</i>

Ni-Pt (Nickel - Platinum)

P. Nash and M.F. Singleton, 1991

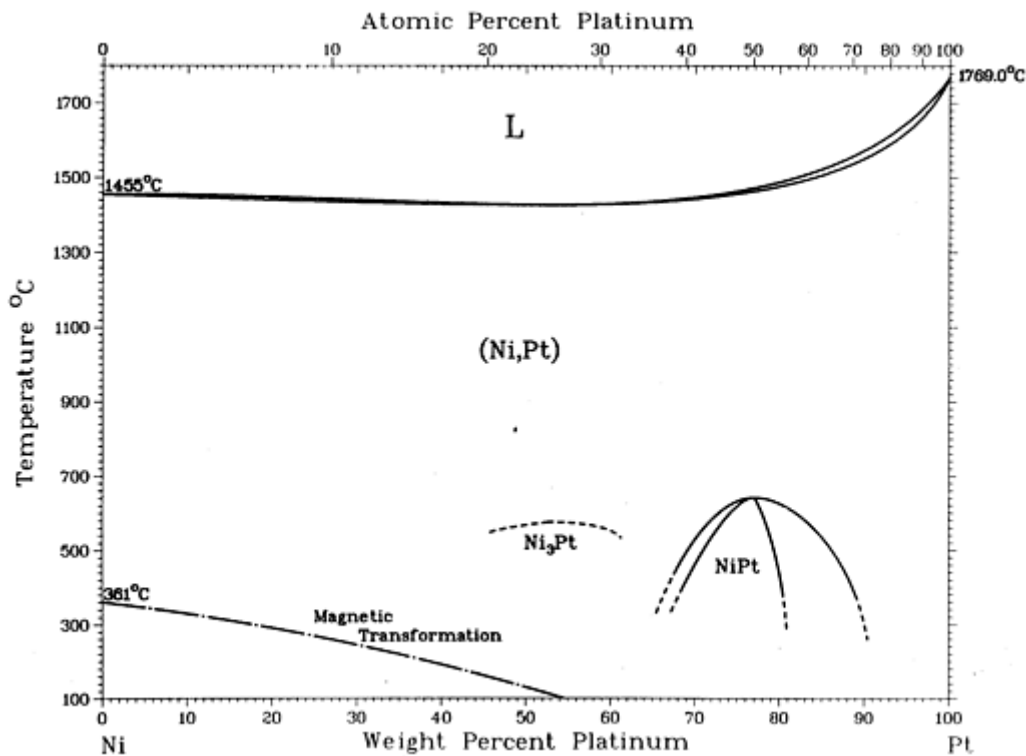

Ni-Pt phase diagram

Ni-Pt crystallographic data

Phase	Composition, wt% Pt	Pearson symbol	Space group
(Ni,Pt)	0 to 100	<i>cF4</i>	<i>Fm$\bar{3}m$</i>
Ni ₃ Pt	~53	<i>cP4</i>	<i>Pm$\bar{3}m$</i>

NiPt	~76.9	<i>tP4</i>	<i>P4/mmm</i>
------	-------	------------	---------------

Ni-Pu (Nickel - Plutonium)

D.E. Peterson, 1991

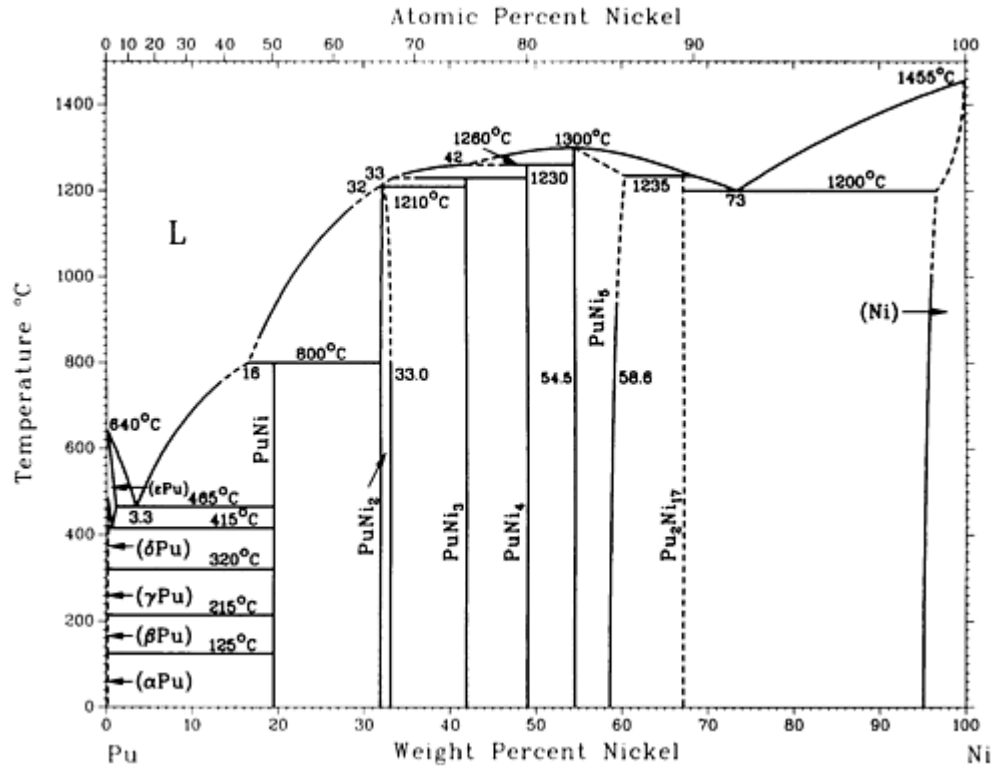

Ni-Pu phase diagram

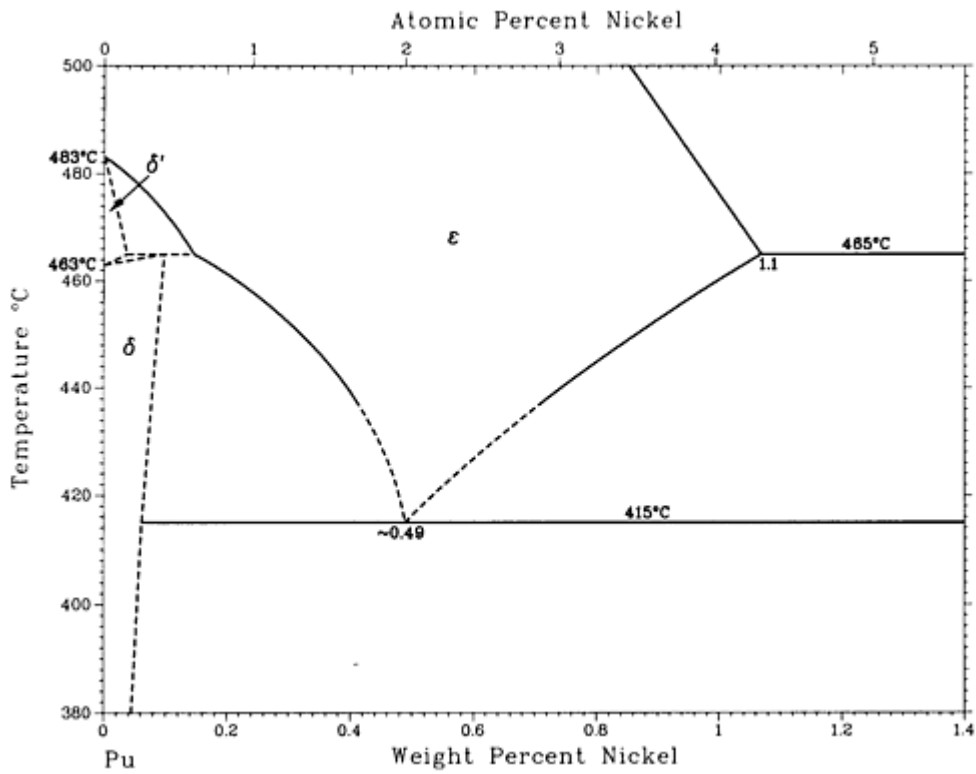

Pu-rich region of the Pu-Ni phase diagram

Ni-Pu crystallographic data

Phase	Composition, wt% Ni	Pearson symbol	Space group
(ϵ Pu)	0 to 1.1	<i>cI2</i>	<i>Im$\bar{3}m$</i>
(δ' Pu)	0 to 0.04	<i>tI2</i>	<i>I4/mmm</i>
(δ Pu)	0 to 0.1	<i>cF4</i>	<i>Fm$\bar{3}m$</i>
(γ Pu)	0	<i>oF8</i>	<i>Fddd</i>
(β Pu)	0	<i>mC34</i>	<i>C2/m</i>
(α Pu)	0	<i>mP16</i>	<i>P2₁/m</i>
PuNi	19.4	<i>oC8</i>	<i>Cmcm</i>
PuNi ₂	32.5 to 34	<i>cF24</i>	<i>Fd$\bar{3}m$</i>

PuNi ₃	42	<i>hR12</i>	<i>R$\bar{3}m$</i>
PuNi ₄	49	<i>mC30</i>	<i>C2/m</i>
PuNi ₅	54.5 to 60	<i>hP6</i>	<i>P6/mmm</i>
Pu ₂ Ni ₁₇	67.2	<i>hP38</i>	<i>P6₃/mmc</i>
(Ni)	92.9 to 100	<i>cF4</i>	<i>Fm$\bar{3}m$</i>

Ni-Re (Nickel - Rhenium)

H. Okamoto, 1992

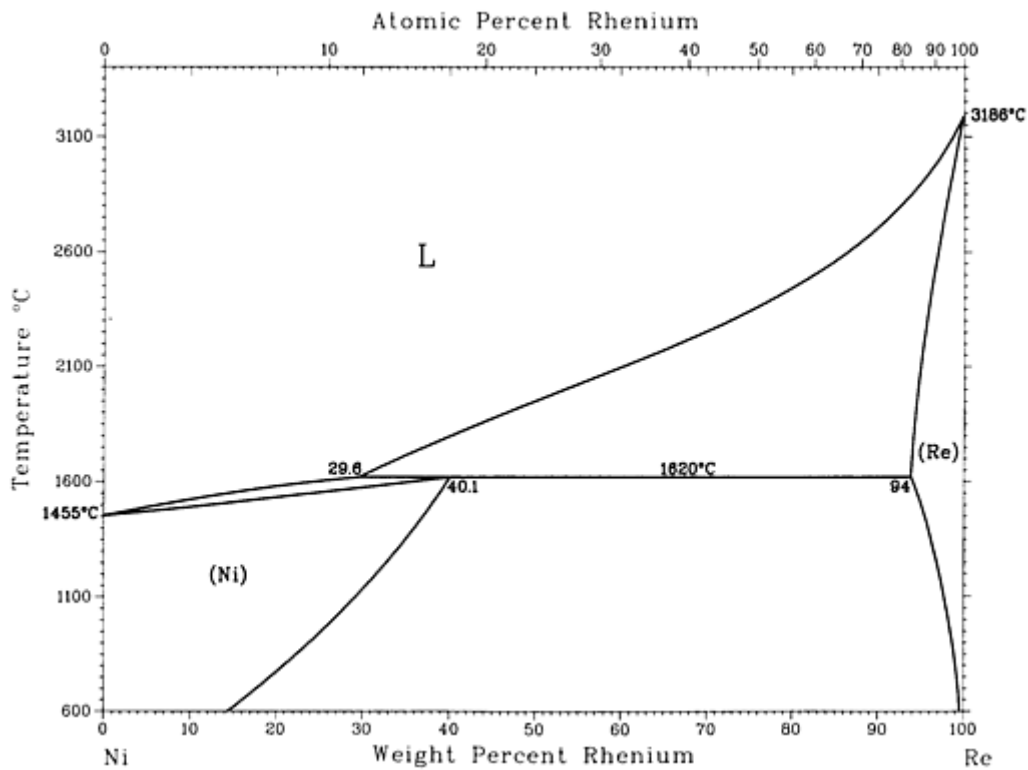

Ni-Re phase diagram

Ni-Re crystallographic data

Phase	Composition, wt% Re	Pearson symbol	Space group
(Ni)	0 to 40.1	<i>cF4</i>	<i>Fm$\bar{3}m$</i>
(Re)	94 to 100	<i>hP2</i>	<i>P6₃/mmc</i>

Ni-Rh (Nickel - Rhodium)

A. Nash and P. Nash, 1991

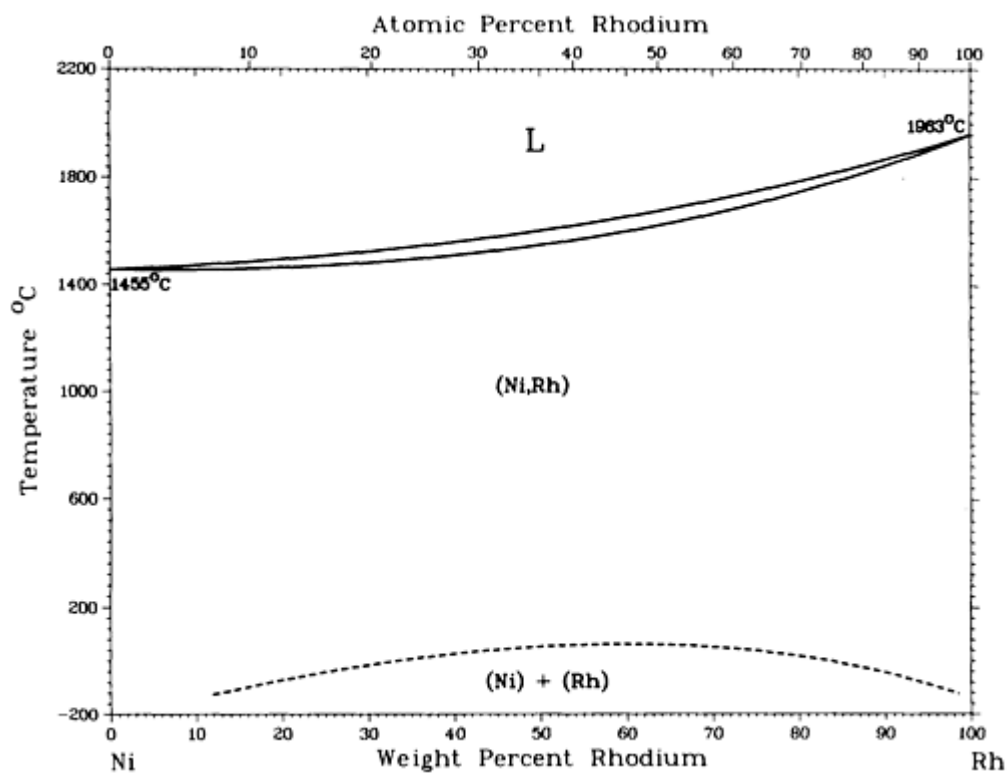

Ni-Rh phase diagram

Ni-Rh crystallographic data

Phase	Composition, wt% Rh	Pearson symbol	Space group
(Ni,Rh)	0 to 100	$cF4$	$Fm\bar{3}m$

Ni-Ru (Nickel - Ruthenium)

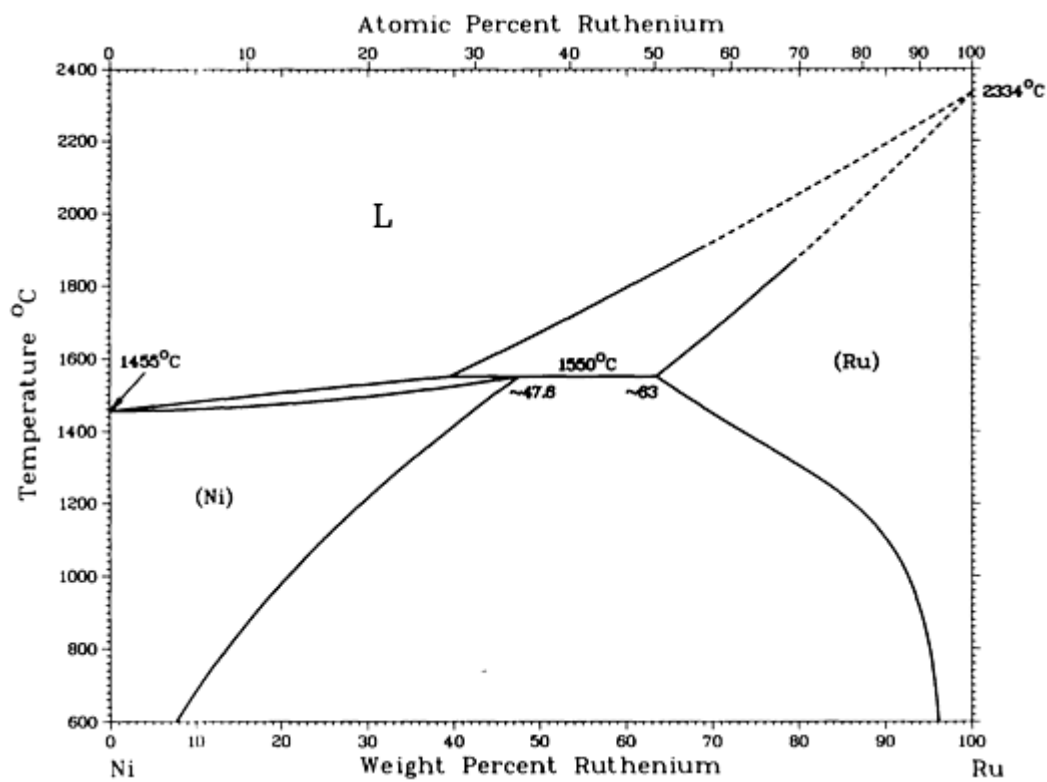

Ni-Ru phase diagram

Ni-Ru crystallographic data

Phase	Composition, wt% Ru	Pearson symbol	Space group
(Ni)	0 to ~47.6	<i>cF4</i>	<i>Fm$\bar{3}m$</i>
(Ru)	~63 to 100	<i>hP2</i>	<i>P6₃/mmc</i>
Metastable phase			
η	?	<i>t**</i>	...

Ni-S (Nickel - Sulfur)

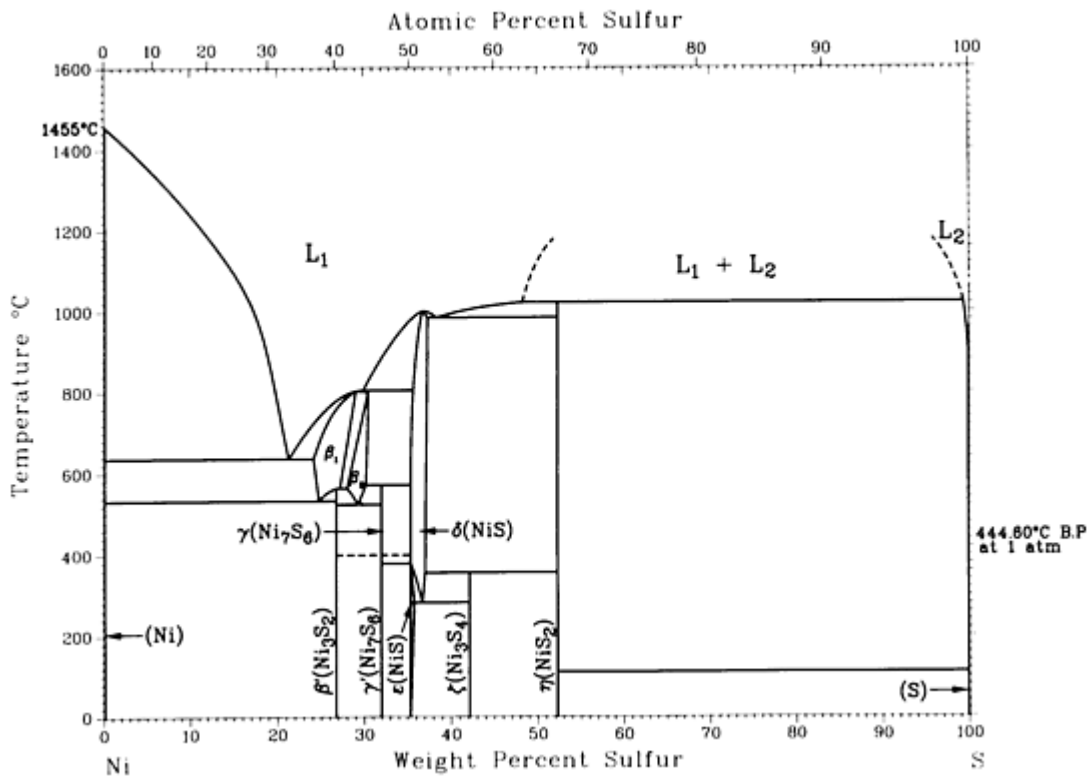

Ni-S phase diagram

Ni-S crystallographic data

Phase	Composition, wt% S	Pearson symbol	Space group
(Ni)	0	<i>cF4</i>	<i>Fm</i> $\bar{3}m$
β' (Ni ₃ S ₂)	27	<i>hR5</i>	<i>R32</i>
β_1 (Ni ₃ S ₂)	24.1 to ~28	(a)	...
β_2 (Ni ₄ S ₃)	28 to 30
γ (Ni ₇ S ₆)	31.9	(a)	...
γ' (Ni ₇ S ₆)	31.9
ϵ (NiS)	35.3 to 35.8	<i>hR6</i>	<i>R</i> $\bar{3}m$
δ (NiS)	35.1 to 37.7	<i>hP4</i>	<i>P6</i> ₃ / <i>mmc</i>

$\zeta_{(Ni_3S_4)}$	42.1	<i>cF56</i>	<i>Fd\bar{3}m</i>
$\eta_{(NiS_2)}$	52.3	<i>cP12</i>	<i>Pa3</i>
(S)	100	<i>oF128</i>	<i>Fddd</i>

(a) Hexagonal

Ni-Sb (Nickel - Antimony)

G.H. Cha, S.Y. Lee, and P. Nash, 1991

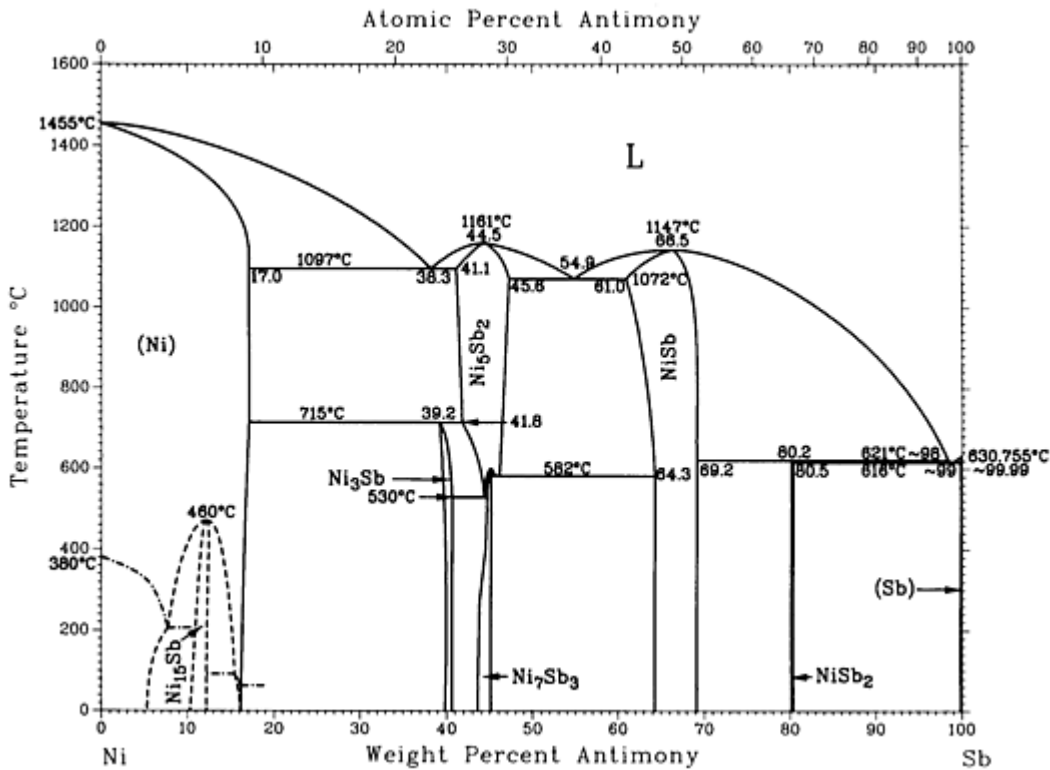

Ni-Sb phase diagram

Ni-Sb crystallographic data

Phase	Composition, wt% Sb	Pearson symbol	Space group
(Ni)	0 to 17.0	<i>cF4</i>	<i>Fm\bar{3}m</i>
Ni ₁₅ Sb	12.2

Ni ₃ Sb	39.2 to 41	<i>oP8</i>	<i>Pmmm</i>
Ni ₅ Sb ₂	41.1 to 45.6	<i>mC28</i>	...
Ni ₇ Sb ₃	45	<i>t**</i>	...
NiSb	61.0 to 69.2	<i>hP4</i>	<i>P6₃/mmc</i>
NiSb ₂	80.2 to 80.5	<i>oP6</i>	<i>Pnmm</i>
(Sb)	~100	<i>hR2</i>	<i>R$\bar{3}m$</i>

Ni-Sc (Nickel - Scandium)

P. Nash and Y.Y. Pan, 1991

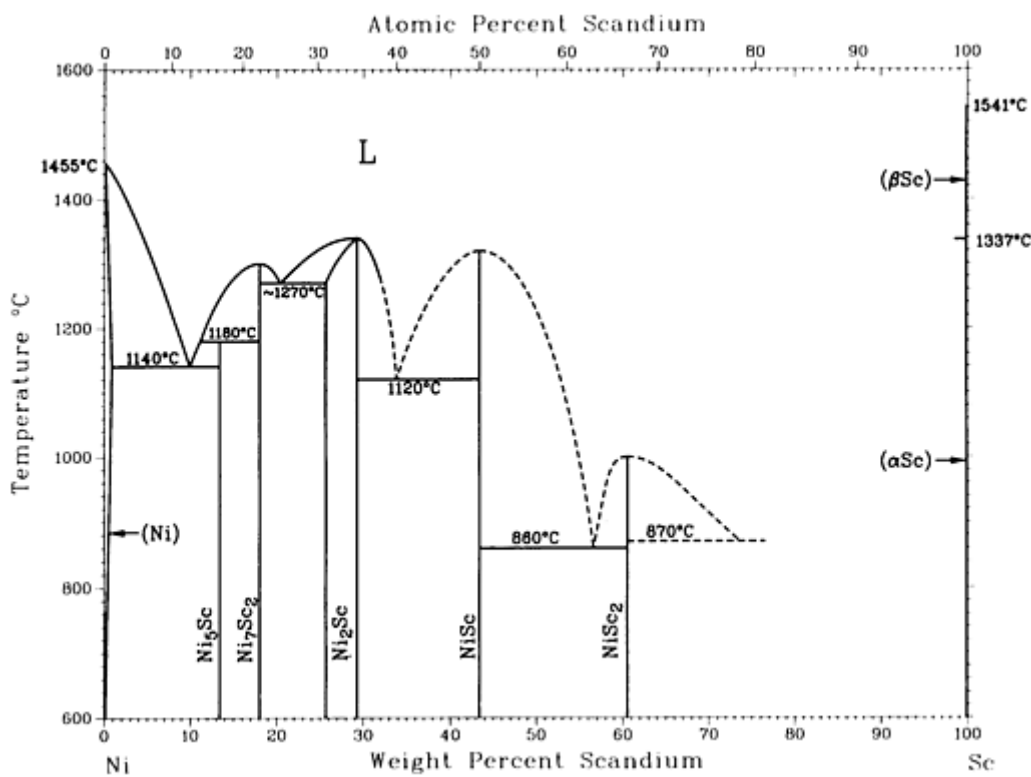

Ni-Sc phase diagram

Ni-Sc crystallographic data

Phase	Composition, wt% Sc	Pearson symbol	Space group
-------	---------------------	----------------	-------------

(Ni)	~0	<i>cF4</i>	<i>Fm$\bar{3}m$</i>
Ni ₅ Sc(HT)	13.3	<i>hP6</i>	<i>P6/mmm</i>
Ni ₅ Sc(LT)	13.3
Ni ₇ Sc ₂	17.9	<i>hP36</i>	<i>P6₃/mmc</i>
Ni ₂ Sc	26 to 29	<i>cF24</i>	<i>Fd$\bar{3}m$</i>
NiSc	43.4	<i>cP2</i>	<i>Pm$\bar{3}m$</i>
NiSc ₂	60.5	<i>cF96</i>	<i>Fd$\bar{3}m$</i>
(β Sc)	100	<i>cI2</i>	<i>Im$\bar{3}m$</i>
(α Sc)	100	<i>hP2</i>	<i>P6₃/mmc</i>

Ni-Se (Nickel - Selenium)

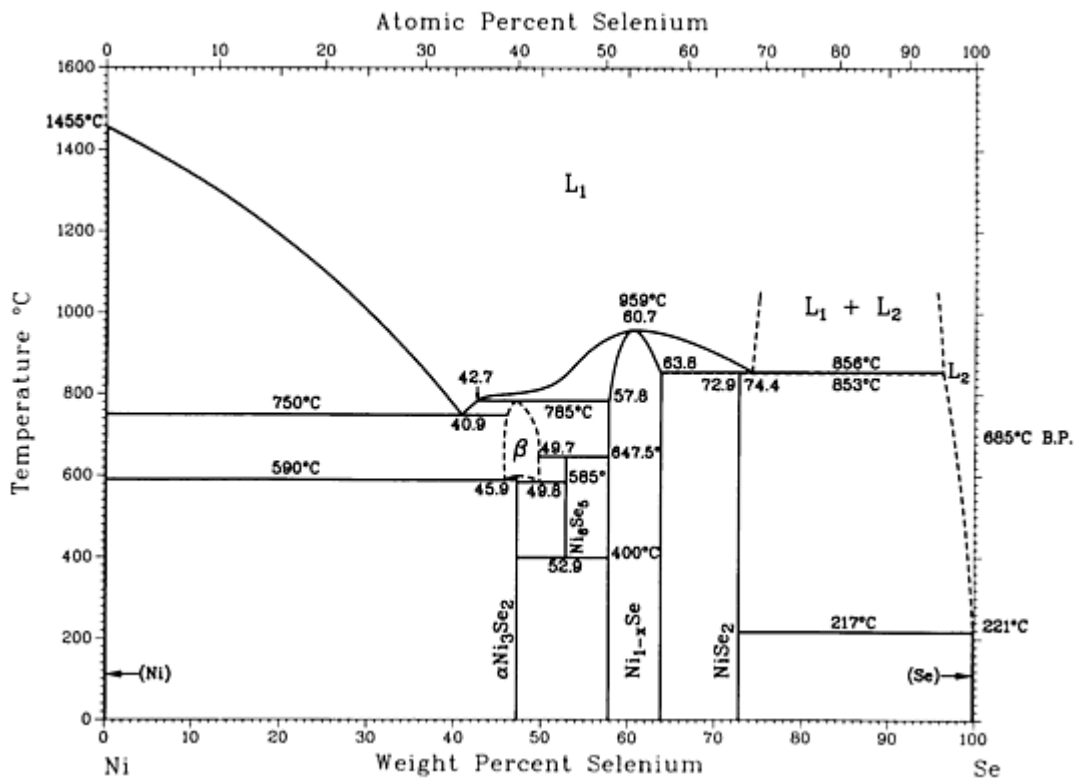

Ni-Se phase diagram

Ni-Se crystallographic data

Phase	Composition, wt% Se	Pearson symbol	Space group
(Ni)	~0	<i>cF4</i>	<i>Fm$\bar{3}m$</i>
β Ni _{3+x} Se ₂	45.9 to 49.8	<i>c**</i>	...
α Ni ₃ Se ₂	47	<i>hR5</i>	<i>R32</i>
Ni ₆ Se ₅	52.9	<i>oP88</i> <i>oC48</i>	<i>Pca2₁</i> <i>Cmcm</i>
Ni _{1-x} Se	57.8 to 63.8	<i>hP4</i>	<i>P6₃/mmc</i>
NiSe ₂	72.9	<i>cP12</i>	<i>Pa3</i>
(Se)	~100	<i>hP2</i>	<i>P3₁21</i>
Metastable phase			

α' -Ni ₃ Se ₂	47	tI^*	...
--	----	--------	-----

Ni-Si (Nickel - Silicon)

P. Nash and A. Nash, 1991

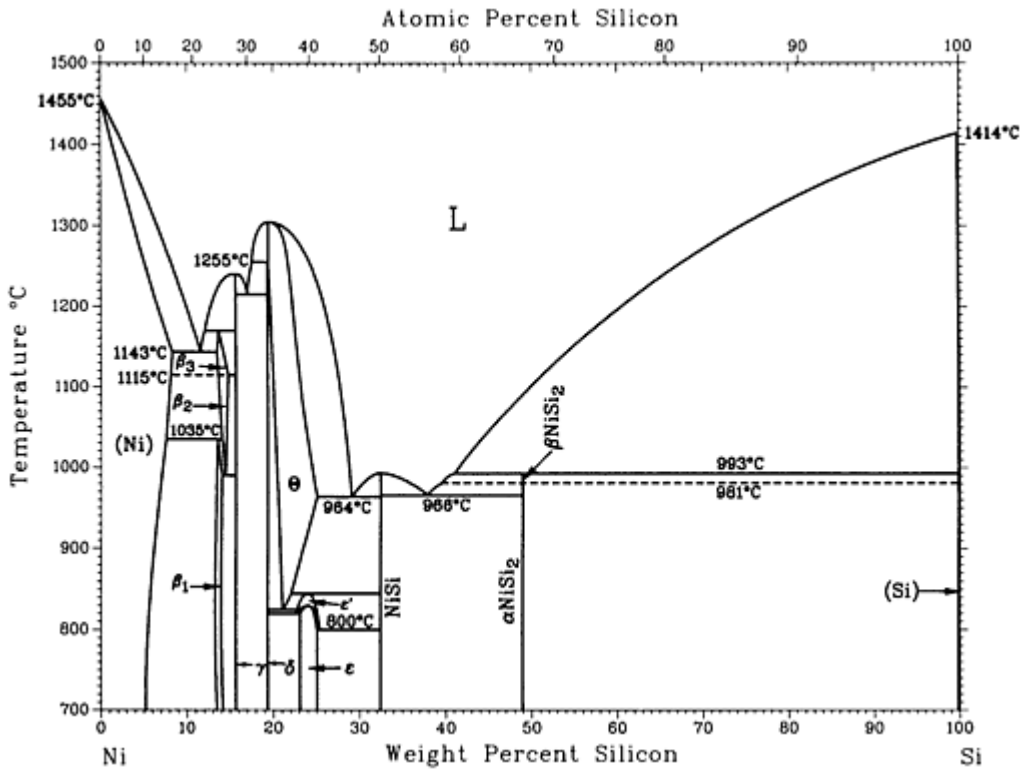

Ni-Si phase diagram

Ni-Si crystallographic data

Phase	Composition, wt% Si	Pearson symbol	Space group
(Ni)	0 to 8.2	$cF4$	$Fm\bar{3}m$
β_1 (Ni ₄ Si)	12.4 to 13.4	$cP4$	$Pm\bar{3}m$
β_3 (Ni ₃ Si)	~13.4 to 14.1	$mC16$...
β_2 (Ni ₃ Si)	~13.4 to 14.1	$mC16$...
γ (Ni ₃₁ Si ₁₂)	15.6	$hP14$...

$\theta_{(Ni_2Si)}$	19.4 to 25	<i>hP6</i>	...
$\delta_{(Ni_2Si)}$	19.3	<i>oP12</i>	...
$\epsilon_{(Ni_3Si_2)}$	23 to 25	<i>oP80</i>	...
NiSi	32.4	<i>oP8</i>	<i>Pnma</i>
β_{NiSi_2}	48.9	?	...
α_{NiSi_2}	48.9	<i>cF12</i>	<i>Fm\bar{3}m</i>
(Si)	~ 100	<i>cF8</i>	<i>Fd\bar{3}m</i>

Ni-Sm (Nickel - Samarium)

Y.Y. Pan and P. Nash, 1991

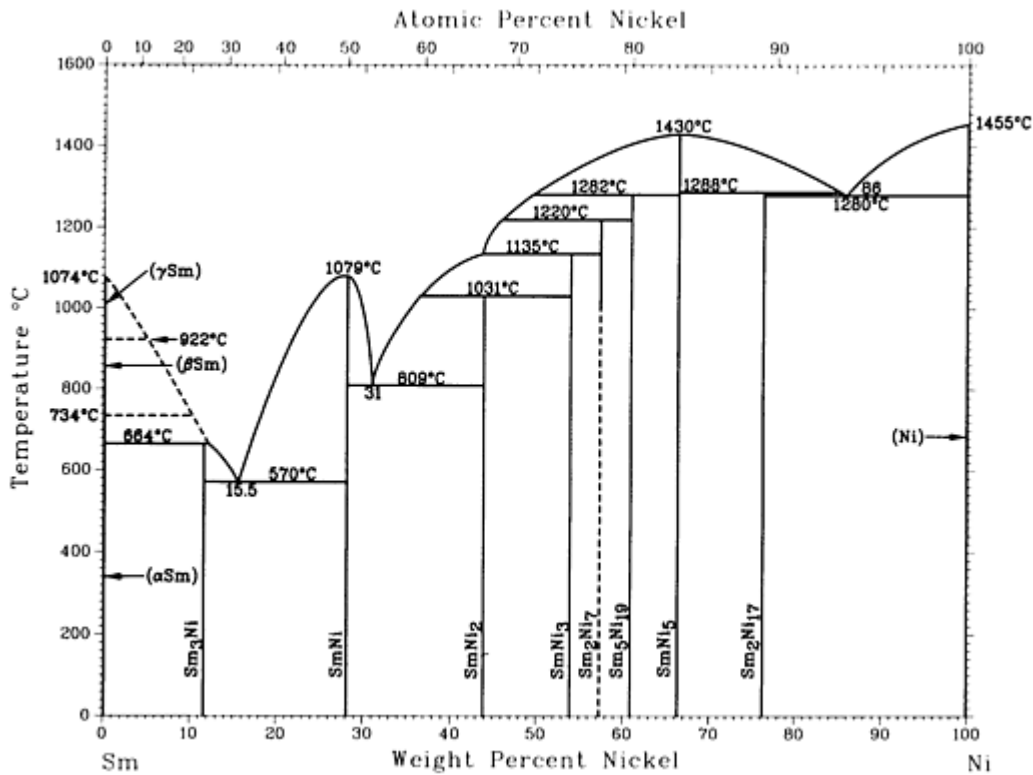

Ni-Sm phase diagram

Ni-Sm crystallographic data

Phase	Composition, wt% Ni	Pearson symbol	Space group
(γ Sm)	0	<i>cI2</i>	<i>Im$\bar{3}m$</i>
(β Sm)	0	<i>hP2</i>	<i>P6$_3$/mmc</i>
(α Sm)	0	<i>hR3</i>	<i>R$\bar{3}m$</i>
Sm ₃ Ni	11.5	<i>oP16</i>	<i>Pnma</i>
SmNi	28.1	<i>oC8</i>	<i>Cmcm</i>
SmNi ₂	43.9	<i>cF24</i>	<i>Fd$\bar{3}m$</i>
SmNi ₃	53.9	<i>hR24</i>	<i>R$\bar{3}m$</i>
Sm ₂ Ni ₇	57.8	<i>hP36</i> ^(a) <i>hR54</i> ^(b)	<i>P6$_3$/mmc</i> <i>R$\bar{3}m$</i>
Sm ₅ Ni ₁₉	59.8	^(c)	<i>P3m/1</i>
SmNi ₅	66.1	<i>hP6</i>	<i>P6/mmm</i>
Sm ₂ Ni ₁₇	76.9	<i>hP38</i>	<i>P6$_3$/mmm</i>
(Ni)	100	<i>cF4</i>	<i>Fm$\bar{3}m$</i>

(a) High-temperature form.

(b) Low-temperature form.

(c) Trigonal

Ni-Sn (Nickel - Tin)

P. Nash and A. Nash, 1991

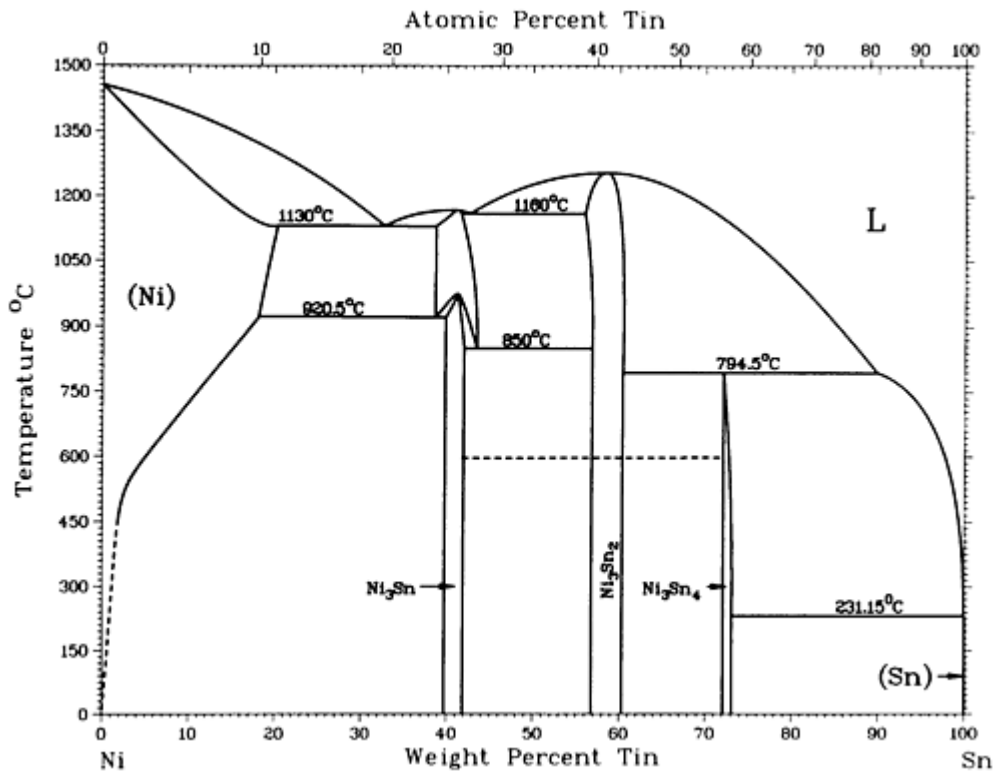

Ni-Sn phase diagram

Ni-Sn crystallographic data

Phase	Composition, wt% Sn	Pearson symbol	Space group
(Ni)	0 to 19.3	<i>cF4</i>	<i>Fm$\bar{3}m$</i>
Ni_3Sn (HT)	37.9 to 43.0	(a)	...
Ni_3Sn (LT)	39 to 41.7	<i>hP8</i>	<i>P6$_3$/mmc</i>
Ni_3Sn_2 (HT)	54.8 to 57.9	(a) (b)
Ni_3Sn_2 (LT)	55.9 to 59.9	<i>hP4</i>	<i>P6$_3$/mmc</i>
Ni_3Sn_4	71.6 to 73	<i>mC14</i>	<i>C2/m</i>
(β Sn)	~100	<i>tI4</i>	<i>I4$_1$/amd</i>

Metastable phase			
Ni ₃ Sn	40	<i>oP8</i>	<i>Pmmn</i>

(a) Hexagonal.

(b) Orthorhombic

Ni-Ta (Nickel - Tantalum)

A. Nash and P. Nash, 1991

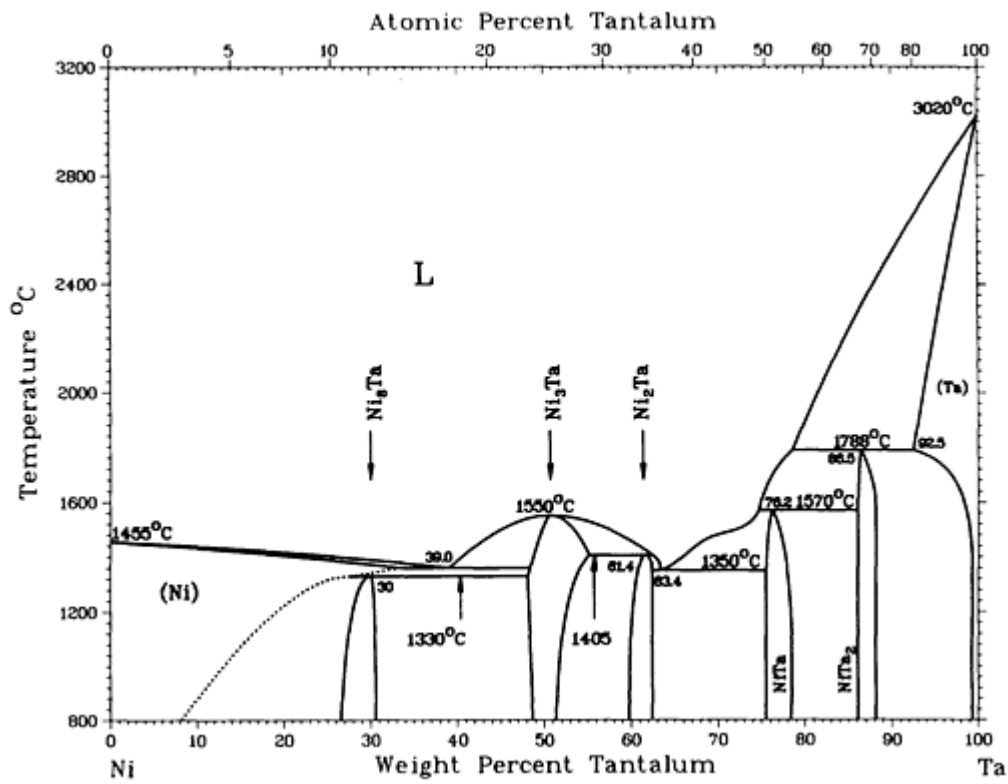

Ni-Ta phase diagram

Ni-Ta crystallographic data

Phase	Composition, wt% Ta	Pearson symbol	Space group
(Ni)	0 to 33	<i>cF4</i>	<i>Fm$\bar{3}m$</i>
Ni ₈ Ta	27.8	<i>tI36</i>	...

$\text{Ni}_3\text{Ta}(12)S$	47.2 to 55.1	$mP48$	$P2_1/m$
Ni_2Ta	59.7 to 62	$tI6$	$I4/mmm$
NiTa	75.5 to 78	$hR13$	$R\bar{3}m$
NiTa_2	86.1 to 88	$tI12$	$I4/mcm$
(Ta)	92.5 to 100	$cI2$	$Im\bar{3}m$
Metastable phases			
ζ	45
$\text{Ni}_3\text{Ta}(2)S$	51	$mP8$	$Pmmm$
$\text{Ni}_3\text{Ta}(3)S$	51	$tI8$	$I4/mmm$

Note: Number in parentheses indicates stacking period; *S* identifies the orthogonal layer type.

Ni-Te (Nickel - Tellurium)

S.Y. Lee and P. Nash, 1991

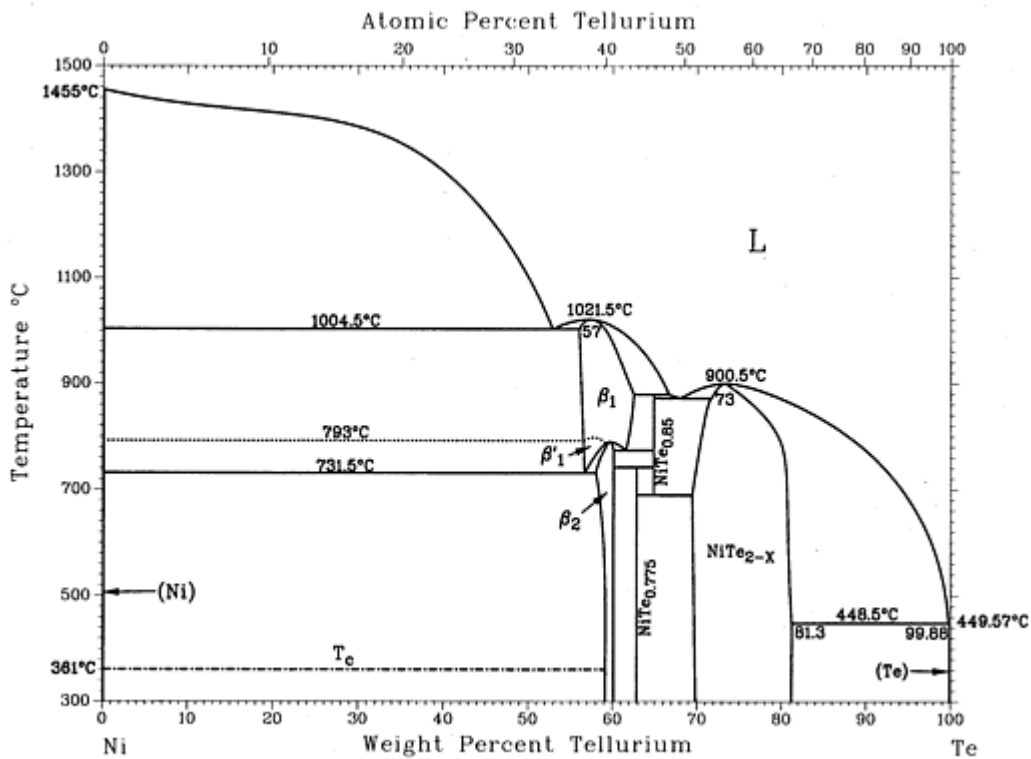

Ni-Te phase diagram

Ni-Te crystallographic data

Phase	Composition, wt% Te	Pearson symbol	Space group
(Ni)	~0	<i>cF4</i>	<i>Fm$\bar{3}m$</i>
β_1	55.9 to 62.4	<i>cF*</i>	...
β_2	58.0 to 59.7 59.7 to 60.1 60.0 to 60.4	<i>m**</i> <i>o**</i> <i>t**</i>
β_1	56.5 to 58
NiTe _{0.775}	62.7	<i>o**</i>	...
NiTe _{0.85}	64.8
NiTe _{2-x}	69.4 to 81.3	<i>hP4</i> <i>hP3</i>	<i>P6$\bar{3}$/mmc</i> <i>P$\bar{3}m1$</i>
(Te)	~100	<i>hP3</i>	<i>P3$\bar{1}21$</i>

Ni-Ti (Nickel - Titanium)

J.L. Murray, 1991

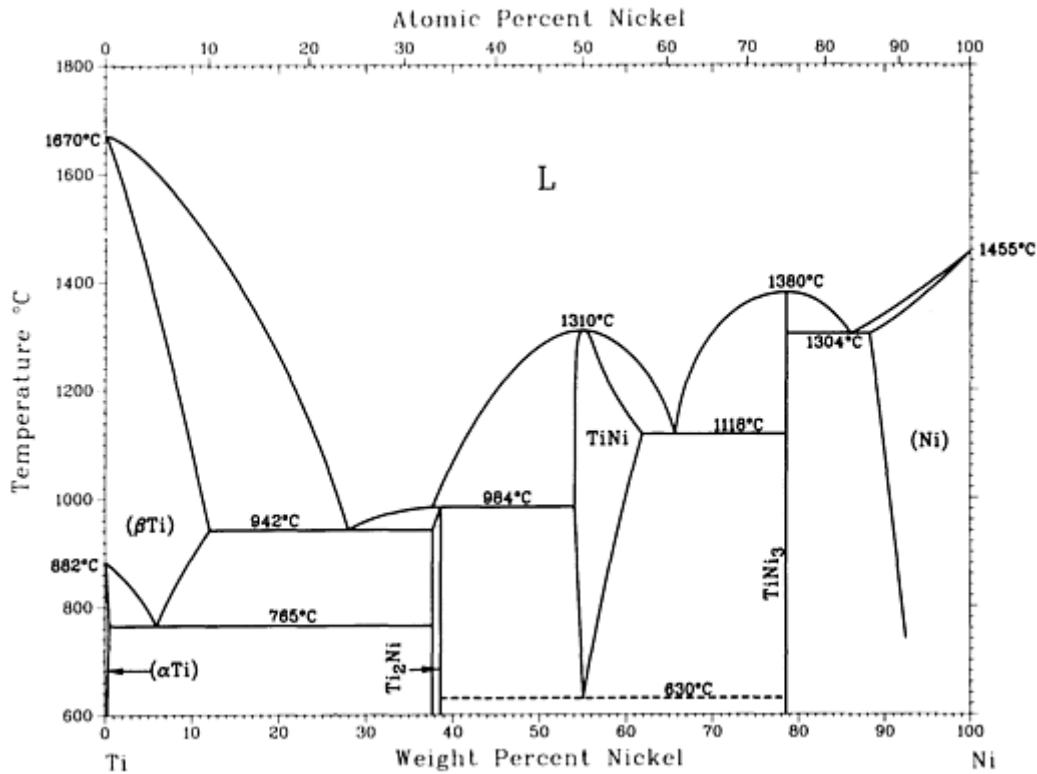

Ni-Ti phase diagram

Ni-Ti crystallographic data

Phase	Composition, wt% Ni	Pearson symbol	Space group
(βTi)	0 to 12	<i>cI2</i>	<i>Im$\bar{3}m$</i>
(αTi)	0 to 0.3	<i>hP2</i>	<i>P6₃/mmc</i>
ω ^(a)	~10	<i>hP3</i>	<i>P6/mmm</i> or <i>P$\bar{3}m1$</i>
Ti ₂ Ni	38.0	<i>cF96</i>	<i>Fd$\bar{3}m$</i>
TiNi ^(a)	~54 to 58	<i>mP4</i>	<i>P2₁/m</i>
TiNi	54.6 to 62	<i>cP2</i>	<i>Pm$\bar{3}m$</i>

γ -TiNi ₃ ^(a)	~77	<i>hR21</i>	<i>R$\bar{3}m$</i>
TiNi ₃	79	<i>hP16</i>	<i>P6₃/mmc</i>
γ -TiNi ₃ ^(a)	~86 to 90	<i>cP4</i>	<i>Pm$\bar{3}m$</i>
(Ni)	88.4 to 100	<i>cF4</i>	<i>Fm$\bar{3}m$</i>

(a) Metastable

Ni-U (Nickel - Uranium)

D.E. Peterson, 1991

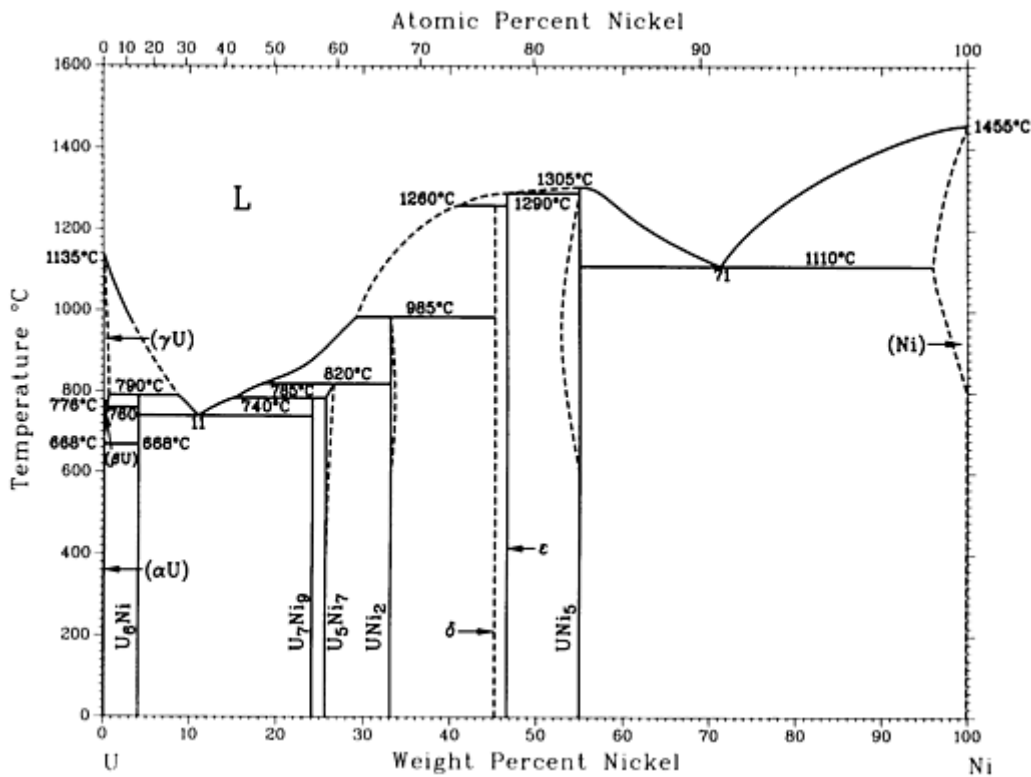

Ni-U phase diagram

Ni-U crystallographic data

Phase	Composition, wt% Ni	Pearson symbol	Space group
(γU)	0 to 0.5	<i>cI2</i>	<i>Im$\bar{3}m$</i>

(β_{U})	0 to 0.2	<i>tP30</i>	<i>P4₂/mmm</i>
(α_{U})	0	<i>oC4</i>	<i>Cmcm</i>
U ₆ Ni	4.0	<i>tI28</i>	<i>I4/mcm</i>
U ₇ Ni ₉	24.0
U ₅ Ni ₇	25.6 to 26.6
UNi ₂	33.1 to 33.4	<i>hP12</i>	<i>P6₃/mmc</i>
δ	45.2
ϵ	46.6
$\eta^{(a)}$	52.9
UNi ₅	53.8 to 55.2	<i>cF24</i>	<i>F$\bar{4}$3m</i>
(Ni)	93.1 to 100	<i>cF4</i>	<i>Fm$\bar{3}$m</i>

(a) Existence tentative

Ni-V (Nickel - Vanadium)

J.F. Smith, O.N. Carlson, and P. Nash, 1991

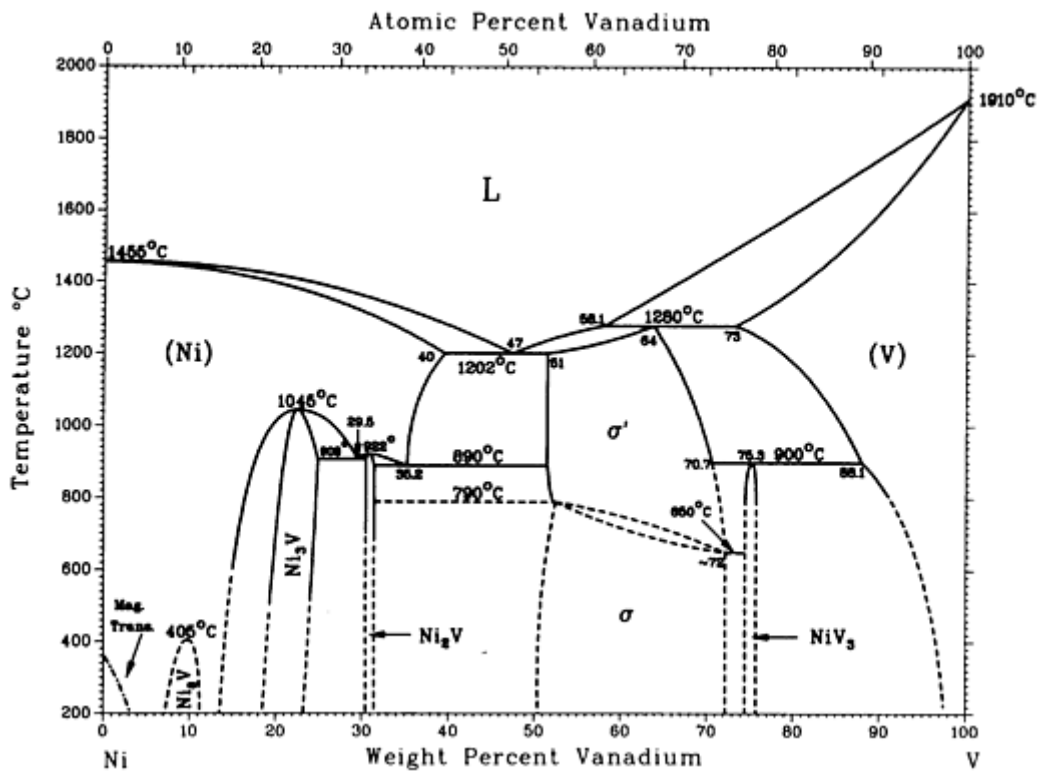

Ni-V phase diagram

Ni-V crystallographic data

Phase	Composition, wt% V	Pearson symbol	Space group
(Ni)	0 to 40	<i>cF4</i>	<i>Fm</i> $\bar{3}m$
Ni ₈ V	~9.8	<i>tI18</i>	...
Ni ₃ V	~19 to 23.0	<i>tI8</i>	<i>I4/mmm</i>
Ni ₂ V	~30.2	<i>oI6</i>	...
σ'	51 to ~72
σ	54.0 to ~72	<i>tP30</i>	<i>P4₂/mnm</i>

NiV ₃	74.9 to 76.0	<i>cP8</i>	<i>Pm</i> $\bar{3}n$
(V)	73 to 100	<i>cI2</i>	<i>Im</i> $\bar{3}m$

Ni-W (Nickel - Tungsten)

H. Okamoto, 1991

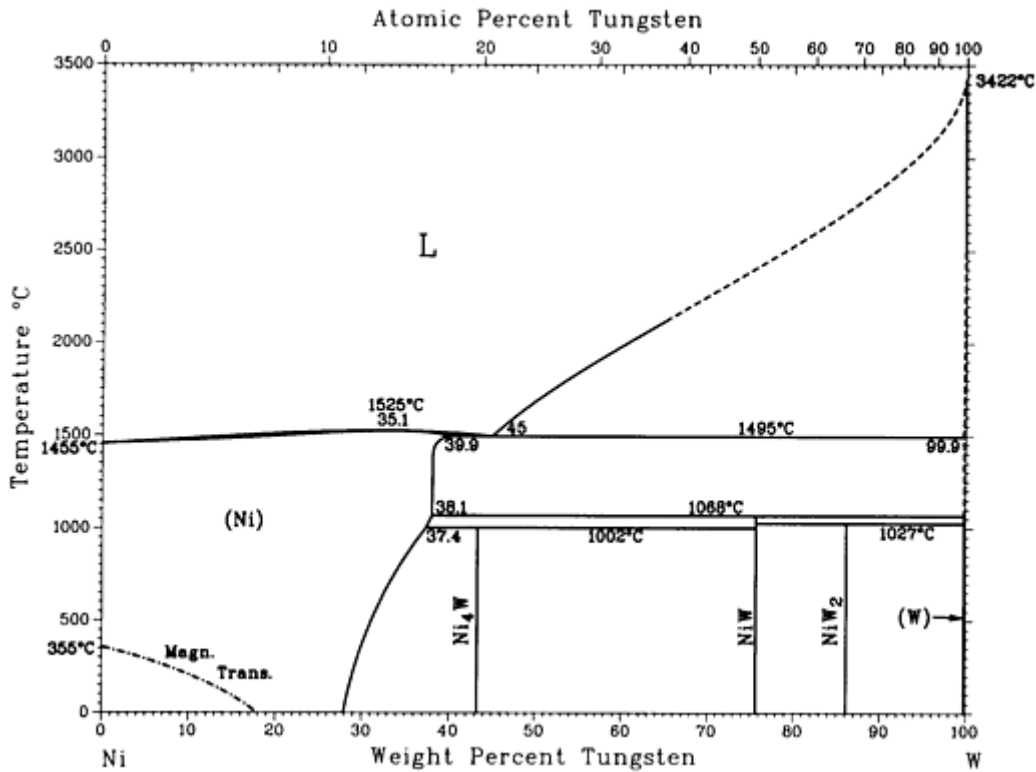

Ni-W phase diagram

Ni-W crystallographic data

Phase	Composition, wt% W	Pearson symbol	Space group
(Ni)	0 to 39.9	<i>cF4</i>	<i>Fm</i> $\bar{3}m$
Ni ₄ W	~44	<i>tI10</i>	<i>I4/m</i>
NiW	~75.8	<i>o**</i>	...
NiW ₂	86.3	<i>tI96</i>	<i>I4</i>

(W)	99.9 to 100	<i>cI2</i>	<i>Im</i> $\bar{3}m$
-----	-------------	------------	----------------------

Ni-Y (Nickel - Yttrium)

P. Nash, 1991

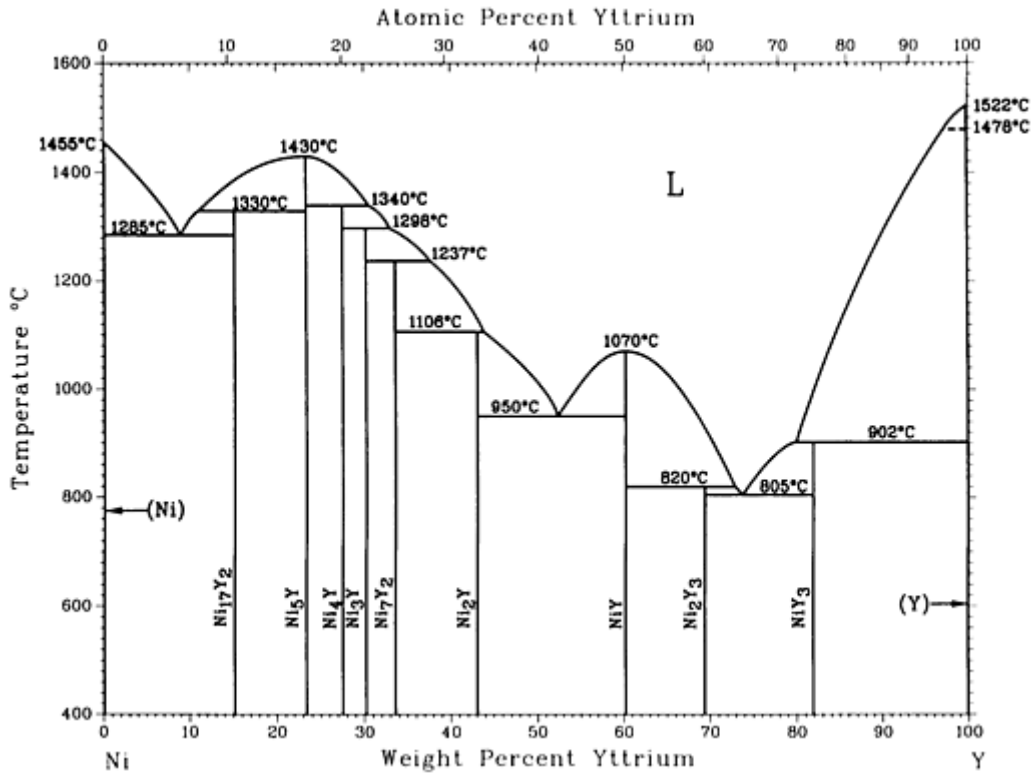

Ni-Y phase diagram

Ni-Y crystallographic data

Phase	Composition, wt% Y	Pearson symbol	Space group
(Ni)	0	<i>cF4</i>	<i>Fm</i> $\bar{3}m$
Ni ₁₇ Y ₂	15.1	<i>hP*</i>	<i>P6</i> ₃ / <i>mmc</i>
Ni ₅ Y	23.3	<i>hP6</i>	<i>P6</i> / <i>mmm</i>
Ni ₄ Y	27.5
Ni ₇ Y ₂	30.2	<i>hR*</i>	<i>R</i> $\bar{3}m$

Ni ₃ Y	33.6	<i>hP</i> ** <i>hR</i> *	<i>P6</i> ₃ / <i>mmc</i> <i>R</i> $\bar{3}$ <i>m</i>
Ni ₂ Y	43.1	<i>cF</i> 24	<i>Fd</i> $\bar{3}$ <i>m</i>
NiY	60.2	<i>oP</i> 8	<i>Pnma</i>
Ni ₂ Y ₃	69.4	<i>t</i> **	<i>P4</i> ₁ <i>2</i> ₁ <i>2</i>
NiY ₃	82.0	<i>oP</i> 16	<i>Pnma</i>
(β Y)	100	<i>cF</i> 4	<i>Fm</i> $\bar{3}$ <i>m</i>
(α Y)	100	<i>hP</i> 2	<i>P6</i> ₃ / <i>mmc</i>

Ni-Yb (Nickel - Ytterbium)

P. Nash, 1991

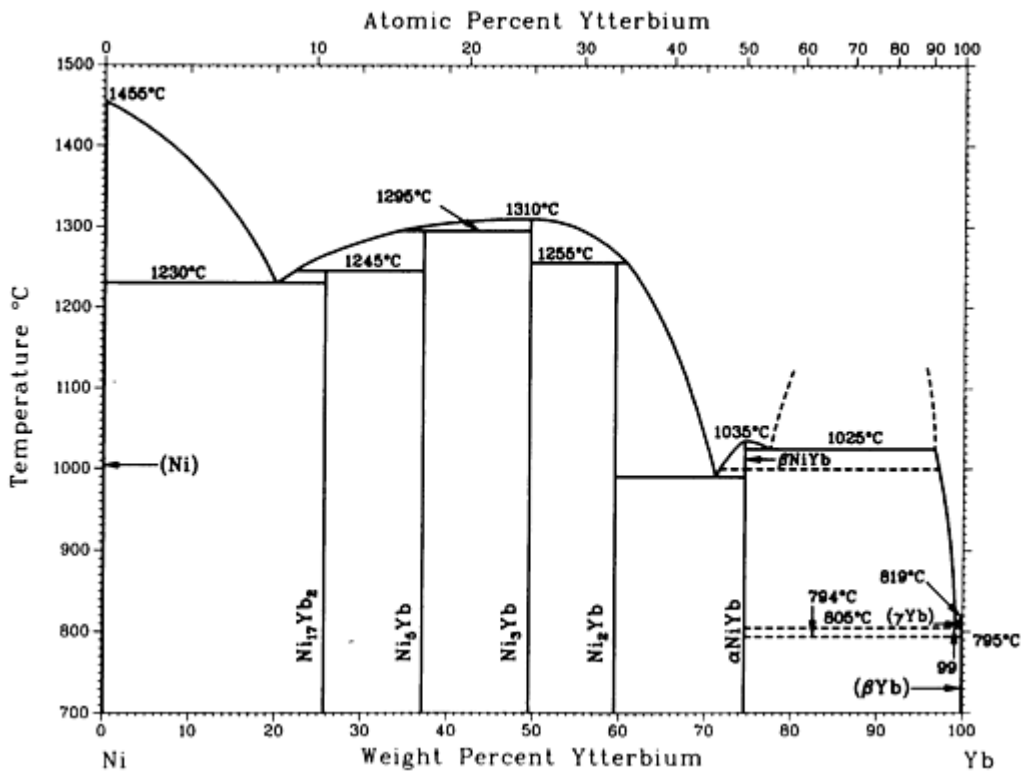

Ni-Yb phase diagram

Ni-Yb crystallographic data

Phase	Composition,	Pearson	Space
-------	--------------	---------	-------

	wt% Yb	symbol	group
(Ni)	0	<i>cF4</i>	<i>Fm$\bar{3}m$</i>
Ni ₁₇ Yb ₂	25.7	<i>hP38</i>	<i>P6₃/mmc</i>
Ni ₅ Yb	37.2	<i>hP6</i>	<i>P6/mmm</i>
Ni ₃ Yb	49.6	<i>hR12</i>	<i>R$\bar{3}m$</i>
Ni ₂ Yb	59.5	<i>cF24</i>	<i>Fd$\bar{3}m$</i>
α NiYb	74.7	<i>oP8</i>	<i>Pnma</i>
(γ Yb)	100	<i>cI2</i>	<i>Im$\bar{3}m$</i>
(β Yb)	100	<i>cF4</i>	<i>Fm$\bar{3}m$</i>
(α Yb)	100	<i>hP2</i>	<i>P6₃/mmc</i>

Ni-Zn (Nickel - Zinc)

P. Nash and Y.Y. Pan, 1991

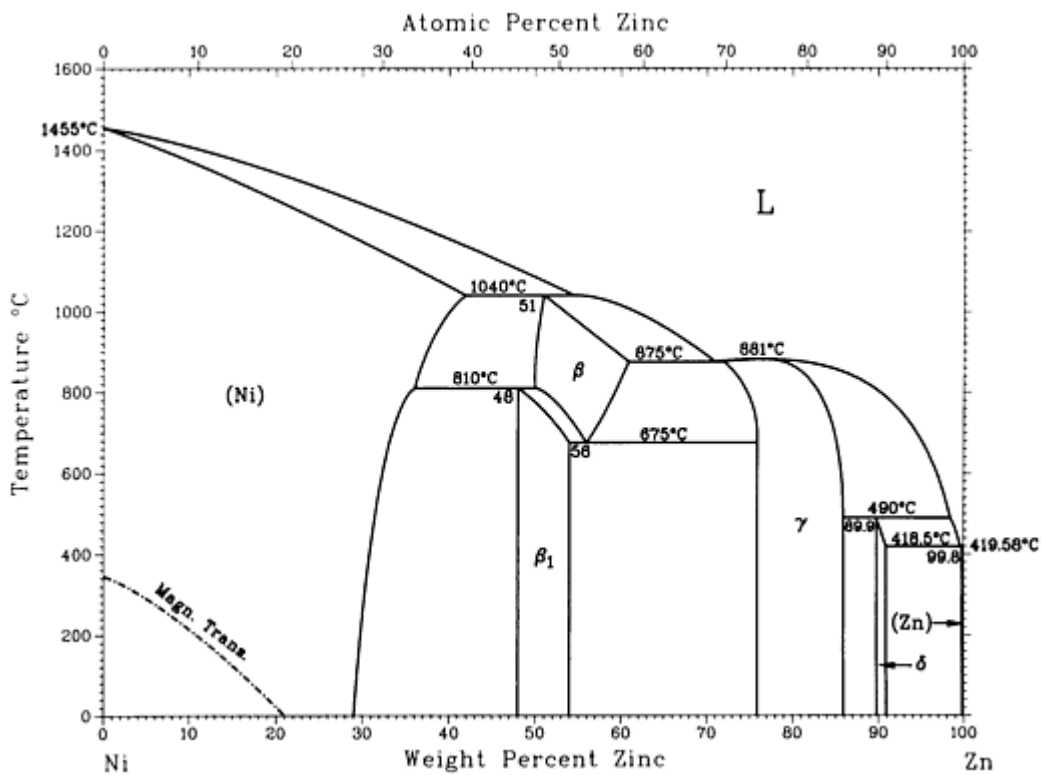

Ni-Zn phase diagram

Ni-Zn crystallographic data

Phase	Composition, wt% Zn	Pearson symbol	Space group
(Ni)	0 to 41.9	<i>cF4</i>	<i>Fm$\bar{3}m$</i>
β	50.0 to 60.9	<i>cP2</i>	<i>Pm$\bar{3}m$</i>
β_1	48.0 to 54.5	<i>tP2</i>	<i>P4/mmm</i>
$\gamma^{(a)}$	72 to 86	<i>cI52</i>	<i>I$\bar{4}3m$</i>
δ	~90	<i>mC6</i>	<i>C2/m</i>
(Zn)	100	<i>hP2</i>	<i>P6$_3$/mmc</i>

(a) Might have orthorhombic structure

Ni-Zr (Nickel - Zirconium)

P. Nash and C.S. Jayanthi, 1991

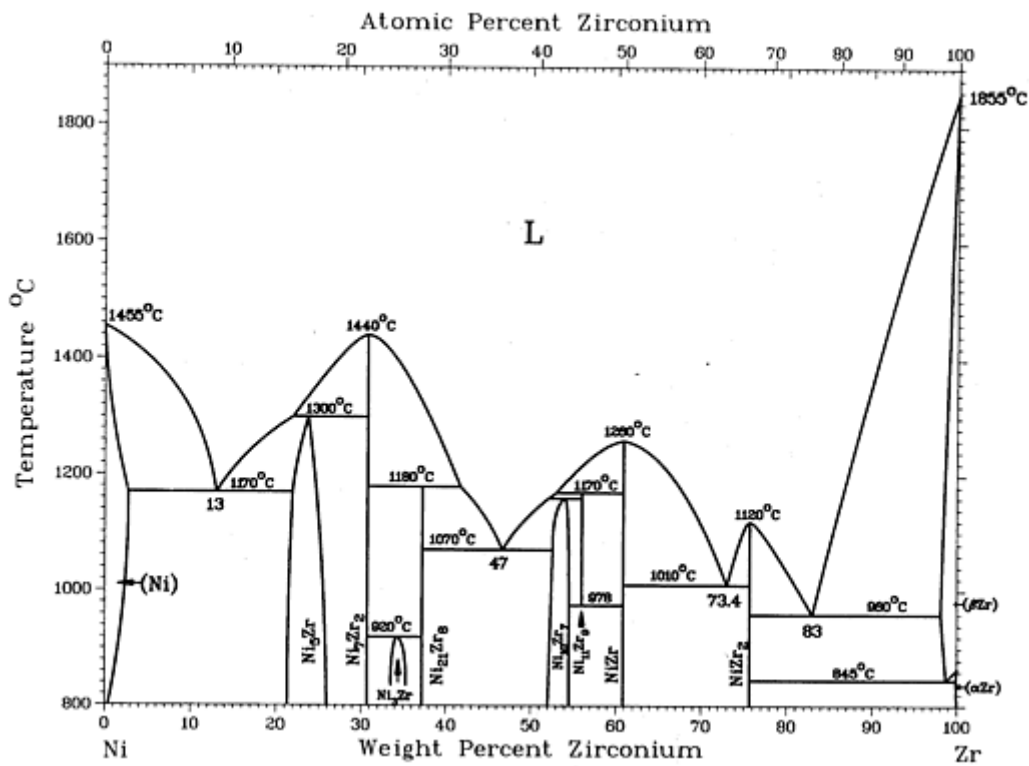

Ni-Zr phase diagram

Ni-Zr crystallographic data

Phase	Composition, wt% Zr	Pearson symbol	Space group
(Ni)	0 to 2.74	<i>cF4</i>	<i>Fm</i> $\bar{3}m$
Ni ₅ Zr	21.32 to 25.95	<i>cF24</i>	<i>F</i> $\bar{4}3m$
Ni ₇ Zr ₂	30.75	<i>mC36</i>	<i>C2/m</i>
Ni ₃ Zr	33.5 to 35.3	<i>hP8</i>	<i>P6₃/mmc</i>
Ni ₂₁ Zr ₈	37.2	(a)	...
Ni ₁₀ Zr ₇	52.0 to 54.52	<i>oC68</i>	<i>C2ca</i> ^(b) <i>Pbca</i> ^(c)
Ni ₁₁ Zr ₉	56.0	<i>tI40</i>	<i>I4/m</i>
NiZr	60.9	<i>oC8</i>	<i>Cmcm</i>

NiZr ₂	75.7	<i>tI12</i>	<i>I4/mcm</i>
(β Zr)	98.10 to 100	<i>cI2</i>	<i>Im$\bar{3}m$</i>
(α Zr)	99.9 to 100	<i>hP2</i>	<i>P6₃/mmc</i>

(a) Triclinic.

(b) Stoichiometric.

(c) Zr-rich

Np (Neptunium) Binary Alloy Phase Diagrams

Introduction

THIS ARTICLE includes systems where neptunium is the first-named element in the binary pair.

Np-Pu (Neptunium - Plutonium)

R.I. Sheldon and D.E. Peterson, 1985

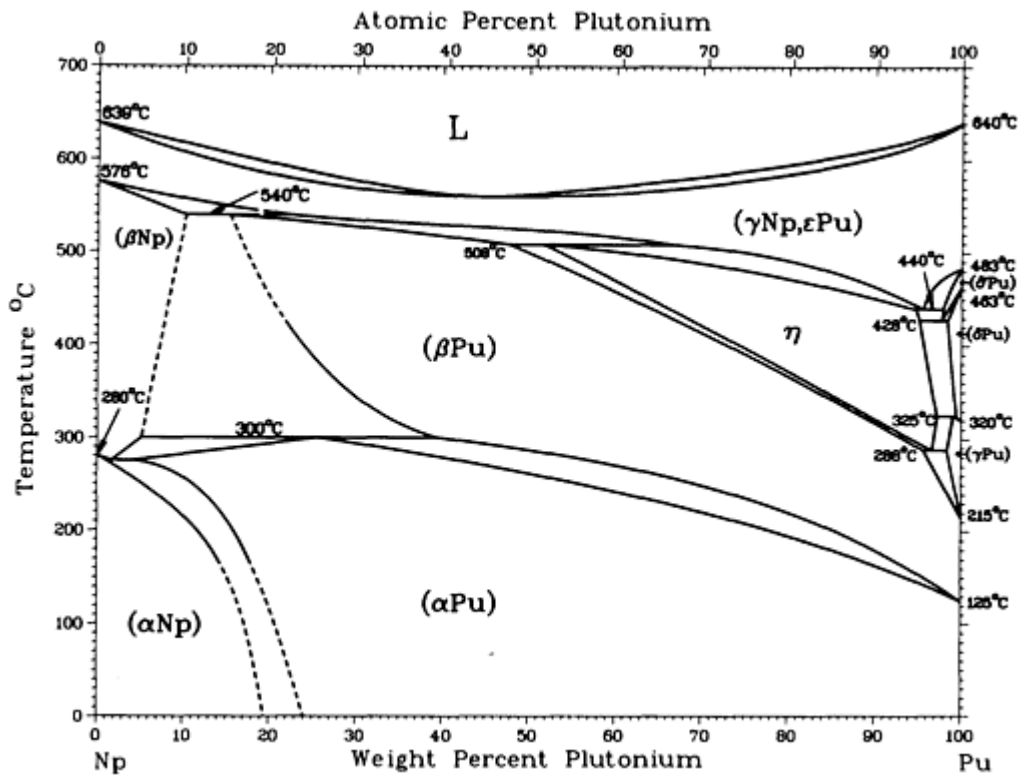

Np-Pu phase diagram

Np-Pu crystallographic data

Phase	Composition, wt% Pu	Pearson symbol	Space group
($\gamma_{Np,\epsilon Pu}$)	0 to 100	<i>cI2</i>	<i>Im$\bar{3}m$</i>
(β_{Np})	0 to 10.3	<i>tP4</i>	<i>P4₂12</i>
(α_{Np})	0 to 19.5	<i>oP8</i>	<i>Pnma</i>
η	52 to 97.1	^(a)	...
(δ_{Pu})	97.7 to 100	<i>tI2</i>	<i>I4/mmm</i>
(δ_{Pu})	98.3 to 100	<i>cF4</i>	<i>Fm$\bar{3}m$</i>
(γ_{Pu})	98.3 to 100	<i>oF8</i>	<i>Fddd</i>
(β_{Pu})	15.4 to 100	<i>mC34</i>	<i>C2/m</i>

(α Pu)	4.1 to 100	<i>mP16</i>	<i>P2₁/m</i>
----------------	------------	-------------	-------------------------

(a) Orthorhombic (tentative)

Np-U (Neptunium - Uranium)

R.I. Sheldon and D.E. Peterson, 1985

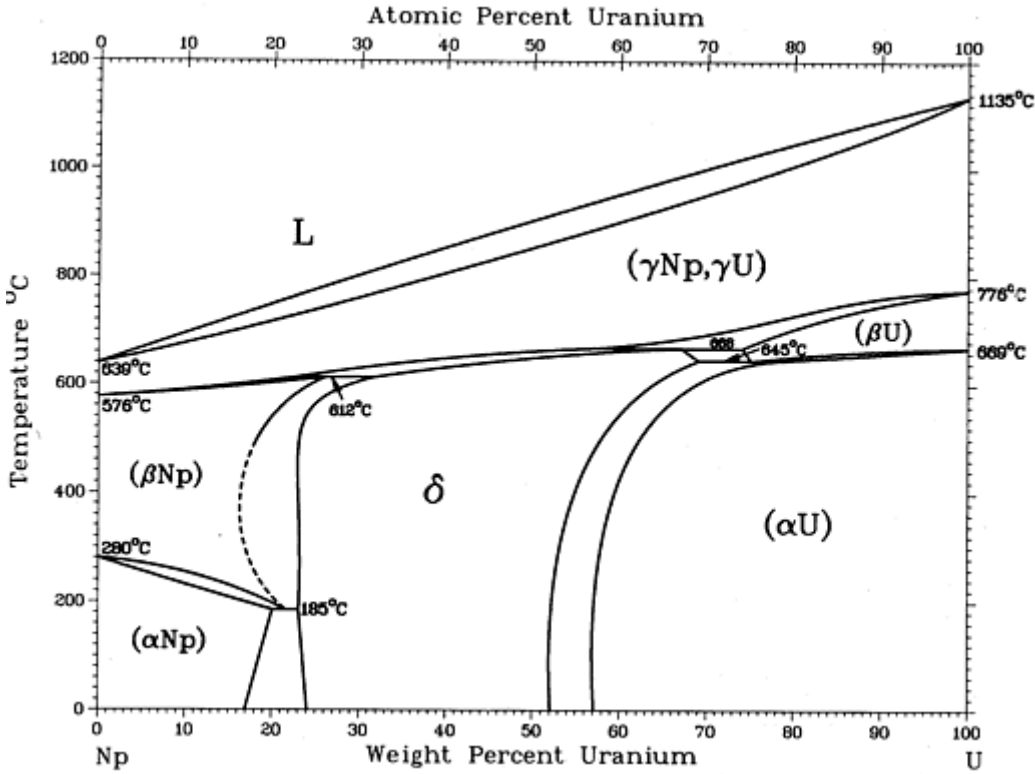

Np-U phase diagram

Np-U crystallographic data

Phase	Composition, wt% U	Pearson symbol	Space group
(γ Np, γ U)	0 to 100	<i>cI2</i>	<i>Im$\bar{3}m$</i>
(β Np)	0 to 26	<i>tP4</i>	<i>P4₂12</i>
(α Np)	0 to 20	<i>oP8</i>	<i>Pnma</i>
δ	23 to 69	<i>cP58^(a)</i>	...

(β_U)	74 to 100	<i>tP30</i>	<i>P4₂/mmm</i>
(α_U)	57 to 100	<i>oC4</i>	<i>Cmcm</i>

(a) Tentative

O (Oxygen) Binary Alloy Phase Diagrams

Introduction

THIS ARTICLE includes systems where oxygen is the first-named element in the binary pair. Additional binary systems that include oxygen are provided in the following locations in this Volume:

- “Ca-O (Calcium - Oxygen)” in the article “Ca (Calcium) Binary Alloy Phase Diagrams.”
- “Ce-O (Cerium - Oxygen)” in the article “Ce (Cerium) Binary Alloy Phase Diagrams.”
- “Cr-O (Chromium - Oxygen)” in the article “Cr (Chromium) Binary Alloy Phase Diagrams.”
- “Cs-O (Cesium - Oxygen)” in the article “Cs (Cesium) Binary Alloy Phase Diagrams.”
- “Cu-O (Copper - Oxygen)” in the article “Cu (Copper) Binary Alloy Phase Diagrams.”
- “Fe-O (Iron - Oxygen)” in the article “Fe (Iron) Binary Alloy Phase Diagrams.”
- “Hf-O (Hafnium - Oxygen)” in the article “Hf (Hafnium) Binary Alloy Phase Diagrams.”
- “Mn-O (Manganese - Oxygen)” in the article “Mn (Manganese) Binary Alloy Phase Diagrams.”
- “Mo-O (Molybdenum - Oxygen)” in the article “Mo (Molybdenum) Binary Alloy Phase Diagrams.”
- “Na-O (Sodium - Oxygen)” in the article “Na (Sodium) Binary Alloy Phase Diagrams.”
- “Ni-O (Nickel - Oxygen)” in the article “Ni (Nickel) Binary Alloy Phase Diagrams.”

O-Pb (Oxygen - Lead)

H.A. Wriedt, 1988

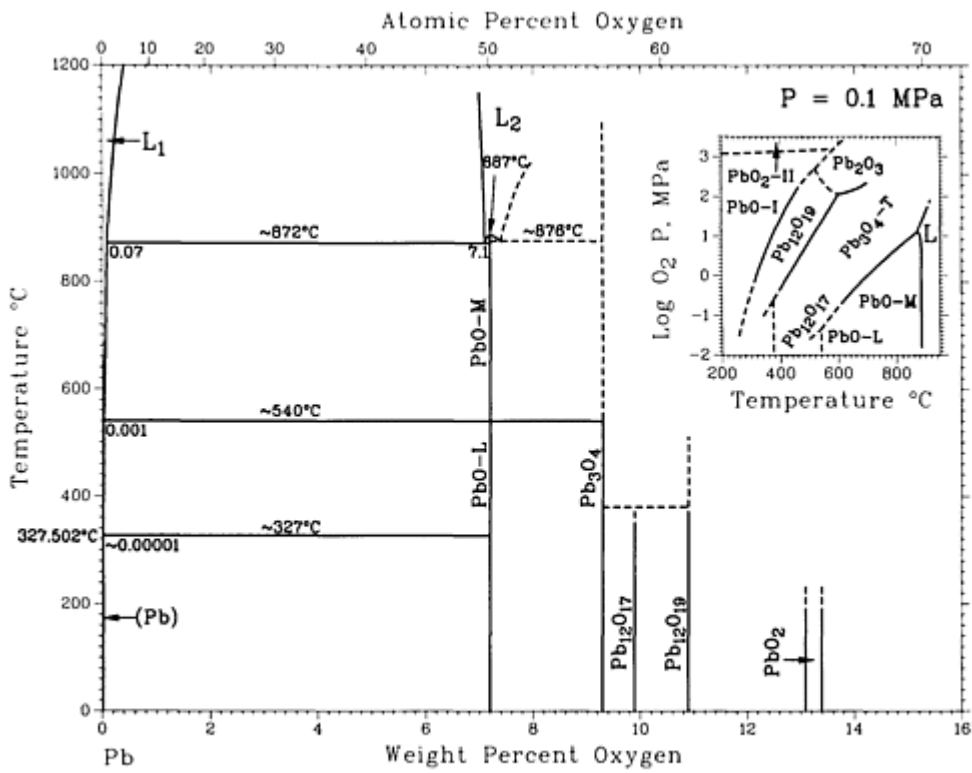

Inset shows equilibrium phase fields under identical hydrostatic and partial O₂ gas pressures

O-Pb (condensed system, 0.1 MPa) phase diagram

O-Pb crystallographic data

Phase	Composition, wt% O	Pearson symbol	Space group
Stable (0.1 MPa)			
(Pb)	0	<i>cF4</i>	<i>Fm</i> $\bar{3}m$
PbO-M	7.2	<i>oP8</i>	<i>Pbma</i>
PbO-L	7.2	<i>tP4</i>	<i>P4/nmm</i>
Pb ₃ O ₄ -T	9.3	<i>tP28</i>	<i>P4₂/mbc</i>
Pb ₃ O ₄ -R	9.3	<i>oP28</i>	<i>Pbam</i>
Pb ₁₂ O ₁₇	9.9	<i>oP58?</i>	<i>Pmc2₁?</i>
Pb ₁₂ O ₁₉	10.9	<i>mP62</i>	<i>Pc?</i> or <i>P2₁/c</i>

PbO ₂ -I	13.1 to 13.4 ^(a)	<i>tP6</i>	<i>P4₂/mmm</i>
Other			
(ϵ Pb) ^(b)	0	<i>hP2</i>	<i>P6₃/mmc</i>
Pb ₂ O ₃ ^(b)	10.4	<i>mP20</i>	<i>P2₁/a</i>
PbO ₂ -II ^(b)	13.4	<i>oP12</i>	<i>Pbcn</i>
PbO ₂ -III ^(b)	13.4	<i>cF12</i>	<i>Fm$\bar{3}m$</i>
PbO α	7.2	(c)	...
PbO	7.2	(d)	<i>P2₁ or P2₁/m</i>
PbO _n	9.3 to 10.8	(c)	...
Pb ₃ O ₄	9.3	(c)	...
Pb ₁₂ O ₁₇	9.9	(e)	...
Pb ₁₂ O ₁₉ (II)	10.9	(d)	...
Pb₁₂O₁₉	10.9	(e)	...

(a) Contains a small amount of hydrogen.

(b) Stable at hydrostatic pressures elevated from 0.1 MPa.

(c) Orthorhombic.

(d) Monoclinic.

(e) Pseudocubic?

O-Pr (Oxygen - Praseodymium)

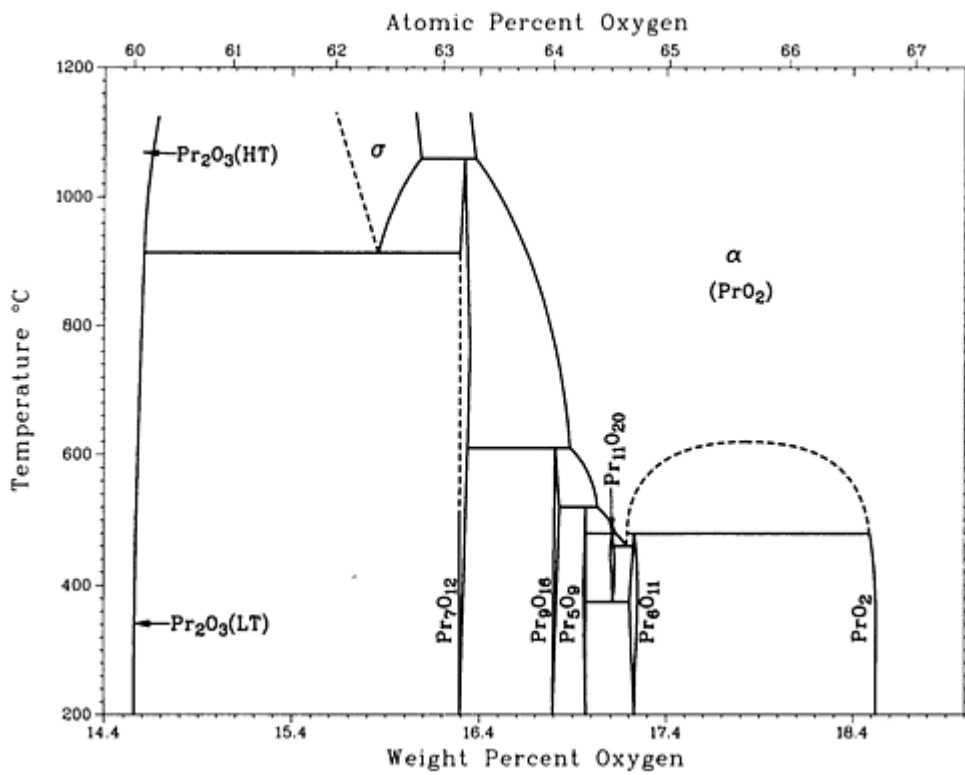

O-Pr phase diagram

O-Pr crystallographic data

Phase	Composition, wt% O	Pearson symbol	Space group
(β_{Pr})	0	$cI2$	$Im\bar{3}m$
(α_{Pr})	0	$hP4$	$P6_3/mmc$
$\text{Pr}_2\text{O}_3(\text{HT})$	~15	$hP5$	$P\bar{3}m1$
$\text{Pr}_2\text{O}_3(\text{LT})$	~15	$cI80$	$Ia\bar{3}$
$\sigma^{(a)}$	~16.0	$cI80$	$Ia\bar{3}$
Pr_7O_{12}	~16.3	$hR19$	$R\bar{3}$
Pr_9O_{16}	~17	aP^*	$P\bar{1}$
Pr_5O_9	~17.0	$mP112$	$P2_1/c$

$\text{Pr}_{11}\text{O}_{20}$	~ 17.1	m^{**}	...
Pr_6O_{11}	~ 17.2	c^{**}	...
$\text{PrO}_2(\alpha)$	~ 18.5	$cF12$	$Fm\bar{3}m$
High-pressure phase			
$\text{PrO}^{(b)}$	10.2	cF^*	...

(a) Reported to be a high-temperature phase; stable above ~ 920 °C.

(b) Obtained by reduction of Pr_2O_3 by Pr at 800 °C and 50 kbar

O-Pu (Oxygen - Plutonium)

H.A. Wriedt, 1990

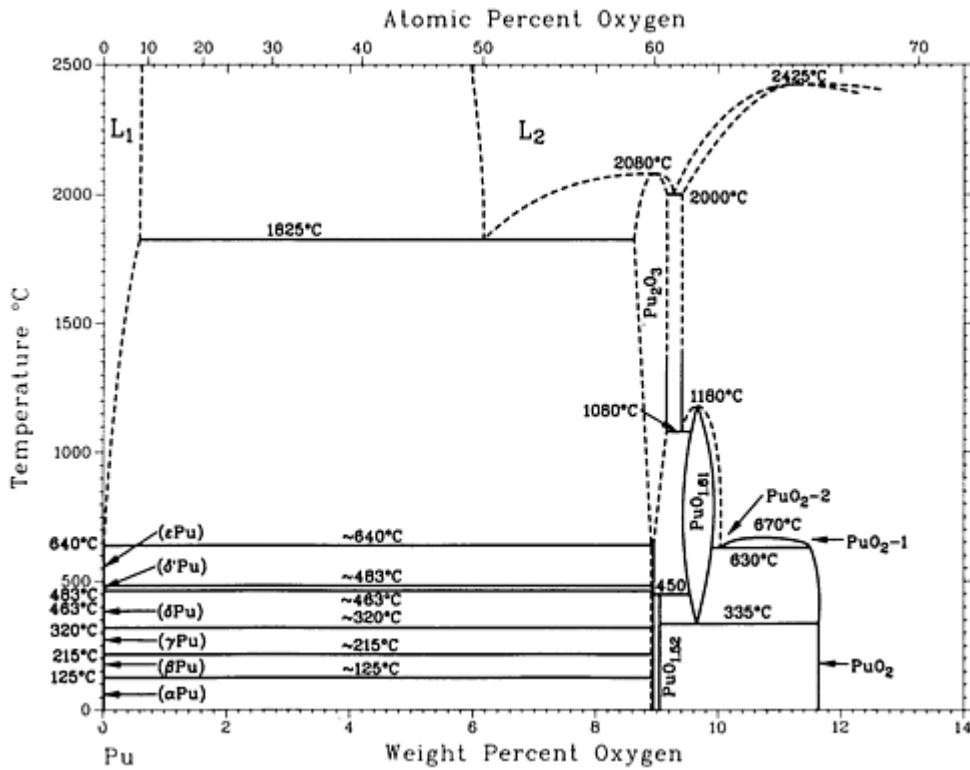

O-Pu (condensed system) phase diagram

O-Pu crystallographic data

Phase	Composition,	Pearson	Space
-------	--------------	---------	-------

	wt% O	symbol	group
Stable			
(α Pu)	~ 0	<i>mP16</i>	<i>P2₁/m</i>
(β Pu)	~ 0	<i>mC34</i>	<i>C2/m</i>
(γ Pu)	~ 0	<i>oF8</i>	<i>Fddd</i>
(δ Pu)	~ 0	<i>cF4</i>	<i>Fm$\bar{3}$m</i>
(δ' Pu)	~ 0	<i>tI2</i>	<i>I4/mmm</i>
(ϵ Pu)	~ 0	<i>cI2</i>	<i>Im$\bar{3}$m</i>
P ₂ O ₃ ^(a)	~ 8.9 to ~ 9.0	<i>hP5</i>	<i>P$\bar{3}$m1</i>
PuO _{1.52} ^(b)	~ 9.1	<i>cI80</i>	<i>Ia$\bar{3}$</i>
PuO _{1.61} ^(b)	~ 9.6 to ~ 10.0	<i>cI80</i>	<i>Ia$\bar{3}$</i>
PuO ₂	~ 9 to $11.6^{(c)}$	<i>cF12</i>	<i>Fm$\bar{3}$m</i>
Other			
Pu	...	<i>hP2</i>	<i>P6₃/mmc</i>

(a) The lower limit at 1100 °C might be 58.8 at.% O.

(b) Possibly unconnected ranges of the same phase.

(c) At 0.1 MPa O₂ pressure

O-Sn (Oxygen - Tin)

From [Hansen] 6

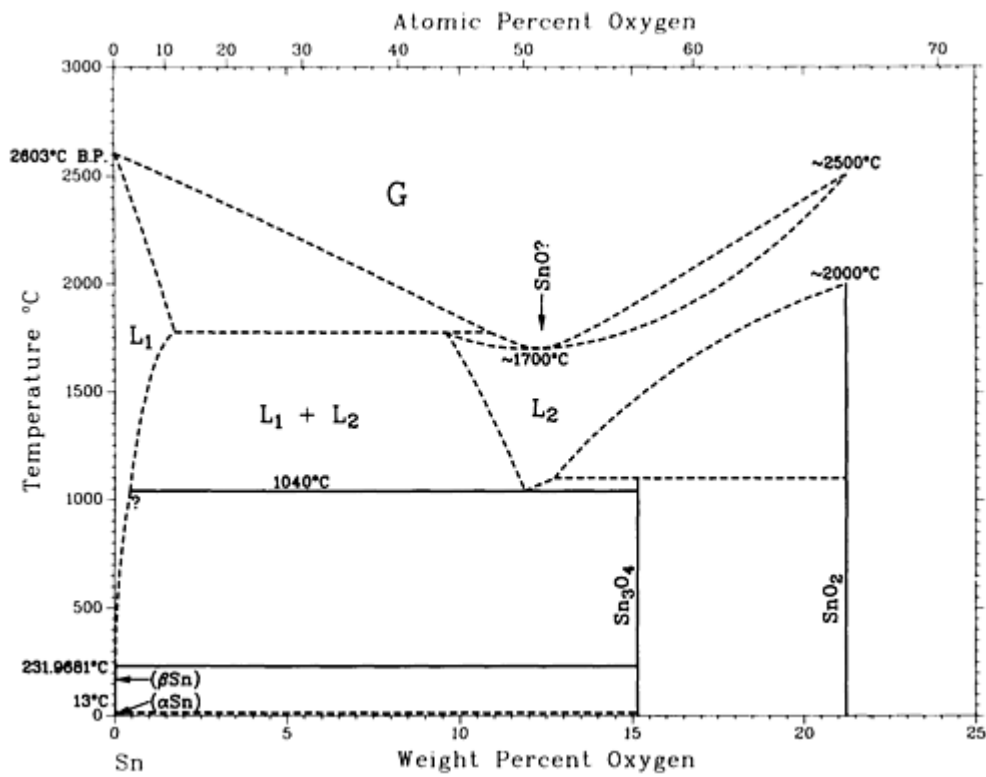

O-Sn phase diagram

O-Sn crystallographic data

Phase	Composition, wt% O	Pearson symbol	Space group
(βSn)	0	<i>tI4</i>	<i>I4₁/amd</i>
(αSn)	0	<i>cF8</i>	<i>Fd$\bar{3}m$</i>
SnO(?)	11.9	<i>tP4</i>	<i>P4/nmm</i>
Sn ₃ O ₄	15.2	<i>a**</i>	...
SnO ₂	21.3	<i>tP6</i>	<i>P4₂/mnm</i>

Reference cited in this section

- [Hansen]: M. Hansen and K. Anderko, *Constitution of Binary Alloys*, McGraw-Hill, New York or General Electric Co., Business Growth Services, Schenectady, New York (1958).

O-Ti (Oxygen - Titanium)

J.L. Murray and H.A. Wriedt, 1987

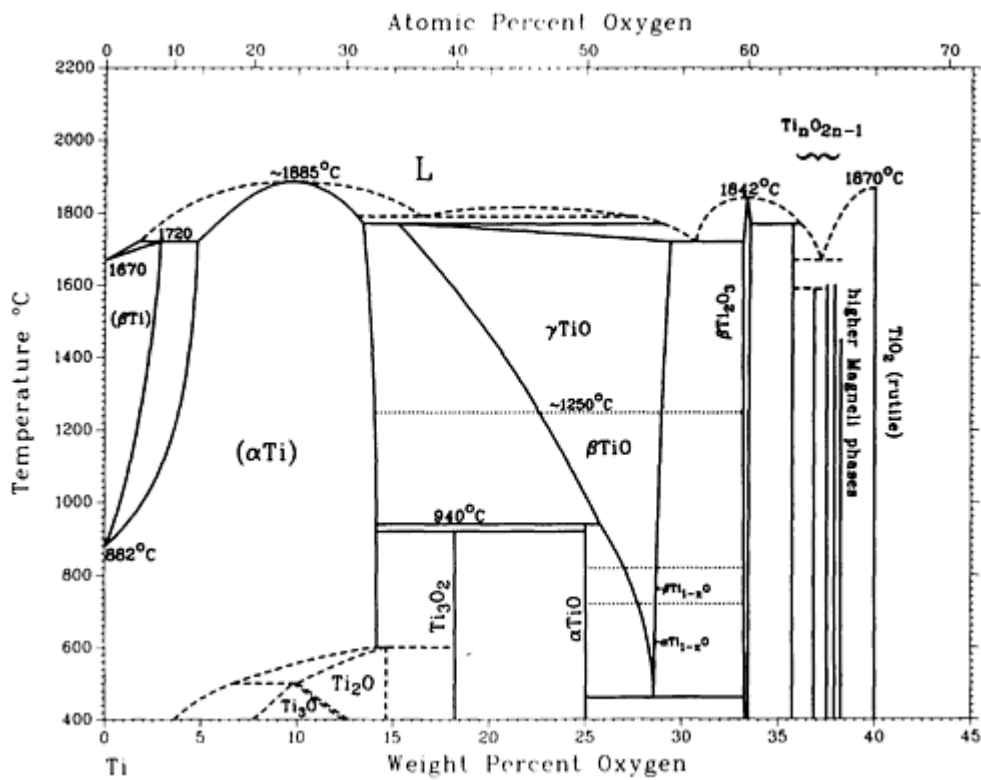

O-Ti phase diagram

O-Ti crystallographic data

Phase	Composition, wt% O	Pearson symbol	Space group
(βTi)	0 to 3	<i>cI2</i>	<i>Im</i> $\bar{3}m$
(αTi)	0 to 13.5	<i>hP2</i>	<i>P6</i> $\bar{3}/mmc$
Ti ₃ O	~8 to ~13	<i>hP</i> ~16	<i>P</i> $\bar{3}1c$
Ti ₂ O	~10 to 14.4	<i>hP3</i>	<i>P</i> $\bar{3}m1$
γTiO	15.2 to 29.4	<i>cF8</i>	<i>Fm</i> $\bar{3}m$
Ti ₃ O ₂	~18	<i>hP</i> ~5	<i>P6/mmm</i>
βTiO	~24 to ~29.4	<i>c</i> **	...
αTiO	~25.0	<i>mC16</i>	<i>A2/m</i> or <i>B</i> */*

β Ti _{1-x} O	~29.5	<i>oI12</i>	<i>I222</i>
α Ti _{1-x} O	~29.5	<i>tI18</i>	<i>I4/m</i>
β Ti ₂ O ₃	33.2 to 33.6	<i>hR30</i>	<i>R$\bar{3}c$</i>
α Ti ₂ O ₃	33.2 to 33.6	<i>hR30</i>	<i>R$\bar{3}c$</i>
β Ti ₃ O ₅	35.8	<i>m**</i>	...
α Ti ₃ O ₅	35.8	<i>mC32</i>	<i>C2/m</i>
α' Ti ₃ O ₅	35.8	<i>mC32</i>	<i>Cc</i>
γ Ti ₄ O ₇	36.9	<i>aP44</i>	<i>P$\bar{1}$</i>
β Ti ₄ O ₇	36.9	<i>aP44</i>	<i>P$\bar{1}$</i>
α Ti ₄ O ₇	36.9	<i>aP44</i>	<i>P$\bar{1}$</i>
γ Ti ₅ O ₉	37.6	<i>aP28</i>	<i>P$\bar{1}$</i>
β Ti ₆ O ₁₁	38.0	<i>aC68</i>	<i>A$\bar{1}$</i>
Ti ₇ O ₁₃	38.3	<i>aP40</i>	<i>P$\bar{1}$</i>
Ti ₈ O ₁₅	38.5	<i>aC92</i>	<i>A$\bar{1}$</i>
Ti ₉ O ₁₇	38.7	<i>aP52</i>	<i>P$\bar{1}$</i>
Rutile	40.1	<i>tP6</i>	<i>P4₂/mnm</i>
Metastable phases			
Anatase	...	<i>tI12</i>	<i>I4₁/amd</i>
Brookite	...	<i>oP24</i>	<i>Pbca</i>

High-pressure phases			
TiO ₂ -II	...	<i>oP12</i>	<i>Pbcn</i>
TiO ₂ -III	...	<i>hP~48</i>	...

O-V (Oxygen - Vanadium)

H.A. Wriedt, 1989

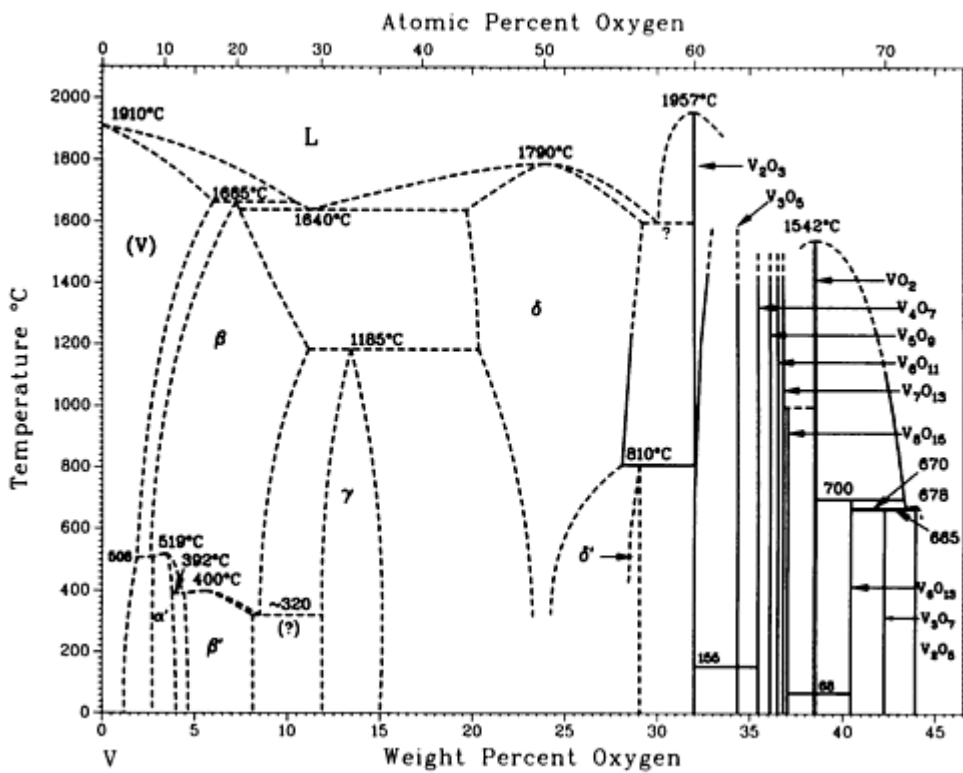

O-V phase diagram

O-V crystallographic data

Phase	Composition, wt% O	Pearson symbol	Space group
(V)	0 to 6	<i>cI2</i>	<i>Im$\bar{3}m$</i>
α'	2.7 to 4.0	<i>tI216^(a)</i>	...
β	2.6 to 11.1	<i>tI2.5^(b)</i>	<i>I4/mmm</i>

β .	4 to 8	$tI76^{(c)}$	$I4/mmm$
γ	12 to 15	$mC20^{(d)}$	$C2/m$
δ	19 to 29.4	$cF8$	$Fm\bar{3}m$
δ'	27 to 28.6	$tI116$	$I4_1/amd$
h-V ₂ O ₃ ^(e)	32.0 to 32.5	$hR10$	$R\bar{3}c$
l-V ₂ O ₃ ^(f)	32	$mI20$	$I2a$
h-V ₃ O ₅ ^(e)	~ 34.4	$mI32$	$I2/c$
l-V ₃ O ₅ ^(f)	34.4 to 34.38	$mP32$	$P2/c$
V ₄ O ₇	35.4	$aP22$	$P\bar{1}$
V ₅ O ₉	36.1	$aP28$	$P\bar{1}$
V ₆ O ₁₁	36.5	$aP34$	$P\bar{1}$
V ₇ O ₁₃	36.8	$aP40$	$P\bar{1}$
V ₈ O ₁₅	37.0	$aP46$	$P\bar{1}$
β VO ₂ ^(e)	38.5 to 38.8	$tP6$	$P4_2/mnm$
α VO ₂ ^(f)	38.6	$mP12$	$P2_1/c$
h-V ₆ O ₁₃ ^(e)	~ 40.5	$mC38$	$C2/m$
l-V ₆ O ₁₃ ^(f)	~ 40.5	$mP38$	$P2_1/a$
V ₃ O ₇	~ 42	$mC120$	$C2/c$
V ₂ O ₅	~ 43.9	$oP14$	$Pmnm$

Other phases			
Martensite-A	2.2 to 2.9	$tI^{*(g)}$...
Martensite-B	2.0 to 2.2	$tI^{*(g)}$...
ϵ	8 to 11	mP^*	$P2_1/c$
$VO_{1.17}$	~ 27	...	$I4_1/a$
V_9O_{17}	~ 37.3	$aP52$	$P1$
VO_2 -B	~ 38.6	$tI288(?)$...
VO_2 -M ₂	~ 38.6	$mC24$	$C2/m$
VO_2 -T ₂	~ 38.6	$tP6$	$P4_2/mnm$
VO_2 -M ₃	38.7 to 39.2	$mP6$	$P2/m$
VO_2 -M ₄ ^(h)	~ 38.6	$mC24$	$C2/m$
VO_2 -D	~ 38.6	$oP12$	$Pbnm$
V_6O_{13} -C	~ 40.5	$cP76(?)$...
V_6O_{13} -D	~ 40.5	$mC38$	$C2/m$
V_4O_9	~ 41.4	$oP52$	$Pnma$
V_4O_9 -E	~ 41.1	$oP104(?)$...
V_2O_5	~ 44.1

(a) At V_8O .

(b) At V_4O .

(c) At $V_{16}O_3$.

(d) At V_7O_3 .

(e) Above T_{trs} .

(f) Below transformation temperature, T_{trs} .

(g) 2 atoms V/unit cell.

(h) Also called $VO_2(B)$

O-W (Oxygen - Tungsten)

H.A. Wriedt, 1989

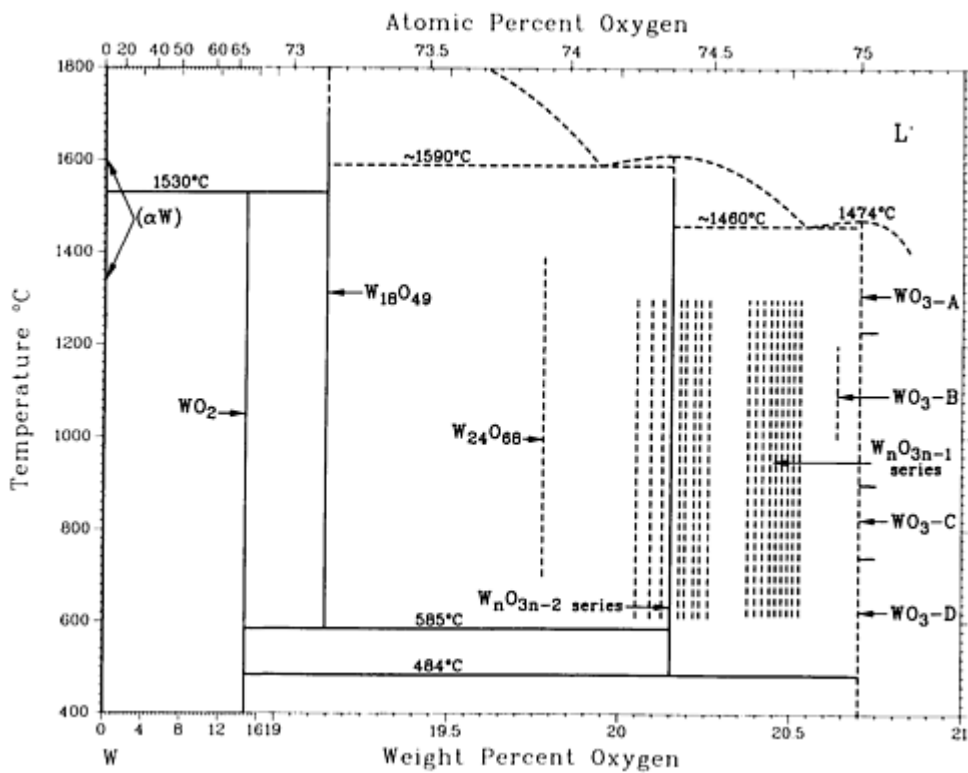

O-W (condensed system, 0.1 MPa) phase diagram

O-W crystallographic data

Phase	Composition, wt% O	Pearson symbol	Space group

(αW)	~ 0	$cI2$	$Im\bar{3}m$
WO_2	~ 14.8	$mP12$	$P2_1/c$
$W_{18}O_{49}$	~ 19.1	$mP67$	$P2/m$
$W_{24}O_{68}$	~ 19.8	m^*92	...
$W_{20}O_{58}^{(a)}$	20.2	$mP78$	$P2/m$
$W_{24}O_{70}^{(a)}$	20.3	$mP94$...
$W_{25}O_{73}^{(a)(b)}$	20.3	$mP98$	$P2/c$
$W_{25}O_{74}^{(c)}$	20.4	$mP99$	$P2/m$
WO_3 -M	~ 20.7
WO_3 -J	~ 20.7
WO_3 -K	~ 20.7
WO_3 -H	~ 20.7
WO_3 -G	~ 20.7	$mP16$	Pc
WO_3 -F	~ 20.7	$aP32$	$P\bar{1}$
WO_3 -E ^(d)	~ 20.7	$mP32$	$P2_1/n$
WO_3 -D ^(d)	~ 20.7	$oP32$	$Pmnb$
WO_3 -C ^(d)	~ 20.7	$tP8$	$P4/nmn$
WO_3 -B	~ 20.7	$tP8$	$P4/nmm$
WO_3 -A	~ 20.7	$tP8(?)$	$P4/nmm(?)$
Other			

(βW)	0 to ?	$cP8$	$Pm\bar{3}n$
$\text{W}_{40}\text{O}_{118}^{(a)}$	20.4	$mP158$	$P2$
$\text{WO}_3^{(e)}$	20.7	$hP24$	$P6/mmm(?)$
$\text{WO}_3^{(f)}$	20.7	$c*4$...

(a) Member $\text{W}_n\text{O}_{3n-2}$ series.

(b) Identified as $\text{WO}_{2.96}(\alpha)$.

(c) Probable member $\text{W}_n\text{O}_{3n-1}$ series, called $\text{WO}_{2.96}(\beta)$.

(d) Often described as a slightly distorted ReO_3 ($D0_9$).

(e) Hexagonal.

(f) Cubic.

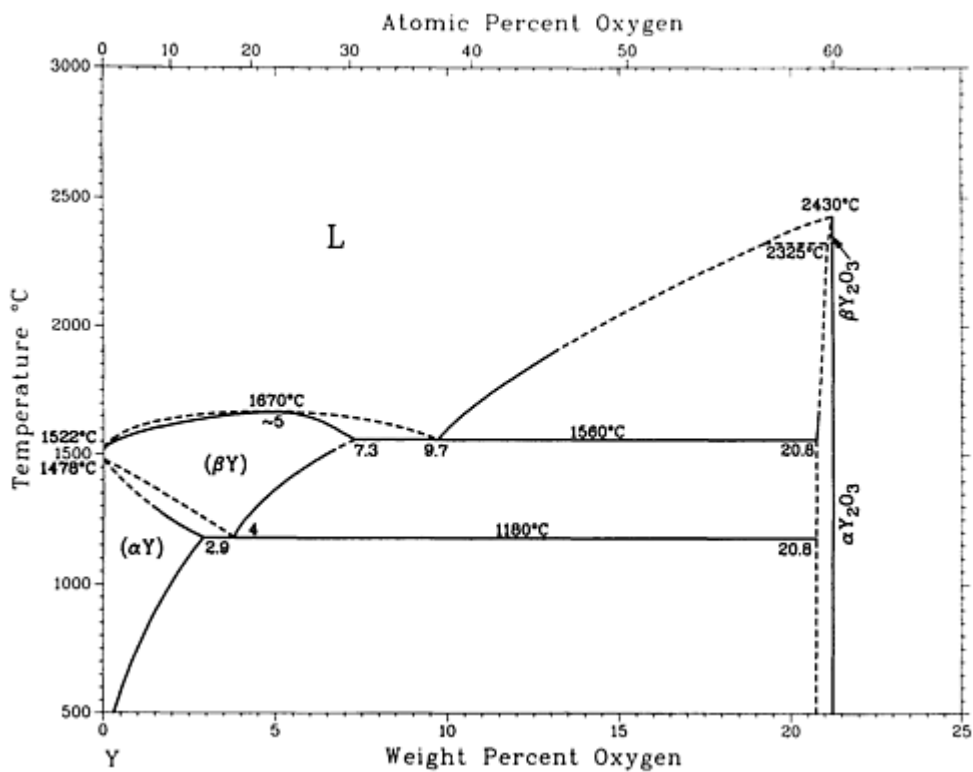

O-Y phase diagram

O-Y crystallographic data

Phase	Composition, wt% O	Pearson symbol	Space group
(βY)	0 to 7.3	<i>cI2</i>	<i>Im</i> $\bar{3}m$
(αY)	0 to 2.9	<i>hP2</i>	<i>P6</i> ₃ <i>/mmc</i>
αY ₂ O _{3-x}	20.8 to 21	<i>cI80</i>	<i>Ia</i> $\bar{3}$
βY ₂ O _{3-x}	~21	<i>hP(?)</i>	<i>P</i> $\bar{3}m1$
γY ₂ O ₃ ^(a)	~21	<i>mC(?)</i>	<i>C2/m</i>

(a) High-pressure phase

O-Zr (Oxygen - Zirconium)

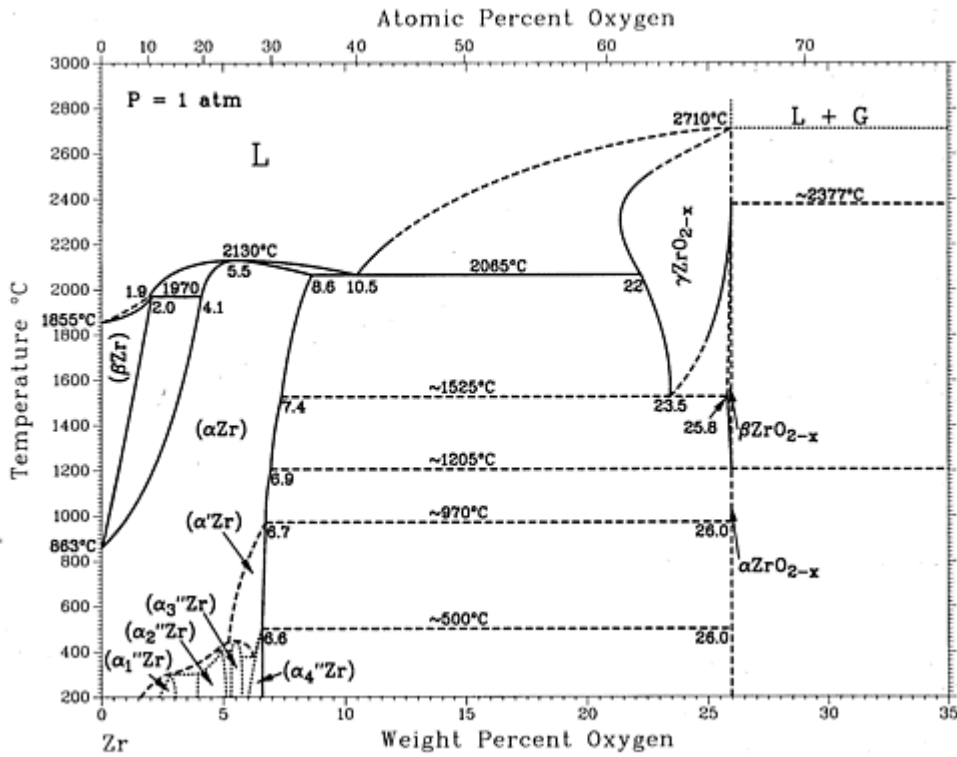

O-Zr phase diagram

O-Zr crystallographic data

Phase	Composition, wt% O	Pearson symbol	Space group
(α Zr)	0 to 8.6	<i>hP2</i>	<i>P6₃/mmc</i>
(β Zr)	0 to 2.0	<i>cI2</i>	<i>Im$\bar{3}m$</i>
γ ZrO _{2-x}	22 to 25.9	<i>cF12</i>	<i>Fm$\bar{3}m$</i>
β ZrO _{2-x}	25.8 to 25.9	<i>tP6</i>	<i>P4₂/nmc</i>
α ZrO _{2-x}	25.9	<i>mP12</i>	<i>P2₁/c</i>

Os (Osmium) Binary Alloy Phase Diagrams

Introduction

THIS ARTICLE includes systems where osmium is the first-named element in the binary pair. Additional binary systems that include osmium are provided in the following locations in this Volume:

- “Cr-Os (Chromium - Osmium)” in the article “Cr (Chromium) Binary Alloy Phase Diagrams.”
- “Hf-Os (Hafnium - Osmium)” in the article “Hf (Hafnium) Binary Phase Diagrams.”
- “Mo-Os (Molybdenum - Osmium)” in the article “Mo (Molybdenum) Binary Phase Diagrams.”
- “Nb-Os (Niobium - Osmium)” in the article “Nb (Niobium) Binary Phase Diagrams.”
- “Ni-Os (Nickel - Osmium)” in the article “Ni (Nickel) Binary Phase Diagrams.”

Os-Pt (Osmium - Platinum)

H. Okamoto, 1990

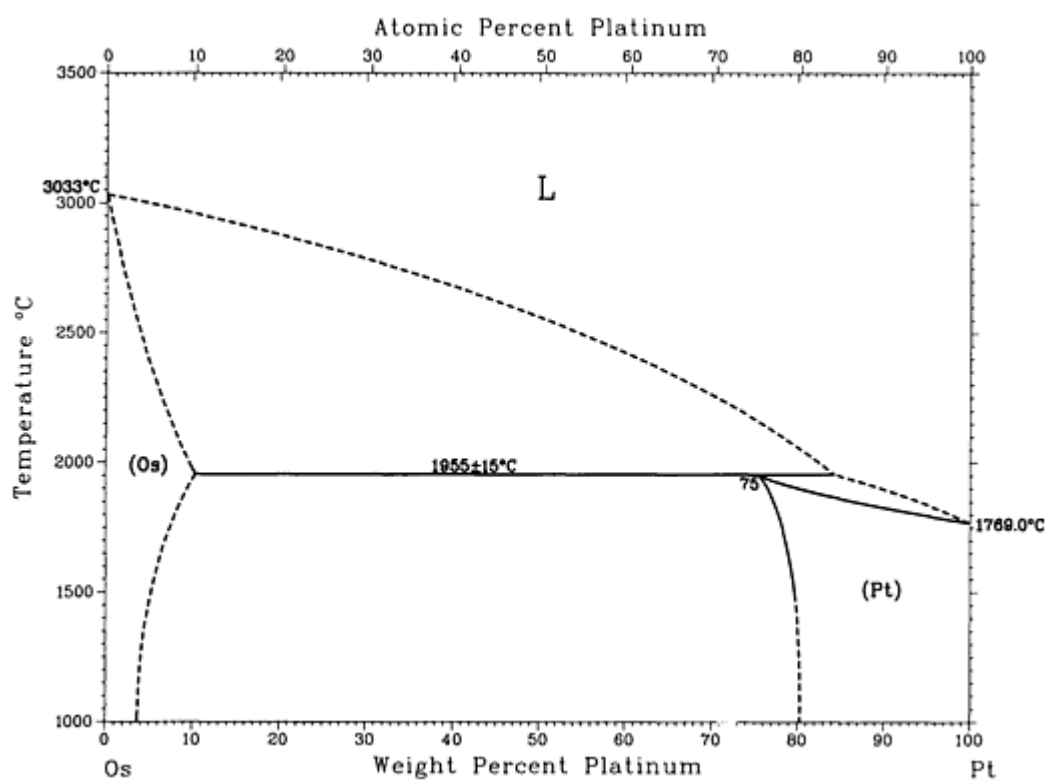

Os-Pt phase diagram

Os-Pt crystallographic data

Phase	Composition, wt% Pt	Pearson symbol	Space group
(Os)	0 to ~11	<i>hP2</i>	<i>P6₃/mmc</i>
(Pt)	75 to 100	<i>cF2</i>	<i>Fm$\bar{3}$m</i>

Os-Pu (Osmium - Plutonium)

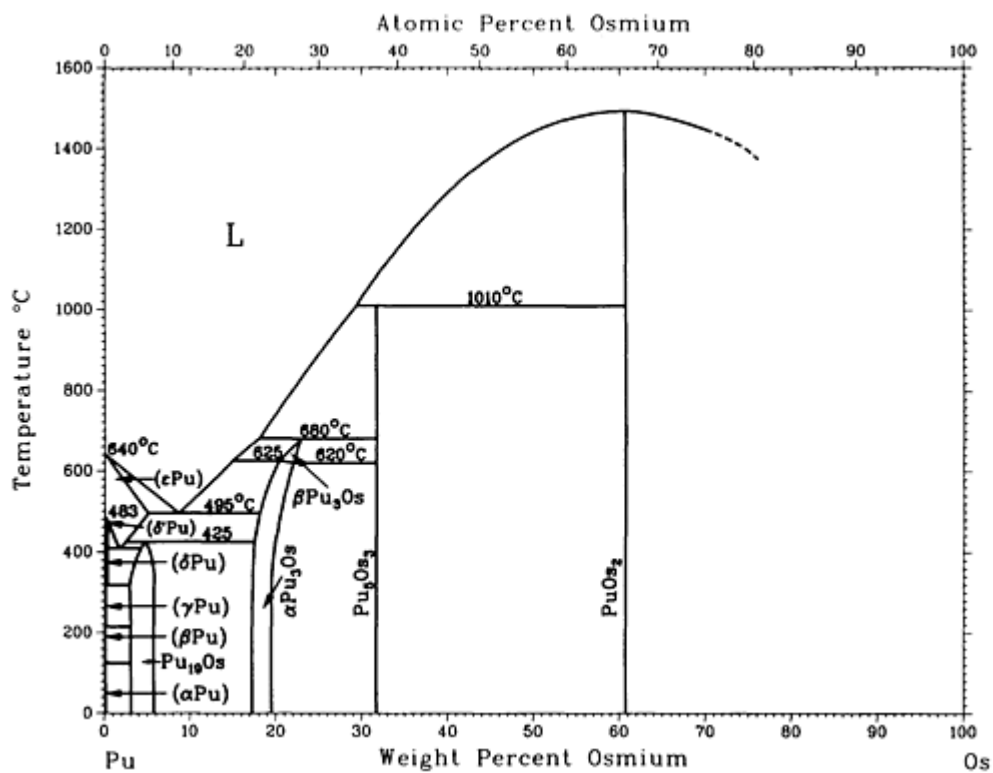

Os-Pu phase diagram

Os-Pu crystallographic data

Phase	Composition, wt% Os	Pearson symbol	Space group
(εPu)	0 to ~5	<i>cI2</i>	<i>Im</i> $\bar{3}m$
(δ'Pu)	0 to ~0.4	<i>tI2</i>	<i>I4/mmm</i>
(δPu)	0 to ~0.4	<i>cF4</i>	<i>Fm</i> $\bar{3}m$
(γPu)	~0	<i>oF8</i>	<i>Fddd</i>
(βPu)	~0	<i>mC34</i>	<i>C2/m</i>
(αPu)	~0	<i>mP16</i>	<i>P2₁/m</i>
β _{Pu₁₉OS}	3 to >6	<i>oP52</i>	<i>Pnna</i>

α Pu ₁₉ Os	3 to >6	<i>oC40</i>	<i>Cmca</i>
β Pu ₃ Os	~21 to <22
α Pu ₃ Os	~17 to >22
Pu ₅ Os ₃	~31.9	<i>tI32</i>	<i>I4/mcm</i>
PuOs ₂	61.0	<i>hP12</i>	<i>P6₃/mmc</i>
Other reported phase			
PuOs ₂	61.0	<i>cF24</i>	<i>Fd$\bar{3}m$</i>

Os-Re (Osmium - Rhenium)

M.A. Tylkina, V.P. Polyakova, and E.M. Savitskii, 1962

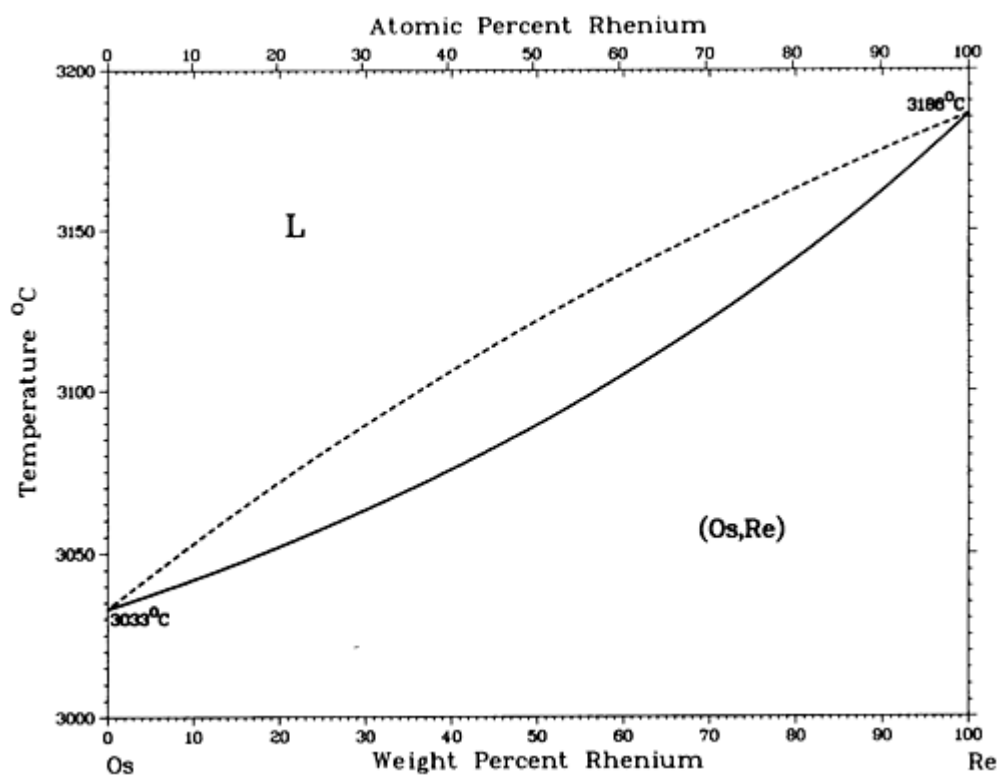

Os-Re phase diagram

Os-Re crystallographic data

Phase	Composition,	Pearson	Space
-------	--------------	---------	-------

	wt% Re	symbol	group
(Os,Re)	0 to 100	<i>hP2</i>	<i>P6₃/mmc</i>

Os-Rh (Osmium - Rhodium)

H. Okamoto, 1990

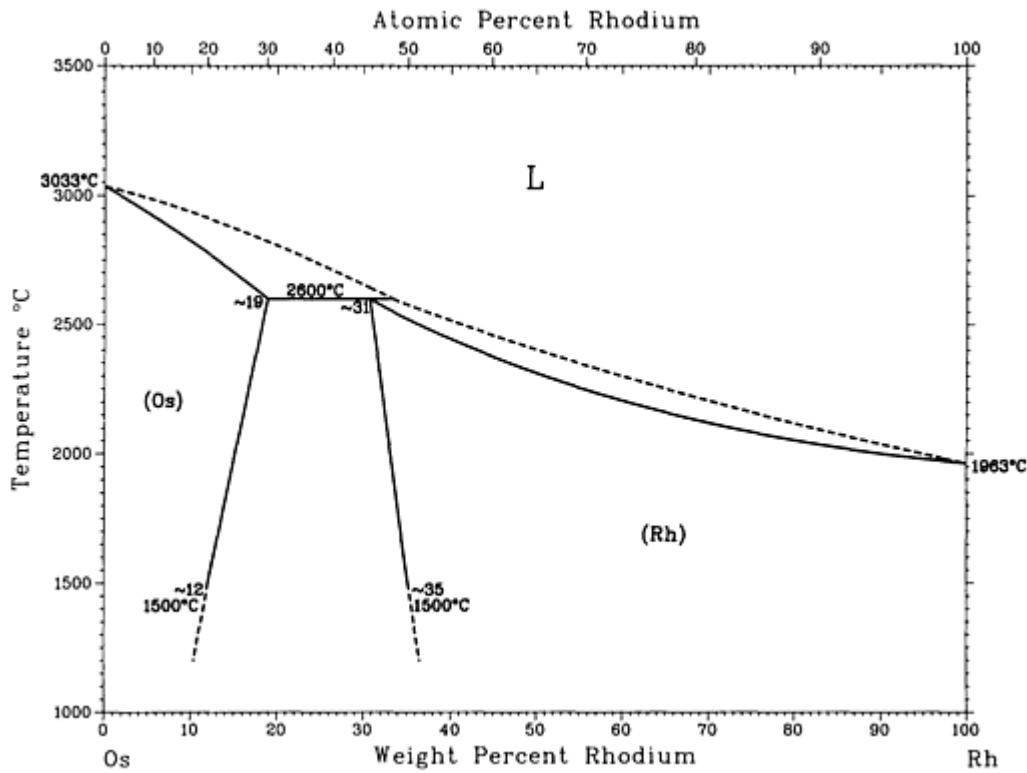

Os-Rh phase diagram

Os-Rh crystallographic data

Phase	Composition, wt% Rh	Pearson symbol	Space group
(Os)	0 to ~19	<i>hP2</i>	<i>P6₃/mmc</i>
(Rh)	~31 to 100	<i>cF2</i>	<i>Fm$\bar{3}$m</i>

Os-Ru (Osmium - Ruthenium)

M.A. Tylkina, V.P. Polyakova, and E.M. Savitskii, 1962

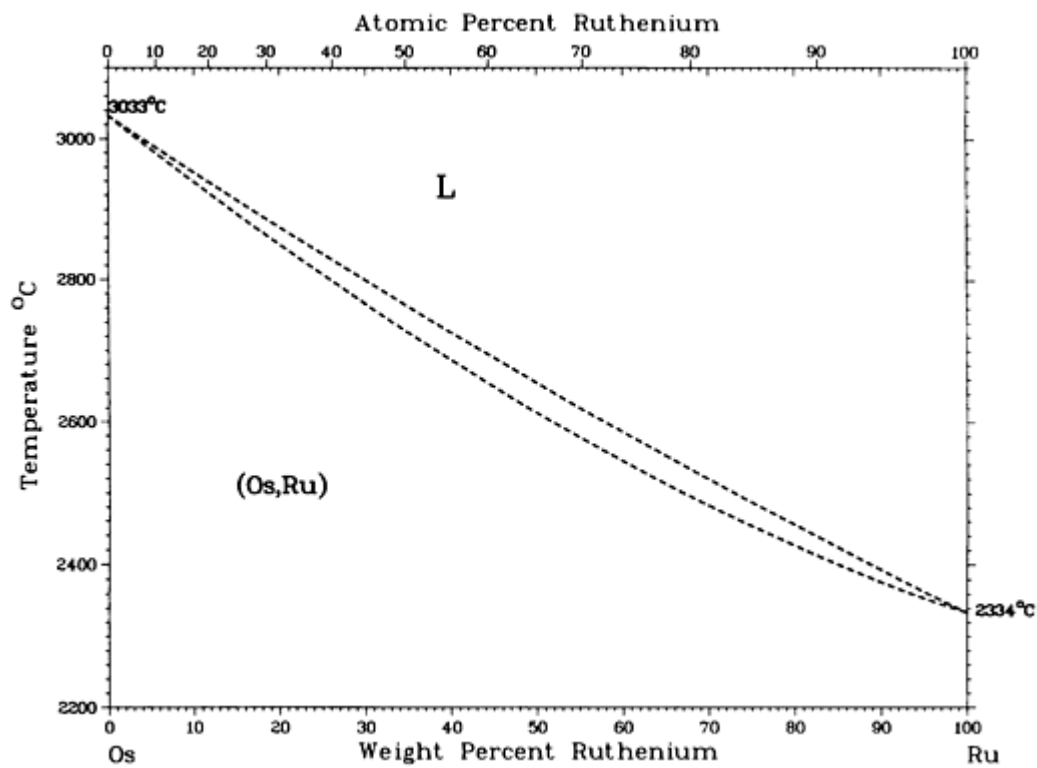

Os-Ru phase diagram

Os-Ru crystallographic data

Phase	Composition, wt% Ru	Pearson symbol	Space group
(Os, Ru)	0 to 100	<i>hP2</i>	<i>P6₃/mmc</i>

Os-Si (Osmium - Silicon)

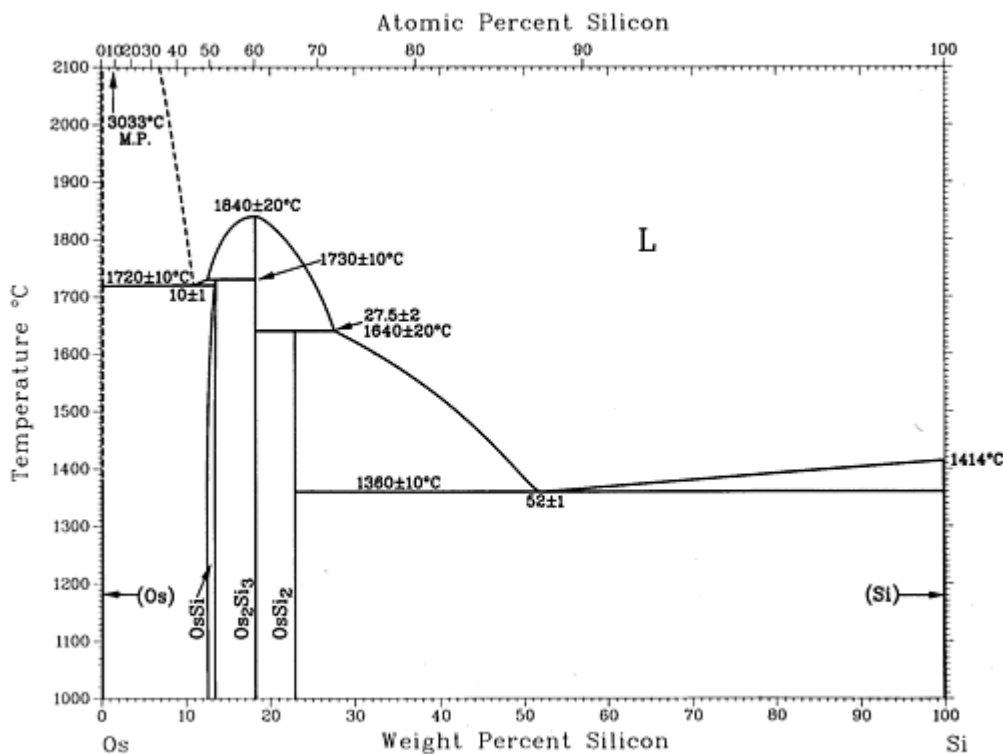

Os-Si phase diagram

Os-Si crystallographic data

Phase	Composition, wt% Si	Pearson symbol	Space group
(Os)	0	<i>hP2</i>	<i>P6₃/mmc</i>
OsSi	12.9	<i>cP8</i>	<i>P2₁3</i>
Os ₂ Si ₃	18	<i>oP40</i>	<i>Pbcn</i>
OsSi ₂	22.8	<i>oC48</i>	<i>Cmca</i>
(Si)	100	<i>cF8</i>	<i>Fd$\bar{3}m$</i>
Metastable phase			
OsSi ₂ ·m	22.8	<i>mC12</i>	<i>C2/m</i>

Os-Ti (Osmium - Titanium)

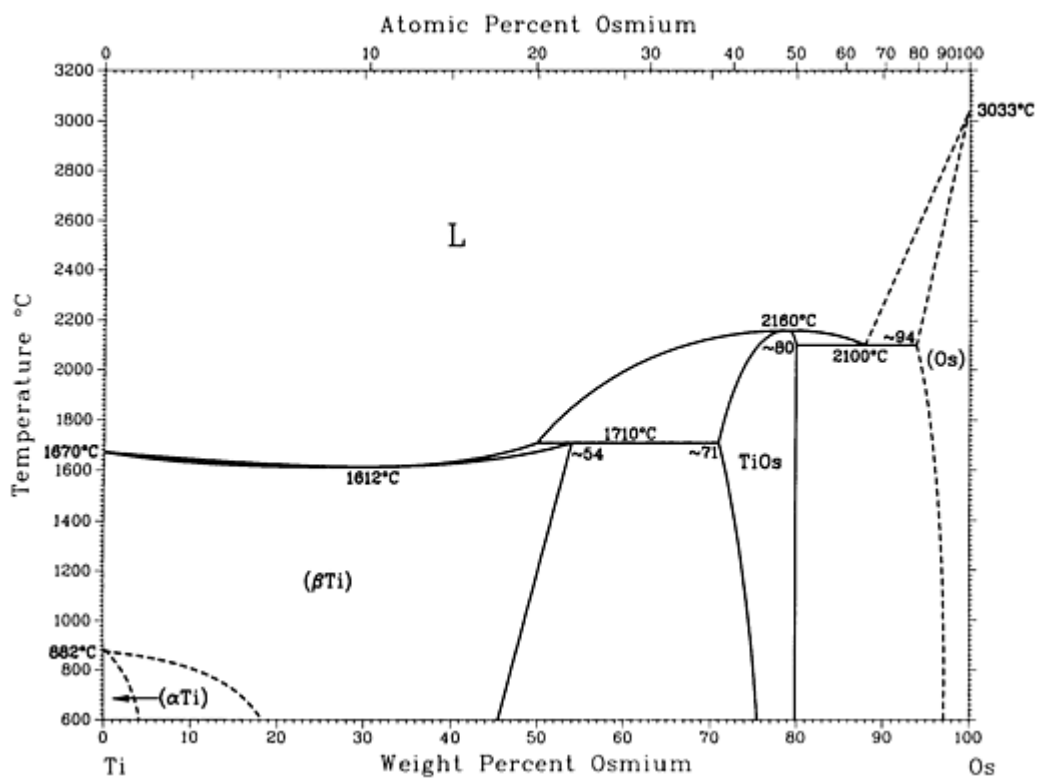

Os-Ti phase diagram

Os-Ti crystallographic data

Phase	Composition, wt% Os	Pearson symbol	Space group
(βTi)	0 to 54	<i>cI2</i>	<i>Im</i> $\bar{3}m$
(αTi)	0 to 4	<i>hP2</i>	<i>P6₃/mmc</i>
TiOs	~71 to ~80	<i>cP2</i>	<i>Pm</i> $\bar{3}m$
(Os)	~94 to 100	<i>hP2</i>	<i>P6₃/mmc</i>

Os-U (Osmium - Uranium)

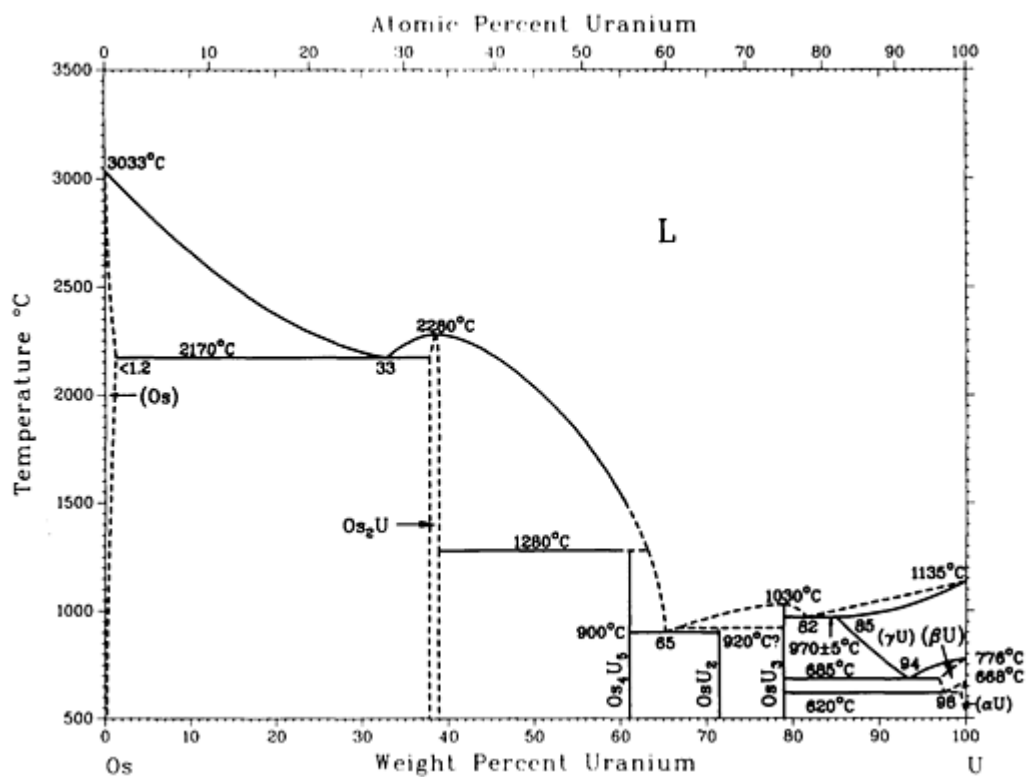

Os-U phase diagram

Os-U crystallographic data

Phase	Composition, wt% U	Pearson symbol	Space group
(Os)	0 to <math><1.2</math>	$hP2$	$P6_3/mmc$
Os_2U	~ 37.6 to 39	$cF24$	$Fd\bar{3}m$
Os_4U_5	~ 61.0
OsU_2	~ 71.5	m^*12	...
OsU_3	79
(γU)	85 to 100	$cI2$	$Im\bar{3}/m$
(βU)	>97 to 100	$tP30$	$P4_2/mnm$
(αU)	>99 to 100	$oC4$	$Cmcm$

17. [Shunk]: F.A. Shunk, *Constitution of Binary Alloys, Second Supplement*, McGraw-Hill, New York or General Electric Co., Business Growth Services, Schenectady, New York (1969).

Os-V (Osmium - Vanadium)

J.F. Smith, 1989

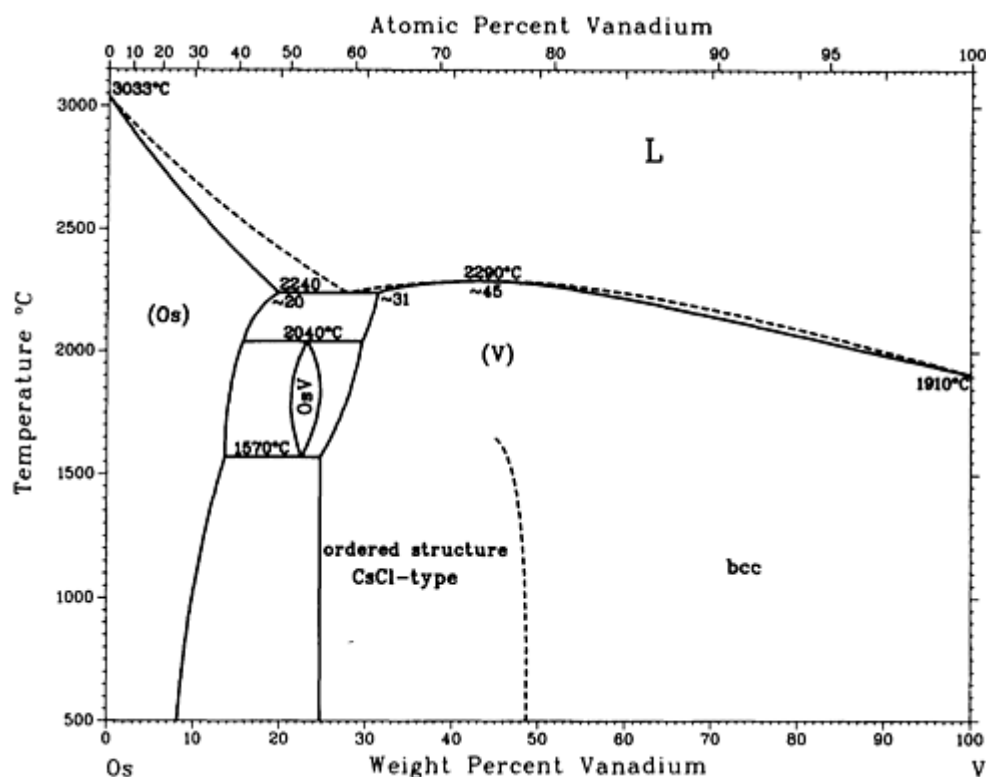

Os-V phase diagram

Os-V crystallographic data

Phase	Composition, wt% V	Pearson symbol	Space group
(Os)	0 to ~20	<i>hP2</i>	<i>P6₃/mmc</i>
OsV	~21.1 to 25	<i>cP8</i>	<i>Pm$\bar{3}$n</i>
(V)	25 to ? ? to 100	<i>cP2</i> <i>cI2</i>	<i>Pm$\bar{3}$m</i> <i>Im$\bar{3}$/m</i>

Os-W (Osmium - Tungsten)

S.V. Nagender Naidu and P. Rama Rao, 1991

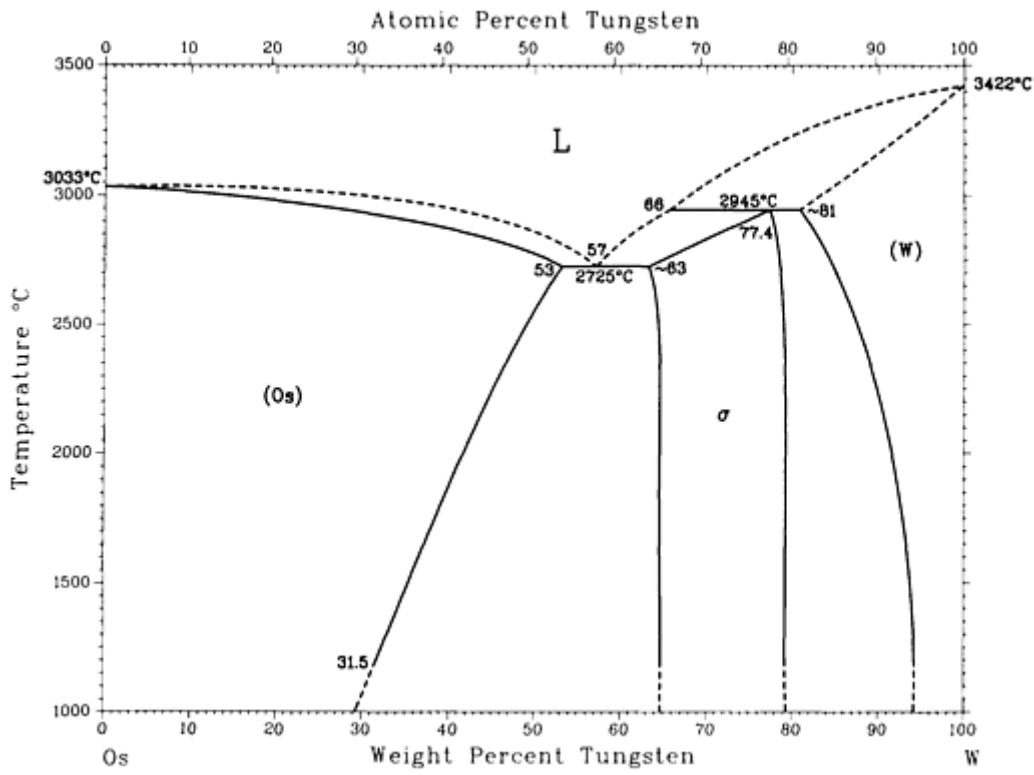

Os-W phase diagram

Os-W crystallographic data

Phase	Composition, wt% W	Pearson symbol	Space group
(Os)	0 to 53	<i>hP2</i>	<i>P6₃/mmc</i>
σ	~63 to ~80	<i>tP30</i>	<i>P4₂/mnm</i>
(W)	~81 to 100	<i>cI2</i>	<i>Im$\bar{3}m$</i>

Os-Zr (Osmium - Zirconium)

H. Okamoto, 1990

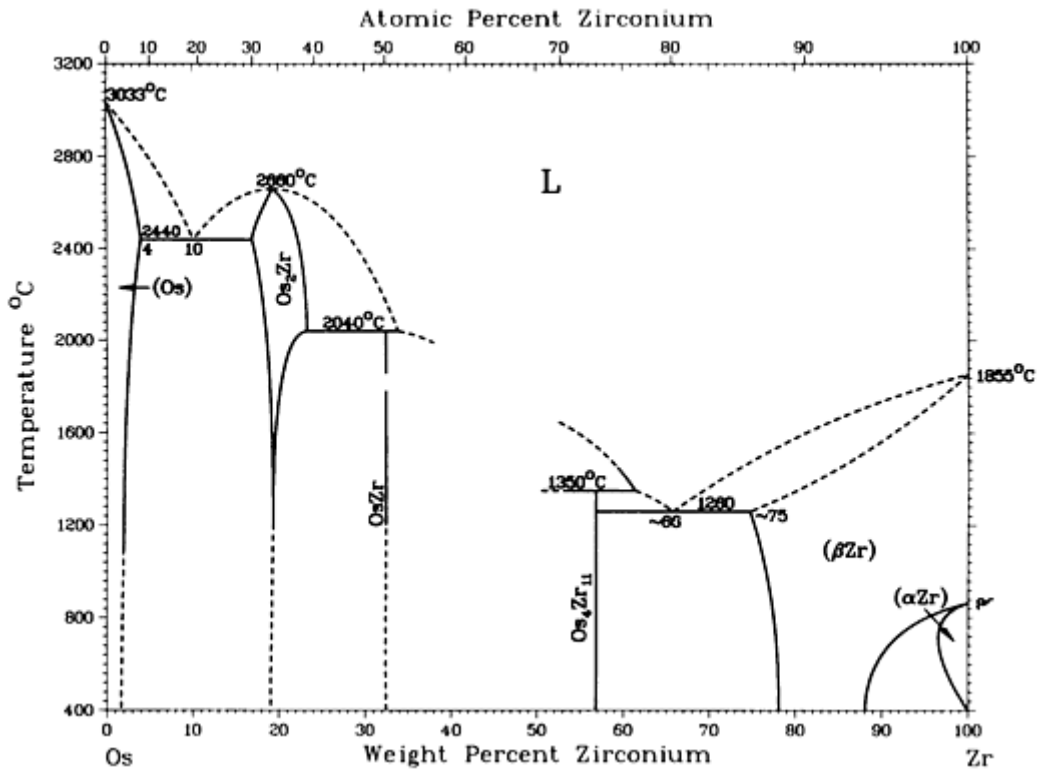

Os-Zr phase diagram

Os-Zr crystallographic data

Phase	Composition, wt% Zr	Pearson symbol	Space group
(Os)	0 to 4	<i>hP2</i>	<i>P6₃/mmc</i>
Os ₂ Zr	~17 to <24	<i>hP12</i>	<i>P6₃/mmc</i>
OsZr	32.4	<i>cP2</i>	<i>Pm$\bar{3}$m</i>
Os ₄ Zr ₁₁	~56.8	<i>cF120</i>	<i>Fm$\bar{3}$m</i>
(βZr)	~75 to 100	<i>cI2</i>	<i>Im$\bar{3}$m</i>
(αZr)	98 to 100	<i>hP2</i>	<i>P6₃/mmc</i>

Introduction

THIS ARTICLE includes systems where phosphorus is the first-named element in the binary pair. Additional binary systems that include phosphorus are provided in the following locations in this Volume:

- “Ag-P (Silver - Phosphorus)” in the article “Ag (Silver) Binary Alloy Phase Diagrams.”
- “As-P (Arsenic - Phosphorus)” in the article “As (Arsenic) Binary Alloy Phase Diagrams.”
- “Ba-P (Barium - Phosphorus)” in the article “Ba (Barium) Binary Alloy Phase Diagrams.”
- “Cd-P (Cadmium - Phosphorus)” in the article “Cd (Cadmium) Binary Alloy Phase Diagrams.”
- “Co-P (Cobalt - Phosphorus)” in the article “Co (Cobalt) Binary Alloy Phase Diagrams.”
- “Cu-P (Copper - Phosphorus)” in the article “Cu (Copper) Binary Alloy Phase Diagrams.”
- “Fe-P (Iron - Phosphorus)” in the article “Fe (Iron) Binary Alloy Phase Diagrams.”
- “Ge-P (Germanium - Phosphorus)” in the article “Ge (Germanium) Binary Alloy Phase Diagrams.”
- “In-P (Indium - Phosphorus)” in the article “In (Indium) Binary Alloy Phase Diagrams.”
- “Mn-P (Manganese - Phosphorus)” in the article “Mn (Manganese) Binary Alloy Phase Diagrams.”
- “Mo-P (Molybdenum - Phosphorus)” in the article “Mo (Molybdenum) Binary Alloy Phase Diagrams.”
- “Ni-P (Nickel - Phosphorus)” in the article “Ni (Nickel) Binary Alloy Phase Diagrams.”

P-Pd (Phosphorus - Palladium)

H. Okamoto, unpublished

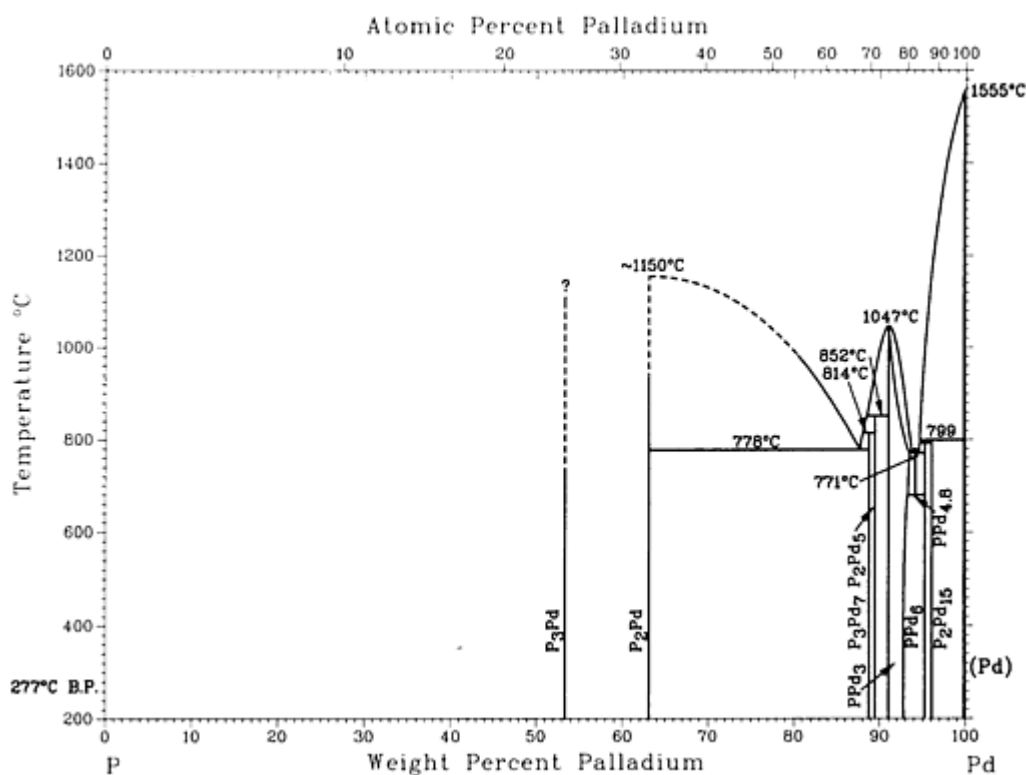

P-Pd phase diagram

P-Pd crystallographic data

Phase	Composition, wt% Pd	Pearson symbol	Space group
P (white)	0	<i>c</i> **	...

P_3Pd	53	$cI32$	$Im\bar{3}$
P_2Pd	63.2	$mC12$	$C2/c$
P_3Pd_7	88.9	$hR20$	$R\bar{3}$
P_2Pd_5	89.6
PPd_3	91 to 93.5	$oP16$	$Pnma$
$PPd_{4,8}$	94.3	$mP24$	$P2_1$
PPd_6	95.4	$mP28$	$P2_1/c$
P_2Pd_{15}	96.3	$hR17$	$R\bar{3}$
(Pd)	100	$cF4$	$Fm\bar{3}m$

P-Pr (Phosphorus - Praseodymium)

From [Moffatt] 11

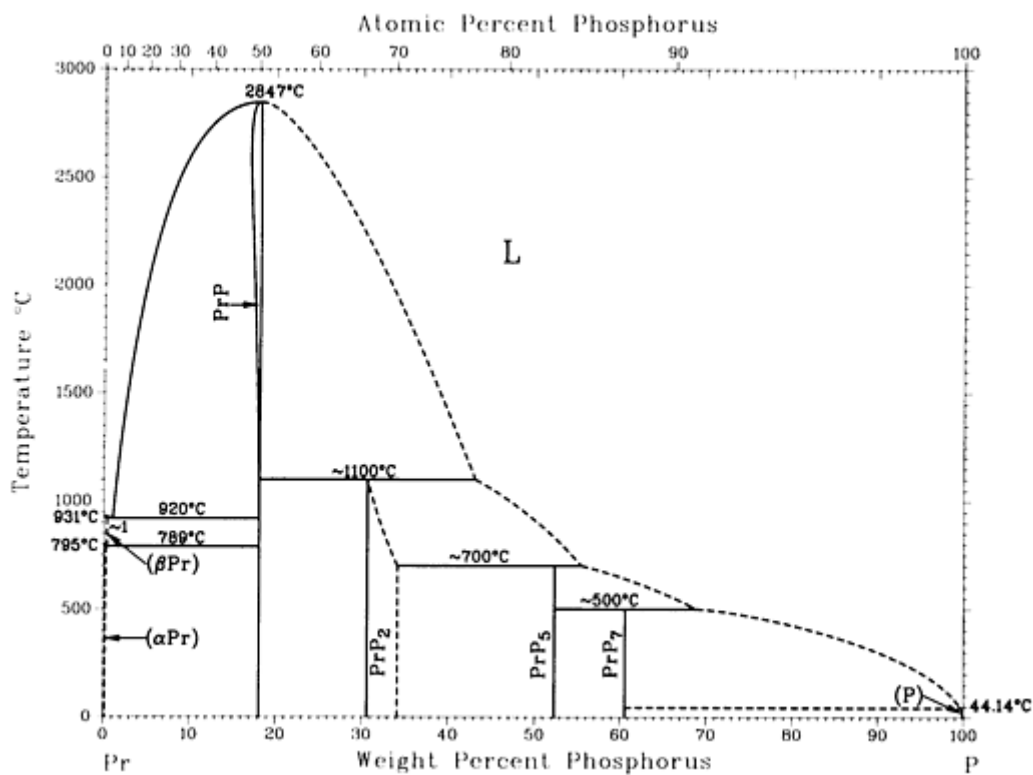

P-Pr phase diagram

P-Pr crystallographic data

Phase	Composition, wt% P	Pearson symbol	Space group
(β _{Pr})	0 to 0.2	<i>cI2</i>	<i>Im</i> $\bar{3}$ / <i>m</i>
(α _{Pr})	0 to ~0.07	<i>hP4</i>	<i>P6</i> ₃ / <i>mmc</i>
PrP	~17 to 18.0	<i>cF8</i>	<i>Fm</i> $\bar{3}$ / <i>m</i>
PrP ₂	30.6 to ?	<i>mP12</i>	<i>P2</i> ₁ / <i>c</i>
PrP ₅	52.3	<i>mP12</i>	<i>P2</i> ₁ / <i>m</i>
PrP ₇	60.6
(α _P)	100	<i>c</i> **	...

Reference cited in this section

11. [Moffatt]: W.G. Moffatt, Ed., *Handbook of Binary Phase Diagrams*, Business Growth Services, General

P-Ru (Phosphorus - Ruthenium)

H. Okamoto, 1990

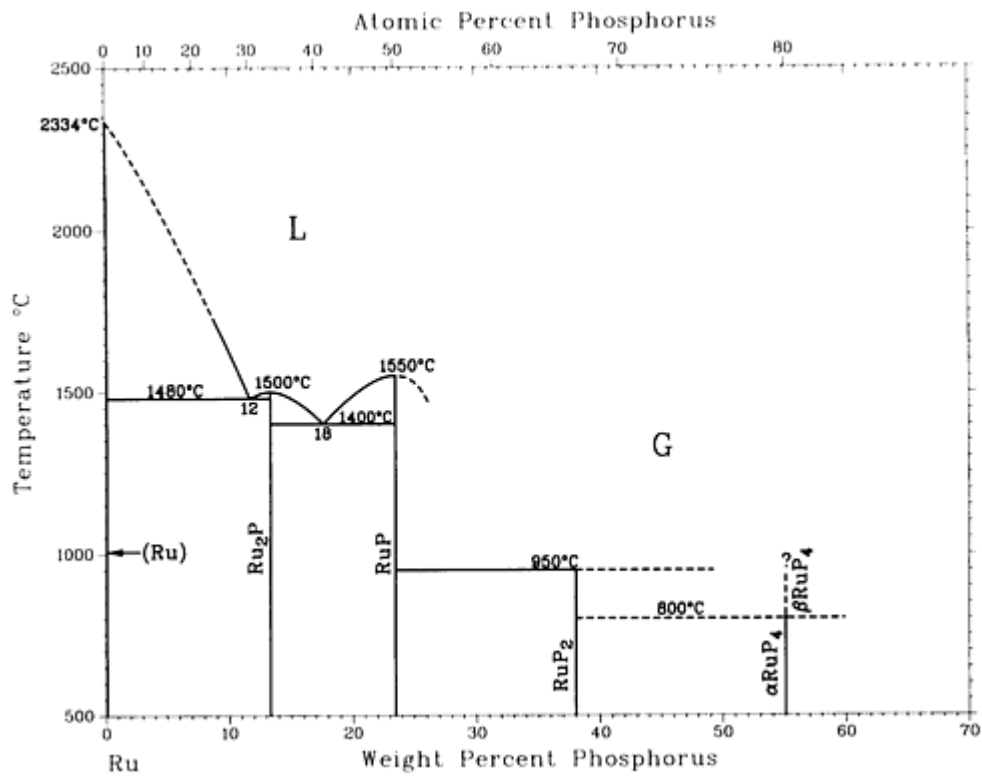

P-Ru phase diagram

P-Ru crystallographic data

Phase	Composition, wt% P	Pearson symbol	Space group
(Ru)	0	$hP2$	$P6_3/mmc$
Ru_2P	13.3	$oP12$	$Pnma$
RuP	23.5	$oP8$	$Pnma$
RuP_2	38.0	$oP6$	$Pnmm$
βRuP_4	55	$aP15$	$P\bar{1}$
αRuP_4	55	$mP10$	$P2_1/c$

P-Sn (Phosphorus - Tin)

A.C. Vivian, 1920

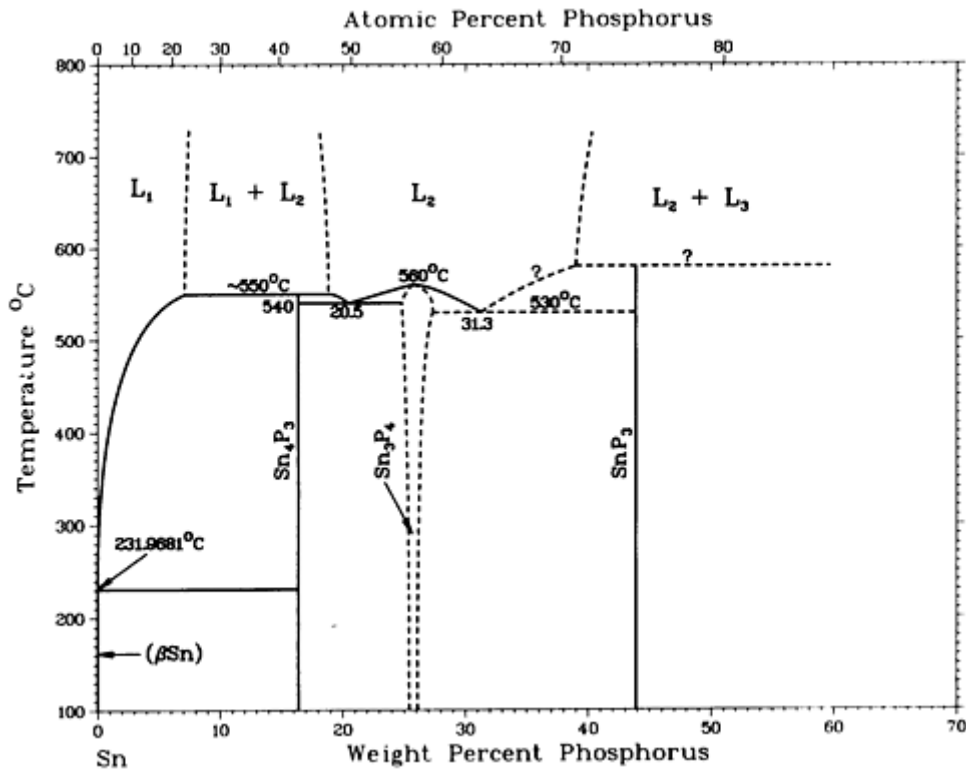

P-Sn phase diagram

P-Sn crystallographic data

Phase	Composition, wt% P	Pearson symbol	Space group
(βSn)	0	<i>I</i> 4	$I4_1/amd$
(αSn)	0	<i>cF</i> 8	$Fd\bar{3}m$
Sn_4P_3	16.4	<i>hR</i> 7	$R\bar{3}m$
Sn_3P_4	~25.8	<i>hR</i> 7	$R\bar{3}m$
SnP_3	44	<i>hR</i> 8	$R\bar{3}m$
Metastable/high-pressure phases			
SnP	20.7 20.7	<i>cF</i> 8 <i>hP</i> 16	$Fm\bar{3}m$ $P321$

	20.7	<i>tI4</i>	<i>I4mm</i>
Sn_7P_{10}	27.1	<i>h**</i>	...

P-Ti (Phosphorus - Titanium)

J.L. Murray, 1987

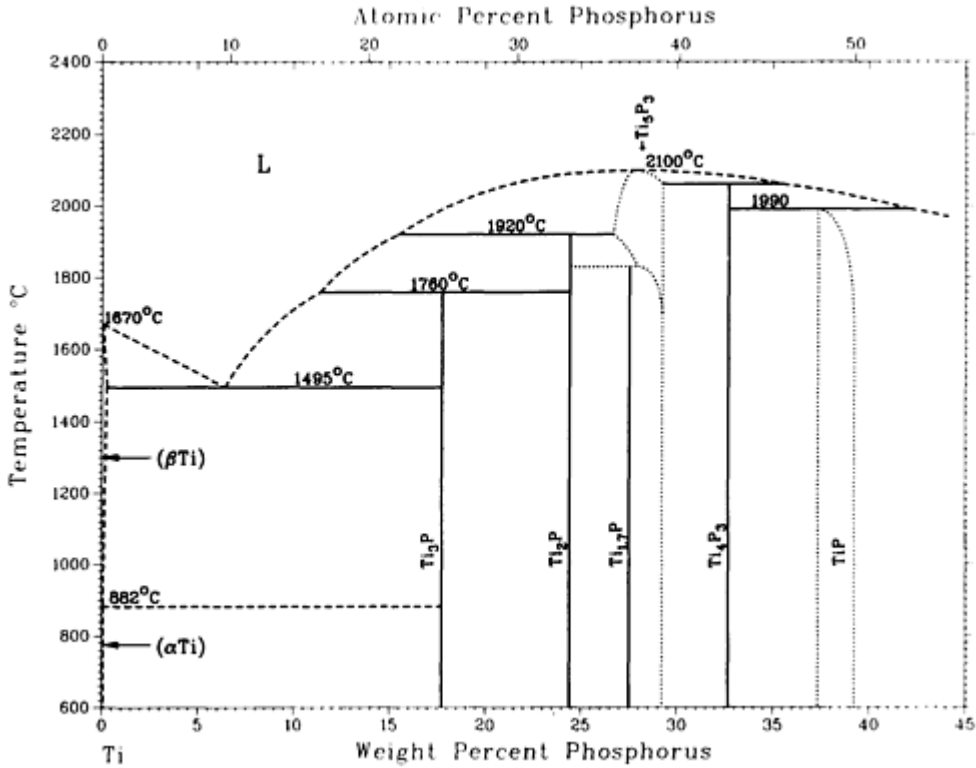

P-Ti phase diagram

P-Ti crystallographic data

Phase	Composition, wt% P	Pearson symbol	Space group
(βTi)	0 to 0.2	<i>cI2</i>	<i>Im</i> $\bar{3}m$
(αTi)	0 to ?	<i>hP2</i>	<i>P6</i> ₃ / <i>mmc</i>
Ti ₃ P	18	<i>tP32</i>	<i>P4</i> ₂ / <i>n</i>
Ti ₂ P	24.4	<i>h**</i> (a)
Ti ₅ P ₃	~27 to ~29	<i>hP16</i>	<i>P6</i> ₃ / <i>mcm</i>

Ti _{1.7} P	27.5	<i>oP*</i>	<i>P2₁2₁2₁</i>
Ti ₄ P ₃	32.7	<i>c**</i>	...
Ti ₃ P ₂ ^(b)	28	<i>t**</i>	...
TiP	37 to 39.3	<i>hP8</i>	<i>P6₃/mmc</i>
TiP ₂	56.4	<i>tI12</i>	<i>I4/mcm</i>

(a) Trigonal.

(b) Not shown in diagram

P-Zn (Phosphorus - Zinc)

J. Dutkiewicz, 1991

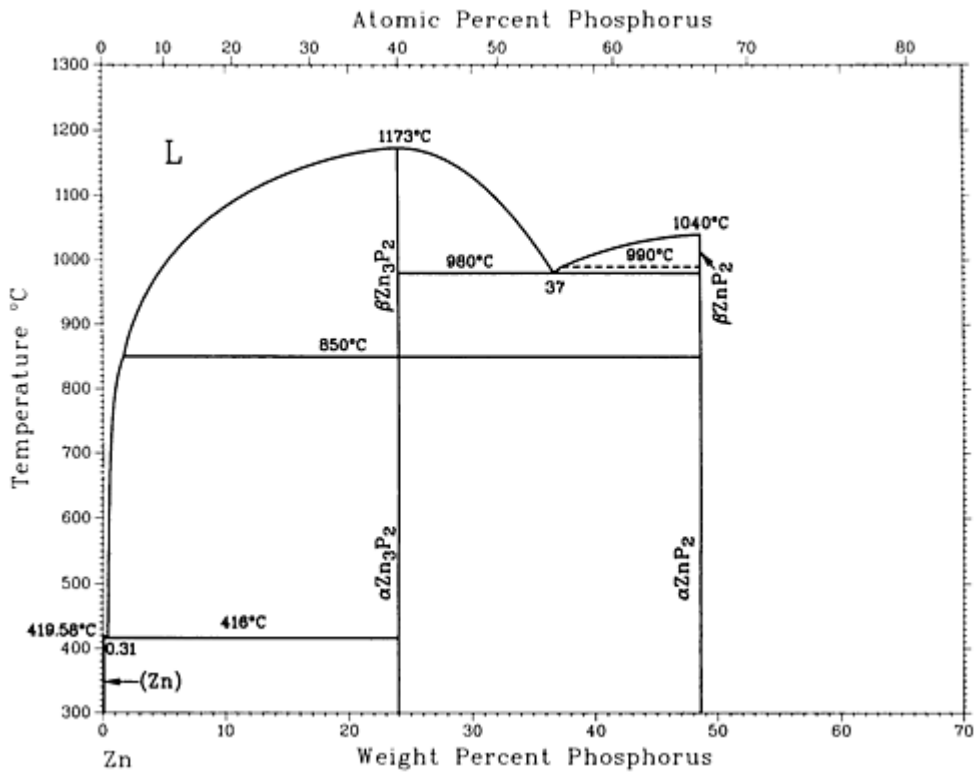

P-Zn phase diagram

P-Zn crystallographic data

Phase	Composition,	Pearson	Space
-------	--------------	---------	-------

	wt% P	symbol	group
(Zn)	0	<i>hP2</i>	<i>P6₃/mmc</i>
$\beta_{\text{Zn}_3\text{P}_2}$	24	<i>c**</i>	...
$\alpha_{\text{Zn}_3\text{P}_2}$	24	<i>tP40</i>	<i>P4₂/nmc</i>
β_{ZnP_2}	48.7	<i>mP24</i>	<i>P2₁/c</i>
α_{ZnP_2}	48.7	<i>tP24</i>	<i>P4₁2₁2</i>

Introduction

THIS ARTICLE includes systems where lead is the first-named element in the binary pair. Additional binary systems that include lead are provided in the following locations in this Volume:

- “Ag-Pb (Silver - Lead)” in the article “Ag (Silver) Binary Alloy Phase Diagrams.”
- “Al-Pb (Aluminum - Lead)” in the article “Al (Aluminum) Binary Alloy Phase Diagrams.”
- “As-Pb (Arsenic - Lead)” in the article “As (Arsenic) Binary Alloy Phase Diagrams.”
- “Au-Pb (Gold - Lead)” in the article “Au (Gold) Binary Alloy Phase Diagrams.”
- “Ba-Pb (Barium - Lead)” in the article “Ba (Barium) Binary Alloy Phase Diagrams.”
- “Bi-Pb (Bismuth - Lead)” in the article “Bi (Bismuth) Binary Alloy Phase Diagrams.”
- “Ca-Pb (Calcium - Lead)” in the article “Ca (Calcium) Binary Alloy Phase Diagrams.”
- “Cd-Pb (Cadmium - Lead)” in the article “Cd (Cadmium) Binary Alloy Phase Diagrams.”
- “Cu-Pb (Copper - Lead)” in the article “Cu (Copper) Binary Alloy Phase Diagrams.”
- “Dy-Pb (Dysprosium - Lead)” in the article “Dy (Dysprosium) Binary Alloy Phase Diagrams.”
- “Eu-Pb (Europium - Lead)” in the article “Eu (Europium) Binary Alloy Phase Diagrams.”
- “Ga-Pb (Gallium - Lead)” in the article “Ga (Gallium) Binary Alloy Phase Diagrams.”
- “Gd-Pb (Gadolinium - Lead)” in the article “Gd (Gadolinium) Binary Alloy Phase Diagrams.”
- “Ge-Pb (Germanium - Lead)” in the article “Ge (Germanium) Binary Alloy Phase Diagrams.”
- “Hg-Pb (Mercury - Lead)” in the article “Hg (Mercury) Binary Alloy Phase Diagrams.”
- “In-Pb (Indium - Lead)” in the article “In (Indium) Binary Alloy Phase Diagrams.”
- “K-Pb (Potassium - Lead)” in the article “K (Potassium) Binary Alloy Phase Diagrams.”
- “La-Pb (Lanthanum - Lead)” in the article “La (Lanthanum) Binary Alloy Phase Diagrams.”
- “Li-Pb (Lithium - Lead)” in the article “Li (Lithium) Binary Alloy Phase Diagrams.”
- “Lu-Pb (Lutetium - Lead)” in the article “Lu (Lutetium) Binary Alloy Phase Diagrams.”
- “Mg-Pb (Magnesium - Lead)” in the article “Mg (Magnesium) Binary Alloy Phase Diagrams.”
- “Na-Pb (Sodium - Lead)” in the article “Na (Sodium) Binary Alloy Phase Diagrams.”
- “Ni-Pb (Nickel - Lead)” in the article “Ni (Nickel) Binary Alloy Phase Diagrams.”

Pb-Pd (Lead - Palladium)

H. Okamoto, 1990

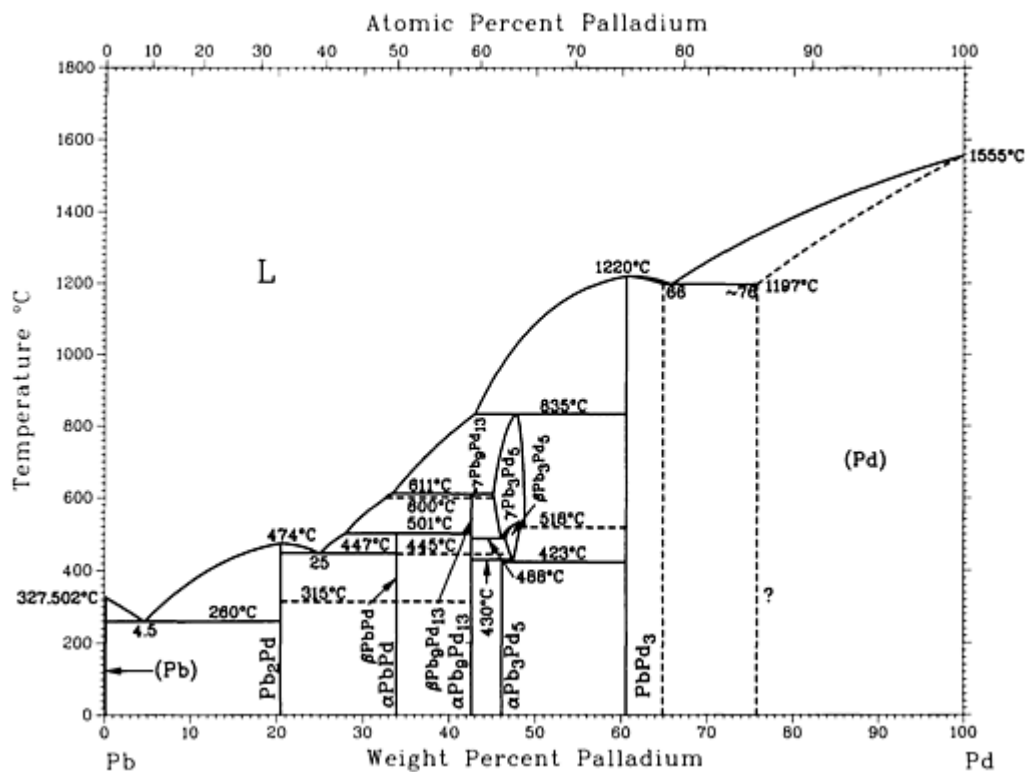

Pb-Pd phase diagram

Pb-Pd crystallographic data

Phase	Composition, wt% Pd	Pearson symbol	Space group
(Pb)	0	$cF4$	$Fm\bar{3}m$
Pb_2Pd	20.4	$tI12$	$I4/mcm$
$PbPd$	33.9	$aP32$	$P\bar{1}$
γ - Pb_9Pd_{13}	42.6
β - Pb_9Pd_{13}	42.6	$hP5$...
α - Pb_9Pd_{13}	42.6	$mC88$	$C2/c$
γ - Pb_3Pd_5	45 to 48

β Pb ₃ Pd ₅	46 to 47	<i>hP4</i>	<i>P6₃/mmc</i>
α Pb ₃ Pd ₅	46.1	<i>mC32</i>	<i>C2</i>
PbPd ₃	61 to 66	<i>cP4</i>	<i>Pm$\bar{3}m$</i>
(Pd)	~76 to 100	<i>cF4</i>	<i>Fm$\bar{3}m$</i>

Pb-Pr (Lead - Praseodymium)

H. Okamoto, 1990

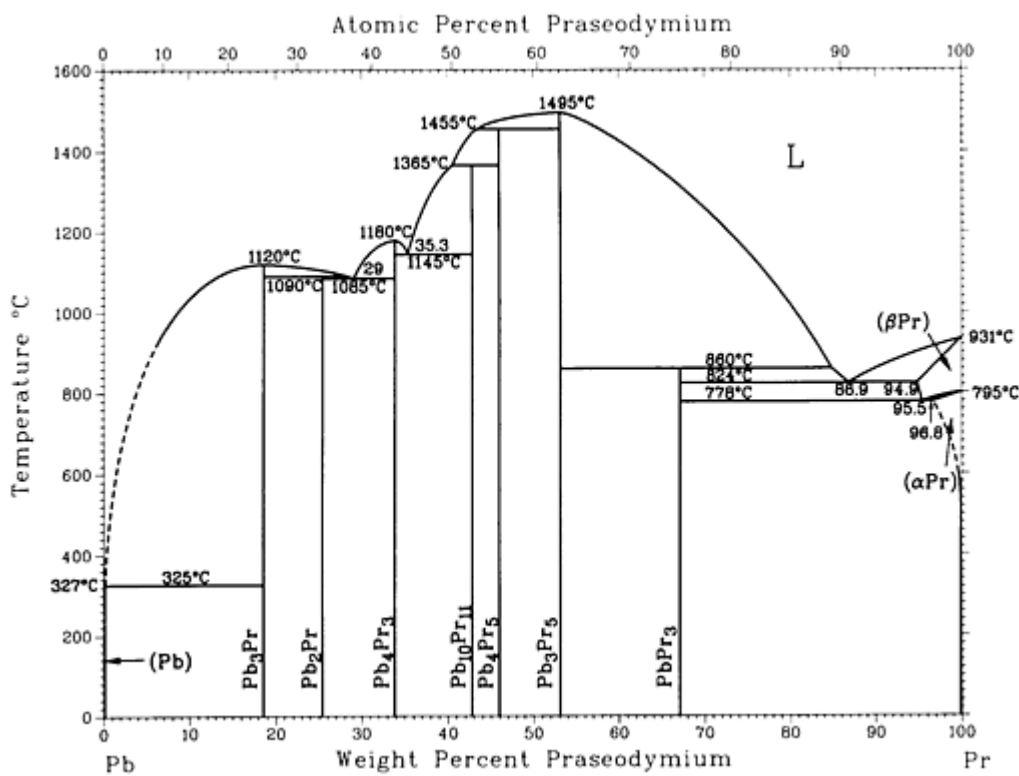

Pb-Pr phase diagram

Pb-Pr crystallographic data

Phase	Composition, wt% Pr	Pearson symbol	Space group
(Pb)	0	<i>cF4</i>	<i>Fm$\bar{3}m$</i>
Pb ₃ Pr	19	<i>cP4</i>	<i>Pm$\bar{3}m$</i>

Pb ₂ Pr	25.3	<i>tI24</i>	<i>I4₁/amd</i>
Pb ₄ Pr ₃	33.8
Pb ₁₀ Pr ₁₁	42.8	<i>tI84</i>	<i>I4/mmm</i>
Pb ₄ Pr ₅	46.0	<i>oP36</i>	<i>Pnma</i>
Pb ₃ Pr ₅	53.1	<i>hP16</i>	<i>P6₃/mcm</i>
PbPr ₃	67	<i>cP4</i>	<i>Pm$\bar{3}$m</i>
(β Pr)	94.9 to 100	<i>cI2</i>	<i>Im$\bar{3}$m</i>
(α Pr)	96.8 to 100	<i>hP4</i>	<i>P6₃/mmc</i>

Pb-Pt (Lead - Platinum)

From [Hansen] 6

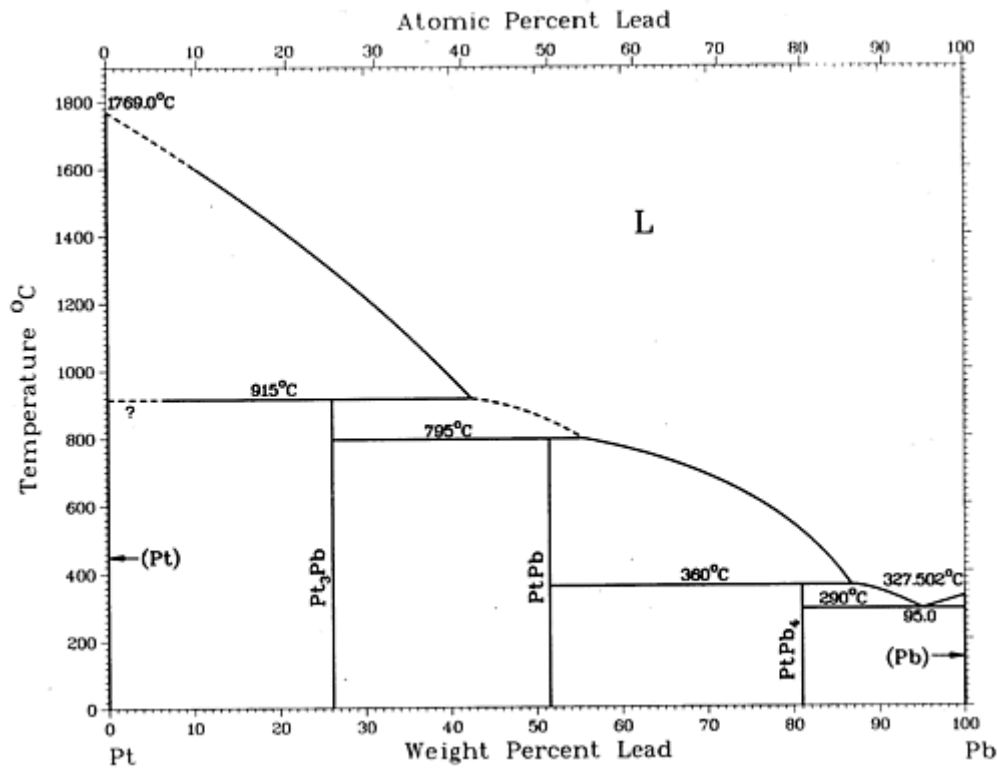

Pb-Pt phase diagram

Pb-Pt crystallographic data

Phase	Composition, wt% Pb	Pearson symbol	Space group
(Pt)	0	$cF4$	$Fm\bar{3}m$
Pt ₃ Pb	26	$cP4$	$Pm\bar{3}m$
PtPb	51.5	$hP4$	$P6_3/mmc$
PtPb ₄	81	$tP10$	$P4/nbm$
(Pb)	100	$cF4$	$Fm\bar{3}m$

Reference cited in this section

6. [Hansen]: M. Hansen and K. Anderko, *Constitution of Binary Alloys*, McGraw-Hill, New York or General Electric Co., Business Growth Services, Schenectady, New York (1958).

Pb-Pu (Lead - Plutonium)

E.M. Foltyn and D.E. Peterson, 1988

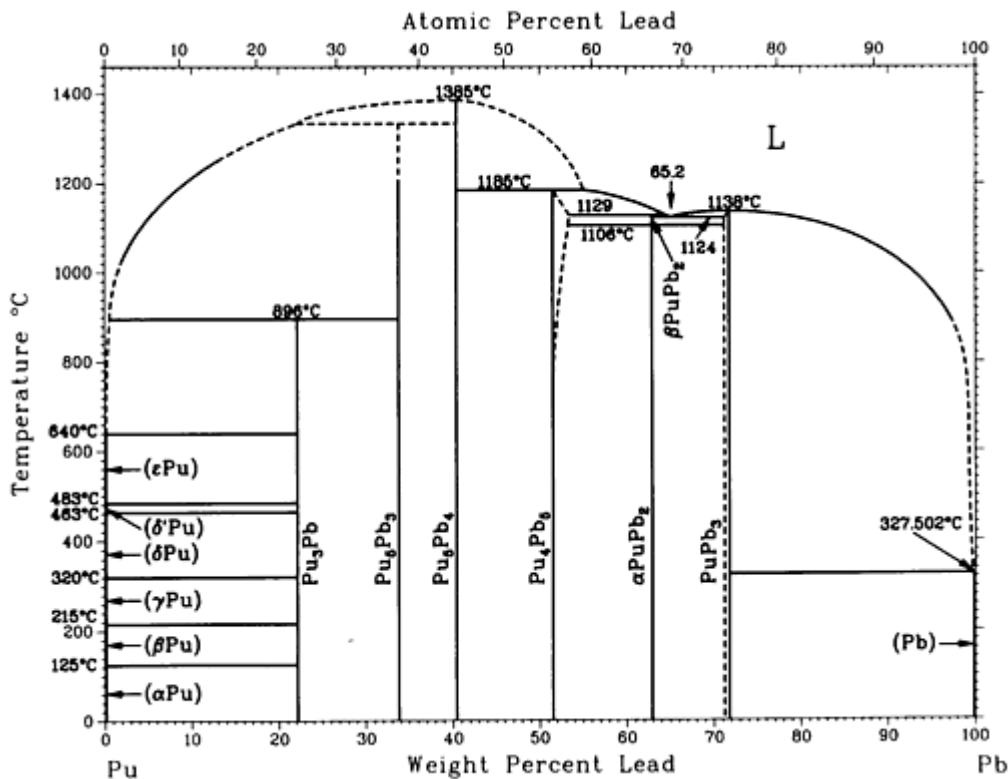

Pb-Pu phase diagram

Pb-Pu crystallographic data

Phase	Composition, wt% Pb	Pearson symbol	Space group
(ϵ Pu)	0	<i>cI2</i>	<i>Im$\bar{3}m$</i>
(δ Pu)	0	<i>tI2</i>	<i>I4/mmm</i>
(δ Pu)	0	<i>cF4</i>	<i>Fm$\bar{3}m$</i>
(γ Pu)	0	<i>oF8</i>	<i>Fddd</i>
(β Pu)	0	<i>mC34</i>	<i>C2/m</i>
(α Pu)	0	<i>mP16</i>	<i>P2₁/m</i>
Pu ₃ Pb	22	<i>cP4</i>	<i>Pm$\bar{3}m$</i>
Pu ₅ Pb ₃	33.7	<i>tI38</i>	<i>I4/mcm</i>
Pu ₅ Pb ₄	40.4	...	<i>P6₃/mcm</i>
Pu ₄ Pb ₅	51.5 to 53.5	...	<i>P6₃22</i>
β PuPb ₂	63.0
PuPb ₂	63.0	<i>tI24</i>	<i>I4₁/amd</i>
PuPb ₃	71 to 72	<i>cP4</i>	<i>Pm$\bar{3}m$</i>
(Pb)	100	<i>cF4</i>	<i>Fm$\bar{3}m$</i>

Pb-Rb (Lead - Rubidium)

A.N. Kuznetsov, K.A. Chuntunov, and S.P. Yatsenko, 1977

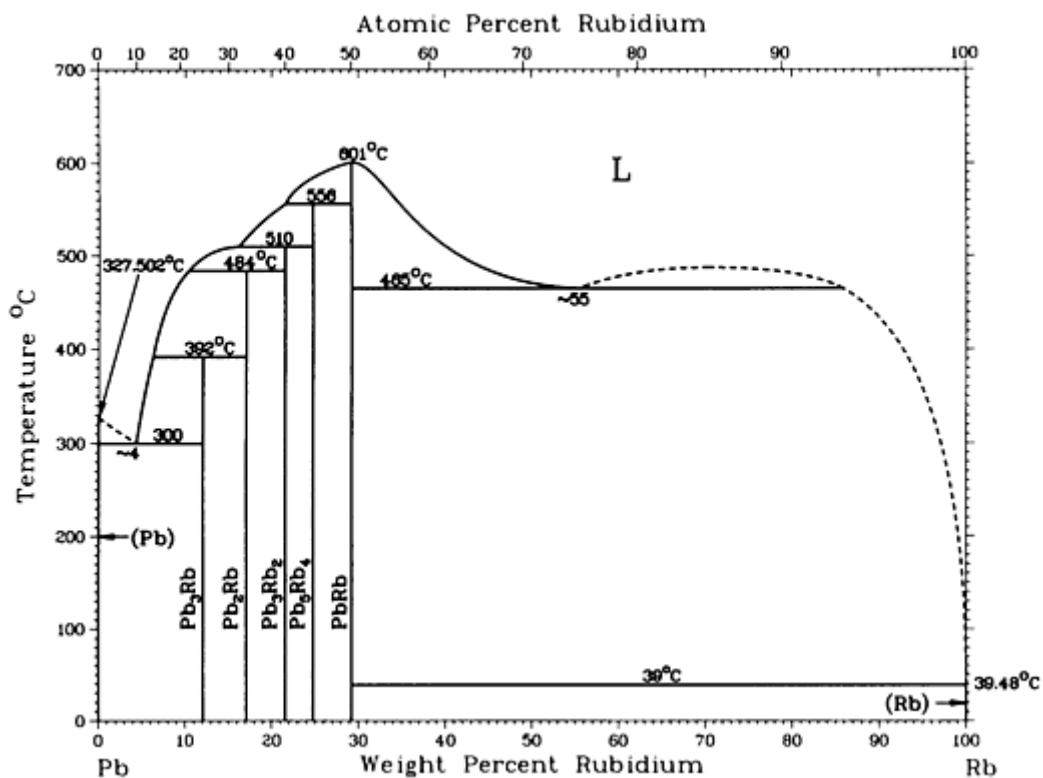

Pb-Rb phase diagram

Pb-Rb crystallographic data

Phase	Composition, wt% Rb	Pearson symbol	Space group
(Pb)	0	<i>cF4</i>	<i>Fm</i> $\bar{3}m$
Pb ₃ Rb	12
Pb ₂ Rb	17.1
Pb ₃ Rb ₂	22
Pb ₅ Rb ₄	24.8
PbRb	29.2	<i>tI64</i>	<i>I4</i> ₁ <i>acd</i>
(Rb)	100	<i>cI2</i>	<i>Im</i> $\bar{3}m$

Pb-Rh (Lead - Rhodium)

H. Okamoto, 1990

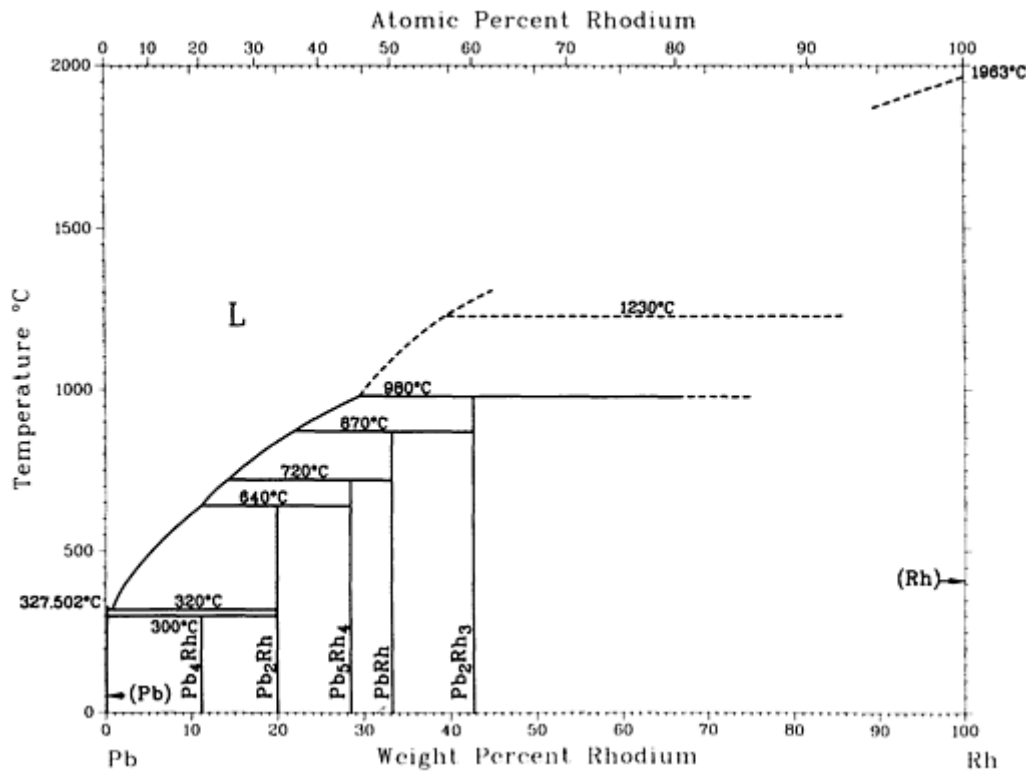

Pb-Rh phase diagram

Pb-Rh crystallographic data

Phase	Composition, wt% Rh	Pearson symbol	Space group
(Pb)	0	<i>cF4</i>	<i>Fm</i> $\bar{3}m$
Pb ₄ Rh	11
Pb ₂ Rh	19.9	<i>tI12</i>	<i>I4/mcm</i>
Pb ₅ Rh ₄	28.4	<i>oF72</i>	<i>Fmmm</i>
PbRh	33.2	<i>hP6</i>	<i>P6/mmm</i>
Pb ₂ Rh ₃	43	<i>hP4</i>	<i>P6₃/mmc</i>
(Rh)	100	<i>cF4</i>	<i>Fm</i> $\bar{3}m$

Pb-S (Lead - Sulfur)

J.-C. Lin, R.C. Sharma, and Y.A. Chang, 1986

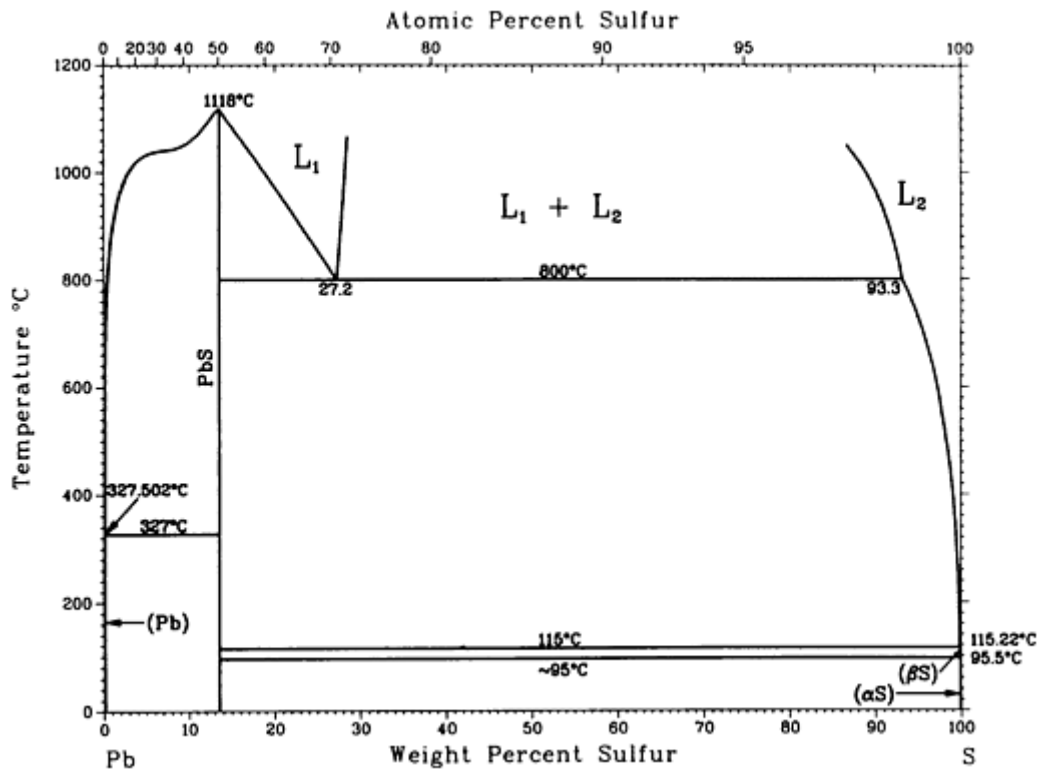

Pb-S phase diagram

Pb-S crystallographic data

Phase	Composition, wt% S	Pearson symbol	Space group
(Pb)	~0	<i>cF4</i>	<i>Fm</i> $\bar{3}m$
PbS	13.4	<i>cF8</i>	<i>Fm</i> $\bar{3}m$
PbS ^(a)	13.4	<i>oP8</i>	<i>Pnma</i>
(β _S)	100	<i>mP</i> *	<i>P2</i> ₁ / <i>c</i>
(α _S)	100	<i>oF128</i>	<i>Fddd</i>

(a)

High-pressure phase

Pb-Sb (Lead - Antimony)

S. Ashtakala, A.D. Pelton, and C.W. Bale, 1981

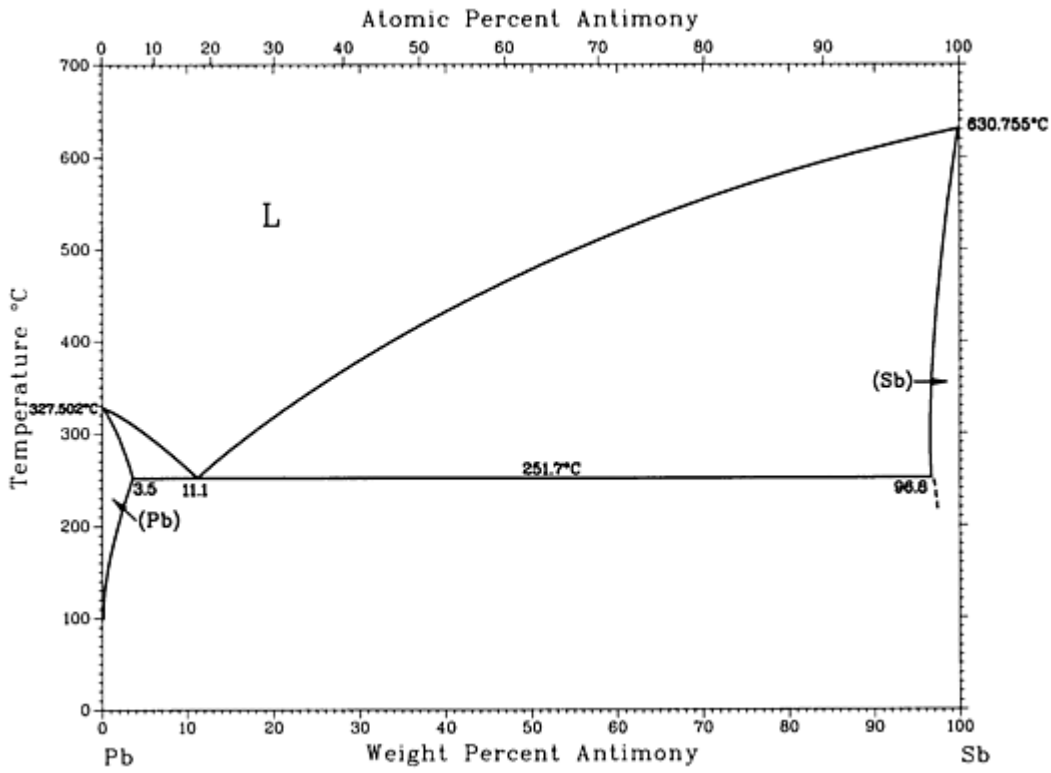

Pb-Sb phase diagram

Pb-Sb crystallographic data

Phase	Composition, wt% Sb	Pearson symbol	Space group
(Pb)	0 to 3.5	$cF4$	$Fm\bar{3}m$
(Sb)	? to 100	$hR2$	$R\bar{3}m$

Pb-Se (Lead - Selenium)

J.-C. Lin, R.C. Sharma, and Y.A. Chang, unpublished

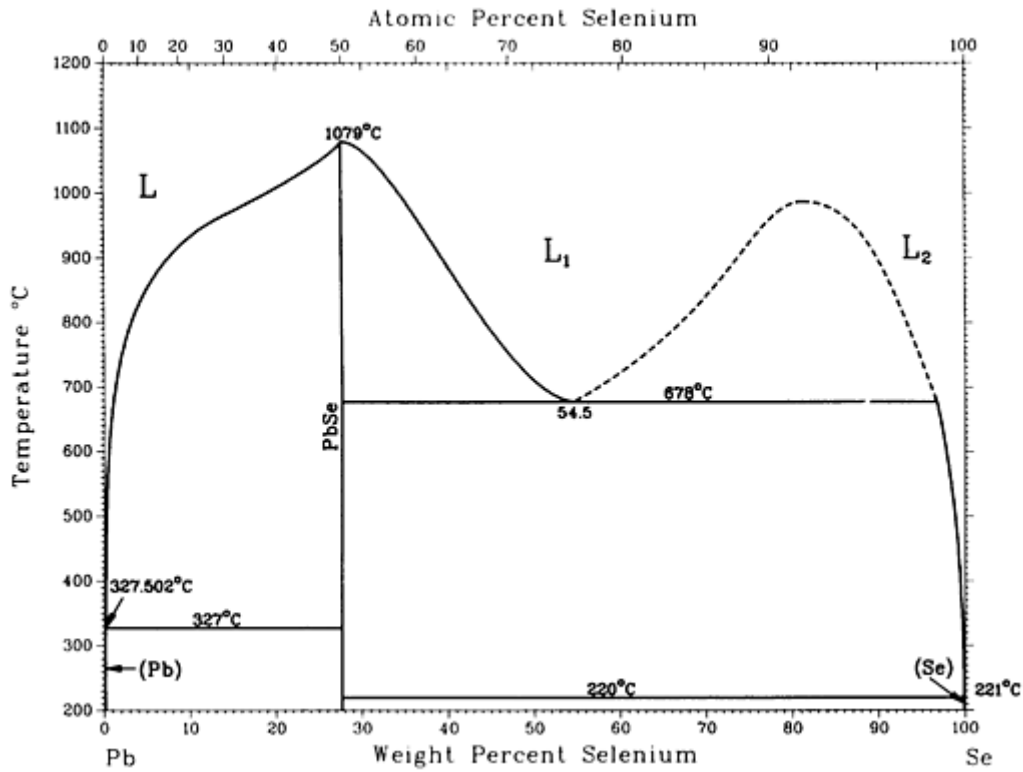

Pb-Se phase diagram

Pb-Se crystallographic data

Phase	Composition, wt% Se	Pearson symbol	Space group
(Pb)	~0	<i>cF4</i>	<i>Fm</i> $\bar{3}m$
PbSe	27.6	<i>cF8</i>	<i>Fm</i> $\bar{3}m$
PbSe(HP)	27.6	<i>oP87</i>	<i>Pnma</i>
(Se)	~100	<i>hP3</i>	<i>P3</i> ₁ <i>21</i>

Pb-Sn (Lead - Tin)

I. Karakaya and W.T. Thompson, 1988

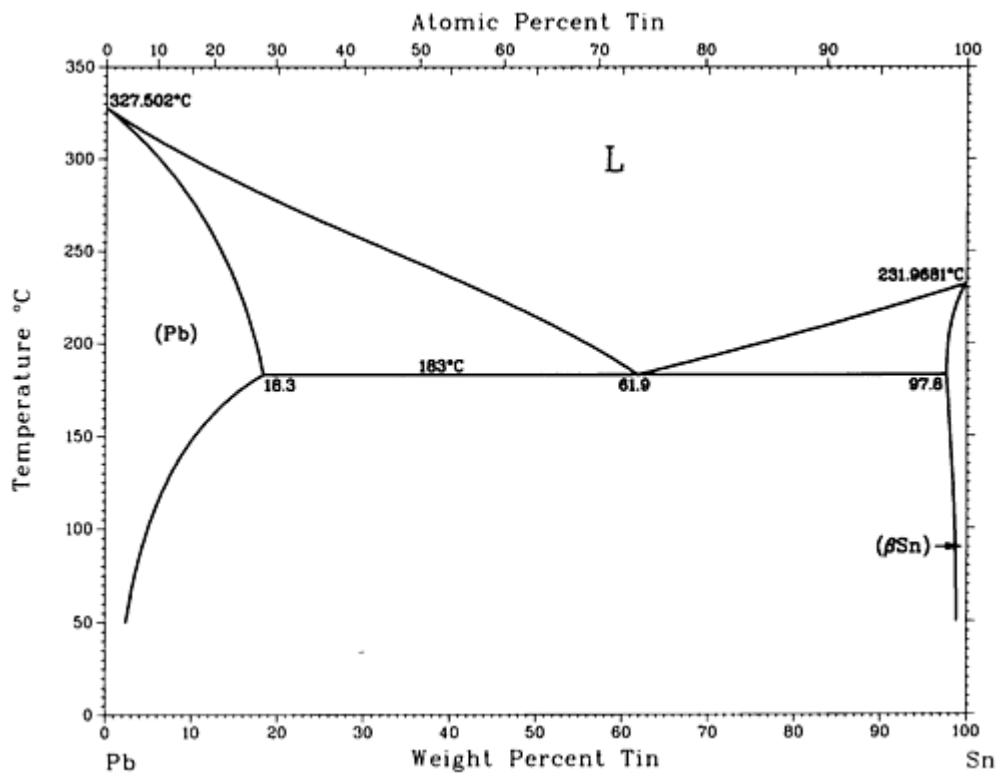

Pb-Sn phase diagram

Pb-Sn crystallographic data

Phase	Composition, wt% Sn	Pearson symbol	Space group
(Pb)	0 to 18.3	$cF4$	$Fm\bar{3}m$
(β Sn)	97.8 to 100	$tI4$	$I4_1/amd$
(α Sn)	100	$cF8$	$Fd\bar{3}m$
High-pressure phases			
$\epsilon^{(a)}$	52 to 74	$hP1$	$P6/mmm$
$\epsilon^{(b)}$	52	$hP2$	$P6_3/mmc$

(a) From phase diagram calculated at 2500

MPa.

- (b) This phase was claimed for alloys at 350 °C and 5500 MPa.

Pb-Sr (Lead - Strontium)

G. Bruzzone, E. Franceschi, and F. Merlo, 1981

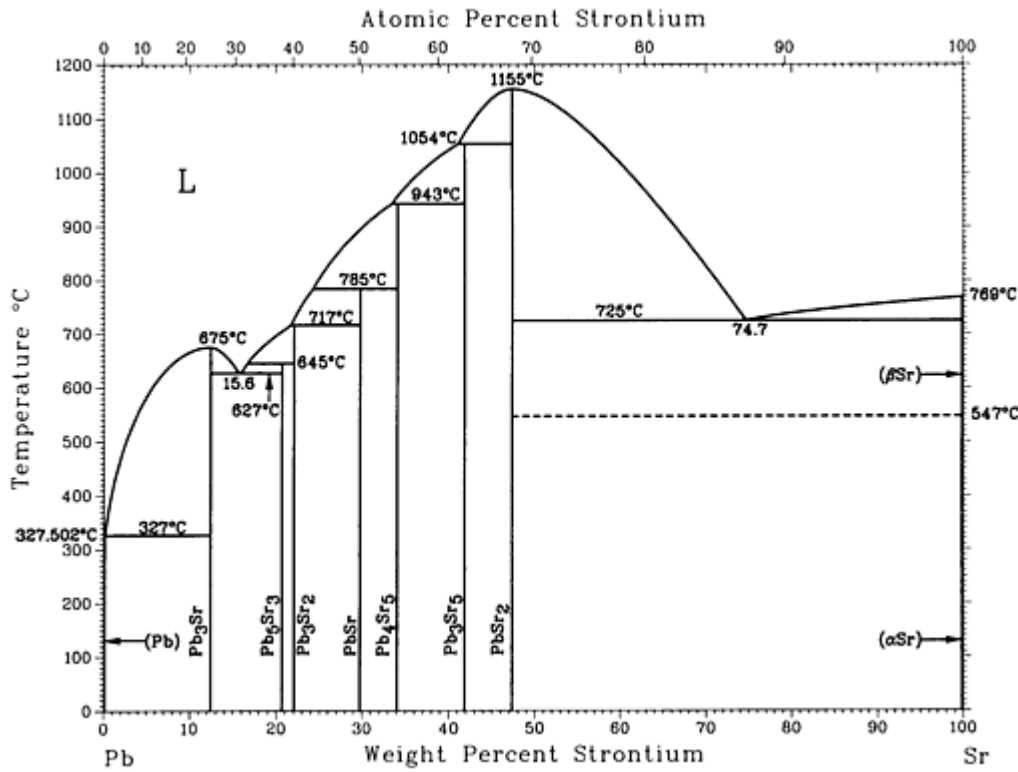

Pb-Sr phase diagram

Pb-Sr crystallographic data

Phase	Composition, wt% Sr	Pearson symbol	Space group
(Pb)	0	<i>cF4</i>	<i>Fm</i> $\bar{3}m$
Pb ₃ Sr	12	<i>tP4</i>	<i>P4/mmm</i>
Pb ₅ Sr ₃	20.2	<i>t**</i>	...
Pb ₃ Sr ₂	22	<i>t**</i>	...
PbSr	29.7	<i>oC8</i>	<i>Cmcm</i>

Pb ₄ Sr ₅	34.6	<i>oP36</i>	<i>Pnma</i>
Pb ₃ Sr ₅	41.3	<i>tI32</i>	<i>I4/mcm</i>
PbSr ₂	45.9	<i>oP12</i>	<i>Pnma</i>
(βSr)	100	<i>cI2</i>	<i>Im$\bar{3}m$</i>
(αSr)	100	<i>cF4</i>	<i>Fm$\bar{3}m$</i>

Pb-Te (Lead - Tellurium)

J.-C. Lin, K.C. Hsieh, R.C. Sharma, and Y.A. Chang, 1989

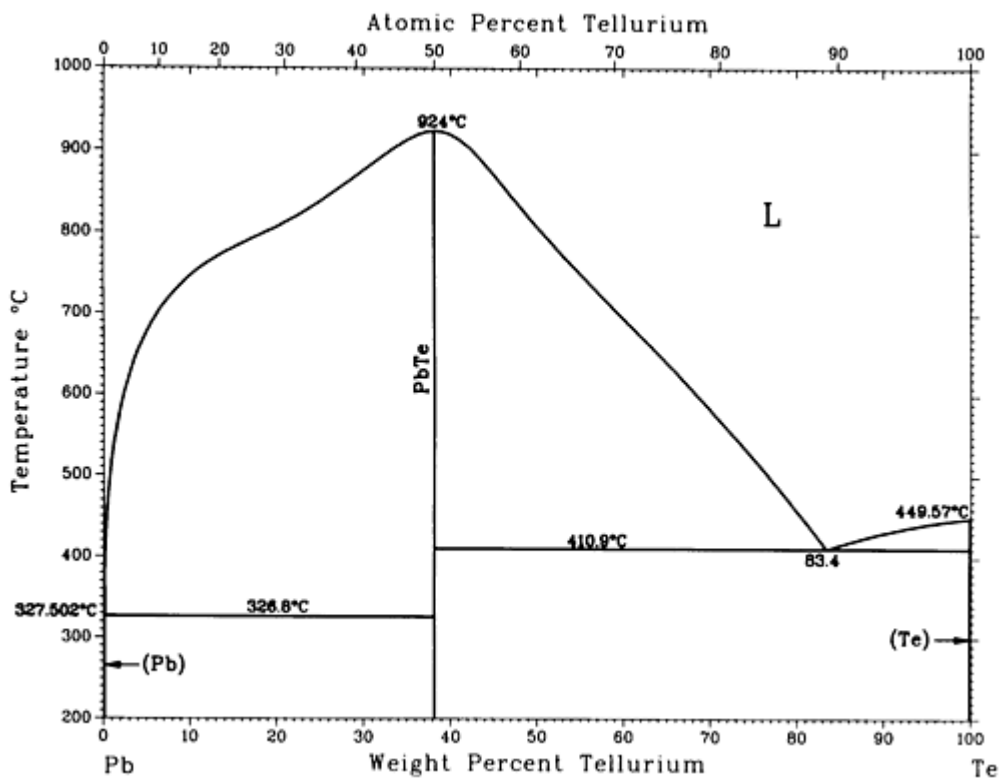

Pb-Te phase diagram

Pb-Te crystallographic data

Phase	Composition, wt% Te	Pearson symbol	Space group
(Pb)	0	<i>cF4</i>	<i>Fm$\bar{3}m$</i>

PbTe	38.1	<i>cF8</i>	<i>Fm</i> $\bar{3}m$
PbTe(HP)	38.1	<i>oP8</i>	<i>Pnma</i>
(Te)	100	<i>hP3</i>	<i>P3</i> $\bar{1}21$

Pb-Tl (Lead - Thallium)

From [Hultgren,B] 7

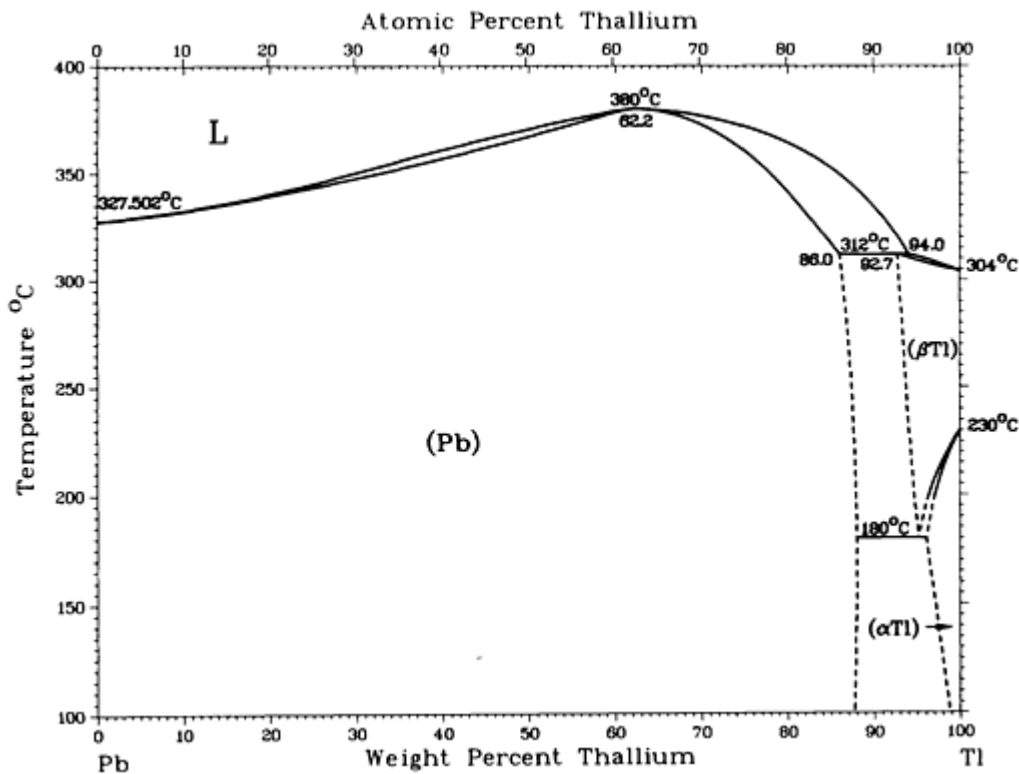

Pb-Tl phase diagram

Pb-Tl crystallographic data

Phase	Composition, wt% Tl	Pearson symbol	Space group
(Pb)	0 to 88	<i>cF4</i>	<i>Fm</i> $\bar{3}m$
(βTl)	92.7 to 100	<i>cI2</i>	<i>Im</i> $\bar{3}m$
(αTl)	96 to 100	<i>hP2</i>	<i>P6</i> $\bar{3}/mmc$

Reference cited in this section

7. [Hultgren, B]: R. Hultgren, P.D. Desai, D.T. Hawkins, M. Gleiser, and K.K. Kelley, *Selected Values of the Thermodynamic Properties of Binary Alloys*, American Society for Metals, Metals Park, Ohio (1973).

Pb-Y (Lead - Yttrium)

O.N. Carlson, F.A. Schmidt, and D.E. Diesburg, 1967

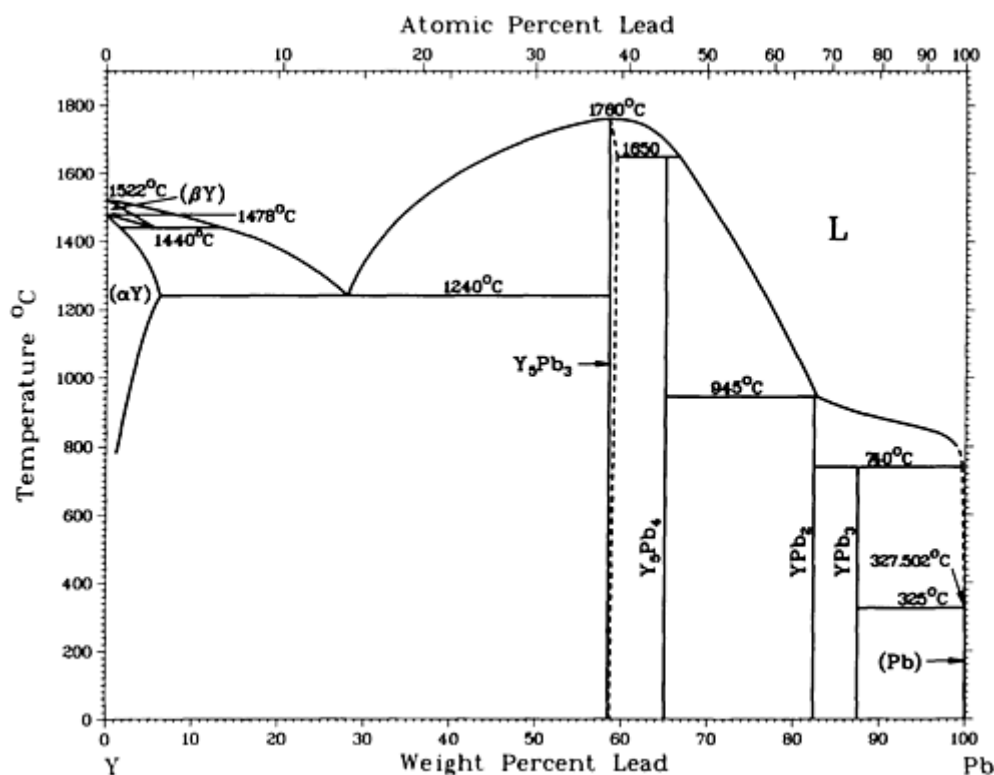

Pb-Y phase diagram

Pb-Y crystallographic data

Phase	Composition, wt% Pb	Pearson symbol	Space group
(βY)	0 to 5.6	<i>cI2</i>	<i>Im$\bar{3}m$</i>
(αY)	0 to 5.6	<i>hP2</i>	<i>P6$_3$/mmc</i>
Y_5Pb_3	~ 58.3	<i>hP16</i>	<i>P6$_3$/mcm</i>
Y_5Pb_4	65.1	<i>oP6</i>	<i>Pnma</i>
YPb_2	82.3	<i>oC12</i>	<i>Cmcm</i>

YPb ₃	87.5	cP4	$Pm\bar{3}m$
(Pb)	100	cF4	$Fm\bar{3}m$

Pb-Yb (Lead - Ytterbium)

A. Palenzona and S. Cirafici, 1991

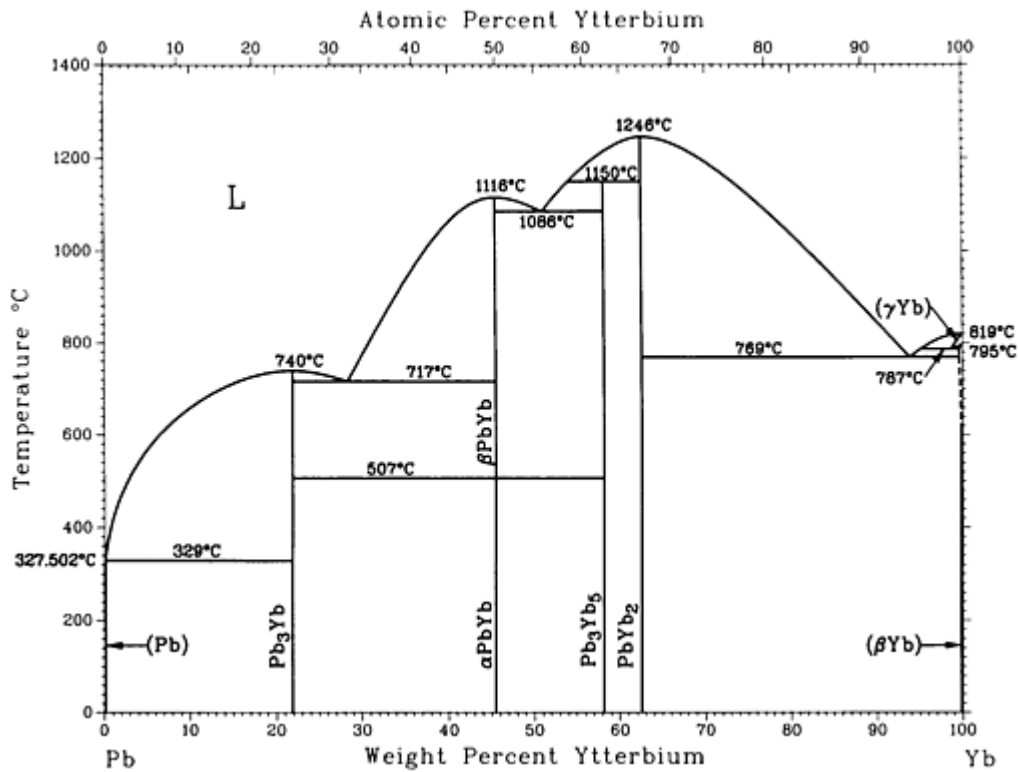

Pb-Yb phase diagram

Pb-Yb crystallographic data

Phase	Composition, wt% Yb	Pearson symbol	Space group
(Pb)	~0	cF4	$Fm\bar{3}m$
Pb ₃ Yb	22	cP4	$Pm\bar{3}m$
PbYb	45.5	<i>t</i> P4 ^(a)	$P4/mmm$ ^(a)
Pb ₃ Yb ₅	58.2	<i>h</i> P16	$P6_3/mcm$
PbYb ₂	62.6	<i>o</i> P12	$Pnma$

(γ Yb)	~ 100	$cI2$	$Im\bar{3}m$
(β Yb)	~ 100	$cF4$	$Fm\bar{3}m$
(α Yb)	~ 100	$hP2$	$P6_3/mmc$

(a) Low-temperature modification

Pb-Zn (Lead - Zinc)

From [Hansen] 6

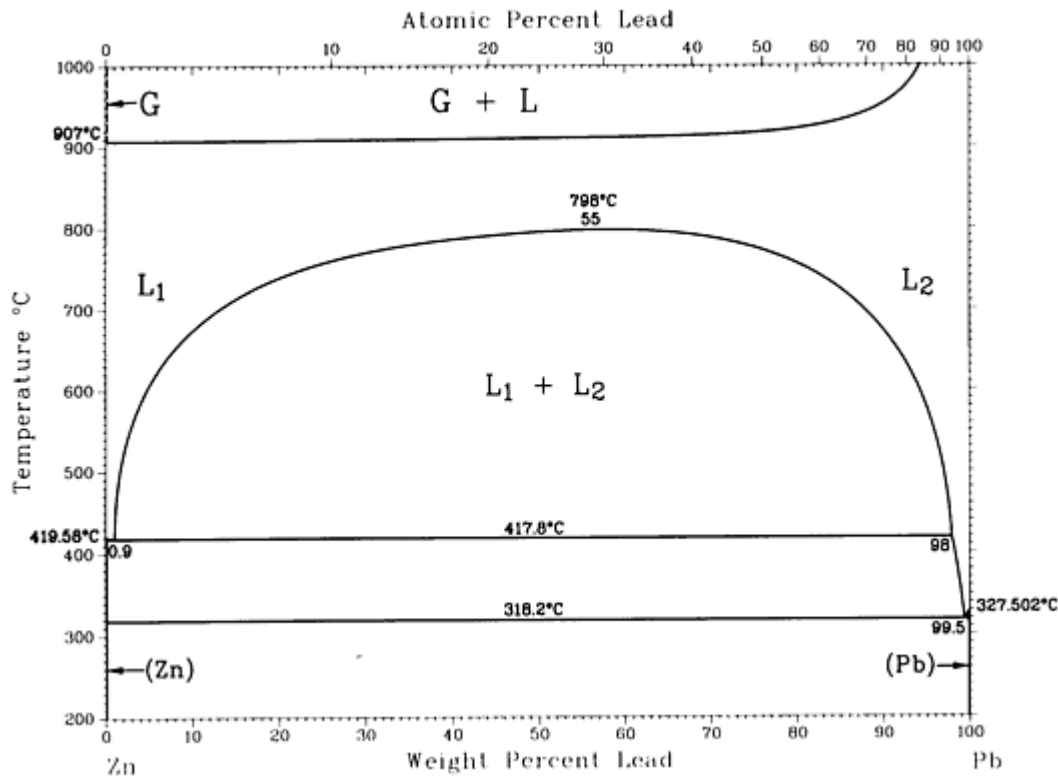

Pb-Zn phase diagram

Pb-Zn crystallographic data

Phase	Composition, wt% Pb	Pearson symbol	Space group
(Zn)	0	$hP2$	$P6_3/mmc$
(Pb)	100	$cF4$	$Fm\bar{3}m$

Reference cited in this section

6. [Hansen]: M. Hansen and K. Anderko, *Constitution of Binary Alloys*, McGraw-Hill, New York or General Electric Co., Business Growth Services, Schenectady, New York (1958).

Pd (Palladium) Binary Alloy Phase Diagrams

Introduction

THIS ARTICLE includes systems where palladium is the first-named element in the binary pair. Additional binary systems that include palladium are provided in the following locations in this Volume:

- “Ag-Pd (Silver - Palladium)” in the article “Ag (Silver) Binary Alloy Phase Diagrams.”
- “Al-Pd (Aluminum - Palladium)” in the article “Al (Aluminum) Binary Alloy Phase Diagrams.”
- “As-Pd (Arsenic - Palladium)” in the article “As (Arsenic) Binary Alloy Phase Diagrams.”
- “Au-Pd (Gold - Palladium)” in the article “Au (Gold) Binary Alloy Phase Diagrams.”
- “B-Pd (Boron - Palladium)” in the article “B (Boron) Binary Alloy Phase Diagrams.”
- “Be-Pd (Beryllium - Palladium)” in the article “Be (Beryllium) Binary Alloy Phase Diagrams.”
- “Bi-Pd (Bismuth - Palladium)” in the article “Bi (Bismuth) Binary Alloy Phase Diagrams.”
- “Ca-Pd (Calcium - Palladium)” in the article “Ca (Calcium) Binary Alloy Phase Diagrams.”
- “Ce-Pd (Cerium - Palladium)” in the article “Ce (Cerium) Binary Alloy Phase Diagrams.”
- “Co-Pd (Cobalt - Palladium)” in the article “Co (Cobalt) Binary Alloy Phase Diagrams.”
- “Cr-Pd (Chromium - Palladium)” in the article “Cr (Chromium) Binary Alloy Phase Diagrams.”
- “Cu-Pd (Copper - Palladium)” in the article “Cu (Copper) Binary Alloy Phase Diagrams.”
- “Dy-Pd (Dysprosium - Palladium)” in the article “Dy (Dysprosium) Binary Alloy Phase Diagrams.”
- “Er-Pd (Erbium - Palladium)” in the article “Er (Erbium) Binary Alloy Phase Diagrams.”
- “Eu-Pd (Europium - Palladium)” in the article “Eu (Europium) Binary Alloy Phase Diagrams.”
- “Fe-Pd (Iron - Palladium)” in the article “Fe (Iron) Binary Alloy Phase Diagrams.”
- “Ga-Pd (Gallium - Palladium)” in the article “Ga (Gallium) Binary Alloy Phase Diagrams.”
- “Gd-Pd (Gadolinium - Palladium)” in the article “Gd (Gadolinium) Binary Alloy Phase Diagrams.”
- “Ge-Pd (Germanium - Palladium)” in the article “Ge (Germanium) Binary Alloy Phase Diagrams.”
- “H-Pd (Hydrogen - Palladium)” in the article “H (Hydrogen) Binary Alloy Phase Diagrams.”
- “Ho-Pd (Holmium - Palladium)” in the article “Ho (Holmium) Binary Alloy Phase Diagrams.”
- “In-Pd (Indium - Palladium)” in the article “In (Indium) Binary Alloy Phase Diagrams.”
- “Ir-Pd (Iridium - Palladium)” in the article “Ir (Iridium) Binary Alloy Phase Diagrams.”
- “Li-Pd (Lithium - Palladium)” in the article “Li (Lithium) Binary Alloy Phase Diagrams.”
- “Mn-Pd (Manganese - Palladium)” in the article “Mn (Manganese) Binary Alloy Phase Diagrams.”
- “Mo-Pd (Molybdenum - Palladium)” in the article “Mo (Molybdenum) Binary Alloy Phase Diagrams.”
- “Nb-Pd (Niobium - Palladium)” in the article “Nb (Niobium) Binary Alloy Phase Diagrams.”
- “Ni-Pd (Nickel - Palladium)” in the article “Ni (Nickel) Binary Alloy Phase Diagrams.”
- “P-Pd (Phosphorus - Palladium)” in the article “P (Phosphorous) Binary Alloy Phase Diagrams.”
- “Pb-Pd (Lead - Palladium)” in the article “Pb (Lead) Binary Alloy Phase Diagrams.”

Pd-Pt (Palladium - Platinum)

H. Okamoto, 1991

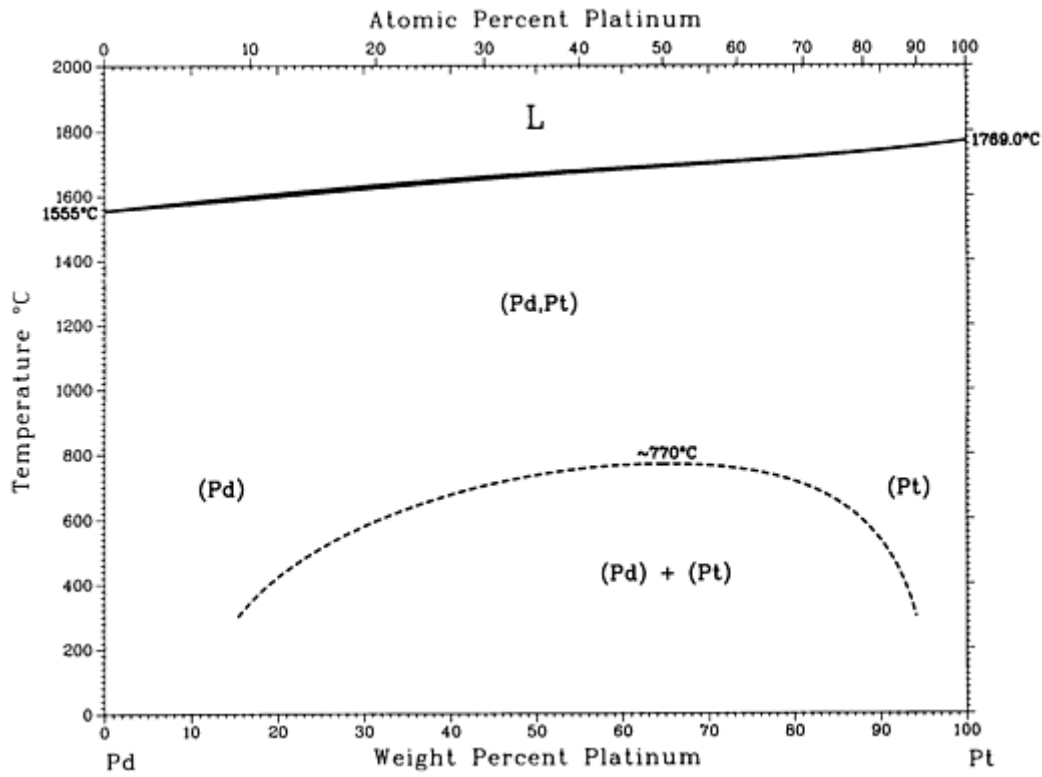

Pd-Pt phase diagram

Pd-Pt crystallographic data

Phase	Composition, wt% Pt	Pearson symbol	Space group
(Pd,Pt)	0 to 100	<i>cF4</i>	<i>Fm</i> $\bar{3}m$

Pd-Pu (Palladium - Plutonium)

V.I. Kutaitsev, N.T. Chebotarev, I.G. Lebedev, M.A. Andrianov, V.N. Konev, and T.S. Menshikova, 1967

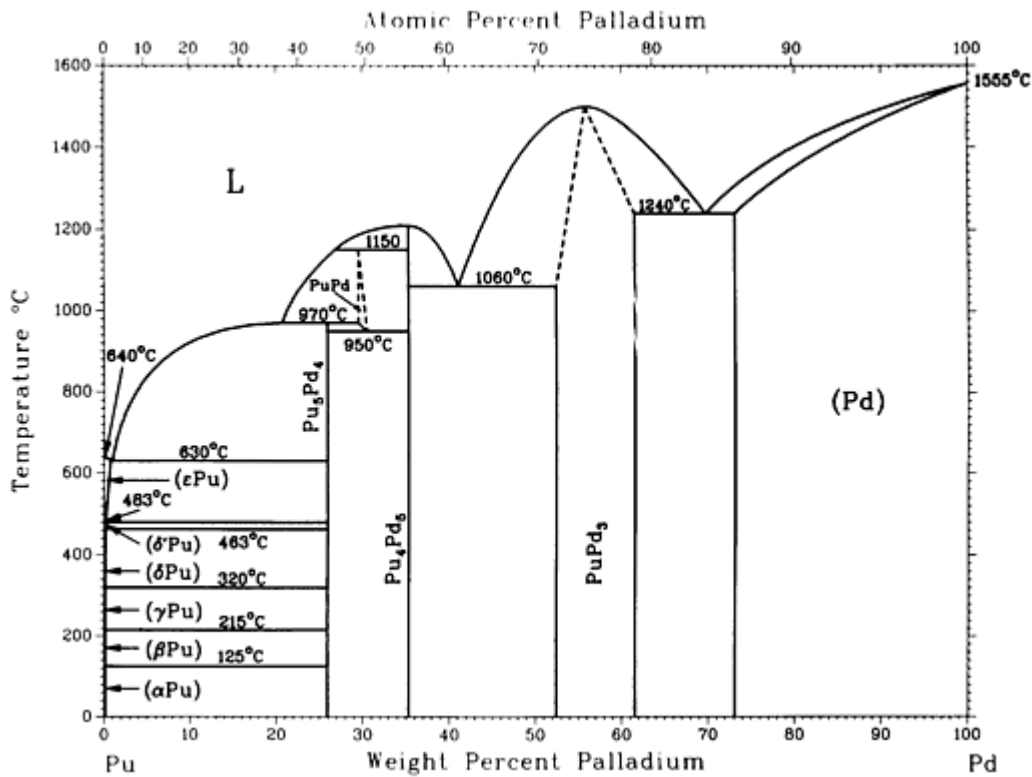

Pd-Pu phase diagram

Pd-Pu crystallographic data

Phase	Composition, wt% Pd	Pearson symbol	Space group
(εPu)	0 to 0.7	<i>cI2</i>	<i>Im$\bar{3}m$</i>
(δ'Pu)	0	<i>tI2</i>	<i>I4/mmm</i>
(δPu)	0	<i>cF4</i>	<i>Fm$\bar{3}m$</i>
(γPu)	0	<i>oF8</i>	<i>Fddd</i>
(βPu)	0	<i>mC34</i>	<i>C2/m</i>
(αPu)	0	<i>mP16</i>	<i>P2₁/m</i>
Pu ₅ Pd ₄	25.8

PuPd	~30 to 30.4	<i>oP8</i>	<i>Pnma</i>
Pu ₄ Pd ₅	35.3
PuPd ₃	~52.2 to 61.4	<i>cP4</i>	<i>Pm$\bar{3}m$</i>
(Pd)	~73 to 100	<i>cF4</i>	<i>Fm$\bar{3}m$</i>

Pd-Rh (Palladium - Rhodium)

H. Okamoto, 1990

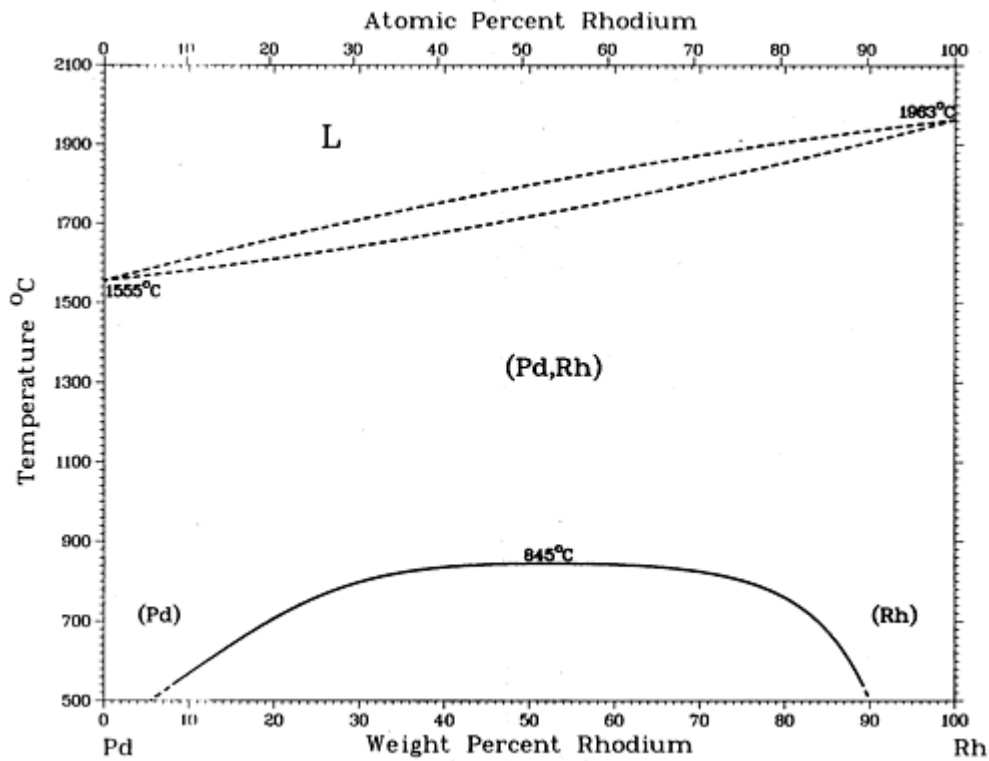

Pd-Rh phase diagram

Pd-Rh crystallographic data

Phase	Composition, wt% Rh	Pearson symbol	Space group
(Pd,Rh)	0 to 100	<i>cF4</i>	<i>Fm$\bar{3}m$</i>

Pd-Ru (Palladium - Ruthenium)

H. Okamoto, 1990

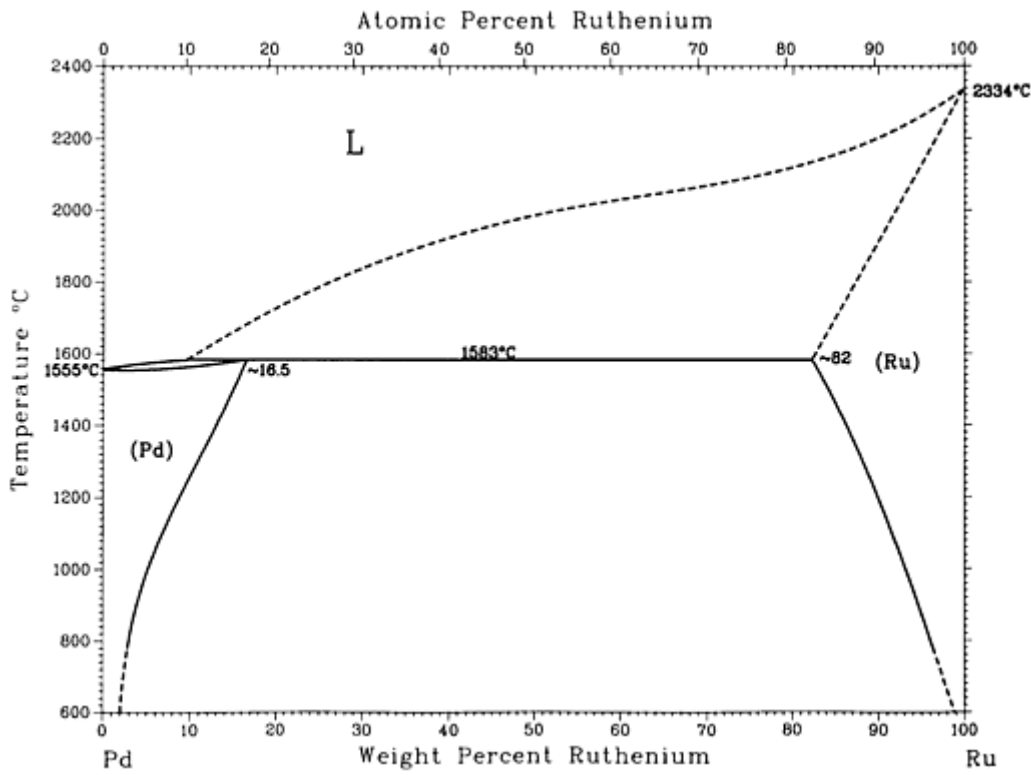

Pd-Ru phase diagram

Pd-Ru crystallographic data

Phase	Composition, wt% Ru	Pearson symbol	Space group
(Pd)	0 to ~16.5	<i>cF4</i>	<i>Fm</i> $\bar{3}m$
(Ru)	~82 to 100	<i>hP2</i>	<i>P6</i> ₃ / <i>mmc</i>

Pd-S (Palladium - Sulfur)

H. Okamoto, 1992

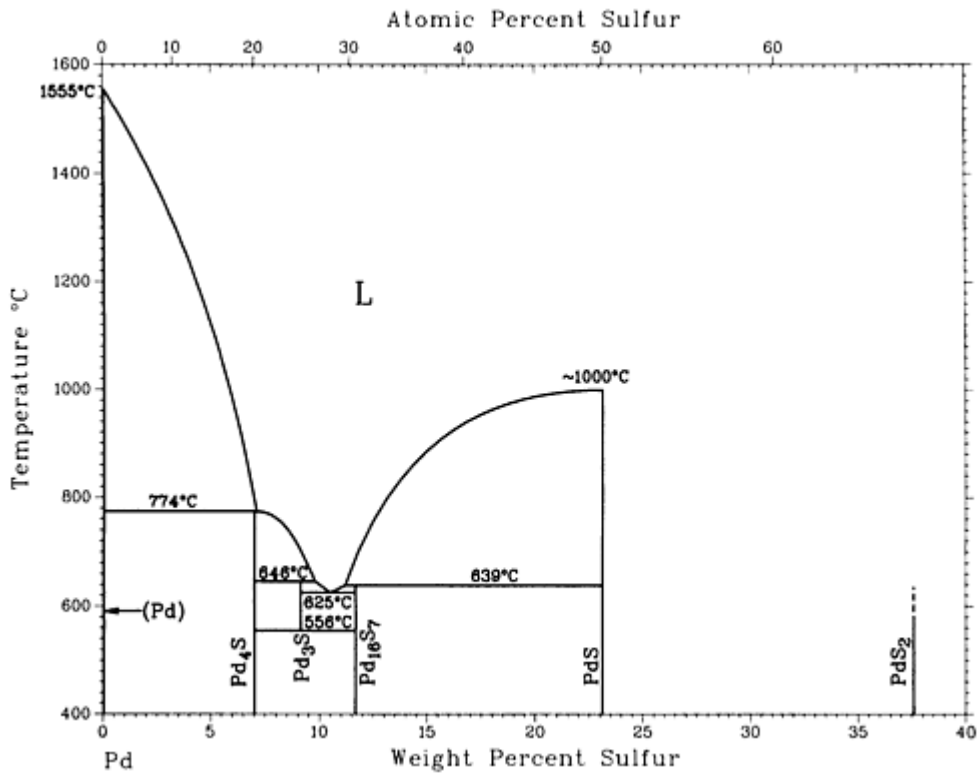

Pd-S phase diagram

Pd-S crystallographic data

Phase	Composition, wt% S	Pearson symbol	Space group
(Pd)	0	<i>cF4</i>	<i>Fm$\bar{3}m$</i>
Pd ₄ S	7	<i>tP10</i>	<i>P$\bar{4}2_1c$</i>
Pd ₃ S	9	<i>oC16</i>	<i>Ama2</i>
Pd ₁₇ S ₇	11.6	<i>cP64</i>	<i>Pm$\bar{3}m$</i>
PdS	23.2	<i>tP16</i>	<i>P4₂/m</i>
PdS ₂	37.6	<i>oP12</i>	<i>Pbca</i>

Pd-Sb (Palladium - Antimony)

H. Okamoto, 1992

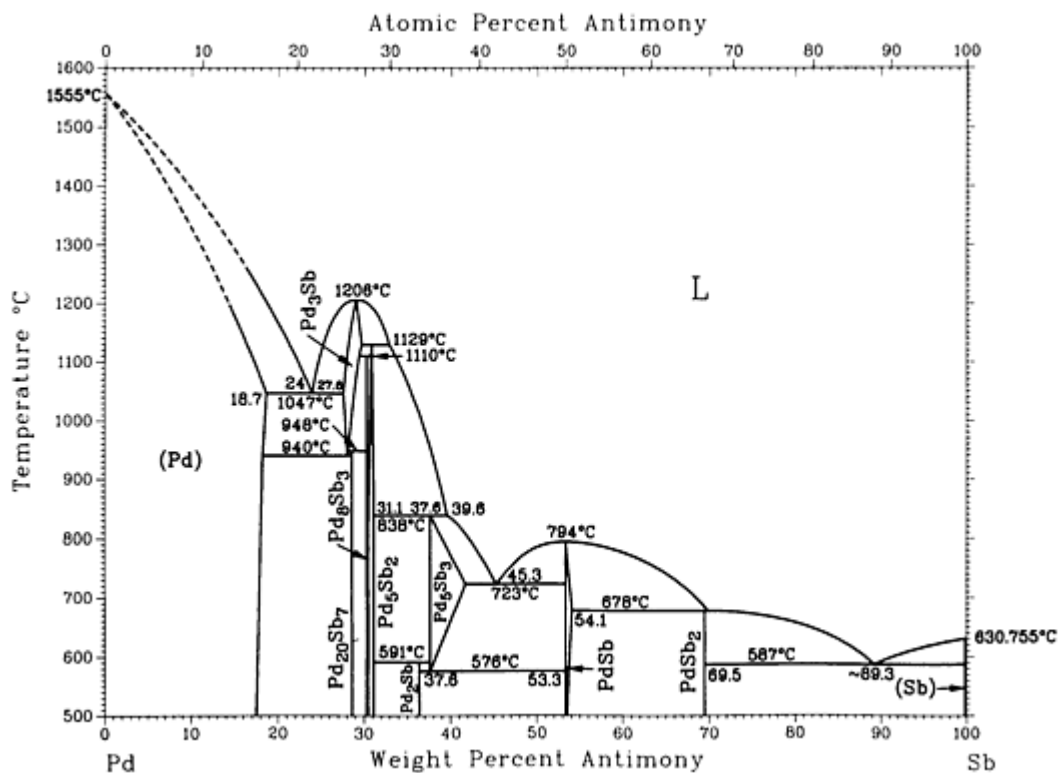

Pd-Sb phase diagram

Pd-Sb crystallographic data

Phase	Composition, wt% Sb	Pearson symbol	Space group
(Pd)	0 to 18.7	<i>cF4</i>	<i>Fm</i> $\bar{3}m$
Pd ₃ Sb	27.6 to 29.7	<i>cF16</i>	<i>Fd</i> $\bar{3}m$
Pd ₂₀ Sb ₇	28.6	<i>hR27</i>	<i>R</i> $\bar{3}$
Pd ₈ Sb ₃	30.3	<i>hR44</i>	<i>R</i> $\bar{3}c$
Pd ₅ Sb ₂	30.5 to 31.1	<i>hP84</i>	<i>P6</i> ₃ / <i>mmc</i>
Pd ₂ Sb	36.4	<i>oC24</i>	<i>Cmc</i> 2 ₁
Pd ₅ Sb ₃	37.4 to 41.7	<i>hP4</i>	<i>P6</i> ₃ / <i>mmc</i>

PdSb	53.4 to 44.2	<i>hP4</i>	<i>P6₃/mmc</i>
PdSb ₂	69.6	<i>cP12</i>	<i>Pa3</i>
(Sb)	100	<i>hR2</i>	<i>R3̄m</i>

Pd-Se (Palladium - Selenium)

H. Okamoto, 1992

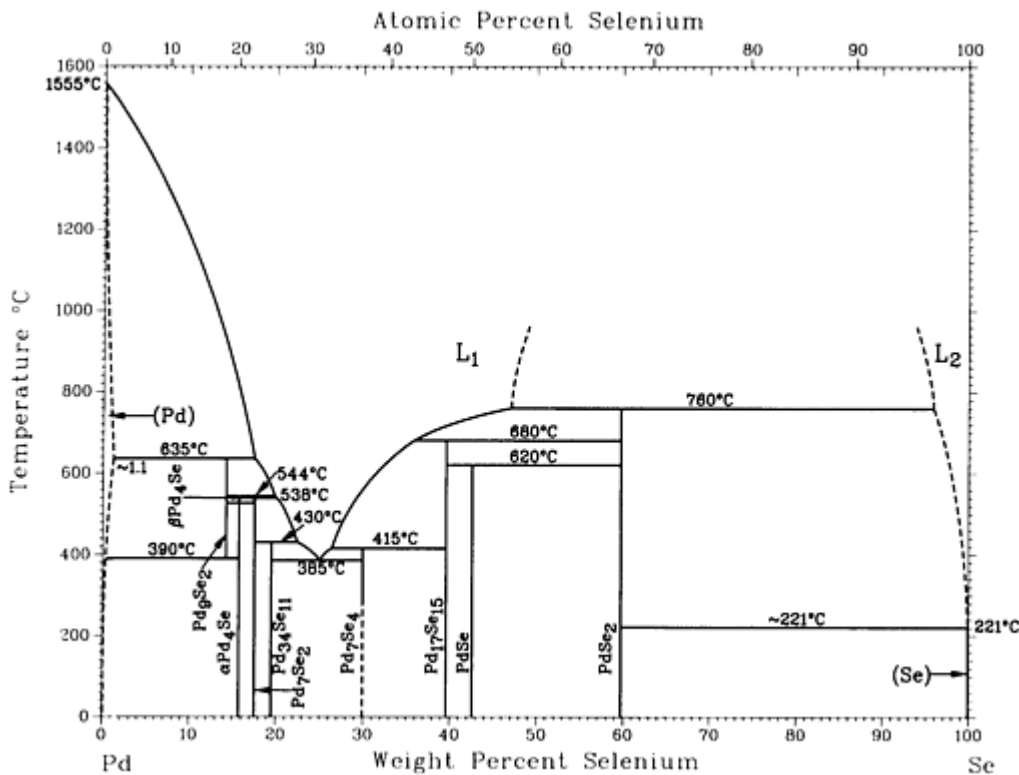

Pd-Se phase diagram

Pd-Se crystallographic data

Phase	Composition, wt% Se	Pearson symbol	Space group
(Pd)	0 to ~1.1	<i>cF4</i>	<i>Fm3̄m</i>
Pd ₉ Se ₂	14.2	<i>hP*</i>	...
β-Pd ₄ Se	16
α-Pd ₄ Se	16	<i>tP10</i>	<i>P4̄2₁c</i>

(Pd)	0	<i>cF4</i>	<i>Fm</i> $\bar{3}m$
Pd ₅ Si	5.02	<i>mP24</i>	<i>P2</i> ₁
Pd ₉ Si ₂	5.54	<i>oP44</i>	<i>Pnma</i>
Pd ₃ Si	8.1	<i>oP16</i>	<i>Pnma</i>
Pd ₂ Si	11.5 to 12.1	<i>hP9</i>	<i>P</i> $\bar{6}2m$
Pd ₂ Si ^(a)	11.7 to 12.1	^(b)	...
PdSi ^(c)	20.9	<i>oP8</i>	<i>Pnma</i>
(Si)	100	<i>cF8</i>	<i>Fd</i> $\bar{3}m$

(a) Below 1090 °C.

(b) Hexagonal superstructure based on the Pd₂Si unit cell.

(c) From 972 to 612 °C

Pd-Sm (Palladium - Samarium)

H. Okamoto, 1990

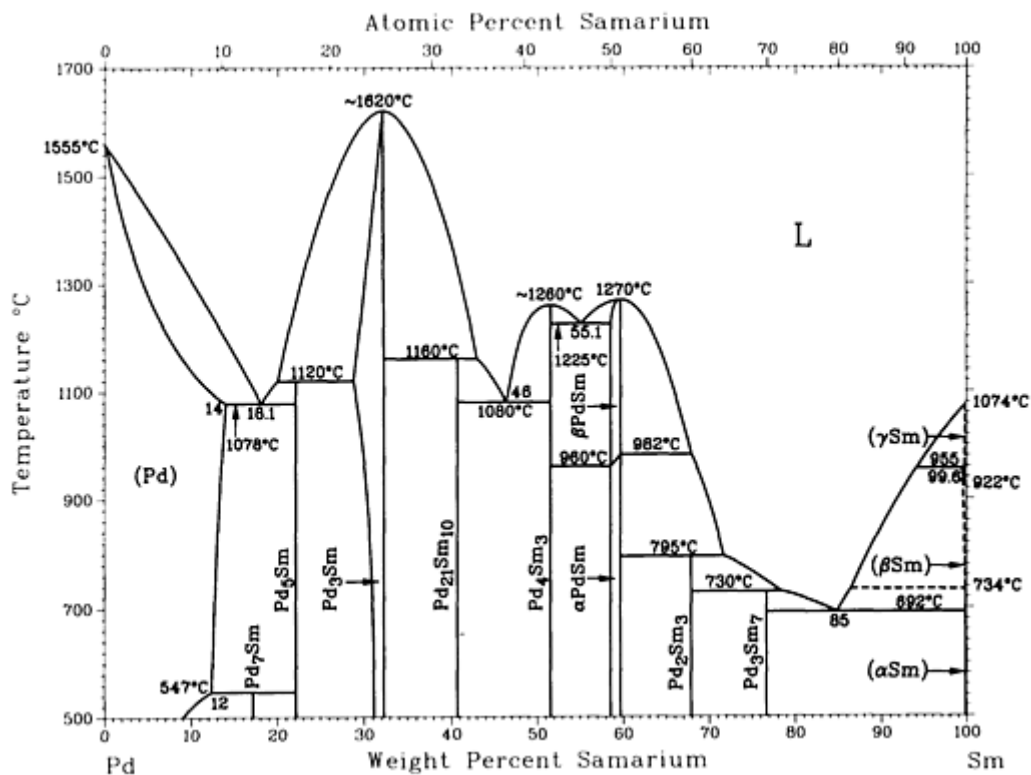

Pd-Sm phase diagram

Pd-Sm crystallographic data

Phase	Composition, wt% Sm	Pearson symbol	Space group
(Pd)	0 to 14	<i>cF4</i>	<i>Fm</i> $\bar{3}m$
Pd ₇ Sm	16.8	<i>c**</i>	...
Pd ₅ Sm	22.1	<i>o*72</i>	...
Pd ₃ Sm	29.1 to 32	<i>cP4</i>	<i>Pm</i> $\bar{3}m$
Pd ₂₁ Sm ₁₀	40.3	<i>mC124</i>	<i>C2/m</i>
Pd ₄ Sm ₃	51.5	<i>hR14</i>	<i>R</i> $\bar{3}$
β _{PdSm}	58.6

α PdSm	58.6	<i>oC8</i>	<i>Cmcm</i>
Pd ₂ Sm ₃	68
Pd ₂ Sm ₇	77	<i>hP20</i>	<i>P6₃mc</i>
(γ Sm)	100	<i>cI2</i>	<i>Im$\bar{3}m$</i>
(β Sm)	100	<i>hP2</i>	<i>P6₃/mmc</i>
(α Sm)	100	<i>hR3</i>	<i>R$\bar{3}m$</i>

Pd-Sn (Palladium - Tin)

H. Okamoto, 1990

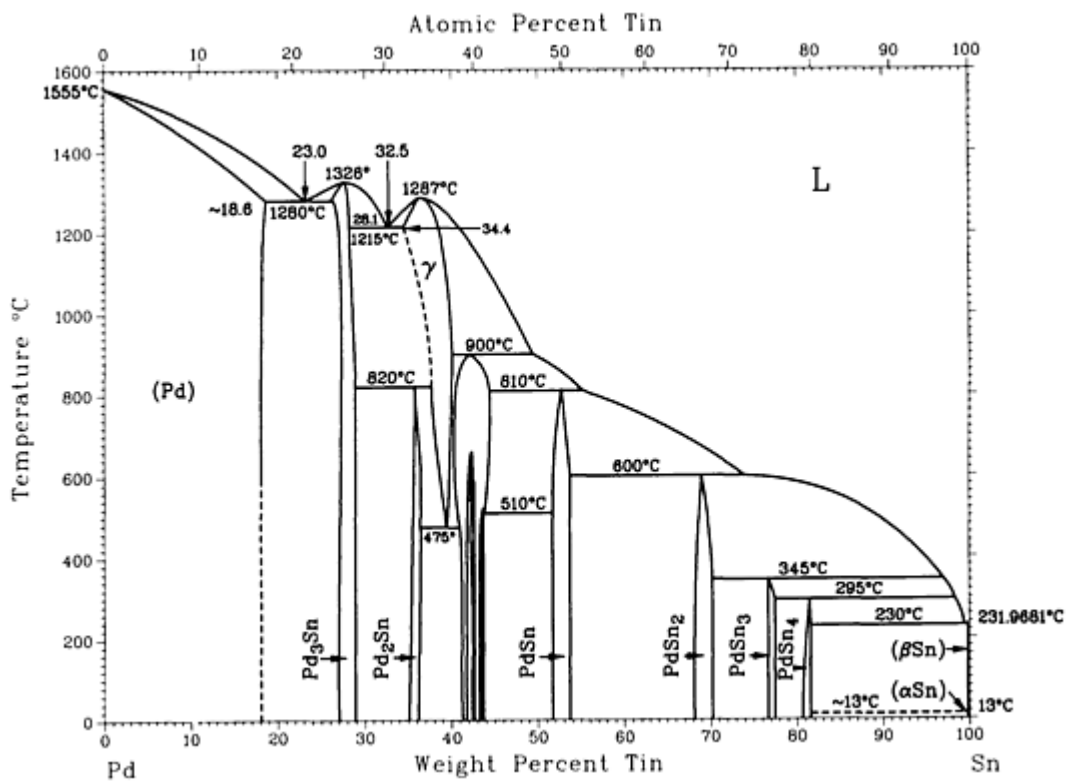

Pd-Sn phase diagram

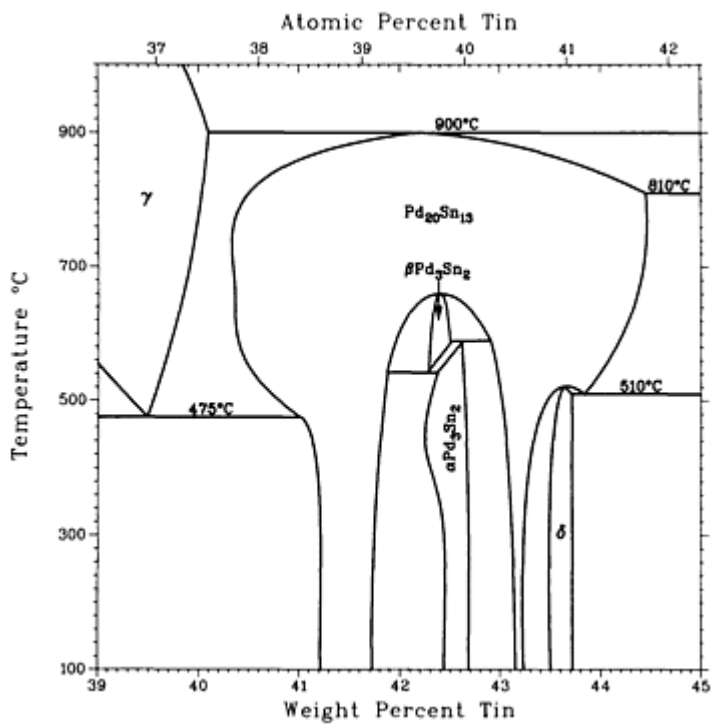

Pd-Sn phase diagram from 39 to 45 wt% Sn

Pd-Sn crystallographic data

Phase	Composition, wt% Sn	Pearson symbol	Space group
(Pd)	0 to ~18.6	<i>cF4</i>	<i>Fm</i> $\bar{3}m$
Pd ₃ Sn	26 to 28.1	<i>cP4</i>	<i>Pm</i> $\bar{3}m$
Pd ₂ Sn	35.8	<i>oP12</i>	<i>Pnma</i>
γ	34 to 40.1	<i>hP4</i>	<i>P6</i> ₃ / <i>mmc</i>
Pd ₂₀ Sn ₁₃	41 to 45	<i>hP66</i>	<i>P3</i> ₁ 21
β Pd ₃ Sn ₂	42.4
α Pd ₃ Sn ₂	43
δ	44
PdSn	~52.7	<i>oP8</i>	<i>Pnma</i>

PdSn ₂	~69.1	<i>oC24</i>	<i>Aba2</i>
PdSn ₃	~77	<i>oC32</i>	<i>Cmca</i>
PdSn ₄	~82	<i>oC20</i>	<i>Aba2</i>
(βSn)	100	<i>tI4</i>	<i>I4₁/amd</i>
(αSn)	100	<i>cF8</i>	<i>Fd$\bar{3}m$</i>

Pd-Te (Palladium - Tellurium)

H. Okamoto, 1992

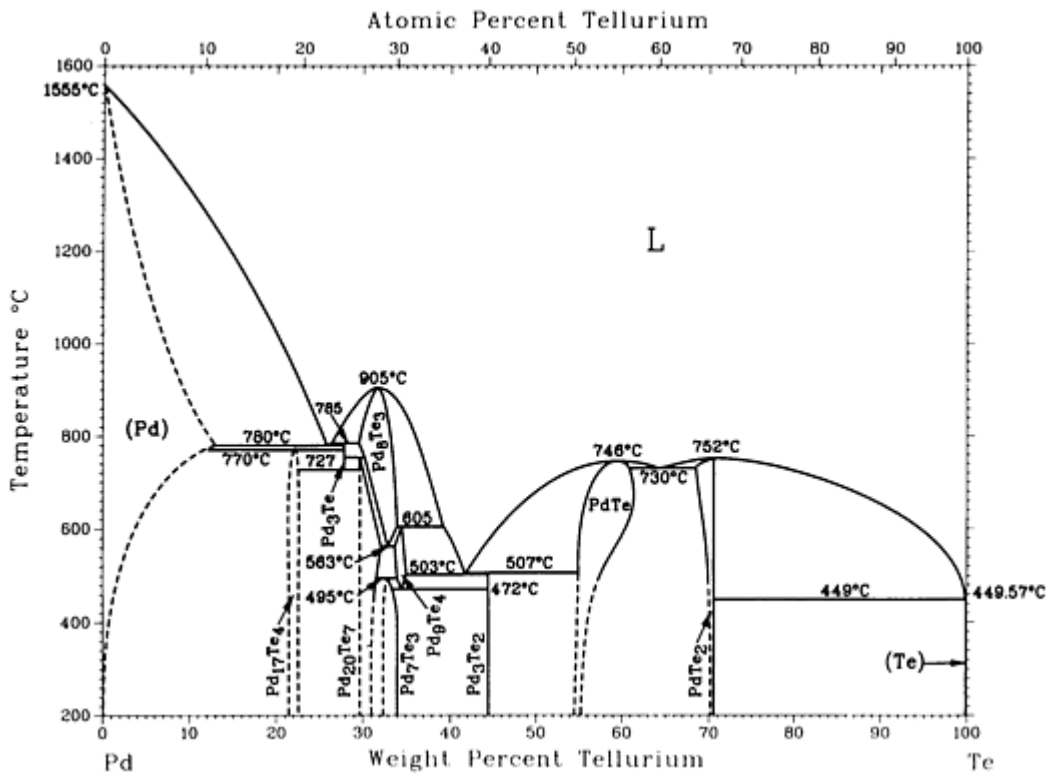

Pd-Te phase diagram

Pd-Te crystallographic data

Phase	Composition, wt% Te	Pearson symbol	Space group
(Pd)	0 to 13	<i>cF2</i>	<i>Fm$\bar{3}m$</i>
Pd ₁₇ Te ₄	~22

Pd_3Te	27.8	<i>cI2</i>	$I\bar{m}\bar{3}m$
$\text{Pd}_{20}\text{Te}_7$	30 to 34	<i>hR27</i>	R3
Pd_8Te_3	30 to 39	<i>o**</i>	...
Pd_7Te_3	33 to 34	<i>m**</i>	...
Pd_9Te_4	39 to 40	<i>mP52</i>	$P2_1/c$
Pd_3Te_2	44	<i>oC20</i>	<i>Cmcm</i>
PdTe	54.5 to 59	<i>hP4</i>	$P6_3/mmc$
PdTe_2	68.5 to 70.6	<i>hP3</i>	$P\bar{3}m1$
(Te)	100	<i>hP3</i>	$P3_121$
Questionable phases			
Pd_4Te	23 to 26	<i>cF104</i>	$F\bar{4}3m$
Pd_3Te_2	44	<i>oP45</i>	$P222_1$

Pd-Ti (Palladium - Titanium)

J.L. Murray, 1987

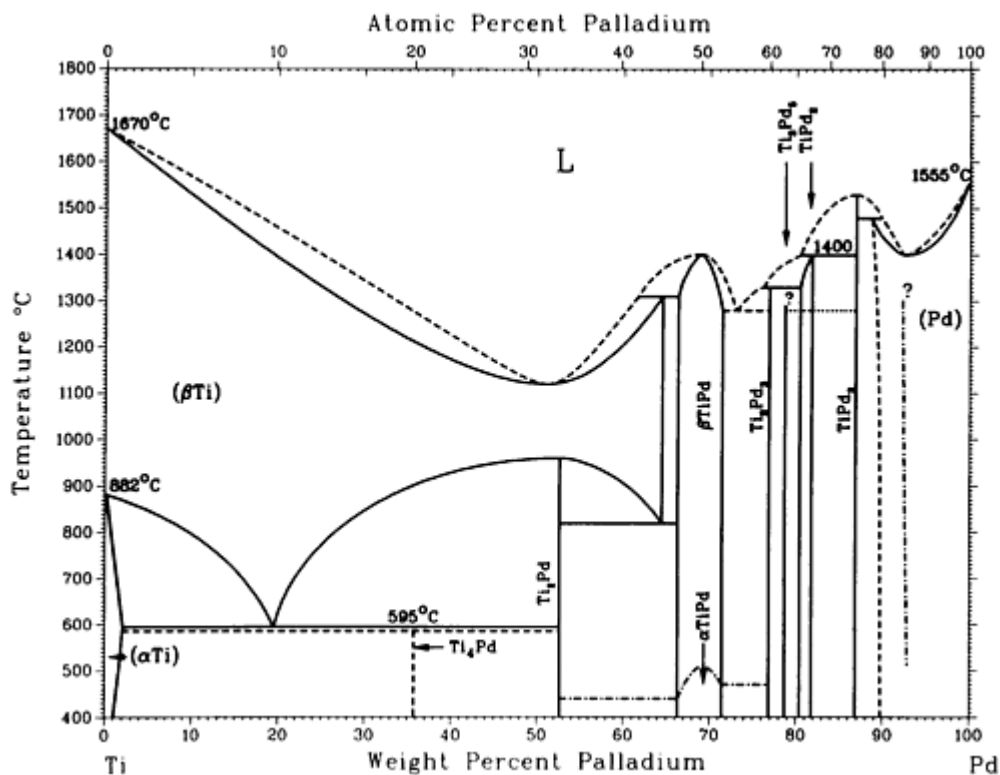

Pd-Ti phase diagram

Pd-Ti crystallographic data

Phase	Composition, wt% Pd	Pearson symbol	Space group
β Ti	0 to 65	<i>cI2</i>	<i>Im$\bar{3}m$</i>
α Ti	0 to ~2	<i>hP2</i>	<i>P6$_3$/mmc</i>
Ti ₄ Pd	36	<i>cP8</i>	<i>Pm$\bar{3}n$</i>
Ti ₂ Pd	52.6	<i>tI6</i>	<i>I4/mmm</i>
β TiPd	66 to 72	<i>cP2</i>	<i>Pm$\bar{3}m$</i>
α TiPd	66 to 72	<i>oP4</i>	<i>Pmma</i>
Ti ₂ Pd ₃	77	<i>oC20</i>	<i>Cmcm</i>

Ti ₃ Pd ₅	78.7	<i>tP8</i>	<i>P4/mmm</i>
TiPd ₂	81 to 82	<i>tI6</i>	<i>I4/mmm</i>
TiPd ₂	81 to 82	(a)	...
TiPd ₃	87	<i>hP16</i>	<i>P6₃/mmc</i>
$\gamma^{(b)}$	87 to 92	<i>cP4</i>	<i>P4/mmm</i>
(Pd)	93 to 100	<i>cF4</i>	<i>Fm$\bar{3}m$</i>

(a) Orthorhombic distortion of MoSi₂.

(b) Possibly an ordered metastable phase. The dot-dash lines show the observed limits of ordering.

Pd-Tl (Palladium - Thallium)

H. Okamoto, 1990

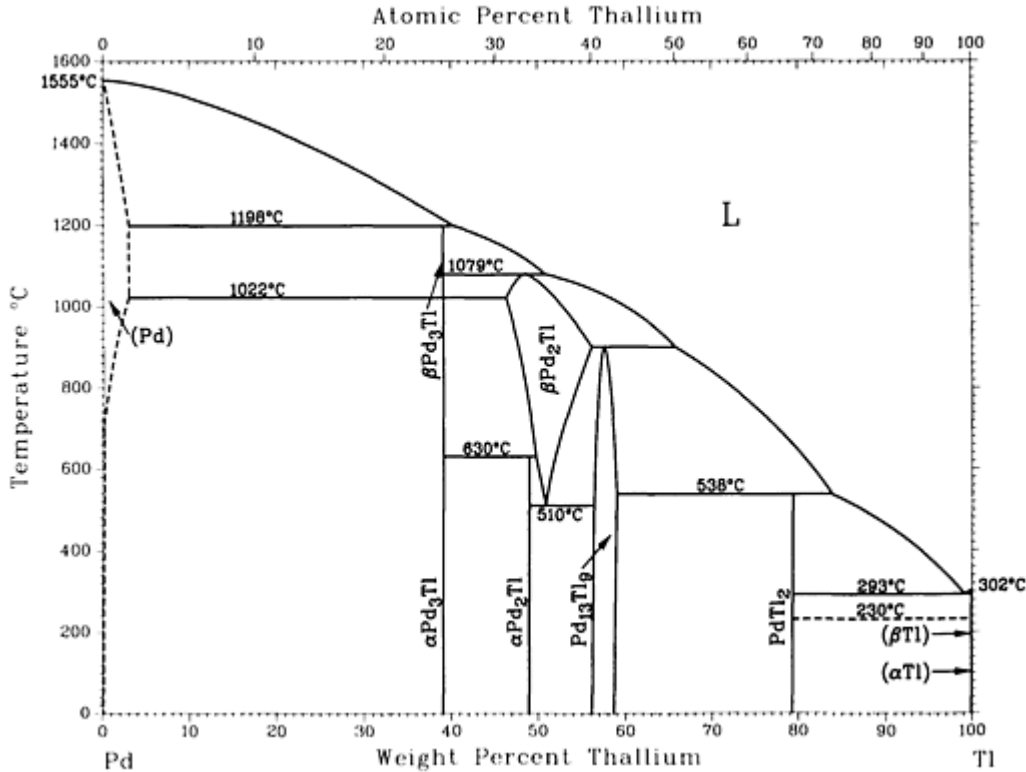

Pd-Tl phase diagram

Pd-Tl crystallographic data

Phase	Composition, wt% Tl	Pearson symbol	Space group
(Pd)	0	<i>cF4</i>	<i>Fm$\bar{3}m$</i>
$\beta_{\text{Pd}_3\text{Tl}}$	39	<i>tI8</i>	<i>I4/mmm</i>
$\alpha_{\text{Pd}_3\text{Tl}}$	39	<i>tI16</i>	<i>I4/mmm</i>
$\beta_{\text{Pd}_2\text{Tl}}$	45 to 56	<i>hP6</i>	<i>P6$_3$/mmc</i>
$\alpha_{\text{Pd}_2\text{Tl}}$	48.9	<i>oP12</i>	<i>Pnma</i>
$\text{Pd}_{13}\text{Tl}_9$	56 to 59	<i>hP20</i>	<i>P$\bar{3}1c$</i>
PdTl_2	79.4	<i>tI12</i>	<i>I4/mcm</i>
(β_{Tl})	100	<i>cI2</i>	<i>Im$\bar{3}m$</i>
(α_{Tl})	100	<i>hP2</i>	<i>P6$_3$/mmc</i>

Pd-U (Palladium - Uranium)

H. Okamoto, 1992

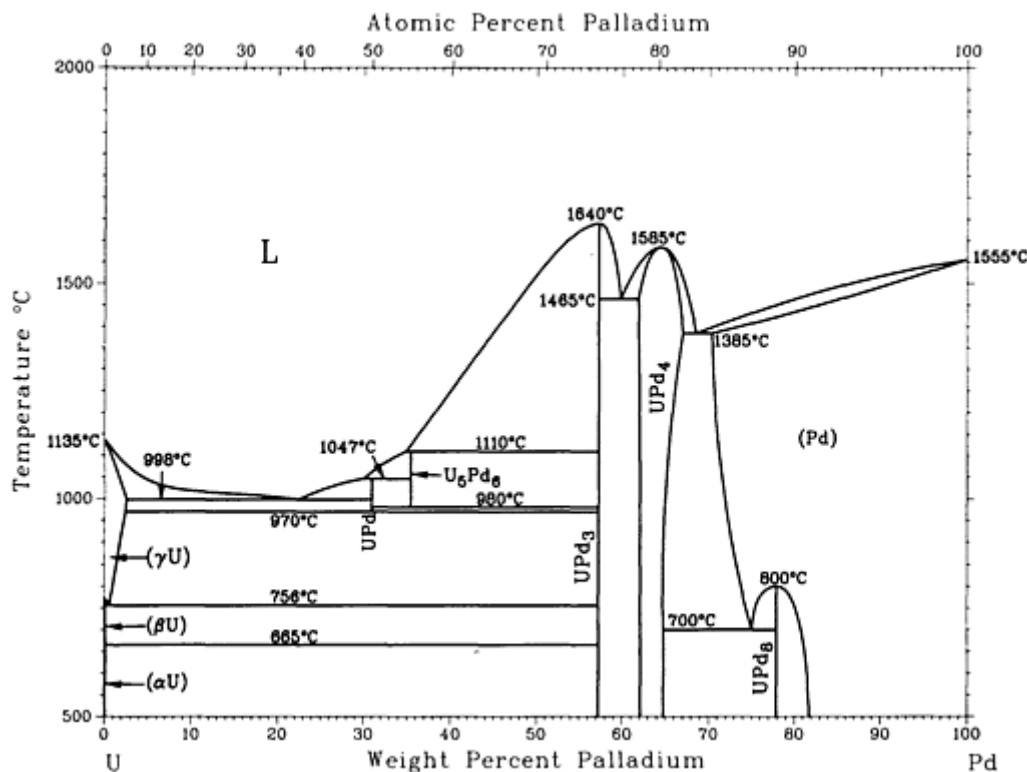

Pd-U phase diagram

Pd-U crystallographic data

Phase	Composition, wt% Pd	Pearson symbol	Space group
(γU)	0 to 2	<i>cI2</i>	<i>Im</i> $\bar{3}m$
(βU)	0	<i>tP30</i>	<i>P4</i> ₂ / <i>mmm</i>
(αU)	0	<i>oC4</i>	<i>Cmcm</i>
UPd	30.9
U ₃ Pd ₆	34.9
UPd ₃	57	<i>hP16</i>	<i>P6</i> ₃ / <i>mmc</i>
UPd ₄	61 to 66	<i>cP4</i>	<i>Pm</i> $\bar{3}m$

UPd ₈	78.2
(Pd)	70 to 100	<i>cF4</i>	<i>Fm</i> $\bar{3}m$

Pd-V (Palladium - Vanadium)

J.F. Smith, 1989

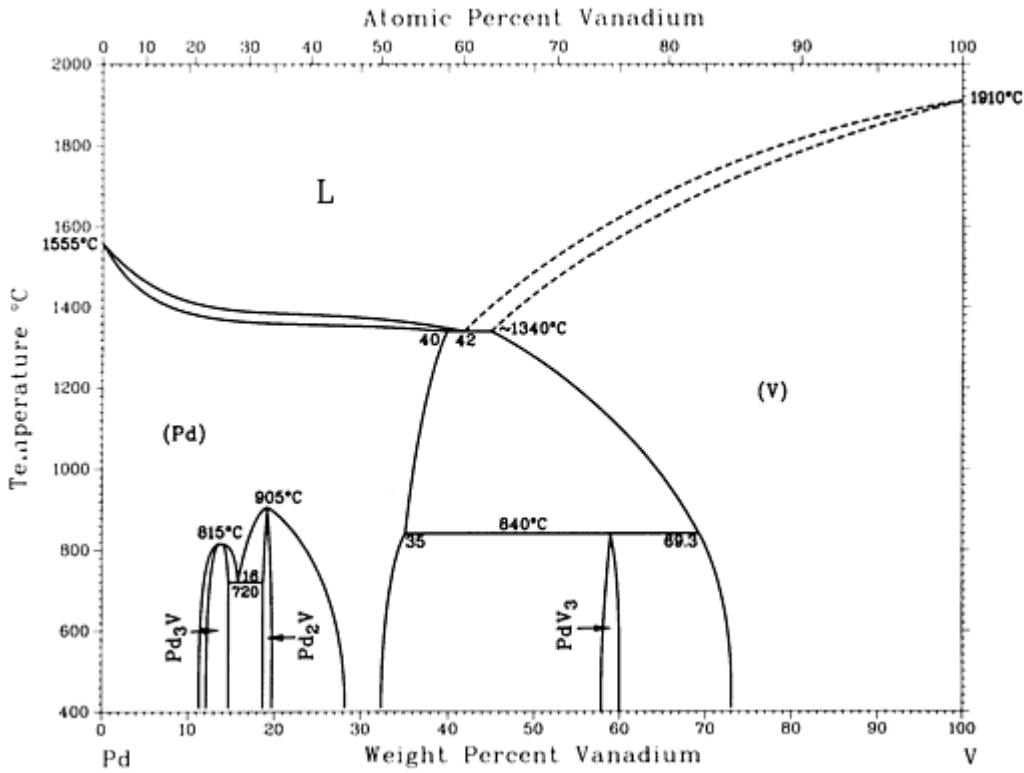

Pd-V phase diagram

Pd-V crystallographic data

Phase	Composition, wt% V	Pearson symbol	Space group
(Pd)	0 to 40	<i>cF4</i>	<i>Fm</i> $\bar{3}m$
Pd ₃ V	~14	<i>tI8</i>	<i>I4/mmm</i>
Pd ₂ V	~19.3	<i>oI6</i>	<i>Immm</i>
PdV ₃	~59	<i>cP8</i>	<i>Pm</i> $\bar{3}n$
(V)	~44.4 to 100	<i>cI2</i>	<i>Im</i> $\bar{3}m$

Pd-W (Palladium - Tungsten)

S.V. Nagender Naidu and P. Rama Rao, 1991

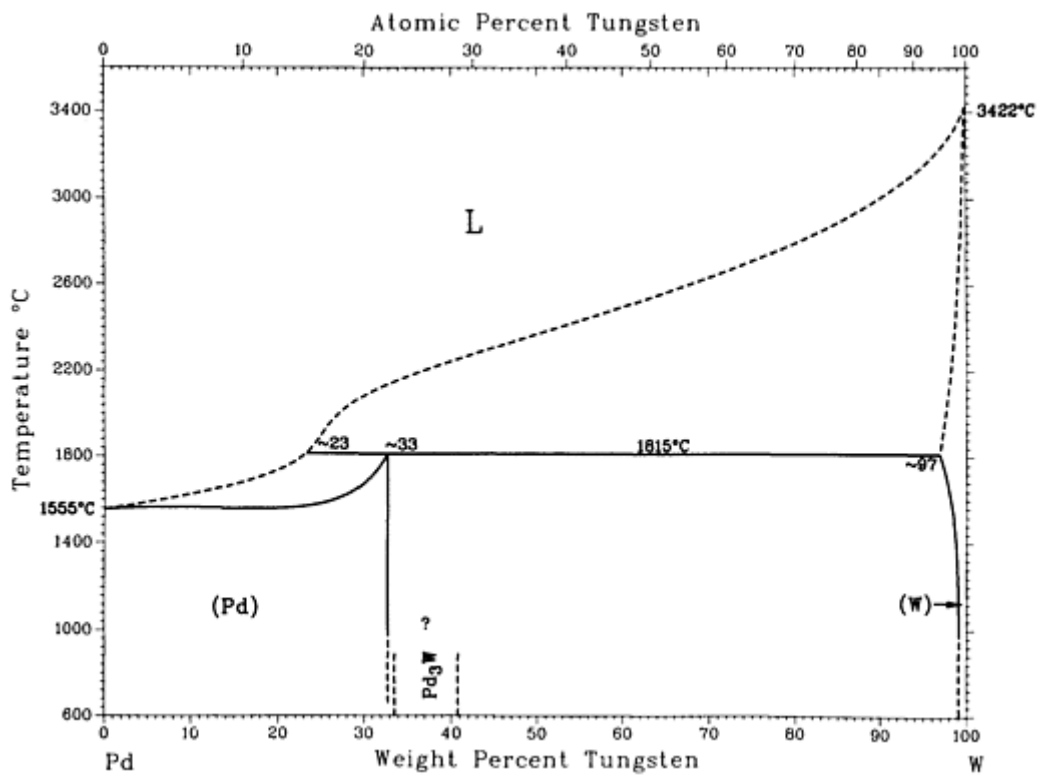

Pd-W phase diagram

Pd-W crystallographic data

Phase	Composition, wt% W	Pearson symbol	Space group
(Pd)	0 to 33	<i>cF4</i>	<i>Fm</i> $\bar{3}m$
(W)	~97 to 100	<i>cI2</i>	<i>Im</i> $\bar{3}m$

Pd-Y (Palladium - Yttrium)

H. Okamoto, 1990

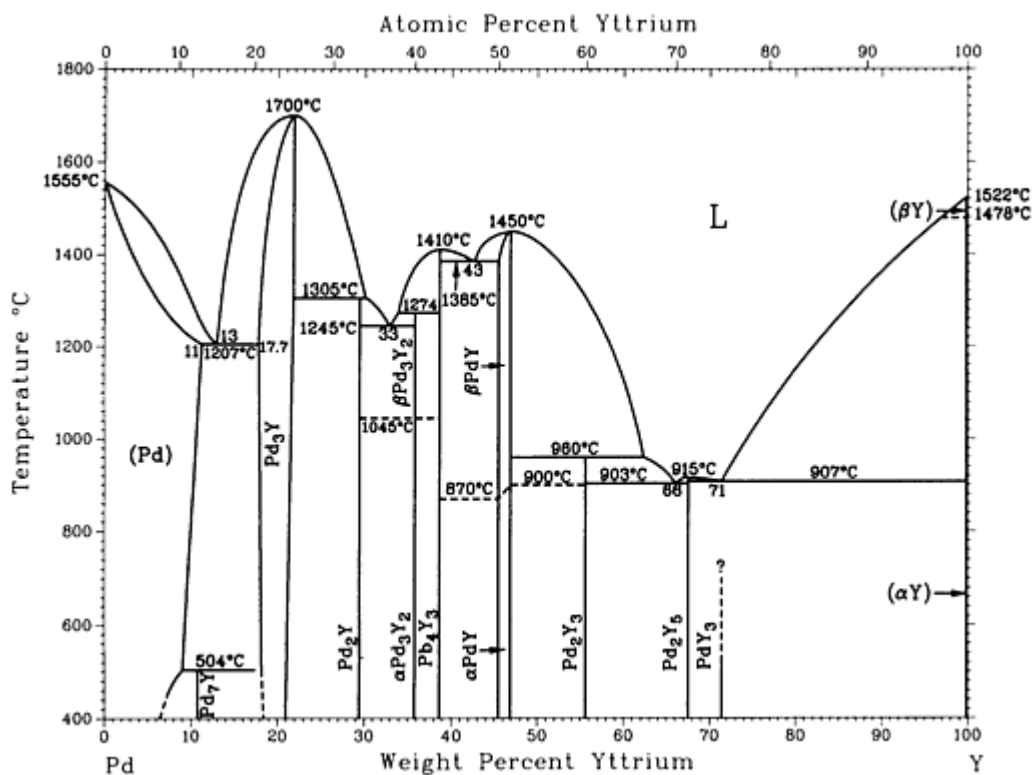

Pd-Y phase diagram

Pd-Y crystallographic data

Phase	Composition, wt% Y	Pearson symbol	Space group
(Pd)	0 to 11	<i>cF4</i>	<i>Fm</i> $\bar{3}m$
Pd ₇ Y	10.7	<i>c**</i>	...
Pd ₃ Y	17.7 to 22	<i>cP4</i>	<i>Pm</i> $\bar{3}m$
Pd ₂ Y	29.4
βPd ₃ Y ₂	36
αPd ₃ Y ₂	36
Pd ₄ Y ₃	38.6	<i>hR14</i>	<i>R</i> $\bar{3}$

β_{PdY}	45.5 to ~ 47
α_{PdY}	45.5 to ~ 47
Pd_2Y_3	56	$hR15$	$R\bar{3}$
Pd_2Y_5	67.6	$cF144$	$Fd\bar{3}m$
PdY_3	72	$oP16$	$Pnma$
(β_{Y})	100	$cI2$	$Im\bar{3}m$
(α_{Y})	100	$hP2$	$P6_3/mmc$

Pd-Yb (Palladium - Ytterbium)

A. Iandelli and A. Palenzona, 1973

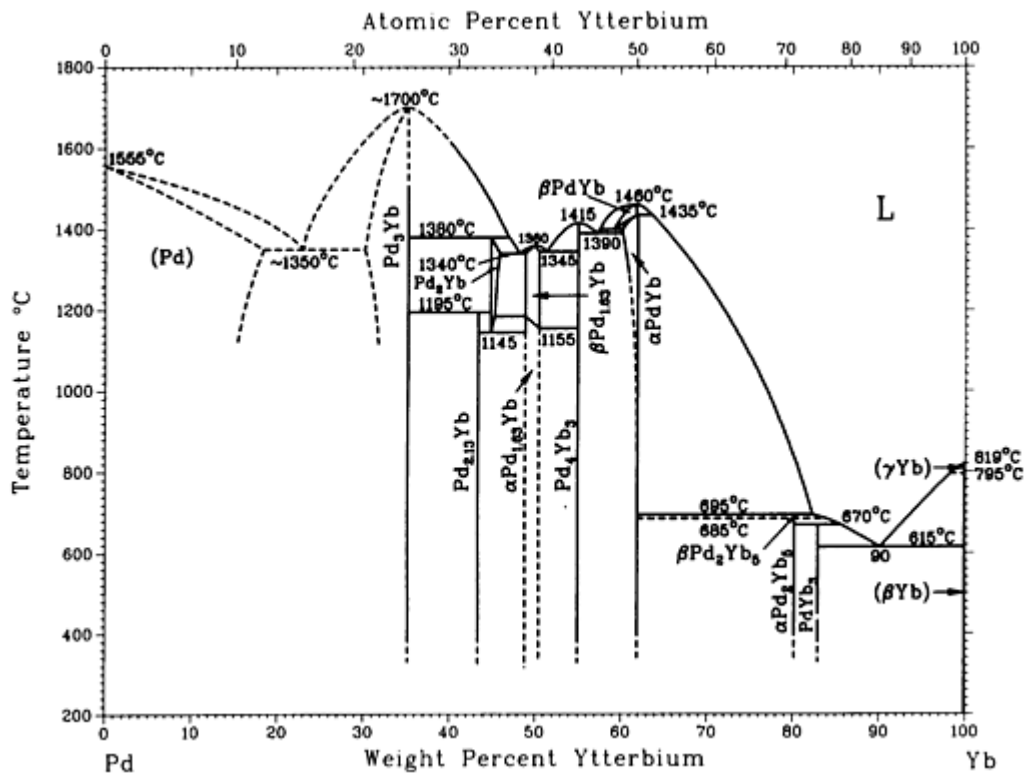

Pd-Yb phase diagram

Pd-Yb crystallographic data

Phase	Composition, wt% Yb	Pearson symbol	Space group
(Pd)	0 to 18	<i>cF4</i>	<i>Fm</i> $\bar{3}m$
Pd ₃ Yb	30 to 35	<i>cP4</i>	<i>Pm</i> $\bar{3}m$
Pd _{2.13} Yb	43
Pd ₂ Yb	44.8 to 46.1
β Pd _{1.63} Yb	49 to 50.4
α Pd _{1.63} Yb	49 to 50.4
Pd ₄ Yb ₃	55	<i>hR14</i>	<i>R</i> $\bar{3}$
β PdYb	59 to ~61.9
α PdYb	60 to 61.9	<i>cP2</i>	<i>Pm</i> $\bar{3}m$
β Pd ₂ Yb ₅	~80.2
α Pd ₂ Yb ₅	~80.2
PdYb ₃	83
(γ Yb)	100	<i>cI2</i>	<i>Im</i> $\bar{3}m$
(β Yb)	100	<i>cF4</i>	<i>Fm</i> $\bar{3}m$

Pd-Zn (Palladium - Zinc)

H. Okamoto, 1990

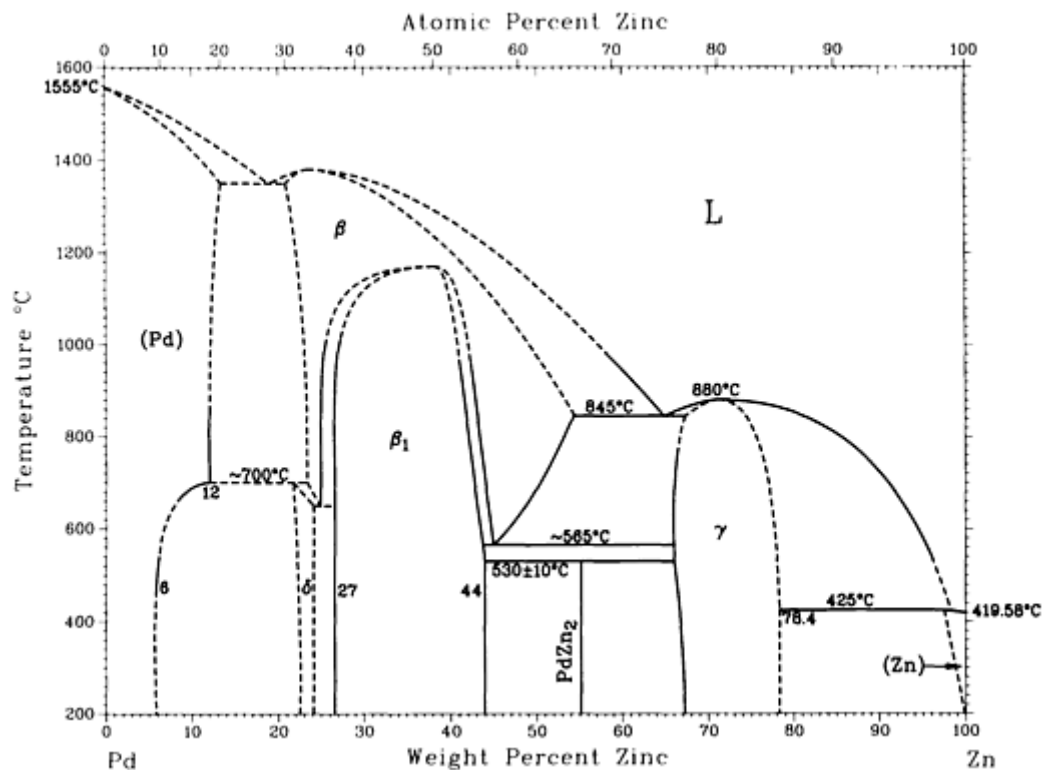

Pd-Zn phase diagram

Pd-Zn crystallographic data

Phase	Composition, wt% Zn	Pearson symbol	Space group
(Pd)	0 to 13	<i>cF4</i>	<i>Fm$\bar{3}m$</i>
δ	~23	<i>oP12</i>	<i>Pnma</i>
β	21 to 53	<i>cP2</i>	<i>Pm$\bar{3}m$</i>
β_1	27 to 44	<i>tP4</i>	<i>P4/mmm</i>
PdZn ₂	55.2	<i>oC48</i>	<i>Cmmm</i>
γ	66 to 78.4	<i>cI52</i>	<i>I$\bar{4}3m$</i>
(Zn)	? to 100	<i>hP2</i>	<i>P6₃/mmc</i>

Introduction

THIS ARTICLE includes systems where praseodymium is the first-named element in the binary pair. Additional binary systems that include praseodymium are provided in the following locations in this Volume:

- “Ag-Pr (Silver - Praseodymium)” in the article “Ag (Silver) Binary Alloy Phase Diagrams.”
- “Al-Pr (Aluminum - Praseodymium)” in the article “Al (Aluminum) Binary Alloy Phase Diagrams.”
- “Au-Pr (Gold - Praseodymium)” in the article “Au (Gold) Binary Alloy Phase Diagrams.”
- “C-Pr (Carbon - Praseodymium)” in the article “C (Carbon) Binary Alloy Phase Diagrams.”
- “Co-Pr (Cobalt - Praseodymium)” in the article “Co (Cobalt) Binary Alloy Phase Diagrams.”
- “Ga-Pr (Gallium - Praseodymium)” in the article “Ga (Gallium) Binary Alloy Phase Diagrams.”
- “Ge-Pr (Germanium - Praseodymium)” in the article “Ge (Germanium) Binary Alloy Phase Diagrams.”
- “In-Pr (Indium - Praseodymium)” in the article “In (Indium) Binary Alloy Phase Diagrams.”
- “Mn-Pr (Manganese - Praseodymium)” in the article “Mn (Manganese) Binary Alloy Phase Diagrams.”
- “Ni-Pr (Nickel - Praseodymium)” in the article “Ni (Nickel) Binary Alloy Phase Diagrams.”
- “O-Pr (Oxygen - Praseodymium)” in the article “O (Oxygen) Binary Alloy Phase Diagrams.”
- “P-Pr (Phosphorus - Praseodymium)” in the article “P (Phosphorous) Binary Alloy Phase Diagrams.”
- “Pb-Pr (Lead - Praseodymium)” in the article “Pb (Lead) Binary Alloy Phase Diagrams.”

Pr-Sb (Praseodymium - Antimony)

H. Okamoto, 1990

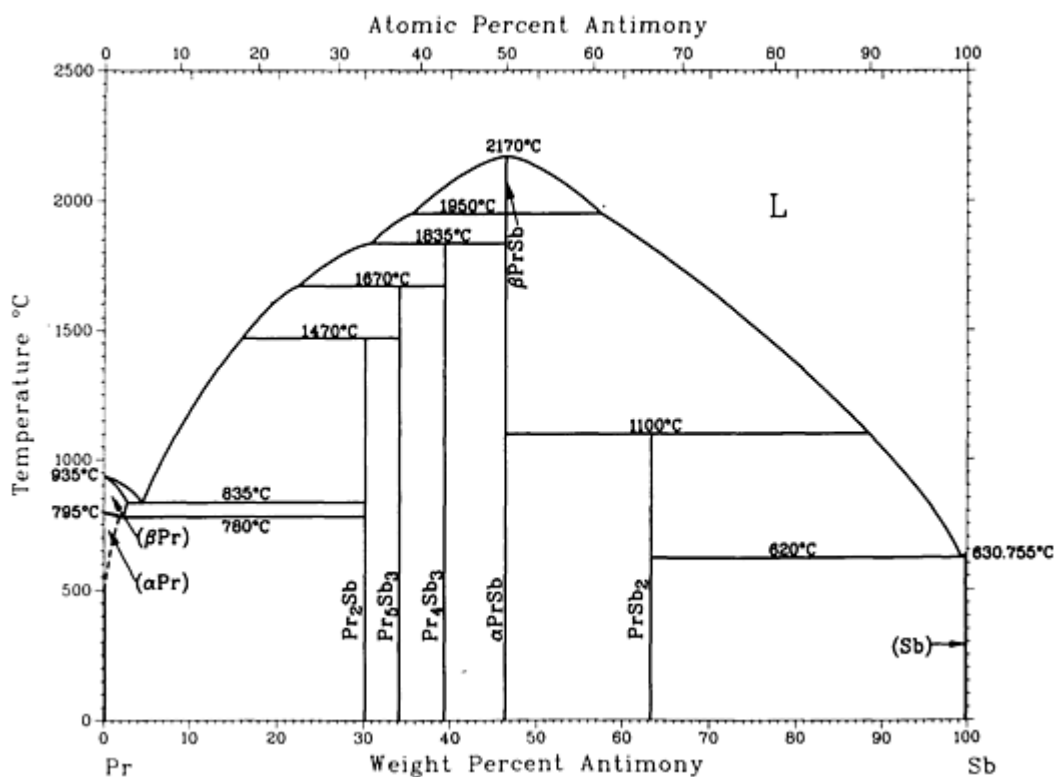

Pr-Sb phase diagram

Pr-Sb crystallographic data

Phase	Composition, wt% Sb	Pearson symbol	Space group
(β_{Pr})	0	<i>cI2</i>	<i>Im\bar{3}m</i>
(α_{Pr})	0	<i>hP4</i>	<i>P6_3/mmc</i>
Pr_2Sb	30.1	<i>tI12</i>	<i>I4/mmm</i>
Pr_5Sb_3	34.1	<i>hP16</i>	<i>P6_3/mcm</i>
Pr_4Sb_3	39.4	<i>cI28</i>	<i>I\bar{4}3d</i>
β_{PrSb}	46.4
α_{PrSb}	46.4	<i>cF8</i>	<i>Fm\bar{3}m</i>
PrSb_2	63.4	<i>oC24</i>	<i>Cmca</i>
(Sb)	100	<i>hR2</i>	<i>R\bar{3}m</i>

Pr-Se (Praseodymium - Selenium)

E.I. Yarembach, 1970

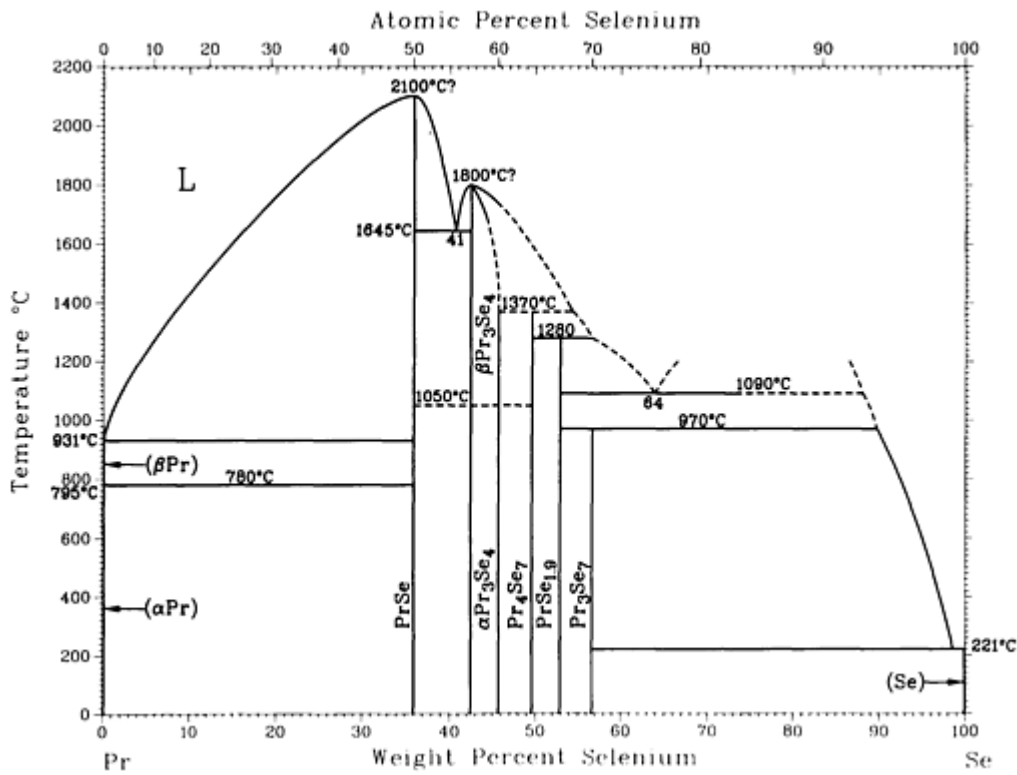

Pr-Se phase diagram

Pr-Se crystallographic data

Phase	Composition, wt% Se	Pearson symbol	Space group
(βPr)	0	<i>cI2</i>	<i>Im</i> $\bar{3}m$
(αPr)	0	<i>hP4</i>	<i>P6</i> ₃ / <i>mmc</i>
PrSe	35.9	<i>cF8</i>	<i>Fm</i> $\bar{3}m$
βPr ₃ Se ₄	~42.2 to 46	<i>cI28</i>	<i>I</i> $\bar{4}3d$
αPr ₃ Se ₄	~42.2 to 46	<i>tI28</i>	<i>I4/mcm</i>
Pr ₄ Se ₇	49.5	<i>tP22</i>	<i>P4/mmm</i>
PrSe _{1.9}	~52.9	<i>tP6</i>	<i>P4/mmm</i>

Pr ₃ Se ₇	57
(Se)	100	hP3	P3 ₁ 21

Pr-Si (Praseodymium - Silicon)

H. Okamoto, 1990

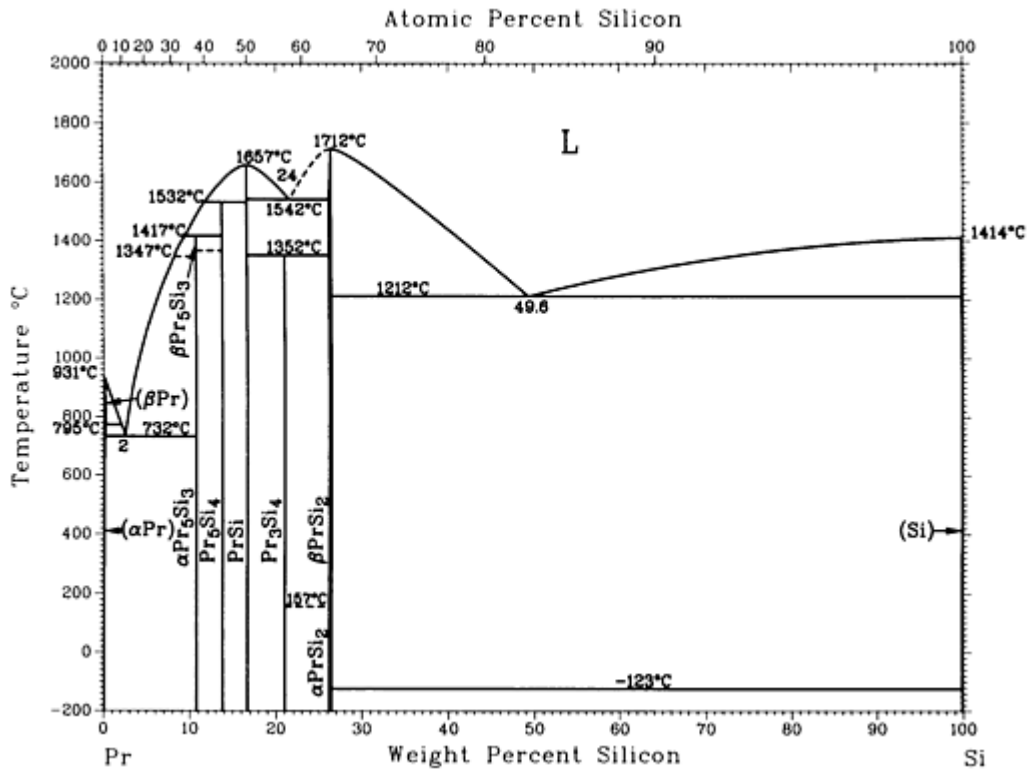

Pr-Si phase diagram

Pr-Si crystallographic data

Phase	Composition, wt% Si	Pearson symbol	Space group
(βPr)	0	cI2	<i>Im</i> $\bar{3}m$
(αPr)	0	hP4	<i>P6</i> ₃ / <i>mmc</i>
βPr ₅ Si ₃	10.7
αPr ₅ Si ₃	10.7	tI32	<i>I4/mcm</i>
Pr ₅ Si ₄	13.7	tP36	<i>P4</i> ₁ 2 ₁ 2

PrSi	16.6	<i>oP8</i>	<i>Pnma</i>
Pr ₃ Si ₄	21.0
β PrSi ₂	26.4	<i>tI12</i>	<i>I4₁/amd</i>
α PrSi ₂	26.4	<i>oI12</i>	<i>Imma</i>
(Si)	100	<i>cF8</i>	<i>Fd$\bar{3}m$</i>

Pr-Sn (Praseodymium - Tin)

H. Okamoto, 1990

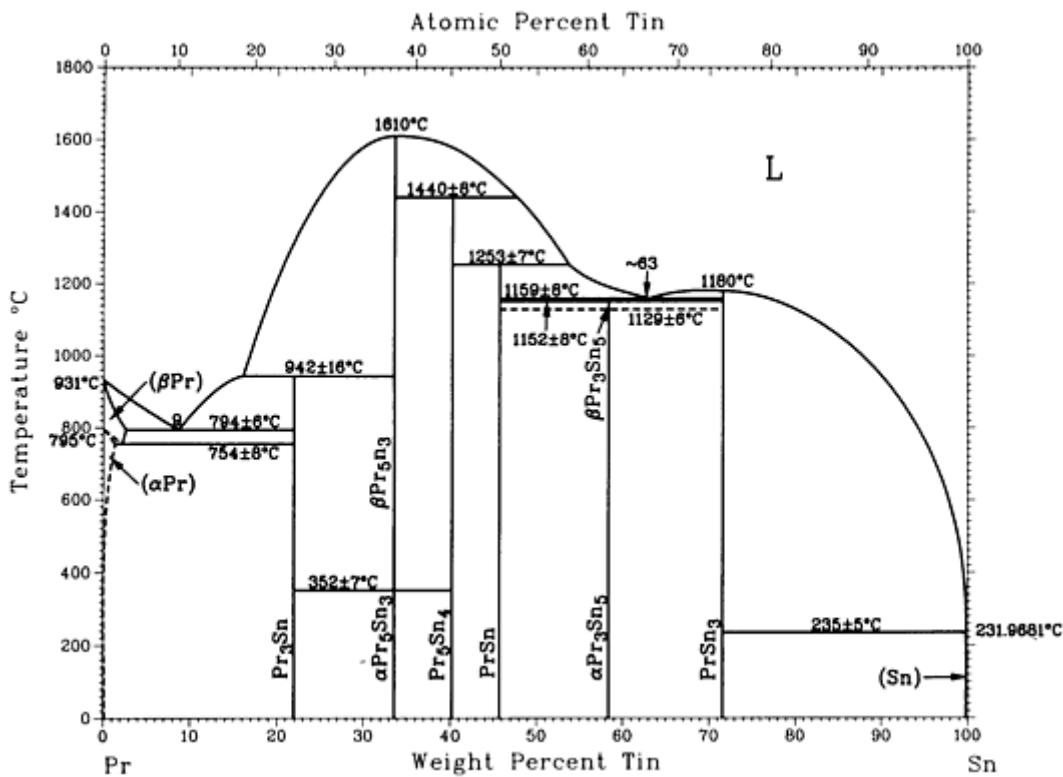

Pr-Sn phase diagram

Pr-Sn crystallographic data

Phase	Composition, wt% Sn	Pearson symbol	Space group
(β Pr)	0 to ~3	<i>cI2</i>	<i>Im$\bar{3}m$</i>
(α Pr)	0 to ~1.3	<i>hP4</i>	<i>P6₃/mmc</i>

Pr_3Sn	22	$cP4$	$Pm\bar{3}m$
$\beta\text{Pr}_5\text{Sn}_3$	33.6	$hP16$	$P6_3/mcm$
$\alpha\text{Pr}_5\text{Sn}_3$	33.6	$tI32$	$I4/mcm$
Pr_5Sn_4	40.2	$oP36$	$Pnma$
PrSn	45.7
$\beta\text{Pr}_3\text{Sn}_5$	58.4
$\alpha\text{Pr}_3\text{Sn}_5$	58.4
PrSn_3	72	$cP4$	$Pm\bar{3}m$
(βSn)	100	$tI4$	$I4_1/amd$
(αSn)	100	$cF8$	$Fd\bar{3}m$

Pr-Te (Praseodymium - Tellurium)

E.I. Yarembach, 1970

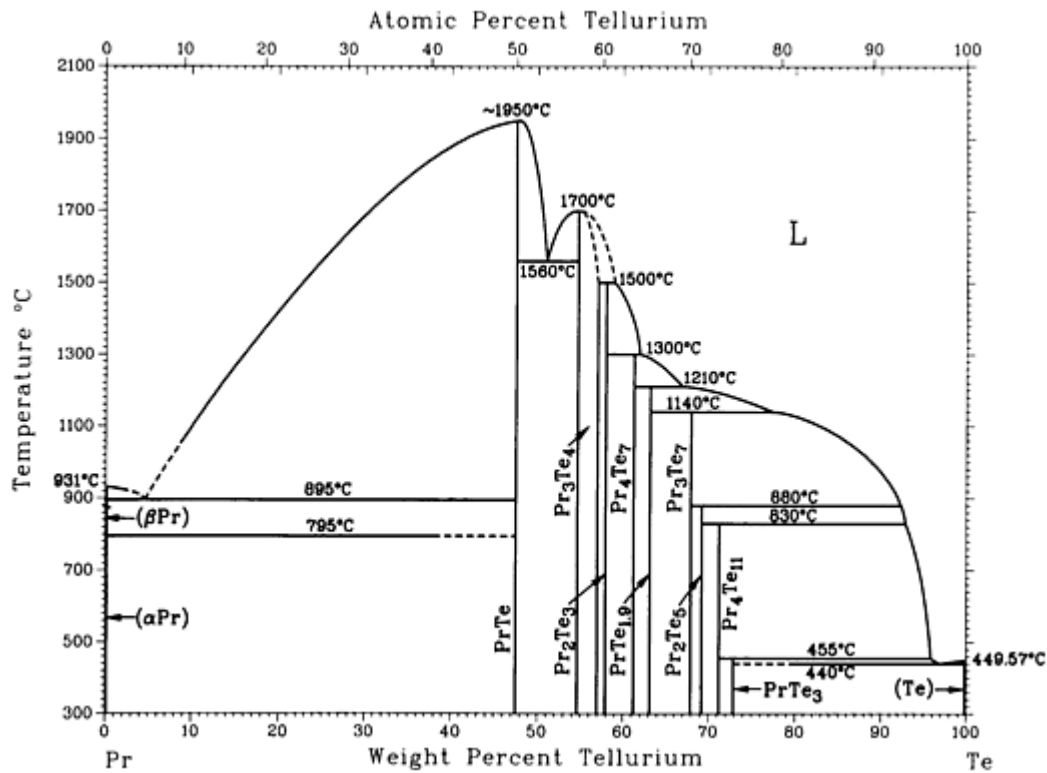

Pr-Te phase diagram

Pr-Te crystallographic data

Phase	Composition, wt% Te	Pearson symbol	Space group
(β Pr)	0	<i>cI2</i>	<i>Im$\bar{3}m$</i>
(α Pr)	0	<i>hP4</i>	<i>P6$_3$/mmc</i>
PrTe	47.5	<i>cF8</i>	<i>Fm$\bar{3}m$</i>
Pr ₃ Te ₄	54.7 to ~57	<i>cI28</i>	<i>I$\bar{4}3d$</i>
Pr ₂ Te ₃	58
Pr ₄ Te ₇	~61.3
PrTe _{1.9}	~63.2

Pr ₃ Te ₇	68
Pr ₂ Te ₅	69.3	<i>oC28</i>	<i>Cmcm</i>
Pr ₄ Te ₁₁	71.3
PrTe ₃	73	<i>tP16</i>	<i>P4₂/n</i>
(Te)	100	<i>hP3</i>	<i>P3₁21</i>

Pr-Tl (Praseodymium - Thallium)

S. Delfino, A. Saccone, A. Palenzona, and R. Ferro, unpublished

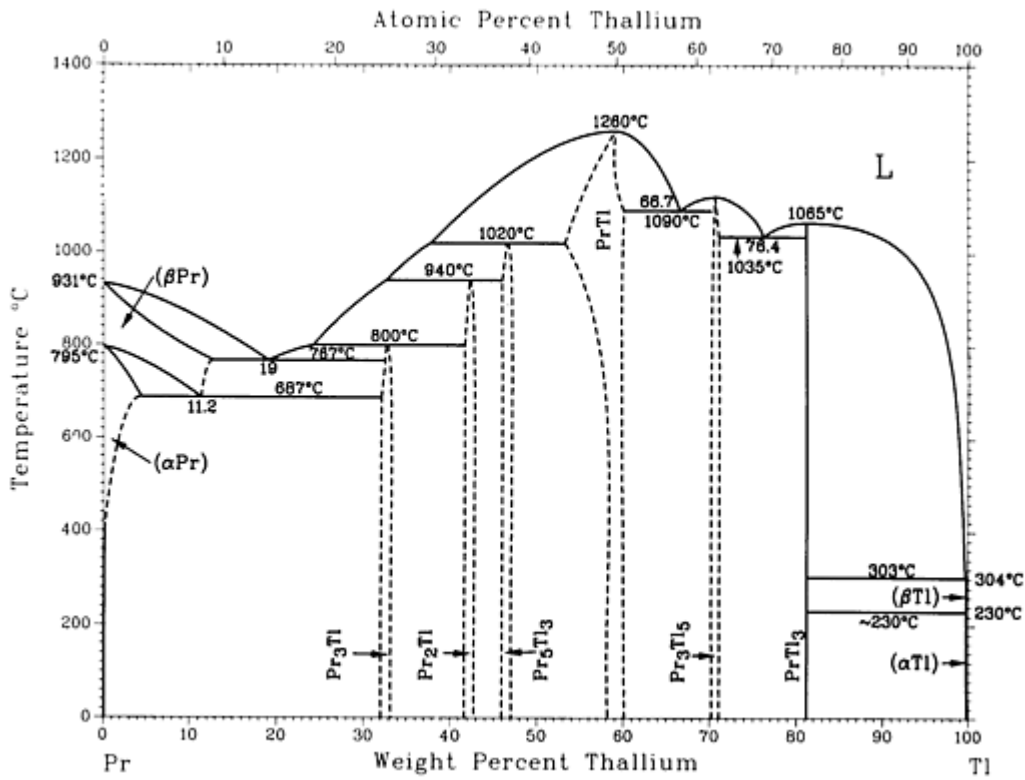

Pr-Tl phase diagram

Pr-Tl crystallographic data

Phase	Composition, wt% Tl	Pearson symbol	Space group
(βPr)	0 to 12.5	<i>cI2</i>	<i>Im$\bar{3}m$</i>
(αPr)	0 to 3.6	<i>hP4</i>	<i>P6₃/mmc</i>

$\text{Pr}_3\text{Tl}^{(a)}$	~ 32.0 to ~ 33.2 ~ 33	$cP4$ $cF4$	$Pm\bar{3}m$ $Fm\bar{3}m$
Pr_2Tl	~ 42 to ~ 43	$hP6$	$P6_3/mmc$
Pr_5Tl_3	~ 46 to ~ 47	$tI32$	$I4/mcm$
$\text{PrTl}^{(b)}$	~ 53 to ~ 60	$cP2$ or $cI2$	$Pm\bar{3}m$ $Im\bar{3}m$
$\text{PrTl}^{(c)}$	~ 53 to ~ 60	$tP2$	$P4/mmm$
Pr_3Tl_5	~ 70 to ~ 71	$oC32$	$Cmcm$
PrTl_3	81	$cP4$	$Pm\bar{3}m$
(β_{Tl})	100	$cI2$	$Im\bar{3}m$
(α_{Tl})	100	$hP2$	$P6_3/mmc$

- (a) A $cP4$ - $cF4$ order-disorder transformation in this phase has been suggested.
- (b) Cubic structure presumed to be room- and higher-temperature phases.
- (c) Tetragonal structure presumed to be lower-temperature phase

Pr-Zn (Praseodymium - Zinc)

J.T. Mason and P. Chiotti, 1970

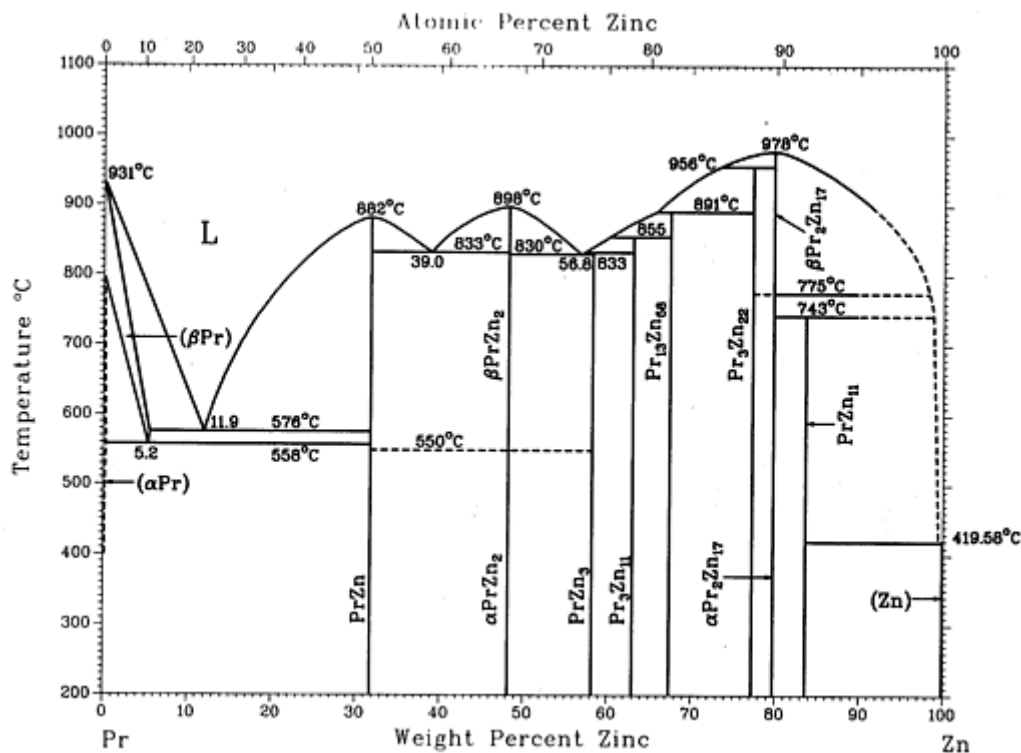

Pr-Zn phase diagram

Pr-Zn crystallographic data

Phase	Composition, wt% Zn	Pearson symbol	Space group
(β _{Pr})	0 to 5	<i>cI2</i>	<i>Im$\bar{3}m$</i>
(α _{Pr})	0 to 0.2	<i>hP4</i>	<i>P6₃/mmc</i>
PrZn	31.7	<i>cP2^(a)</i>	<i>Pm$\bar{3}m$</i>
β _{PrZn₂}	48.2
α _{PrZn₂}	48.2	<i>oI12</i>	<i>Imma</i>
PrZn ₃	58	<i>oP16</i>	<i>Pnma</i>
Pr ₃ Zn ₁₁	62.9	<i>oI28</i>	<i>Immm</i>

$\text{Pr}_{13}\text{Zn}_{58}$	67.3	<i>hP142</i>	<i>P6₃/mc</i>
$\text{Pr}_3\text{Zn}_{22}$	77	<i>tI100</i>	<i>I4₁/amd</i>
$\beta\text{Pr}_2\text{Zn}_{17}$	79.6	<i>hR19</i>	<i>R$\bar{3}m$</i>
$\alpha\text{Pr}_2\text{Zn}_{17}$	79.6	<i>hP38</i>	<i>P6₃/mmc</i>
PrZn_{11}	83.5	<i>tI48</i>	<i>I4₁/amd</i>
(Zn)	100	<i>hP2</i>	<i>P6₃/mmc</i>

(a) *t*** below 45 K

Pt (Platinum) Binary Alloy Phase Diagrams

Introduction

THIS ARTICLE includes systems where platinum is the first-named element in the binary pair. Additional binary systems that include platinum are provided in the following locations in this Volume:

- “Ag-Pt (Silver - Platinum)” in the article “Ag (Silver) Binary Alloy Phase Diagrams.”
- “Al-Pt (Aluminum - Platinum)” in the article “Al (Aluminum) Binary Alloy Phase Diagrams.”
- “Au-Pt (Gold - Platinum)” in the article “Au (Gold) Binary Alloy Phase Diagrams.”
- “B-Pt (Boron - Platinum)” in the article “B (Boron) Binary Alloy Phase Diagrams.”
- “Bi-Pt (Bismuth - Platinum)” in the article “Bi (Bismuth) Binary Alloy Phase Diagrams.”
- “Ca-Pt (Calcium - Platinum)” in the article “Ca (Calcium) Binary Alloy Phase Diagrams.”
- “Co-Pt (Cobalt - Platinum)” in the article “Co (Cobalt) Binary Alloy Phase Diagrams.”
- “Cr-Pt (Chromium - Platinum)” in the article “Cr (Chromium) Binary Alloy Phase Diagrams.”
- “Cu-Pt (Copper - Platinum)” in the article “Cu (Copper) Binary Alloy Phase Diagrams.”
- “Er-Pt (Erbium - Platinum)” in the article “Er (Erbium) Binary Alloy Phase Diagrams.”
- “Eu-Pt (Europium - Platinum)” in the article “Eu (Europium) Binary Alloy Phase Diagrams.”
- “Ga-Pt (Gallium - Platinum)” in the article “Ga (Gallium) Binary Alloy Phase Diagrams.”
- “Ge-Pt (Germanium - Platinum)” in the article “Ge (Germanium) Binary Alloy Phase Diagrams.”
- “In-Pt (Indium - Platinum)” in the article “In (Indium) Binary Alloy Phase Diagrams.”
- “Ir-Pt (Iridium - Platinum)” in the article “Ir (Iridium) Binary Alloy Phase Diagrams.”
- “Mo-Pt (Molybdenum - Platinum)” in the article “Mo (Molybdenum) Binary Alloy Phase Diagrams.”
- “Nb-Pt (Niobium - Platinum)” in the article “Nb (Niobium) Binary Alloy Phase Diagrams.”
- “Nd-Pt (Neodymium - Platinum)” in the article “Nd (Neodymium) Binary Alloy Phase Diagrams.”
- “Ni-Pt (Nickel - Platinum)” in the article “Ni (Nickel) Binary Alloy Phase Diagrams.”
- “Os-Pt (Osmium - Platinum)” in the article “Os (Osmium) Binary Alloy Phase Diagrams.”
- “Pb-Pt (Lead - Platinum)” in the article “Pb (Lead) Binary Alloy Phase Diagrams.”
- “Pd-Pt (Palladium - Platinum)” in the article “Pd (Palladium) Binary Alloy Phase Diagrams.”

Pt-Rh (Platinum - Rhodium)

H. Okamoto, 1992

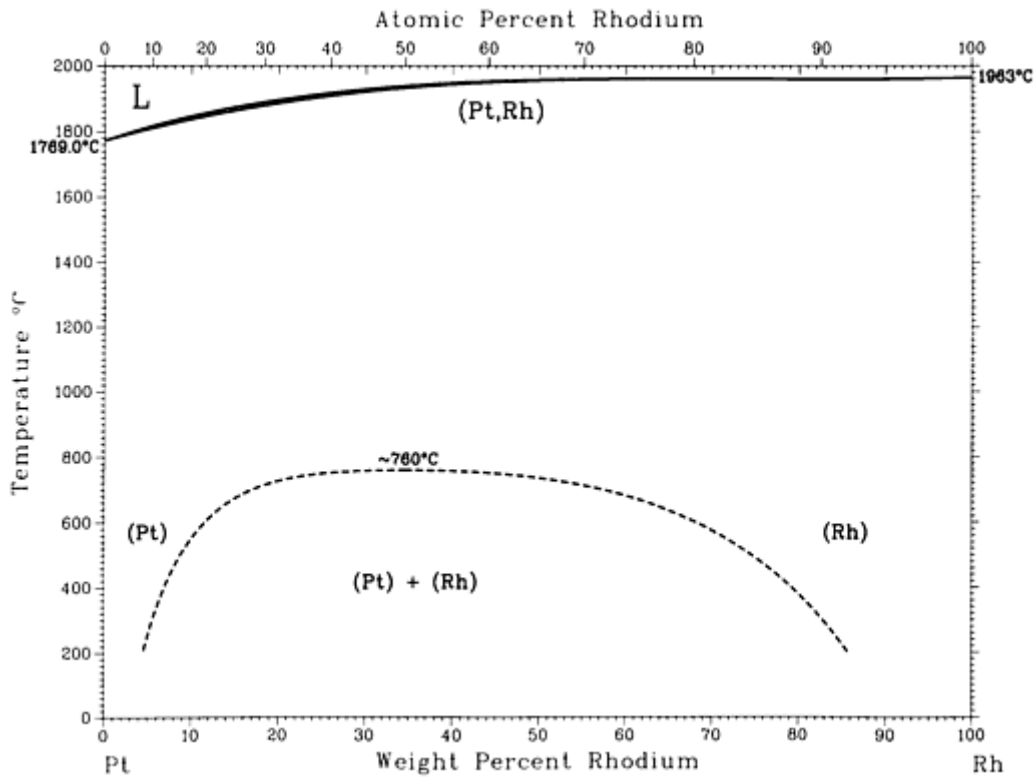

Pt-Rh phase diagram

Pt-Rh crystallographic data

Phase	Composition, wt% Rh	Pearson symbol	Space group
(Pt,Rh)	0 to 100	<i>cF4</i>	<i>Fm</i> $\bar{3}m$

Pt-Si (Platinum - Silicon)

H. Okamoto and L.E. Tanner, 1991

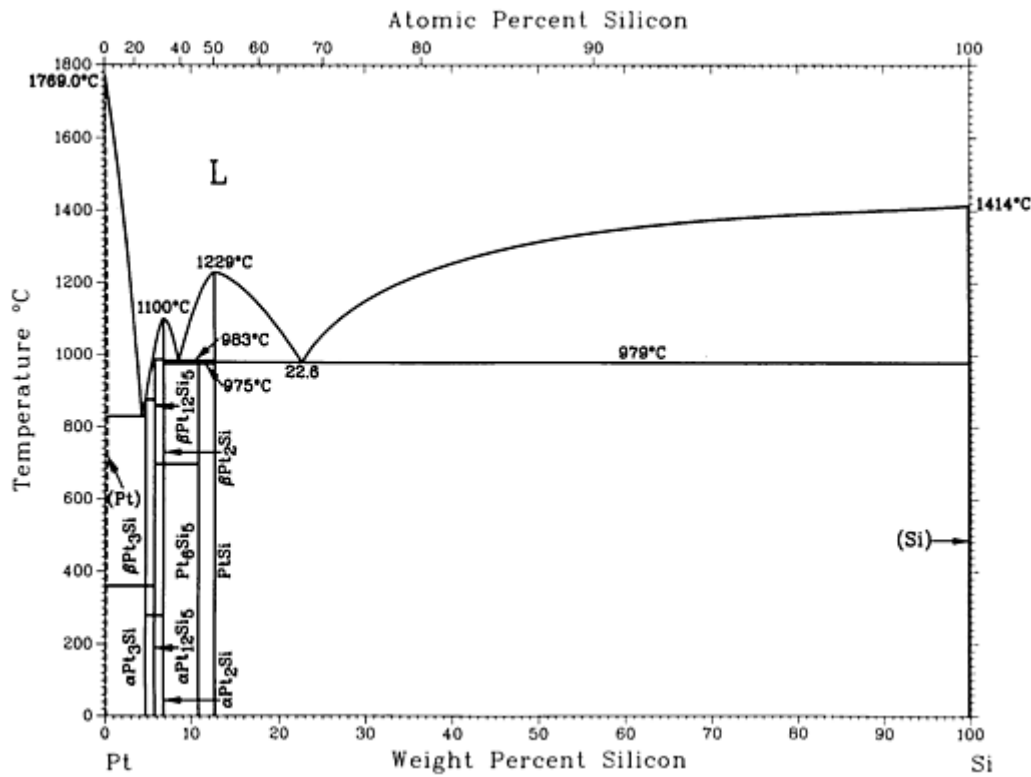

Pt-Si phase diagram

Pt-Si crystallographic data

Phase	Composition, wt% Si	Pearson symbol	Space group
(Pt)	0 to 0.2	<i>cF4</i>	<i>Fm</i> $\bar{3}m$
$\gamma_{\text{Pt}_3\text{Si}^{(a)}}$	5	<i>tI16</i>	<i>I4/mcm</i>
$\beta_{\text{Pt}_3\text{Si}}$	5	<i>oP16</i>	<i>Pnma</i>
$\alpha_{\text{Pt}_3\text{Si}}$	5	<i>mC16</i>	<i>C2/m</i>
$\beta_{\text{Pt}_{12}\text{Si}_5}$	5.7	<i>tI34</i>	<i>I4/m</i>
$\alpha_{\text{Pt}_{12}\text{Si}_5}$	5.7	<i>tP68</i>	<i>P4/n</i>
$\beta_{\text{Pt}_2\text{Si}}$	6.7	<i>hP9</i>	<i>P</i> $\bar{6}2m$

$\alpha\text{Pt}_2\text{Si}$	6.7	<i>tI6</i>	<i>I4/mmm</i>
Pt_6Si_5	10.7	<i>mP22</i>	<i>P2_1/m</i>
PtSi	12.6	<i>oP8</i>	<i>Pnma</i>
$\text{Pt}_2\text{Si}_3^{(b)}$	18	<i>hP10</i>	<i>P6_3/mmc</i>
$\text{Pt}_4\text{Si}_9^{(b)}$	24.4	?	?
(Si)	100	<i>cF8</i>	<i>Fd\bar{3}m</i>

(a) Impurity stabilized.

(b) Metastable

Pt-Sn (Platinum - Tin)

From [Hansen] 6

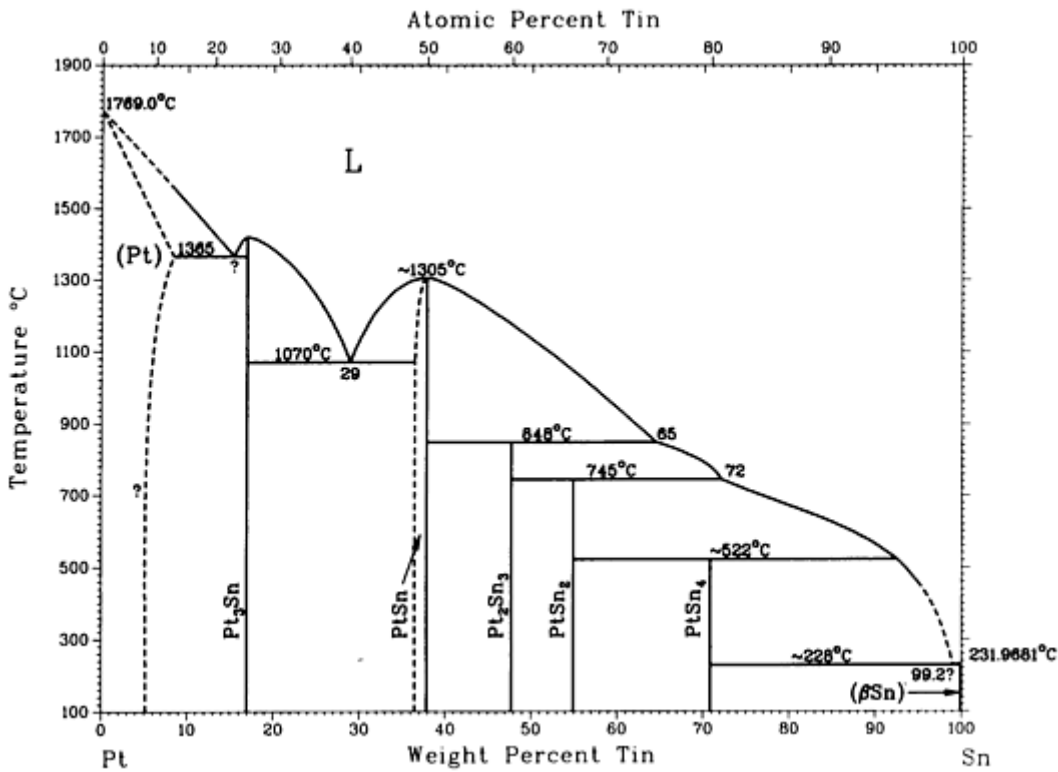

Pt-Sn phase diagram

Pt-Sn crystallographic data

Phase	Composition, wt% Sn	Pearson symbol	Space group
(Pt)	0 to ?	<i>cF4</i>	<i>Fm$\bar{3}m$</i>
Pt ₃ Sn	17	<i>cP4</i>	<i>Pm$\bar{3}m$</i>
PtSn	>36 to 37.8	<i>hP4</i>	<i>P6₃/mmc</i>
Pt ₂ Sn ₃	48	<i>hP10</i>	<i>P6₃/mmc</i>
PtSn ₂	54.9	<i>cF12</i>	<i>Fm$\bar{3}m$</i>
PtSn ₄	71	<i>oC20</i>	<i>Aba2</i>
(β Sn)	100	<i>tI4</i>	<i>I4₁/amd</i>
(α Sn)	100	<i>cF8</i>	<i>Fd$\bar{3}m$</i>

Reference cited in this section

6. [Hansen]: M. Hansen and K. Anderko, *Constitution of Binary Alloys*, McGraw-Hill, New York or General Electric Co., Business Growth Services, Schenectady, New York (1958).

Pt-Te (Platinum - Tellurium)

H. Okamoto, 1990

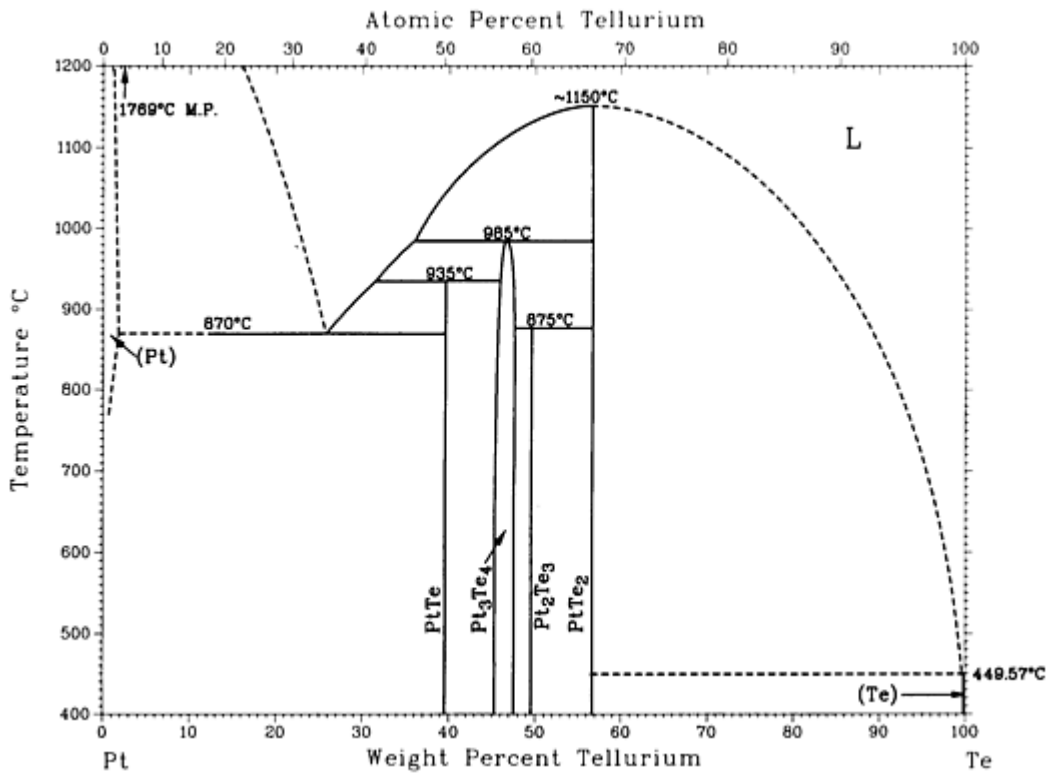

Pt-Te phase diagram

Pt-Te crystallographic data

Phase	Composition, wt% Te	Pearson symbol	Space group
(Pt)	0 to ?	<i>cF4</i>	<i>Fm</i> $\bar{3}m$
PtTe	39.5	<i>mC8</i>	<i>C2/m</i>
Pt ₃ Te ₄	~46.5	<i>mC14</i>	<i>C2/m</i>
Pt ₂ Te ₃	50	<i>mC20</i>	<i>C2/m</i>
PtTe ₂	56.7	<i>hP3</i>	<i>P</i> $\bar{3}m1$
(Te)	100	<i>hP3</i>	<i>P3</i> ₁ 21

Pt-Ti (Platinum - Titanium)

J.L. Murray, 1987

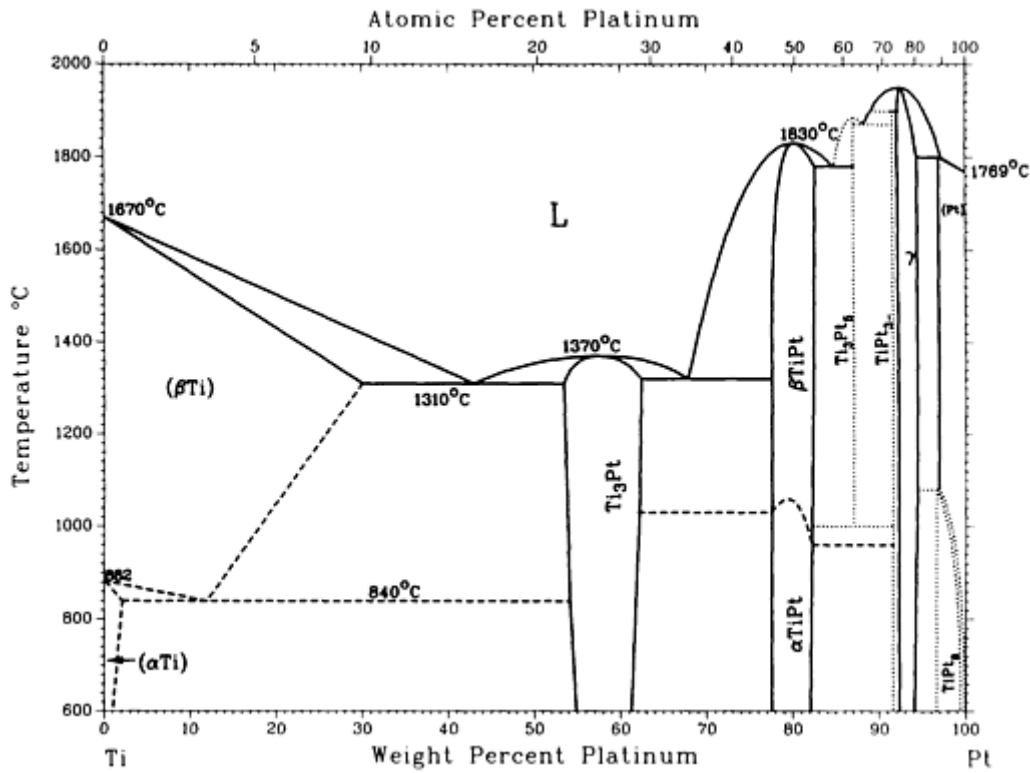

Pt-Ti phase diagram

Pt-Ti crystallographic data

Phase	Composition, wt% Pt	Pearson symbol	Space group
(βTi)	0 to 31	<i>cI2</i>	<i>Im$\bar{3}m$</i>
(αTi)	0 to 2.0	<i>hP2</i>	<i>P6₃/mmc</i>
Ti ₃ Pt	54 to 63	<i>cP8</i>	<i>Pm$\bar{3}n$</i>
βTiPt	78 to 83	<i>oP2</i>	<i>Pmma</i>
αTiPt	78 to 83	<i>oP4</i>	<i>Pmma</i>
Ti ₃ Pt ₅	87.2	<i>oI32</i>	<i>Ibam</i>
TiPt ₃	<92	<i>hP16</i>	<i>P6₃/mmc</i>

γ	92 to 95	<i>tP4</i>	$Pm\bar{3}m$
TiPt ₈	97 to 99.5	<i>tI18</i>	$I4/m$
(Pt)	95 to 100	<i>cF4</i>	$Fm\bar{3}m$

Pt-Tl (Platinum - Thallium)

H. Okamoto, 1990

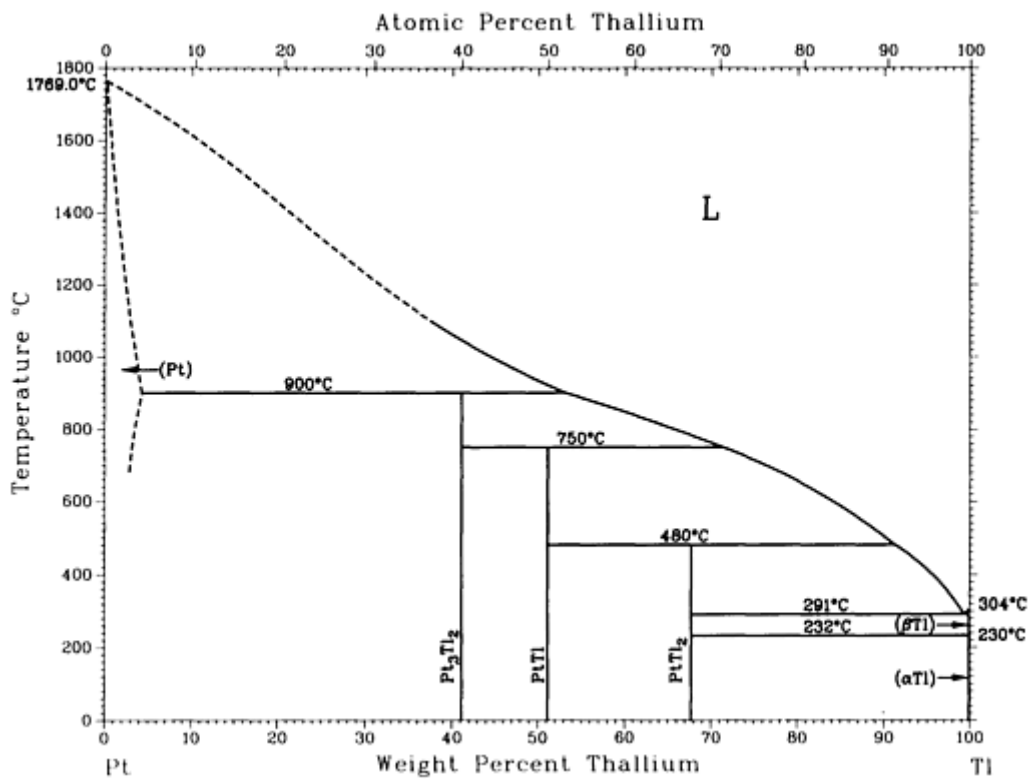

Pt-Tl phase diagram

Pt-Tl crystallographic data

Phase	Composition, wt% Tl	Pearson symbol	Space group
(Pt)	0 to ?	<i>cF4</i>	$Fm\bar{3}m$
Pt ₃ Tl ₂	41	<i>hP20</i>	$P\bar{3}1c$
PtTl	51.2	<i>hP6</i>	$P6/mmm$

PtTi ₂	67.7	<i>tI12</i>	<i>I4/mcm</i>
(βTi)	100	<i>cI2</i>	<i>Im$\bar{3}m$</i>
(αTi)	100	<i>hP2</i>	<i>P6₃/mmc</i>

Pt-U (Platinum - Uranium)

B.A.S. Ross and D.E. Peterson, 1990

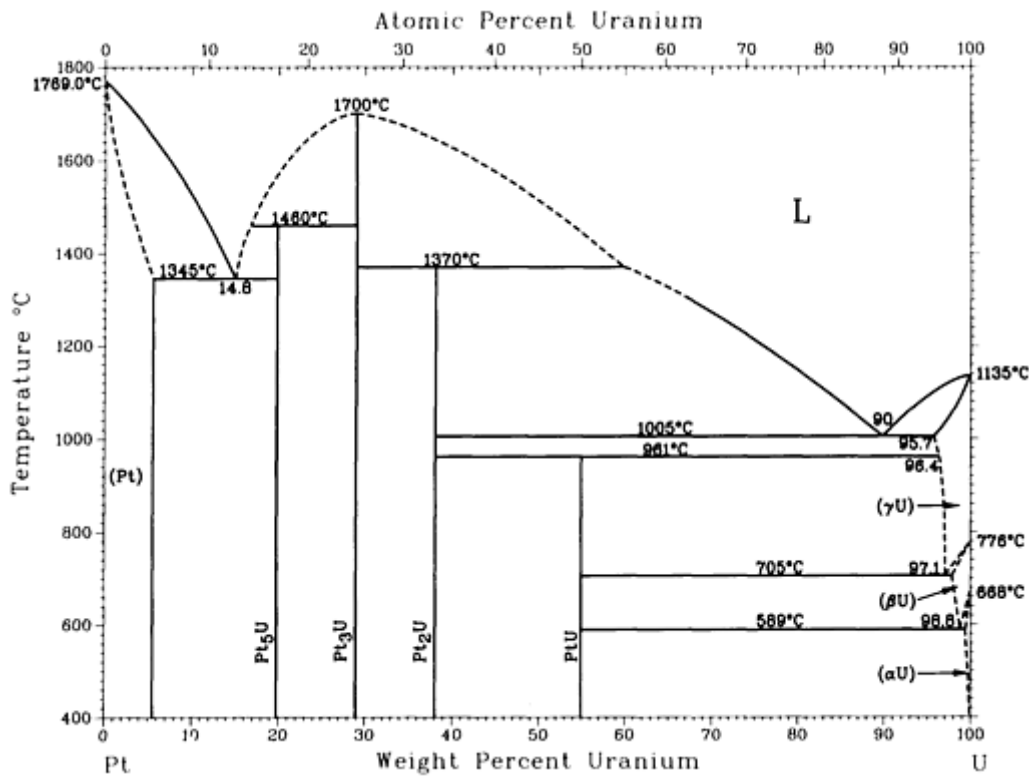

Pt-U phase diagram

Pt-U crystallographic data

Phase	Composition, wt% U	Pearson symbol	Space group
(Pt)	0 to 5	<i>cF4</i>	<i>Fm$\bar{3}m$</i>
Pt ₅ U	19.7	<i>cF24</i>	<i>F$\bar{4}3m$</i>
Pt ₃ U	29	<i>hP8</i>	<i>P6₃/mmc</i>
Pt ₂ U ^(a)	37.9	<i>oC12</i>	<i>Ama2</i>

PtU	55.0	<i>oC8</i>	<i>Cmcm</i>
(γ U)	99.7 to 100	<i>cI2</i>	<i>Im\bar{3}m</i>
(β U)	98.1 to 100	<i>tP30</i>	<i>P4₂/mmm</i>
(α U)	99.2 to 100	<i>oC4</i>	<i>Cmcm</i>

(a) Distorted structure

Pt-V (Platinum - Vanadium)

J.F. Smith, 1989

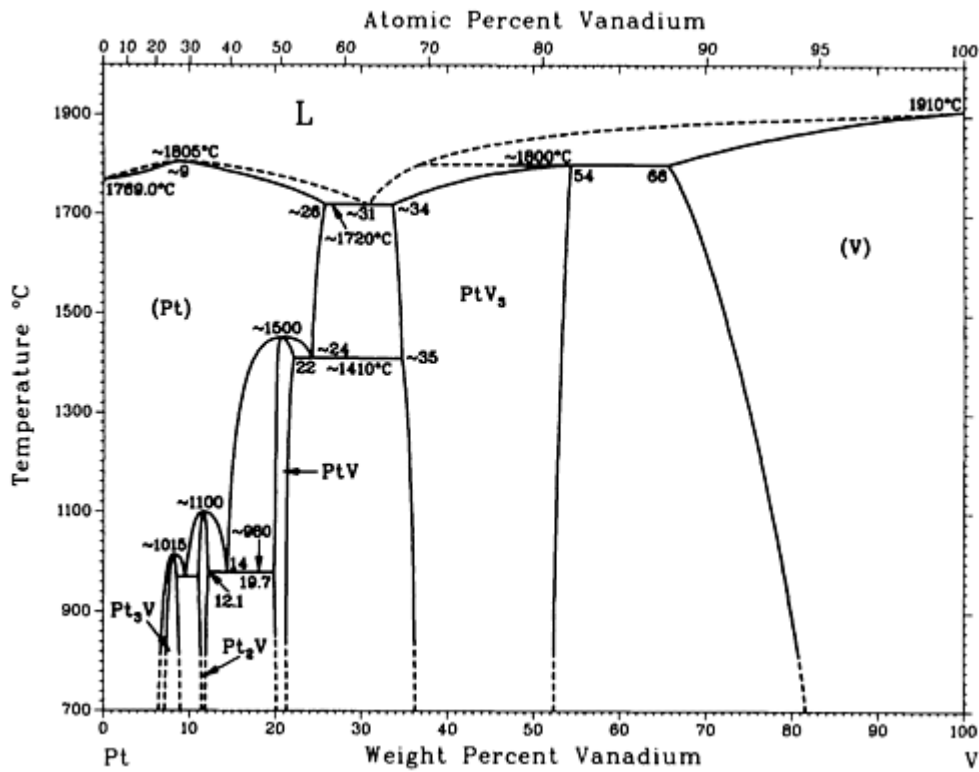

Pt-V phase diagram

Pt-V crystallographic data

Phase	Composition, wt% V	Pearson symbol	Space group
(Pt)	0 to ~26	<i>cF4</i>	<i>Fm\bar{3}m</i>

Pt ₃ V	7 to 8	<i>tI8</i>	<i>I4/mmm</i>
Pt ₂ V	11 to 21.1	<i>oI6</i>	<i>Immm</i>
PtV	19.7 to 22	<i>oP4</i>	<i>Pmma</i>
PtV ₃	~34 to 54	<i>cP8</i>	<i>Pm$\bar{3}n$</i>
(V)	66 to 100	<i>cI2</i>	<i>Im$\bar{3}m$</i>
Metastable phases			
Pt ₈ V ^(a)	~3.2	<i>tI18</i>	<i>I4/mmm</i>
Pt ₃ V ^(b)	6.9 to 7.2	<i>cP4</i>	<i>Pm$\bar{3}m$</i>
PtV	20.7 to 23.5	<i>tP2</i>	<i>P4/mmm</i>
PtV ₃	~44	<i>cP4</i>	<i>Pm$\bar{3}m$</i>

(a) Possibly misclassified because neither its stability nor metastability is conclusive.

(b) Stabilized by oxygen and possibly also by nitrogen and/or carbon

Pt-Zr (Platinum - Zirconium)

H. Okamoto, 1990

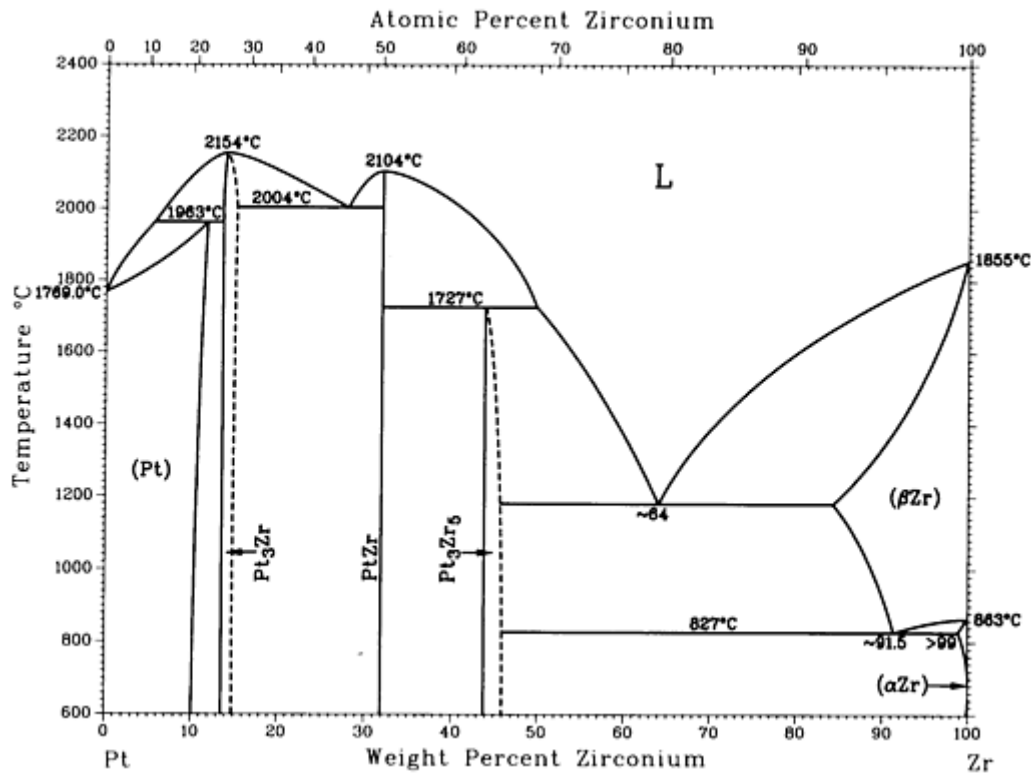

Pt-Zr phase diagram

Pt-Zr crystallographic data

Phase	Composition, wt% Zr	Pearson symbol	Space group
(Pt)	0 to ~12	<i>cF4</i>	<i>Fm</i> $\bar{3}m$
Pt ₃ Zr	14	<i>cP4</i> <i>hP16</i>	<i>Pm</i> $\bar{3}m$ <i>P6₃/mmc</i>
Pt ₁₁ Zr ₉ ^(a)	28	<i>tI40</i>	<i>I4/m</i>
β _{PtZr}	31.9	<i>cP2</i>	<i>Pm</i> $\bar{3}m$
α _{PtZr}	31.9	<i>oC8</i>	<i>Cmcm</i>
Pt ₃ Zr ₅	43.8	<i>hP16</i>	<i>P6₃/mcm</i>

(β_{Zr})	~ 84.3 to 100	$cI2$	$Im\bar{3}m$
(α_{Zr})	>99 to 100	$hP2$	$P6_3/mmc$

Note: The polymorphic transformation temperature of PtZr is unknown.

(a) Not shown in the diagram

Pu (Plutonium) Binary Alloy Phase Diagrams

Introduction

THIS ARTICLE includes systems where plutonium is the first-named element in the binary pair. Additional binary systems that include plutonium are provided in the following locations in this Volume:

- “Au-Pu (Gold - Plutonium)” in the article “Au (Gold) Binary Alloy Phase Diagrams.”
- “Ce-Pu (Cerium - Plutonium)” in the article “Ce (Cerium) Binary Alloy Phase Diagrams.”
- “Co-Pu (Cobalt - Plutonium)” in the article “Co (Cobalt) Binary Alloy Phase Diagrams.”
- “Cu-Pu (Copper - Plutonium)” in the article “Cu (Copper) Binary Alloy Phase Diagrams.”
- “Fe-Pu (Iron - Plutonium)” in the article “Fe (Iron) Binary Alloy Phase Diagrams.”
- “Ga-Pu (Gallium - Plutonium)” in the article “Ga (Gallium) Binary Alloy Phase Diagrams.”
- “In-Pu (Indium - Plutonium)” in the article “In (Indium) Binary Alloy Phase Diagrams.”
- “Mn-Pu (Manganese - Plutonium)” in the article “Mn (Manganese) Binary Alloy Phase Diagrams.”
- “Mo-Pu (Molybdenum - Plutonium)” in the article “Mo (Molybdenum) Binary Alloy Phase Diagrams.”
- “Ni-Pu (Nickel - Plutonium)” in the article “Ni (Nickel) Binary Alloy Phase Diagrams.”
- “Np-Pu (Neptunium - Plutonium)” in the article “Np (Neptunium) Binary Alloy Phase Diagrams.”
- “O-Pu (Oxygen - Plutonium)” in the article “O (Oxygen) Binary Alloy Phase Diagrams.”
- “Os-Pu (Osmium - Plutonium)” in the article “Os (Osmium) Binary Alloy Phase Diagrams.”
- “Pb-Pu (Lead - Plutonium)” in the article “Pb (Lead) Binary Alloy Phase Diagrams.”
- “Pd-Pu (Palladium - Plutonium)” in the article “Pd (Palladium) Binary Alloy Phase Diagrams.”

Pu-Sc (Plutonium - Scandium)

H. Okamoto, 1990

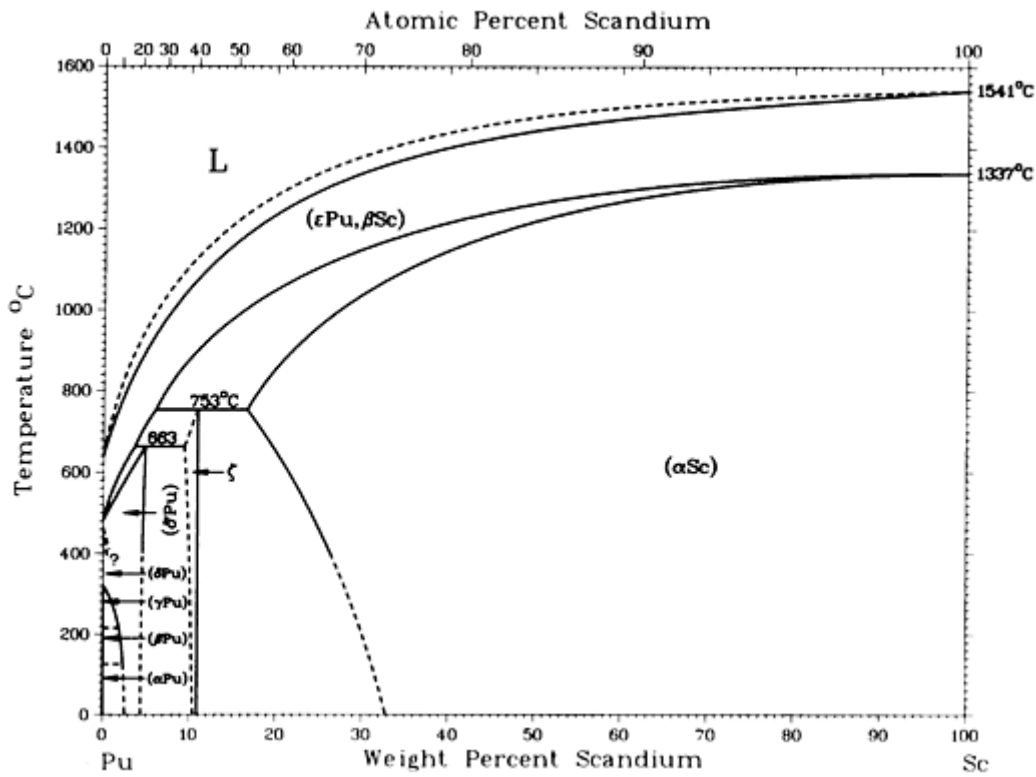

Pu-Sc phase diagram

Pu-Sc crystallographic data

Phase	Composition, wt% Sc	Pearson symbol	Space group
(εPu, βSc)	0 to 100	<i>cI2</i>	<i>Im</i> $\bar{3}m$
(δPu)	0 to ?	<i>tI2</i>	<i>I4/mmm</i>
(δPu)	0 to ?	<i>cF4</i>	<i>Fm</i> $\bar{3}m$
(γPu)	0 to ?	<i>oF8</i>	<i>Fddd</i>
(βPu)	0 to ?	<i>mC34</i>	<i>C2/m</i>
(αPu)	0 to ?	<i>mP16</i>	<i>P2₁/m</i>
ζ	? to 11

(α Sc)	17 to 100	<i>hP2</i>	<i>P6₃/mmc</i>
----------------	-----------	------------	---------------------------

Pu-U (Plutonium - Uranium)

H. Okamoto, 1992

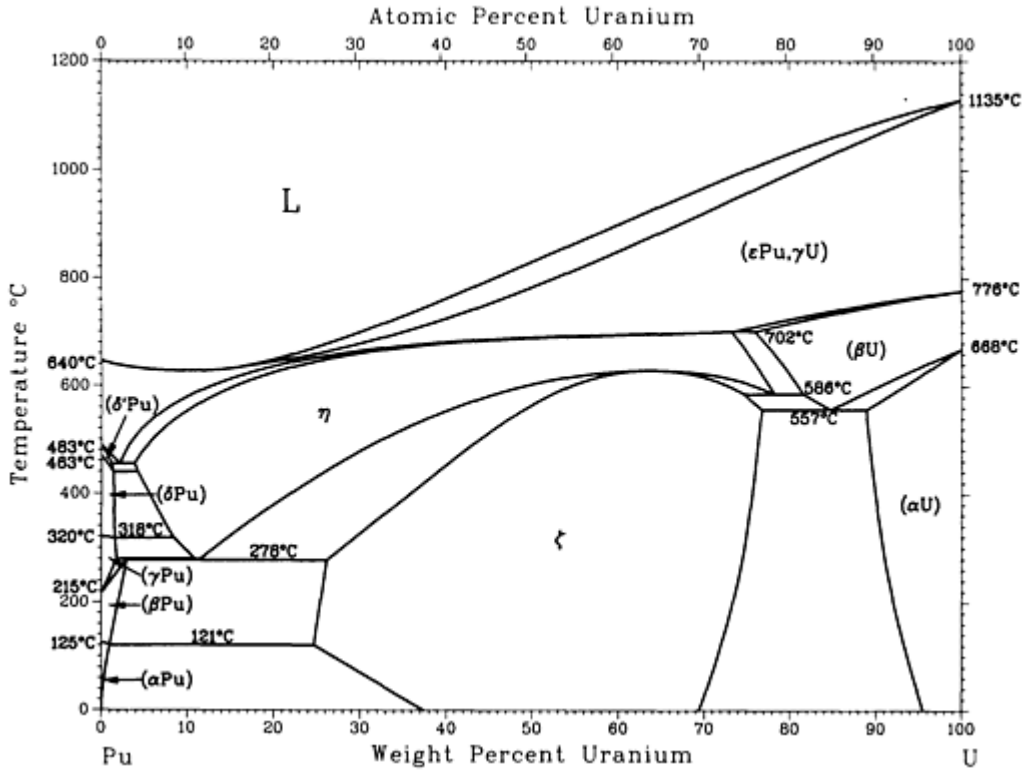

Pu-U phase diagram

Pu-U crystallographic data

Phase	Composition, wt% U	Pearson symbol	Space group
(ϵ Pu, γ U)	0 to 100	<i>cI2</i>	<i>Im$\bar{3}m$</i>
(δ' Pu)	0 to 2	<i>tI2</i>	<i>I4/mmm</i>
(δ Pu)	0 to 2	<i>cF4</i>	<i>Fm$\bar{3}m$</i>
(γ Pu)	0 to 2	<i>oF8</i>	<i>Fddd</i>
(β Pu)	0 to 3	<i>mC34</i>	<i>C2/m</i>

(α Pu)	0	<i>mP16</i>	<i>P2₁/m</i>
ζ	25 to 77	<i>cP58</i>	...
η	4 to 80	<i>tP52</i>	...
(β _U)	77 to 100	<i>tP30</i>	<i>P4₂/mnm</i>
(α U)	89 to 100	<i>oC4</i>	<i>Cmcm</i>

Pu-Zn (Plutonium - Zinc)

From [Chiotti] 3

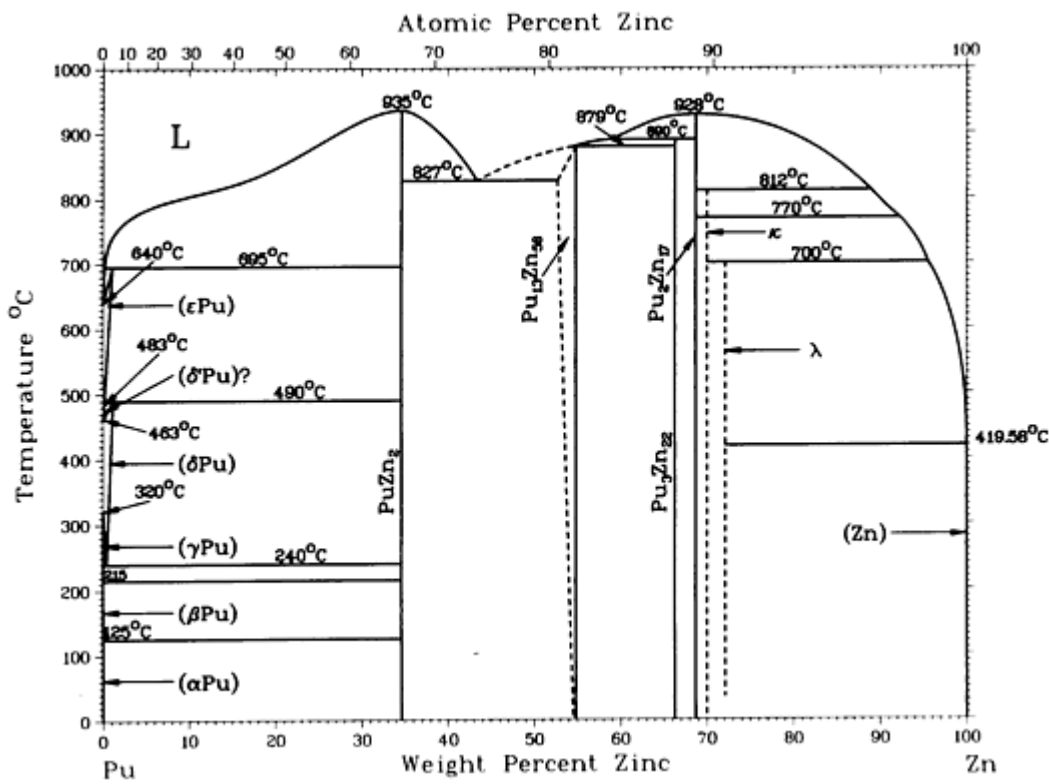

Pu-Zn phase diagram

Pu-Zn crystallographic data

Phase	Composition, wt% Zn	Pearson symbol	Space group
(ϵ Pu)	0 to 0.96	<i>cI2</i>	<i>Im$\bar{3}m$</i>
(δ Pu)	0	<i>tI2</i>	<i>I4/mmm</i>

(δ_{Pu})	0 to 1.1	<i>cF4</i>	<i>Fm$\bar{3}m$</i>
(γ_{Pu})	0	<i>oF8</i>	<i>Fddd</i>
(β_{Pu})	0	<i>mC34</i>	<i>C2/m</i>
(α_{Pu})	0	<i>mP16</i>	<i>P2₁/m</i>
PuZn ₂	34.9	<i>cF24</i>	<i>Fd$\bar{3}m$</i>
Pu ₃ Zn ₅₈	~52.5 to 55	<i>hP142</i>	<i>P6₃mc</i>
Pu ₃ Zn ₂₂	66	<i>tI100</i>	<i>I4₁/amd</i>
Pu ₂ Zn ₁₇	69.5	<i>hR*</i>	<i>R$\bar{3}m$</i>
$\kappa(\text{HT})$	~71	<i>hP*</i>	<i>P6/mmm</i>
$\kappa(\text{LT})$	~71	<i>hP38</i>	<i>P6₃/mmc</i>
λ	~71.8	<i>hP*</i>	<i>P6₃22</i>
(Zn)	100	<i>hP2</i>	<i>P6₃/mmc</i>

Reference cited in this section

3. [Chiotti]: P. Chiotti, V.V. Akhachinskij, and I. Ansara, *The Chemical Thermodynamics of Actinide Elements and Compounds*, Part 5: The Actinide Binary Alloys, V. Medvedev, M.H. Rand, E.F. Westrum, Jr., and F.L. Oetting, Ed., International Atomic Energy Agency, Vienna (1981).

Pu-Zr (Plutonium - Zirconium)

From [Elliott] 4

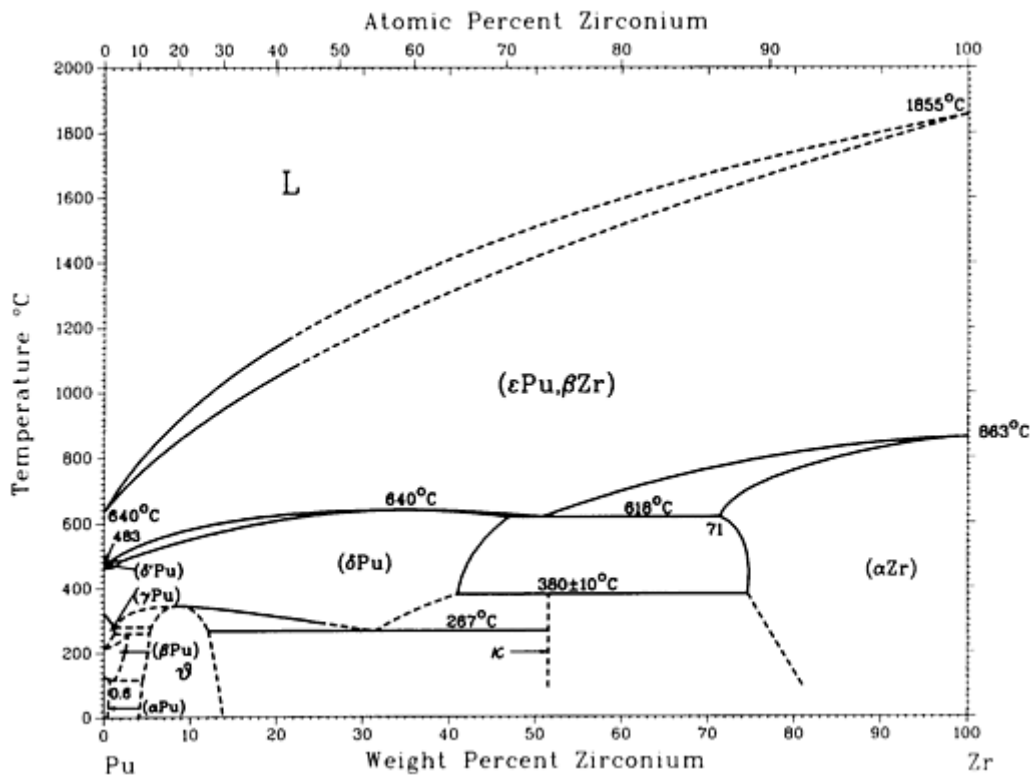

Pu-Zr phase diagram

Pu-Zr crystallographic data

Phase	Composition, wt% Zr	Pearson symbol	Space group
$(\epsilon\text{Pu}, \beta\text{Zr})$	0 to 100	<i>cI2</i>	<i>Im$\bar{3}m$</i>
(δPu)	0 to 0.76	<i>tI2</i>	<i>I4/mmm</i>
(δPu)	0 to 47	<i>cF4</i>	<i>Fm$\bar{3}m$</i>
(γPu)	0 to 1.1	<i>oF8</i>	<i>Fddd</i>
(βPu)	0 to 2.7	<i>mC34</i>	<i>C2/m</i>
(αPu)	0 to 0.57	<i>mP16</i>	<i>P2₁/m</i>

θ (or Pu ₄ Zr)	4 to 14	<i>tP80</i>	<i>P4/ncc</i>
κ (or PuZr ₃)	52	<i>hP3</i>	<i>P6/mmm</i>
(α Zr)	71 to 100	<i>hP2</i>	<i>P6₃/mmm</i>

Reference cited in this section

4. [Elliott]: R.P. Elliott, *Constitution of Binary Alloys, First Supplement*, McGraw-Hill, New York or General Electric Co., Business Growth Services, Schenectady, New York (1965).

Rb (Rubidium) Binary Alloy Phase Diagrams

Introduction

THIS ARTICLE includes systems where rubidium is the first-named element in the binary pair. Additional binary systems that include rubidium are provided in the following locations in this Volume:

- “Au-Rb (Gold - Rubidium)” in the article “Au (Gold) Binary Alloy Phase Diagrams.”
- “Bi-Rb (Bismuth - Rubidium)” in the article “Bi (Bismuth) Binary Alloy Phase Diagrams.”
- “Cs-Rb (Cesium - Rubidium)” in the article “Cs (Cesium) Binary Alloy Phase Diagrams.”
- “Hg-Rb (Mercury - Rubidium)” in the article “Hg (Mercury) Binary Alloy Phase Diagrams.”
- “In-Rb (Indium - Rubidium)” in the article “In (Indium) Binary Alloy Phase Diagrams.”
- “K-Rb (Potassium - Rubidium)” in the article “K (Potassium) Binary Alloy Phase Diagrams.”
- “Na-Rb (Sodium - Rubidium)” in the article “Na (Sodium) Binary Alloy Phase Diagrams.”
- “Pb-Rb (Lead - Rubidium)” in the article “Pb (Lead) Binary Alloy Phase Diagrams.”

Rb-Sb (Rubidium - Antimony)

F.W. Dorn and W. Klemm, 1961

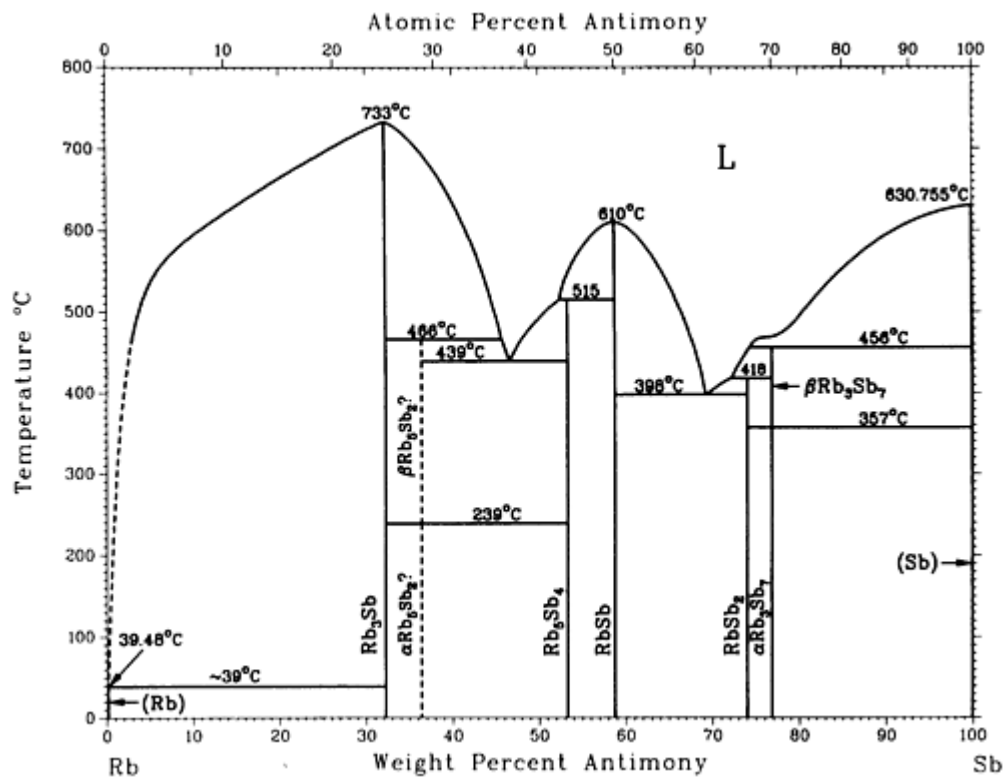

Rb-Sb phase diagram

Rb-Sb crystallographic data

Phase	Composition, wt% Sb	Pearson symbol	Space group
(Rb)	0	<i>cI2</i>	<i>Im</i> $\bar{3}m$
Rb ₃ Sb	30	<i>hP8</i>	<i>P6₃/mm</i>
β -Rb ₅ Sb ₂	36.3
α -Rb ₅ Sb ₂	36.3
Rb ₅ Sb ₄	53.2
RbSb	58.8	<i>oP16</i>	<i>P2₁2₁2₁</i>
RbSb ₂	74.0

β -Rb ₃ Sb ₇	77
α -Rb ₃ Sb ₇	77
(Sb)	100	<i>hR2</i>	$R\bar{3}m$

Rb-Se (Rubidium - Selenium)

H. Okamoto, 1990

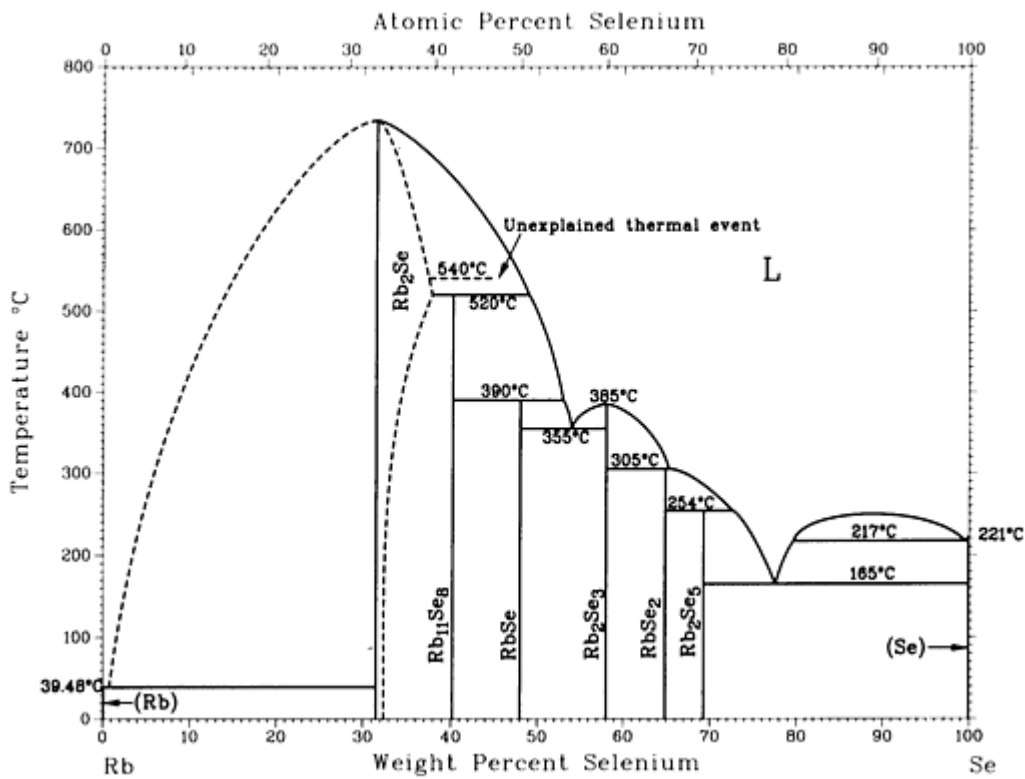

Rb-Se phase diagram

Rb-Se crystallographic data

Phase	Composition, wt% Se	Pearson symbol	Space group
(Rb)	0	<i>cI2</i>	$Im\bar{3}m$
Rb ₂ Se	31.6 to ~38	<i>cF12</i>	$Fm\bar{3}m$
Rb ₁₁ Se ₈	40.2

RbSe	48.0
Rb ₂ Se ₃	58	<i>oC20</i>	<i>Cmc2₁</i>
RbSe ₂	64.9
Rb ₂ Se ₅	69.8	<i>oP28</i>	<i>P2₁2₁2₁</i>
(Se)	100	<i>hP3</i>	<i>P3₁21</i>

Rb-Tl (Rubidium - Thallium)

R. Thümmel and W. Klemm, 1970

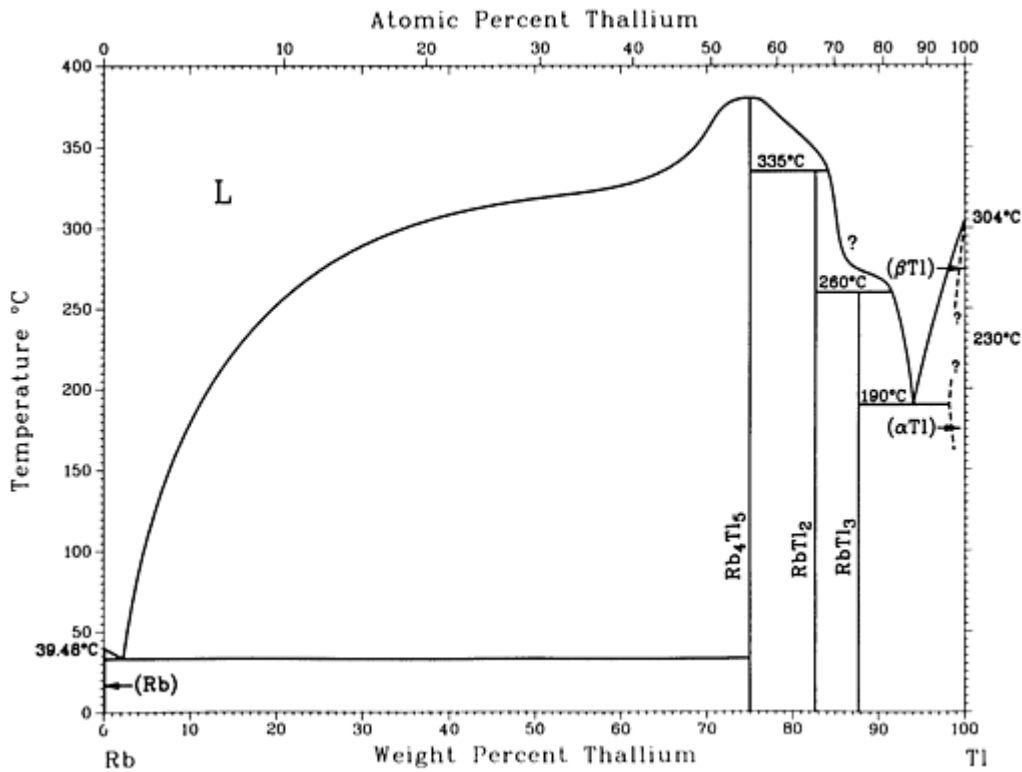

Rb-Tl phase diagram

Rb-Tl crystallographic data

Phase	Composition, wt% Tl	Pearson symbol	Space group
(Rb)	0	<i>cI2</i>	<i>Im$\bar{3}m$</i>
Rb ₄ Tl ₅	74.9

RbTl ₂	82.7
RbTl ₃	88
(βTl)	? to 100	<i>cI2</i>	<i>Im$\bar{3}m$</i>
(αTl)	? to 100	<i>hP2</i>	<i>P6₃/mmc</i>

Re (Rhenium) Binary Alloy Phase Diagrams

Introduction

THIS ARTICLE includes systems where rhenium is the first-named element in the binary pair. Additional binary systems that include rhenium are provided in the following locations in this Volume:

- “B-Re (Boron - Rhenium)” in the article “B (Boron) Binary Alloy Phase Diagrams.”
- “Co-Re (Cobalt - Rhenium)” in the article “Co (Cobalt) Binary Alloy Phase Diagrams.”
- “Cr-Re (Chromium - Rhenium)” in the article “Cr (Chromium) Binary Alloy Phase Diagrams.”
- “Ni-Re (Nickel - Rhenium)” in the article “Ni (Nickel) Binary Alloy Phase Diagrams.”
- “Os-Re (Osmium - Rhenium)” in the article “Os (Osmium) Binary Alloy Phase Diagrams.”

Re-Ru (Rhenium - Ruthenium)

E. Rudy, B. Kietter, and H. Froelich, 1962

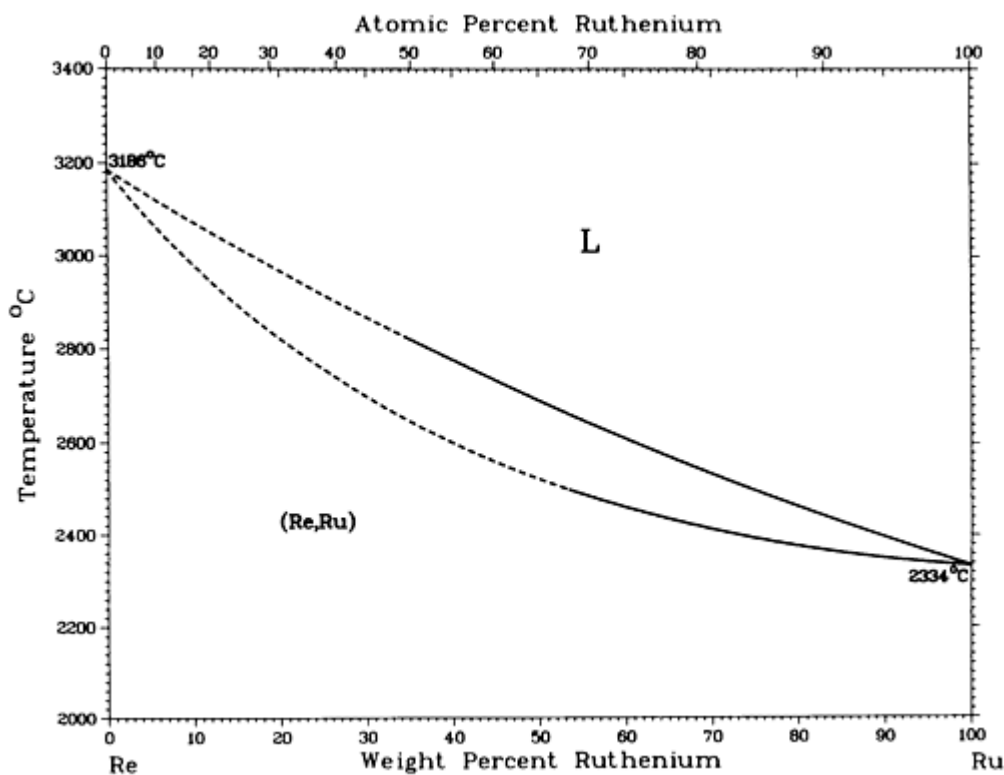

Re-Ru phase diagram

Re-Ru crystallographic data

Phase	Composition, wt% Ru	Pearson symbol	Space group
(Re,Ru)	0 to 100	<i>hP2</i>	<i>P6₃/mmc</i>

Re-Si (Rhenium - Silicon)

A.B. Gokhale and G.J. Abbaschian, unpublished

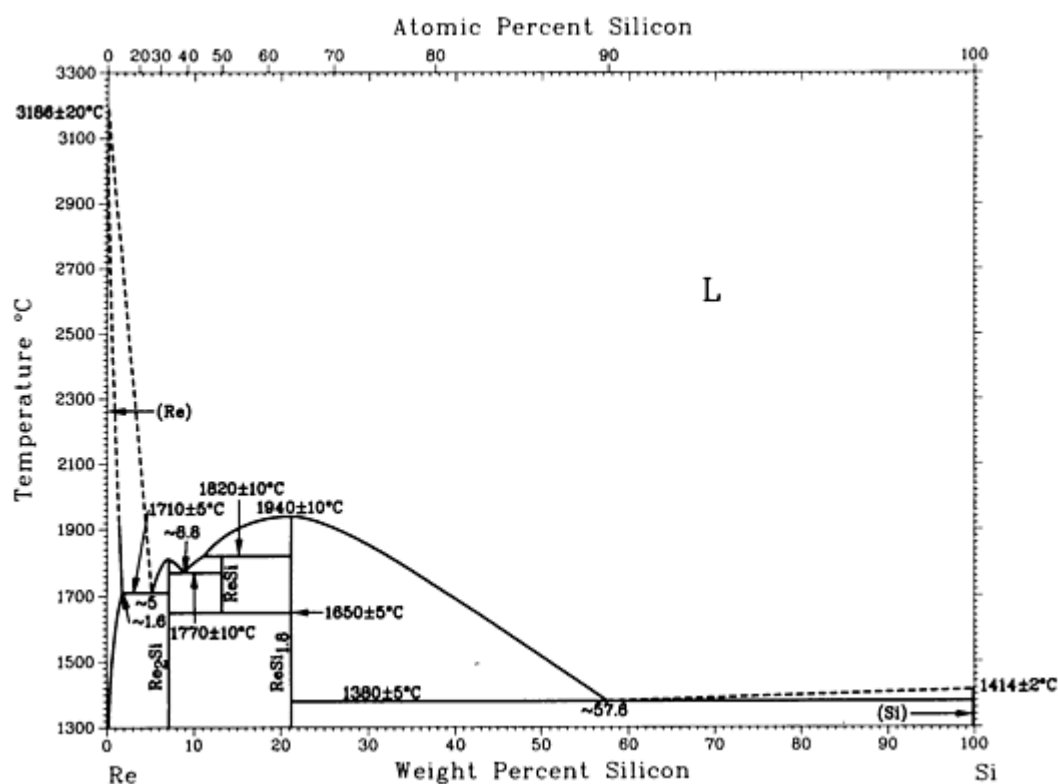

Re-Si phase diagram

Re-Si crystallographic data

Phase	Composition, wt% Si	Pearson symbol	Space group
(Re)	0 to ~1.6	<i>hP2</i>	<i>P6₃/mmc</i>
Re ₂ Si	7.0	^(a)	<i>P2₁/b</i>
ReSi	13.1	<i>cP8</i>	<i>P2₁3</i>

ReSi _{1.8}	21.4	<i>tl6</i>	<i>I4/mmm</i>
(Si)	100	<i>cF8</i>	<i>Fd3̄m</i>

(a) Monoclinic

Re-Te (Rhenium - Tellurium)

T.Kh. Kurbanov, R.A. Dovlyatshina, I.A. Dzhavodova, and F.A. Akhmenov, 1977

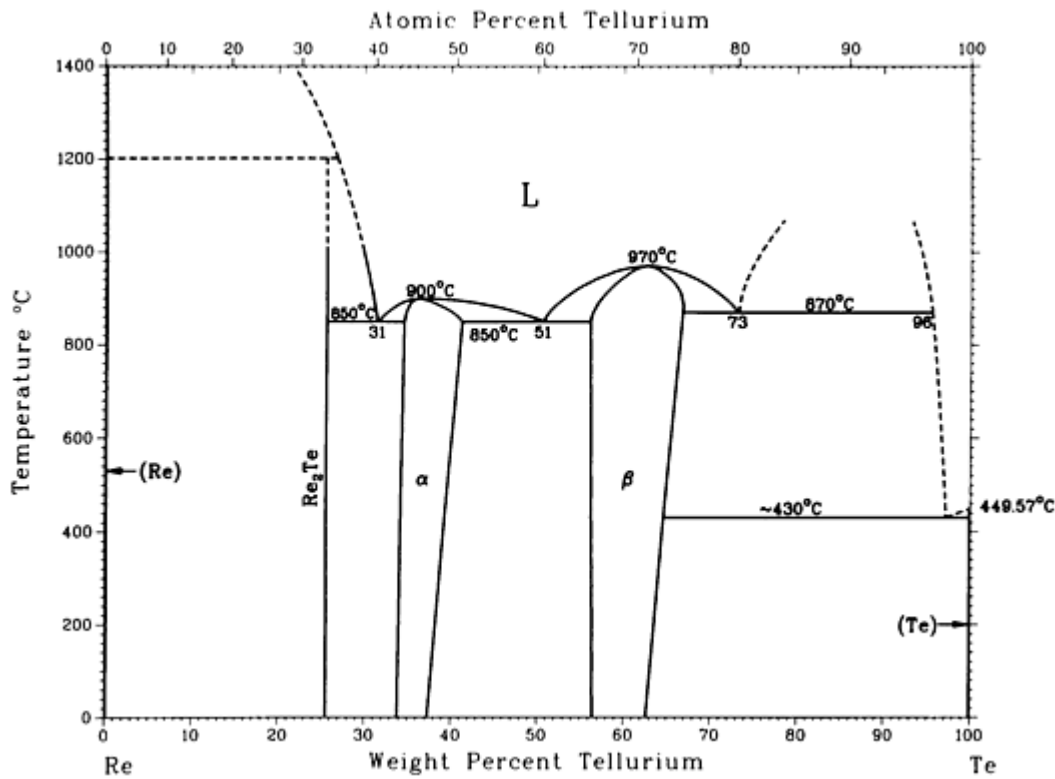

Re-Te phase diagram

Re-Te crystallographic data

Phase	Composition, wt% Te	Pearson symbol	Space group
(Re)	0	<i>hP2</i>	<i>P6₃/mmc</i>
Re_2Te	25.5
α	~33.9 to 42.1
β	~56.5 to 67	<i>oP84</i>	<i>Pbca</i>

(Te)	100	hP3	P3 ₁ 21
------	-----	-----	--------------------

Re-U (Rhenium - Uranium)

H. Okamoto, 1990

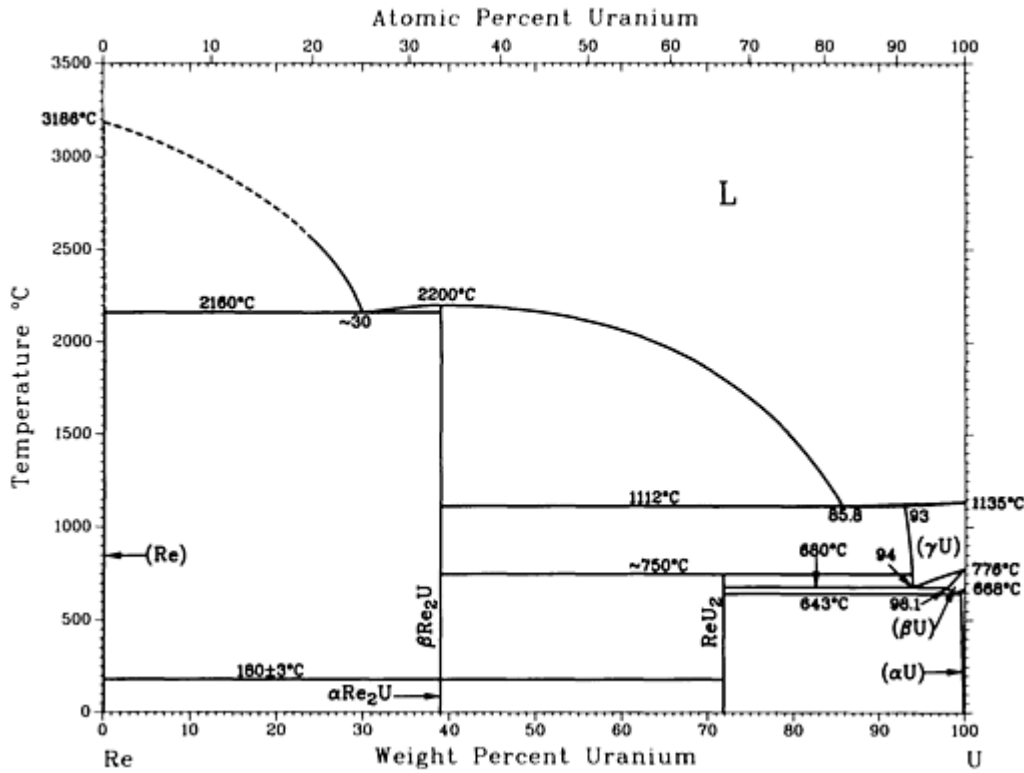

Re-U phase diagram

Re-U crystallographic data

Phase	Composition, wt% U	Pearson symbol	Space group
(Re)	0	hP2	$P6_3/mmc$
Re ₂ U	39.0	hP12	$P6_3/mmc$
Re ₂ U	39.0	oC24	$Cmcm$
ReU ₂	71.9
(γU)	93 to 100	cI2	$Im\bar{3}m$
(βU)	98.1 to 100	tP30	$P4_2/mnm$

(αU)	~ 100	$oC4$	$Cmcm$
--------------	------------	-------	--------

Re-V (Rhenium - Vanadium)

J.F. Smith, 1989

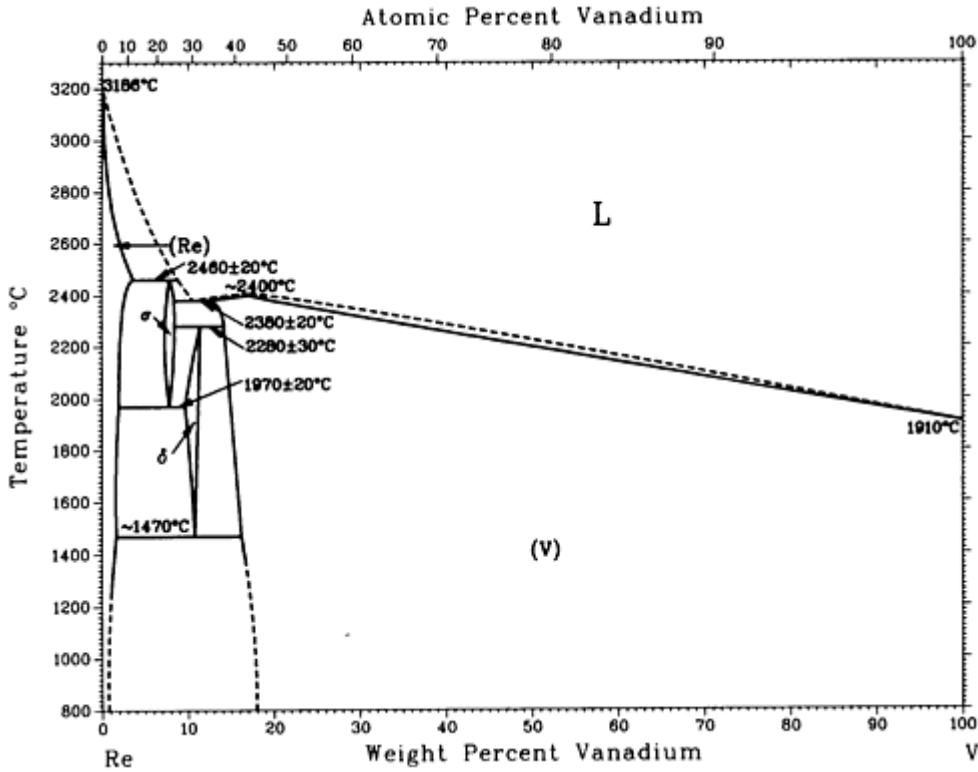

Re-V phase diagram

Re-V crystallographic data

Phase	Composition, wt% V	Pearson symbol	Space group
(Re)	0 to 4	$hP2$	$P6_3/mmc$
σ	~8.0 to 8.3	$tP30$	$P4_2/mnm$
δ	9.6 to 11.4	$cP8$	$Pm\bar{3}n$
(V)	12.8 to 100	$cI2$	$Im\bar{3}m$

Introduction

THIS ARTICLE includes systems where rhodium is the first-named element in the binary pair. Additional binary systems that include rhodium are provided in the following locations in this Volume:

- “Cr-Rh (Chromium - Rhodium)” in the article “Cr (Chromium) Binary Alloy Phase Diagrams.”
- “Cu-Rh (Copper - Rhodium)” in the article “Cu (Copper) Binary Alloy Phase Diagrams.”
- “Fe-Rh (Iron - Rhodium)” in the article “Fe (Iron) Binary Alloy Phase Diagrams.”
- “Gd-Rh (Gadolinium - Rhodium)” in the article “Gd (Gadolinium) Binary Alloy Phase Diagrams.”
- “Hf-Rh (Hafnium - Rhodium)” in the article “Hf (Hafnium) Binary Alloy Phase Diagrams.”
- “Ir-Rh (Iridium - Rhodium)” in the article “Ir (Iridium) Binary Alloy Phase Diagrams.”
- “Mo-Rh (Molybdenum - Rhodium)” in the article “Mo (Molybdenum) Binary Alloy Phase Diagrams.”
- “Nb-Rh (Niobium - Rhodium)” in the article “Nb (Niobium) Binary Alloy Phase Diagrams.”
- “Nd-Rh (Neodymium - Rhodium)” in the article “Nd (Neodymium) Binary Alloy Phase Diagrams.”
- “Ni-Rh (Nickel - Rhodium)” in the article “Ni (Nickel) Binary Alloy Phase Diagrams.”
- “Os-Rh (Osmium - Rhodium)” in the article “Os (Osmium) Binary Alloy Phase Diagrams.”
- “Pb-Rh (Lead - Rhodium)” in the article “Pb (Lead) Binary Alloy Phase Diagrams.”
- “Pd-Rh (Palladium - Rhodium)” in the article “Pd (Palladium) Binary Alloy Phase Diagrams.”
- “Pt-Rh (Platinum - Rhodium)” in the article “Pt (Platinum) Binary Alloy Phase Diagrams.”

Rh-Se (Rhodium - Selenium)

H. Okamoto, 1990

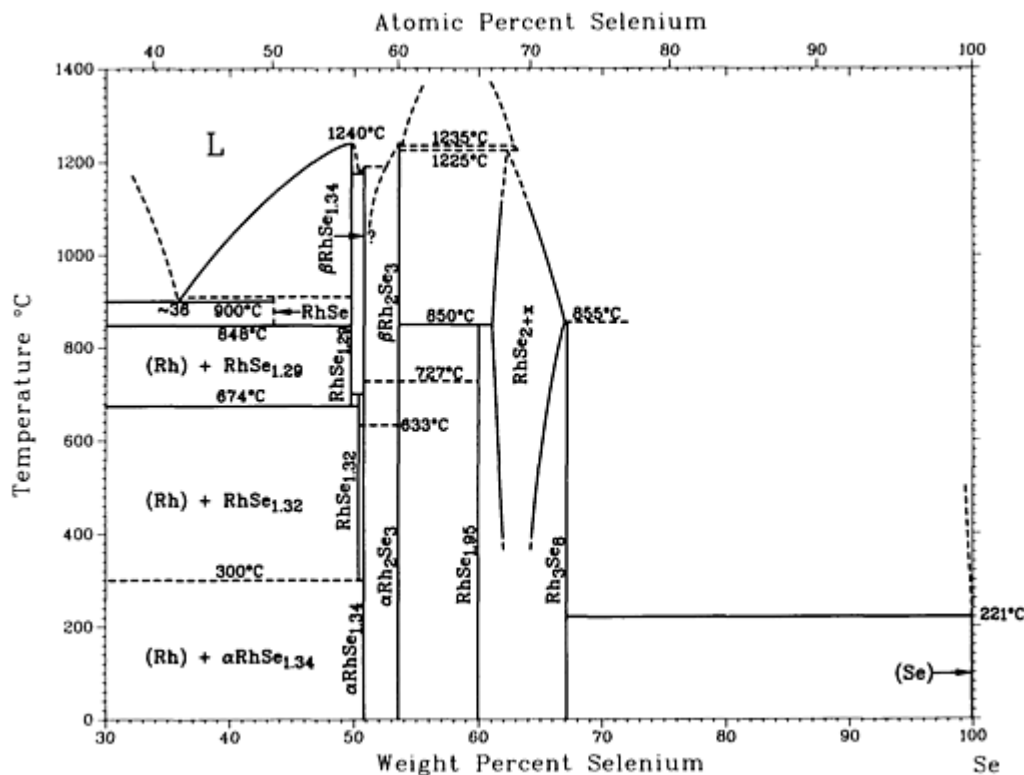

Rh-Se phase diagram

Rh-Se crystallographic data

Phase	Composition, wt% Se	Pearson symbol	Space group
(Rh)	0	<i>cF4</i>	<i>Fm</i> $\bar{3}m$
RhSe	43.4	<i>hP4</i>	<i>P6</i> $\bar{3}/mmc$
RhSe _{1.29}	49.7
RhSe _{1.32}	50.3	<i>o**</i>	...
β RhSe _{1.34}	50.7
α RhSe _{1.34}	50.7	<i>hP*</i>	...
β Rh ₂ Se ₃	54
α Rh ₂ Se ₃	54	<i>oP20</i>	<i>Pbcn</i>
RhSe _{1.95}	59.9	<i>oP24</i>	<i>Pnma</i>
RhSe _{2+x}	61.0 to 66.9	<i>cP12</i>	<i>Pa</i> $\bar{3}$
Rh ₃ Se ₈	67.1	<i>hR11</i>	<i>R</i> $\bar{3}$
(Se)	100	<i>hP3</i>	<i>P3</i> $\bar{1}21$

Rh-Ta (Rhodium - Tantalum)

B.C. Giessen, H. Ibach, and N.J. Grant, 1964

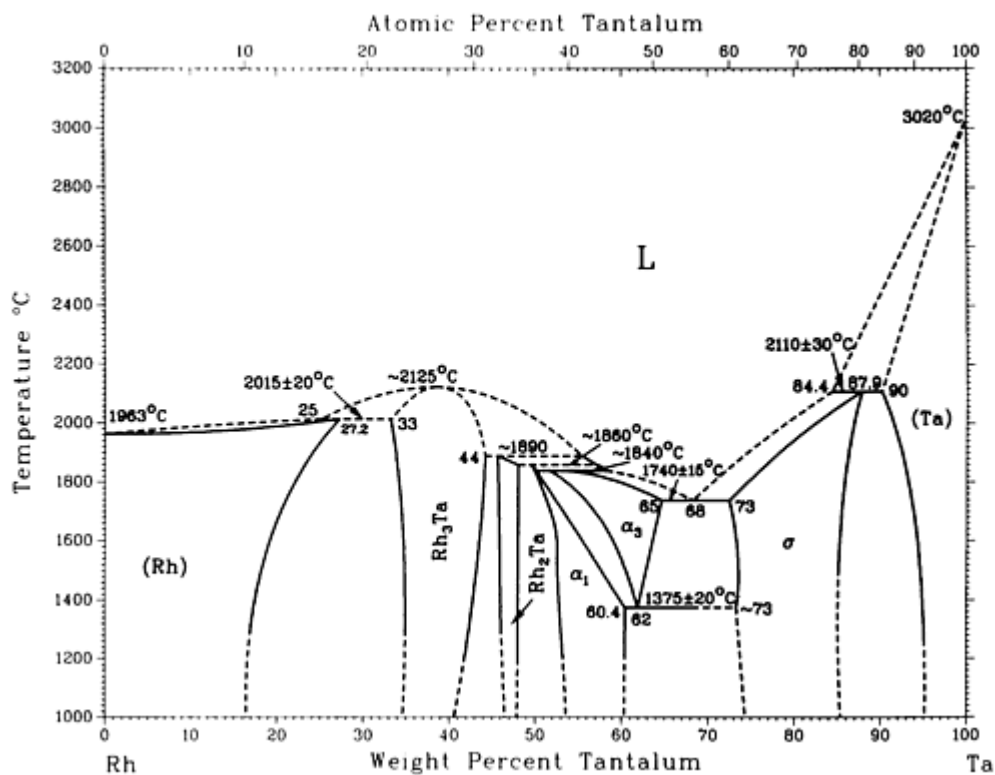

Rh-Ta phase diagram

Rh-Ta crystallographic data

Phase	Composition, wt% Ta	Pearson symbol	Space group
(Rh)	0 to 27.2	<i>cF4</i>	<i>Fm</i> $\bar{3}m$
Rh ₃ Ta	33 to 44	<i>cP4</i>	<i>Pm</i> $\bar{3}m$
Rh ₂ Ta	45 to 48	<i>oP12</i>	<i>Pnma</i>
α ₃	54 to 65
α ₁	51 to 60.4	...	<i>Pmcm?</i>
σ	73 to 87.9	<i>tP30</i>	<i>P4₂/mnm</i>
(Ta)	90 to 100	<i>cI2</i>	<i>Im</i> $\bar{3}m$

Rh-Ti (Rhodium - Titanium)

J.L. Murray, 1987

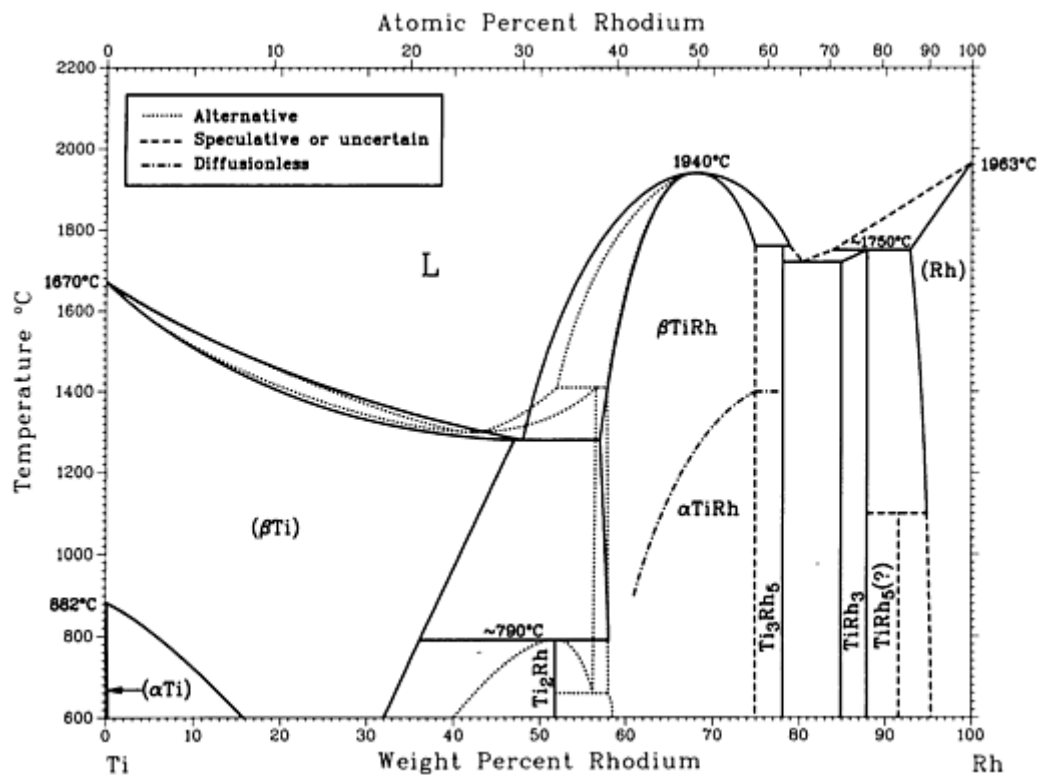

Rh-Ti phase diagram

Rh-Ti crystallographic data

Phase	Composition, wt% Rh	Pearson symbol	Space group
(βTi)	0 to 47	cI2	$Im\bar{3}m$
(αTi)	0 to 0.161	hP2	$P6_3/mmc$
Ti ₂ Rh	51.8	tI6	$I4/mmm$
βTiRh	~57 to 75	cP2	$Pm\bar{3}m$
αTiRh	~57 to 75	tP2	$Pm\bar{3}m$
Ti ₃ Rh ₅	78.2	oP16	$Pbam$
TiRh ₃	85 to 88	cP4	$Pm\bar{3}m$

TiRh ₅	~91.7
(Rh)	93 to 100	<i>cF4</i>	<i>Fm</i> $\bar{3}m$

Rh-U (Rhodium - Uranium)

From [Ivanov] 8

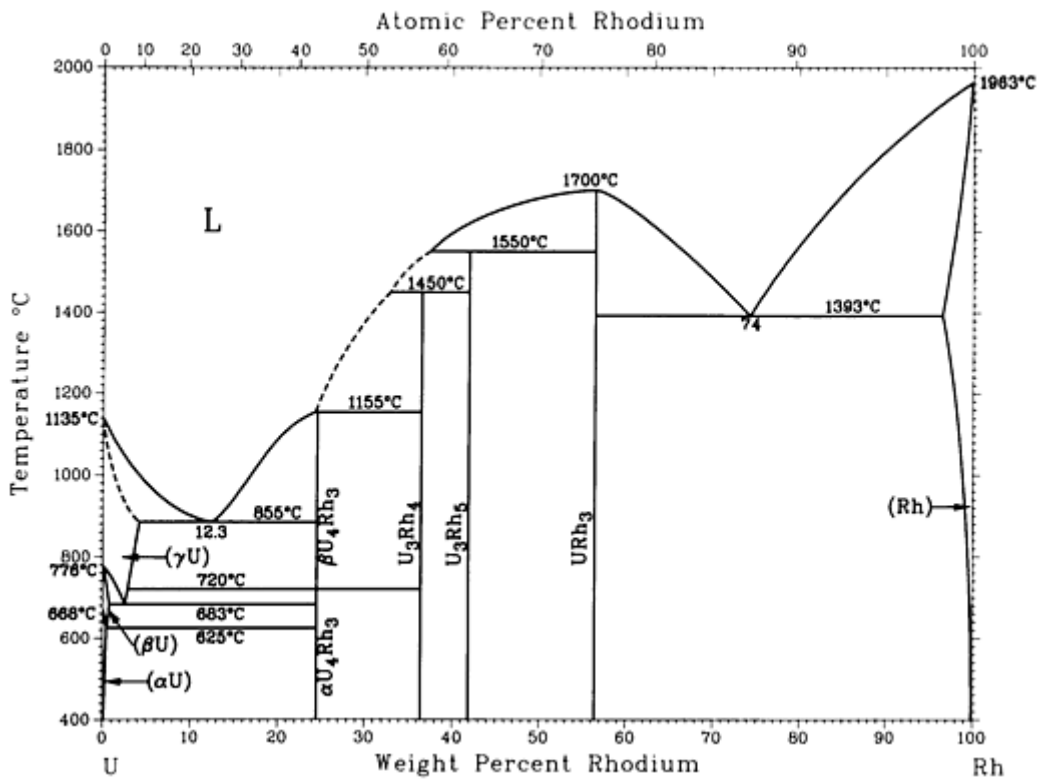

Rh-U phase diagram

Rh-U crystallographic data

Phase	Composition, wt% Rh	Pearson symbol	Space group
(γU)	0 to 0.41	<i>oC4</i>	<i>Cmcm</i>
(βU)	0 to 0.87	<i>tP30</i>	<i>P</i> $\bar{4}n2$
(αU)	0 to 0.43	<i>cI2</i>	<i>Im</i> $\bar{3}m$
βU ₄ Rh ₃	25

$\alpha\text{U}_4\text{Rh}_3$	25
U_3Rh_4	36
U_3Rh_5	~ 42
URh_3	57	<i>cP4</i>	$Pm\bar{3}m$
(Rh)	96 to 100	<i>cF4</i>	$Fm\bar{3}m$

Reference cited in this section

8. [Ivanov]: O.S. Ivanov, T.A. Badaeva, R.M. Sofronova, V.B. Kishenevskii, and N.P. Kushnir, *Phase Diagrams of Uranium Alloys*, Nauka, Moscow (1972).

Rh-V (Rhodium - Vanadium)

J.F. Smith, 1989

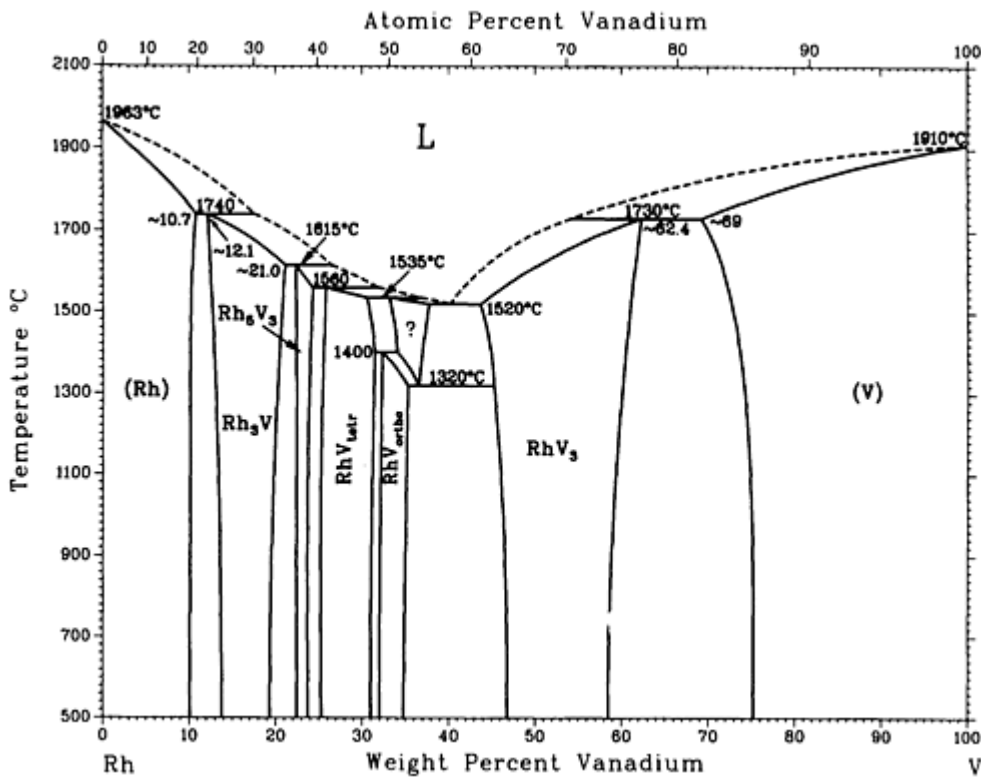

Rh-V phase diagram

Rh-V crystallographic data

Phase	Composition,	Pearson	Space
-------	--------------	---------	-------

	wt% V	symbol	group
(Rh)	0 to ~10.7	<i>cF4</i>	<i>Fm</i> $\bar{3}m$
Rh ₃ V	~12.1 to ~21.0	<i>cP4</i>	<i>Pm</i> $\bar{3}m$
Rh ₅ V ₃	~23 to 24.3	<i>oC16</i>	<i>Cm2m</i> or <i>Cmcm</i>
RhV _{tetr}	25.2 to 31	<i>tP4</i>	<i>P4/mmm</i>
RhV _{ortho}	32 to 35.2	<i>oC8</i>	<i>Cmmm</i>
RhV ₃	44 to ~62.4	<i>cP8</i>	<i>Pm</i> $\bar{3}n$
(V)	~69 to 100	<i>cI2</i>	<i>Im</i> $\bar{3}m$

Ru (Ruthenium) Binary Alloy Phase Diagrams

Introduction

THIS ARTICLE includes systems where ruthenium is the first-named element in the binary pair. Additional binary systems that include ruthenium are provided in the following locations in this Volume:

- “B-Ru (Boron - Ruthenium)” in the article “B (Boron) Binary Alloy Phase Diagrams.”
- “Cr-Ru Chromium - Ruthenium” in the article “Cr (Chromium) Binary Alloy Phase Diagrams.”
- “Er-Ru (Erbium - Ruthenium)” in the article “Er (Erbium) Binary Alloy Phase Diagrams.”
- “Ir-Ru (Iridium - Ruthenium)” in the article “Ir (Iridium) Binary Alloy Phase Diagrams.”
- “Mo-Ru (Molybdenum - Ruthenium)” in the article “Mo (Molybdenum) Binary Alloy Phase Diagrams.”
- “Nb-Ru (Niobium - Ruthenium)” in the article “Nb (Niobium) Binary Alloy Phase Diagrams.”
- “Ni-Ru (Nickel - Ruthenium)” in the article “Ni (Nickel) Binary Alloy Phase Diagrams.”
- “Os-Ru (Osmium - Ruthenium)” in the article “Os (Osmium) Binary Alloy Phase Diagrams.”
- “P-Ru (Phosphorus - Ruthenium)” in the article “P (Phosphorous) Binary Alloy Phase Diagrams.”
- “Pd-Ru (Palladium - Ruthenium)” in the article “Pd (Palladium) Binary Alloy Phase Diagrams.”
- “Re-Ru (Rhenium - Ruthenium)” in the article “Re (Rhenium) Binary Alloy Phase Diagrams.”

Ru-Si (Ruthenium - Silicon)

H. Okamoto, 1990

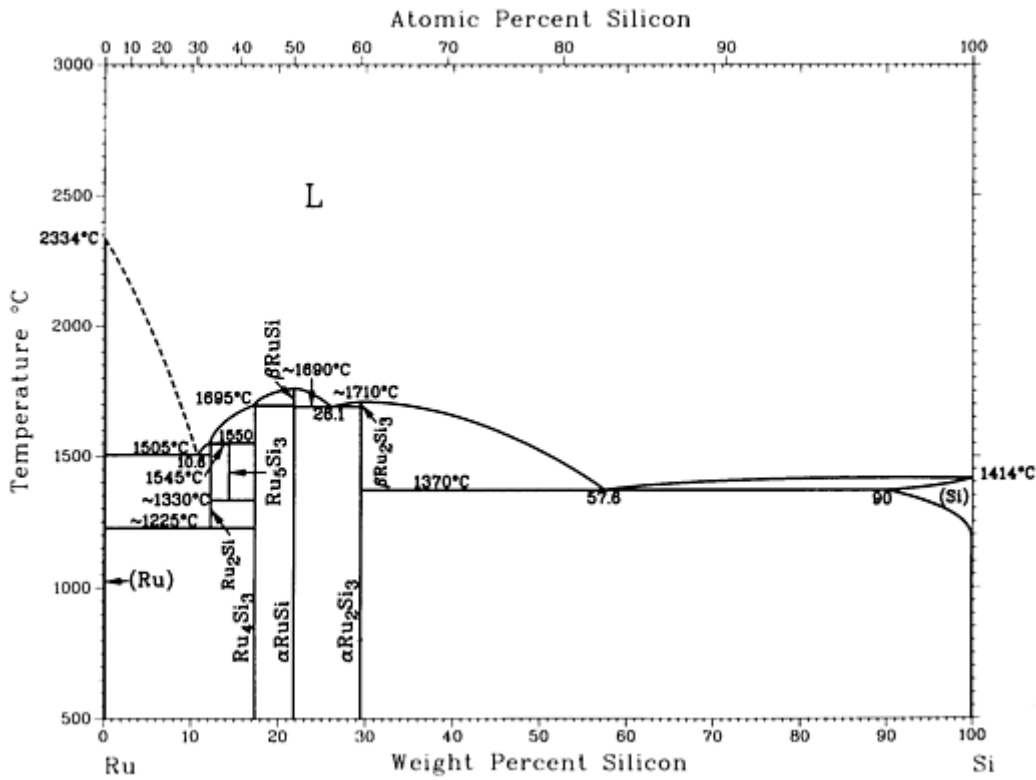

Ru-Si phase diagram

Ru-Si crystallographic data

Phase	Composition, wt% Si	Pearson symbol	Space group
(Ru)	0	<i>hP2</i>	<i>P6₃/mmc</i>
Ru ₂ Si	12.2	<i>oP12</i>	<i>Pnma</i>
Ru ₅ Si ₃	14.3	<i>oP16</i>	<i>Pbam</i>
Ru ₄ Si ₃	17.3	<i>oP28</i>	<i>Pnma</i>
βRuSi	21.7	<i>cP2</i>	<i>Pm$\bar{3}$m</i>
αRuSi	21.7	<i>cP8</i>	<i>P2₁3</i>
βRu ₂ Si ₃	29	<i>tP80</i>	<i>P$\bar{4}$c2</i>

$\alpha\text{Ru}_2\text{Si}_3$	29	<i>oP40</i>	<i>Pbcn</i>
(Si)	90 to 100	<i>cF8</i>	<i>Fd\bar{3}m</i>

Ru-Ta (Ruthenium - Tantalum)

H. Okamoto, 1991

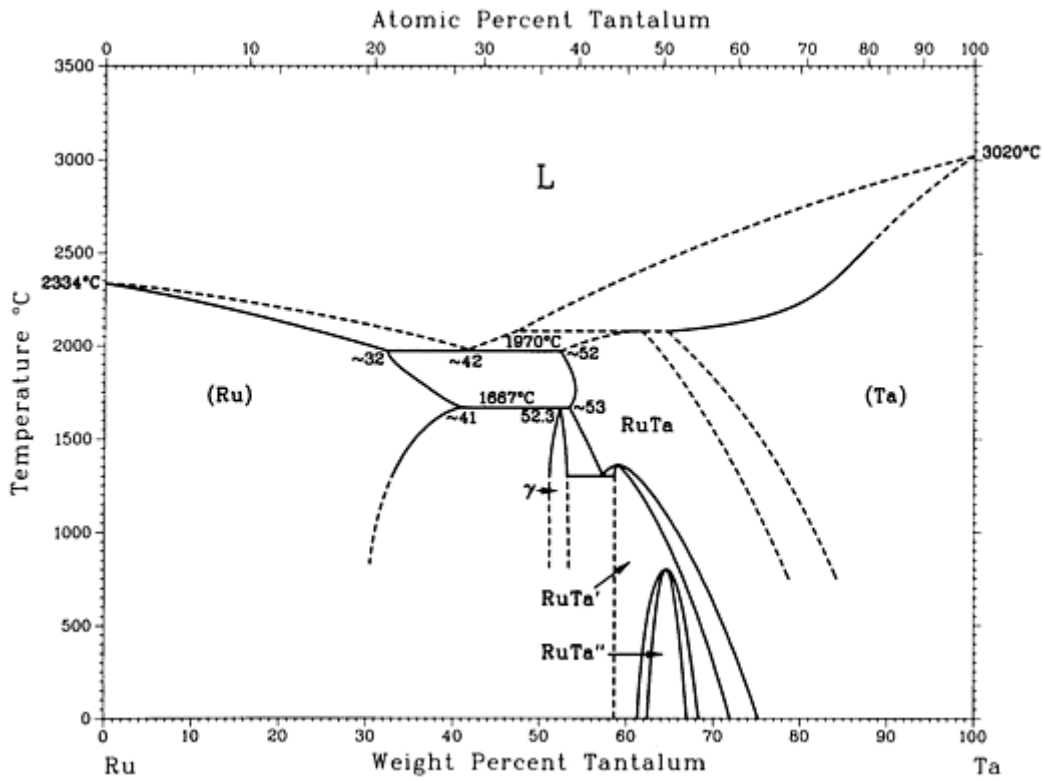

Ru-Ta phase diagram

Ru-Ta crystallographic data

Phase	Composition, wt% Ta	Pearson symbol	Space group
(Ru)	0 to ~41	<i>hP2</i>	<i>P6₃/mmc</i>
γ	~52.3	<i>c**</i>	...
RuTa	~52.3 to ?	<i>cP2</i>	<i>Pm\bar{3}m</i>
RuTa'	~58 to 73	<i>tP2</i>	<i>P4/mmm</i>
RuTa''	~62 to 67	<i>oC4</i>	<i>Cmmm</i>

(Ta)	65 to 100	<i>cI2</i>	$Im\bar{3}m$
------	-----------	------------	--------------

Ru-Ti (Ruthenium - Titanium)

J.L. Murray, 1987

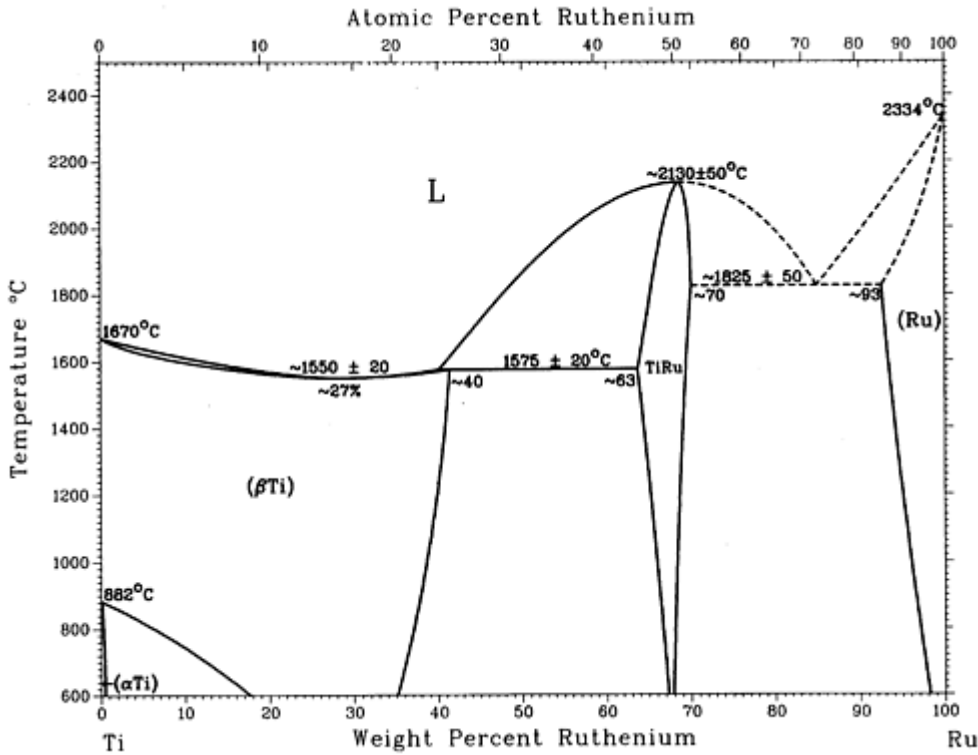

Ru-Ti phase diagram

Ru-Ti crystallographic data

Phase	Composition, wt% Ru	Pearson symbol	Space group
(β Ti)	0 to ~40	<i>cI2</i>	$Im\bar{3}m$
(α Ti)	0 to >0.2	<i>hP2</i>	$P6_3/mmc$
TiRu	~63 to ~70	<i>cP2</i>	$Pm\bar{3}m$
(Ru)	~93 to 100	<i>hP2</i>	$P6_3/mmc$
Metastable phases			
(α' Ti)	...	<i>hP2</i>	$P6_3/mmc$

$(\alpha''' \text{Ti})$...	<i>oC4</i>	<i>Cmcm</i>
ω	...	<i>hP3</i>	<i>P6/mmm</i>

Ru-V (Ruthenium - Vanadium)

J.F. Smith, 1989

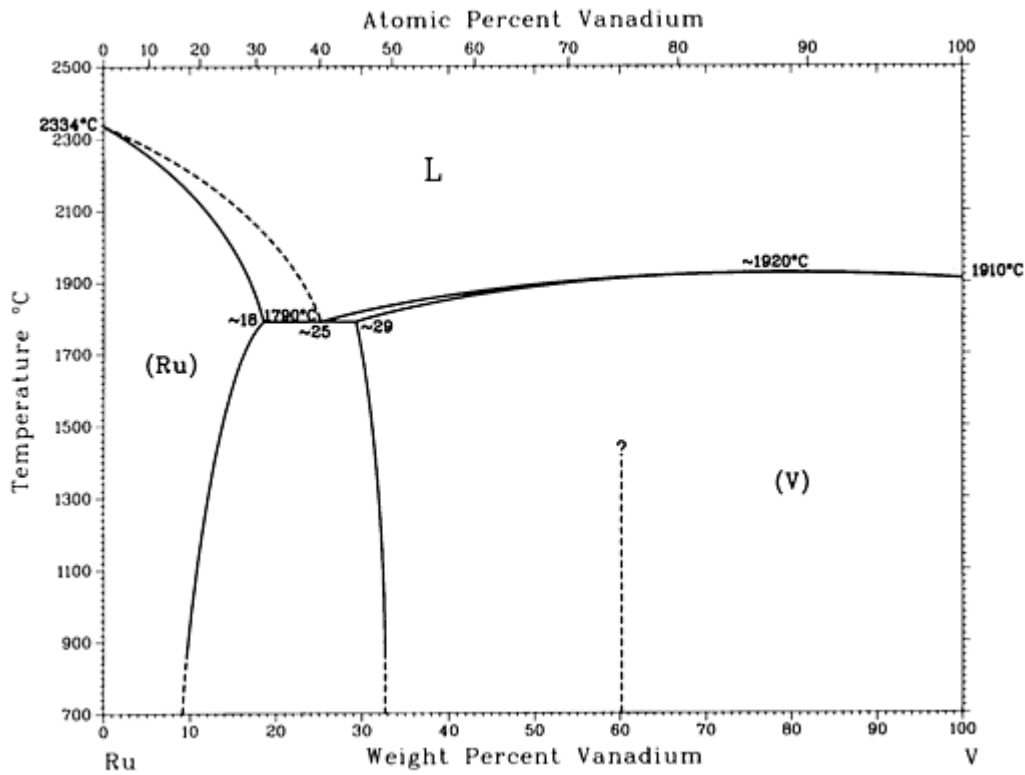

Ru-V phase diagram

Ru-V crystallographic data

Phase	Composition, wt% V	Pearson symbol	Space group
(Ru)	0 to ~18	<i>hP2</i>	<i>P6₃/mmc</i>
RuV	33.5	<i>t**</i>	...
RuV	~29 to 60	<i>cP2</i>	<i>Pm$\bar{3}$m</i>
(V)	60 to 100	<i>cI2</i>	<i>Im$\bar{3}$m</i>

Introduction

THIS ARTICLE includes systems where sulfur is the first-named element in the binary pair. Additional binary systems that include sulfur are provided in the following locations in this Volume:

- “Ag-S (Silver - Sulfur)” in the article “Ag (Silver) Binary Alloy Phase Diagrams.”
- “Al-S (Aluminum - Sulfur)” in the article “Al (Aluminum) Binary Alloy Phase Diagrams.”
- “As-S (Arsenic - Sulfur)” in the article “As (Arsenic) Binary Alloy Phase Diagrams.”
- “Bi-S (Bismuth - Sulfur)” in the article “Bi (Bismuth) Binary Alloy Phase Diagrams.”
- “Ce-S (Cerium - Sulfur)” in the article “Ce (Cerium) Binary Alloy Phase Diagrams.”
- “Co-S (Cobalt - Sulfur)” in the article “Co (Cobalt) Binary Alloy Phase Diagrams.”
- “Cr-S (Chromium - Sulfur)” in the article “Cr (Chromium) Binary Alloy Phase Diagrams.”
- “Cs-S (Cesium - Sulfur)” in the article “Cs (Cesium) Binary Alloy Phase Diagrams.”
- “Cu-S (Copper - Sulfur)” in the article “Cu (Copper) Binary Alloy Phase Diagrams.”
- “Dy-S (Dysprosium - Sulfur)” in the article “Dy (Dysprosium) Binary Alloy Phase Diagrams.”
- “Fe-S (Iron - Sulfur)” in the article “Fe (Iron) Binary Alloy Phase Diagrams.”
- “Ga-S (Gallium - Sulfur)” in the article “Ga (Gallium) Binary Alloy Phase Diagrams.”
- “Ge-S (Germanium - Sulfur)” in the article “Ge (Germanium) Binary Alloy Phase Diagrams.”
- “Hg-S (Mercury - Sulfur)” in the article “Hg (Mercury) Binary Alloy Phase Diagrams.”
- “In-S (Indium - Sulfur)” in the article “In (Indium) Binary Alloy Phase Diagrams.”
- “K-S (Potassium - Sulfur)” in the article “K (Potassium) Binary Alloy Phase Diagrams.”
- “La-S (Lanthanum - Sulfur)” in the article “La (Lanthanum) Binary Alloy Phase Diagrams.”
- “Li-S (Lithium - Sulfur)” in the article “Li (Lithium) Binary Alloy Phase Diagrams.”
- “Mo-S (Molybdenum - Sulfur)” in the article “Mo (Molybdenum) Binary Alloy Phase Diagrams.”
- “Na-S (Sodium - Sulfur)” in the article “Na (Sodium) Binary Alloy Phase Diagrams.”
- “Ni-S (Nickel - Sulfur)” in the article “Ni (Nickel) Binary Alloy Phase Diagrams.”
- “Pb-S (Lead - Sulfur)” in the article “Pb (Lead) Binary Alloy Phase Diagrams.”
- “Pd-S (Palladium - Sulfur)” in the article “Pd (Palladium) Binary Alloy Phase Diagrams.”

S-Se (Sulfur - Selenium)

R.C. Sharma and Y.A. Chang, unpublished

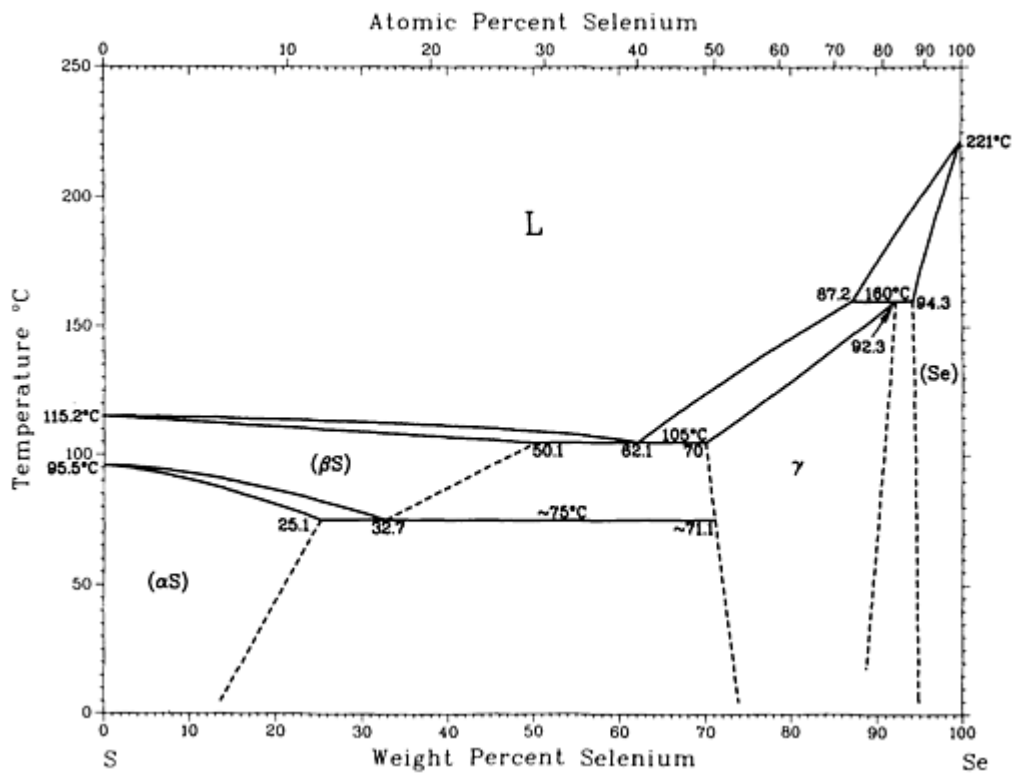

S-Se phase diagram

S-Se crystallographic data

Phase	Composition, wt% Se	Pearson symbol	Space group
(β _S)	0 to 50.1	<i>mP</i> *	<i>P2₁/c</i>
(α _S)	0 to 25.1	<i>oF128</i>	<i>Fddd</i>
γ	70 to 92.3	(a)	...
(Se)	94.3 to 100	<i>hP3</i>	<i>P3₁21</i>
High-pressure phase			
S _{0.555} Se _{0.445}	66.4	(b)	<i>P3₁</i> or <i>P3₂</i>

(a) Monoclinic.

(b) Trigonal

S-Sn (Sulfur - Tin)

R.C. Sharma and Y.A. Chang, 1986

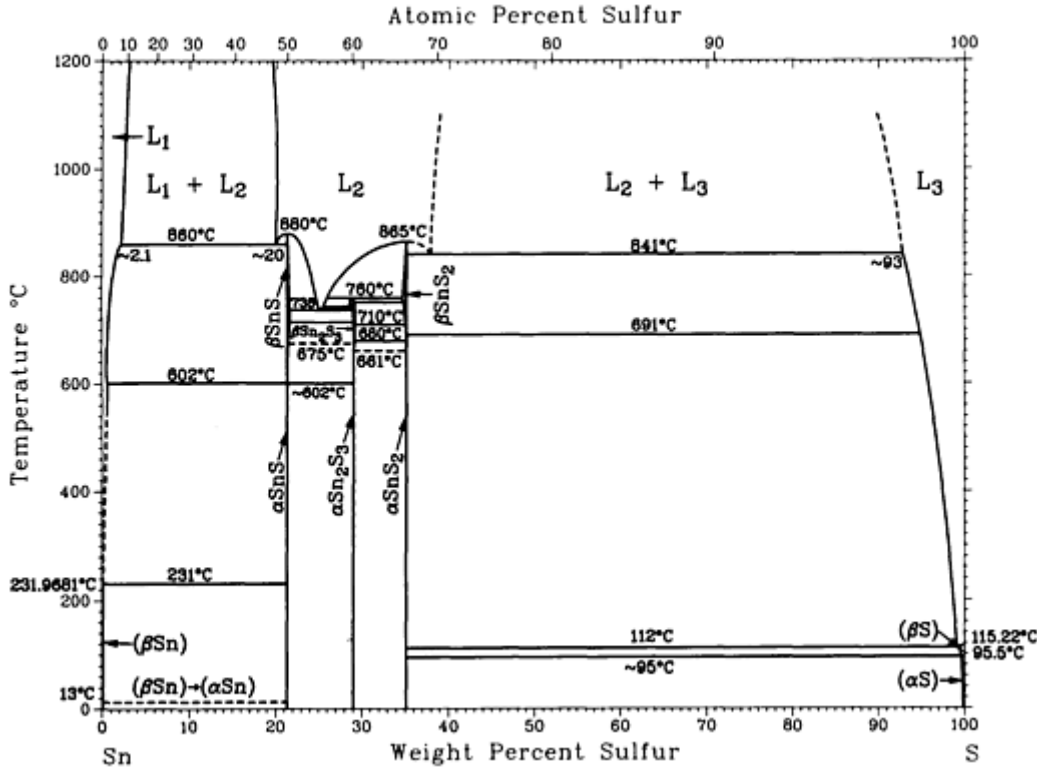

S-Sn phase diagram

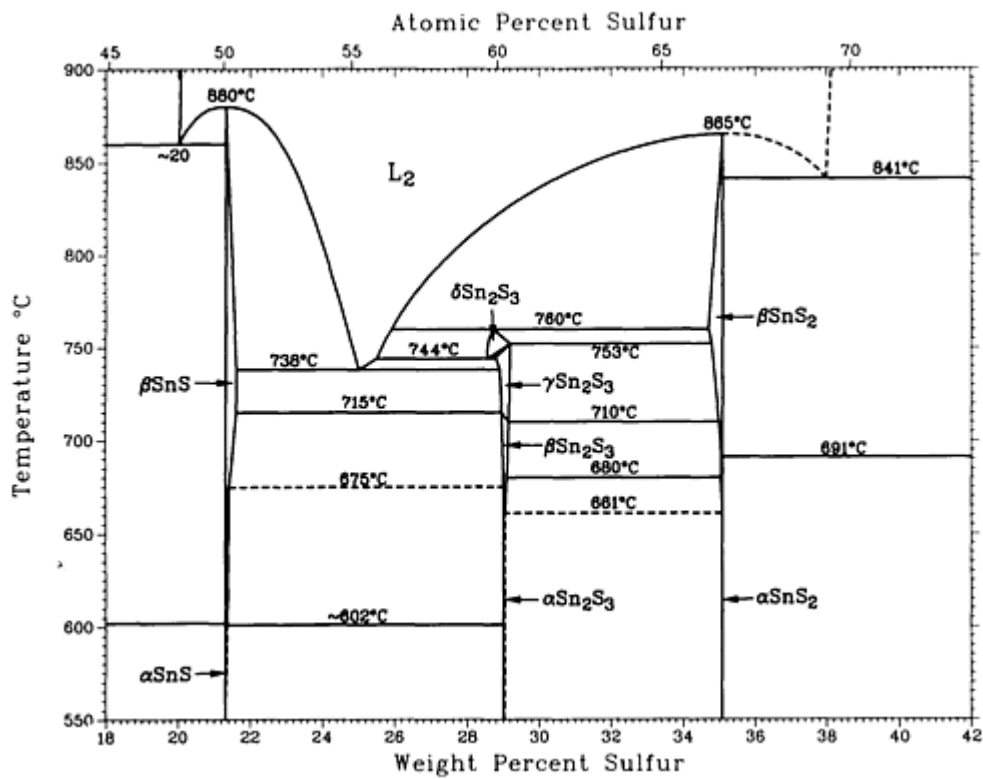

S-Sn phase diagram between 18 and 35 wt%

S-Sn crystallographic data

Phase	Composition, wt% S	Pearson symbol	Space group
(β Sn)	0	<i>tI4</i>	<i>I4₁/amd</i>
β SnS	21.3	<i>cC8</i>	<i>Cmcm</i>
α SnS	21.3	<i>oP8</i>	<i>Pnma</i>
δ Sn ₂ S ₃	29
γ Sn ₂ S ₃	29
β Sn ₂ S ₃	29
α Sn ₂ S ₃	29	<i>oP20</i>	<i>Pnma</i>
SnS ₂	35.1	<i>hP*</i> <i>hP3</i>	<i>P6₃mc</i> <i>P3m1</i>

Metastable phases			
SnS (thin film)	21.3	$cF8$	$Fm\bar{3}m$
Sn ₄ S ₅	25.3
Sn ₃ S ₄	26.4	I^{**}	...

S-Sn (Sulfur - Tin)

R.C. Sharma and Y.A. Chang, 1986

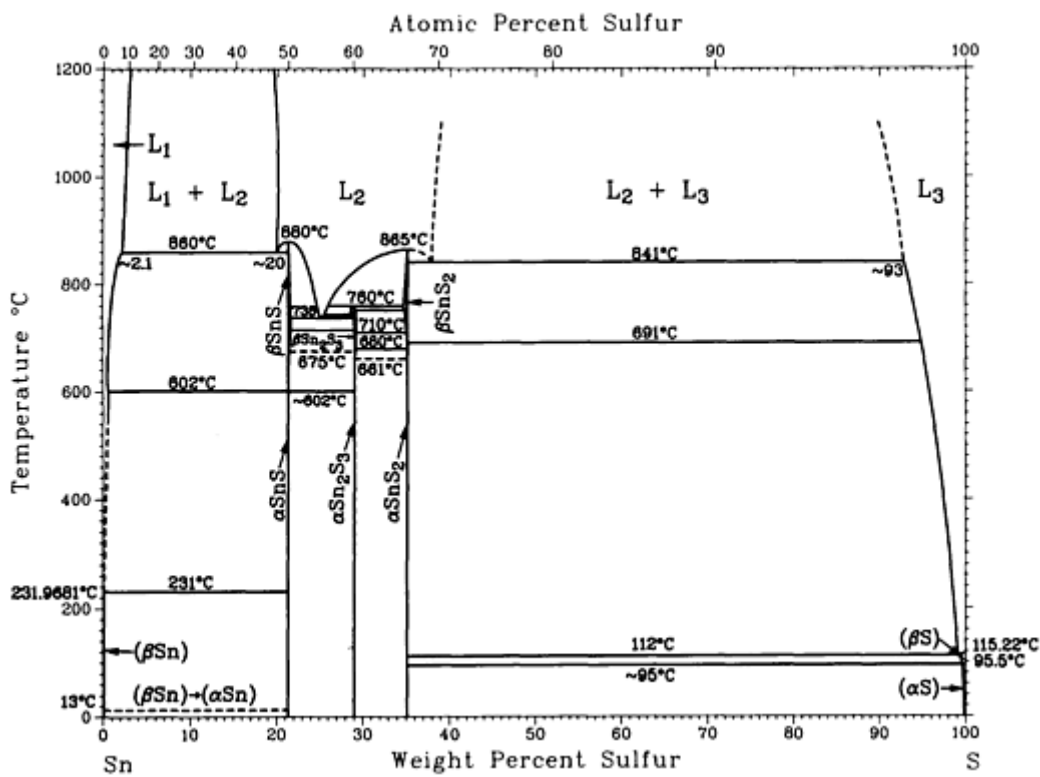

S-Sn phase diagram

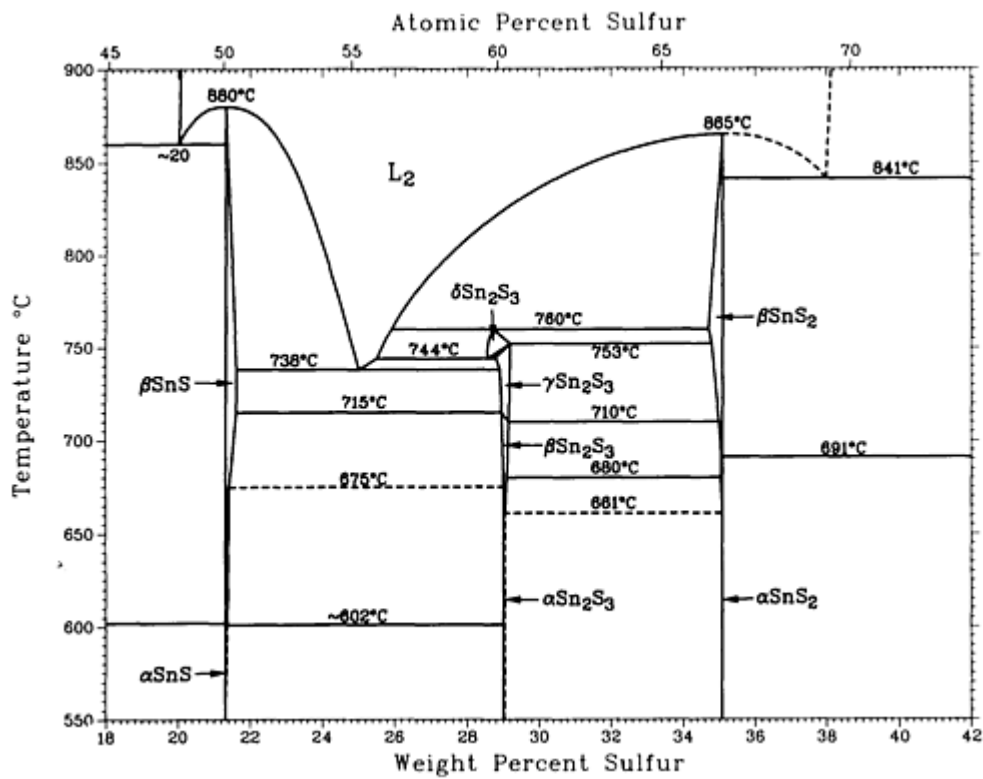

S-Sn phase diagram between 18 and 35 wt%

S-Sn crystallographic data

Phase	Composition, wt% S	Pearson symbol	Space group
(β_{Sn})	0	<i>tI4</i>	<i>I4₁/amd</i>
β_{SnS}	21.3	<i>cC8</i>	<i>Cmcm</i>
α_{SnS}	21.3	<i>oP8</i>	<i>Pnma</i>
$\delta_{\text{Sn}_2\text{S}_3}$	29
$\gamma_{\text{Sn}_2\text{S}_3}$	29
$\beta_{\text{Sn}_2\text{S}_3}$	29
$\alpha_{\text{Sn}_2\text{S}_3}$	29	<i>oP20</i>	<i>Pnma</i>
SnS ₂	35.1	<i>hP*</i> <i>hP3</i>	<i>P6₃mc</i> <i>P3m1</i>

Metastable phases			
SnS (thin film)	21.3	<i>cF8</i>	<i>Fm$\bar{3}m$</i>
Sn ₄ S ₅	25.3
Sn ₃ S ₄	26.4	<i>I</i> **	...

S-Te (Sulfur - Tellurium)

D.T. Li, R.C. Sharma, and Y.A. Chang, 1989

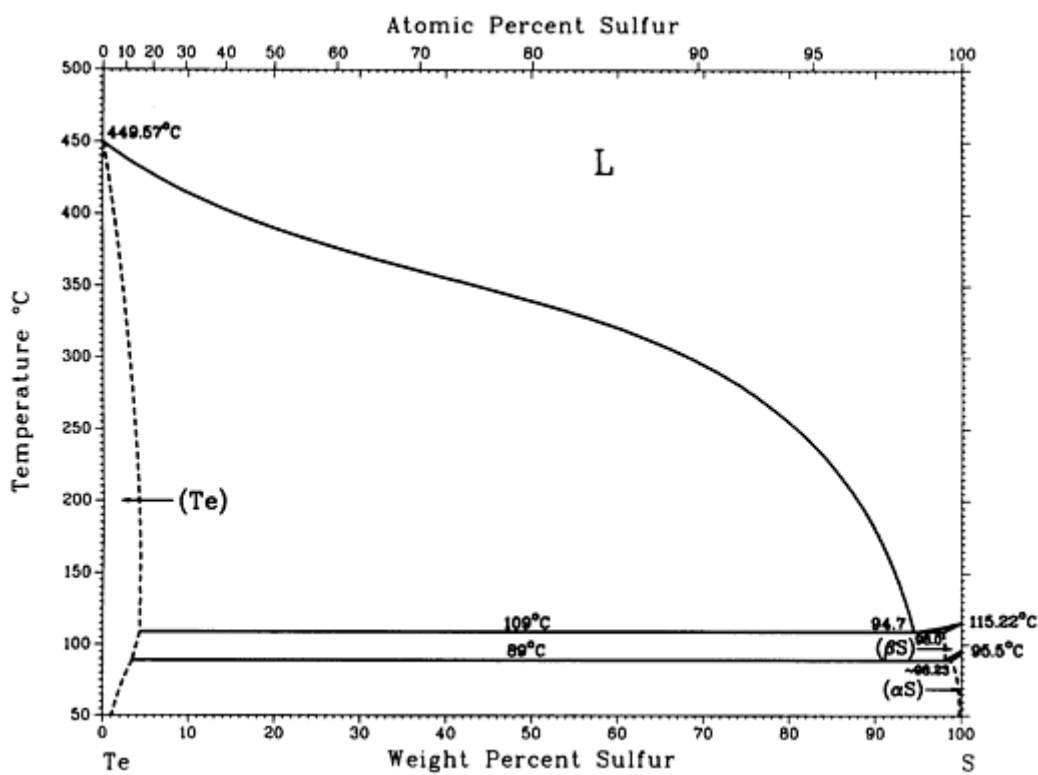

S-Te phase diagram

S-Te crystallographic data

Phase	Composition, wt% S	Pearson symbol	Space group
(Te)	0 to 40.3	<i>hP3</i>	<i>P3₁21</i>
Te ₇ S ₁₀ ^(a)	...	(b)	...
(βS)	98.0 to 100	<i>mP*</i>	<i>P2₁/c</i>

(α S)	~98.23 to 100	<i>oF128</i>	<i>Fddd</i>
---------------	---------------	--------------	-------------

(a) High-pressure phase.

(b) Pseudo-orthorhombic

S-Ti (Sulfur - Titanium)

J.L. Murray, 1987

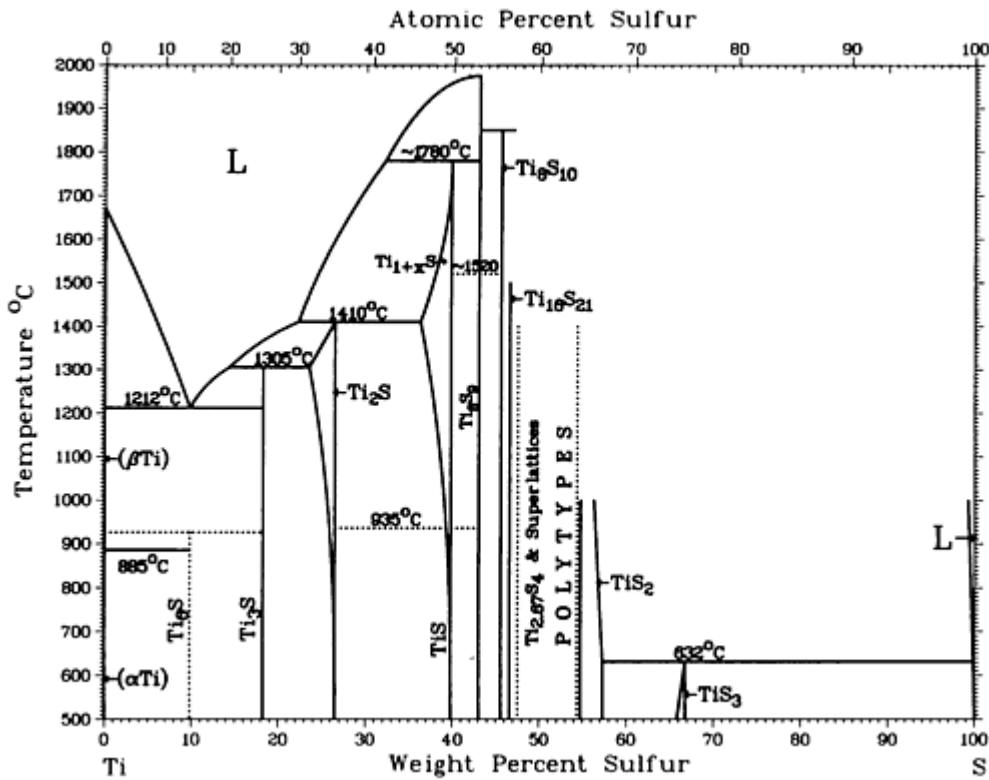

S-Ti phase diagram

S-Ti crystallographic data

Phase	Composition, wt% S	Pearson symbol	Space group
(β Ti)	0 to 0.007	<i>cI2</i>	<i>Im$\bar{3}m$</i>
(α Ti)	0 to 0.013	<i>hP2</i>	<i>P6₃/mmc</i>
Ti ₆ S	~10	(a)	...
Ti ₃ S	18	<i>t*24</i>	...

Ti ₂ S	23 to 27	^(b)	...
Ti _{1+r} S	36 to 39.8	<i>hP2</i>	<i>P6m2</i>
TiS	~39.8	<i>hP4</i>	<i>P6₃/mmc</i>
Ti ₈ S ₉	~42.6	<i>hR18</i>	<i>R3₂m</i>
Ti ₈ S ₁₀	~45.6	<i>hP18</i>	<i>P6₃/mmc</i>
Ti ₁₆ S ₂₁	~45.6	<i>hR37.1</i>	<i>R3₂m</i>
Ti _{2.67} S ₄	47.9 to 51.6	<i>hP6.8</i>	<i>P6₃mc</i>
(4H) ₂	49.9 to 50.4	<i>mC40.14</i>	<i>Cc</i>
(4H) ₃	...	<i>mC59.8</i>	<i>Cc</i>
Ti ₇ S ₁₂	~53.1	<i>hR19.1</i>	<i>R3₂m</i>
TiS ₂	54.8 to 57.3	<i>hP3</i>	<i>P3₂m</i>
TiS ₃	~67	<i>mP8</i>	<i>P2₁/m</i>
(S)	100	<i>oF128</i>	<i>Fddd</i>

(a) Hexagonal.

(b) Unknown low symmetry

Introduction

THIS ARTICLE includes systems where antimony is the first-named element in the binary pair. Additional binary systems that include antimony are provided in the following locations in this Volume:

- “Ag-Sb (Silver - Antimony)” in the article “Ag (Silver) Binary Alloy Phase Diagrams.”
- “Al-Sb (Aluminum - Antimony)” in the article “Al (Aluminum) Binary Alloy Phase Diagrams.”
- “As-Sb (Arsenic - Antimony)” in the article “As (Arsenic) Binary Alloy Phase Diagrams.”
- “Au-Sb (Gold - Antimony)” in the article “Au (Gold) Binary Alloy Phase Diagrams.”
- “Bi-Sb (Bismuth - Antimony)” in the article “Bi (Bismuth) Binary Alloy Phase Diagrams.”
- “Ca-Sb (Calcium - Antimony)” in the article “Ca (Calcium) Binary Alloy Phase Diagrams.”
- “Cd-Sb (Cadmium - Antimony)” in the article “Cd (Cadmium) Binary Alloy Phase Diagrams.”
- “Co-Sb (Cobalt - Antimony)” in the article “Co (Cobalt) Binary Alloy Phase Diagrams.”
- “Cr-Sb (Chromium - Antimony)” in the article “Cr (Chromium) Binary Alloy Phase Diagrams.”
- “Cs-Sb (Cesium - Antimony)” in the article “Cs (Cesium) Binary Alloy Phase Diagrams.”
- “Cu-Sb (Copper - Antimony)” in the article “Cu (Copper) Binary Alloy Phase Diagrams.”
- “Dy-Sb (Dysprosium - Antimony)” in the article “Dy (Dysprosium) Binary Alloy Phase Diagrams.”
- “Fe-Sb (Iron - Antimony)” in the article “Fe (Iron) Binary Alloy Phase Diagrams.”
- “Ga-Sb (Gallium - Antimony)” in the article “Ga (Gallium) Binary Alloy Phase Diagrams.”
- “Gd-Sb (Gadolinium - Antimony)” in the article “Gd (Gadolinium) Binary Alloy Phase Diagrams.”
- “Ge-Sb (Germanium - Antimony)” in the article “Ge (Germanium) Binary Alloy Phase Diagrams.”
- “Ho-Sb (Holmium - Antimony)” in the article “Ho (Holmium) Binary Alloy Phase Diagrams.”
- “In-Sb (Indium - Antimony)” in the article “In (Indium) Binary Alloy Phase Diagrams.”
- “K-Sb (Potassium - Antimony)” in the article “K (Potassium) Binary Alloy Phase Diagrams.”
- “La-Sb (Lanthanum - Antimony)” in the article “La (Lanthanum) Binary Alloy Phase Diagrams.”
- “Mg-Sb (Magnesium - Antimony)” in the article “Mg (Magnesium) Binary Alloy Phase Diagrams.”
- “Mn-Sb (Manganese - Antimony)” in the article “Mn (Manganese) Binary Alloy Phase Diagrams.”
- “Na-Sb (Sodium - Antimony)” in the article “Na (Sodium) Binary Alloy Phase Diagrams.”
- “Nd-Sb (Neodymium - Antimony)” in the article “Nd (Neodymium) Binary Alloy Phase Diagrams.”
- “Ni-Sb (Nickel - Antimony)” in the article “Ni (Nickel) Binary Alloy Phase Diagrams.”
- “Pb-Sb (Lead - Antimony)” in the article “Pb (Lead) Binary Alloy Phase Diagrams.”
- “Pd-Sb (Palladium - Antimony)” in the article “Pd (Palladium) Binary Alloy Phase Diagrams.”
- “Pr-Sb (Praseodymium - Antimony)” in the article “Pr (Praseodymium) Binary Alloy Phase Diagrams.”
- “Rb-Sb (Rubidium - Antimony)” in the article “Rb (Rubidium) Binary Alloy Phase Diagrams.”

Sb-Se (Antimony - Selenium)

H. Okamoto, 1990

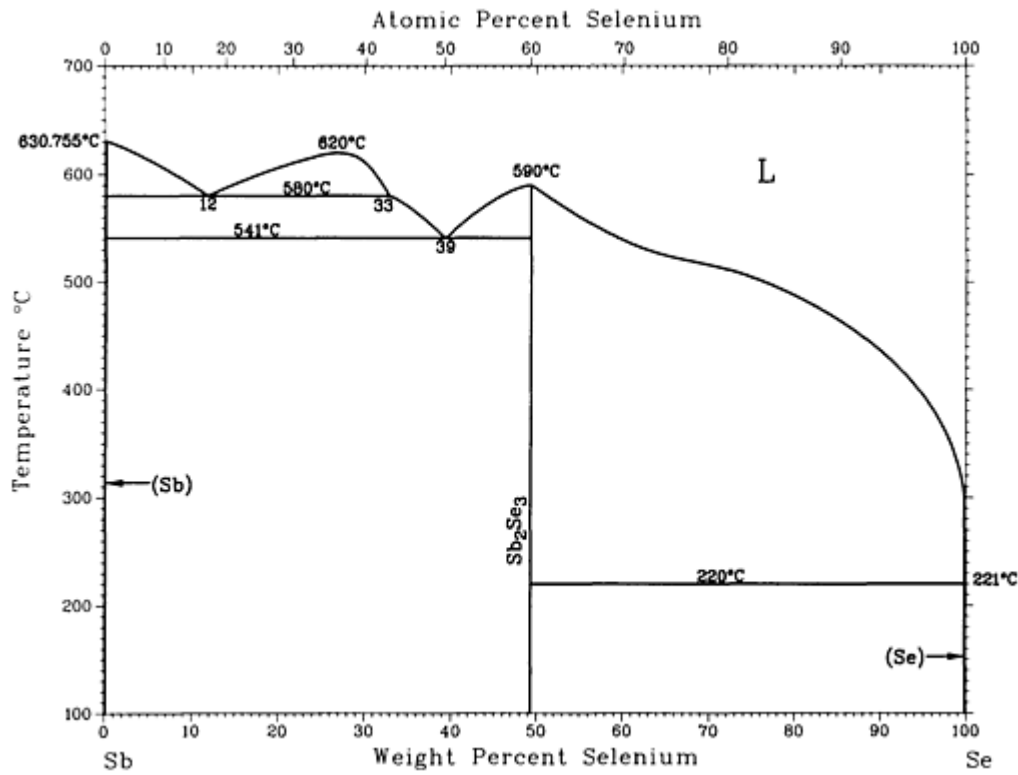

Sb-Se phase diagram

Sb-Se crystallographic data

Phase	Composition, wt% Se	Pearson symbol	Space group
(Sb)	0	<i>hR2</i>	$R\bar{3}m$
Sb ₂ Se ₃	49	<i>oP20</i>	<i>Pnma</i>
(Se)	100	<i>hP3</i>	<i>P3₁21</i>

Sb-Si (Antimony - Silicon)

R.W. Olesinski and G.J. Abbaschian, 1985

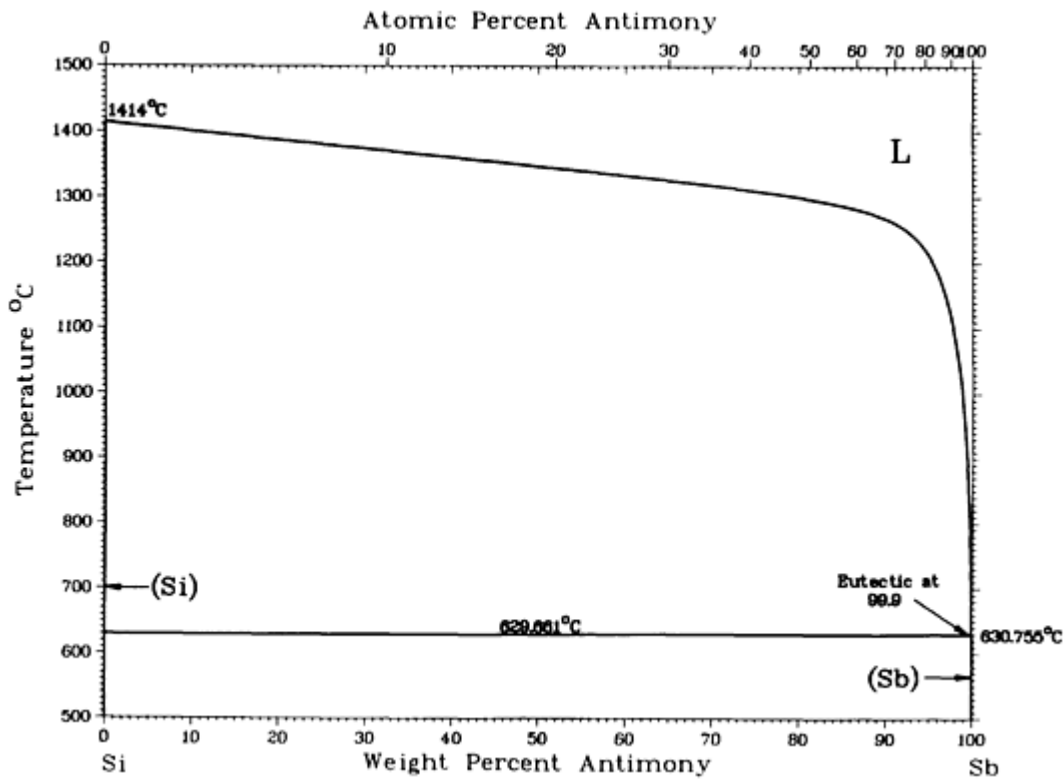

Sb-Si phase diagram

Sb-Si crystallographic data

Phase	Composition, wt% Sb	Pearson symbol	Space group
(Si)	0 to 0.09	<i>cF8</i>	$Fd\bar{3}m$
(Sb)	100	<i>hR2</i>	$R\bar{3}m$

Sb-Sm (Antimony - Samarium)

H. Okamoto, 1990

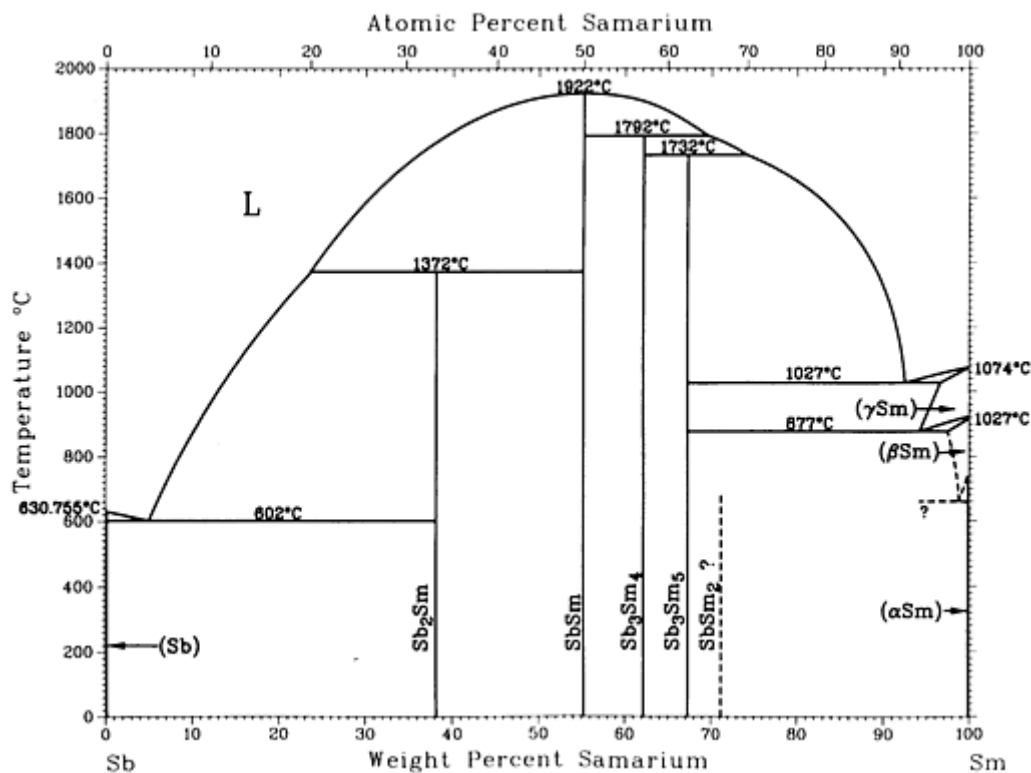

Sb-Sm phase diagram

Sb-Sm crystallographic data

Phase	Composition, wt% Sm	Pearson symbol	Space group
(Sb)	0	<i>hR2</i>	$R\bar{3}m$
Sb ₂ Sm	38.1	<i>oC24</i>	<i>Cmca</i>
SbSm	55.3	<i>cF8</i>	$Fm\bar{3}m$
Sb ₃ Sm ₄	62.2	<i>cI28</i>	$I\bar{4}3d$
Sb ₃ Sm ₅	67.3	<i>hP16</i>	$P6_3/mcm$
SbSm ₂	71.2	<i>tI12</i>	$I4/mmm$
(γSm)	100	<i>cI2</i>	$Im\bar{3}m$

(β_{Sn})	100	$hP2$	$P6_3/mmc$
(α_{Sn})	100	$hR3$	$R\bar{3}m$

Sb-Sn (Antimony - Tin)

B. Predel and W. Schwermann, 1971

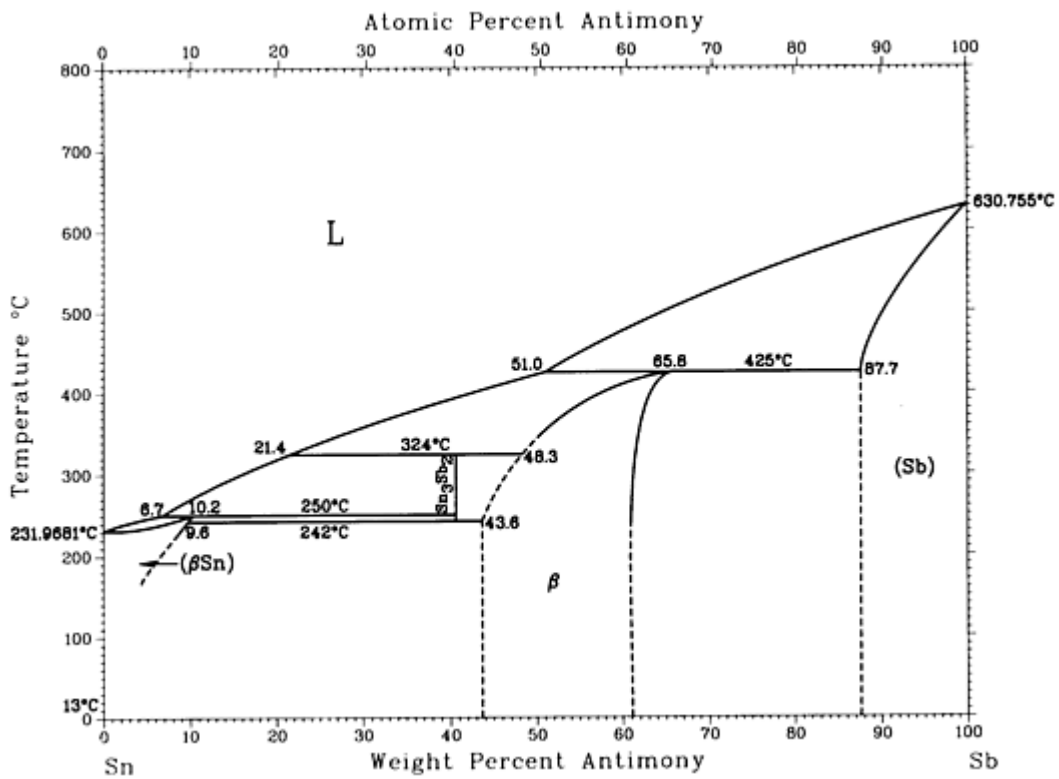

Sb-Sn phase diagram

Sb-Sn crystallographic data

Phase	Composition, wt% Sb	Pearson symbol	Space group
(β_{Sn})	0 to 9.6	$tI4$	$I4_1/amd$
Sn_3Sb_2	43.6
β	43.6 to 65.8	$cF8$	$Fm\bar{3}m$
(Sb)	87.7 to 100	$hR2$	$R\bar{3}m$

Sb-Sr (Antimony - Strontium)

A.V. Vakhobov, Z.V. Niyazova, and B.N. Polev, 1975

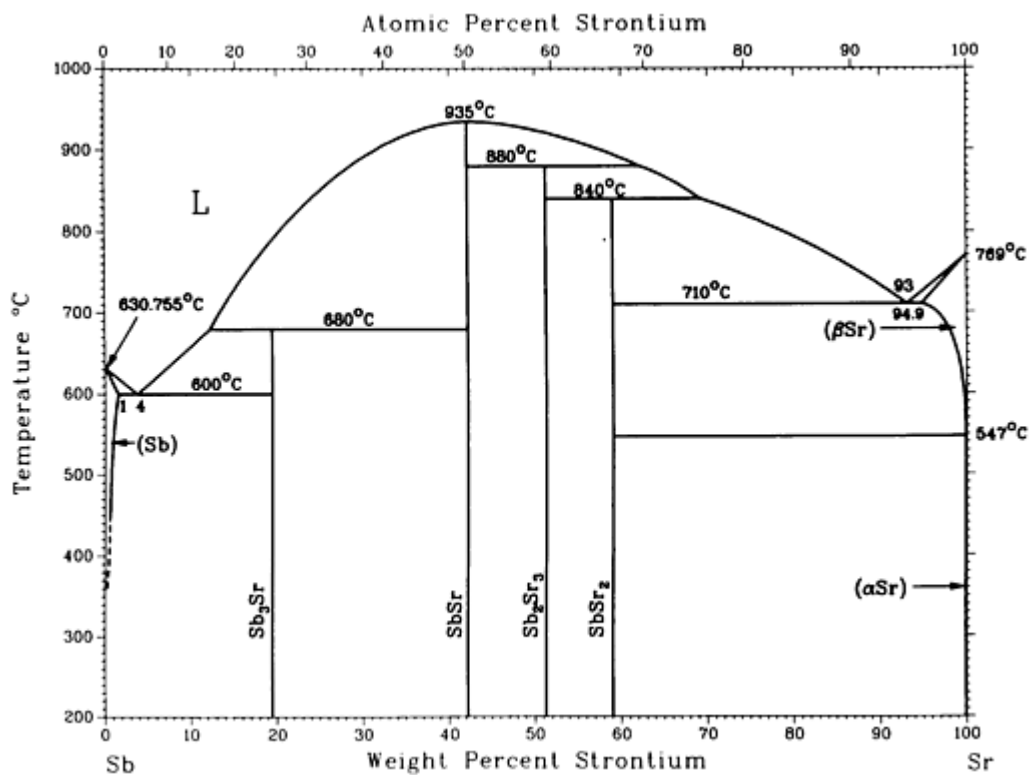

Sb-Sr phase diagram

Sb-Sr crystallographic data

Phase	Composition, wt% Sr	Pearson symbol	Space group
(Sb)	0 to 1	$hR2$	$R\bar{3}m$
Sb_3Sr	19
$SbSr$	41.8
Sb_2Sr_3	52
$SbSr_2$	59	$tI12$	$I4/mmm$
(βSr)	94.9 to 100	$cI2$	$Im\bar{3}m$
(αSr)	100	$cF4$	$Fm\bar{3}m$

Sb-Tb (Antimony - Terbium)

H. Okamoto, 1990

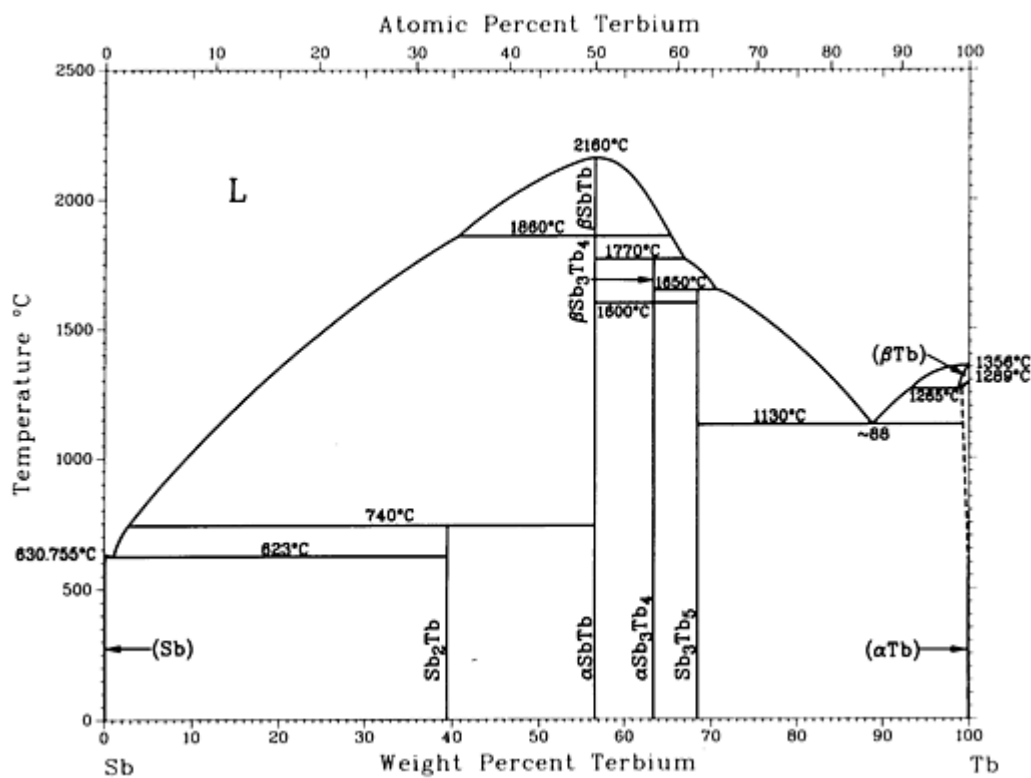

Sb-Tb phase diagram

Sb-Tb crystallographic data

Phase	Composition, wt% Tb	Pearson symbol	Space group
(Sb)	0	$hR2$	$R\bar{3}m$
Sb_2Tb	39.5	$oC24$	$Cmca$
β_{SbTb}	56.6
α_{SbTb}	56.6	$cF8$	$Fm\bar{3}m$
$\beta_{Sb_3Tb_4}$	63.5	$cI28$	$I\bar{4}3d$
$\alpha_{Sb_3Tb_4}$	63.5
Sb_3Tb_5	68.5	$hP16$	$P6_3/mcm$

(βTb)	100	$cI2$	$Im\bar{3}m$
(αTb)	100	$hP2$	$P6_3/mmc$

Sb-Te (Antimony - Tellurium)

H. Okamoto, 1990

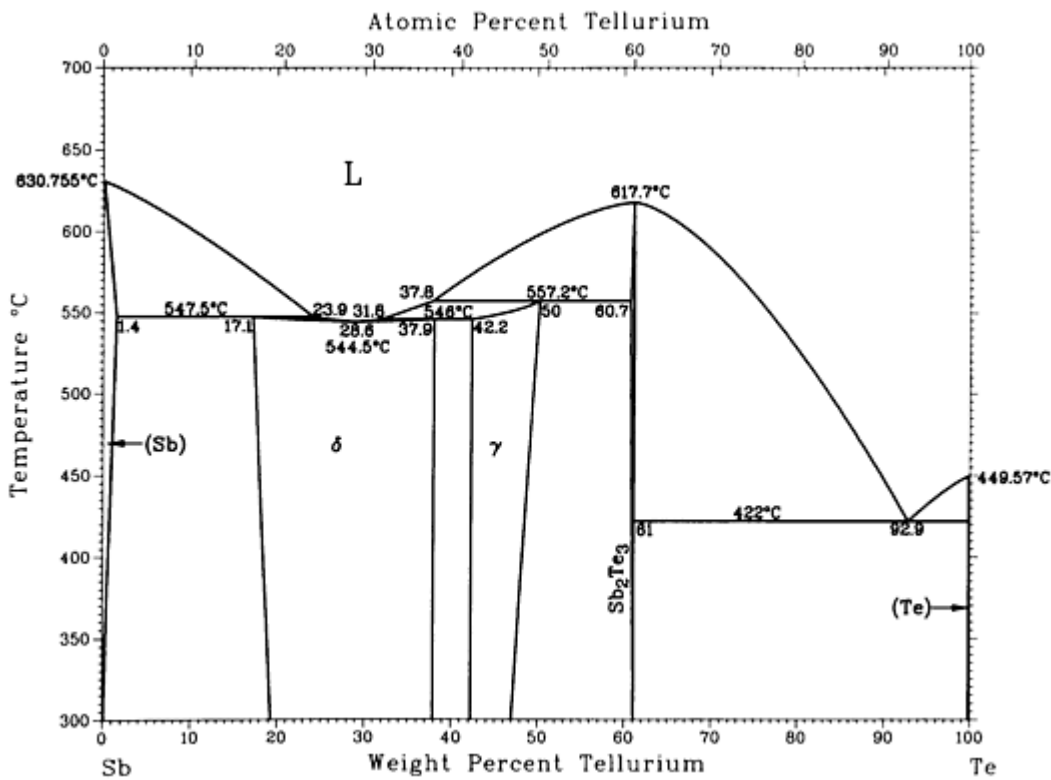

Sb-Te phase diagram

Sb-Te crystallographic data

Phase	Composition, wt% Te	Pearson symbol	Space group
(Sb)	0 to 1.4	$hR2$	$R\bar{3}m$
δ	17.1 to 37.9
γ	42.2 to 50
Sb_2Te_3	60.7 to 61	$hR5$	$R\bar{3}m$
(Te)	100	$hP3$	$P3_121$

Sb-Tl (Antimony - Thallium)

R.C. Sharma and Y.A. Chang, unpublished

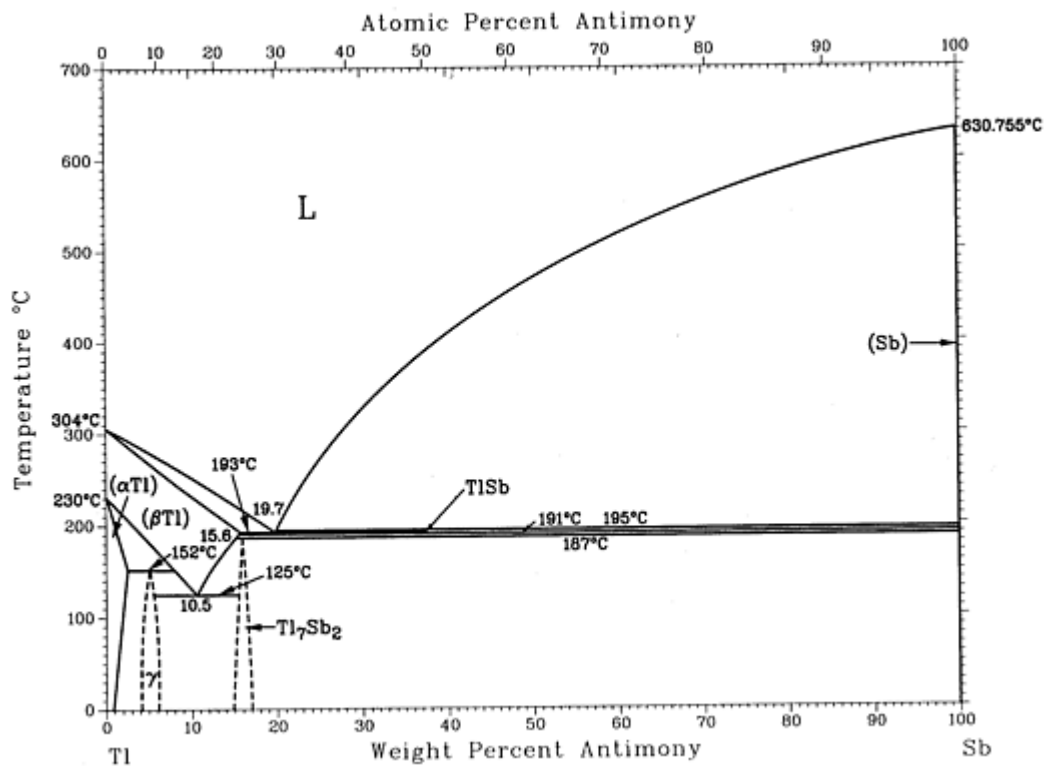

Sb-Tl phase diagram

Sb-Tl crystallographic data

Phase	Composition, wt% Sb	Pearson symbol	Space group
(β _{Tl})	0 to 15.6	<i>cI2</i>	<i>Im</i> $\bar{3}m$
(α _{Tl})	0 to 2	<i>hP2</i>	<i>P6</i> ₃ <i>mmc</i>
γ	4.0 to 6.0	<i>cF*</i>	...
Tl ₇ Sb ₂	14.7 to 16.9	<i>cI54</i>	<i>Im</i> $\bar{3}m$
TlSb	37.3
(Sb)	100	<i>hR2</i>	<i>R</i> $\bar{3}m$

Sb-U (Antimony - Uranium)

P. Chiotti, 1980

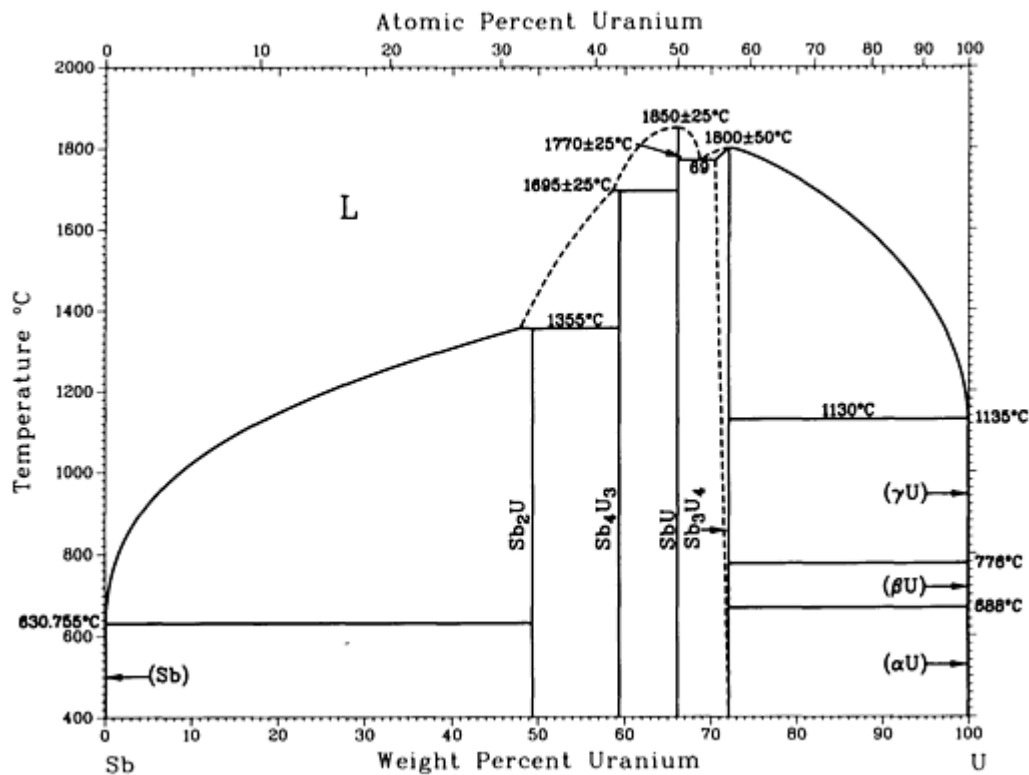

Sb-U phase diagram

Sb-U crystallographic data

Phase	Composition, wt% U	Pearson symbol	Space group
(Sb)	0	<i>hR2</i>	$R\bar{3}m$
Sb ₂ U	49.4	<i>tP6</i>	$P4/nmm$
Sb ₄ U ₃ ^(a)	59.5	<i>cI28</i>	$I\bar{4}3d$
SbU	66.2	<i>cF8</i>	$Fm\bar{3}m$
Sb ₃ U ₄	72.2	...	$P6_3/mcm$
(γU)	100	<i>cI2</i>	$Im\bar{3}m$
(βU)	100	<i>tP30</i>	$P4_2/mnm$

(α U)	100	<i>oC4</i>	<i>Cmcm</i>
---------------	-----	------------	-------------

(a) Evidence for ferromagnetic ordering of Sb_4U_3 has been presented.

Sb-Y (Antimony - Yttrium)

F.A. Schmidt and O.D. McMasters, 1970

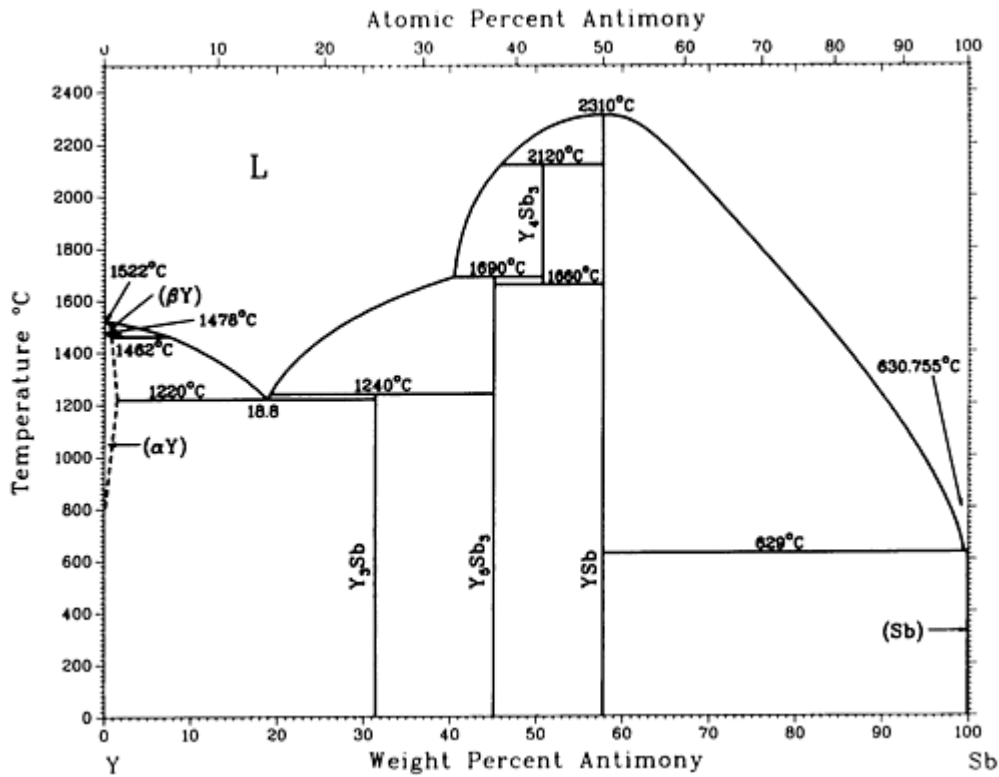

Sb-Y phase diagram

Sb-Y crystallographic data

Phase	Composition, wt% Sb	Pearson symbol	Space group
(β Y)	0 to 2.7	<i>cI2</i>	<i>Im$\bar{3}m$</i>
(α Y)	0 to 1.4	<i>hP2</i>	<i>P6$_3$/mmc</i>
Y_3Sb	31	<i>tP32</i>	<i>P4$_2$/n</i>
Y_5Sb_3	45.1	<i>hP16</i>	<i>P6$_3$/mcm</i>

Y_4Sb_3	50.7	$cI28$	$I\bar{4}3d$
YSb	57.8	$cF8$	$Fm\bar{3}m$
(Sb)	100	$hR2$	$R\bar{3}m$

Sb-Zn (Antimony - Zinc)

G. Vuillard and J.P. Piton, 1966; and T. Takei, 1927

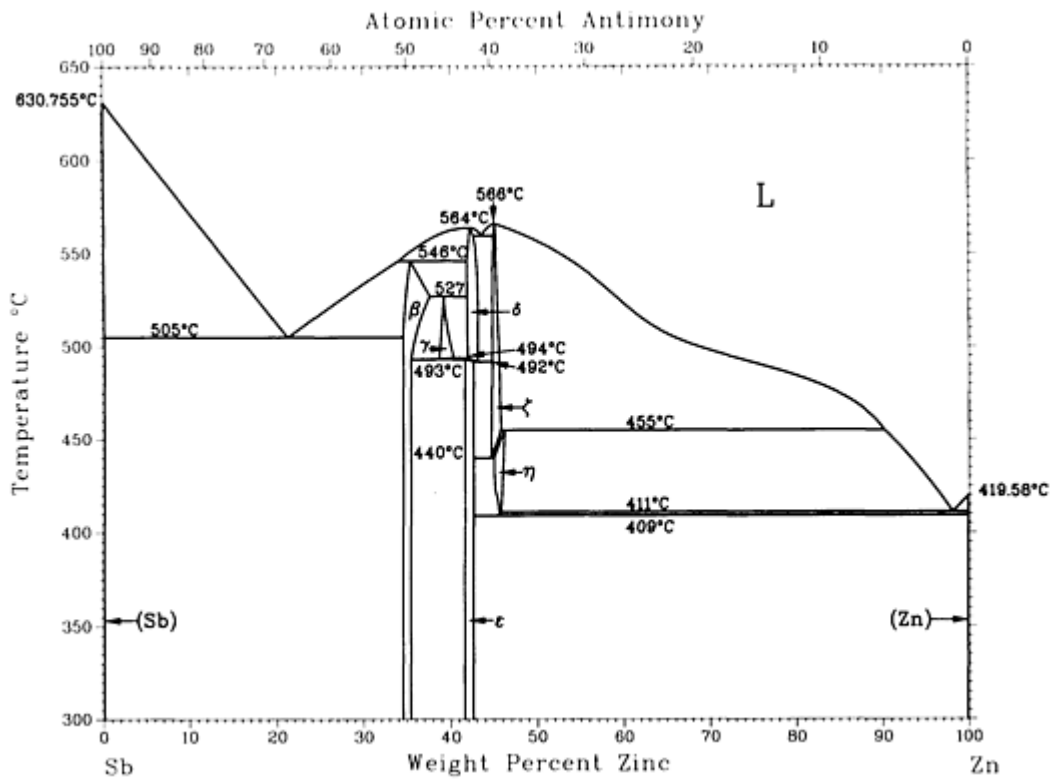

Sb-Zn phase diagram

Sb-Zn crystallographic data

Phase	Composition, wt% Zn	Pearson symbol	Space group
(Sb)	0	$hR2$	$R\bar{3}m$
β	~ 34.9 to ~ 38	$oP16$	$Pbca$
γ	39 to 41

ε	42 to 43	(a)	...
δ	42 to \sim 43.1	(a)	...
ζ	45 to 46	oI^*	...
η	45 to \sim 46	$oP30$	$Pmmn$
(Zn)	100	$hP2$	$P6_3/mmc$

(a) Sb_3Zn_4 (δ , ε ?): $hR22$ or $oP28$ or mC^* ?

Sc (Scandium) Binary Alloy Phase Diagrams

Introduction

THIS ARTICLE includes systems where scandium is the first-named element in the binary pair. Additional binary systems that include scandium are provided in the following locations in this Volume:

- “Ag-Sc (Silver - Scandium)” in the article “Ag (Silver) Binary Alloy Phase Diagrams.”
- “B-Sc (Boron - Scandium)” in the article “B (Boron) Binary Alloy Phase Diagrams.”
- “C-Sc (Carbon - Scandium)” in the article “C (Carbon) Binary Alloy Phase Diagrams.”
- “Cr-Sc (Chromium - Scandium)” in the article “Cr (Chromium) Binary Alloy Phase Diagrams.”
- “Fe-Sc (Iron - Scandium)” in the article “Fe (Iron) Binary Alloy Phase Diagrams.”
- “Ga-Sc (Gallium - Scandium)” in the article “Ga (Gallium) Binary Alloy Phase Diagrams.”
- “Ge-Sc (Germanium - Scandium)” in the article “Ge (Germanium) Binary Alloy Phase Diagrams.”
- “In-Sc (Indium - Scandium)” in the article “In (Indium) Binary Alloy Phase Diagrams.”
- “La-Sc (Lanthanum - Scandium)” in the article “La (Lanthanum) Binary Alloy Phase Diagrams.”
- “Mg-Sc (Magnesium - Scandium)” in the article “Mg (Magnesium) Binary Alloy Phase Diagrams.”
- “Ni-Sc (Nickel - Scandium)” in the article “Ni (Nickel) Binary Alloy Phase Diagrams.”
- “Pu-Sc (Plutonium - Scandium)” in the article “Pu (Plutonium) Binary Alloy Phase Diagrams.”

Sc-Ti (Scandium - Titanium)

J.L. Murray, 1987

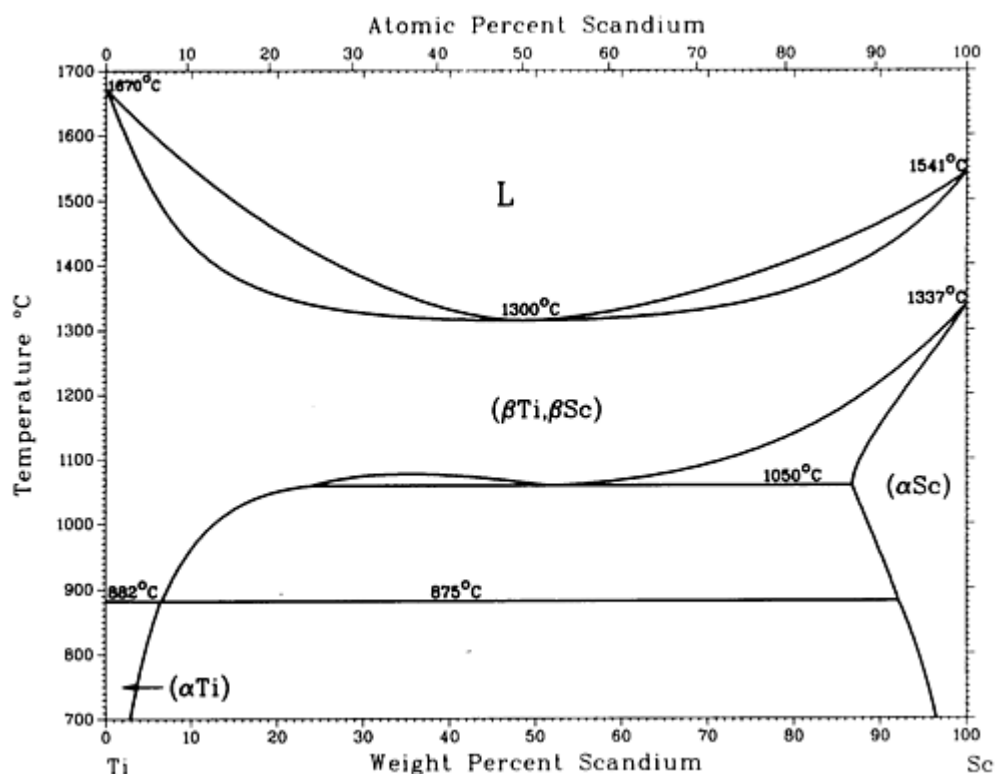

Sc-Ti phase diagram

Sc-Ti crystallographic data

Phase	Composition, wt% Sc	Pearson symbol	Space group

(β_{Ti}, β_{Sc})	0 to 100	$cI2$	$Im\bar{3}m$
(αTi)	0 to 7.4	$hP2$	$P6_3/mmc$
(αSc)	88.2 to 100	$hP2$	$P6_3/mmc$

Sc-Y (Scandium - Yttrium)

K.A. Gschneidner, Jr. and F.W. Calderwood, 1983

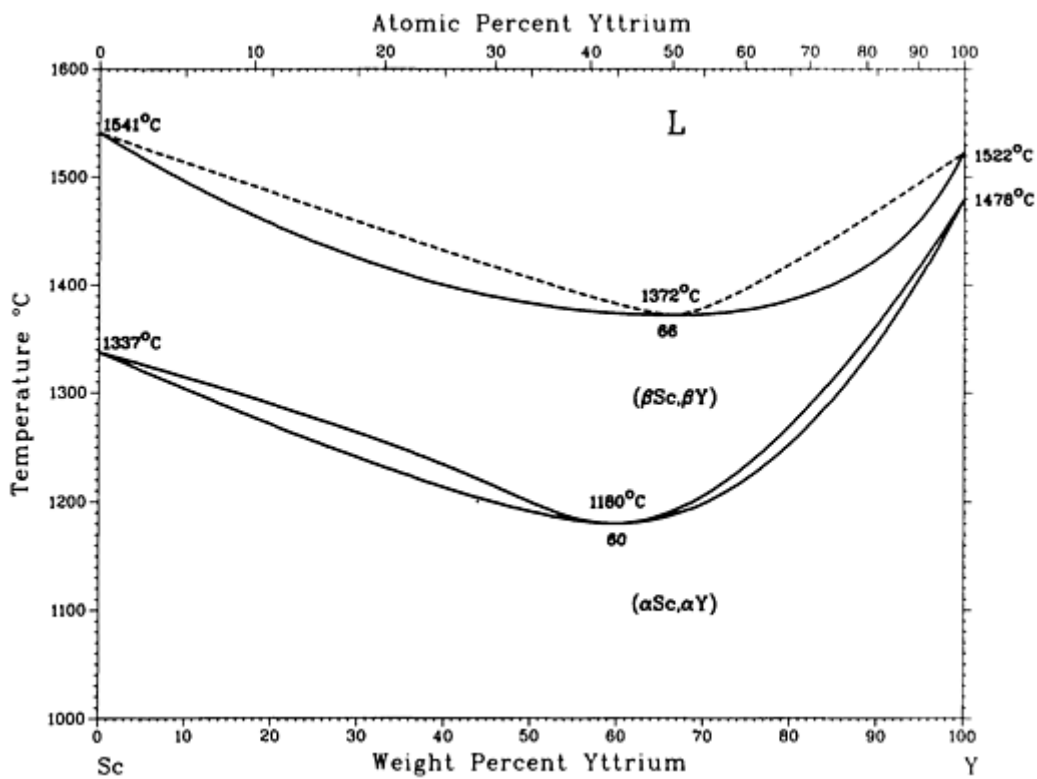

Sc-Y phase diagram

Sc-Y crystallographic data

Phase	Composition, wt% Y	Pearson symbol	Space group
(β_{Sc}, β_Y)	0 to 100	$cI2$	$Im\bar{3}m$
$(\alpha Sc, \alpha Y)$	0 to 100	$hP2$	$P6_3/mmc$

Sc-Zr (Scandium - Zirconium)

A. Palenzona and S. Cirafici, 1991

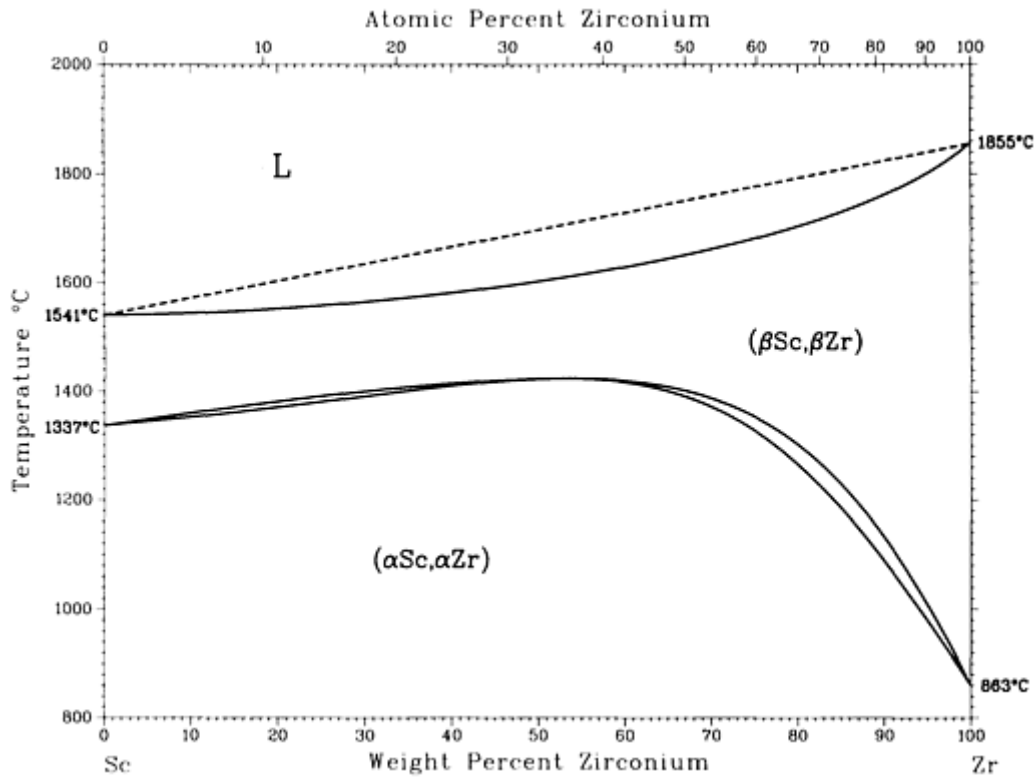

Sc-Zr phase diagram

Sc-Zr crystallographic data

Phase	Composition, wt% Zr	Pearson symbol	Space group
(β _{Sc} ,β _{Zr})	0 to 100	<i>cI2</i>	<i>Im</i> $\bar{3}m$
(α _{Sc} ,α _{Zr})	0 to 100	<i>hP2</i>	<i>P6</i> ₃ / <i>mmc</i>

Sc-Y (Scandium - Yttrium)

K.A. Gschneidner, Jr. and F.W. Calderwood, 1983

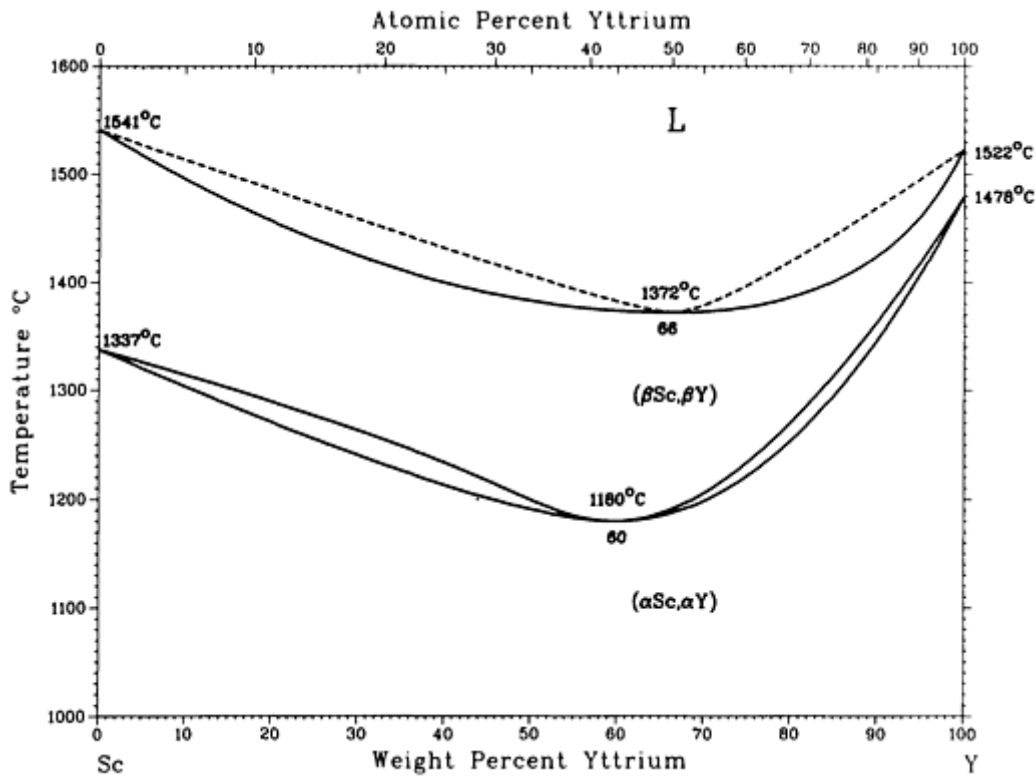

Sc-Y phase diagram

Sc-Y crystallographic data

Phase	Composition, wt% Y	Pearson symbol	Space group
$(\beta_{\text{Sc}}, \beta_{\text{Y}})$	0 to 100	<i>cI2</i>	<i>Im</i> $\bar{3}m$
$(\alpha_{\text{Sc}}, \alpha_{\text{Y}})$	0 to 100	<i>hP2</i>	<i>P6</i> $_3$ / <i>mmc</i>

Sc-Zr (Scandium - Zirconium)

A. Palenzona and S. Cirafici, 1991

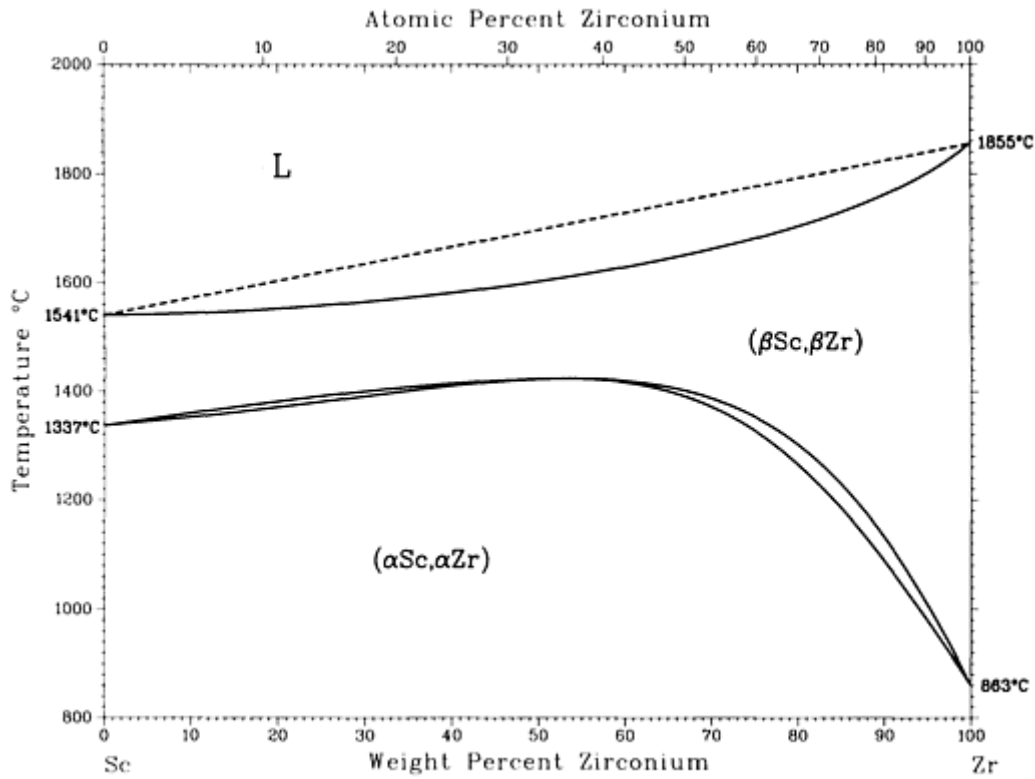

Sc-Zr phase diagram

Sc-Zr crystallographic data

Phase	Composition, wt% Zr	Pearson symbol	Space group
(β _{Sc} ,β _{Zr})	0 to 100	<i>cI2</i>	<i>Im</i> $\bar{3}m$
(α _{Sc} ,α _{Zr})	0 to 100	<i>hP2</i>	<i>P6</i> ₃ / <i>mmc</i>

Se (Selenium) Binary Alloy Phase Diagrams

Introduction

THIS ARTICLE includes systems where selenium is the first-named element in the binary pair. Additional binary systems that include selenium are provided in the following locations in this Volume:

- “Ag-Se (Silver - Selenium)” in the article “Ag (Silver) Binary Alloy Phase Diagrams.”
- “Al-Se (Aluminum - Selenium)” in the article “Al (Aluminum) Binary Alloy Phase Diagrams.”
- “As-Se (Arsenic - Selenium)” in the article “As (Arsenic) Binary Alloy Phase Diagrams.”
- “Au-Se (Gold - Selenium)” in the article “Au (Gold) Binary Alloy Phase Diagrams.”
- “Ba-Se (Barium - Selenium)” in the article “Ba (Barium) Binary Alloy Phase Diagrams.”
- “Bi-Se (Bismuth - Selenium)” in the article “Bi (Bismuth) Binary Alloy Phase Diagrams.”
- “Cd-Se (Cadmium - Selenium)” in the article “Cd (Cadmium) Binary Alloy Phase Diagrams.”
- “Co-Se (Cobalt - Selenium)” in the article “Co (Cobalt) Binary Alloy Phase Diagrams.”
- “Cr-Se (Chromium - Selenium)” in the article “Cr (Chromium) Binary Alloy Phase Diagrams.”
- “Cs-Se (Cesium - Selenium)” in the article “Cs (Cesium) Binary Alloy Phase Diagrams.”
- “Cu-Se (Copper - Selenium)” in the article “Cu (Copper) Binary Alloy Phase Diagrams.”
- “Er-Se (Erbium - Selenium)” in the article “Er (Erbium) Binary Alloy Phase Diagrams.”
- “Fe-Se (Iron - Selenium)” in the article “Fe (Iron) Binary Alloy Phase Diagrams.”
- “Ga-Se (Gallium - Selenium)” in the article “Ga (Gallium) Binary Alloy Phase Diagrams.”
- “Gd-Se (Gadolinium - Selenium)” in the article “Gd (Gadolinium) Binary Alloy Phase Diagrams.”
- “Ge-Se (Germanium - Selenium)” in the article “Ge (Germanium) Binary Alloy Phase Diagrams.”
- “Hg-Se (Mercury - Selenium)” in the article “Hg (Mercury) Binary Alloy Phase Diagrams.”
- “In-Se (Indium - Selenium)” in the article “In (Indium) Binary Alloy Phase Diagrams.”
- “K-Se (Potassium - Selenium)” in the article “K (Potassium) Binary Alloy Phase Diagrams.”
- “La-Se (Lanthanum - Selenium)” in the article “La (Lanthanum) Binary Alloy Phase Diagrams.”
- “Li-Se (Lithium - Selenium)” in the article “Li (Lithium) Binary Alloy Phase Diagrams.”
- “Na-Se (Sodium - Selenium)” in the article “Na (Sodium) Binary Alloy Phase Diagrams.”
- “Ni-Se (Nickel - Selenium)” in the article “Ni (Nickel) Binary Alloy Phase Diagrams.”
- “Pb-Se (Lead - Selenium)” in the article “Pb (Lead) Binary Alloy Phase Diagrams.”
- “Pd-Se (Palladium - Selenium)” in the article “Pd (Palladium) Binary Alloy Phase Diagrams.”
- “Pr-Se (Praseodymium - Selenium)” in the article “Pr (Praseodymium) Binary Alloy Phase Diagrams.”
- “Rb-Se (Rubidium - Selenium)” in the article “Rb (Rubidium) Binary Alloy Phase Diagrams.”
- “Rh-Se (Rhodium - Selenium)” in the article “Rh (Rhodium) Binary Alloy Phase Diagrams.”
- “S-Se (Sulfur - Selenium)” in the article “S (Sulfur) Binary Alloy Phase Diagrams.”
- “Sb-Se (Antimony - Selenium)” in the article “Sb (Antimony) Binary Alloy Phase Diagrams.”

Se-Sn (Selenium - Tin)

R.C. Sharma and Y.A. Chang, 1986

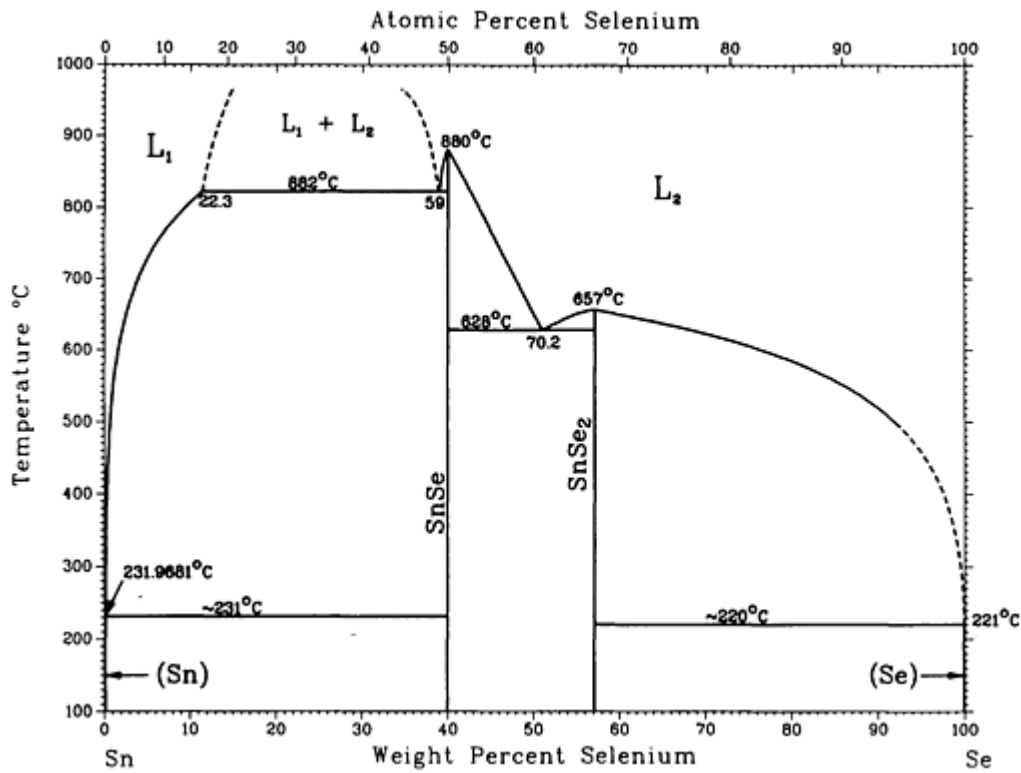

Se-Sn phase diagram

Se-Sn crystallographic data

Phase	Composition, wt% Se	Pearson symbol	Space group
(Sn)	0	<i>tI4</i>	<i>I4₁amd</i>
SnSe	39.9	<i>oP8</i>	<i>Pnma</i>
SnSe ₂	57.1	<i>hP3</i>	<i>P$\bar{3}m1$</i>
(Se)	100	<i>hP3</i>	<i>P3₁21</i>

Se-Sr (Selenium - Strontium)

Yu.B. Lyskova and A.V. Vakhobov, 1975

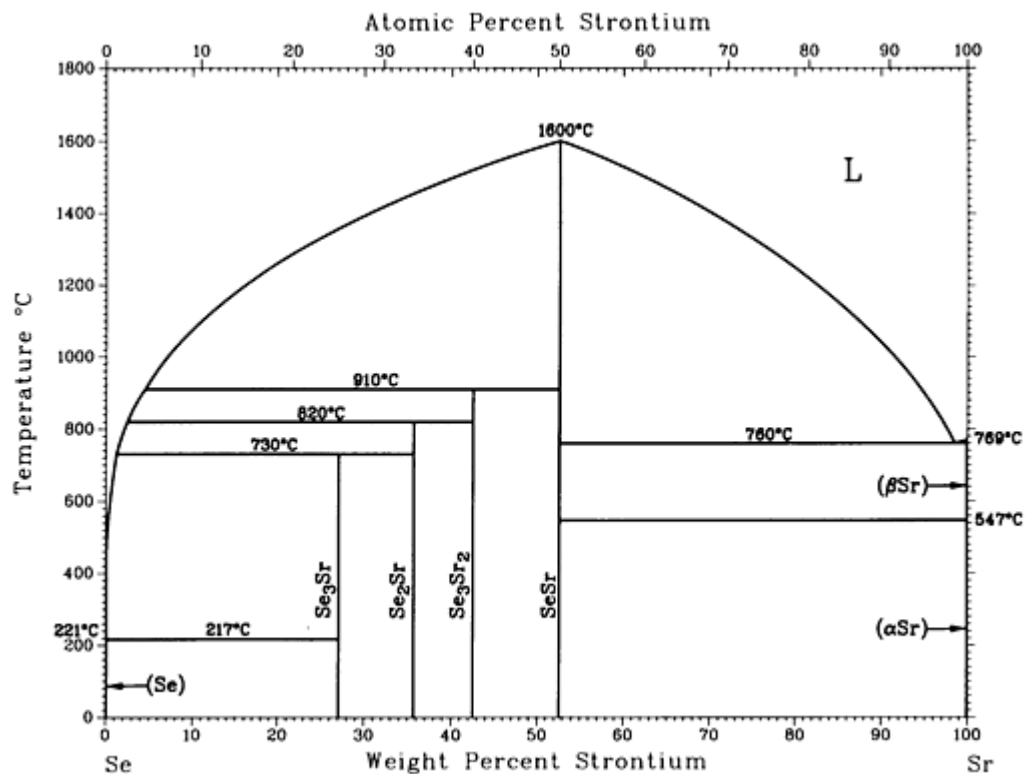

Se-Sr phase diagram

Se-Sr crystallographic data

Phase	Composition, wt% Sr	Pearson symbol	Space group
(Se)	0	<i>hP3</i>	<i>P3₁21</i>
Se ₃ Sr	27
Se ₂ Sr	35.7
Se ₃ Sr ₂	43
SeSr	52.6	<i>cF8</i>	<i>Fm$\bar{3}m$</i>
(β _{Sr})	100	<i>cI2</i>	<i>Im$\bar{3}m$</i>

(α Sr)	100	<i>cF4</i>	<i>Fm</i> $\bar{3}m$
----------------	-----	------------	----------------------

Se-Te (Selenium - Tellurium)

R.C. Sharma, D.T. Li, and Y.A. Chang, unpublished

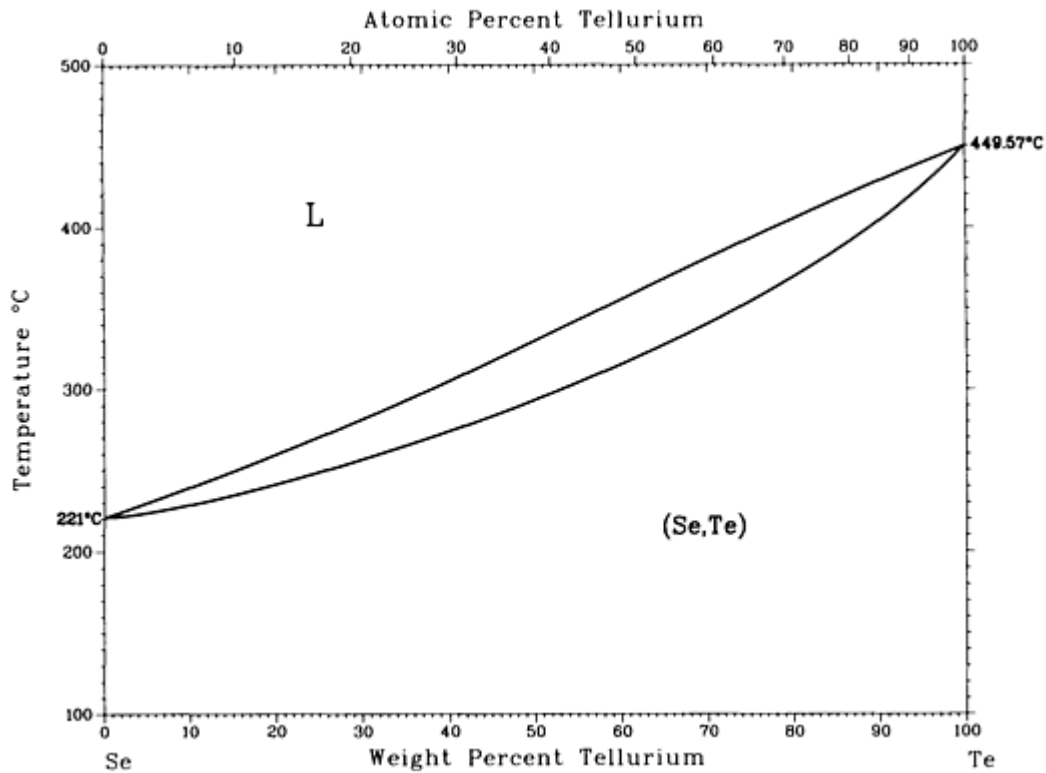

Se-Te phase diagram

Se-Te crystallographic data

Phase	Composition, wt% Te	Pearson symbol	Space group
(Se,Te)	0 to 100	<i>hP3</i>	<i>P3</i> ₁ 21

Se-Tl (Selenium - Thallium)

G. Morgant, B. Legendre, S. Mareglier-Lacordaire, and C. Souleau, 1981

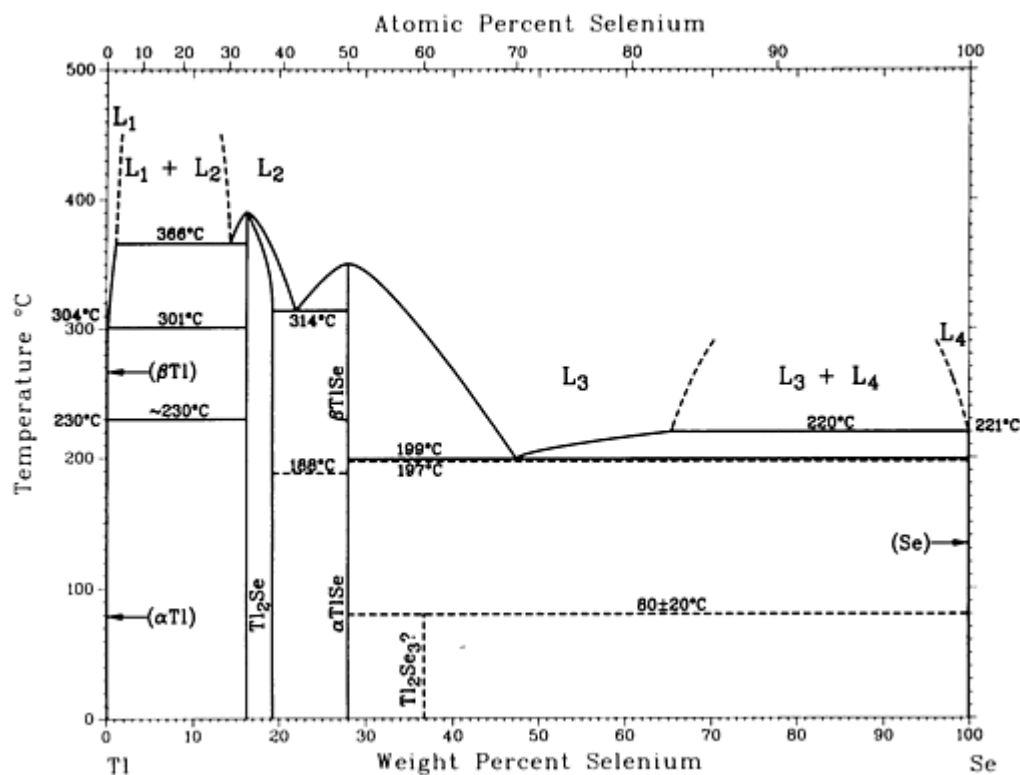

Se-Tl phase diagram

Se-Tl crystallographic data

Phase	Composition, wt% Se	Pearson symbol	Space group
(β _{Tl})	0	<i>cI2</i>	<i>Im</i> $\bar{3}m$
(α _{Tl})	0	<i>hP2</i>	<i>P6</i> ₃ <i>/mmc</i>
Tl ₂ Se	16.5 to 19	<i>tP32</i>	<i>P4/ncc</i>
β _{TlSe}	27.9	<i>tI16</i>	<i>I4/mcm</i>
α _{TlSe}	27.9
Tl ₂ Se ₃ ?	37	<i>hP4</i>	<i>P6</i> ₃ <i>mc</i>

(Se)	100	<i>hP3</i>	<i>P3₁21</i>
------	-----	------------	-------------------------

Se-Tm (Selenium - Thulium)

H. Okamoto, 1990

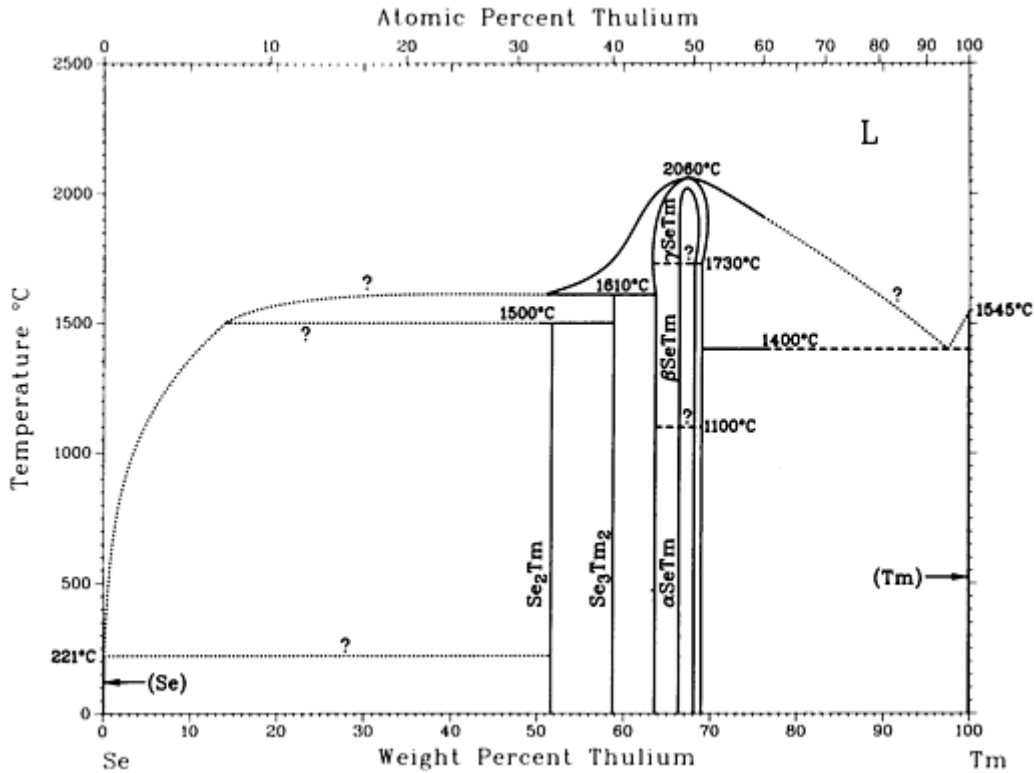

Se-Tm phase diagram

Se-Tm crystallographic data

Phase	Composition, wt% Tm	Pearson symbol	Space group
(γ Se)	0	<i>hP3</i>	<i>P3₁21</i>
Se ₂ Tm	51.6	<i>tP6</i>	<i>P4/nmm</i>
Se ₃ Tm ₂	59	<i>oF80</i>	<i>Fddd</i>
γ SeTm	64 to 69	<i>cF8</i>	<i>Fm$\bar{3}m$</i>
β SeTm	65 to 69

α SeTm	65 to 69
(Tm)	100	<i>hP2</i>	<i>P6₃/mmc</i>

Note: "SeTm" is Se₆Tm₅ on the Se-rich side and SeTm_{1.05} on the Tm-rich side.

Si (Silicon) Binary Alloy Phase Diagrams

Introduction

THIS ARTICLE includes systems where silicon is the first-named element in the binary pair. Additional binary systems that include silicon are provided in the following locations in this Volume:

- "Ag-Si (Silver - Silicon)" in the article "Ag (Silver) Binary Alloy Phase Diagrams."
- "Al-Si (Aluminum - Silicon)" in the article "Al (Aluminum) Binary Alloy Phase Diagrams."
- "As-Si (Arsenic - Silicon)" in the article "As (Arsenic) Binary Alloy Phase Diagrams."
- "Au-Si (Gold - Silicon)" in the article "Au (Gold) Binary Alloy Phase Diagrams."
- "B-Si (Boron - Silicon)" in the article "B (Boron) Binary Alloy Phase Diagrams."
- "Ba-Si (Barium - Silicon)" in the article "Ba (Barium) Binary Alloy Phase Diagrams."
- "Be-Si (Beryllium - Silicon)" in the article "Be (Beryllium) Binary Alloy Phase Diagrams."
- "C-Si (Carbon - Silicon)" in the article "C (Carbon) Binary Alloy Phase Diagrams."
- "Ca-Si (Calcium - Silicon)" in the article "Ca (Calcium) Binary Alloy Phase Diagrams."
- "Ce-Si (Cerium - Silicon)" in the article "Ce (Cerium) Binary Alloy Phase Diagrams."
- "Co-Si (Cobalt - Silicon)" in the article "Co (Cobalt) Binary Alloy Phase Diagrams."
- "Cr-Si (Chromium - Silicon)" in the article "Cr (Chromium) Binary Alloy Phase Diagrams."
- "Cu-Si (Copper - Silicon)" in the article "Cu (Copper) Binary Alloy Phase Diagrams."
- "Fe-Si (Iron - Silicon)" in the article "Fe (Iron) Binary Alloy Phase Diagrams."
- "Ge-Si (Germanium - Silicon)" in the article "Ge (Germanium) Binary Alloy Phase Diagrams."
- "Hf-Si (Hafnium - Silicon)" in the article "Hf (Hafnium) Binary Alloy Phase Diagrams."
- "In-Si (Indium - Silicon)" in the article "In (Indium) Binary Alloy Phase Diagrams."
- "Li-Si (Lithium - Silicon)" in the article "Li (Lithium) Binary Alloy Phase Diagrams."
- "Mg-Si (Magnesium - Silicon)" in the article "Mg (Magnesium) Binary Alloy Phase Diagrams."
- "Mn-Si (Manganese - Silicon)" in the article "Mn (Manganese) Binary Alloy Phase Diagrams."
- "Mo-Si (Molybdenum - Silicon)" in the article "Mo (Molybdenum) Binary Alloy Phase Diagrams."
- "Nb-Si (Niobium - Silicon)" in the article "Nb (Niobium) Binary Alloy Phase Diagrams."
- "Nd-Si (Neodymium - Silicon)" in the article "Nd (Neodymium) Binary Alloy Phase Diagrams."
- "Ni-Si (Nickel - Silicon)" in the article "Ni (Nickel) Binary Alloy Phase Diagrams."
- "Os-Si (Osmium - Silicon)" in the article "Os (Osmium) Binary Alloy Phase Diagrams."
- "Pd-Si (Palladium - Silicon)" in the article "Pd (Palladium) Binary Alloy Phase Diagrams."
- "Pr-Si (Praseodymium - Silicon)" in the article "Pr (Praseodymium) Binary Alloy Phase Diagrams."
- "Pt-Si (Platinum - Silicon)" in the article "Pt (Platinum) Binary Alloy Phase Diagrams."
- "Re-Si (Rhenium - Silicon)" in the article "Re (Rhenium) Binary Alloy Phase Diagrams."
- "Ru-Si (Ruthenium - Silicon)" in the article "Ru (Ruthenium) Binary Alloy Phase Diagrams."
- "Sb-Si (Antimony - Silicon)" in the article "Sb (Antimony) Binary Alloy Phase Diagrams."

Si-Sn (Silicon - Tin)

R.W. Olesinski and G.J. Abbaschian, 1984

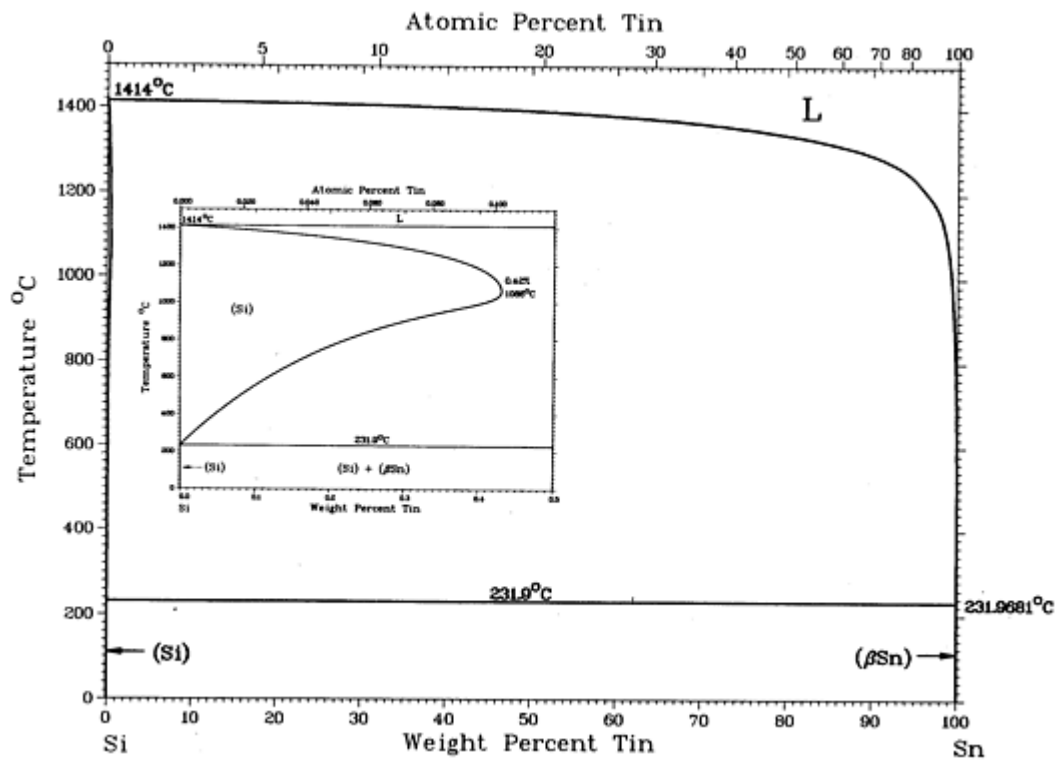

Si-Sn phase diagram

Si-Sn crystallographic data

Phase	Composition, wt% Sn	Pearson symbol	Space group
(Si)	0 to 0.42	<i>cF8</i>	<i>Fd$\bar{3}m$</i>
(β Sn)	100	<i>tI4</i>	<i>I4₁/amd</i>
(α Sn)	100	<i>cF8</i>	<i>Fd$\bar{3}m$</i>

Si-Sr (Silicon - Strontium)

V.P. Itkin and C.B. Alcock, 1989

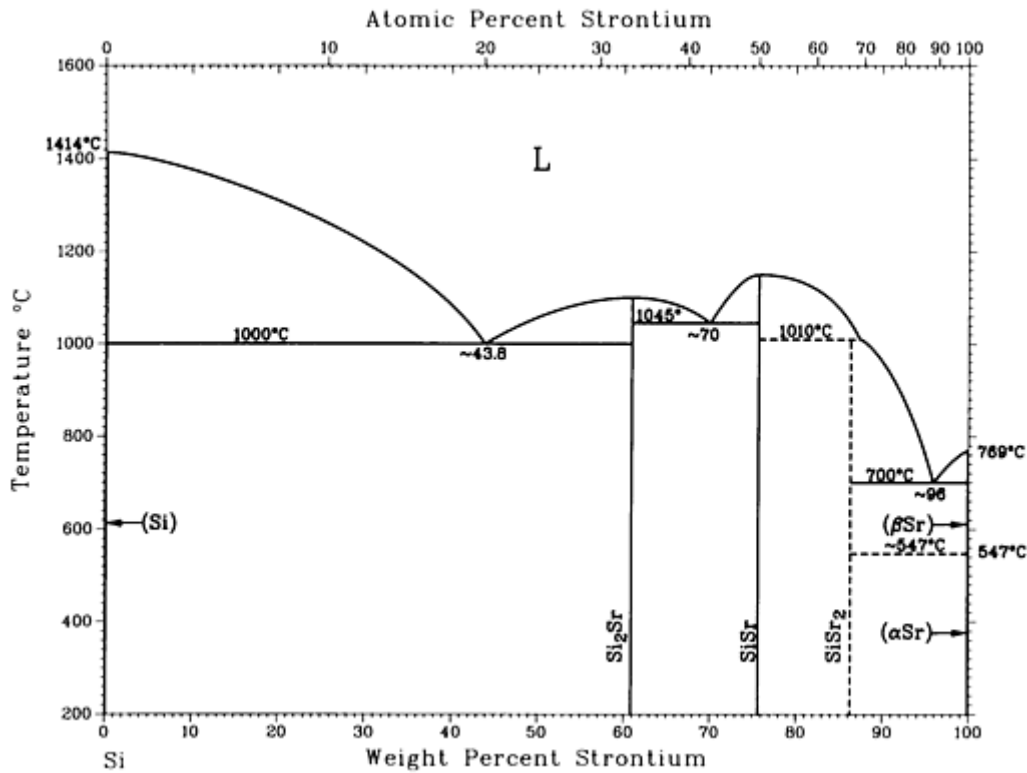

Si-Sr phase diagram

Si-Sr crystallographic data

Phase	Composition, wt% Sr	Pearson symbol	Space group
(Si)	0	<i>cF8</i>	<i>Fd$\bar{3}m$</i>
Si_2Sr	60.9	<i>cP12</i>	<i>P4$_3$32</i>
SiSr	75.7	<i>oC8</i>	<i>Cmcm</i>
$SiSr_2$	86.2	<i>oP12</i>	<i>Pnma</i>
(βSr)	100	<i>cI2</i>	<i>Im$\bar{3}m$</i>
(αSr)	100	<i>cF4</i>	<i>Fm$\bar{3}m$</i>

Other possible phases			
Si_7Sr_4	64.0 to 68 ^(a)	<i>tI12</i>	<i>I4₁/amd</i>
αSiSr	75.7	<i>oI40</i>	<i>Immm</i>
Si_3Sr_5	83.9	<i>tI32</i>	<i>I4cm</i>
High-pressure, metastable phase			
$\text{Si}_2\text{Sr(II)}$	60.9	<i>tI12</i>	<i>I4₁/amd</i>

(a) Possible speculative homogeneity range

Si-Ta (Silicon - Tantalum)

M.E. Schlesinger, unpublished

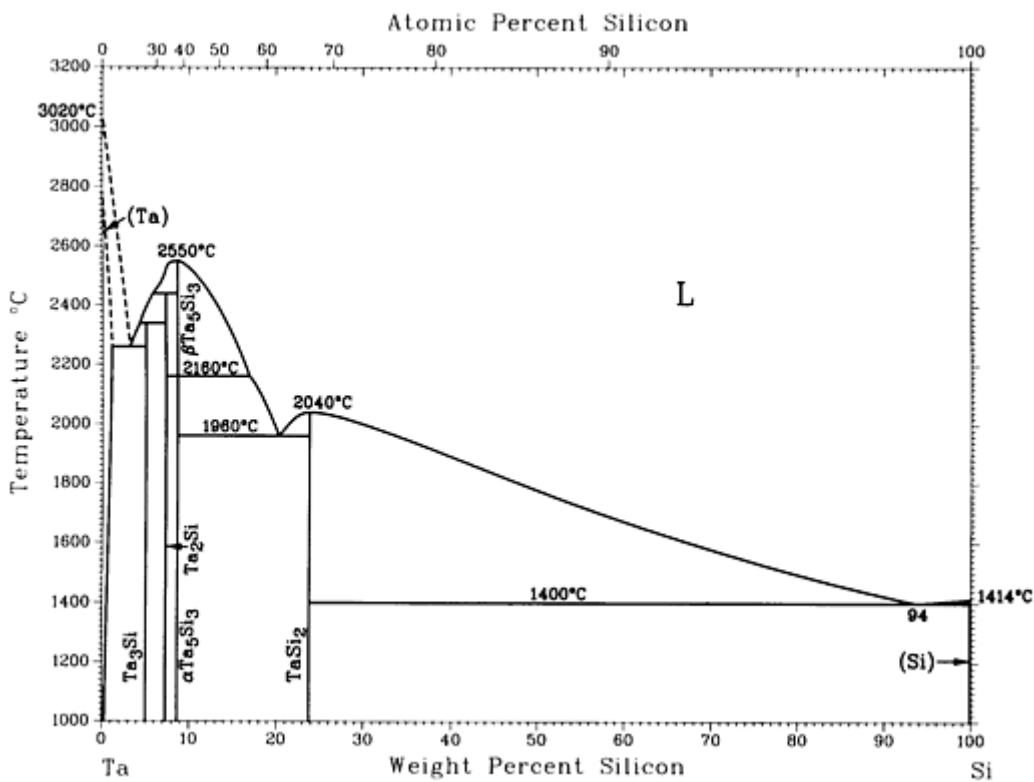

Si-Ta phase diagram

Si-Ta crystallographic data

Phase	Composition, wt% Si	Pearson symbol	Space group
(Ta)	0 to ~1	<i>cI2</i>	<i>Im$\bar{3}m$</i>
Ta ₃ Si	5	<i>tP32</i>	<i>P4₂/n</i>
Ta ₂ Si	7.2	<i>tI12</i>	<i>I4/m</i>
β -Ta ₅ Si ₃	8.5	<i>tI32</i>	<i>I4/mcm</i>
α -Ta ₅ Si ₃	8.5	<i>tI32</i>	<i>I4/mcm</i>
TaSi ₂	23.7	<i>hP9</i>	<i>P6₂22</i>
Si	100	<i>cF8</i>	<i>Fd$\bar{3}m$</i>
Metastable phases			
Ta _{4,5} Si	3.5	<i>hP8</i>	<i>P6₃/mmc</i>
Ta ₅ Si ₃	8.5	<i>hP16</i>	<i>P6₃/mcm</i>

Si-Te (Silicon - Tellurium)

T.G. Davey and E.H. Baker, 1980

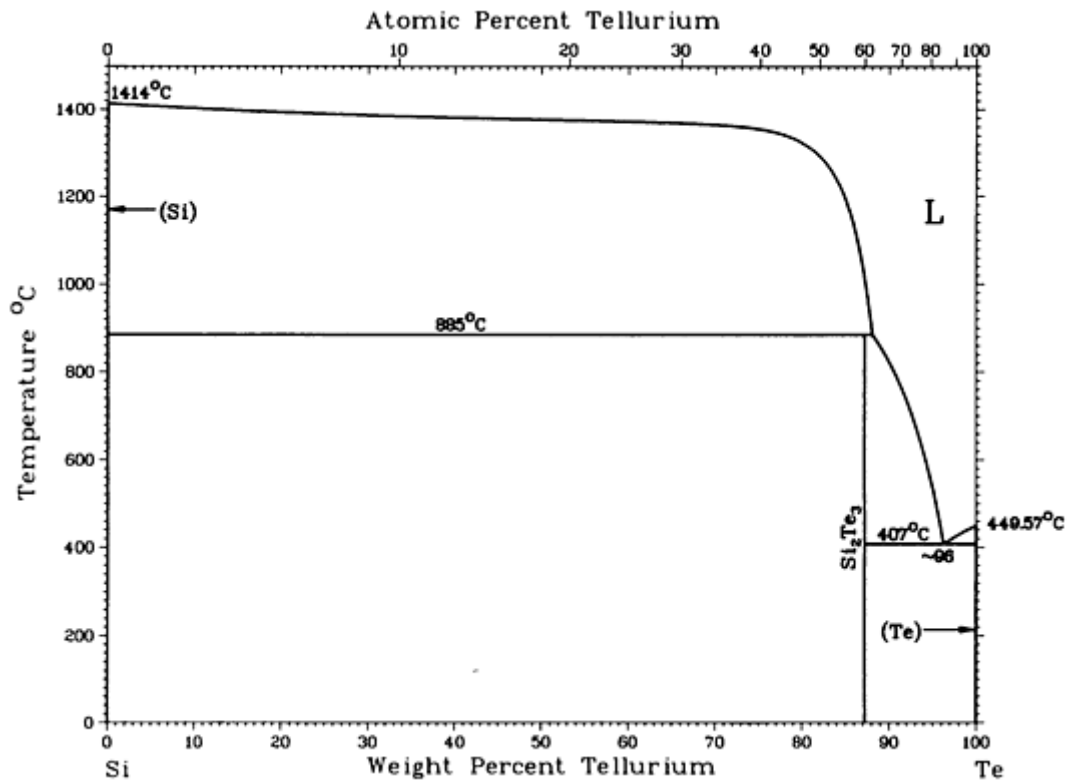

Si-Te phase diagram

Si-Te crystallographic data

Phase	Composition, wt% Te	Pearson symbol	Space group
(Si)	0	<i>cF8</i>	<i>Fd$\bar{3}m$</i>
Si ₂ Te ₃	87	<i>hP40</i>	<i>P$\bar{3}1c$</i>
(Te)	100	<i>hP3</i>	<i>P3₁21</i>

Si-Th (Silicon - Thorium)

From [Thorium] 20

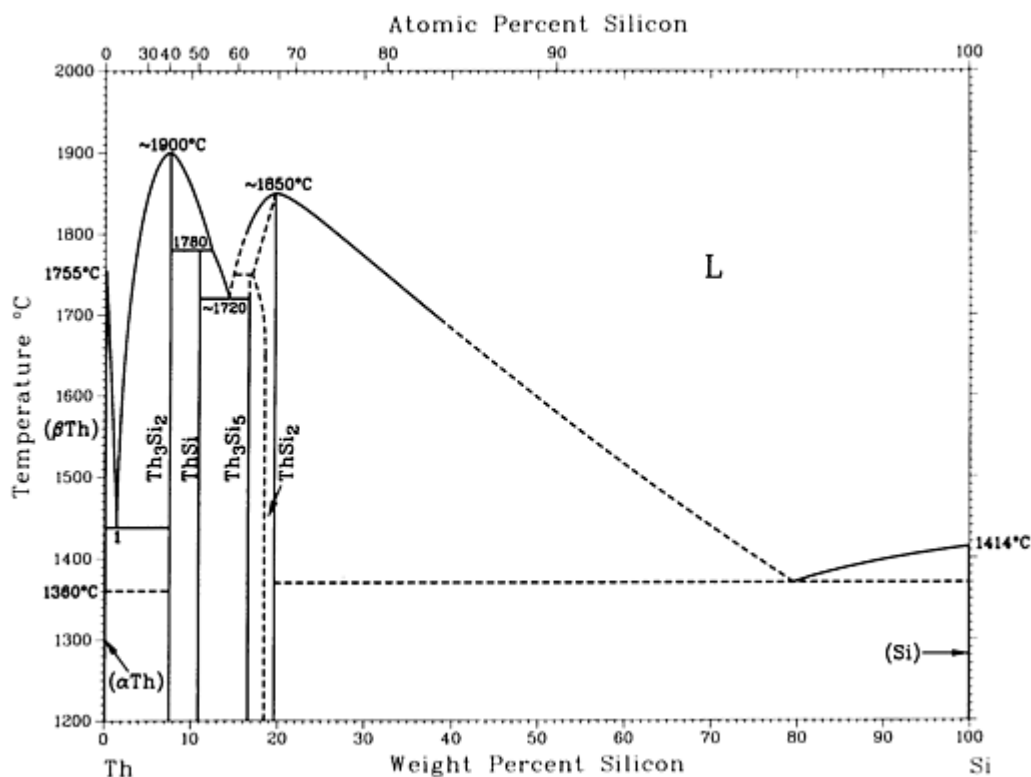

Si-Th phase diagram

Si-Th crystallographic data

Phase	Composition, wt% Si	Pearson symbol	Space group
(βTh)	0	<i>cI2</i>	<i>Im$\bar{3}m$</i>
(αTh)	0	<i>cF4</i>	<i>Fm$\bar{3}m$</i>
Th ₃ Si ₂	8	<i>tP10</i>	<i>P4/mbm</i>
ThSi	10.8	<i>oP8</i>	<i>Pnma</i>
Th ₃ Si ₅	16.8	<i>hP3</i>	<i>P6/mmm</i>
ThSi ₂	~18 to 19.5	<i>tI12</i>	<i>I4₁/amd</i>

(Si)	100	<i>cF8</i>	<i>Fd$\bar{3}m$</i>
------	-----	------------	--------------------------------

Reference cited in this section

20. [Thorium]: M.H. Rand, O. von Goldbeck, R. Ferro, K. Girgis, and A.L. Dragoo, *Thorium: Physico-Chemical Properties of Its Compounds and Alloys*, O. Kubaschewski, Ed., Atomic Energy Review Special Issue No.5, International Atomic Energy Agency, Vienna (1975).

Si-Ti (Silicon - Titanium)

J.L. Murray, 1987

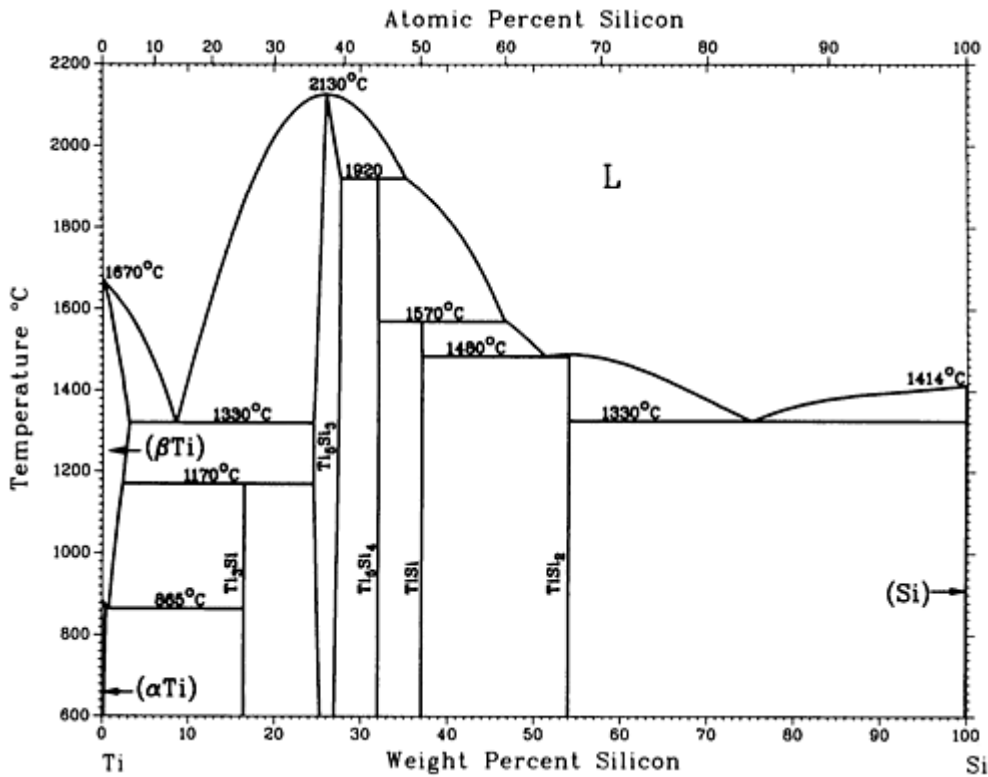

Si-Ti phase diagram

Si-Ti crystallographic data

Phase	Composition, wt% Si	Pearson symbol	Space group
(βTi)	0 to 2.1	<i>cI2</i>	<i>Im$\bar{3}m$</i>
(αTi)	0 to 0.3	<i>hP2</i>	<i>P6₃/mmc</i>

Ti_3Si	16	$tP32$	$P4_2/n$
Ti_5Si_3	24.4 to 27.7	$hP16$	$P6_3/mcm$
Ti_5Si_4	31.9	$tP36$	$P4_12_12$
$\text{Ti}_6\text{Si}_5^{(a)}$	32.9	^(b)	...
TiSi	37.0	$oP8$ $oP8$	$Pmm2$ $Pnma$
TiSi_2	54.0	$oF24$	$Fddd$
(Si)	100	$cF8$	$Fd\bar{3}m$

(a) Not shown in diagram.

(b) Tetragonal, related to $\sigma(D8_8)$

Si-U (Silicon - Uranium)

H. Okamoto, 1990

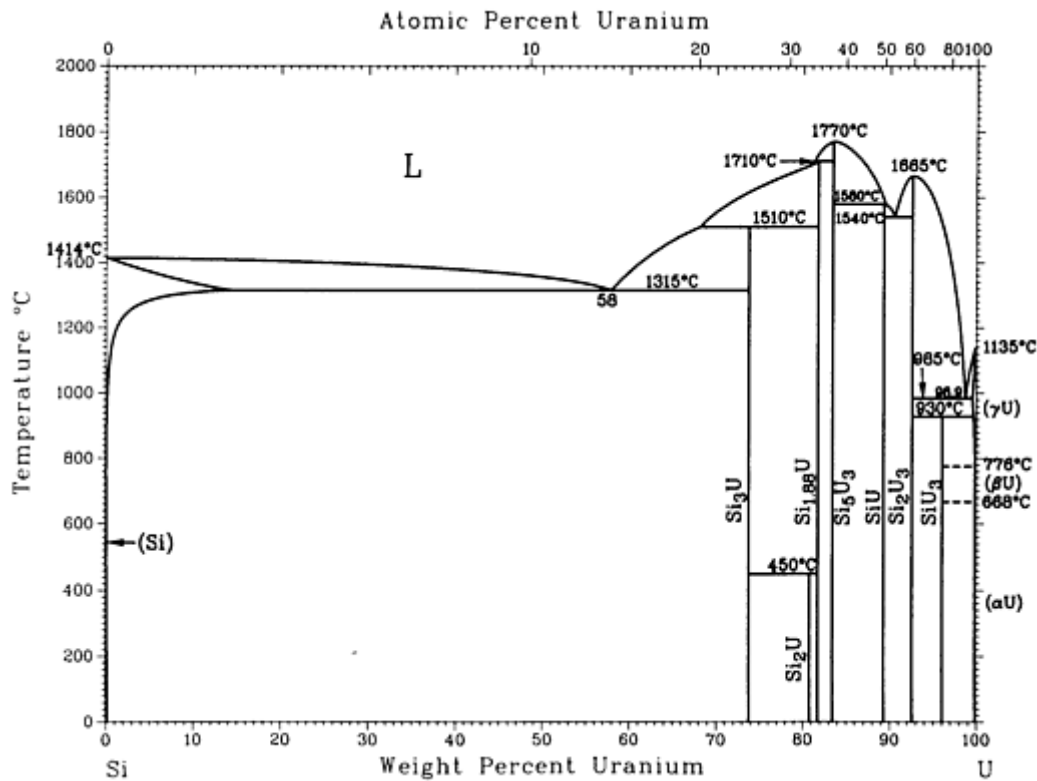

Si-U phase diagram

Si-U crystallographic data

Phase	Composition, wt% U	Pearson symbol	Space group
(Si)	0	<i>cF8</i>	<i>Fd</i> $\bar{3}m$
Si ₃ U	74	<i>cP4</i>	<i>Pm</i> $\bar{3}m$
Si ₂ U	80.9	<i>hP3</i>	<i>P6/mmm</i>
Si _{1.88} U	81.8	<i>iI12</i>	<i>I4₁/amd</i>
Si ₅ U ₃	83.6	<i>hP3</i>	<i>P6/mmm</i>
SiU	89.4	<i>oP8</i>	<i>Pnma</i>

Si ₂ U ₃	93	<i>tP19</i>	<i>P4/mbm</i>
SiU ₃	96	<i>cP4</i>	<i>Pm$\bar{3}m$</i>
(γ U)	100	<i>cI2</i>	<i>Im$\bar{3}m$</i>
(β U)	100	<i>tP30</i>	<i>P4₂/mnm</i>
(α U)	100	<i>oC4</i>	<i>Cmcm</i>

Si-V (Silicon - Vanadium)

J.F. Smith, 1989

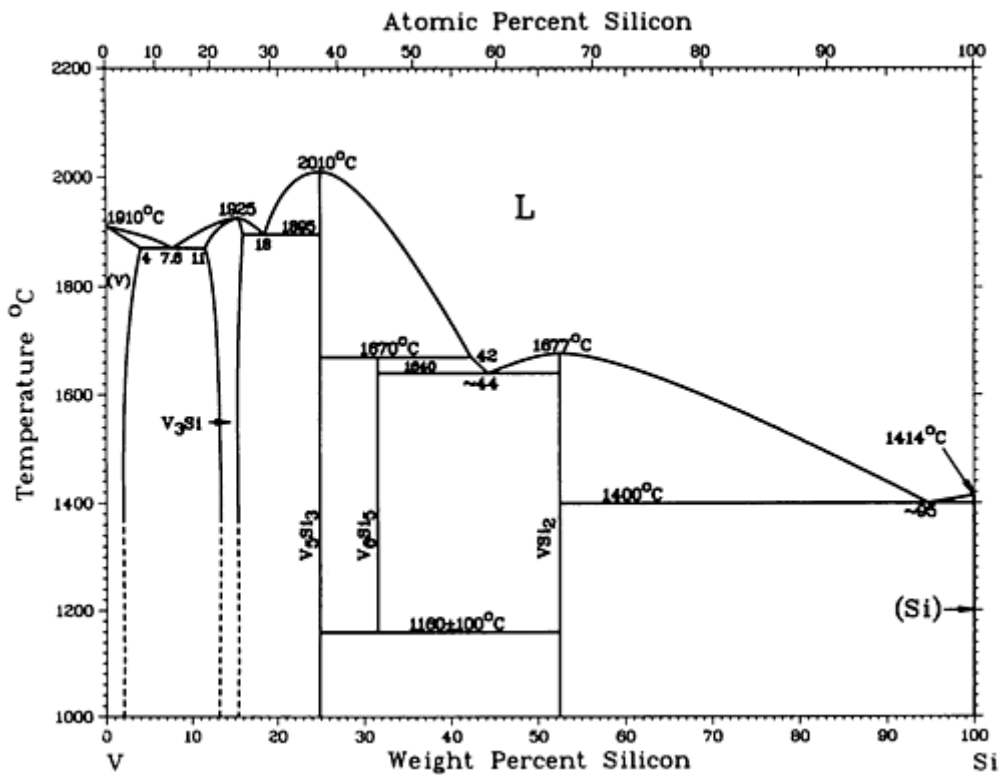

Si-V phase diagram

Si-V crystallographic data

Phase	Composition, wt% Si	Pearson symbol	Space group

(V)	0 to 4	<i>cI2</i>	<i>Im</i> $\bar{3}m$
V ₃ Si	11 to ~15.9	<i>cP8</i>	<i>Pm</i> $\bar{3}n$
V ₅ Si ₃	24.9	<i>tI32</i>	<i>I4/mcm</i>
V ₅ Si ₃	^(a)	<i>hP16</i>	<i>P6₃/mcm</i>
V ₆ Si ₅	~31	<i>oI44</i>	<i>Immm</i>
VSi ₂	52.5	<i>hP9</i>	<i>P6₂22</i>
(Si)	100	<i>cF8</i>	<i>Fm</i> $\bar{3}m$

(a) Carbon-stabilized

Si-Zn (Silicon - Zinc)

R.W. Olesinski and G.J. Abbaschian, 1985

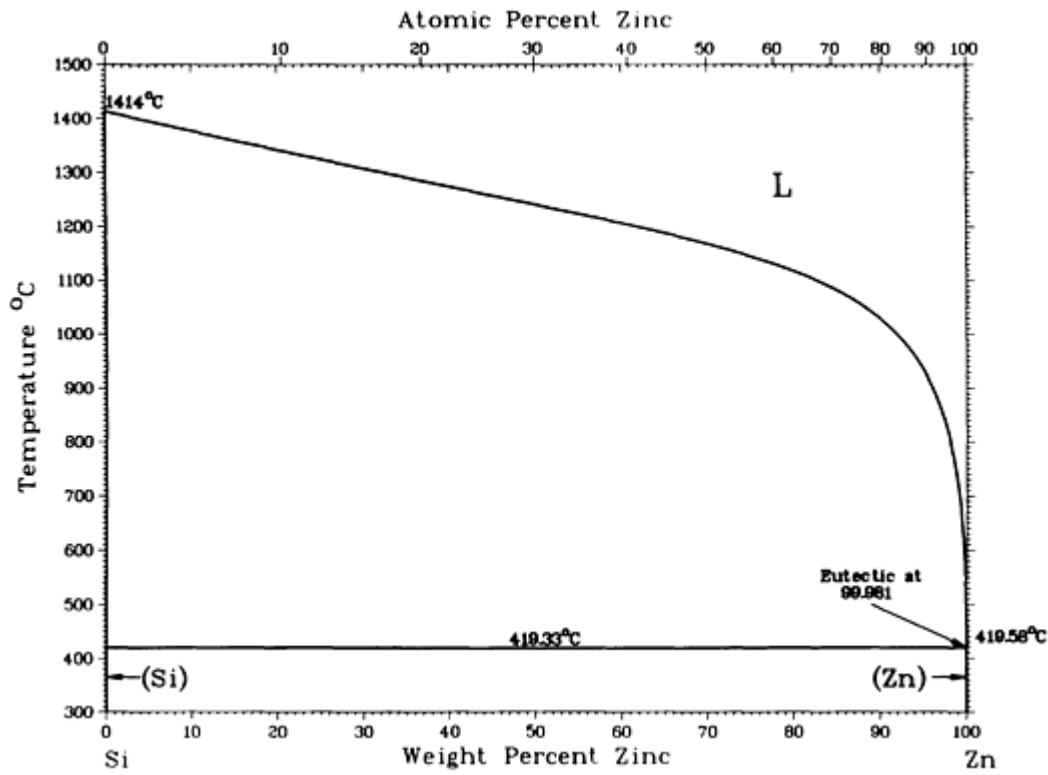

Si-Zn phase diagram

Si-Zn crystallographic data

Phase	Composition, wt% Zn	Pearson symbol	Space group
(Si)	0	<i>cF8</i>	<i>Fd$\bar{3}m$</i>
(Zn)	100	<i>hP2</i>	<i>P6₃/mmc</i>

Si-Zr (Silicon - Zirconium)

H. Okamoto, 1990

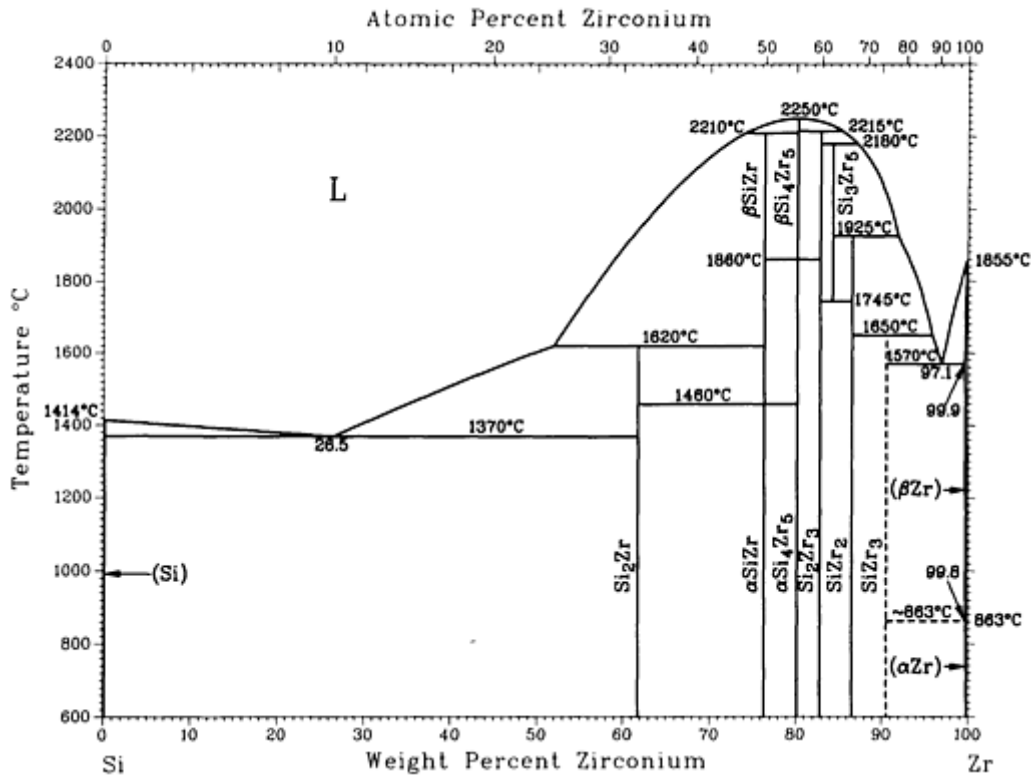

Si-Zr phase diagram

Si-Zr crystallographic data

Phase	Composition, wt% Zr	Pearson symbol	Space group
(Si)	0	<i>cF8</i>	<i>Fd$\bar{3}m$</i>
Si ₂ Zr	61.9	<i>oC12</i>	<i>Cmcm</i>
βSiZr	76.5	<i>oC8</i>	<i>Cmcm</i>
αSiZr	76.5	<i>oP8</i>	<i>Pnma</i>
βSi ₄ Zr ₅	80.3
αSi ₄ Zr ₅	80.3	<i>tP36</i>	<i>P4₁2₁2</i>

Si_2Zr_3	83	<i>tP10</i>	<i>P4/mbm</i>
Si_3Zr_5	84.4	<i>hP16</i>	<i>P6₃/mcm</i>
SiZr_2	86.7	<i>tI12</i>	<i>I4/mcm</i>
SiZr_3	~91	<i>tP32</i> <i>tI32</i>	<i>P4₂/n</i> <i>I4</i>
(β Zr)	100	<i>cI2</i>	<i>Im$\bar{3}m$</i>
(α Zr)	100	<i>hP2</i>	<i>P6₃/mmc</i>

Sm (Samarium) Binary Alloy Phase Diagrams

Introduction

THIS ARTICLE includes systems where samarium is the first-named element in the binary pair. Additional binary systems that include samarium are provided in the following locations in this Volume:

- “Ag-Sm (Silver - Samarium)” in the article “Ag (Silver) Binary Alloy Phase Diagrams.”
- “Bi-Sm (Bismuth - Samarium)” in the article “Bi (Bismuth) Binary Alloy Phase Diagrams.”
- “Cd-Sm (Cadmium - Samarium)” in the article “Cd (Cadmium) Binary Alloy Phase Diagrams.”
- “Co-Sm (Cobalt - Samarium)” in the article “Co (Cobalt) Binary Alloy Phase Diagrams.”
- “Fe-Sm (Iron - Samarium)” in the article “Fe (Iron) Binary Alloy Phase Diagrams.”
- “Ga-Sm (Gallium - Samarium)” in the article “Ga (Gallium) Binary Alloy Phase Diagrams.”
- “Ge-Sm (Germanium - Samarium)” in the article “Ge (Germanium) Binary Alloy Phase Diagrams.”
- “In-Sm (Indium - Samarium)” in the article “In (Indium) Binary Alloy Phase Diagrams.”
- “Mg-Sm (Magnesium - Samarium)” in the article “Mg (Magnesium) Binary Alloy Phase Diagrams.”
- “Mn-Sm (Manganese - Samarium)” in the article “Mn (Manganese) Binary Alloy Phase Diagrams.”
- “Ni-Sm (Nickel - Samarium)” in the article “Ni (Nickel) Binary Alloy Phase Diagrams.”
- “Pd-Sm (Palladium - Samarium)” in the article “Pd (Palladium) Binary Alloy Phase Diagrams.”
- “Sb-Sm (Antimony - Samarium)” in the article “Sb (Antimony) Binary Alloy Phase Diagrams.”

Sm-Sn (Samarium - Tin)

G. Borzone, A. Borsese, and R. Ferro, 1982

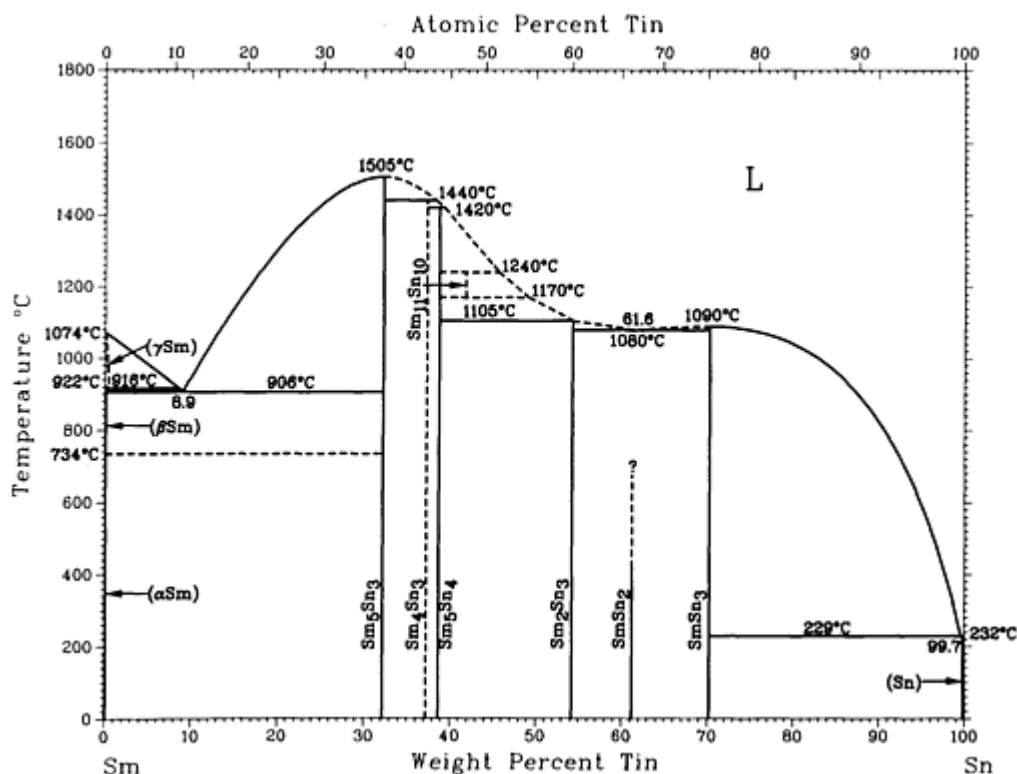

Sm-Sn phase diagram

Sm-Sn crystallographic data

Phase	Composition, wt% Sn	Pearson symbol	Space group
(γ Sm)	0 to 0.4	<i>cI2</i>	<i>Im</i> $\bar{3}m$
(β Sm)	0	<i>hP2</i>	<i>P6</i> $_3/mmc$
(α Sm)	0	<i>hR3</i>	<i>R</i> $\bar{3}m$
Sm ₅ Sn ₃	32.1	<i>hP16</i>	<i>P6</i> $_3/mcm$
Sm ₄ Sn ₃	37	<i>cI28</i>	<i>I</i> $\bar{4}3d$
Sm ₅ Sn ₄	38.8	<i>oP36</i>	<i>Pnma</i>
Sm ₁₁ Sm ₁₀	~42	<i>tI84</i>	<i>I4/mmm</i>
Sm ₂ Sn ₃	54	<i>t**</i>	...
SmSn ₂	61.3
SmSn ₃	70	<i>cP4</i>	<i>Pm</i> $\bar{3}m$
(β Sn)	100	<i>tI4</i>	<i>I4</i> $_1/amd$
(α Sn)	100	<i>cF8</i>	<i>Fd</i> $\bar{3}m$

Sm-Tl (Samarium - Thallium)

S. Delfino, A. Saccone, A. Palenzona, and R. Ferro, unpublished

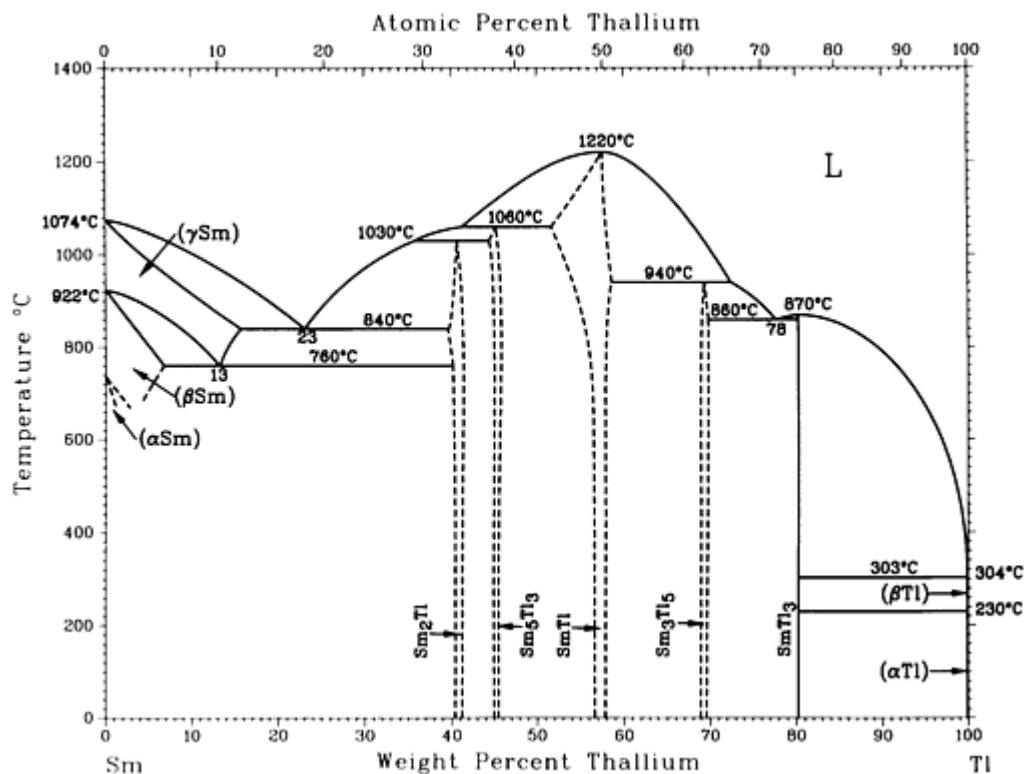

Sm-Tl phase diagram

Sm-Tl crystallographic data

Phase	Composition, wt% Tl	Pearson symbol	Space group
(βSm)	0 to ~3.4	$hP2$	$P6_3/mmc$
(αSm)	0 to ?	$hR2$	$R\bar{3}m$
(γSm)	0 to ~16	$cI2$	$Im\bar{3}m$
Sm_2Tl	~40 to ~41	$hP6$	$P6_3/mmc$
Sm_5Tl_3	~44 to ~45	$tI32$	$I4/mcm$
$SmTl^{(a)}$	~52 to ~59	$tP2$ (or $cI2$)	$Pm\bar{3}m$ $Im\bar{3}m$

SmTl ^(b)	~52 to ~59	<i>tP2</i>	<i>P4/mmm</i>
Sm ₃ Tl ₅	~69 to ~70	<i>oC32</i>	<i>Cmcm</i>
SmTl ₃	80	<i>cP4</i>	<i>Pm$\bar{3}m$</i>
(β Tl)	100	<i>cI2</i>	<i>Im$\bar{3}m$</i>
(α Tl)	100	<i>hP2</i>	<i>P6₃/mmc</i>

(a) Cubic structure presumed to be room- and high-temperature phases.

(b) Tetragonal structure presumed to be low-temperature phase.

Sm-Zn (Samarium - Zinc)

From [Moffatt] 11

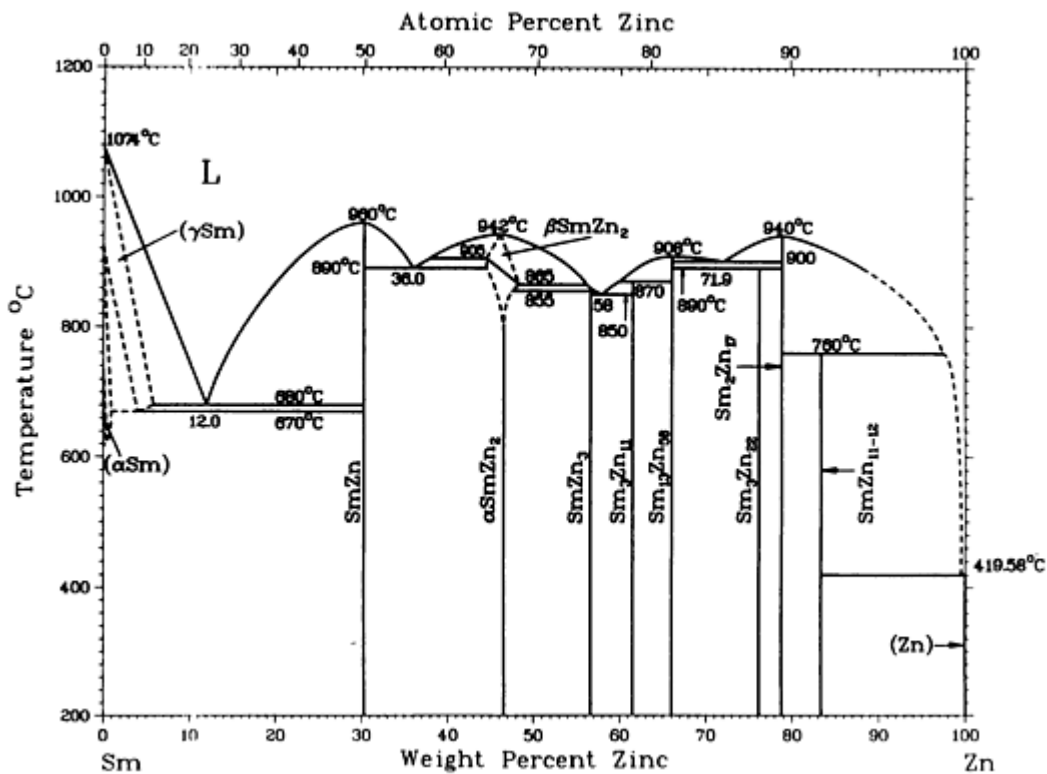

Sm-Zn phase diagram

Sm-Zn crystallographic data

Phase	Composition, wt% Zn	Pearson symbol	Space group
(γ Sm)	0 to ?	<i>cI2</i>	<i>Im$\bar{3}m$</i>
(β Sm)	0 to ?	<i>hP2</i>	<i>P6$_3$/mmc</i>
(α Sm)	0 to ?	<i>hR3</i>	<i>R$\bar{3}m$</i>
SmZn	30.3	<i>cP2</i>	<i>Pm$\bar{3}m$</i>
β SmZn ₂	45.2 to 48	<i>oI12</i>	<i>Imma</i>
α SmZn ₂	~46.6	<i>oI12</i>	<i>Imma</i>
SmZn ₃	57	<i>oP16</i>	<i>Pnma</i>
Sm ₃ Zn ₁₁	~61.5	<i>oI28</i>	<i>Immm</i>
Sm ₁₃ Zn ₅₈	~66.2	<i>hP142</i>	<i>P6$_3$mc</i>
Sm ₃ Zn ₂₂	76	<i>iI100</i>	<i>I4$_1$/amd</i>
Sm ₂ Zn ₁₇	~78.8
SmZn ₁₁₋₁₂	83	<i>iI26</i>	<i>I4/mmm</i>
(Zn)	100	<i>hP2</i>	<i>P6$_3$/mmc</i>

Reference cited in this section

- [Moffatt]: W.G. Moffatt, Ed., *Handbook of Binary Phase Diagrams*, Business Growth Services, General Electric Co., Schenectady, NY (1976).

Introduction

THIS ARTICLE includes systems where tin is the first-named element in the binary pair. Additional binary systems that include tin are provided in the following locations in this Volume:

- “Ag-Sn (Silver - Tin)” in the article “Ag (Silver) Binary Alloy Phase Diagrams.”
- “Al-Sn (Aluminum - Tin)” in the article “Al (Aluminum) Binary Alloy Phase Diagrams.”
- “As-Sn (Arsenic - Tin)” in the article “As (Arsenic) Binary Alloy Phase Diagrams.”
- “Au-Sn (Gold - Tin)” in the article “Au (Gold) Binary Alloy Phase Diagrams.”
- “Bi-Sn (Bismuth - Tin)” in the article “Bi (Bismuth) Binary Alloy Phase Diagrams.”
- “Cd-Sn (Cadmium - Tin)” in the article “Cd (Cadmium) Binary Alloy Phase Diagrams.”
- “Ce-Sn (Cerium - Tin)” in the article “Ce (Cerium) Binary Alloy Phase Diagrams.”
- “Co-Sn (Cobalt - Tin)” in the article “Co (Cobalt) Binary Alloy Phase Diagrams.”
- “Cr-Sn (Chromium - Tin)” in the article “Cr (Chromium) Binary Alloy Phase Diagrams.”
- “Cs-Sn (Cesium - Tin)” in the article “Cs (Cesium) Binary Alloy Phase Diagrams.”
- “Cu-Sn (Copper - Tin)” in the article “Cu (Copper) Binary Alloy Phase Diagrams.”
- “Dy-Sn (Dysprosium - Tin)” in the article “Dy (Dysprosium) Binary Alloy Phase Diagrams.”
- “Fe-Sn (Iron - Tin)” in the article “Fe (Iron) Binary Alloy Phase Diagrams.”
- “Ga-Sn (Gallium - Tin)” in the article “Ga (Gallium) Binary Alloy Phase Diagrams.”
- “Gd-Sn (Gadolinium - Tin)” in the article “Gd (Gadolinium) Binary Alloy Phase Diagrams.”
- “Ge-Sn (Germanium - Tin)” in the article “Ge (Germanium) Binary Alloy Phase Diagrams.”
- “Hg-Sn (Mercury - Tin)” in the article “Hg (Mercury) Binary Alloy Phase Diagrams.”
- “In-Sn (Indium - Tin)” in the article “In (Indium) Binary Alloy Phase Diagrams.”
- “K-Sn (Potassium - Tin)” in the article “K (Potassium) Binary Alloy Phase Diagrams.”
- “La-Sn (Lanthanum - Tin)” in the article “La (Lanthanum) Binary Alloy Phase Diagrams.”
- “Li-Sn (Lithium - Tin)” in the article “Li (Lithium) Binary Alloy Phase Diagrams.”
- “Mg-Sn (Magnesium - Tin)” in the article “Mg (Magnesium) Binary Alloy Phase Diagrams.”
- “Mn-Sn (Manganese - Tin)” in the article “Mn (Manganese) Binary Alloy Phase Diagrams.”
- “Na-Sn (Sodium - Tin)” in the article “Na (Sodium) Binary Alloy Phase Diagrams.”
- “Nd-Sn (Neodymium - Tin)” in the article “Nd (Neodymium) Binary Alloy Phase Diagrams.”
- “Ni-Sn (Nickel - Tin)” in the article “Ni (Nickel) Binary Alloy Phase Diagrams.”
- “O-Sn (Oxygen - Tin)” in the article “O (Oxygen) Binary Alloy Phase Diagrams.”
- “P-Sn (Phosphorus - Tin)” in the article “P (Phosphorous) Binary Alloy Phase Diagrams.”
- “Pb-Sn (Lead - Tin)” in the article “Pb (Lead) Binary Alloy Phase Diagrams.”
- “Pd-Sn (Palladium - Tin)” in the article “Pd (Palladium) Binary Alloy Phase Diagrams.”
- “Pr-Sn (Praseodymium - Tin)” in the article “Pr (Praseodymium) Binary Alloy Phase Diagrams.”
- “Pt-Sn (Platinum - Tin)” in the article “Pt (Platinum) Binary Alloy Phase Diagrams.”
- “S-Sn (Sulfur - Tin)” in the article “S (Sulfur) Binary Alloy Phase Diagrams.”
- “Sb-Sn (Antimony - Tin)” in the article “Sb (Antimony) Binary Alloy Phase Diagrams.”
- “Se-Sn (Selenium - Tin)” in the article “Se (Selenium) Binary Alloy Phase Diagrams.”
- “Si-Sn (Silicon - Tin)” in the article “Si (Silicon) Binary Alloy Phase Diagrams.”
- “Sm-Sn (Samarium - Tin)” in the article “Sm (Samarium) Binary Alloy Phase Diagrams.”

Sn-Sr (Tin - Strontium)

P.R. Subramanian, 1990

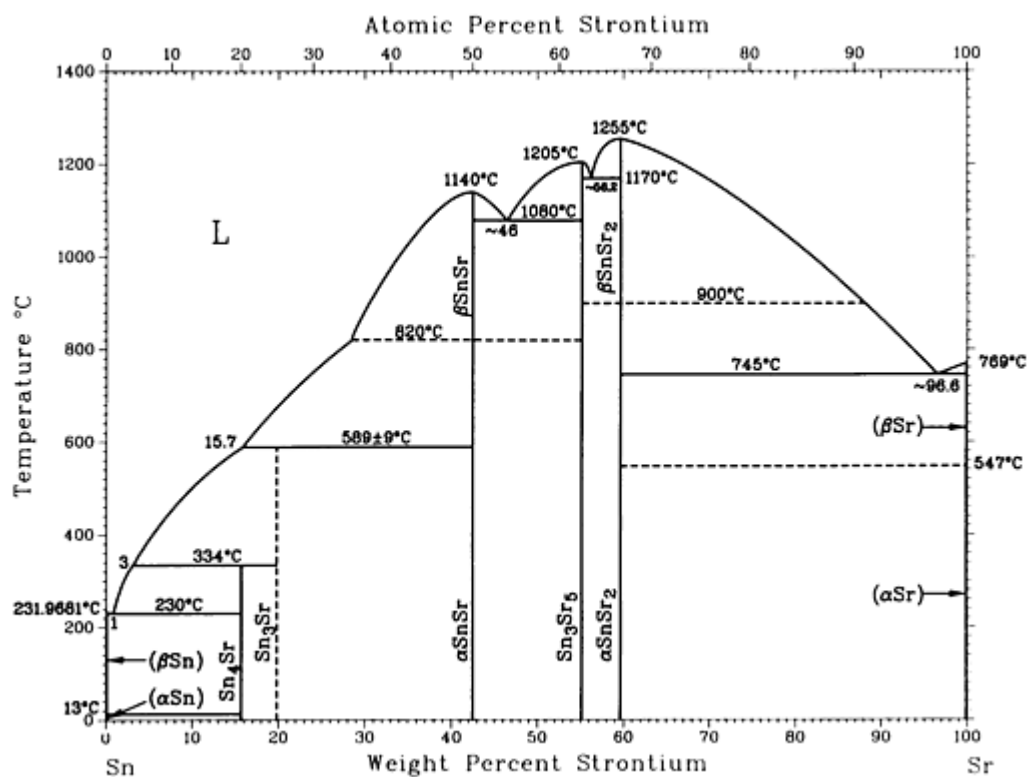

Sn-Sr phase diagram

Sn-Sr crystallographic data

Phase	Composition, wt% Sr	Pearson symbol	Space group
(βSn)	0	<i>I4</i>	<i>I4₁amd</i>
(αSn)	0	<i>cF8</i>	<i>Fd3m</i>
Sn ₄ Sr	15.6
Sn ₃ Sr	19.7
βSnSr	42.5
αSnSr	42.5	<i>oC8</i>	<i>Cmcm</i>

Sn_3Sr_5	55.2	$tI32$	$I4/mcm$
βSnSr_2	59.6
αSnSr_2	59.6	$oP12$	$Pnma$
(βSr)	100	$cI2$	$Im\bar{3}m$
(αSr)	100	$cF4$	$Fm\bar{3}m$

Sn-Te (Tin - Tellurium)

R.C. Sharma and Y.A. Chang, 1986

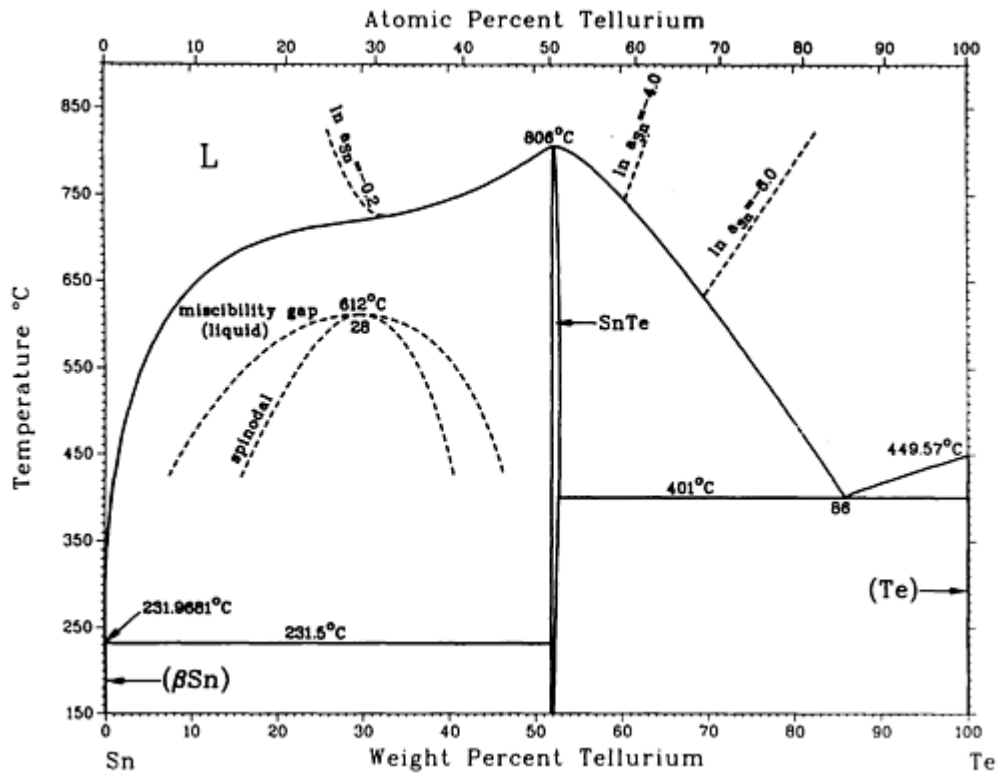

Sn-Te phase diagram

Sn-Te crystallographic data

Phase	Composition, wt% Te	Pearson symbol	Space group
(Sn)	~0	$tI4$	$I4_1/amd$

SnTe	51.8	<i>cF8</i>	<i>Fm</i> $\bar{3}m$
SnTe(HP)	51.8	<i>oP8</i>	<i>Pnma</i>
(Te)	100	<i>hP3</i>	<i>P3</i> $_1$ 21

Sn-Ti (Tin - Titanium)

J.L. Murray, 1987

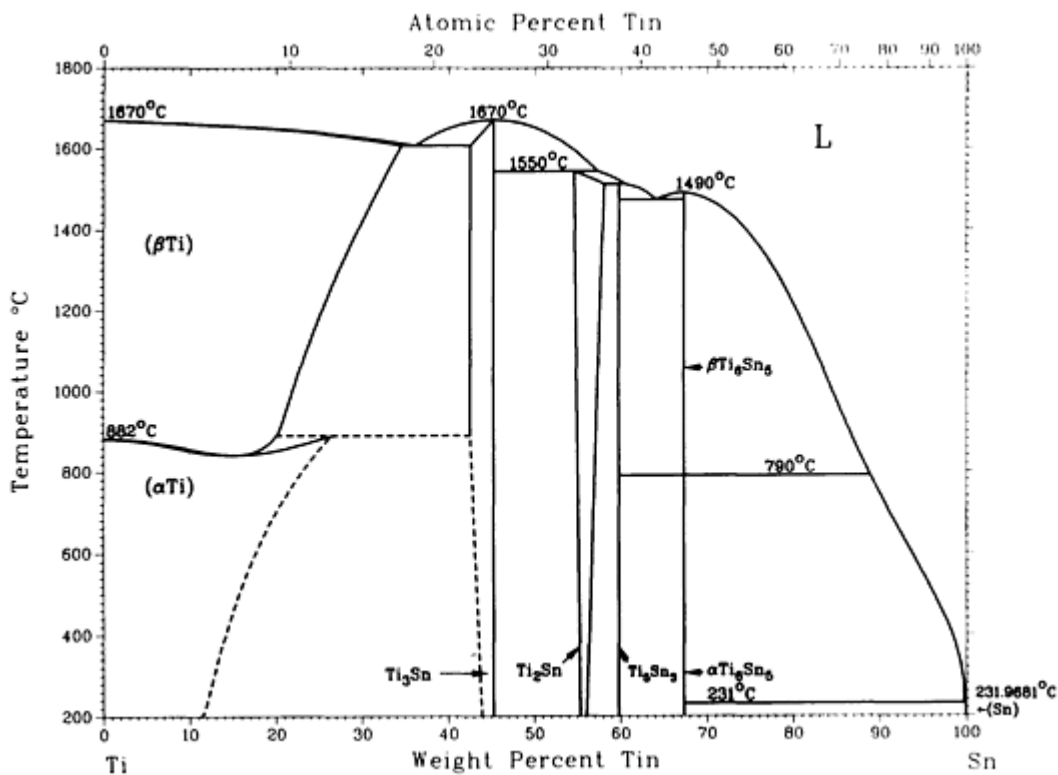

Sn-Ti phase diagram

Sn-Ti crystallographic data

Phase	Composition, wt% Sn	Pearson symbol	Space group
(βTi)	0 to 34	<i>cI2</i>	<i>Im</i> $\bar{3}m$
(αTi)	0 to >16.7	<i>hP2</i>	<i>P6</i> $_3$ / <i>mmc</i>
Ti ₃ Sn	43 to 45	<i>hP8</i>	<i>P6</i> $_3$ / <i>mmc</i>

Ti ₂ Sn	54.6 to 58.1	<i>hP6</i>	<i>P6₃/mmc</i>
Ti ₅ Sn ₃	59.8	<i>hP16</i>	<i>P6₃/mcm</i>
β -Ti ₆ Sn ₅	67.4	<i>hP22</i>	<i>P6₃/mmc</i> <i>P$\bar{3}$1c</i>
α -Ti ₆ Sn ₅	67.4	<i>oI44</i>	<i>Immm</i>
(Sn)	99.99 to 100	<i>tI4</i>	<i>I4₁/amd</i>

Sn-Tl (Tin - Thallium)

H. Okamoto, 1990

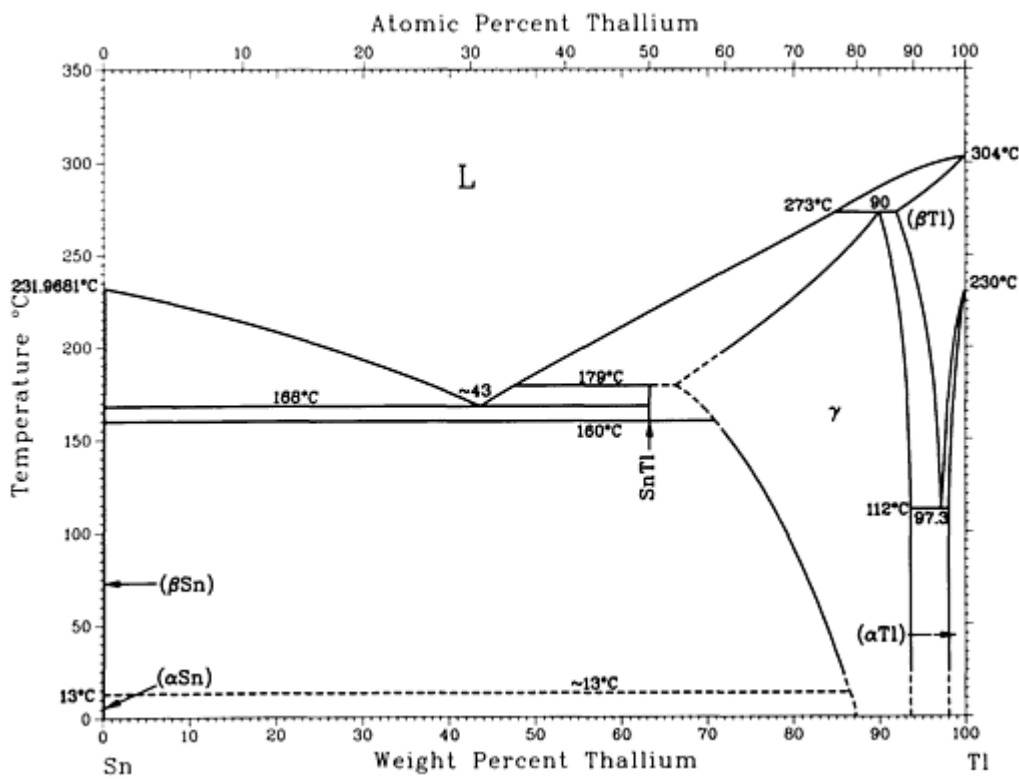

Sn-Tl phase diagram

Sn-Tl crystallographic data

Phase	Composition, wt% Tl	Pearson symbol	Space group
(β _{Sn})	0	<i>tI4</i>	<i>I4₁/amd</i>

(α Sn)	0	<i>cF8</i>	<i>Fd$\bar{3}m$</i>
SnTl	63.3	<i>tP2</i>	<i>P4/mmm</i>
γ	68 to 94	<i>cF4</i>	<i>Fm$\bar{3}m$</i>
(β Tl)	92 to 100	<i>cI2</i>	<i>Im$\bar{3}m$</i>
(α Tl)	98 to 100	<i>hP2</i>	<i>P6$_3$/mmc</i>

Sn-U (Tin - Uranium)

R.I. Sheldon, E.M. Foltyn, and D.E. Peterson, 1987

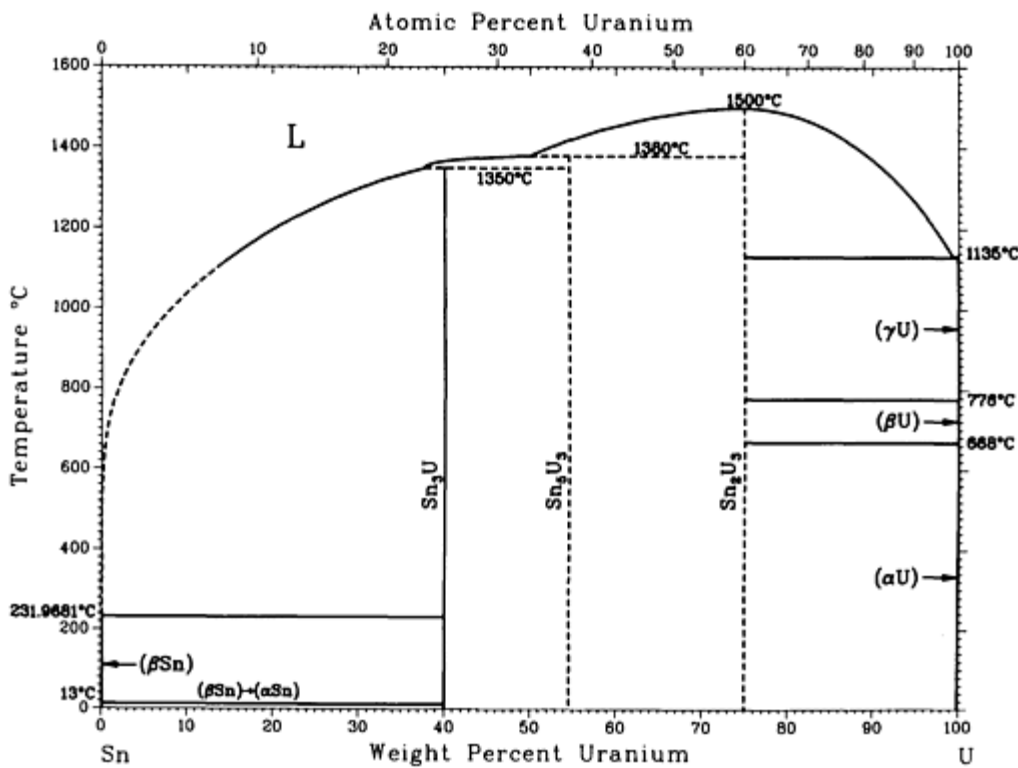

Sn-U phase diagram

Sn-U crystallographic data

Phase	Composition, wt% U	Pearson symbol	Space group
(β Sn)	0	<i>tI4</i>	<i>I4$_1$/amd</i>

(α Sn)	0	<i>cF8</i>	<i>Fd$\bar{3}m$</i>
Sn ₃ U ^(a)	40.1	<i>cP4</i>	<i>Pm$\bar{3}m$</i>
Sn ₅ U ₃	54.6
Sn ₂ U ₃	75.0
(γ U)	100	<i>cI2</i>	<i>Im$\bar{3}m$</i>
(β U)	100	<i>tP30</i>	<i>P4₂/mnm</i>
(α U)	100	<i>oC4</i>	<i>Cmcm</i>

(a) No tendency to disorder was observed.

Sn-Y (Tin - Yttrium)

H. Okamoto, 1990

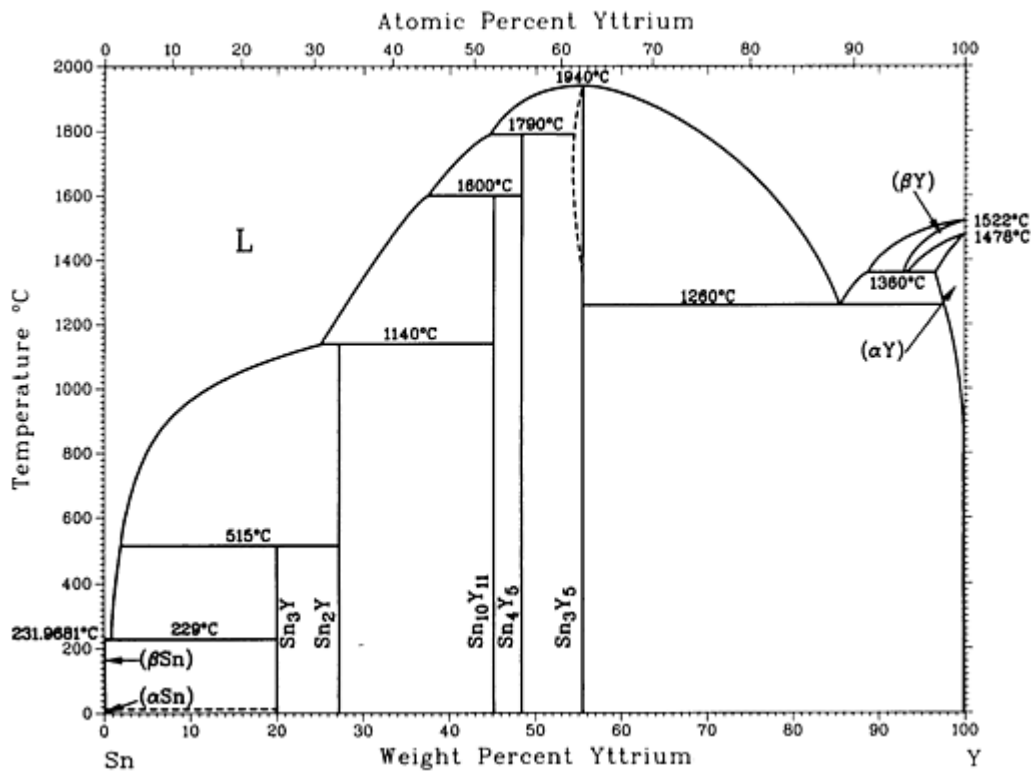

Sn-Y phase diagram

Sn-Y crystallographic data

Phase	Composition, wt% Y	Pearson symbol	Space group
(β_{Sn})	0	<i>tI4</i>	<i>I4₁amd</i>
(α_{Sn})	0	<i>cF8</i>	<i>Fd$\bar{3}m$</i>
Sn ₃ Y	20	<i>cP4</i>	<i>Pm$\bar{3}m$</i>
Sn ₂ Y	27.2	<i>oC12</i>	<i>Cmcm</i>
Sn ₁₀ Y ₁₁	45.2	<i>tI84</i>	<i>I4/mmm</i>
Sn ₄ Y ₅	48.4	<i>oP36</i>	<i>Pnma</i>
Sn ₃ Y ₅	55.5	<i>hP16</i>	<i>P6₃/mcm</i>
(β_{Y})	100	<i>cI2</i>	<i>Im$\bar{3}m$</i>
(α_{Y})	100	<i>hP2</i>	<i>P6₃/mmc</i>

Sn-Yb (Tin - Ytterbium)

A. Palenzona and S. Cirafici, 1991

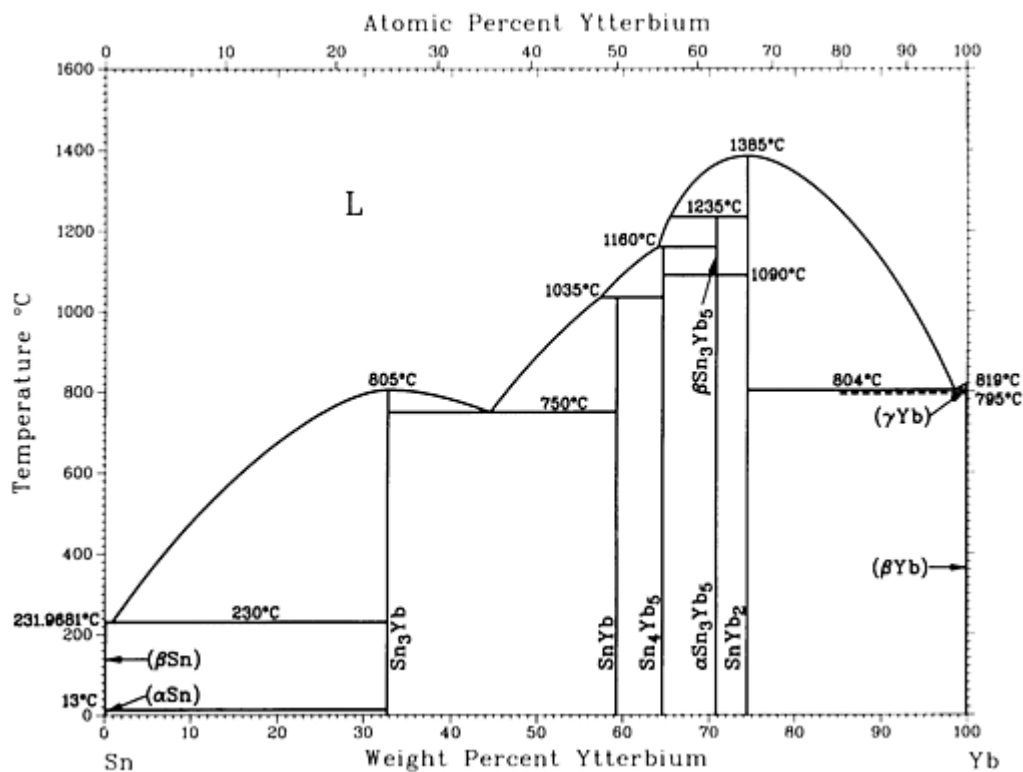

Sn-Yb phase diagram

Sn-Yb crystallographic data

Phase	Composition, wt% Yb	Pearson symbol	Space group
(βSn)	0	<i>tI4</i>	<i>I4₁/amd</i>
(αSn)	0	<i>cF8</i>	<i>Fd$\bar{3}m$</i>
Sn ₃ Yb	32.7	<i>cP4</i>	<i>Pm$\bar{3}m$</i>
SnYb	59.3	<i>tP2</i>	<i>P4/mmm</i>
Sn ₄ Yb ₅	64.6	<i>oP36</i>	<i>Pnma</i>
βSn ₃ Yb ₅	70.8	<i>tI32</i>	<i>I4/mcm</i>
αSn ₃ Yb ₅	70.8	<i>hP16</i>	<i>P6₃/mcm</i>

SnYb ₂	74.5	<i>hP6</i>	<i>P6₃/mmc</i>
(γ Yb)	100	<i>cI2</i>	<i>Im$\bar{3}m$</i>
(β Yb)	100	<i>cF4</i>	<i>Fm$\bar{3}m$</i>
(α Yb)	100	<i>hP2</i>	<i>P6₃/mmc</i>

Sn-Zn (Tin - Zinc)

Z. Moser, J. Dutkiewicz, W. Gasiór, and J. Salawa, 1985

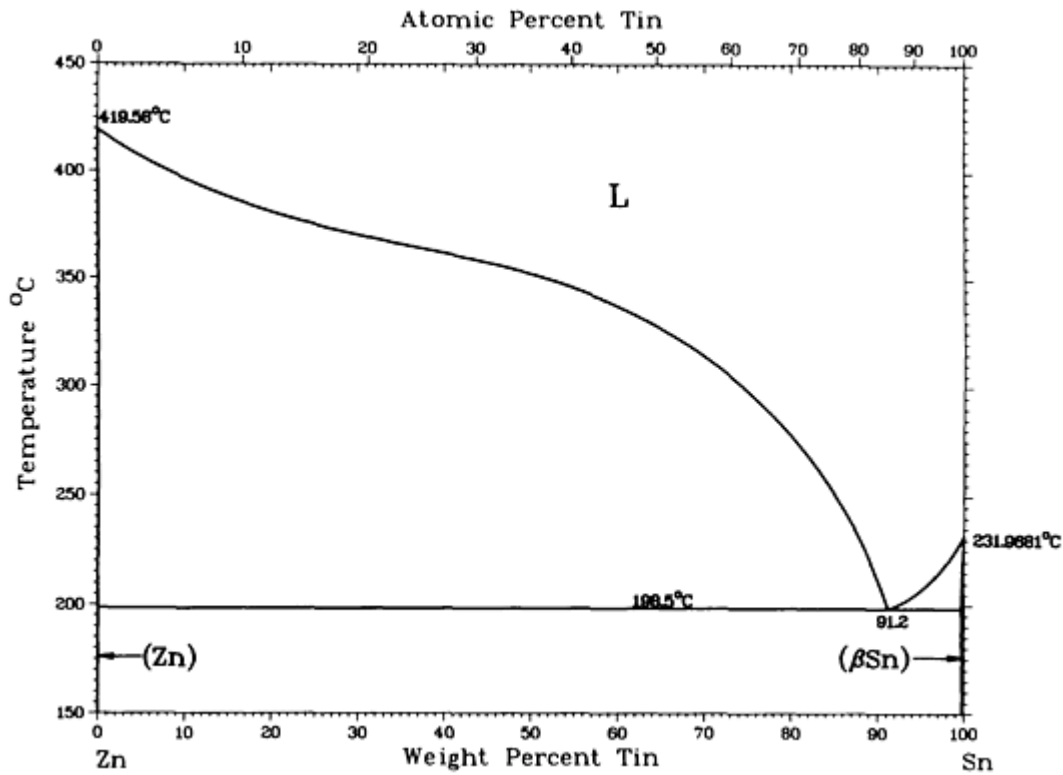

Sn-Zn phase diagram

Sn-Zn crystallographic data

Phase	Composition, wt% Sn	Pearson symbol	Space group
(Zn)	0	<i>hP2</i>	<i>P6₃/mmc</i>
(β Sn)	~100	<i>tI4</i>	<i>I4₁/amd</i>

Sn-Zr (Tin - Zirconium)

J.P. Abriata, J.C. Bolcich, and D. Arias, 1983

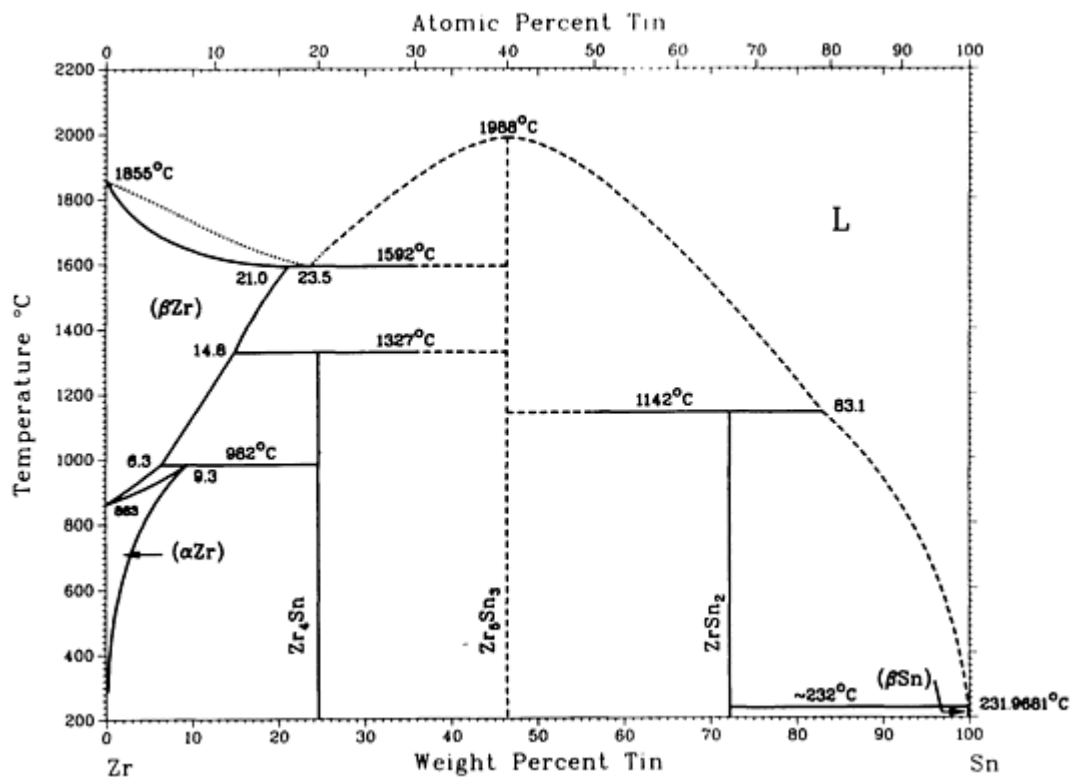

Sn-Zr phase diagram

Sn-Zr crystallographic data

Phase	Composition, wt% Sn	Pearson symbol	Space group
(β _{Zr})	0 to 21.0	<i>cI2</i>	<i>Im</i> $\bar{3}m$
(α _{Zr})	0 to 9.3	<i>hP2</i>	<i>P6</i> ₃ / <i>m</i> <i>mc</i>
Zr ₄ Sn	~25	<i>cP8</i>	<i>Pm</i> $\bar{3}n$
Zr ₅ Sn ₃	40 to ~47	<i>hP16</i>	<i>P6</i> ₃ / <i>m</i> <i>cm</i>
ZrSn ₂	72.8	<i>oF24</i>	<i>Fddd</i>
(β _{Sn})	100	<i>tI4</i>	<i>I4</i> ₁ / <i>amd</i>
(α _{Sn})	100	<i>cF8</i>	<i>Fd</i> $\bar{3}m$

Possible additional phase			
Zr ₅ Sn ₄	~52	<i>hP18</i>	...

Sr (Strontium) Binary Alloy Phase Diagrams

Introduction

THIS ARTICLE includes systems where strontium is the first-named element in the binary pair. Additional binary systems that include strontium are provided in the following locations in this Volume:

- “Ag-Sr (Silver - Strontium)” in the article “Ag (Silver) Binary Alloy Phase Diagrams.”
- “Al-Sr (Aluminum - Strontium)” in the article “Al (Aluminum) Binary Alloy Phase Diagrams.”
- “Au-Sr (Gold - Strontium)” in the article “Au (Gold) Binary Alloy Phase Diagrams.”
- “Bi-Sr (Bismuth - Strontium)” in the article “Bi (Bismuth) Binary Alloy Phase Diagrams.”
- “Ca-Sr (Calcium - Strontium)” in the article “Ca (Calcium) Binary Alloy Phase Diagrams.”
- “Cd-Sr (Cadmium - Strontium)” in the article “Cd (Cadmium) Binary Alloy Phase Diagrams.”
- “Cu-Sr (Copper - Strontium)” in the article “Cu (Copper) Binary Alloy Phase Diagrams.”
- “Ga-Sr (Gallium - Strontium)” in the article “Ga (Gallium) Binary Alloy Phase Diagrams.”
- “Ge-Sr (Germanium - Strontium)” in the article “Ge (Germanium) Binary Alloy Phase Diagrams.”
- “H-Sr (Hydrogen - Strontium)” in the article “H (Hydrogen) Binary Alloy Phase Diagrams.”
- “Hg-Sr (Mercury - Strontium)” in the article “Hg (Mercury) Binary Alloy Phase Diagrams.”
- “In-Sr (Indium - Strontium)” in the article “In (Indium) Binary Alloy Phase Diagrams.”
- “Li-Sr (Lithium - Strontium)” in the article “Li (Lithium) Binary Alloy Phase Diagrams.”
- “Mg-Sr (Magnesium - Strontium)” in the article “Mg (Magnesium) Binary Alloy Phase Diagrams.”
- “Na-Sr (Sodium - Strontium)” in the article “Na (Sodium) Binary Alloy Phase Diagrams.”
- “Pb-Sr (Lead - Strontium)” in the article “Pb (Lead) Binary Alloy Phase Diagrams.”
- “Sb-Sr (Antimony - Strontium)” in the article “Sb (Antimony) Binary Alloy Phase Diagrams.”
- “Se-Sr (Selenium - Strontium)” in the article “Se (Selenium) Binary Alloy Phase Diagrams.”
- “Si-Sr (Silicon - Strontium)” in the article “Si (Silicon) Binary Alloy Phase Diagrams.”
- “Sn-Sr (Tin - Strontium)” in the article “Sn (Tin) Binary Alloy Phase Diagrams.”

Sr-Te (Strontium - Tellurium)

Yu.B. Lyskova and A.V. Vakhobov, 1975

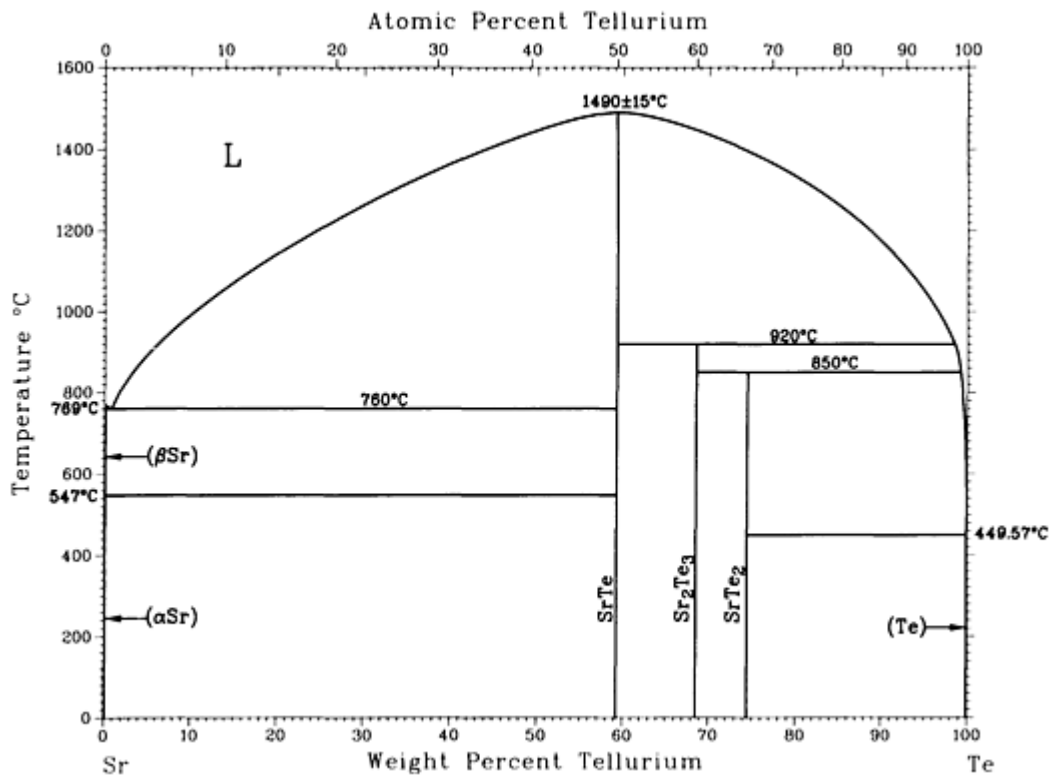

Sr-Te phase diagram

Sr-Te crystallographic data

Phase	Composition, wt% Te	Pearson symbol	Space group
(β _{Sr})	0	cI2	$Im\bar{3}m$
(α _{Sr})	0	cF4	$Fm\bar{3}m$
SrTe	59.3	cF8	$Fm\bar{3}m$
Sr ₂ Te ₃	69
SrTe ₂	74.5
(Te)	100	<i>hP</i> 3	$P3_121$

Sr-Tl (Strontium - Thallium)

H. Okamoto, 1990

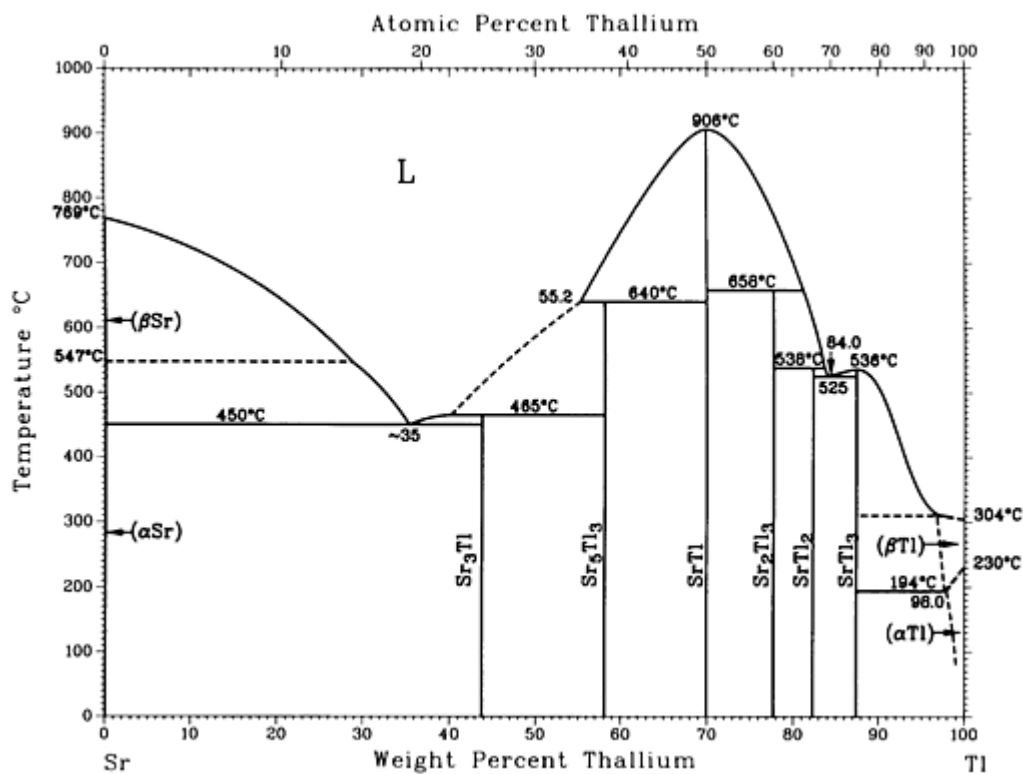

Sr-Tl phase diagram

Sr-Tl crystallographic data

Phase	Composition, wt% Tl	Pearson symbol	Space group
(βSr)	0	<i>cI2</i>	$Im\bar{3}m$
(αSr)	0	<i>cF4</i>	$Fm\bar{3}m$
Sr_3Tl	44
Sr_5Tl_3	58.3	<i>tI32</i>	$I4/mcm$
SrTl	70.0	<i>cP2</i>	$Pm\bar{3}m$
Sr_2Tl_3	78

SrTi ₂	82.4	<i>hP6</i>	<i>P6₃/mmc</i>
SrTi ₃	88
(β Ti)	? to 100	<i>cI2</i>	<i>Im$\bar{3}m$</i>
(α Ti)	98.0 to 100	<i>hP2</i>	<i>P6₃/mmc</i>

Sr-Zn (Strontium - Zinc)

P.R. Subramanian, 1990

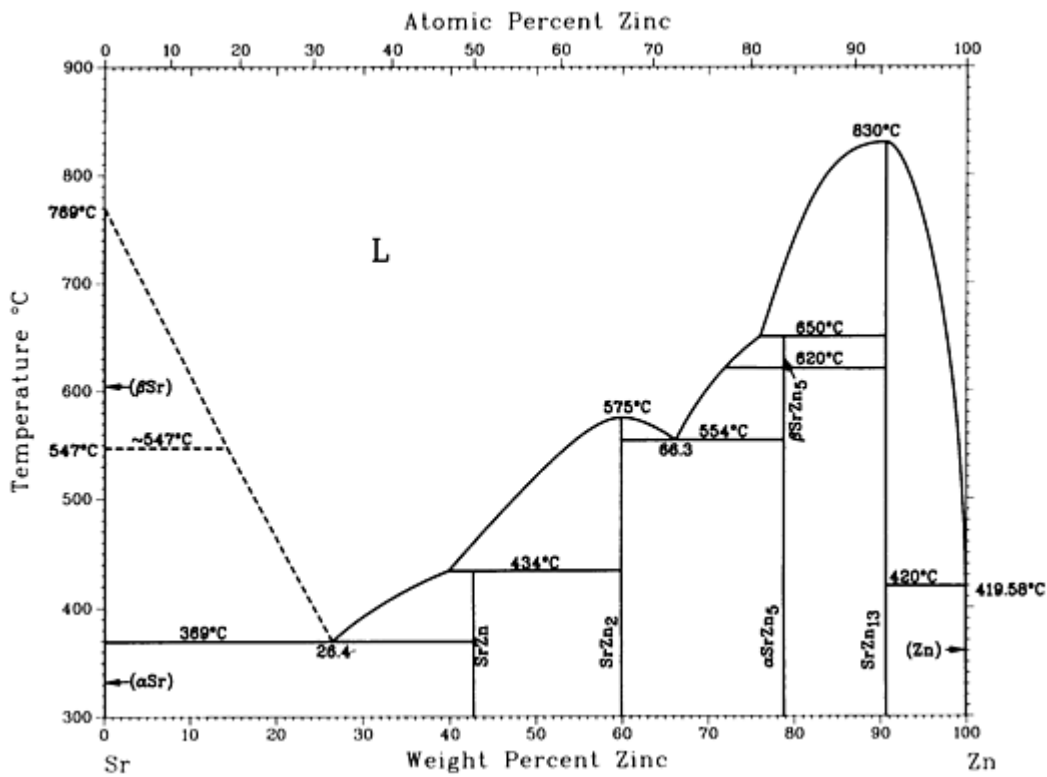

Sr-Zn phase diagram

Sr-Zn crystallographic data

Phase	Composition, wt% Zn	Pearson symbol	Space group
(β Sr)	0	<i>cI2</i>	<i>Im$\bar{3}m$</i>

(α Sr)	0	<i>cF4</i>	<i>Fm$\bar{3}m$</i>
SrZn	42.7	<i>oP8</i>	<i>Pnma</i>
SrZn ₂	59.9	<i>oI12</i>	<i>Imma</i>
SrZn ₅ (HT)	78.8	<i>hP6</i>	<i>P6/mmm</i>
SrZn ₅ (LT)	78.8	<i>oP24</i>	<i>Pnma</i>
SrZn ₁₃	~90.7	<i>cF112</i>	<i>Fm$\bar{3}c$</i>
(Zn)	100	<i>hP2</i>	<i>P6₃/mmc</i>

Ta (Tantalum) Binary Alloy Phase Diagrams

Introduction

THIS ARTICLE includes systems where tantalum is the first-named element in the binary pair. Additional binary systems that include tantalum are provided in the following locations in this Volume:

- “Al-Ta (Aluminum - Tantalum)” in the article “Al (Aluminum) Binary Alloy Phase Diagrams.”
- “B-Ta (Boron - Tantalum)” in the article “B (Boron) Binary Alloy Phase Diagrams.”
- “C-Ta (Carbon - Tantalum)” in the article “C (Carbon) Binary Alloy Phase Diagrams.”
- “Co-Ta (Cobalt - Tantalum)” in the article “Co (Cobalt) Binary Alloy Phase Diagrams.”
- “Cr-Ta (Chromium - Tantalum)” in the article “Cr (Chromium) Binary Alloy Phase Diagrams.”
- “H-Ta (Hydrogen - Tantalum)” in the article “H (Hydrogen) Binary Alloy Phase Diagrams.”
- “Hf-Ta (Hafnium - Tantalum)” in the article “Hf (Hafnium) Binary Alloy Phase Diagrams.”
- “Ir-Ta (Iridium - Tantalum)” in the article “Ir (Iridium) Binary Alloy Phase Diagrams.”
- “Mo-Ta (Molybdenum - Tantalum)” in the article “Mo (Molybdenum) Binary Alloy Phase Diagrams.”
- “N-Ta (Nitrogen - Tantalum)” in the article “N (Nitrogen) Binary Alloy Phase Diagrams.”
- “Nb-Ta (Niobium - Tantalum)” in the article “Nb (Niobium) Binary Alloy Phase Diagrams.”
- “Ni-Ta (Nickel - Tantalum)” in the article “Ni (Nickel) Binary Alloy Phase Diagrams.”
- “Rh-Ta (Rhodium - Tantalum)” in the article “Rh (Rhodium) Binary Alloy Phase Diagrams.”
- “Ru-Ta (Ruthenium - Tantalum)” in the article “Ru (Ruthenium) Binary Alloy Phase Diagrams.”
- “Si-Ta (Silicon - Tantalum)” in the article “Si (Silicon) Binary Alloy Phase Diagrams.”

Ta-Th (Tantalum - Thorium)

R. Krishnan, S.P. Garg, and N. Krishnamurthy, 1989

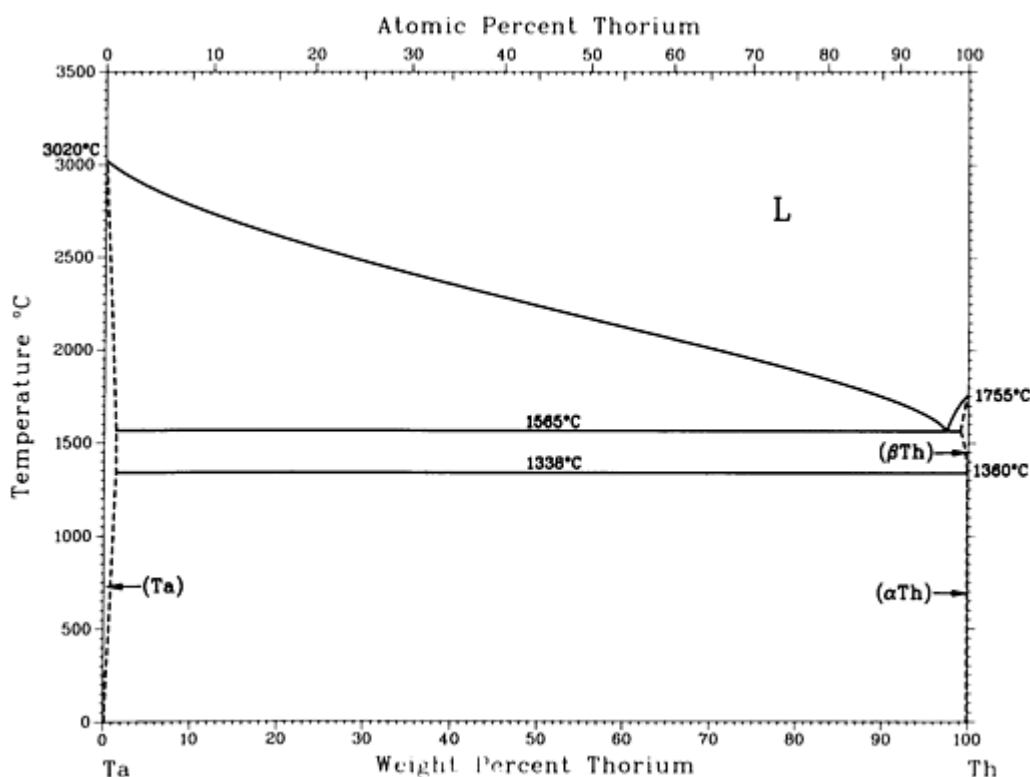

Ta-Th phase diagram

Ta-Th crystallographic data

Phase	Composition, wt% Th	Pearson symbol	Space group
(Ta)	0 to <1	<i>cI2</i>	<i>Im</i> $\bar{3}m$
(β_{Th})	99.85 to 100	<i>cI2</i>	<i>Im</i> $\bar{3}m$
(α_{Th})	>99.9 to 100	<i>cF4</i>	<i>Fm</i> $\bar{3}m$

Ta-Ti (Tantalum - Titanium)

J.L. Murray, 1987

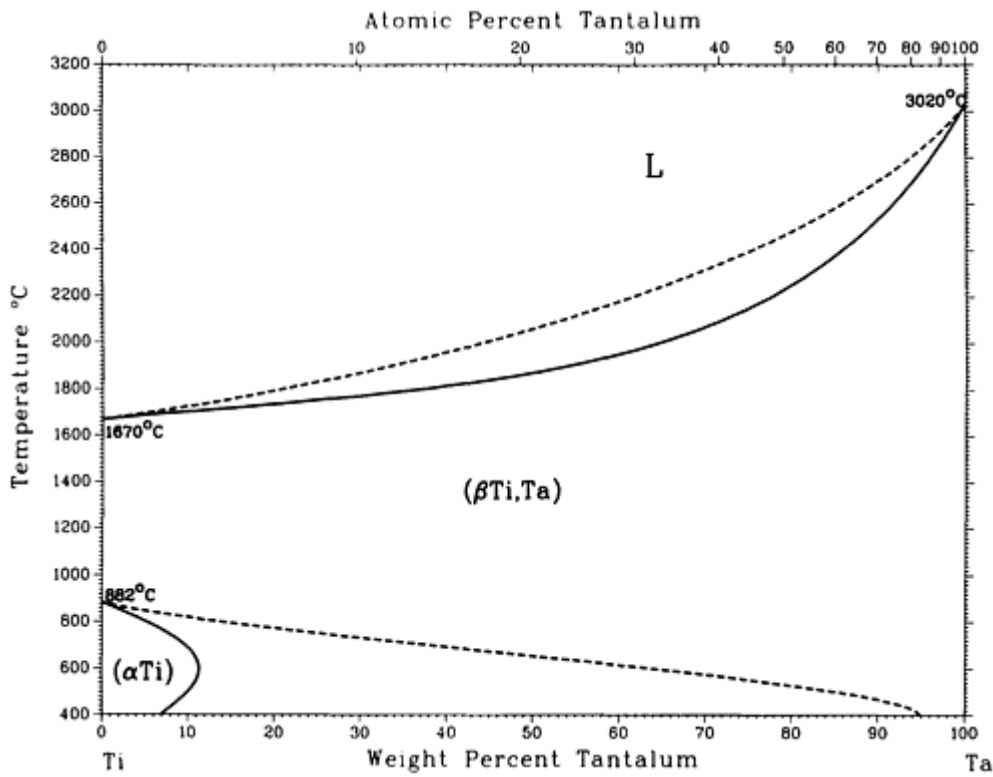

Ta-Ti phase diagram

Ta-Ti crystallographic data

Phase	Composition, wt% Ta	Pearson symbol	Space group
($\beta_{Ti,Ta}$)	0 to 100	<i>cI2</i>	<i>Im</i> $\bar{3}m$

(α Ti)	0 to 12.4	<i>hP2</i>	<i>P6₃/mmc</i>
Metastable phases			
(α')	...	<i>hP2</i>	<i>P6₃/mmc</i>
(α'')	...	<i>oC4</i>	<i>Cmcm</i>
ω	...	<i>hP3</i>	<i>P6/mmm</i> or <i>P$\bar{3}m1$</i>

Ta-U (Tantalum - Uranium)

R. Krishnan, S.P. Garg, and N. Krishnamurthy, 1988

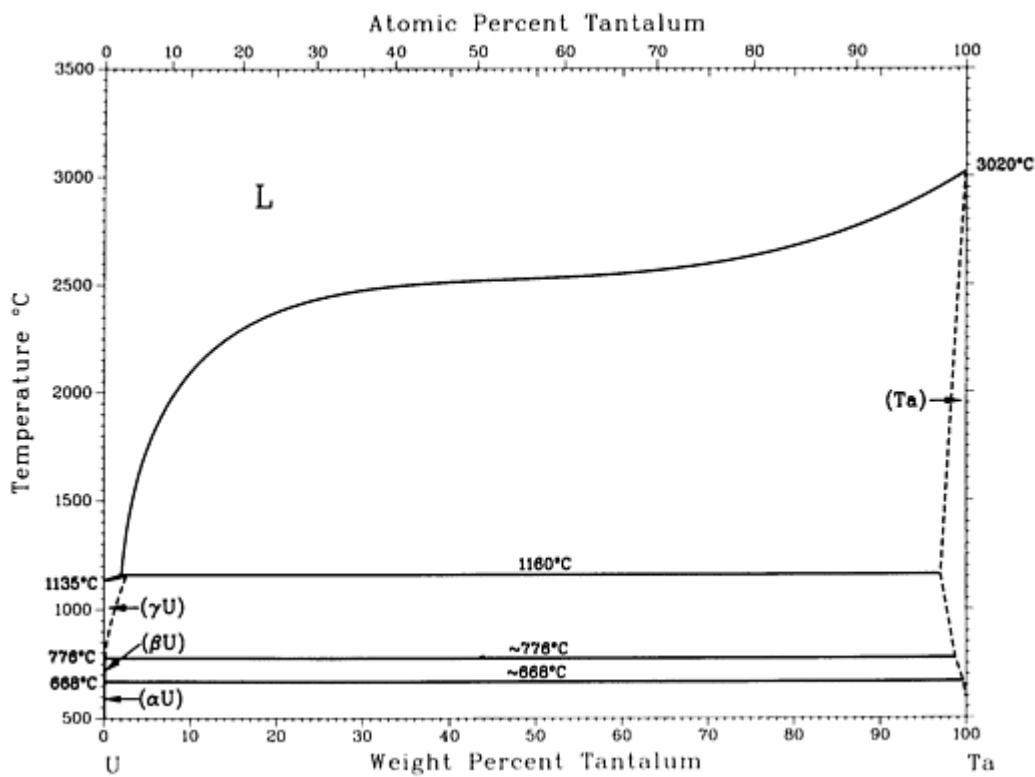

Ta-U phase diagram

Ta-U crystallographic data

Phase	Composition, wt% Ta	Pearson symbol	Space group

(γ_U)	0 to ~ 2	<i>cI2</i>	$Im\bar{3}m$
(β_U)	0	<i>tP30</i>	$P4_2/mnm$
(α_U)	0	<i>oC4</i>	$Cmcm$
(Ta)	? to 100	<i>cI2</i>	$Im\bar{3}m$

Ta-V (Tantalum - Vanadium)

J.F. Smith and O.N. Carlson, 1989

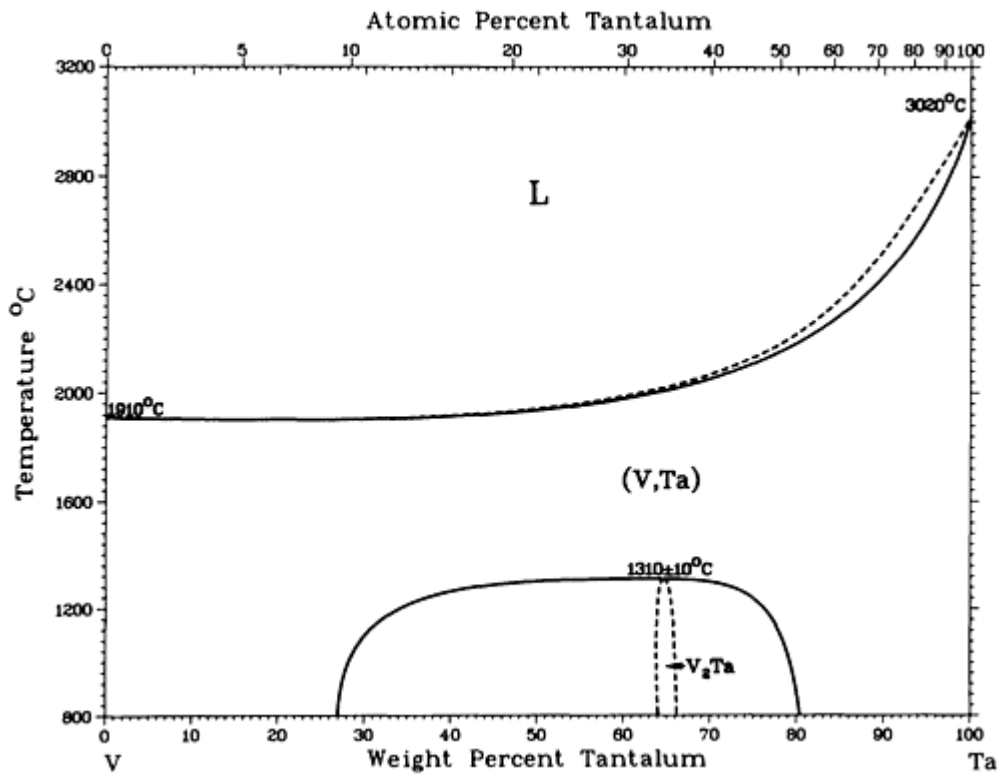

Ta-V phase diagram

Ta-V crystallographic data

Phase	Composition, wt% Ta	Pearson symbol	Space group
(V,Ta)	0 to 100	<i>cI2</i>	$Im\bar{3}m$
V ₂ Ta ^(a)	~ 64 to ~ 67	<i>cF24</i>	$Fd\bar{3}m$

(a) A high-temperature polymorph of V_2Ta has been reported to be a hexagonal $MgZn_2$ -type structure, with $hP12$ and $P6_3/mmc$.

Ta-W (Tantalum - Tungsten)

R. Krishnan, S.P. Garg, and N. Krishnamurthy, 1985

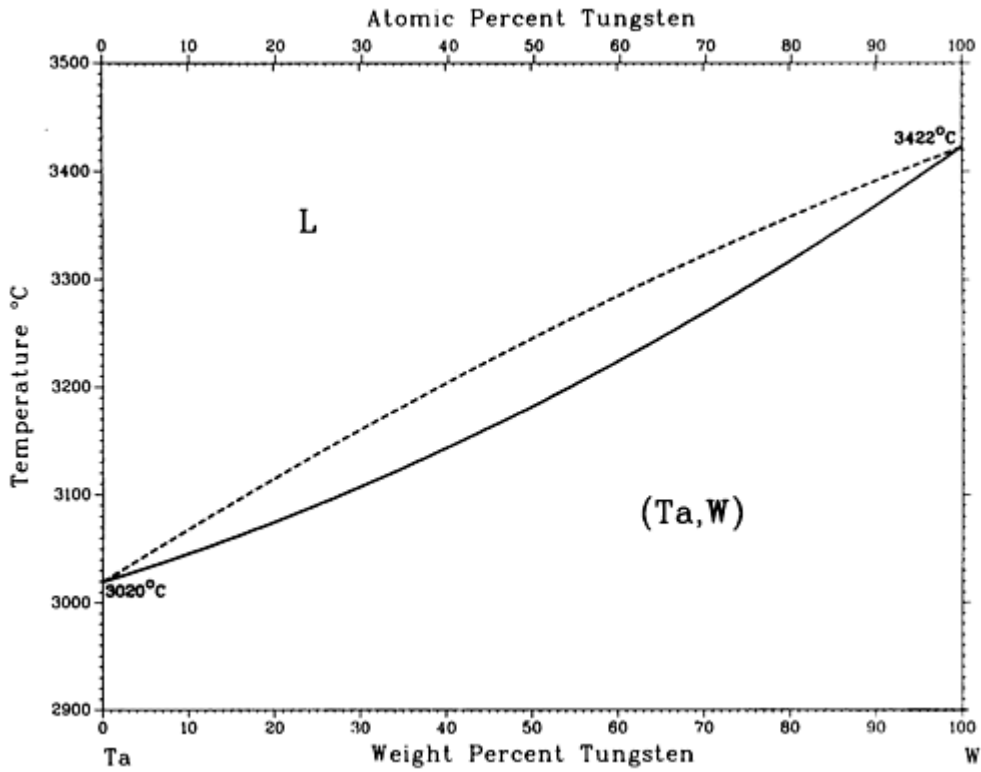

Ta-W phase diagram

Ta-W crystallographic data

Phase	Composition, wt% W	Pearson symbol	Space group
(Ta,W)	0 to 100	$cI2$	$Im\bar{3}m$

Ta-Zr (Tantalum - Zirconium)

R. Krishnan, S.P. Garg, S. Banerjee, and N. Krishnamurthy, 1989

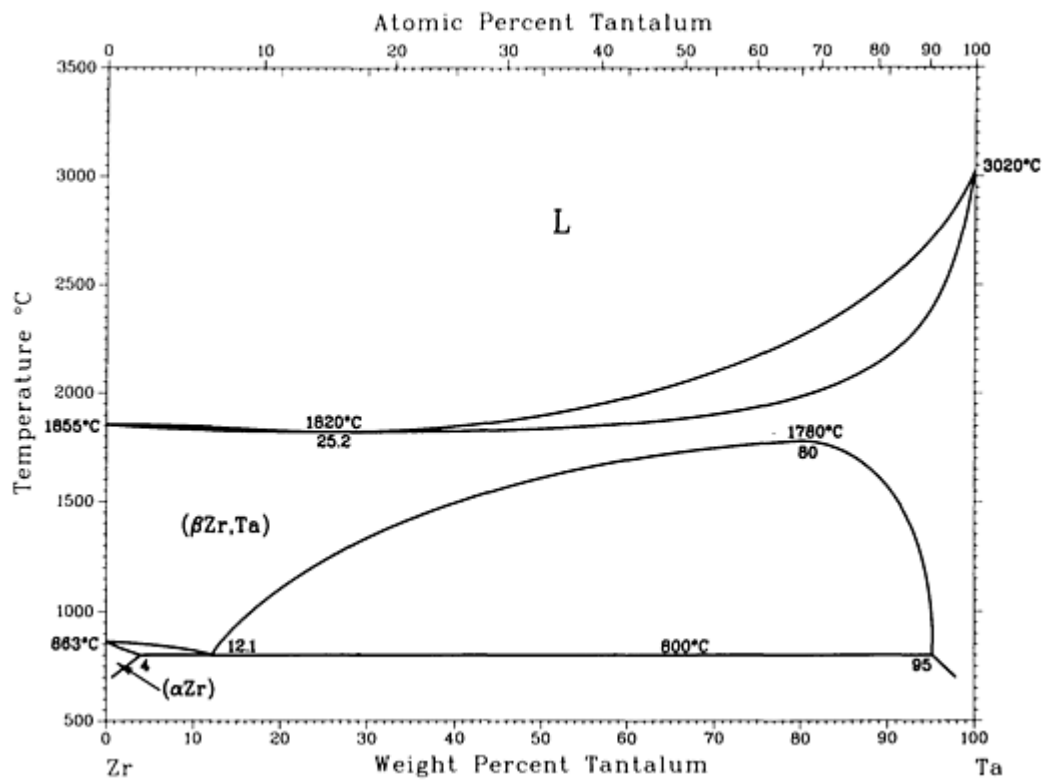

Ta-Zr phase diagram

Ta-Zr crystallographic data

Phase	Composition, wt% Ta	Pearson symbol	Space group
(β _{Zr,Ta})	0 to 100	<i>cI2</i>	<i>Im</i> $\bar{3}m$
(αZr)	0 to 4	<i>hP2</i>	<i>P6₃/mmc</i>

Introduction

THIS ARTICLE includes systems where terbium is the first-named element in the binary pair. Additional binary systems that include terbium are provided in the following locations in this Volume:

- “Co-Tb (Cobalt - Terbium)” in the article “Co (Cobalt) Binary Alloy Phase Diagrams.”
- “Fe-Tb (Iron - Terbium)” in the article “Fe (Iron) Binary Alloy Phase Diagrams.”
- “Ga-Tb (Gallium - Terbium)” in the article “Ga (Gallium) Binary Alloy Phase Diagrams.”
- “Ge-Tb (Germanium - Terbium)” in the article “Ge (Germanium) Binary Alloy Phase Diagrams.”
- “In-Tb (Indium - Terbium)” in the article “In (Indium) Binary Alloy Phase Diagrams.”
- “Sb-Tb (Antimony - Terbium)” in the article “Sb (Antimony) Binary Alloy Phase Diagrams.”

Tb-Tl (Terbium - Thallium)

S. Delfino, A. Saccone, A. Palenzona, and R. Ferro, unpublished

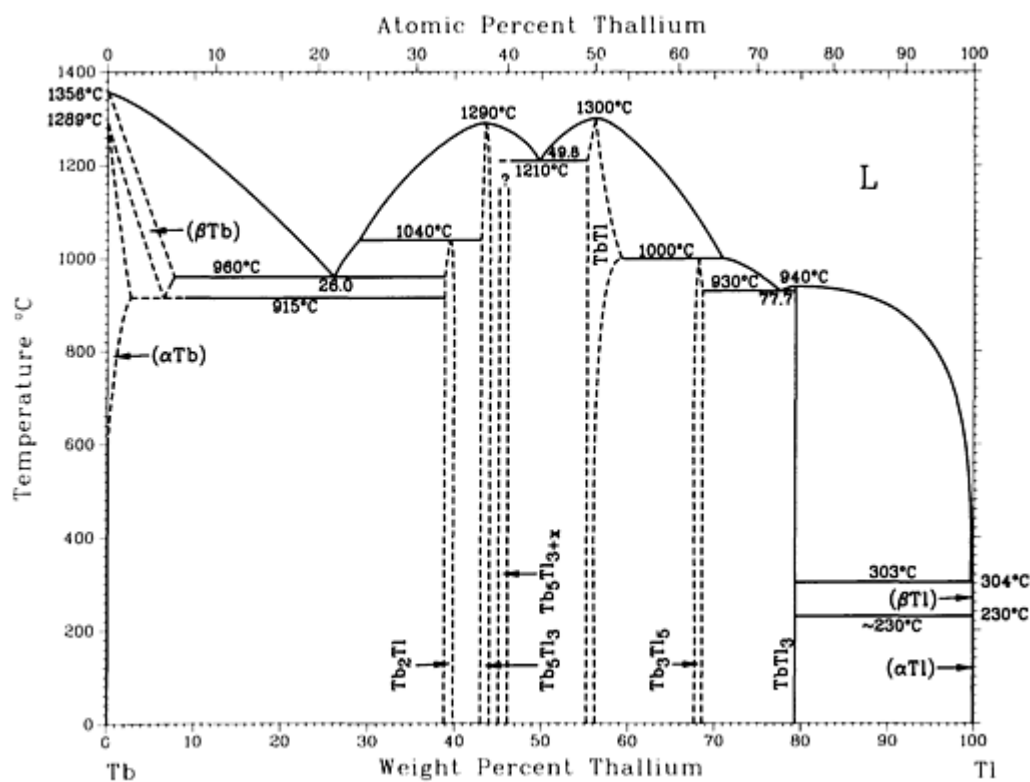

Tb-Tl phase diagram

Tb-Tl crystallographic data

Phase	Composition, wt% Tl	Pearson symbol	Space group
(β)Tb	0 to ~6	cI2	<i>Im</i> $\bar{3}m$

(α Tb)	0 to ?	<i>hP2</i>	<i>P6₃/mmc</i>
Tb ₂ Tl	~39 to ~40	<i>hP6</i>	<i>P6₃/mmc</i>
β Tb ₅ Tl ₃	~43 to ~44	<i>hP16</i>	<i>P6₃/mcm</i>
α Tb ₅ Tl ₃	~43 to ~44	<i>tI32</i>	<i>I4/mcm</i>
Tb ₅ Tl _{3+x}	?	<i>tI32</i>	<i>I4/mcm</i>
TbTl	~55 to ~59 ~55 to ~59	<i>cP2</i> ^(a) (or <i>cI2</i>) <i>tP2</i> ^(b)	<i>Pm</i> $\bar{3}m$ <i>Im</i> $\bar{3}m$ <i>P4/mmm</i>
Tb ₃ Tl ₅	~68 to ~69	<i>oC32</i>	<i>Cmcm</i>
TbTl ₃	79	<i>cP4</i>	<i>Pm</i> $\bar{3}m$
(β Tl)	100	<i>cI2</i>	<i>Im</i> $\bar{3}m$
(α Tl)	100	<i>hP2</i>	<i>P6₃/mmc</i>

(a) High-temperature phase (>250 K).

(b) Low-temperature phase

Te (Tellurium) Binary Alloy Phase Diagrams

Introduction

THIS ARTICLE includes systems where tellurium is the first-named element in the binary pair. Additional binary systems that include tellurium are provided in the following locations in this Volume:

- “Ag-Te (Silver - Tellurium)” in the article “Ag (Silver) Binary Alloy Phase Diagrams.”
- “Al-Te (Aluminum - Tellurium)” in the article “Al (Aluminum) Binary Alloy Phase Diagrams.”
- “As-Te (Arsenic - Tellurium)” in the article “As (Arsenic) Binary Alloy Phase Diagrams.”
- “Au-Te (Gold - Tellurium)” in the article “Au (Gold) Binary Alloy Phase Diagrams.”
- “Ba-Te (Barium - Tellurium)” in the article “Ba (Barium) Binary Alloy Phase Diagrams.”
- “Bi-Te (Bismuth - Tellurium)” in the article “Bi (Bismuth) Binary Alloy Phase Diagrams.”
- “Cd-Te (Cadmium - Tellurium)” in the article “Cd (Cadmium) Binary Alloy Phase Diagrams.”
- “Ce-Te (Cerium - Tellurium)” in the article “Ce (Cerium) Binary Alloy Phase Diagrams.”
- “Co-Te (Cobalt - Tellurium)” in the article “Co (Cobalt) Binary Alloy Phase Diagrams.”
- “Cr-Te (Chromium - Tellurium)” in the article “Cr (Chromium) Binary Alloy Phase Diagrams.”
- “Cs-Te (Cesium - Tellurium)” in the article “Cs (Cesium) Binary Alloy Phase Diagrams.”
- “Cu-Te (Copper - Tellurium)” in the article “Cu (Copper) Binary Alloy Phase Diagrams.”

- “Dy-Te (Dysprosium - Tellurium)” in the article “Dy (Dysprosium) Binary Alloy Phase Diagrams.”
- “Er-Te (Erbium - Tellurium)” in the article “Er (Erbium) Binary Alloy Phase Diagrams.”
- “Eu-Te (Europium - Tellurium)” in the article “Eu (Europium) Binary Alloy Phase Diagrams.”
- “Fe-Te (Iron - Tellurium)” in the article “Fe (Iron) Binary Alloy Phase Diagrams.”
- “Ga-Te (Gallium - Tellurium)” in the article “Ga (Gallium) Binary Alloy Phase Diagrams.”
- “Gd-Te (Gadolinium - Tellurium)” in the article “Gd (Gadolinium) Binary Alloy Phase Diagrams.”
- “Ge-Te (Germanium - Tellurium)” in the article “Ge (Germanium) Binary Alloy Phase Diagrams.”
- “Hg-Te (Mercury - Tellurium)” in the article “Hg (Mercury) Binary Alloy Phase Diagrams.”
- “Ho-Te (Holmium - Tellurium)” in the article “Ho (Holmium) Binary Alloy Phase Diagrams.”
- “In-Te (Indium - Tellurium)” in the article “In (Indium) Binary Alloy Phase Diagrams.”
- “K-Te (Potassium - Tellurium)” in the article “K (Potassium) Binary Alloy Phase Diagrams.”
- “Li-Te (Lithium - Tellurium)” in the article “Li (Lithium) Binary Alloy Phase Diagrams.”
- “Na-Te (Sodium - Tellurium)” in the article “Na (Sodium) Binary Alloy Phase Diagrams.”
- “Nd-Te (Neodymium - Tellurium)” in the article “Nd (Neodymium) Binary Alloy Phase Diagrams.”
- “Ni-Te (Nickel - Tellurium)” in the article “Ni (Nickel) Binary Alloy Phase Diagrams.”
- “Pb-Te (Lead - Tellurium)” in the article “Pb (Lead) Binary Alloy Phase Diagrams.”
- “Pd-Te (Palladium - Tellurium)” in the article “Pd (Palladium) Binary Alloy Phase Diagrams.”
- “Pr-Te (Praseodymium - Tellurium)” in the article “Pr (Praseodymium) Binary Alloy Phase Diagrams.”
- “Pt-Te (Platinum - Tellurium)” in the article “Pt (Platinum) Binary Alloy Phase Diagrams.”
- “Re-Te (Rhenium - Tellurium)” in the article “Re (Rhenium) Binary Alloy Phase Diagrams.”
- “S-Te (Sulfur - Tellurium)” in the article “S (Sulfur) Binary Alloy Phase Diagrams.”
- “Sb-Te (Antimony - Tellurium)” in the article “Sb (Antimony) Binary Alloy Phase Diagrams.”
- “Se-Te (Selenium - Tellurium)” in the article “Se (Selenium) Binary Alloy Phase Diagrams.”
- “Si-Te (Silicon - Tellurium)” in the article “Si (Silicon) Binary Alloy Phase Diagrams.”
- “Sn-Te (Tin - Tellurium)” in the article “Sn (Tin) Binary Alloy Phase Diagrams.”
- “Sr-Te (Strontium - Tellurium)” in the article “Sr (Strontium) Binary Alloy Phase Diagrams.”

Te-Tl (Tellurium - Thallium)

H. Okamoto, 1991

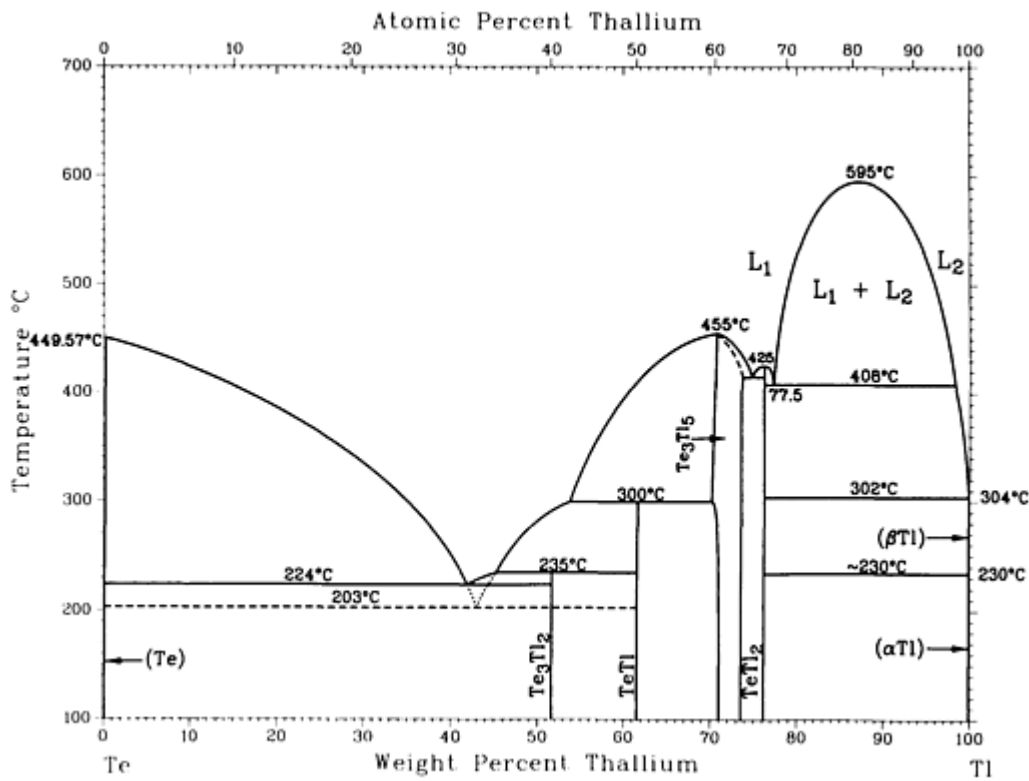

Te-Tl phase diagram

Te-Tl crystallographic data

Phase	Composition, wt% Tl	Pearson symbol	Space group
(Te)	0	<i>hP3</i>	<i>P3₁21</i>
Te ₃ Tl ₂	52	<i>mC20</i>	<i>Cc</i>
TeTl	61.6	<i>tI32</i>	<i>I4/mcm</i>
Te ₃ Tl ₅	72.7	<i>tI32</i>	<i>I4/m</i>
TeTl ₂	76.2
(βTl)	100	<i>cI2</i>	<i>Im$\bar{3}m$</i>

(α Tl)	100	<i>hP2</i>	<i>P6₃/mmc</i>
----------------	-----	------------	---------------------------

Te-U (Tellurium - Uranium)

From [Moffatt] 11

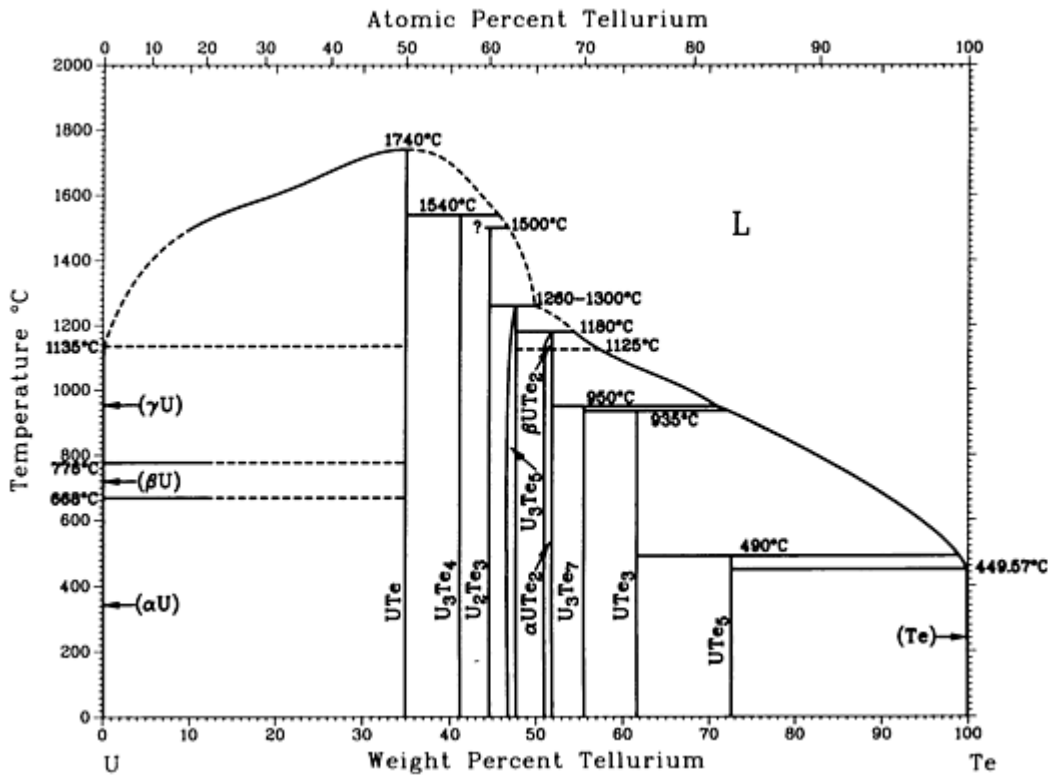

Te-U phase diagram

Te-U crystallographic data

Phase	Composition, wt% Te	Pearson symbol	Space group
(γ U)	0	<i>cI2</i>	<i>Im$\bar{3}m$</i>
(β U)	0	<i>tP30</i>	<i>P4₂mm</i>
(α U)	0	<i>oC4</i>	<i>Cmcm</i>
UTe	34.9	<i>cF8</i>	<i>Fm$\bar{3}m$</i>

U_3Te_4	~41.0	<i>cI28</i>	<i>$I\bar{4}3d$</i>
U_2Te_3	45	<i>hP16</i>	<i>$P6_3/mcm$</i>
U_3Te_5	47 to 48	<i>oP32</i>	<i>$Pnma$</i>
$\beta/\alpha UTe_2$	51 to 52	<i>oI12</i> <i>tP6</i>	<i>$Immm$</i> <i>$P4/nmm$</i>
U_3Te_7	56
UTe_3	62	<i>t**</i>	...
UTe_5	73.1
(Te)	100	<i>hP3</i>	<i>$P3_121$</i>

Reference cited in this section

- [**Moffatt**]: W.G. Moffatt, Ed., *Handbook of Binary Phase Diagrams*, Business Growth Services, General Electric Co., Schenectady, NY (1976).

Te-Yb (Tellurium - Ytterbium)

H. Okamoto, 1990

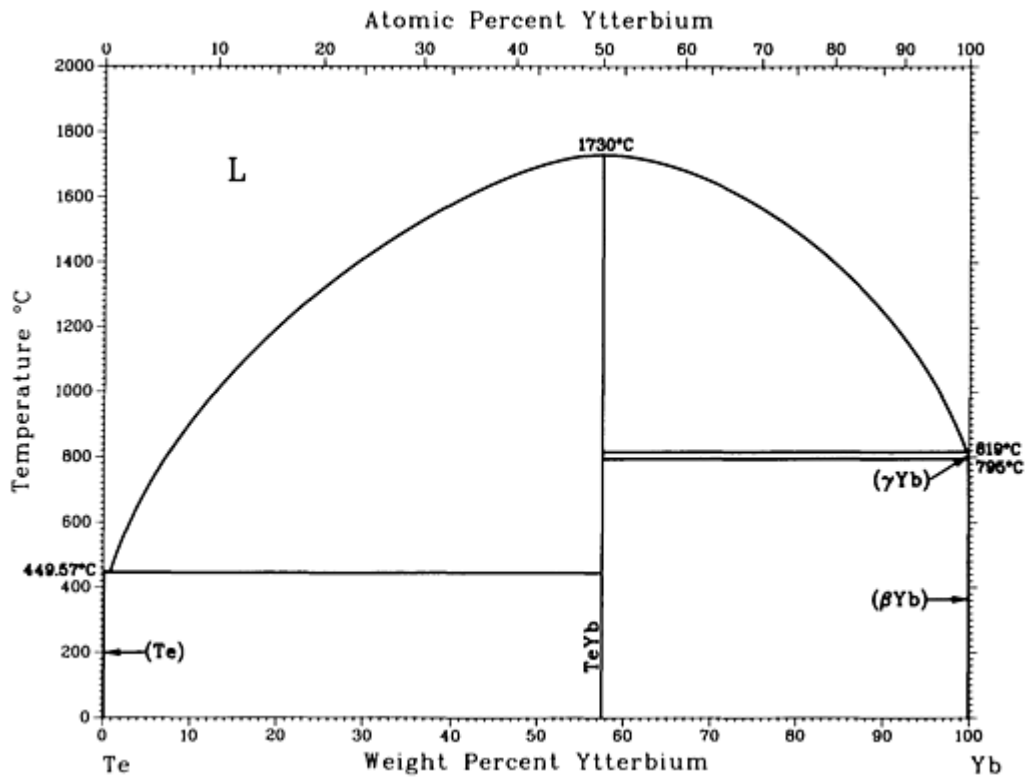

Te-Yb phase diagram

Te-Yb crystallographic data

Phase	Composition, wt% Yb	Pearson symbol	Space group
(Te)	0	<i>hP3</i>	<i>P3₁21</i>
TeYb	57.6	<i>cF8</i>	<i>Fm$\bar{3}m$</i>
(γ Yb)	100	<i>cI2</i>	<i>Im$\bar{3}m$</i>
(β Yb)	100	<i>cF4</i>	<i>Fm$\bar{3}m$</i>
(α Yb)	100	<i>hP2</i>	<i>P6₃/mmc</i>

Introduction

THIS ARTICLE includes systems where thorium is the first-named element in the binary pair. Additional binary systems that include thorium are provided in the following locations in this Volume:

- “Al-Th (Aluminum - Thorium)” in the article “Al (Aluminum) Binary Phase Diagrams.”
- “Au-Th (Gold - Thorium)” in the article “Au (Gold) Binary Phase Diagrams.”
- “Be-Th (Beryllium - Thorium)” in the article “Be (Beryllium) Binary Phase Diagrams.”
- “C-Th (Carbon - Thorium)” in the article “C (Carbon) Binary Phase Diagrams.”
- “Cd-Th (Cadmium - Thorium)” in the article “Cd (Cadmium) Binary Phase Diagrams.”
- “Co-Th (Cobalt - Thorium)” in the article “Co (Cobalt) Binary Phase Diagrams.”
- “Cu-Th (Copper - Thorium)” in the article “Cu (Copper) Binary Phase Diagrams.”
- “Fe-Th (Iron - Thorium)” in the article “Fe (Iron) Binary Phase Diagrams.”
- “In-Th (Indium - Thorium)” in the article “In (Indium) Binary Phase Diagrams.”
- “Ir-Th (Iridium - Thorium)” in the article “Ir (Iridium) Binary Phase Diagrams.”
- “Mg-Th (Magnesium - Thorium)” in the article “Mg (Magnesium) Binary Phase Diagrams.”
- “N-Th (Nitrogen - Thorium)” in the article “N (Nitrogen) Binary Phase Diagrams.”
- “Nb-Th (Niobium - Thorium)” in the article “Nb (Niobium) Binary Phase Diagrams.”
- “Si-Th (Silicon - Thorium)” in the article “Si (Silicon) Binary Phase Diagrams.”
- “Ta-Th (Tantalum - Thorium)” in the article “Ta (Tantalum) Binary Phase Diagrams.”

Th-Ti (Thorium - Titanium)

J.L. Murray, 1987

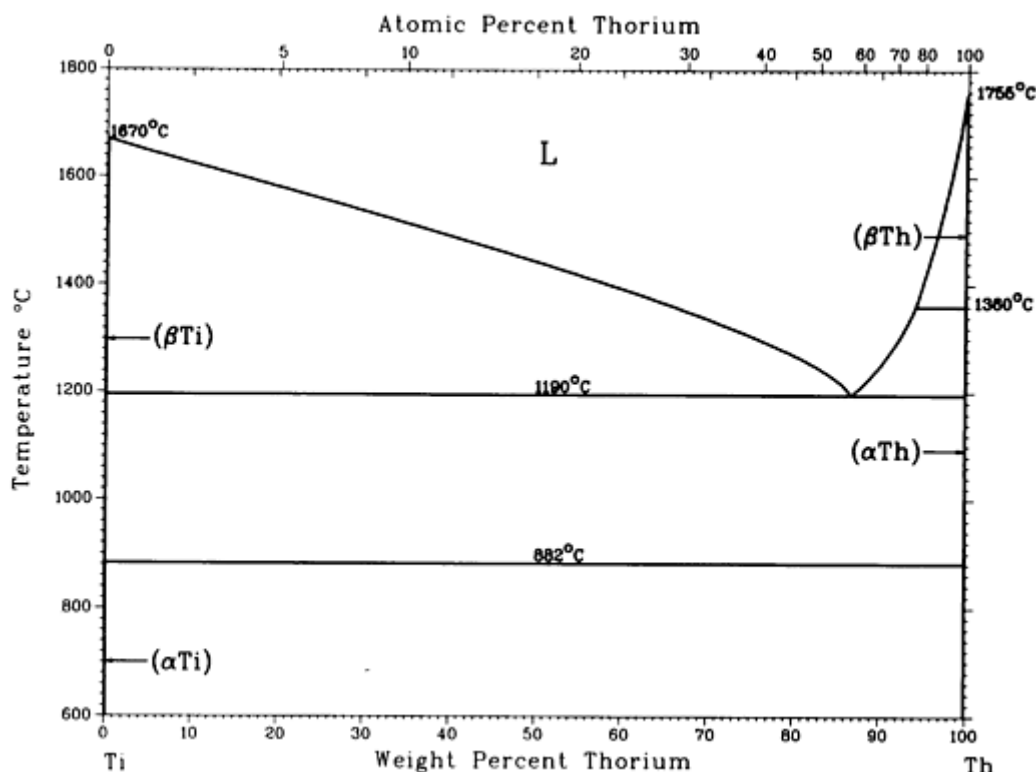

Th-Ti phase diagram

Th-Ti crystallographic data

Phase	Composition, wt% Th	Pearson symbol	Space group
(β Ti)	0	<i>cI2</i>	<i>Im$\bar{3}m$</i>
(α Ti)	0	<i>hP2</i>	<i>P6$_3$/mmc</i>
(β Th)	100	<i>cI2</i>	<i>Im$\bar{3}m$</i>
(α Th)	100	<i>cF4</i>	<i>Fm$\bar{3}m$</i>

Th-Tl (Thorium - Thallium)

H. Okamoto, 1990

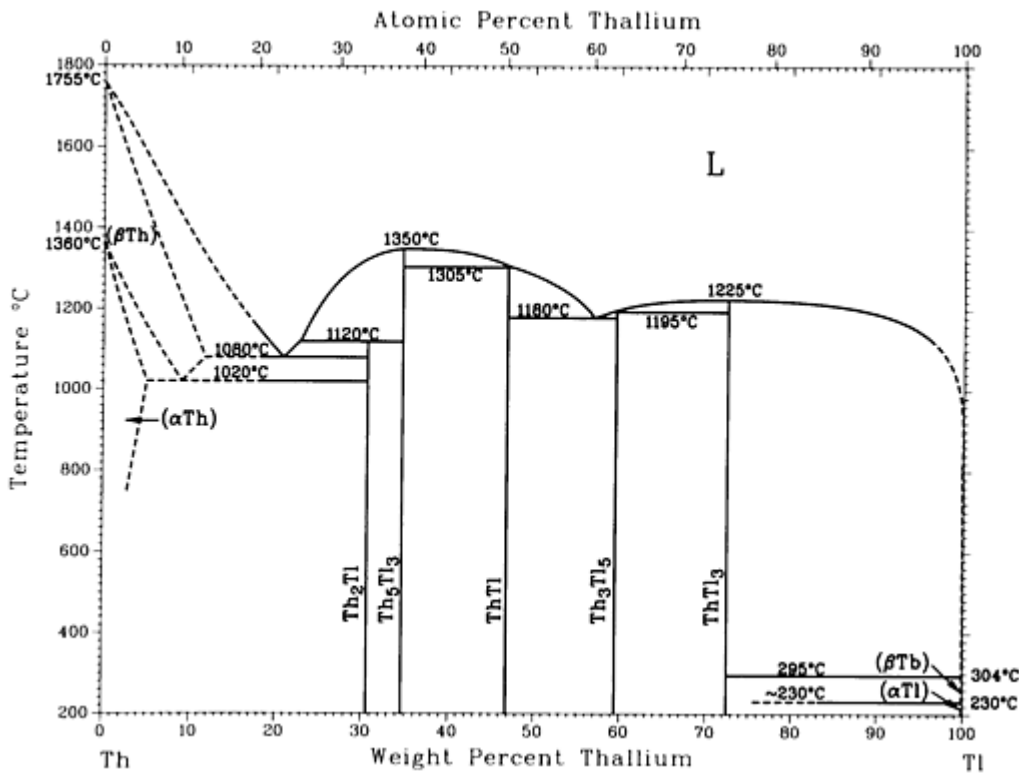

Th-Tl phase diagram

Th-Tl crystallographic data

Phase	Composition, wt% Tl	Pearson symbol	Space group
(β Tb)	~230%		
(α Tl)	~230%		
(β Tl)	295%		
(α Tl)	304%		

(β_{Th})	0 to ?	$cI2$	$Im\bar{3}m$
(α_{Th})	0 to ?	$cF4$	$Fm\bar{3}m$
Th_2Tl	30.5	$tI12$	$I4/mcm$
Th_5Tl_3	34.6	$hP16$	$P6_3/mcm$
ThTl	46.8	$oP24$	$Pbcm$
Th_3Tl_5	59.5	$oC32$	$Cmcm$
ThTl_3	73	$cP4$	$Pm\bar{3}m$
(β_{Tl})	100	$cI2$	$Im\bar{3}m$
(α_{Tl})	100	$hP2$	$P6_3/mmc$

Th-Zn (Thorium - Zinc)

P. Chiotti and K.J. Gill, 1961

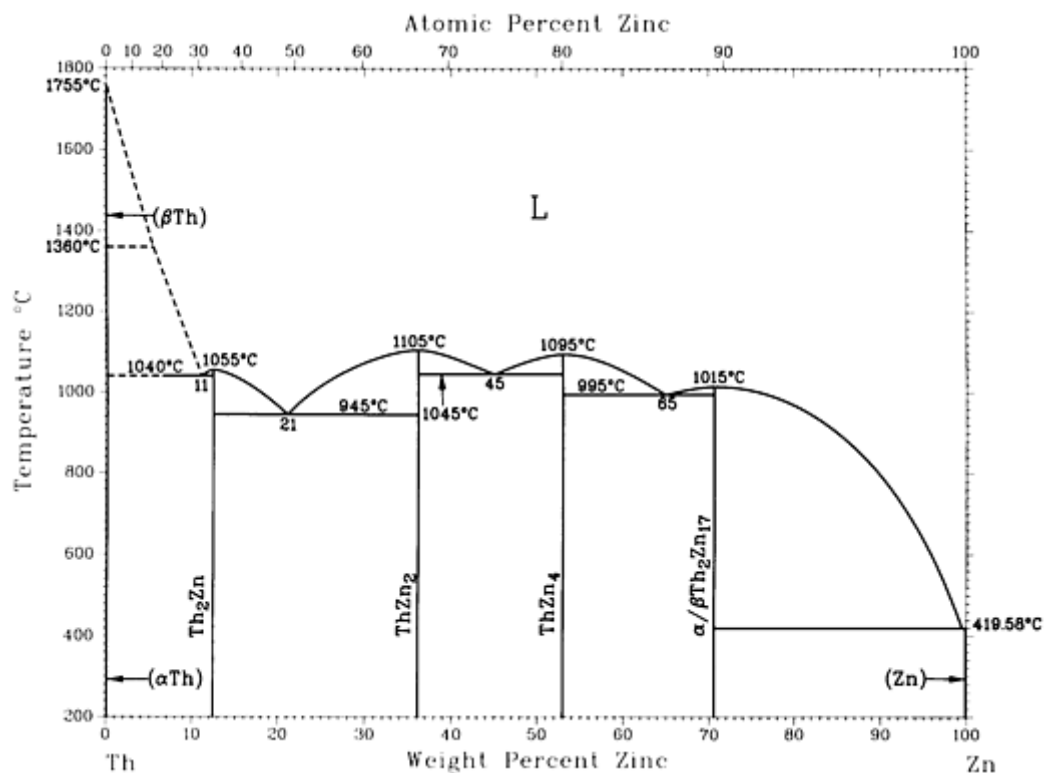

Th-Zn phase diagram

Th-Zn crystallographic data

Phase	Composition, wt% Zn	Pearson symbol	Space group
(βTh)	0	<i>cI2</i>	<i>Im</i> $\bar{3}m$
(αTh)	0	<i>cF2</i>	<i>Fm</i> $\bar{3}m$
Th ₂ Zn	12.3	<i>tI12</i>	<i>I4/mcm</i>
ThZn ₂	36.1	<i>hP3</i>	<i>P6/mmm</i>
ThZn ₄	53	<i>tI10</i>	<i>I4/mmm</i>
β-Th ₂ Zn ₁₇	70.6	<i>hR19</i>	<i>R</i> $\bar{3}m$

$\alpha\text{Th}_2\text{Zn}_{17}$	70.6	<i>hP38</i>	<i>P6_3/mmc</i>
(Zn)	100	<i>hP2</i>	<i>P6_3/mmc</i>

Th-Zr (Thorium - Zirconium)

E.D. Gibson, B.A. Loomis, and O.N. Carlson, 1958; R.H. Johnson and R.W.K. Honeycombe, 1961

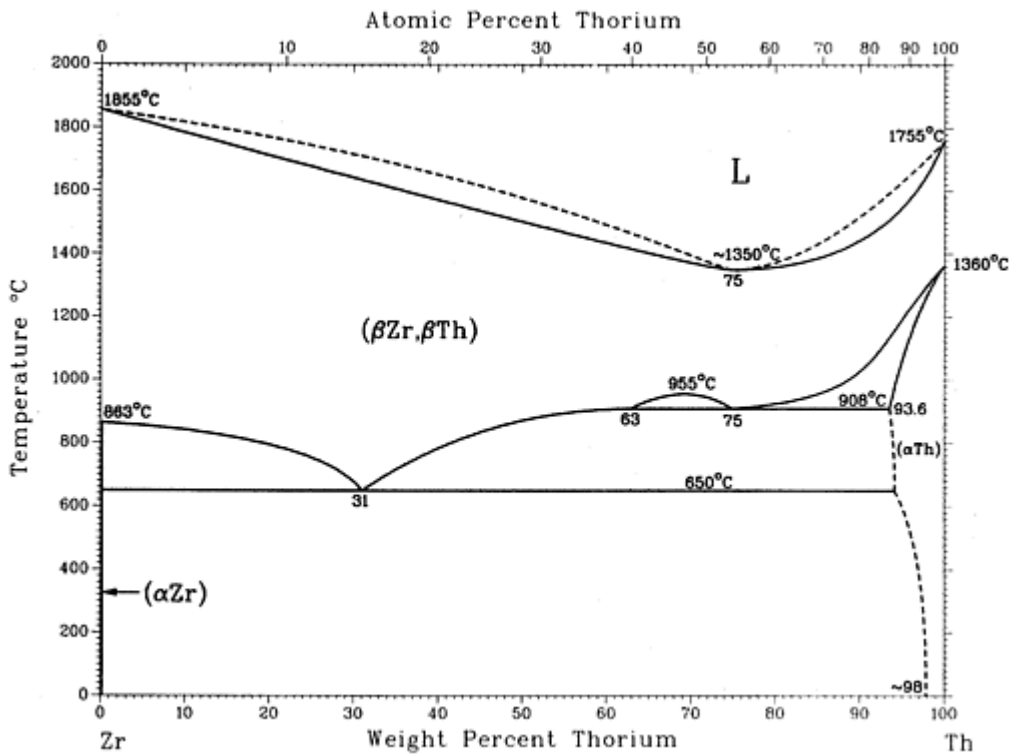

Th-Zr phase diagram

Th-Zr crystallographic data

Phase	Composition, wt% Th	Pearson symbol	Space group
$(\beta_{\text{Zr}}, \beta_{\text{Th}})$	0 to 100	<i>cI2</i>	<i>Im\bar{3}m</i>
(αZr)	0	<i>hP2</i>	<i>P6_3/mmc</i>
(αTh)	93.6 to 100	<i>cF4</i>	<i>Fm\bar{3}m</i>

Introduction

THIS ARTICLE includes systems where titanium is the first-named element in the binary pair. Additional binary systems that include titanium are provided in the following locations in this Volume:

- “Ag-Ti (Silver - Titanium)” in the article “Ag (Silver) Binary Alloy Phase Diagrams.”
- “Al-Ti (Aluminum - Titanium)” in the article “Al (Aluminum) Binary Alloy Phase Diagrams.”
- “Au-Ti (Gold - Titanium)” in the article “Au (Gold) Binary Alloy Phase Diagrams.”
- “B-Ti (Boron - Titanium)” in the article “B (Boron) Binary Alloy Phase Diagrams.”
- “Be-Ti (Beryllium - Titanium)” in the article “Be (Beryllium) Binary Alloy Phase Diagrams.”
- “C-Ti (Carbon - Titanium)” in the article “C (Carbon) Binary Alloy Phase Diagrams.”
- “Ce-Ti (Cerium - Titanium)” in the article “Ce (Cerium) Binary Alloy Phase Diagrams.”
- “Co-Ti (Cobalt - Titanium)” in the article “Co (Cobalt) Binary Alloy Phase Diagrams.”
- “Cr-Ti (Chromium - Titanium)” in the article “Cr (Chromium) Binary Alloy Phase Diagrams.”
- “Cu-Ti (Copper - Titanium)” in the article “Cu (Copper) Binary Alloy Phase Diagrams.”
- “Er-Ti (Erbium - Titanium)” in the article “Er (Erbium) Binary Alloy Phase Diagrams.”
- “Fe-Ti (Iron - Titanium)” in the article “Fe (Iron) Binary Alloy Phase Diagrams.”
- “Gd-Ti (Gadolinium - Titanium)” in the article “Gd (Gadolinium) Binary Alloy Phase Diagrams.”
- “Ge-Ti (Germanium - Titanium)” in the article “Ge (Germanium) Binary Alloy Phase Diagrams.”
- “H-Ti (Hydrogen - Titanium)” in the article “H (Hydrogen) Binary Alloy Phase Diagrams.”
- “In-Ti (Indium - Titanium)” in the article “In (Indium) Binary Alloy Phase Diagrams.”
- “Ir-Ti (Iridium - Titanium)” in the article “Ir (Iridium) Binary Alloy Phase Diagrams.”
- “Mn-Ti (Manganese - Titanium)” in the article “Mn (Manganese) Binary Alloy Phase Diagrams.”
- “Mo-Ti (Molybdenum - Titanium)” in the article “Mo (Molybdenum) Binary Alloy Phase Diagrams.”
- “N-Ti (Nitrogen - Titanium)” in the article “N (Nitrogen) Binary Alloy Phase Diagrams.”
- “Nb-Ti (Niobium - Titanium)” in the article “Nb (Niobium) Binary Alloy Phase Diagrams.”
- “Nd-Ti (Neodymium - Titanium)” in the article “Nd (Neodymium) Binary Alloy Phase Diagrams.”
- “Ni-Ti (Nickel - Titanium)” in the article “Ni (Nickel) Binary Alloy Phase Diagrams.”
- “O-Ti (Oxygen - Titanium)” in the article “O (Oxygen) Binary Alloy Phase Diagrams.”
- “Os-Ti (Osmium - Titanium)” in the article “Os (Osmium) Binary Alloy Phase Diagrams.”
- “P-Ti (Phosphorus - Titanium)” in the article “P (Phosphorous) Binary Alloy Phase Diagrams.”
- “Pd-Ti (Palladium - Titanium)” in the article “Pd (Palladium) Binary Alloy Phase Diagrams.”
- “Pt-Ti (Platinum - Titanium)” in the article “Pt (Platinum) Binary Alloy Phase Diagrams.”
- “Rh-Ti (Rhodium - Titanium)” in the article “Rh (Rhodium) Binary Alloy Phase Diagrams.”
- “Ru-Ti (Ruthenium - Titanium)” in the article “Ru (Ruthenium) Binary Alloy Phase Diagrams.”
- “S-Ti (Sulfur - Titanium)” in the article “S (Sulfur) Binary Alloy Phase Diagrams.”
- “Sc-Ti (Scandium - Titanium)” in the article “Sc (Scandium) Binary Alloy Phase Diagrams.”
- “Si-Ti (Silicon - Titanium)” in the article “Si (Silicon) Binary Alloy Phase Diagrams.”
- “Sn-Ti (Tin - Titanium)” in the article “Sn (Tin) Binary Alloy Phase Diagrams.”
- “Ta-Ti (Tantalum - Titanium)” in the article “Ta (Tantalum) Binary Alloy Phase Diagrams.”
- “Th-Ti (Thorium - Titanium)” in the article “Th (Thorium) Binary Alloy Phase Diagrams.”

Ti-U (Titanium - Uranium)

J.L. Murray, 1987

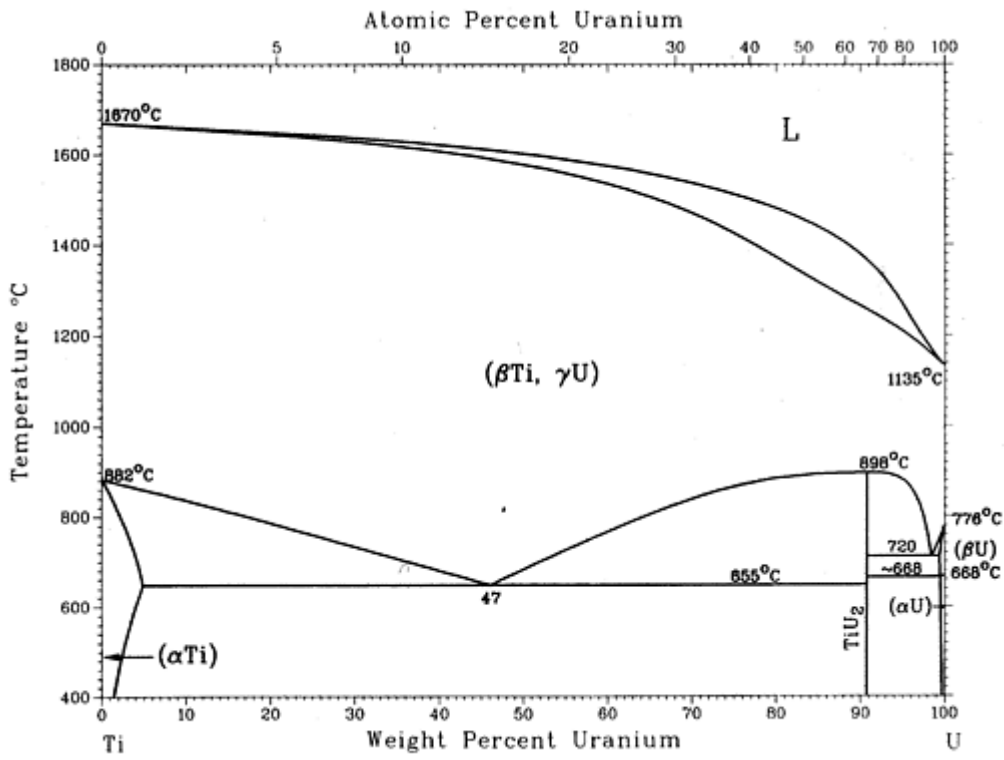

Ti-U phase diagram

Ti-U crystallographic data

Phase	Composition, wt% U	Pearson symbol	Space group
(β _{Ti} , γ _U)	0 to 100	<i>cI2</i>	<i>Im</i> $\bar{3}m$
(αTi)	0 to ~5	<i>hP2</i>	<i>P6</i> ₃ / <i>mmc</i>
TiU ₂	90.9	<i>hP3</i>	<i>P6</i> / <i>mmm</i>
(β _U)	~99.6 to 100	<i>tP30</i>	<i>P4</i> ₂ / <i>nm</i>
(αU)	~99.6 to 100	<i>oC4</i>	<i>Cmcm</i>
α _b ^(a)	38	(b)	...

(a) Metastable.

(b) Monoclinic

Ti-V (Titanium - Vanadium)

J.L. Murray, 1989

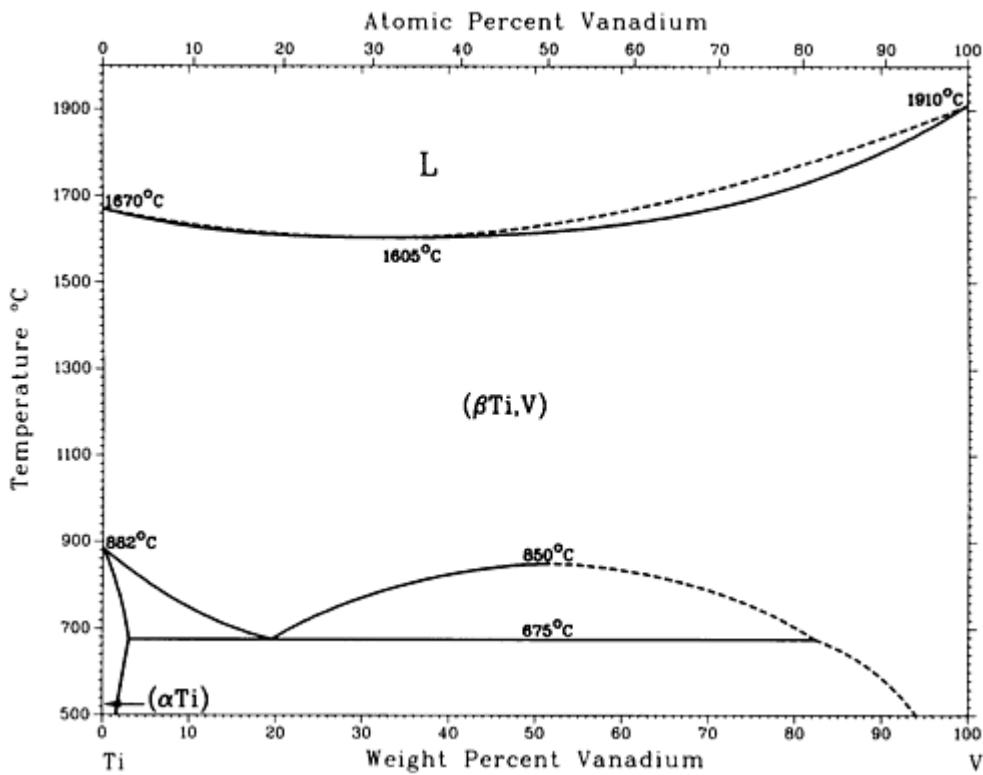

Ti-V phase diagram

Ti-V crystallographic data

Phase	Composition, wt% V	Pearson symbol	Space group
(β _{Ti,V})	0 to 100	<i>cI2</i>	<i>Im</i> $\bar{3}m$
(αTi)	0 to ~3	<i>hP2</i>	<i>P6</i> ₃ / <i>mmc</i>
Metastable phases			

α'	0 to 5	$hP2$	$P6_3/mmc$
α''	5 to 16	$oC4$	$Cmcm$
ω	12 to ~ 51.5	$hP3$	$P6/mmm$ or $P\bar{3}m1$

Ti-W (Titanium - Tungsten)

J.L. Murray, 1987

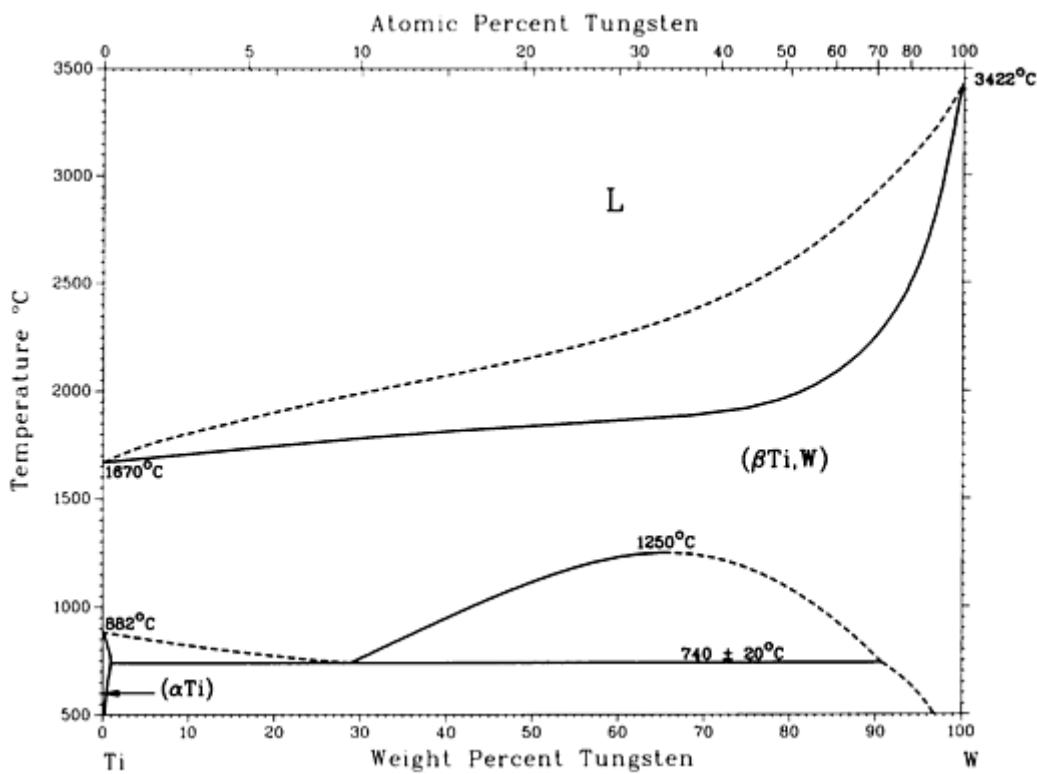

Ti-W phase diagram

Ti-W crystallographic data

Phase	Composition, wt% W	Pearson symbol	Space group
$(\beta_{Ti,W})$	0 to 100	$cI2$	$Im\bar{3}m$
(αTi)	0 to 0.8	$hP2$	$P6_3/mmc$

$\alpha^{(a)}$	0 to 7	<i>hP2</i>	<i>P6₃/mmc</i>
$\alpha^{(a)}$	7 to 18.3	<i>oC4</i>	<i>Cmcm</i>
$\omega^{(a)}$	20 to 30	<i>hP3</i>	<i>P6/mmm</i>

(a) Metastable

Ti-Y (Titanium - Yttrium)

J.L. Murray, 1987

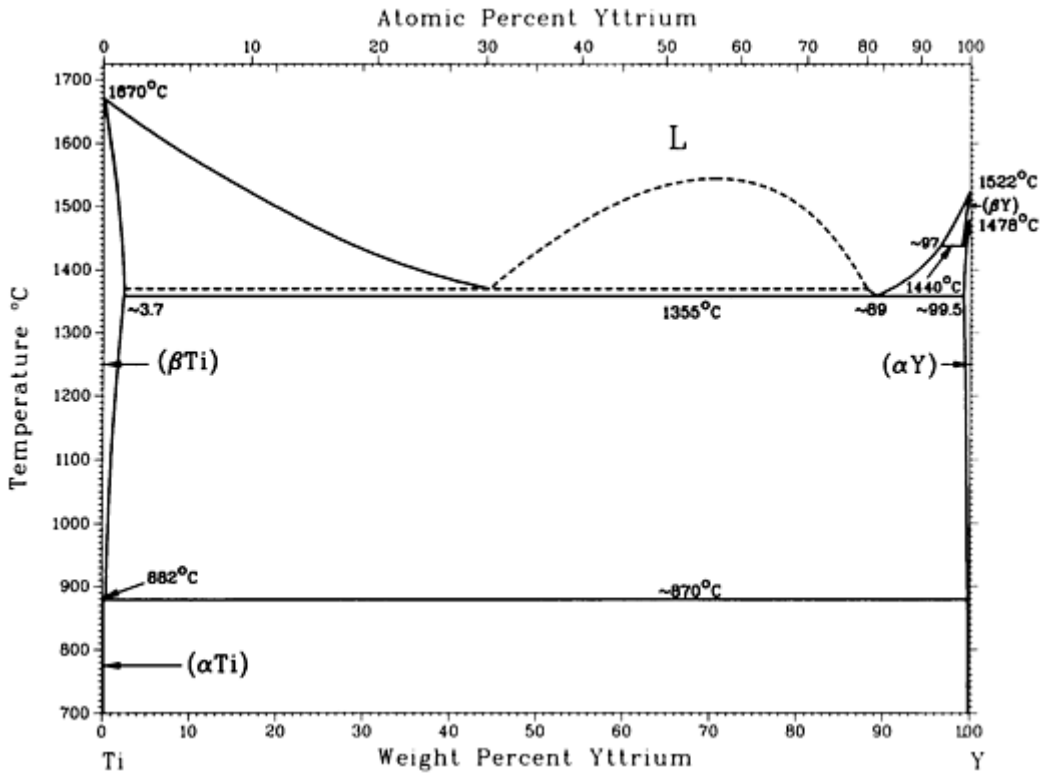

Ti-Y phase diagram

Ti-Y crystallographic data

Phase	Composition, wt% Y	Pearson symbol	Space group
(βTi)	0 to ~3.7	<i>cI2</i>	<i>Im$\bar{3}m$</i>

(α Ti)	0 to \sim 0.02	<i>hP2</i>	<i>P6₃/mmc</i>
(β Y)	\sim 99.5 to 100	<i>cI2</i>	<i>Im$\bar{3}m$</i>
(α Y)	\sim 99.5 to 100	<i>hP2</i>	<i>P6₃/mmc</i>

Ti-Zr (Titanium - Zirconium)

J.L. Murray, 1987

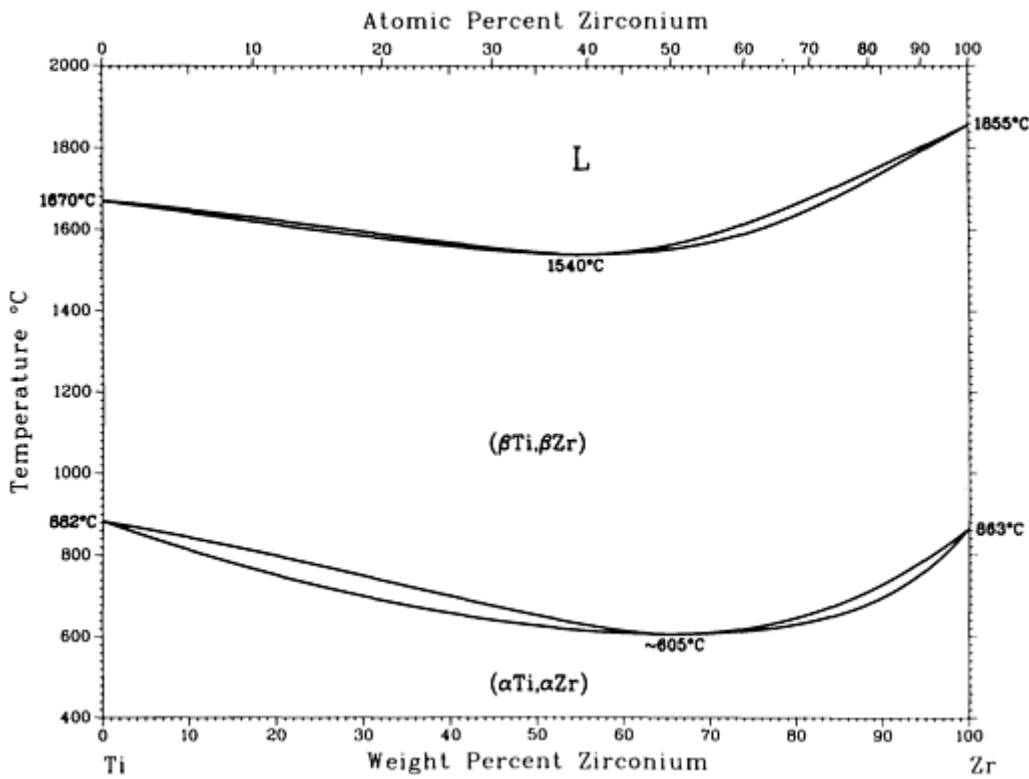

Ti-Zr phase diagram

Ti-Zr crystallographic data

Phase	Composition, wt% Zr	Pearson symbol	Space group
(β Ti, β Zr)	0 to 100	<i>cI2</i>	<i>Im$\bar{3}m$</i>
(α Ti, α Zr)	0 to 100	<i>hP2</i>	<i>P6₃/mmc</i>

Metastable phases			
α'	...	$hP2$	$P6_3/mmc$
ω	...	$hP3$	$P6/mmm$ or $P\bar{3}m1$

Tl (Thallium) Binary Alloy Phase Diagrams

Introduction

THIS ARTICLE includes systems where thallium is the first-named element in the binary pair. Additional binary systems that include thallium are provided in the following locations in this Volume:

- “Ag-Tl (Silver - Thallium)” in the article “Ag (Silver) Binary Alloy Phase Diagrams.”
- “As-Tl (Arsenic - Thallium)” in the article “As (Arsenic) Binary Alloy Phase Diagrams.”
- “Au-Tl (Gold - Thallium)” in the article “Au (Gold) Binary Alloy Phase Diagrams.”
- “Ba-Tl (Barium - Thallium)” in the article “Ba (Barium) Binary Alloy Phase Diagrams.”
- “Bi-Tl (Bismuth - Thallium)” in the article “Bi (Bismuth) Binary Alloy Phase Diagrams.”
- “Ca-Tl (Calcium - Thallium)” in the article “Ca (Calcium) Binary Alloy Phase Diagrams.”
- “Cd-Tl (Cadmium - Thallium)” in the article “Cd (Cadmium) Binary Alloy Phase Diagrams.”
- “Ce-Tl (Cerium - Thallium)” in the article “Ce (Cerium) Binary Alloy Phase Diagrams.”
- “Cs-Tl (Cesium - Thallium)” in the article “Cs (Cesium) Binary Alloy Phase Diagrams.”
- “Cu-Tl (Copper - Thallium)” in the article “Cu (Copper) Binary Alloy Phase Diagrams.”
- “Dy-Tl (Dysprosium - Thallium)” in the article “Dy (Dysprosium) Binary Alloy Phase Diagrams.”
- “Er-Tl (Erbium - Thallium)” in the article “Er (Erbium) Binary Alloy Phase Diagrams.”
- “Ga-Tl (Gallium - Thallium)” in the article “Ga (Gallium) Binary Alloy Phase Diagrams.”
- “Gd-Tl (Gadolinium - Thallium)” in the article “Gd (Gadolinium) Binary Alloy Phase Diagrams.”
- “Ge-Tl (Germanium - Thallium)” in the article “Ge (Germanium) Binary Alloy Phase Diagrams.”
- “Hg-Tl (Mercury - Thallium)” in the article “Hg (Mercury) Binary Alloy Phase Diagrams.”
- “Ho-Tl (Holmium - Thallium)” in the article “Ho (Holmium) Binary Alloy Phase Diagrams.”
- “In-Tl (Indium - Thallium)” in the article “In (Indium) Binary Alloy Phase Diagrams.”
- “K-Tl (Potassium - Thallium)” in the article “K (Potassium) Binary Alloy Phase Diagrams.”
- “La-Tl (Lanthanum - Thallium)” in the article “La (Lanthanum) Binary Alloy Phase Diagrams.”
- “Li-Tl (Lithium - Thallium)” in the article “Li (Lithium) Binary Alloy Phase Diagrams.”
- “Lu-Tl (Lutetium - Thallium)” in the article “Lu (Lutetium) Binary Alloy Phase Diagrams.”
- “Mg-Tl (Magnesium - Thallium)” in the article “Mg (Magnesium) Binary Alloy Phase Diagrams.”
- “Na-Tl (Sodium - Thallium)” in the article “Na (Sodium) Binary Alloy Phase Diagrams.”
- “Nd-Tl (Neodymium - Thallium)” in the article “Nd (Neodymium) Binary Alloy Phase Diagrams.”
- “Pb-Tl (Lead - Thallium)” in the article “Pb (Lead) Binary Alloy Phase Diagrams.”
- “Pd-Tl (Palladium - Thallium)” in the article “Pd (Palladium) Binary Alloy Phase Diagrams.”
- “Pr-Tl (Praseodymium - Thallium)” in the article “Pr (Praseodymium) Binary Alloy Phase Diagrams.”
- “Pt-Tl (Platinum - Thallium)” in the article “Pt (Platinum) Binary Alloy Phase Diagrams.”
- “Rb-Tl (Rubidium - Thallium)” in the article “Rb (Rubidium) Binary Alloy Phase Diagrams.”
- “Sb-Tl (Antimony - Thallium)” in the article “Sb (Antimony) Binary Alloy Phase Diagrams.”
- “Se-Tl (Selenium - Thallium)” in the article “Se (Selenium) Binary Alloy Phase Diagrams.”
- “Sm-Tl (Samarium - Thallium)” in the article “Sm (Samarium) Binary Alloy Phase Diagrams.”
- “Sn-Tl (Tin - Thallium)” in the article “Sn (Tin) Binary Alloy Phase Diagrams.”
- “Sr-Tl (Strontium - Thallium)” in the article “Sr (Strontium) Binary Alloy Phase Diagrams.”
- “Tb-Tl (Terbium - Thallium)” in the article “Tb (Terbium) Binary Alloy Phase Diagrams.”
- “Te-Tl (Tellurium - Thallium)” in the article “Te (Tellurium) Binary Alloy Phase Diagrams.”
- “Th-Tl (Thorium - Thallium)” in the article “Th (Thorium) Binary Alloy Phase Diagrams.”

Tl-Yb (Thallium - Ytterbium)

S. Delfino, A. Saccone, A. Palenzona, and R. Ferro, unpublished

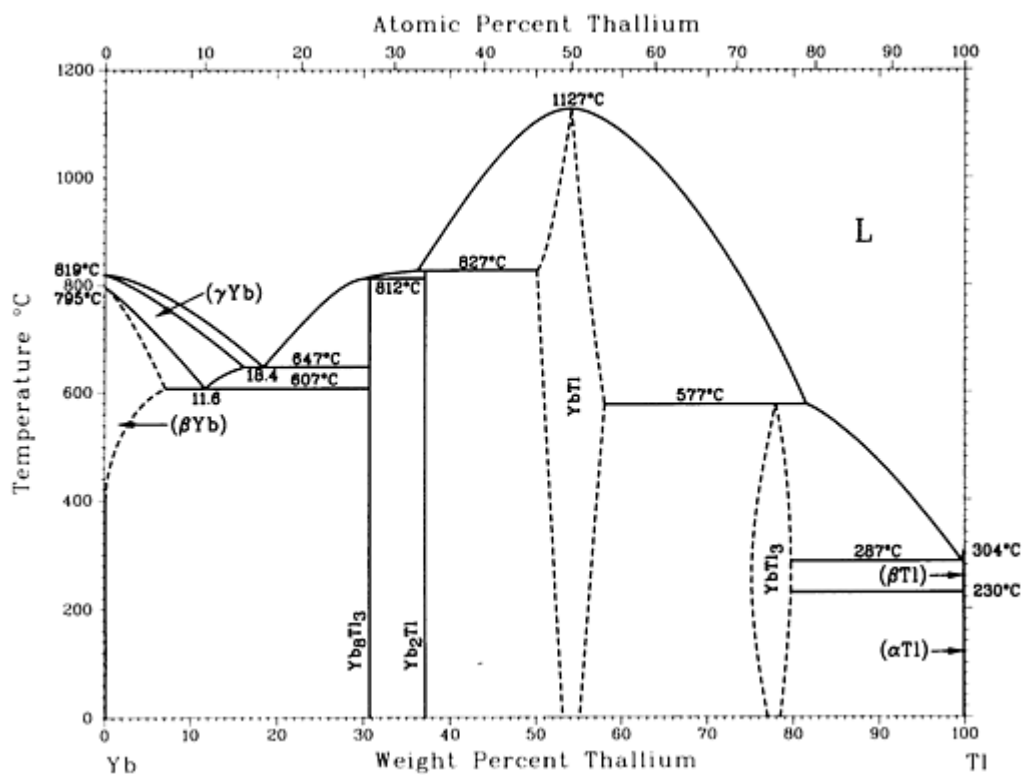

Tl-Yb phase diagram

Tl-Yb crystallographic data

Phase	Composition, wt% Tl	Pearson symbol	Space group
(β Yb)	0 to ~7	<i>cF2</i>	<i>Fm</i> $\bar{3}m$
(γ Yb)	0 to ~16	<i>cI2</i>	<i>Im</i> $\bar{3}m$
Yb ₈ Tl ₃	30.69	<i>aP22</i>	<i>P</i> $\bar{1}$
Yb ₂ Tl	37.13	<i>oP12</i>	<i>Pnma</i>
YbTl	~50 to ~58	<i>cP2</i> (or <i>cI2</i>)	<i>Pm</i> $\bar{3}m$ <i>Im</i> $\bar{3}m$
YbTl ₃	~75 to ~80	<i>cP4</i>	<i>Pm</i> $\bar{3}m$

(βTl)	100	<i>cI2</i>	$Im\bar{3}m$
(αTl)	100	<i>hP2</i>	$P6_3/mmc$

Tl-Zn (Thallium - Zinc)

A.V. Vegesack, 1907; and W. Seith, H. Johnson, and J. Wagner, 1952

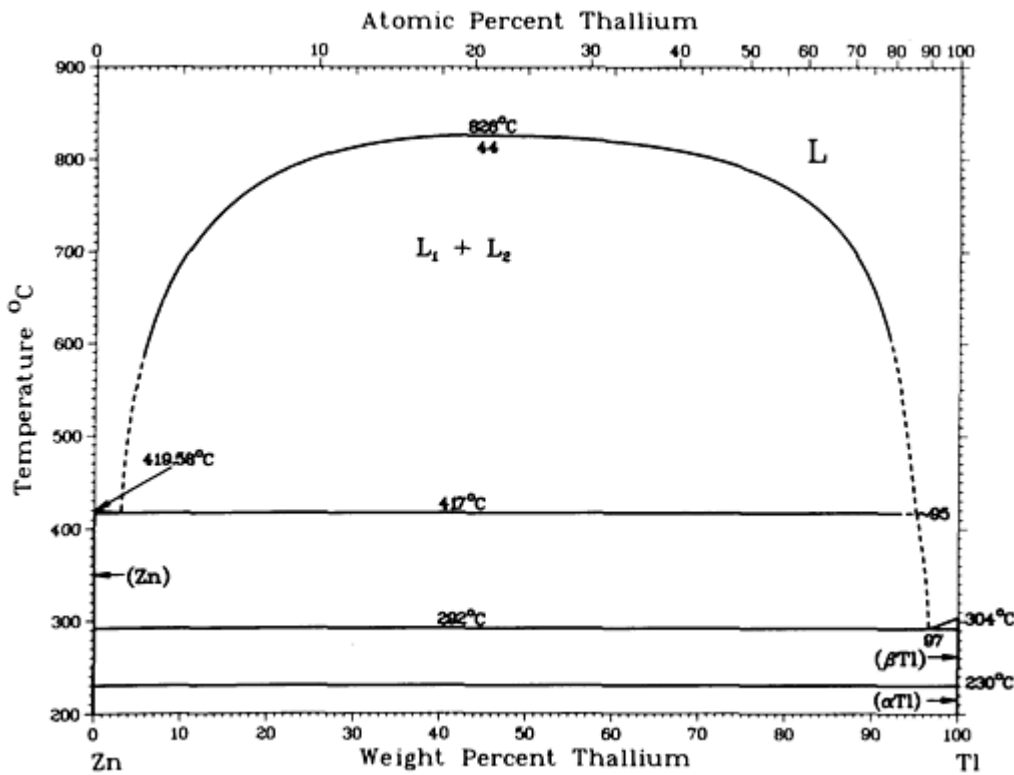

Tl-Zn phase diagram

Tl-Zn crystallographic data

Phase	Composition, wt% Tl	Pearson symbol	Space group
(Zn)	0	<i>hP2</i>	$P6_3/mmc$
(βTl)	100	<i>cI2</i>	$Im\bar{3}m$
(αTl)	100	<i>hP2</i>	$P6_3/mmc$

U-Zr (Uranium - Zirconium)

H. Okamoto, 1992

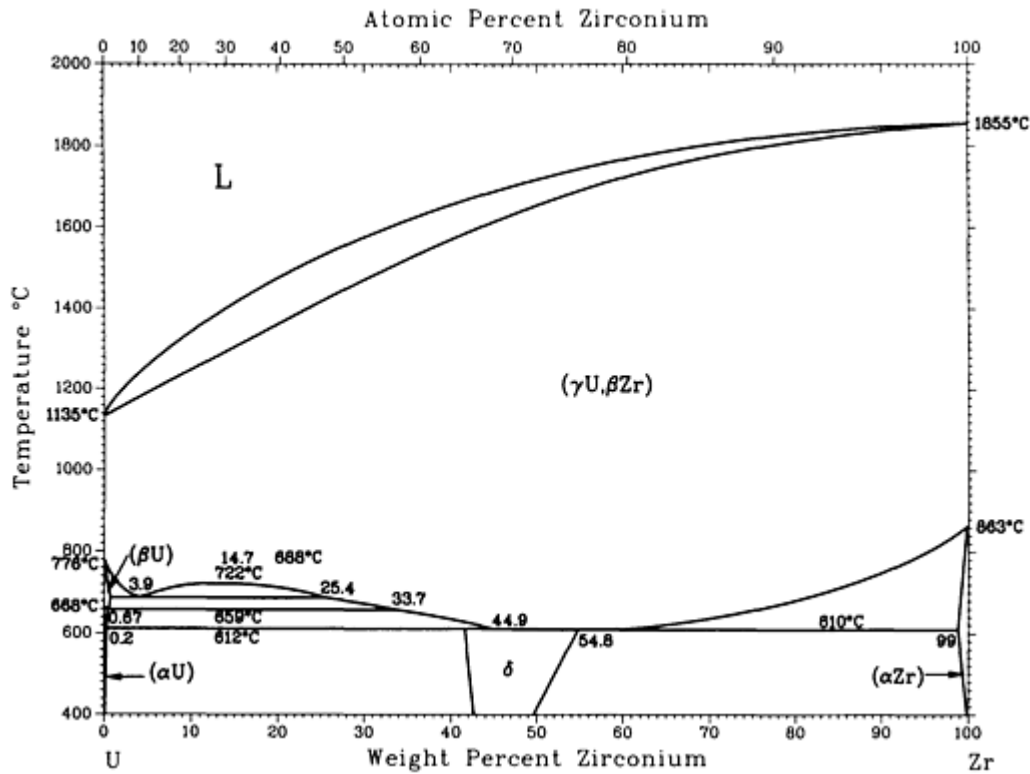

U-Zr phase diagram

U-Zr crystallographic data

Phase	Composition, wt% Zr	Pearson symbol	Space group
($\gamma_{\text{U}}, \beta_{\text{Zr}}$)	0 to 100	<i>cI2</i>	<i>Im</i> $\bar{3}m$
(BU)	0 to 0.4	<i>tP30</i>	<i>P4</i> ₂ / <i>mmm</i>
(α_{U})	0 to 0.2	<i>oC4</i>	<i>Cmcm</i>
δ	42 to 55	<i>hP3</i>	<i>P6</i> / <i>mmm</i>
(α_{Zr})	99 to 100	<i>hP2</i>	<i>P6</i> ₃ / <i>mmc</i>

Introduction

THIS ARTICLE includes systems where vanadium is the first-named element in the binary pair. Additional binary systems that include vanadium are provided in the following locations in this Volume:

- “Al-V (Aluminum - Vanadium)” in the article “Al (Aluminum) Binary Phase Diagrams.”
- “Au-V (Gold - Vanadium)” in the article “Au (Gold) Binary Phase Diagrams.”
- “B-V (Boron - Vanadium)” in the article “B (Boron) Binary Phase Diagrams.”
- “C-V (Carbon - Vanadium)” in the article “C (Carbon) Binary Phase Diagrams.”
- “Co-V (Cobalt - Vanadium)” in the article “Co (Cobalt) Binary Phase Diagrams.”
- “Cr-V (Chromium - Vanadium)” in the article “Cr (Chromium) Binary Phase Diagrams.”
- “Cu-V (Copper - Vanadium)” in the article “Cu (Copper) Binary Phase Diagrams.”
- “Fe-V (Iron - Vanadium)” in the article “Fe (Iron) Binary Phase Diagrams.”
- “Ga-V (Gallium - Vanadium)” in the article “Ga (Gallium) Binary Phase Diagrams.”
- “H-V (Hydrogen - Vanadium)” in the article “H (Hydrogen) Binary Phase Diagrams.”
- “Hf-V (Hafnium - Vanadium)” in the article “Hf (Hafnium) Binary Phase Diagrams.”
- “In-V (Indium - Vanadium)” in the article “In (Indium) Binary Phase Diagrams.”
- “Ir-V (Iridium - Vanadium)” in the article “Ir (Iridium) Binary Phase Diagrams.”
- “Mn-V (Manganese - Vanadium)” in the article “Mn (Manganese) Binary Phase Diagrams.”
- “Mo-V (Molybdenum - Vanadium)” in the article “Mo (Molybdenum) Binary Phase Diagrams.”
- “Nb-V (Niobium - Vanadium)” in the article “Nb (Niobium) Binary Phase Diagrams.”
- “Ni-V (Nickel - Vanadium)” in the article “Ni (Nickel) Binary Phase Diagrams.”
- “O-V (Oxygen - Vanadium)” in the article “O (Oxygen) Binary Phase Diagrams.”
- “Os-V (Osmium - Vanadium)” in the article “Os (Osmium) Binary Phase Diagrams.”
- “Pd-V (Palladium - Vanadium)” in the article “Pd (Palladium) Binary Phase Diagrams.”
- “Pt-V (Platinum - Vanadium)” in the article “Pt (Platinum) Binary Phase Diagrams.”
- “Re-V (Rhenium - Vanadium)” in the article “Re (Rhenium) Binary Phase Diagrams.”
- “Rh-V (Rhodium - Vanadium)” in the article “Rh (Rhodium) Binary Phase Diagrams.”
- “Ru-V (Ruthenium - Vanadium)” in the article “Ru (Ruthenium) Binary Phase Diagrams.”
- “Si-V (Silicon - Vanadium)” in the article “Si (Silicon) Binary Phase Diagrams.”
- “Ta-V (Tantalum - Vanadium)” in the article “Ta (Tantalum) Binary Phase Diagrams.”
- “Ti-V (Titanium - Vanadium)” in the article “Ti (Titanium) Binary Phase Diagrams.”

V-W (Vanadium - Tungsten)

S.V. Nagender Naidu, A.M. Sriramamurthy, M. Vijayakumar, and P. Rama Rao, 1989

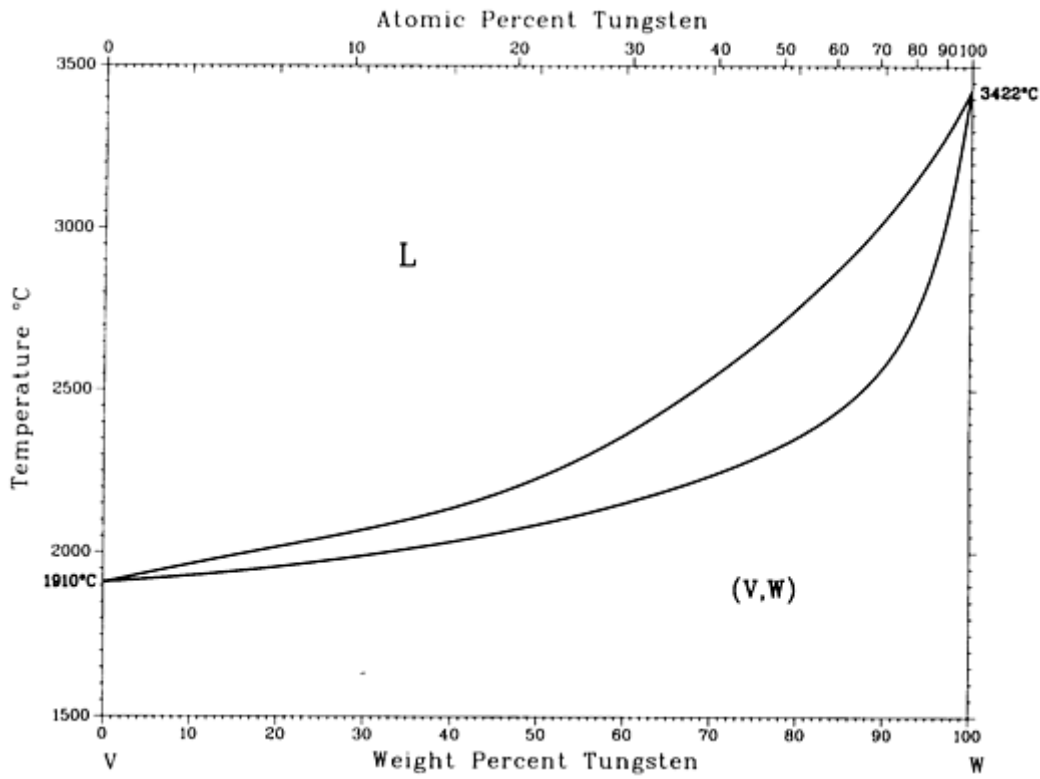

V-W phase diagram

V-W crystallographic data

Phase	Composition, wt% W	Pearson symbol	Space group
(V,W)	0 to 100	<i>cI2</i>	<i>Im</i> $\bar{3}m$

V-Zr (Vanadium - Zirconium)

J.F. Smith, 1989

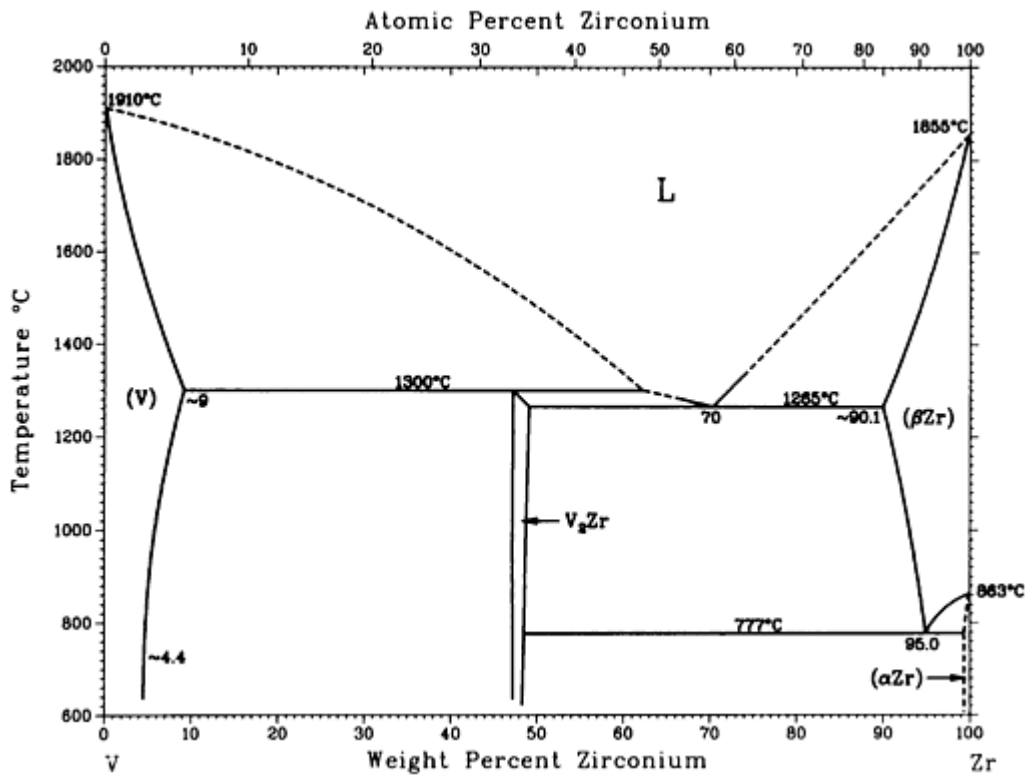

V-Zr phase diagram

V-Zr crystallographic data

Phase	Composition, wt% Zr	Pearson symbol	Space group
(V)	0 to ~9	$cI2$	$Im\bar{3}m$
V_2Zr	~47.2	$cF24$	$Fd\bar{3}m$
(βZr)	~90.1 to 100	$cI2$	$Im\bar{3}m$
(αZr)	~100	$hP2$	$P6_3/mmc$

Introduction

THIS ARTICLE includes systems where tungsten is the first-named element in the binary pair. Additional binary systems that include tungsten are provided in the following locations in this Volume:

- “Al-W (Aluminum - Tungsten)” in the article “Al (Aluminum) Binary Alloy Phase Diagrams.”
- “B-W (Boron - Tungsten)” in the article “B (Boron) Binary Alloy Phase Diagrams.”
- “Be-W (Beryllium - Tungsten)” in the article “Be (Beryllium) Binary Alloy Phase Diagrams.”
- “C-W (Carbon - Tungsten)” in the article “C (Carbon) Binary Alloy Phase Diagrams.”
- “Co-W (Cobalt - Tungsten)” in the article “Co (Cobalt) Binary Alloy Phase Diagrams.”
- “Cr-W (Chromium - Tungsten)” in the article “Cr (Chromium) Binary Alloy Phase Diagrams.”
- “Fe-W (Iron - Tungsten)” in the article “Fe (Iron) Binary Alloy Phase Diagrams.”
- “Hf-W (Hafnium - Tungsten)” in the article “Hf (Hafnium) Binary Alloy Phase Diagrams.”
- “Ir-W (Iridium - Tungsten)” in the article “Ir (Iridium) Binary Alloy Phase Diagrams.”
- “Mo-W (Molybdenum - Tungsten)” in the article “Mo (Molybdenum) Binary Alloy Phase Diagrams.”
- “Nb-W (Niobium - Tungsten)” in the article “Nb (Niobium) Binary Alloy Phase Diagrams.”
- “Ni-W (Nickel - Tungsten)” in the article “Ni (Nickel) Binary Alloy Phase Diagrams.”
- “O-W (Oxygen - Tungsten)” in the article “O (Oxygen) Binary Alloy Phase Diagrams.”
- “Os-W (Osmium - Tungsten)” in the article “Os (Osmium) Binary Alloy Phase Diagrams.”
- “Pd-W (Palladium - Tungsten)” in the article “Pd (Palladium) Binary Alloy Phase Diagrams.”
- “Ta-W (Tantalum - Tungsten)” in the article “Ta (Tantalum) Binary Alloy Phase Diagrams.”
- “Ti-W (Titanium - Tungsten)” in the article “Ti (Titanium) Binary Alloy Phase Diagrams.”
- “V-W (Vanadium - Tungsten)” in the article “V (Vanadium) Binary Alloy Phase Diagrams.”

W-Zr (Tungsten - Zirconium)

S.V. Nagender Naidu and P. Rama Rao, 1991

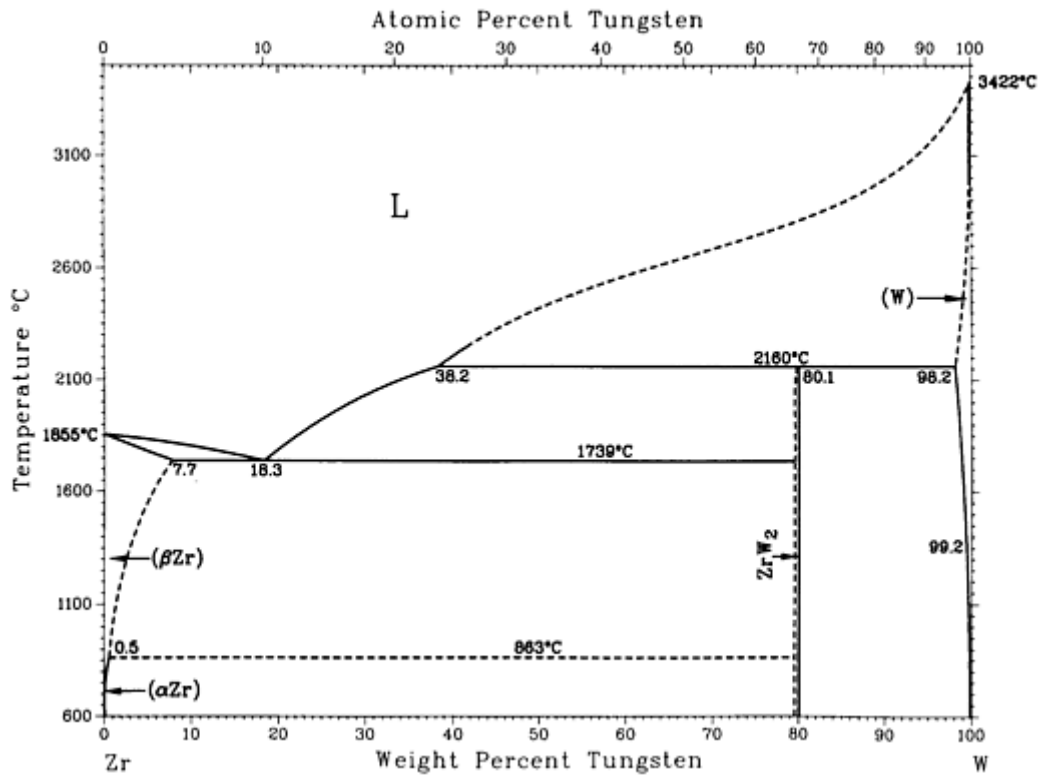

W-Zr phase diagram

W-Zr crystallographic data

Phase	Composition, wt% W	Pearson symbol	Space group
β_{Zr}	0 to 7.7	<i>cI2</i>	$Im\bar{3}m$
α_{Zr}	0 to 0.50	<i>hP2</i>	$P6_3/mmc$
ZrW_2	~80.1	<i>cF24</i>	$Fd\bar{3}m$
(W)	98.2 to 100	<i>cI2</i>	$Im\bar{3}m$

Introduction

THIS ARTICLE includes systems where yttrium is the first-named element in the binary pair. Additional binary systems that include yttrium are provided in the following locations in this Volume:

- “Ag-Y (Silver - Yttrium)” in the article “Ag (Silver) Binary Phase Alloy Diagrams.”
- “Al-Y (Aluminum - Yttrium)” in the article “Al (Aluminum) Binary Phase Alloy Diagrams.”
- “B-Y (Boron - Yttrium)” in the article “B (Boron) Binary Phase Alloy Diagrams.”
- “Bi-Y (Bismuth - Yttrium)” in the article “Bi (Bismuth) Binary Phase Alloy Diagrams.”
- “C-Y (Carbon - Yttrium)” in the article “C (Carbon) Binary Phase Alloy Diagrams.”
- “Cd-Y (Cadmium - Yttrium)” in the article “Cd (Cadmium) Binary Phase Alloy Diagrams.”
- “Co-Y (Cobalt - Yttrium)” in the article “Co (Cobalt) Binary Phase Alloy Diagrams.”
- “Ga-Y (Gallium - Yttrium)” in the article “Ga (Gallium) Binary Phase Alloy Diagrams.”
- “Ge-Y (Germanium - Yttrium)” in the article “Ge (Germanium) Binary Phase Alloy Diagrams.”
- “In-Y (Indium - Yttrium)” in the article “In (Indium) Binary Phase Alloy Diagrams.”
- “Mg-Y (Magnesium - Yttrium)” in the article “Mg (Magnesium) Binary Phase Alloy Diagrams.”
- “Mn-Y (Manganese - Yttrium)” in the article “Mn (Manganese) Binary Phase Alloy Diagrams.”
- “Ni-Y (Nickel - Yttrium)” in the article “Ni (Nickel) Binary Phase Alloy Diagrams.”
- “O-Y (Oxygen - Yttrium)” in the article “O (Oxygen) Binary Phase Alloy Diagrams.”
- “Pb-Y (Lead - Yttrium)” in the article “Pb (Lead) Binary Phase Alloy Diagrams.”
- “Pd-Y (Palladium - Yttrium)” in the article “Pd (Palladium) Binary Phase Alloy Diagrams.”
- “Sb-Y (Antimony - Yttrium)” in the article “Sb (Antimony) Binary Phase Alloy Diagrams.”
- “Sc-Y (Scandium - Yttrium)” in the article “Sc (Scandium) Binary Phase Alloy Diagrams.”
- “Sn-Y (Tin - Yttrium)” in the article “Sn (Tin) Binary Phase Alloy Diagrams.”
- “Ti-Y (Titanium - Yttrium)” in the article “Ti (Titanium) Binary Phase Alloy Diagrams.”

Y-Zn (Yttrium - Zinc)

H. Okamoto, 1990

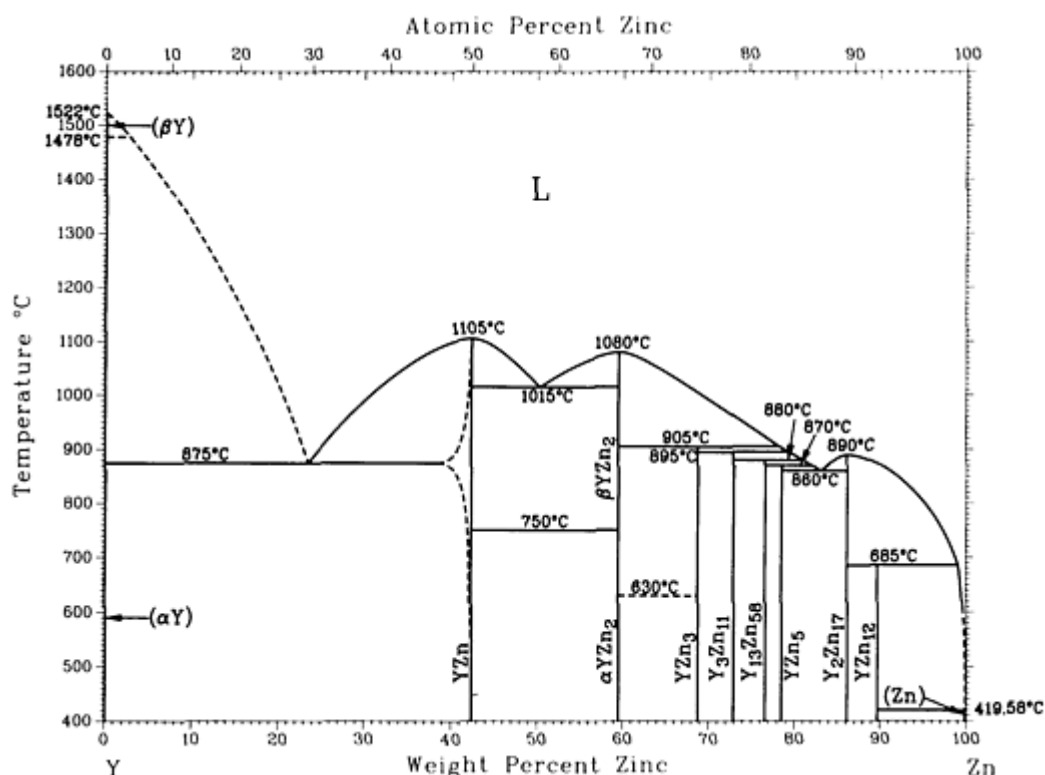

Y-Zn phase diagram

Y-Zn crystallographic data

Phase	Composition, wt% Zn	Pearson symbol	Space group
(β Y)	0	<i>cI2</i>	<i>Im$\bar{3}m$</i>
(α Y)	0	<i>hP2</i>	<i>P6₃/mmc</i>
YZn	? to 42.4	<i>cP2</i>	<i>Pm$\bar{3}m$</i>
β _{YZn₂}	59.6
α _{YZn₂}	59.6	<i>oI12</i>	<i>Imma</i>
YZn ₃	69	<i>oP16</i>	<i>Pnma</i>
Y ₃ Zn ₁₁	73.0	<i>oI28</i>	<i>Immm</i>
Y ₁₃ Zn ₅₈	76.7	<i>hP142</i>	<i>P6₃mc</i>
YZn ₅	76.6	<i>hP36</i>	<i>P6₃/mmc</i>
Y ₂ Zn ₁₇	86.2	<i>hP38</i>	<i>P6₃/mmc</i>
YZn ₁₂	89.8	<i>tI26</i>	<i>I4/mmm</i>
(Zn)	100	<i>hP2</i>	<i>P6₃/mmc</i>

Y-Zr (Yttrium - Zirconium)

A. Palenzona and S. Cirafici, 1991

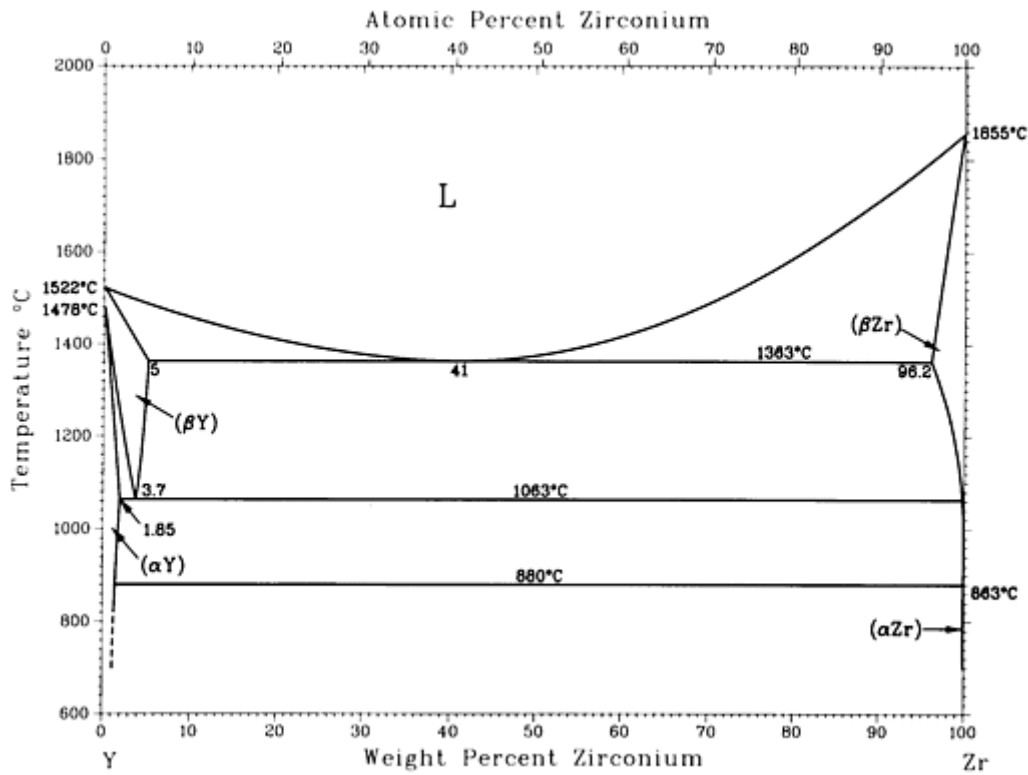

Y-Zr phase diagram

Y-Zr crystallographic data

Phase	Composition, wt% Zr	Pearson symbol	Space group
(β _Y)	0 to 5	<i>cI2</i>	<i>Im</i> $\bar{3}m$
(α _Y)	0 to 1.85	<i>hP2</i>	<i>P6</i> ₃ / <i>mmc</i>
(β _{Zr})	96.2 to 100	<i>cI2</i>	<i>Im</i> $\bar{3}m$
(α _{Zr})	100	<i>hP2</i>	<i>P6</i> ₃ / <i>mmc</i>

Introduction

THIS ARTICLE includes systems where ytterbium is the first-named element in the binary pair. Additional binary systems that include ytterbium are provided in the following locations in this Volume:

- “Ag-Yb (Silver - Ytterbium)” in the article “Ag (Silver) Binary Alloy Phase Diagrams.”
- “Al-Yb (Aluminum - Ytterbium)” in the article “Al (Aluminum) Binary Alloy Phase Diagrams.”
- “As-Yb (Arsenic - Ytterbium)” in the article “As (Arsenic) Binary Alloy Phase Diagrams.”
- “Au-Yb (Gold - Ytterbium)” in the article “Au (Gold) Binary Alloy Phase Diagrams.”
- “Bi-Yb (Bismuth - Ytterbium)” in the article “Bi (Bismuth) Binary Alloy Phase Diagrams.”
- “Ca-Yb (Calcium - Ytterbium)” in the article “Ca (Calcium) Binary Alloy Phase Diagrams.”
- “Cd-Yb (Cadmium - Ytterbium)” in the article “Cd (Cadmium) Binary Alloy Phase Diagrams.”
- “Cu-Yb (Copper - Ytterbium)” in the article “Cu (Copper) Binary Alloy Phase Diagrams.”
- “Ga-Yb (Gallium - Ytterbium)” in the article “Ga (Gallium) Binary Alloy Phase Diagrams.”
- “Ge-Yb (Germanium - Ytterbium)” in the article “Ge (Germanium) Binary Alloy Phase Diagrams.”
- “In-Yb (Indium - Ytterbium)” in the article “In (Indium) Binary Alloy Phase Diagrams.”
- “Mg-Yb (Magnesium - Ytterbium)” in the article “Mg (Magnesium) Binary Alloy Phase Diagrams.”
- “Ni-Yb (Nickel - Ytterbium)” in the article “Ni (Nickel) Binary Alloy Phase Diagrams.”
- “Pb-Yb (Lead - Ytterbium)” in the article “Pb (Lead) Binary Alloy Phase Diagrams.”
- “Pd-Yb (Palladium - Ytterbium)” in the article “Pd (Palladium) Binary Alloy Phase Diagrams.”
- “Sn-Yb (Tin - Ytterbium)” in the article “Sn (Tin) Binary Alloy Phase Diagrams.”
- “Te-Yb (Tellurium - Ytterbium)” in the article “Te (Tellurium) Binary Alloy Phase Diagrams.”
- “Tl-Yb (Thallium - Ytterbium)” in the article “Tl (Thallium) Binary Alloy Phase Diagrams.”

Yb-Zn (Ytterbium - Zinc)

J.T. Mason and P. Chiotti, 1968

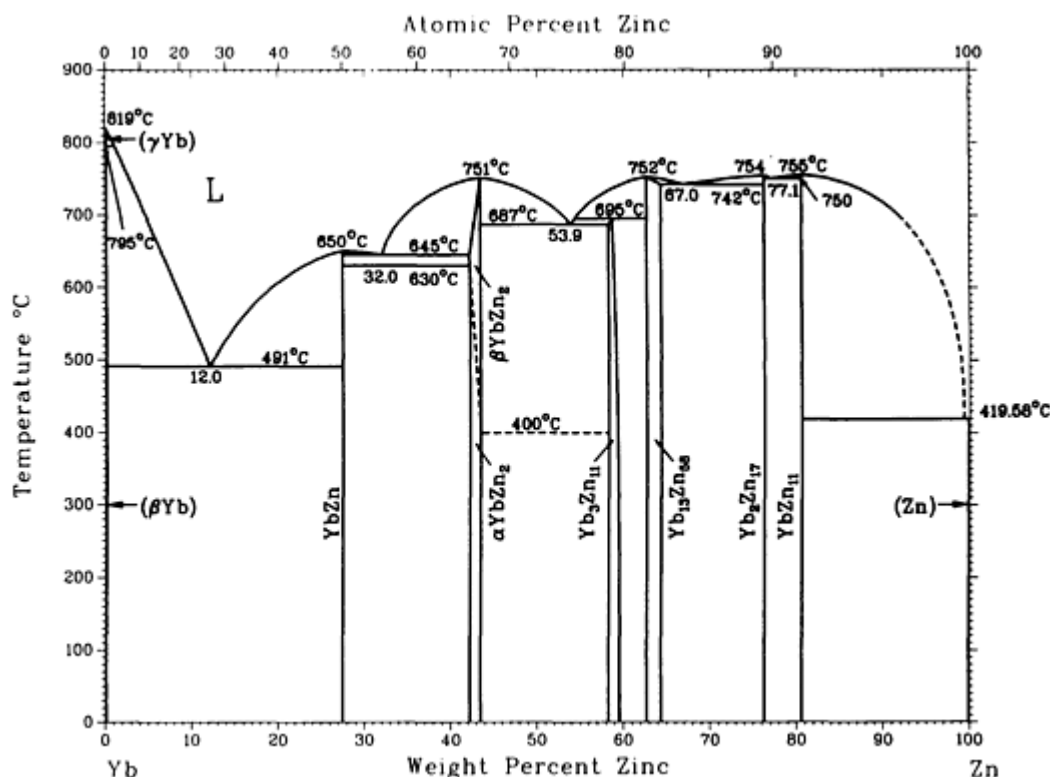

Yb-Zn phase diagram

Yb-Zn crystallographic data

Phase	Composition, wt% Zn	Pearson symbol	Space group
(γ Yb)	0	<i>cI2</i>	<i>Im$\bar{3}m$</i>
(β Yb)	0	<i>cF4</i>	<i>Fm$\bar{3}m$</i>
YbZn	27.4	<i>cP2</i>	<i>Pm$\bar{3}m$</i>
β YbZn ₂	~42 to 43
α YbZn ₂	~42 to 43	<i>oI12</i>	<i>Imma</i>
Yb ₃ Zn ₁₁	~58.0 to 59.4	<i>oI28</i>	<i>Immm</i>
Yb ₁₃ Zn ₅₈	~62.5 to 64.0	<i>hP142</i>	<i>P6₃mc</i>
Yb ₂ Zn ₁₇	76.3
YbZn ₁₁	80.3	<i>tI48</i>	<i>I4₁amd</i>
(Zn)	100	<i>hP2</i>	<i>P6₃/mmc</i>
Other reported phases			
Yb ₃ Zn ₁₇	68	<i>cI160</i>	<i>Im$\bar{3}$</i>
YbZn ₁₃	83.2	<i>cF112</i>	<i>Fm$\bar{3}c$</i>

Zn (Zinc) Binary Alloy Phase Diagrams

Introduction

Binary systems that include zinc are provided in the following locations in this Volume:

- “Ag-Zn (Silver - Zinc)” in the article “Ag (Silver) Binary Alloy Phase Diagrams.”
- “Al-Zn (Aluminum - Zinc)” in the article “Al (Aluminum) Binary Alloy Phase Diagrams.”
- “As-Zn (Arsenic - Zinc)” in the article “As (Arsenic) Binary Alloy Phase Diagrams.”
- “Au-Zn (Gold - Zinc)” in the article “Au (Gold) Binary Alloy Phase Diagrams.”
- “Ba-Zn (Barium - Zinc)” in the article “Ba (Barium) Binary Alloy Phase Diagrams.”
- “Bi-Zn (Bismuth - Zinc)” in the article “Bi (Bismuth) Binary Alloy Phase Diagrams.”
- “Ca-Zn (Calcium - Zinc)” in the article “Ca (Calcium) Binary Alloy Phase Diagrams.”
- “Cd-Zn (Cadmium - Zinc)” in the article “Cd (Cadmium) Binary Alloy Phase Diagrams.”
- “Ce-Zn (Cerium - Zinc)” in the article “Ce (Cerium) Binary Alloy Phase Diagrams.”
- “Co-Zn (Cobalt - Zinc)” in the article “Co (Cobalt) Binary Alloy Phase Diagrams.”
- “Cu-Zn (Copper - Zinc)” in the article “Cu (Copper) Binary Alloy Phase Diagrams.”
- “Fe-Zn (Iron - Zinc)” in the article “Fe (Iron) Binary Alloy Phase Diagrams.”
- “Ga-Zn (Gallium - Zinc)” in the article “Ga (Gallium) Binary Alloy Phase Diagrams.”
- “Ge-Zn (Germanium - Zinc)” in the article “Ge (Germanium) Binary Alloy Phase Diagrams.”
- “Hg-Zn (Mercury - Zinc)” in the article “Hg (Mercury) Binary Alloy Phase Diagrams.”
- “In-Zn (Indium - Zinc)” in the article “In (Indium) Binary Alloy Phase Diagrams.”
- “La-Zn (Lanthanum - Zinc)” in the article “La (Lanthanum) Binary Alloy Phase Diagrams.”
- “Li-Zn (Lithium - Zinc)” in the article “Li (Lithium) Binary Alloy Phase Diagrams.”
- “Mg-Zn (Magnesium - Zinc)” in the article “Mg (Magnesium) Binary Alloy Phase Diagrams.”
- “Mn-Zn (Manganese - Zinc)” in the article “Mn (Manganese) Binary Alloy Phase Diagrams.”
- “Nd-Zn (Neodymium - Zinc)” in the article “Nd (Neodymium) Binary Alloy Phase Diagrams.”
- “Ni-Zn (Nickel - Zinc)” in the article “Ni (Nickel) Binary Alloy Phase Diagrams.”
- “P-Zn (Phosphorus - Zinc)” in the article “P (Phosphorous) Binary Alloy Phase Diagrams.”
- “Pb-Zn (Lead - Zinc)” in the article “Pb (Lead) Binary Alloy Phase Diagrams.”
- “Pd-Zn (Palladium - Zinc)” in the article “Pd (Palladium) Binary Alloy Phase Diagrams.”
- “Pr-Zn (Praseodymium - Zinc)” in the article “Pr (Praseodymium) Binary Alloy Phase Diagrams.”
- “Pu-Zn (Plutonium - Zinc)” in the article “Pu (Plutonium) Binary Alloy Phase Diagrams.”
- “Sb-Zn (Antimony - Zinc)” in the article “Sb (Antimony) Binary Alloy Phase Diagrams.”
- “Si-Zn (Silicon - Zinc)” in the article “Si (Silicon) Binary Alloy Phase Diagrams.”
- “Sm-Zn (Samarium - Zinc)” in the article “Sm (Samarium) Binary Alloy Phase Diagrams.”
- “Sn-Zn (Tin - Zinc)” in the article “Sn (Tin) Binary Alloy Phase Diagrams.”
- “Sr-Zn (Strontium - Zinc)” in the article “Sr (Strontium) Binary Alloy Phase Diagrams.”
- “Te-Zn (Tellurium - Zinc)” in the article “Te (Tellurium) Binary Alloy Phase Diagrams.”
- “Th-Zn (Thorium - Zinc)” in the article “Th (Thorium) Binary Alloy Phase Diagrams.”
- “Tl-Zn (Thallium - Zinc)” in the article “Tl (Thallium) Binary Alloy Phase Diagrams.”
- “Y-Zn (Yttrium - Zinc)” in the article “Y (Yttrium) Binary Alloy Phase Diagrams.”
- “Yb-Zn (Ytterbium - Zinc)” in the article “Yb (Ytterbium) Binary Alloy Phase Diagrams.”

Zr (Zirconium) Binary Alloy Phase Diagrams

Introduction

Binary systems that include zirconium are provided in the following locations in this Volume:

- “Ag-Zr (Silver - Zirconium)” in the article “Ag (Silver) Binary Alloy Phase Diagrams.”
- “Al-Zr (Aluminum - Zirconium)” in the article “Al (Aluminum) Binary Alloy Phase Diagrams.”
- “Au-Zr (Gold - Zirconium)” in the article “Au (Gold) Binary Alloy Phase Diagrams.”
- “B-Zr (Boron - Zirconium)” in the article “B (Boron) Binary Alloy Phase Diagrams.”
- “Be-Zr (Beryllium - Zirconium)” in the article “Be (Beryllium) Binary Alloy Phase Diagrams.”
- “Bi-Zr (Bismuth - Zirconium)” in the article “Bi (Bismuth) Binary Alloy Phase Diagrams.”
- “C-Zr (Carbon - Zirconium)” in the article “C (Carbon) Binary Alloy Phase Diagrams.”
- “Cr-Zr (Chromium - Zirconium)” in the article “Cr (Chromium) Binary Alloy Phase Diagrams.”

- “Cu-Zr (Copper - Zirconium)” in the article “Cu (Copper) Binary Alloy Phase Diagrams.”
- “Dy-Zr (Dysprosium - Zirconium)” in the article “Dy (Dysprosium) Binary Alloy Phase Diagrams.”
- “Fe-Zr (Iron - Zirconium)” in the article “Ga (Gallium) Binary Alloy Phase Diagrams.”
- “Ga-Zr (Gallium - Zirconium)” in the article “Ga (Gallium) Binary Alloy Phase Diagrams.”
- “H-Zr (Hydrogen - Zirconium)” in the article “H (Hydrogen) Binary Alloy Phase Diagrams.”
- “Hf-Zr (Hafnium - Zirconium)” in the article “Hf (Hafnium) Binary Alloy Phase Diagrams.”
- “Ir-Zr (Iridium - Zirconium)” in the article “Ir (Iridium) Binary Alloy Phase Diagrams.”
- “Mg-Zr (Magnesium - Zirconium)” in the article “Mg (Magnesium) Binary Alloy Phase Diagrams.”
- “Mn-Zr (Manganese - Zirconium)” in the article “Mn (Manganese) Binary Alloy Phase Diagrams.”
- “Mo-Zr (Molybdenum - Zirconium)” in the article “Mo (Molybdenum) Binary Alloy Phase Diagrams.”
- “N-Zr (Nitrogen - Zirconium)” in the article “N (Nitrogen) Binary Alloy Phase Diagrams.”
- “Nb-Zr (Niobium - Zirconium)” in the article “Nb (Niobium) Binary Alloy Phase Diagrams.”
- “Ni-Zr (Nickel - Zirconium)” in the article “Ni (Nickel) Binary Alloy Phase Diagrams.”
- “O-Zr (Oxygen - Zirconium)” in the article “O (Oxygen) Binary Alloy Phase Diagrams.”
- “Os-Zr (Osmium - Zirconium)” in the article “Os (Osmium) Binary Alloy Phase Diagrams.”
- “Pt-Zr (Platinum - Zirconium)” in the article “Pt (Platinum) Binary Alloy Phase Diagrams.”
- “Pu-Zr (Plutonium - Zirconium)” in the article “Pu (Plutonium) Binary Alloy Phase Diagrams.”
- “Sc-Zr (Scandium - Zirconium)” in the article “Sc (Scandium) Binary Alloy Phase Diagrams.”
- “Si-Zr (Silicon - Zirconium)” in the article “Si (Silicon) Binary Alloy Phase Diagrams.”
- “Sn-Zr (Tin - Zirconium)” in the article “Sn (Tin) Binary Alloy Phase Diagrams.”
- “Ta-Zr (Tantalum - Zirconium)” in the article “Ta (Tantalum) Binary Alloy Phase Diagrams.”
- “Th-Zr (Thorium - Zirconium)” in the article “Th (Thorium) Binary Alloy Phase Diagrams.”
- “Ti-Zr (Titanium - Zirconium)” in the article “Ti (Titanium) Binary Alloy Phase Diagrams.”
- “U-Zr (Uranium - Zirconium)” in the article “U (Uranium) Binary Alloy Phase Diagrams.”
- “V-Zr (Vanadium - Zirconium)” in the article “V (Vanadium) Binary Alloy Phase Diagrams.”
- “W-Zr (Tungsten - Zirconium)” in the article “W (Tungsten) Binary Alloy Phase Diagrams.”
- “Y-Zr (Yttrium - Zirconium)” in the article “Y (Yttrium) Binary Alloy Phase Diagrams.”

U (Uranium) Binary Alloy Phase Diagrams

Introduction

THIS ARTICLE includes systems where uranium is the first-named element in the binary pair. Additional binary systems that include uranium are provided in the following locations in this Volume:

- “Al-U (Aluminum - Uranium)” in the article “Al (Aluminum) Binary Alloy Phase Diagrams.”
- “Au-U (Gold - Uranium)” in the article “Au (Gold) Binary Alloy Phase Diagrams.”
- “Bi-U (Bismuth - Uranium)” in the article “Bi (Bismuth) Binary Alloy Phase Diagrams.”
- “C-U (Carbon - Uranium)” in the article “C (Carbon) Binary Alloy Phase Diagrams.”
- “Cr-U (Chromium - Uranium)” in the article “Cr (Chromium) Binary Alloy Phase Diagrams.”
- “Fe-U (Iron - Uranium)” in the article “Fe (Iron) Binary Alloy Phase Diagrams.”
- “Ga-U (Gallium - Uranium)” in the article “Ga (Gallium) Binary Alloy Phase Diagrams.”
- “Ge-U (Germanium - Uranium)” in the article “Ge (Germanium) Binary Alloy Phase Diagrams.”
- “H-U (Hydrogen - Uranium)” in the article “H (Hydrogen) Binary Alloy Phase Diagrams.”
- “Hf-U (Hafnium - Uranium)” in the article “Hf (Hafnium) Binary Alloy Phase Diagrams.”
- “Ir-U (Iridium - Uranium)” in the article “Ir (Iridium) Binary Alloy Phase Diagrams.”
- “Mn-U (Manganese - Uranium)” in the article “Mn (Manganese) Binary Alloy Phase Diagrams.”
- “Mo-U (Molybdenum - Uranium)” in the article “Mo (Molybdenum) Binary Alloy Phase Diagrams.”
- “N-U (Nitrogen - Uranium)” in the article “N (Nitrogen) Binary Alloy Phase Diagrams.”
- “Nb-U (Niobium - Uranium)” in the article “Nb (Niobium) Binary Alloy Phase Diagrams.”
- “Ni-U (Nickel - Uranium)” in the article “Ni (Nickel) Binary Alloy Phase Diagrams.”
- “Np-U (Neptunium - Uranium)” in the article “Np (Neptunium) Binary Alloy Phase Diagrams.”
- “Os-U (Osmium - Uranium)” in the article “Os (Osmium) Binary Alloy Phase Diagrams.”
- “Pd-U (Palladium - Uranium)” in the article “Pd (Palladium) Binary Alloy Phase Diagrams.”
- “Pt-U (Platinum - Uranium)” in the article “Pt (Platinum) Binary Alloy Phase Diagrams.”
- “Pu-U (Plutonium - Uranium)” in the article “Pu (Plutonium) Binary Alloy Phase Diagrams.”
- “Re-U (Rhenium - Uranium)” in the article “Re (Rhenium) Binary Alloy Phase Diagrams.”

- “Rh-U (Rhodium - Uranium)” in the article “Rh (Rhodium) Binary Alloy Phase Diagrams.”
- “Ru-U (Ruthenium - Uranium)” in the article “Ru (Ruthenium) Binary Alloy Phase Diagrams.”
- “Sb-U (Antimony - Uranium)” in the article “Sb (Antimony) Binary Alloy Phase Diagrams.”
- “Se-U (Selenium - Uranium)” in the article “Se (Selenium) Binary Alloy Phase Diagrams.”
- Si-U (Silicon - Uranium)”in the article “Si (Silicon) Binary Alloy Phase Diagrams.”
- Sn-U (Tin - Uranium)”in the article “Sn (Tin) Binary Alloy Phase Diagrams.”
- “Ta-U (Tantalum - Uranium)” in the article “Ta (Tantalum) Binary Alloy Phase Diagrams.”
- “Te-U (Tellurium - Uranium)” in the article “Te (Tellurium) Binary Alloy Phase Diagrams.”
- “Ti-U (Titanium - Uranium)” in the article “Ti (Titanium) Binary Alloy Phase Diagrams.”

Introduction

THE 80 TERNARY SYSTEMS covered in this Section were selected for their commercial importance from the thousands of systems scheduled for inclusion in the *Handbook of Ternary Alloy Phase Diagrams*, to be published by ASM in 1994. The 313 diagrams shown here were chosen from the more than 12,000 assembled for that project. Wherever a recent compilation of diagrams assessed under the International Programme covered one of these systems, priority was given to those evaluated diagrams in preference to older, unassessed work. The remaining diagrams, although not yet assessed, were selected as the best available.

When a single source covered a system, a set of compatible diagrams was selected from it. For some systems, however, diagrams from more than one source were needed. Except for occasional conversion of composition scale from atomic to weight percent or change in orientation or labeling, each author's diagram has been redrawn, but shown as originally presented. *Therefore, the diagrams do not, in all instances, agree with one another and with the binary diagrams published in this Volume.* The reference source for each diagram is identified by a code consisting of two numbers (indicating the year of publication) followed by the first three letters of the first author's (or editor's) surname. The complete citation for each source code is listed at the end of this Section.

Because this Handbook is designed to be used primarily by engineers to solve industrial problems, the composition scale is plotted in weight percent. Conversions between weight and atomic composition can be made using the standard atomic weights listed in the Appendix. For the sake of clarity, grid lines are not superimposed on the phase diagrams. However, tick marks are provided along the composition scales as well as the temperature scale, which is shown in degrees Celsius. Celsius temperatures can be easily converted to degrees Fahrenheit using the table in the Appendix. When an arrowhead appears on a temperature trough line in a liquidus projection, it indicates the direction of decreasing temperature in the trough. Dashed lines are used to denote uncertain or speculative boundaries. Dotted lines indicate the limit of the investigated region.

The diagrams presented in this Section are for stable equilibrium conditions, with the exception of metastable conditions for some diagrams involving carbon and iron. These latter ternary diagrams can be identified by the presence of Fe₃C on the Fe-C binary portion of the diagram. In some ternary diagrams involving carbon and iron, the symbol M is used to represent both iron and the other metallic element when the two metals substitute for each other in a carbide phase--for example, M₃C.

References

Ternary System References

1. **11Par:** N. Parravano, "Das Ternäre System Silber-Zinn-Blei," *Z. Metallkd.*, Vol 1, 1911, p 89-108
2. **29Bau:** O. Bauer and M. Hansen, "Der Einfluss von dritten Metallen auf die Konstitution der Messinglegierungen. I. Der Einfluss von Blei," *Z. Metallkd.*, Vol 21, 1929, p 190-196
3. **36Kos:** W. Köster and W. Dullenkopf, "Das Dreistoffsystem Aluminium-Magnesium-Zink. III. Der Teilbereich Mg-Al₃Mg₄-Al₂Mg₃Zn₃-MgZn₂-Mg," *Z. Metallkd.*, Vol 28, 1936, p 363-367
4. **48Kos:** W. Köster, U. Zwicker, and K. Moeller, "Mikroskopische und röntgenographische Untersuchungen zur Kenntnis des Systems Kupfer-Nickel-Aluminium," *Z. Metallkd.*, Vol 39, 1948, p 225-231
5. **48Wil:** F.H. Wilson, "The Copper-Rich Corner of the Copper-Aluminum-Silicon Diagram," *Trans. AIME*, Vol 175, 1948, p 262-273
6. **51Lin:** E. Linder, "Eine Methode zur Erforschung von Vierstoffsystemen Dargestellt am System Blei-Zink-Kadmium-Zinn," *Z. Metallkd.*, Vol 43, 1951, p 377-387
7. **52Das:** D.K. Das, S.P. Rideout, and P.A. Beck, "Intermediate Phases in the Mo-Fe-Co, Mo-Fe-Ni, and Mo-Ni-Co Ternary Systems," *Trans. AIME*, Vol 194, 1952, p 1071-1075
8. **56Zwi:** U. Zwicker, "Die Systeme Titan-Aluminium-Chrom und Titan-Aluminium-Vanadin und die technischen Titanlegierungen mit 5% Cr und 3% Al sowie mit 6% Al und 4% V," *Z. Metallkd.*, Vol 47, 1956, p 535-548
9. **58Bag:** Yu.A. Bagaryatskiy, G.I. Nosova, and T.V. Tagunova, "Study of the Phase Diagrams of the

- Alloys Titanium-Chromium, Titanium-Tungsten, and Titanium-Chromium-Tungsten, Prepared by the Method of Powder Metallurgy, *Russ. J. Inorganic Chem.*; TR: *Zh. Neorg. Khim.*, Vol 3 (No. 3), 1958, p 330-341
10. **58Kor:** I.I. Kornilov and R.S. Polyakov, Phase Diagram of the Ternary System Titanium-Niobium-Molybdenum, *Russ. J. Inorganic Chem.*, Tr. *Zh. Neorg. Khim.*, Vol 3 (No. 4), 1958, p 62-74
 11. **58Liv:** B.G. Livshits and Ya.D. Khorin, "Study of Equilibrium Phase Diagram of the System Co-Cr-Ti," *Russ. J. Inorganic Chem.*; TR: *Zh. Neorg. Khim.*, Vol 3 (No. 3), 1958, p 193-205
 12. **59Cla:** J.W.H. Clare, "The Constitution of Aluminium-Rich Alloys of the Aluminium-Chromium-Manganese System," *Trans. AIME*, Vol 215, 1959, p 429-433
 13. **61Eng:** J.J. English, "Binary and Ternary Phase Diagrams of Niobium, Molybdenum and Tungsten (1961)," Available as NTIS Document AD 257,739
 14. **61Far:** P. Farrar and H. Margolin, "The Titanium Rich Region of the Titanium-Aluminium-Vanadium System," *Trans. AIME*, Vol 221, 1961, p 1214-1221
 15. **62Zak:** E.K. Zakharov and B.G. Livshits, "Phase Composition Diagram of the Cobalt-Chromium-Titanium Ternary System," *Russ. Metall. Fuels*, (No. 5), 1962, p 88-97
 16. **63Sta:** H.H. Stadelmaier and R.A. Gregg, "Die Ternäre Phase $Fe_{23}C_3B_3$ im Dreistoffsystem Eisen-Kohlenstoff-Bor," *Metall. Berlin*, Vol 17, 1963, p 412-414
 17. **64Kus:** J.B. Kusma and H. Nowotny, "Untersuchungen im Dreistoff: Mn-Al-Si," *Monatsh. Chem.*, Vol 95, 1964, p 1266-1271
 18. **64Ste:** P. Stecher, F. Benesovsky, and H. Nowotny, "Untersuchungen im System Chrom-Wolfram-Kohlenstoff," Vol. 12, 1964, p 89-95
 19. **65Kuz:** Yu.B. Kuz'ma and T.F. Fedorov, "Phase Equilibria in the System Molybdenum-Chromium-Carbon," *Sov. Powder Metall. Met. Ceram.*; TR: *Poroshk. Metall. Kiev*, Vol 4, 1965, p 920-922
 20. **66Kie:** R. Kieffer and H. Rassaerts, "Über das System Vanadium-Chrom-Kohlenstoff und über den Einsatz von Vanadin- und Chromcarbiden in Hartmetallen, Teil I," *Metall, Berlin*, Vol 20, 1966, p 691-695
 21. **66Kos:** W. Köster and T. Gödecke, "Das Dreistoffsystem Kupfer-Mangan-Aluminium," *Z. Metallkd.*, Vol 57, 1966, p 889-901
 22. **67Pta:** W. Ptak and Z. Moser, "The Range of Occurrence of Two Liquid Phases in Zn-Sn-Cd-Pb Alloys," *Bull. Acad. Pol. Sci. Ser. Sci. Tech.*, Vol 15 (No. 9), 1967, p 809-815
 23. **70Han:** R.C. Hansen and A. Raman, "Alloy Chemistry of sigma (beta-U)-Related Phases. III. sigma-Phases with Non-Transition Elements," *Z. Metallkd.*, Vol 61, 1970, p 115-120
 24. **70Kos:** W. Köster and T. Gödecke, "Das Dreistoffsystem Eisen-Aluminium-Zink," *Z. Metallkd.*, Vol 61, 1970, p 649-658
 25. **71Pre:** A.P. Prevarskiy, "Investigation of Fe-Cu-Al Alloys," *Russ. Metall.*; TR: *Izv. Akad. Nauk SSSR, Metall.*, (No. 4), 1971, p 154-156
 26. **73Ben:** R. Benz, J.F. Elliott, and J. Chipman, "Thermodynamics of the Solid Phases in the System Fe-Mn-C," *Metall. Trans.*, Vol 4, 1973, p 1975-1986
 27. **73Bla:** J.M. Blalock, Jr., J.V. Harding, and W.T. Pell-Walpole, *Metallography, Structures and Phase Diagrams*, Vol 8, *Metals Handbook*, 8th ed., American Society for Metals, Metals Park, OH, 1973
 28. **73Bre:** L. Brewer and S.-G. Chang, *Metallography, Structures and Phase Diagrams*, Vol 8, *Metals Handbook*, 8th ed., American Society for Metals, Metals Park, OH, 1973
 29. **73Dra:** J.M. Drapier and D. Coutouradis, *Metallography, Structures and Phase Diagrams*, Vol 8, *Metals Handbook*, 8th ed., American Society for Metals, Metals Park, OH 1973
 30. **73Lev:** E.D. Levine, *Metallography, Structures and Phase Diagrams*, Vol 8, *Metals Handbook*, 8th ed., American Society for Metals, Metals Park, OH 1973
 31. **73Mar:** V.Ya. Markiv, V.V. Burnashova, and V.R. Ryabov, "The Systems Titanium-Iron-Aluminium, Titanium-Nickel-Aluminium, and Titanium-Copper-Aluminium," *Met. Allofizika, Kiev (Akad. Nauk Ukr. SSSR, Metallofiz.)*, Vol 46, 1973, p 103-109
 32. **73Pel:** W.T. Pell-Walpole and C.T. Thwaites, *Metallography, Structures and Phase Diagrams*, Vol 8, *Metals Handbook*, 8th ed., American Society for Metals, Metals Park, OH 1973

33. **73Smi:** C.S. Smith and E.D. Levine, *Metallography, Structures and Phase Diagrams*, Vol 8, *Metals Handbook*, 8th ed., American Society for Metals, Metals Park, OH 1973
34. **73Wil:** L.A. Willey, *Metallography, Structures and Phase Diagrams*, Vol 8, *Metals Handbook*, 8th ed., American Society for Metals, Metals Park, OH 1973
35. **74Kau:** L. Kaufman and H. Nesor, "Calculation of Superalloy Phase Diagrams: Part I," *Metall. Trans.*, Vol 5, 1974, p 1617-1621
36. **75Kau:** L. Kaufman and H. Nesor, "Calculation of Superalloy Phase Diagrams: Part IV," *Metall. Trans. A*, Vol 6, 1975, p 2123-2131
37. **77Lev:** V.I. Levanov, V.S. Mikheyev, and A.I. Chernitysn, "Investigation of the Ti-Nb-W System (Nb + W up to 50 wt.%)," *Russ. Metall.*; TR: *Izv. Akad. Nauk SSSR, Met.*, (No. 1), 1977, p 186-191
38. **79Cha:** Y.A. Chang, J.P. Neumann, A. Mikula, and D. Goldberg, *Phase Diagrams and Thermodynamic Properties of Ternary Copper-Metal Systems*, INCRA Monograph VI, International Copper Research Association, 1979
39. **80Gry:** V.I. Gryzunov and A.S. Sagyndykov, "Mutual Diffusion in the System Ti-Ni-Co," *Phys. Met. Metallogr.*, Tr: *Fiz. Met. Metalloved.*, Vol 49 (No. 5), 1980, p 178-182
40. **80Loo:** F.J.J. van Loo, G.F. Bastin, J.W.G.A. Vrolijk, and J.J.M. Hendriks, "Phase Relations in the Systems Fe-Ni-Mo, Fe-Co-Mo and Ni-Co-Mo at 1100 °C," *J. Less-Common Met.*, Vol 72, 1980, p 225-230
41. **80Mas:** S.B. Maslenkov and E.A. Nikandrova, "Examination of the Ni-Mo-W Phase Diagram," *Russ. Metall.*, Tr: *Izv. Akad. Nauk SSSR, Met.*, (No. 2), 1980, p 184-187
42. **81Zha:** Jin Zhanpeng, "A Study of the Range of Stability of sigma Phase in Some Ternary Systems," *Scand. J. Metall.*, Vol 10, 1981, p 279-287
43. **83Gry:** V.I. Gryzunov, G.V. Shcherbedinskiy, Ye.M. Sokolovskaya, B.K. Aytbayev, and A.S. Sagyndykov, "Kinetics of Phase Growth During Mutual Diffusion in Ternary Multiphase Metallic Systems," *Phys. Met. Metallogr.*; TR: *Fiz. Met. Metalloved.*, Vol 56 (No. 1), 1983, p 183-186
44. **84Ere:** V.N. Eremenko, L.A. Tret'yachenko, S.B. Prima, and E.L. Semenova, "Constitution Diagrams of Titanium-Nickel-Groups IV-VIII Transition Metal Systems," *Sov. Powder Metall. Met. Ceram.*; TR: *Poroshk. Metall. Kiev*, Vol 23 (No. 8), 1984, p 613-621
45. **84Gup:** K.P. Gupta, S.B. Rajendraprasad, A.K. Jena, and R.C. Sharma, "The Co-Mo-Ni System," *Trans. Indian Inst. Met.*, Vol 37 (No. 6), 1984, p 691-697
46. **84Mir:** D.B. Miracle, K.A. Lark, V. Srinivasan, and H.A. Lipsitt, "Nickel-Aluminium-Molybdenum Phase Equilibria," *Metall. Trans. A*, Vol 15, 1984, p 481-486
47. **85Mes:** L.L. Meshkov, S.N. Nesterenko, and T.V. Ishchenko, "Structural Features of Phase Diagrams Formed by Molybdenum and Tungsten with Iron-Group Metals," *Russ. Metall.*; TR: *Izv. Akad. Nauk SSSR, Met.*, (No. 2), 1985, p 204-207
48. **85Nas:** P. Nash and W.W. Liang, "Phase Equilibria in the Ni-Al-Ti System at 1173 K," *Metall. Trans. A*, Vol 16, 1985, p 319-322
49. **85Oma:** A.K. Omarov, S.V. Sejtzhanov, and A.I. Idirisov, "Isothermal Sections of the Ternary System Al-Ni-Ti for the Temperature Range 1150-600 °C," *Izv. Akad. Nauk Kazakh. SSSR, Khim.*, (No. 1), 1985, p 36-42
50. **85Osa:** K. Osamura, "The Pb-Sb-Sn (Lead-Antimony-Tin) System," *Bull. Alloy Phase Diagrams*, Vol 6 (No. 4), 1985, p 372-379
51. **86Ere:** V.N. Eremenko, T.Ja. Velikanova, and A.A. Bondar, "The Ternary Phase Diagram Cr-W-C System," *Dop. Akad. Nauk Ukr. RSR, A, Fiz.- Mat. Tekh.*, Vol 48 (No. 11), 1986, p 74-78
52. **86Mey:** S.a. Mey and K. Hack, "A Thermochemical Evaluation of the Silicon-Zinc, Aluminum-Silicon, and Aluminum-Silicon-Zinc Systems," *Z. Metallkd.*, Vol 77 (No. 7), 1986, p 454-459
53. **86Pri:** S.B. Prima, L.A. Tret'yachenko, and V.N. Eremenko, "Investigation of Phase Equilibria in the Ti-Ni-Mo System at 1200 °C," *Russ. Metall.*; TR: *Izv. Akad. Nauk SSSR, Met.*, (No. 2), 1986, p 205-210
54. **86Rag:** V. Raghavan, "The Carbon-Iron-Silicon System," *J. Alloy Phase Diagrams, India*, Vol 2 (No. 2), 1986, p 97-107
55. **87Ere:** V.N. Eremenko, T.Ya. Velikanova, and A.A. Bondar, "The Phase Diagram of the Cr-Mo-C System, II. Phase Equilibria in the Partial System Mo₂C-Cr₇C₃-C," *Sov. Powder Metall. Met. Ceram.*,

TR: *Poroshk. Metall. Kiev*, Vol 26 (No. 6), 1987, p 506-511

56. **87Ofo:** N.C. Oforika and C.W. Haworth, "Phase Equilibria of Aluminum-Chromium-Nickel System at 1423 K," *Scand. J. Metall.*, Vol 16, 1987, p 184-188
57. **87Rag:** V. Raghavan, *Phase Diagrams of Ternary Iron Alloys*, The Indian Institute of Metals, Calcutta, India, (No. 1), 1987
58. **87Smi:** S.V. Smirnova, L.L. Meshkov, and O.N. Kosolapova, "Physicochemical Interaction and Magnetic Properties on the Phases in the Iron-Molybdenum-Niobium System," *Moscow Univ. Chem. Bull.*, Tr: *Vest. Mosk. Univ. Khim.*, Vol 42 (No. 1), 1987, p 84-87
59. **88Pet:** G. Petzow and G. Effenberg, *Ternary Alloys*, VCH Verlagsgesellschaft, Weinheim, Germany, Vol 1, 1988
60. **88Ray:** G.V. Raynor and V.G. Rivlin, *Phase Equilibria in Iron Ternary Alloys*, The Institute of Metals, London, (No. 4), 1988
61. **88Rok:** L.L. Rokhlin and A.G. Pepelyan, "Phase Equilibria in the Mg-Rich Region of the Mg-Al-Si System," *Russ. Metall.*, Tr: *Izv. Akad. Nauk SSSR, Met.*, (No. 6), 1988, p 172-174
62. **88Sim:** C.J. Simensen, B.C. Oberländer, J. Svalestuen, and A. Thornvaldsen, "The Phase Diagram for Magnesium-Aluminum-Manganese Above 650 °C," *Z. Metallkd.*, Vol 79 (No. 11), 1988, p 696-699
63. **89Har:** K.C. Harikumar and V. Raghavan, "BCC-FCC Equilibrium in Ternary Iron Alloys II," *J. Alloy Phase Diagrams*, India, Vol 5 (No. 2), 1989, p 77-96
64. **90Gup:** K.P. Gupta, *Phase Diagrams of Ternary Nickel Alloys*, Indian Institute of Metals, Calcutta, (No. 1), 1990
65. **90Pri:** A. Prince, G.V. Raynor, and D.S. Evans, *Phase Diagrams of Ternary Gold Alloys*, The Institute of Metals, London, 1990

Ag-Au-Cu (Silver - Gold - Copper) Ternary Phase Diagrams

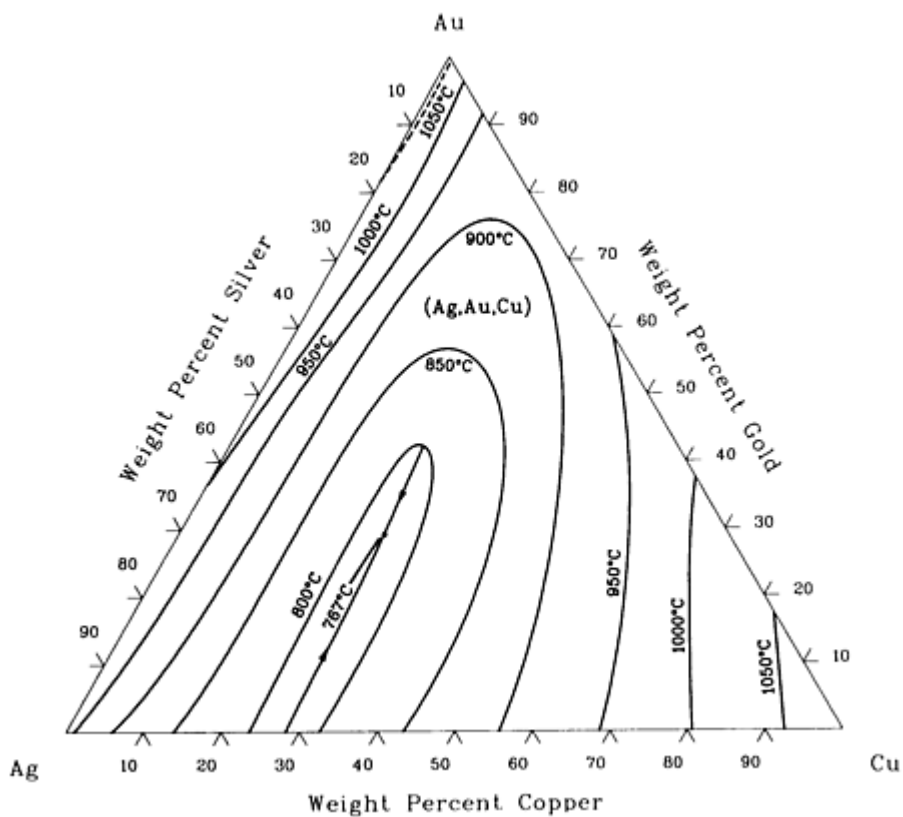

Ag-Au-Cu liquidus projection [90Pri 65].

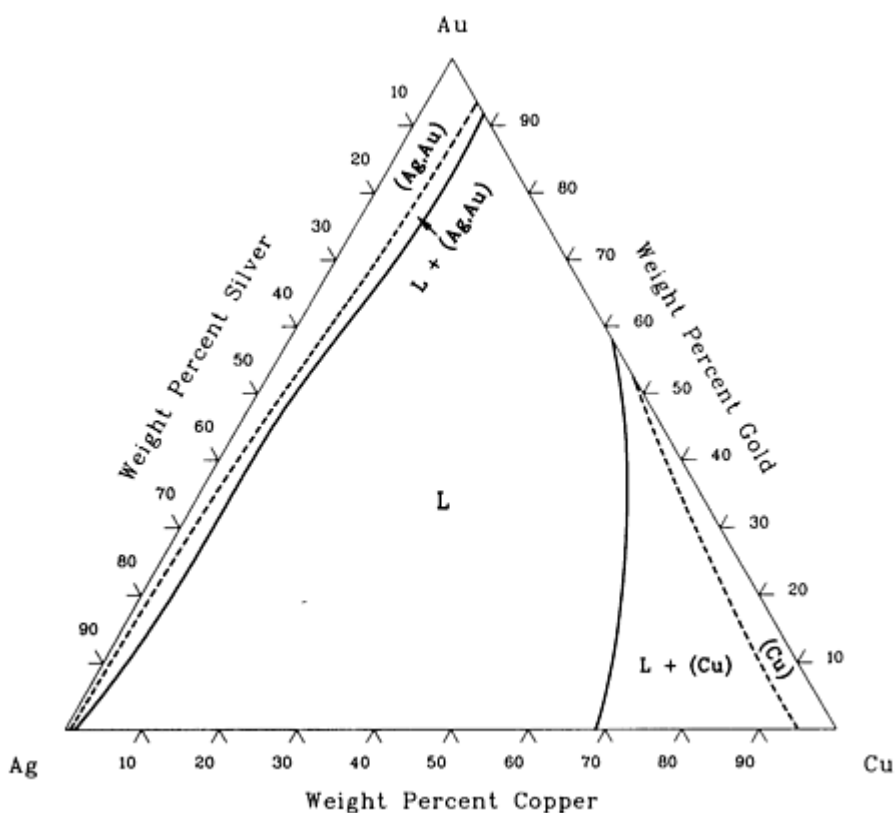

Ag-Au-Cu isothermal section at 950 °C [90Pri 65].

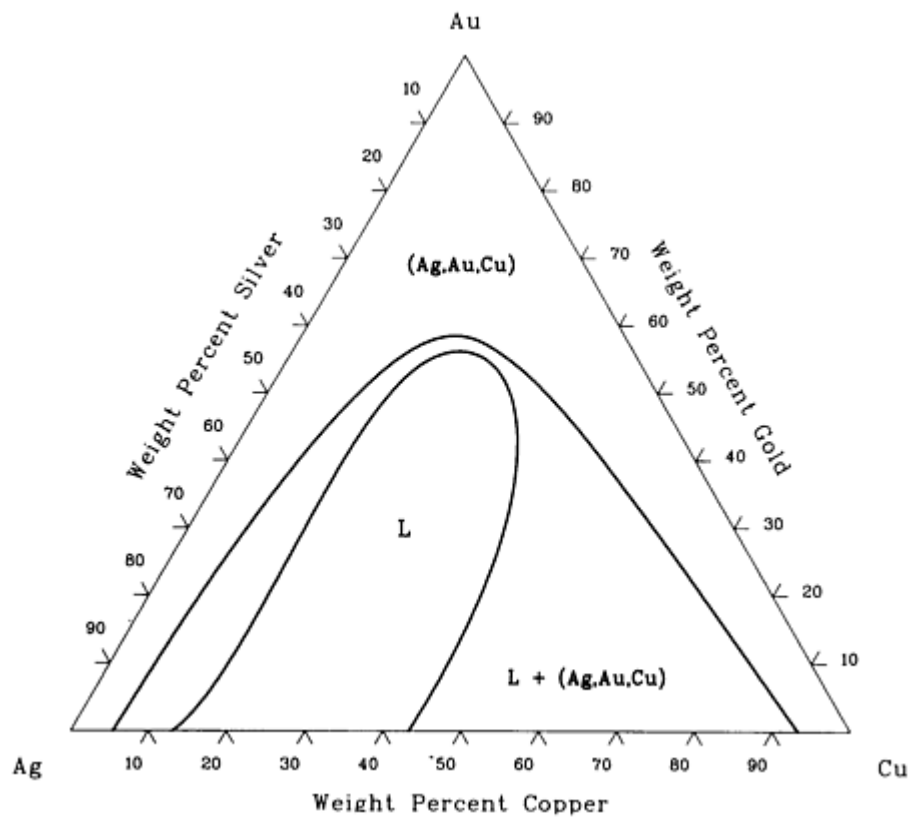

Ag-Au-Cu isothermal section at 850 °C [90Pri 65].

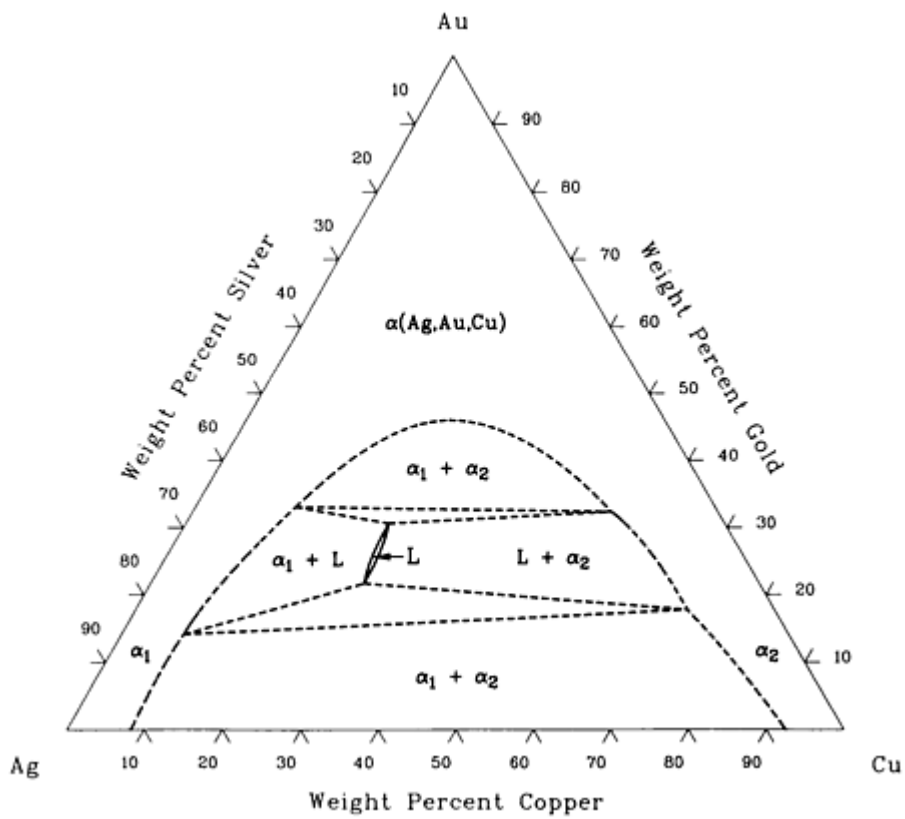

Ag-Au-Cu isothermal section at 775 °C [90Pri 65].

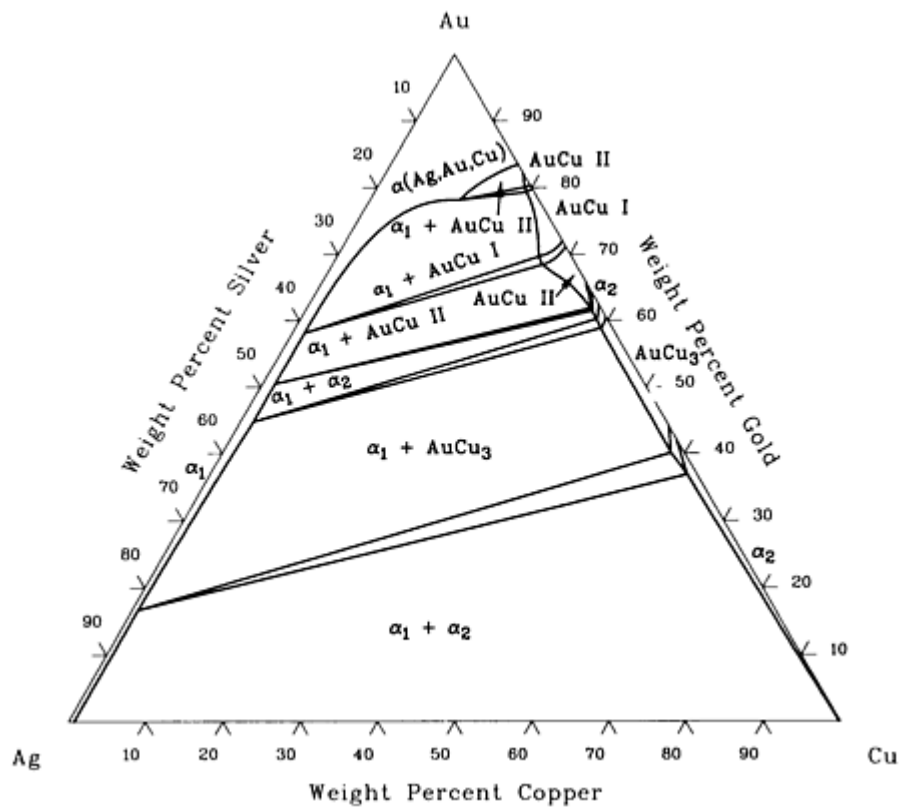

Ag-Au-Cu isothermal section at 300 °C [90Pri 65].

Reference cited in this section

90Pri: A. Prince, G.V. Raynor, and D.S. Evans, *Phase Diagrams of Ternary Gold Alloys*, The Institute of Metals, London, 1990

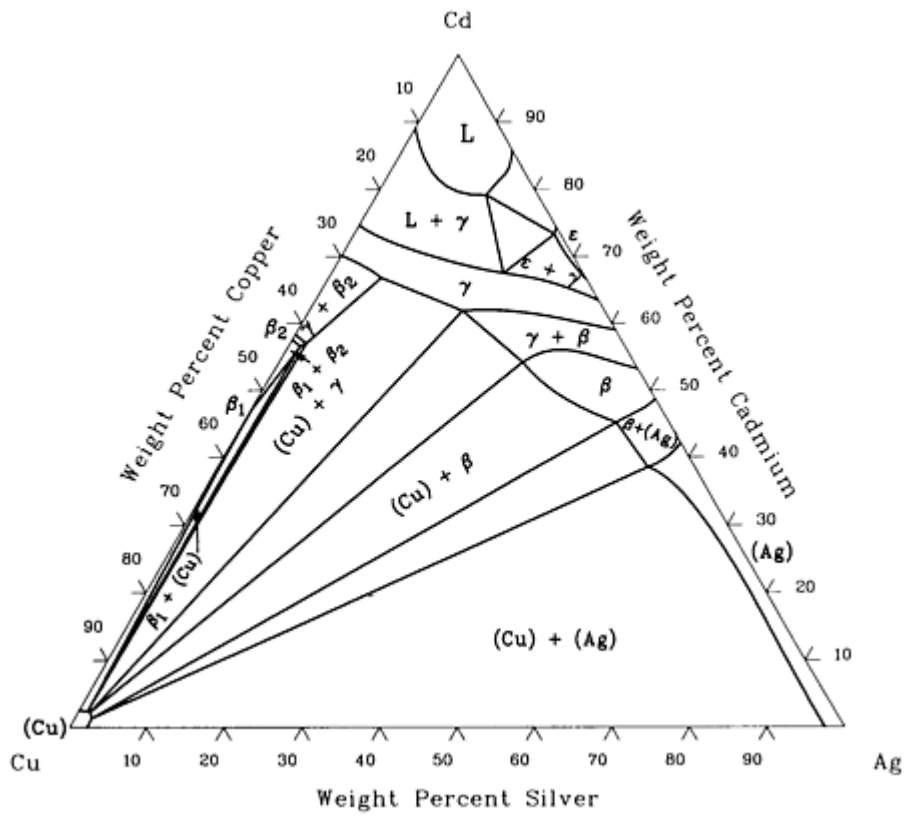

Ag-Cd-Cu isothermal section at 500 °C [88Pet 59].

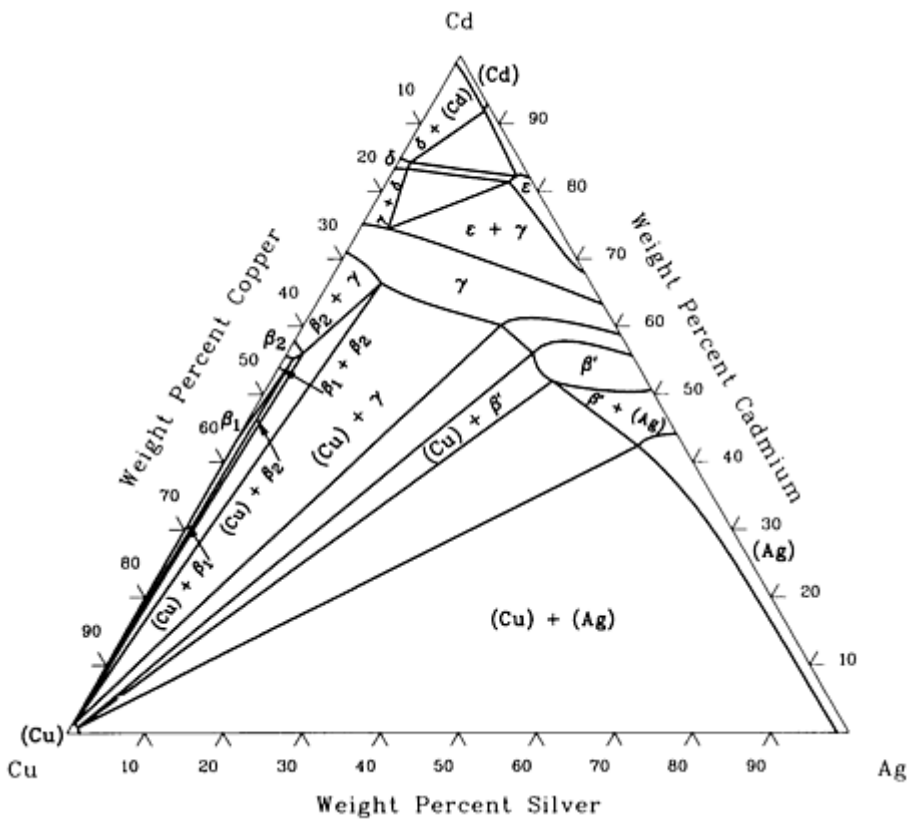

Ag-Cd-Cu isothermal section at 300 °C [88Pet 59].

Ag-Cd-Zn (Silver - Cadmium - Zinc) Ternary Phase Diagrams

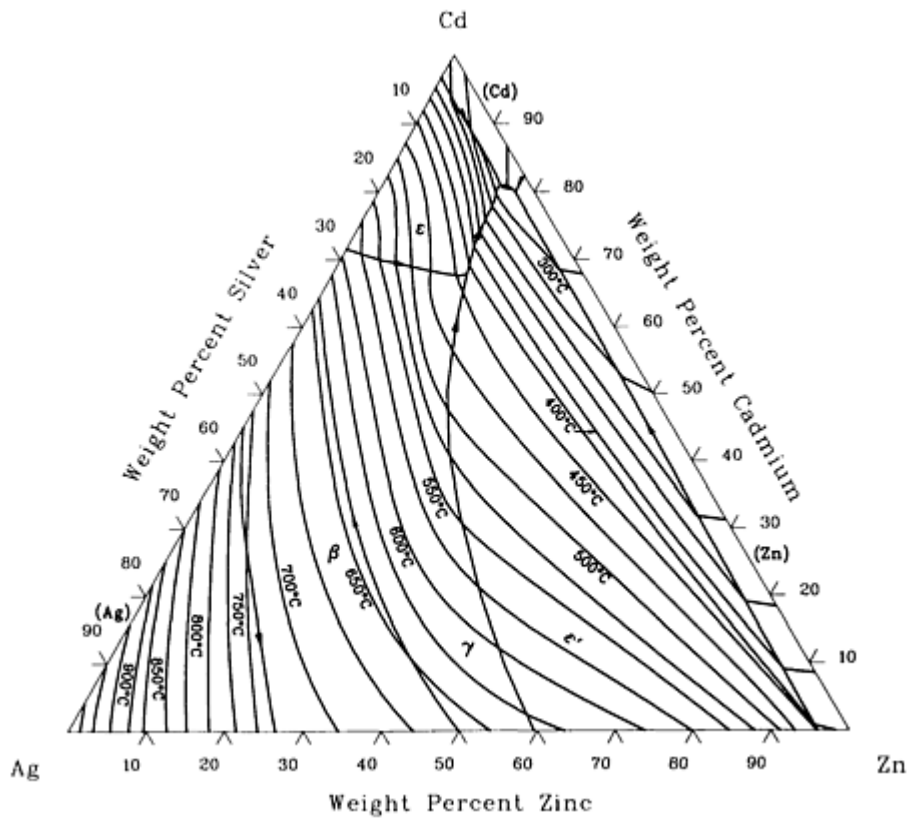

Ag-Cd-Zn liquidus projection with regions of primary crystallization [88Pet 59].

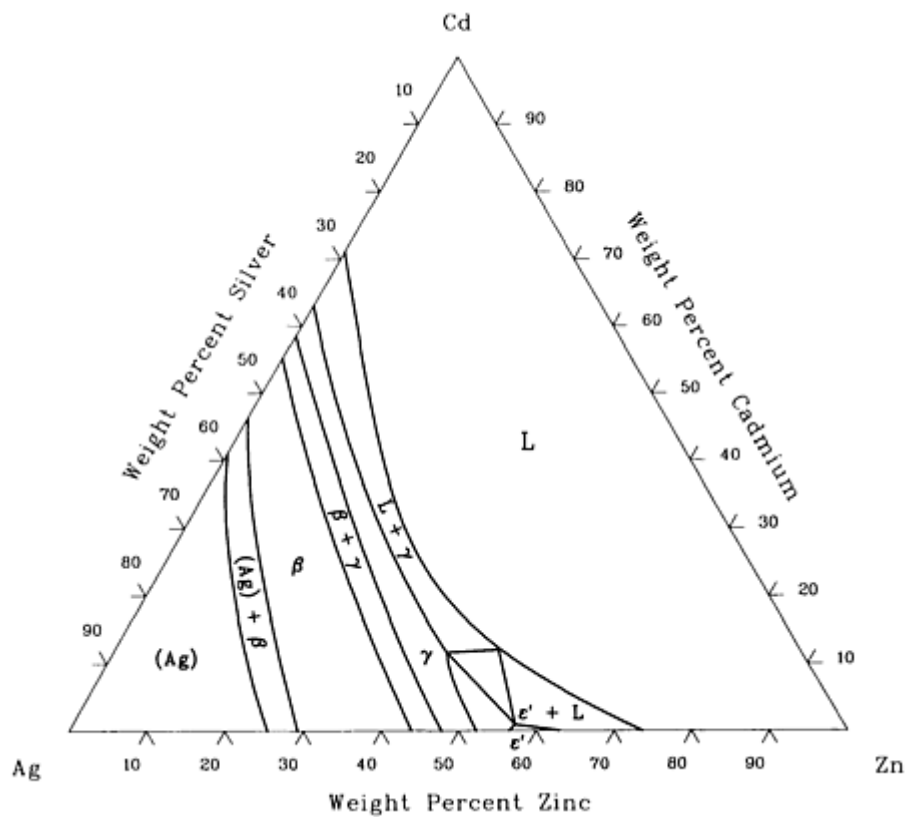

Ag-Cd-Zn isothermal section at 600 °C [88Pet 59].

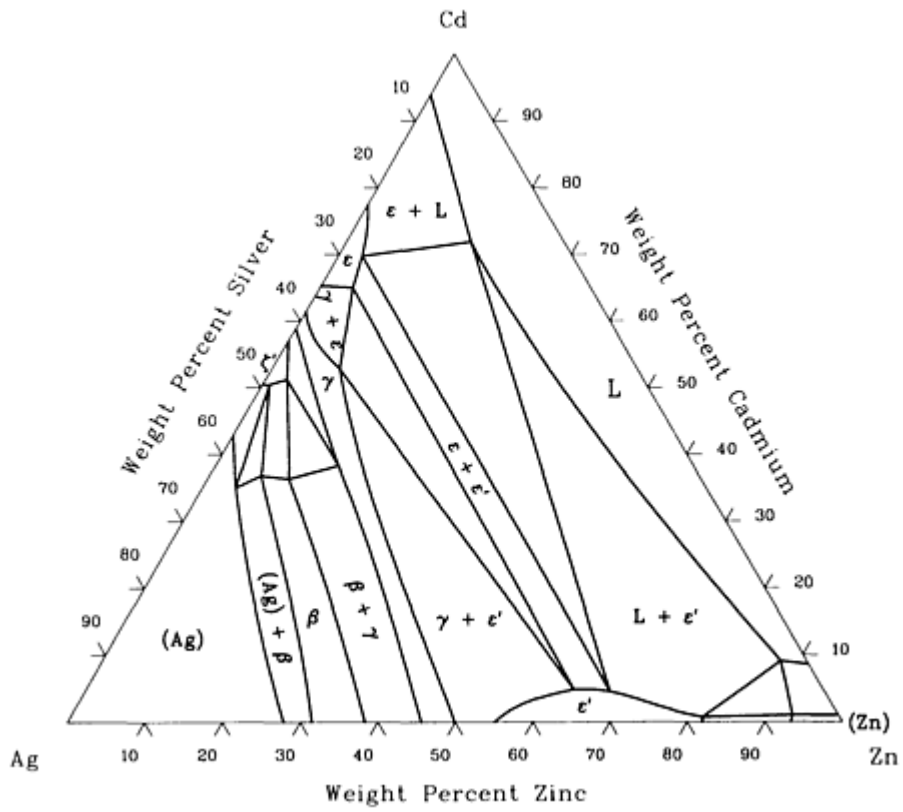

Ag-Cd-Zn isothermal section at 400 °C [88Pet 59].

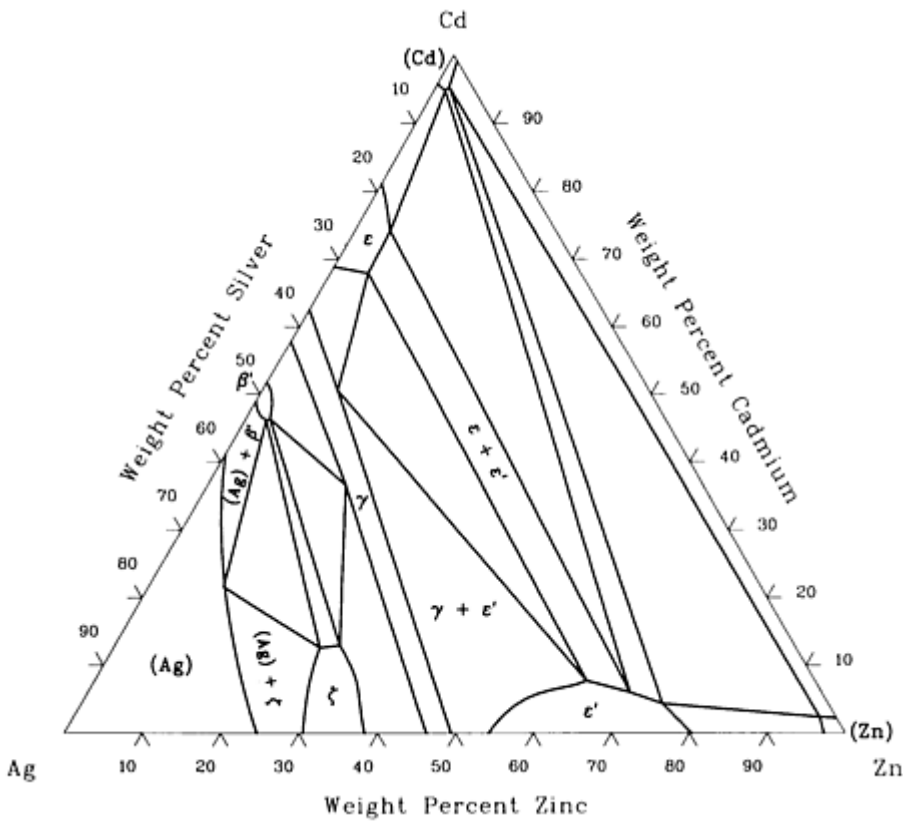

Ag-Cd-Zn isothermal section at 200 °C [88Pet 59].

Reference cited in this section

88Pet: G. Petzow and G. Effenberg, *Ternary Alloys*, VCH Verlagsgesellschaft, Weinheim, Germany, Vol 1, 1988

Ag-Cu-Zn (Silver - Copper - Zinc) Ternary Phase Diagrams

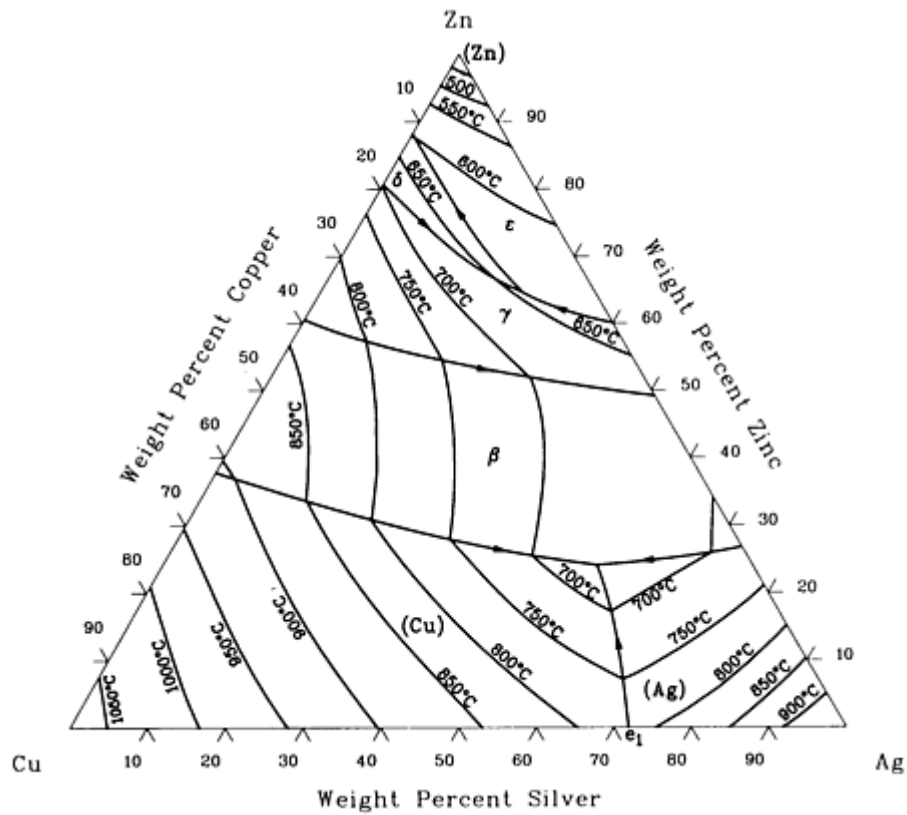

Ag-Cu-Zn liquidus projection [88Pet 59].

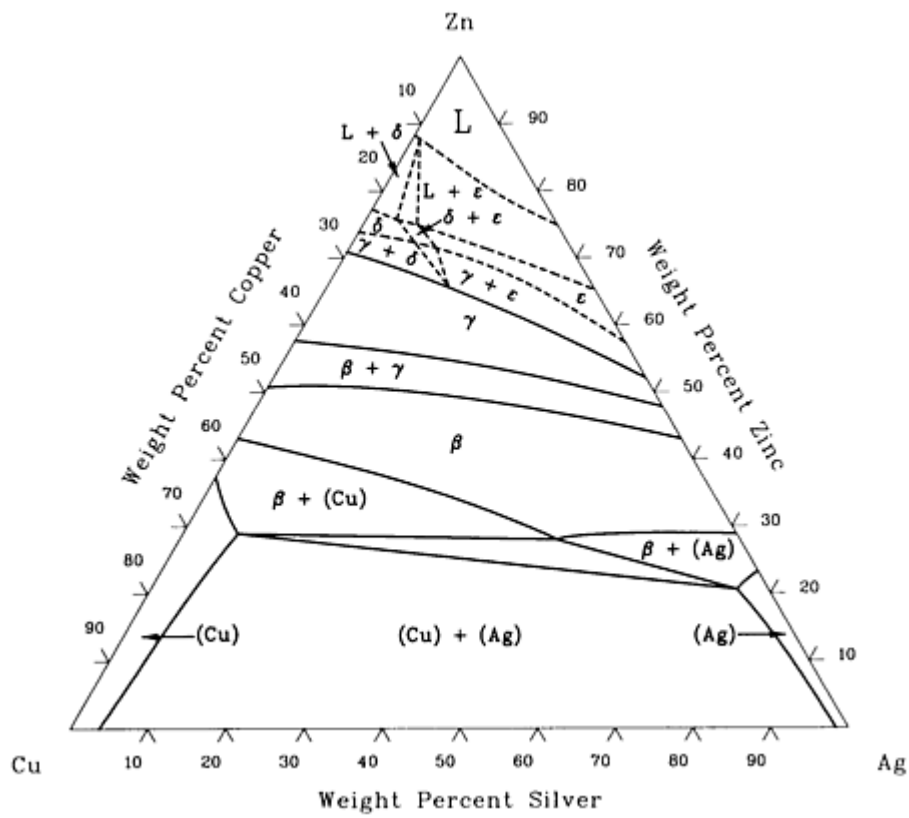

Ag-Cu-Zn isothermal section at 600 °C [88Pet 59].

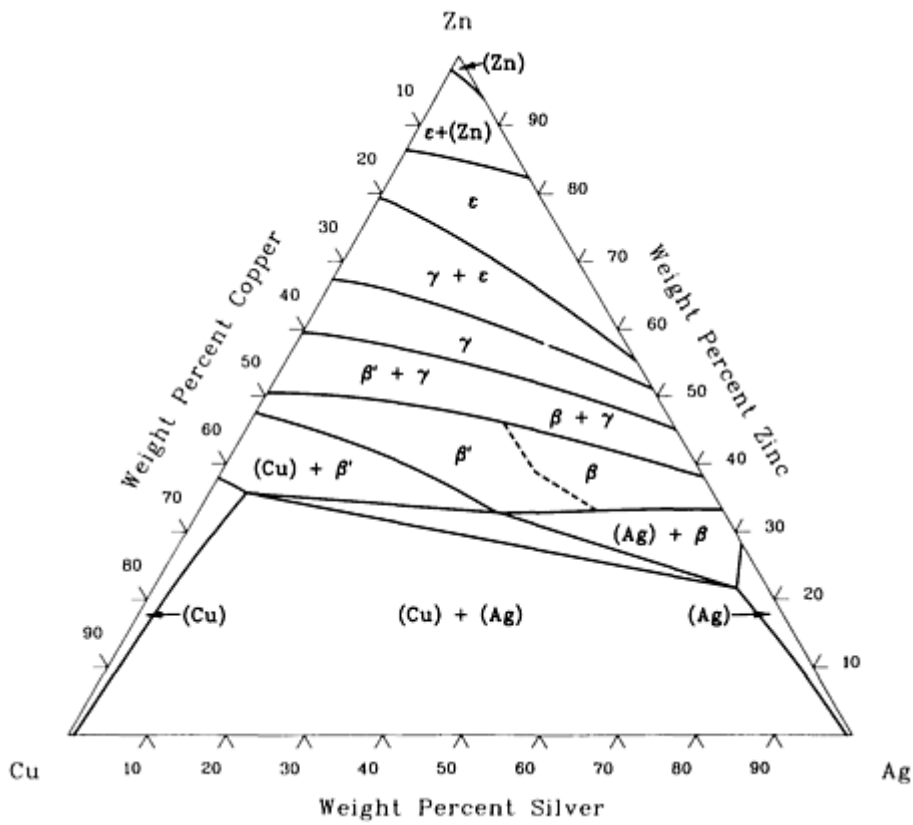

Ag-Cu-Zn isothermal section at 350 °C [88Pet 59].

Ag-Pb-Sn (Silver - Lead - Tin) Ternary Phase Diagrams

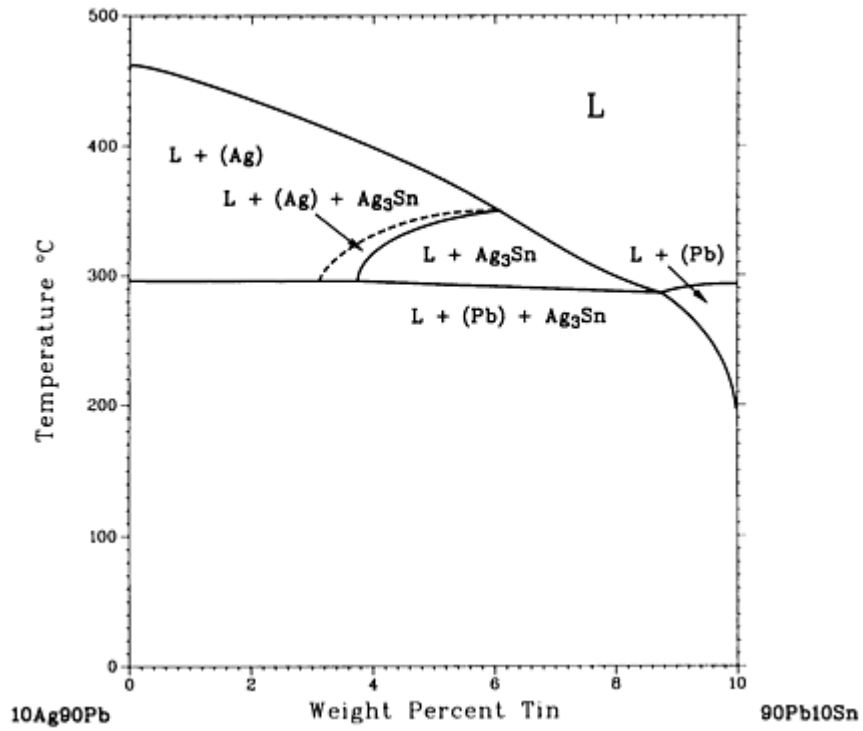

Ag-Pb-Sn [11Par 1].

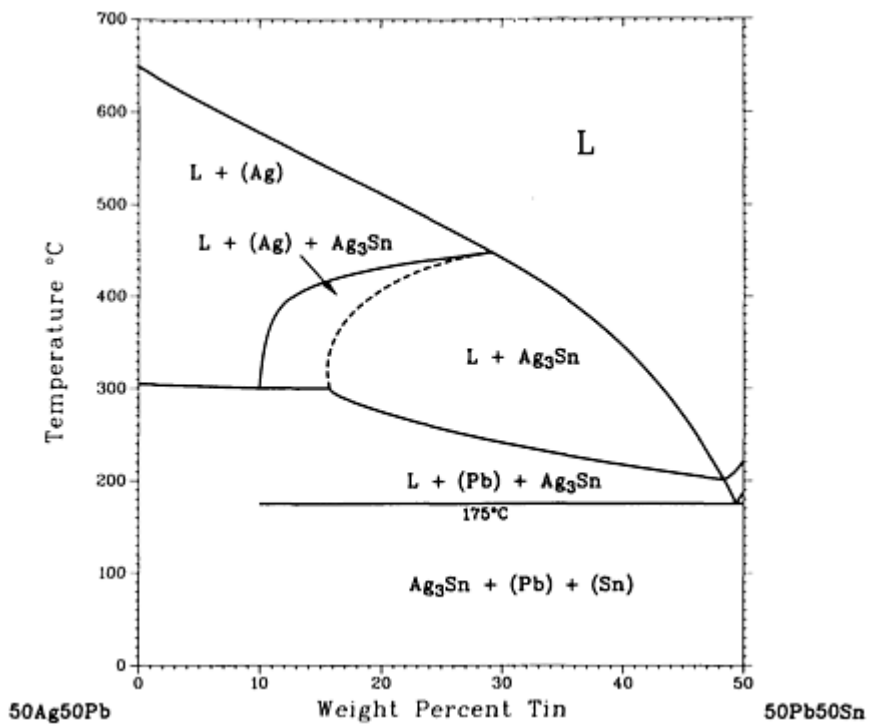

Ag-Pb-Sn [11Par 1].

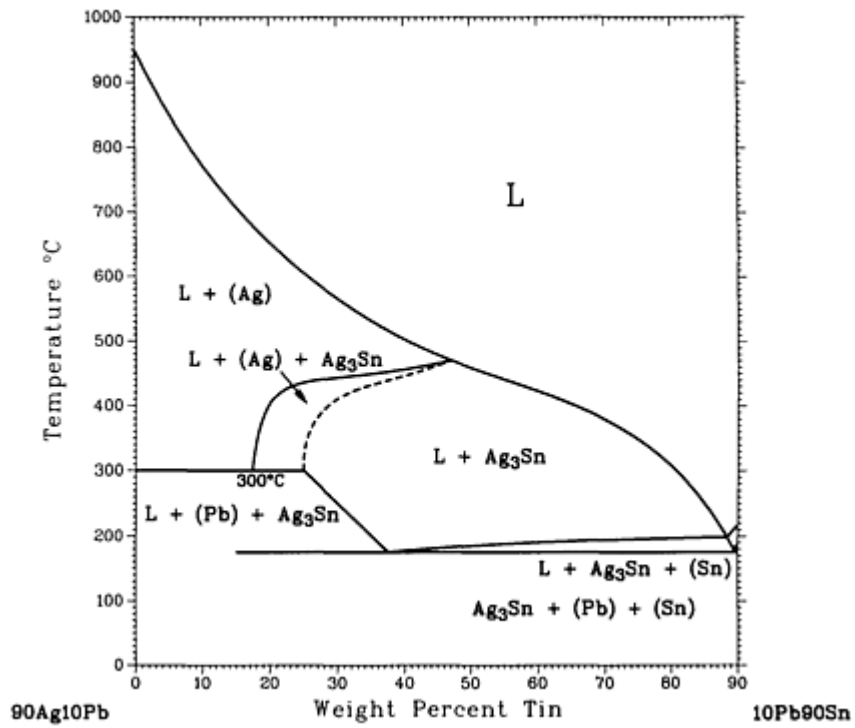

Ag-Pb-Sn [11Par 1].

Reference cited in this section

11Par: N. Parravano, "Das Ternäre System Silber-Zinn-Blei," *Z. Metallkd.*, Vol 1, 1911, p 89-108

Al (Aluminum) Ternary Alloy Phase Diagrams

Introduction

THIS ARTICLE includes systems where aluminum is the first-named element in the ternary system.

Al-Cr-Fe (Aluminum - Chromium - Iron) Ternary Phase Diagrams

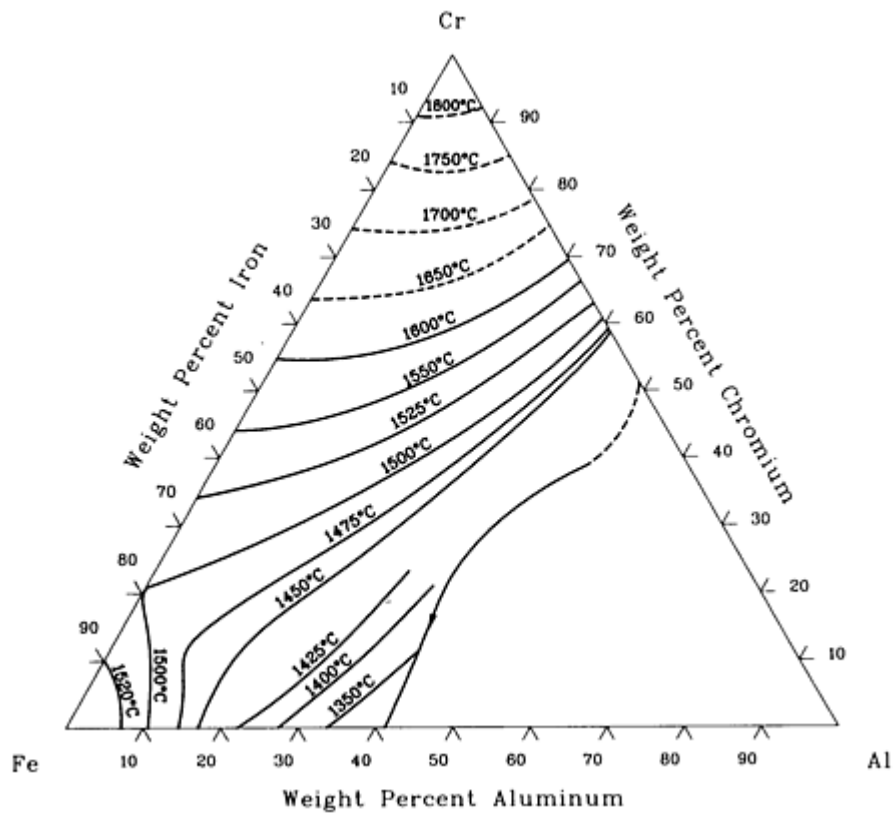

Al-Cr-Fe liquidus projection [88Ray 60].

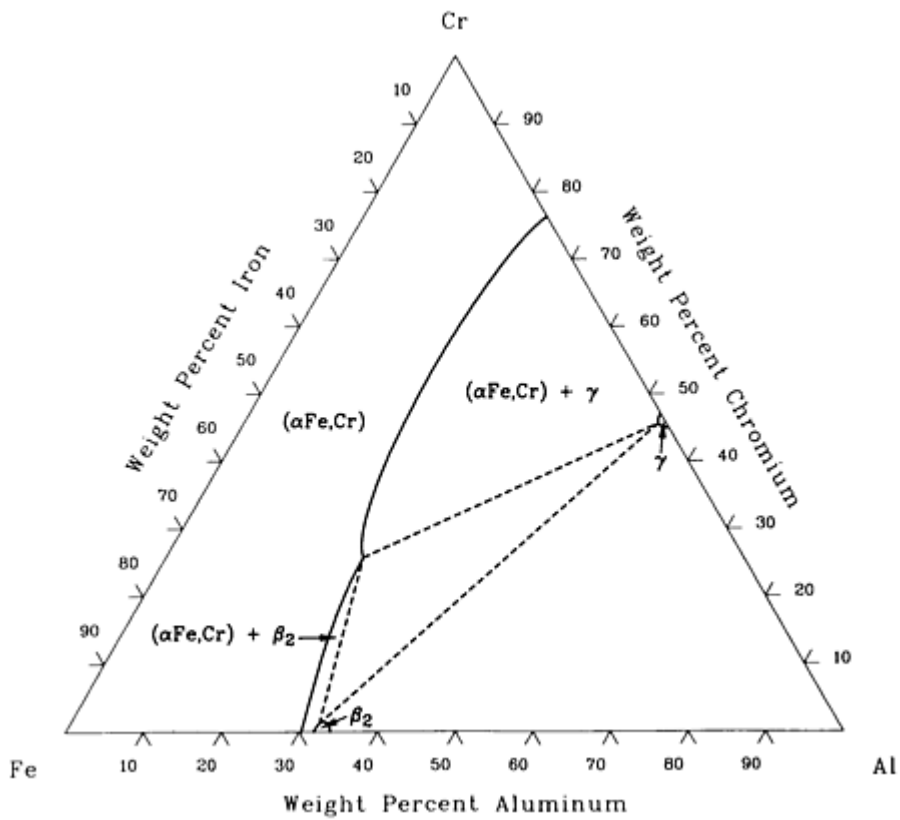

Al-Cr-Fe isothermal section at 900 °C [88Ray 60].

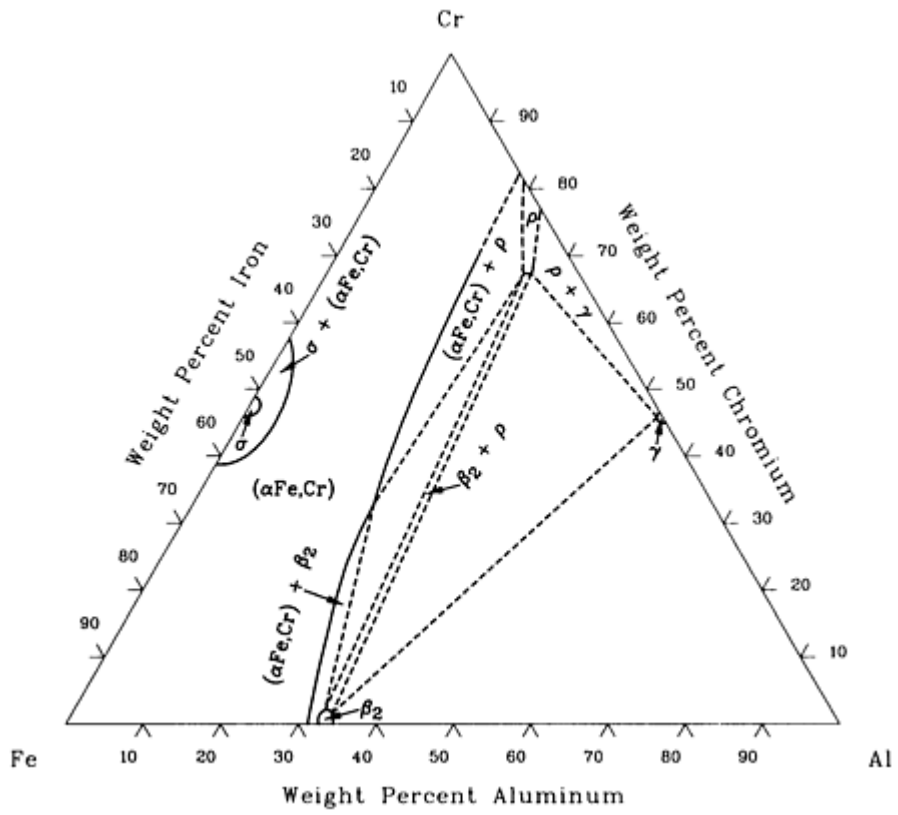

Al-Cr-Fe isothermal section at 750 °C [88Ray 60].

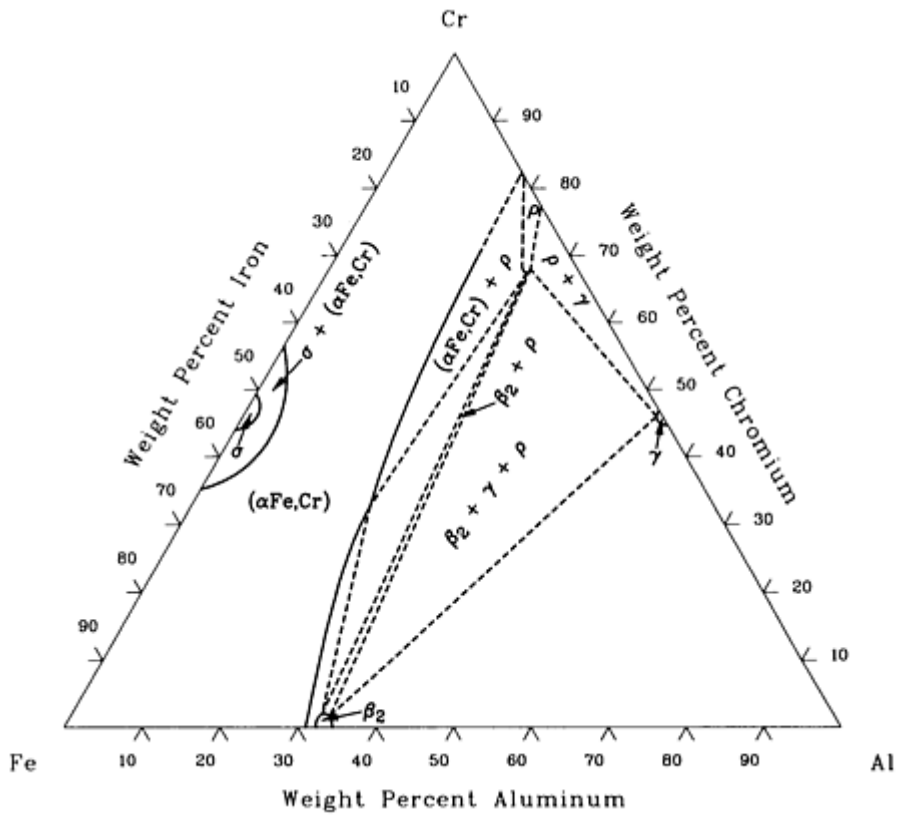

Al-Cr-Fe isothermal section at 600 °C [88Ray 60].

88Ray: G.V. Raynor and V.G. Rivlin, *Phase Equilibria in Iron Ternary Alloys*, The Institute of Metals, London, (No. 4), 1988

Al-Cr-Mn (Aluminum - Chromium - Manganese) Ternary Phase Diagrams

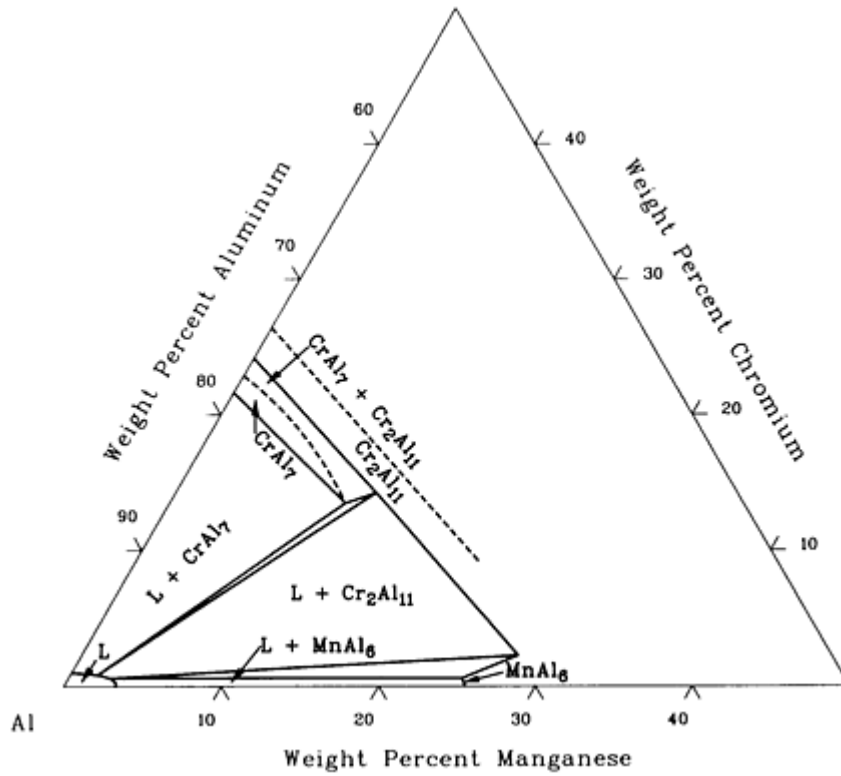

Al-Cr-Mn isothermal section at 690 °C [73Wil 34].

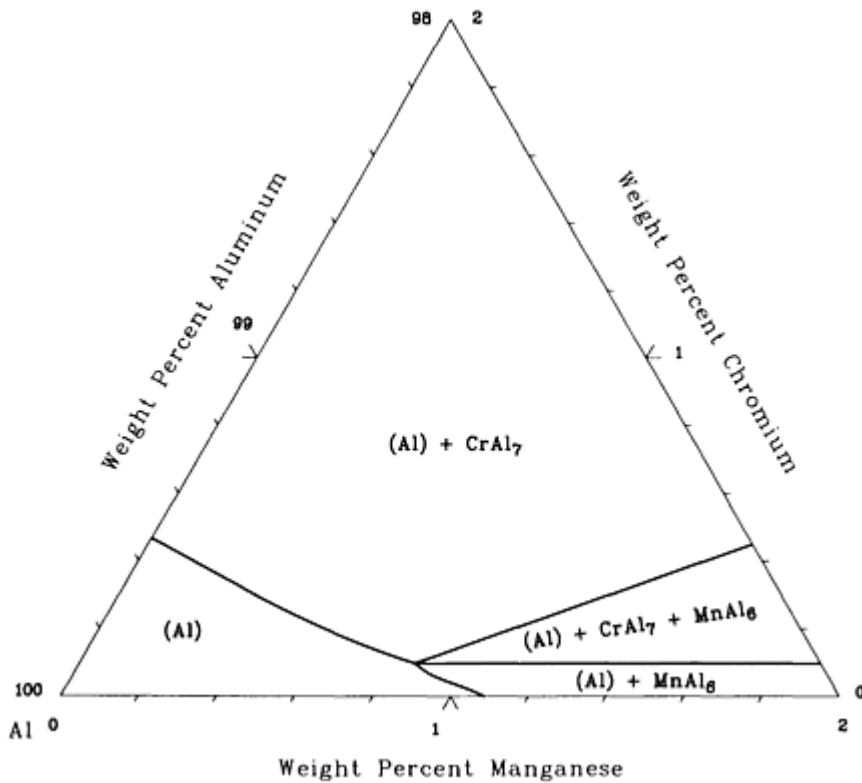

Al-Cr-Mn isothermal section at 600 °C [73Wil 34].

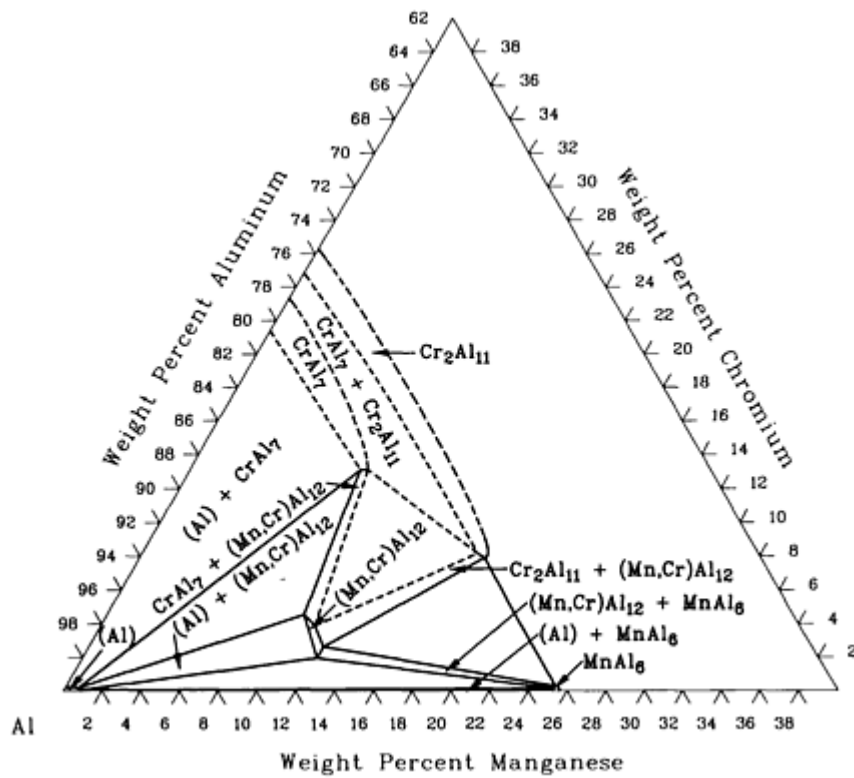

Al-Cr-Mn isothermal section at 550 °C [73Wil 34].

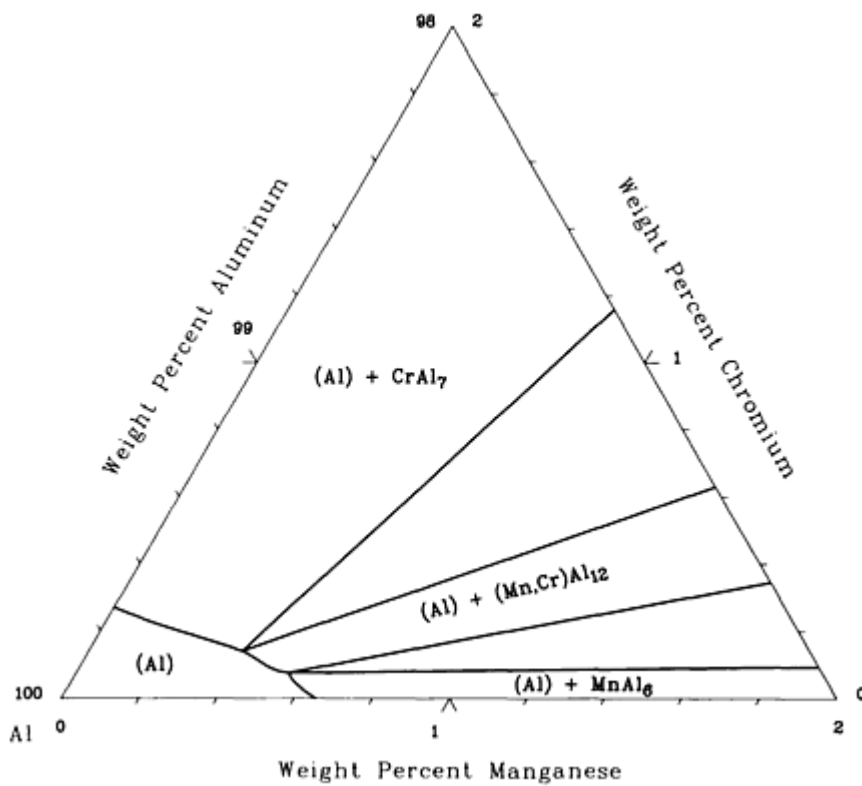

Al-Cr-Mn (Al) isothermal section at 550 °C [73Wil 34].

73Wil: L.A. Willey, *Metallography, Structures and Phase Diagrams*, Vol 8, *Metals Handbook*, 8th ed., American Society for Metals, Metals Park, OH 1973

Al-Cr-Ni (Aluminum - Chromium - Nickel) Ternary Phase Diagrams

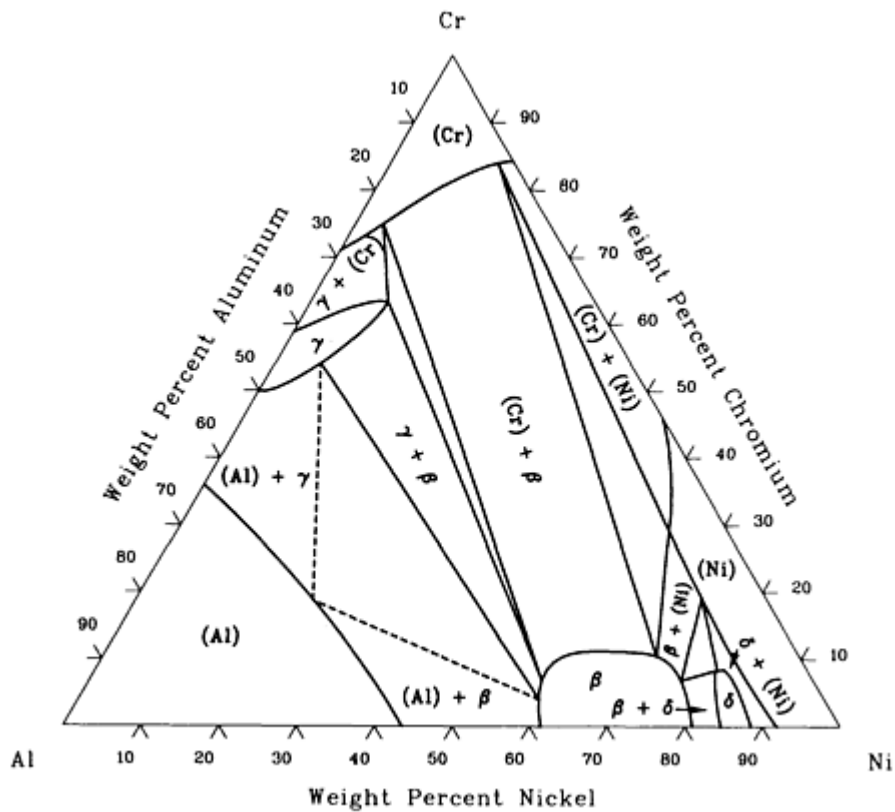

Al-Cr-Ni isothermal section at 1150 °C [87Ofo 56].

Reference cited in this section

87Ofo: N.C. Oforika and C.W. Haworth, "Phase Equilibria of Aluminum-Chromium-Nickel System at 1423 K," *Scand. J. Metall.*, Vol 16, 1987, p 184-188

Al-Cr-Ti (Aluminum - Chromium - Titanium) Ternary Phase Diagrams

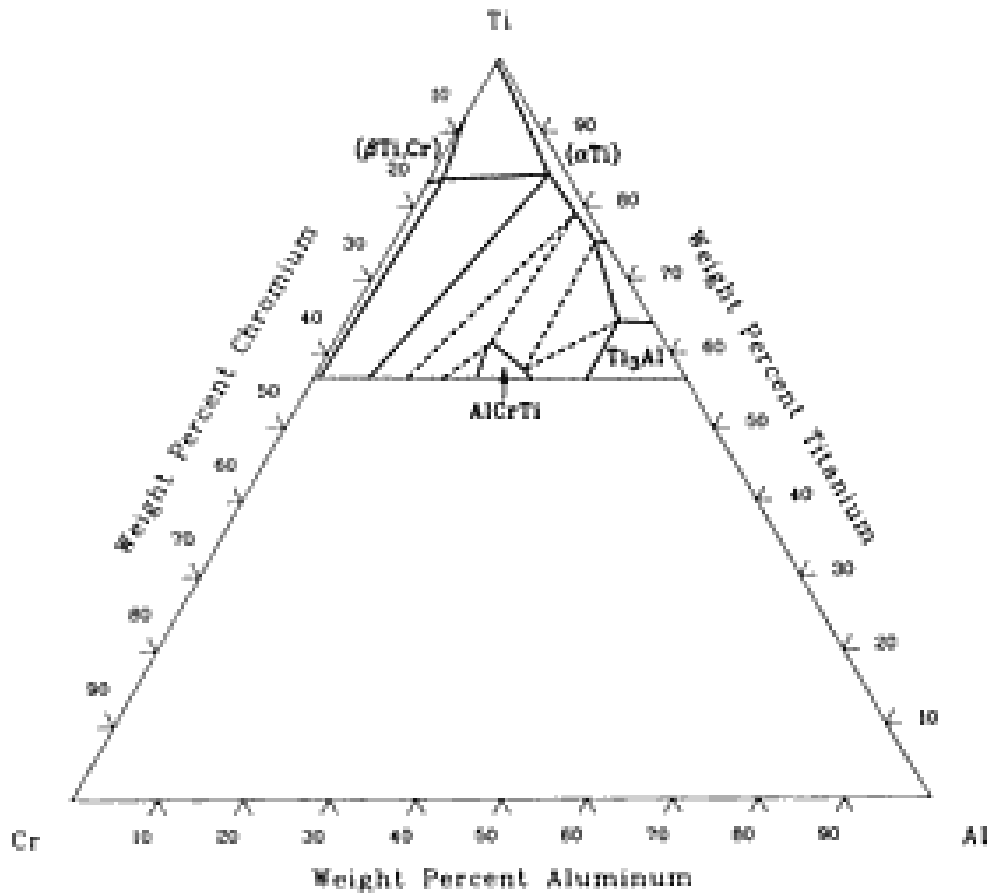

Al-Cr-Ti isothermal section at 760 °C [56Zwi 8].

Reference cited in this section

56Zwi: U. Zwicker, "Die Systeme Titan-Aluminium-Chrom und Titan-Aluminium-Vanadin und die technischen Titanlegierungen mit 5% Cr und 3% Al sowie mit 6% Al und 4% V," *Z. Metallkd.*, Vol 47, 1956, p 535-548

Al-Cu-Fe (Aluminum - Copper - Iron) Ternary Phase Diagrams

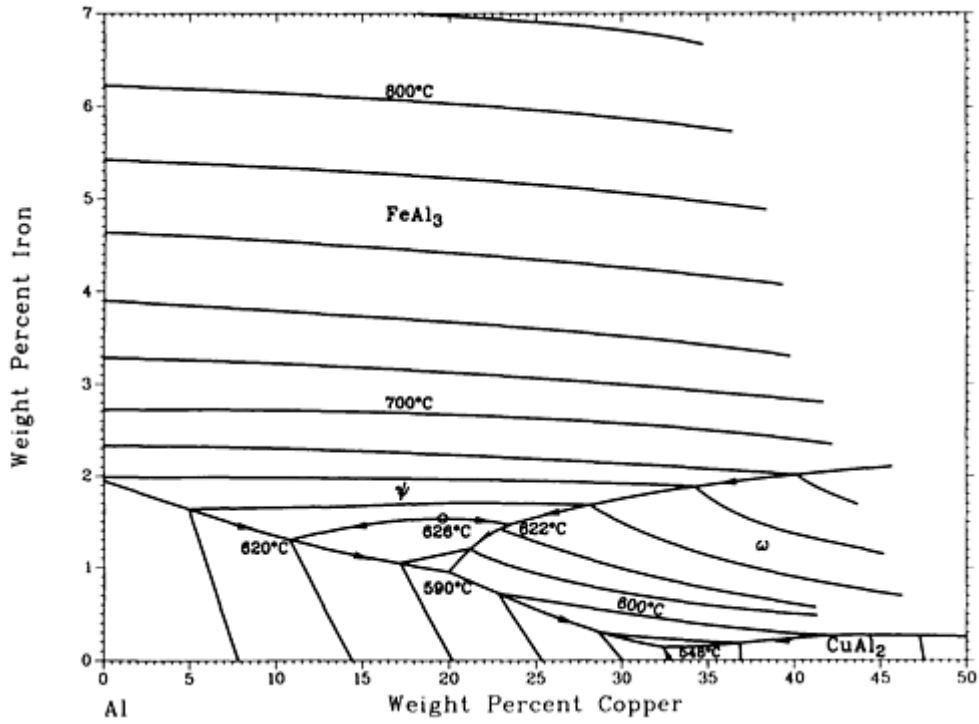

Al-Cu-Fe liquidus projection [73Wil 34].

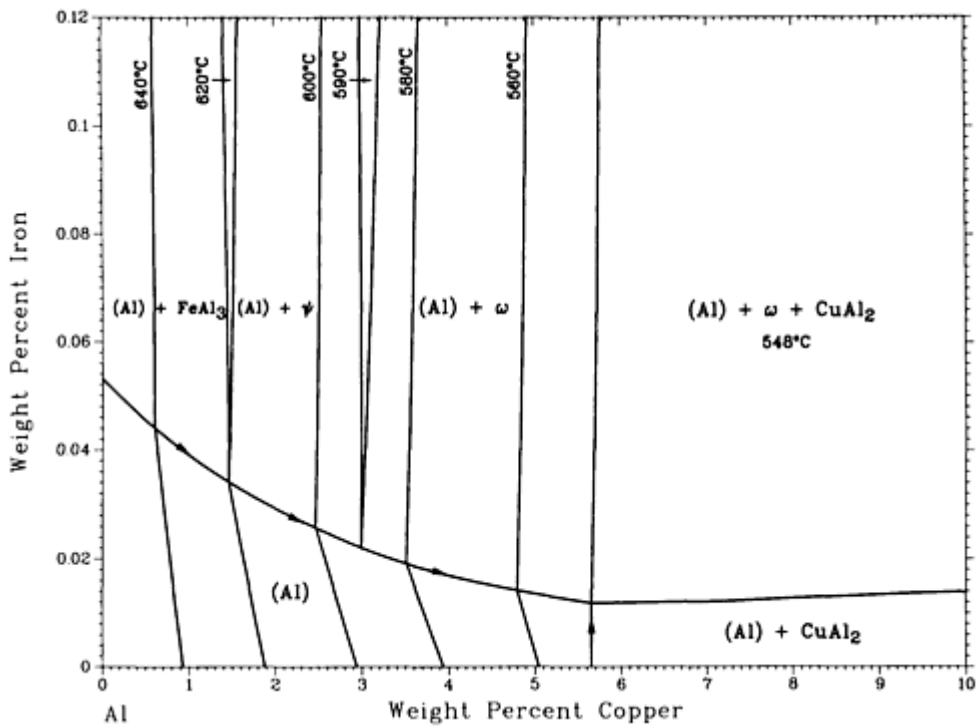

Al-Cu-Fe solidus projection [73Wil 34].

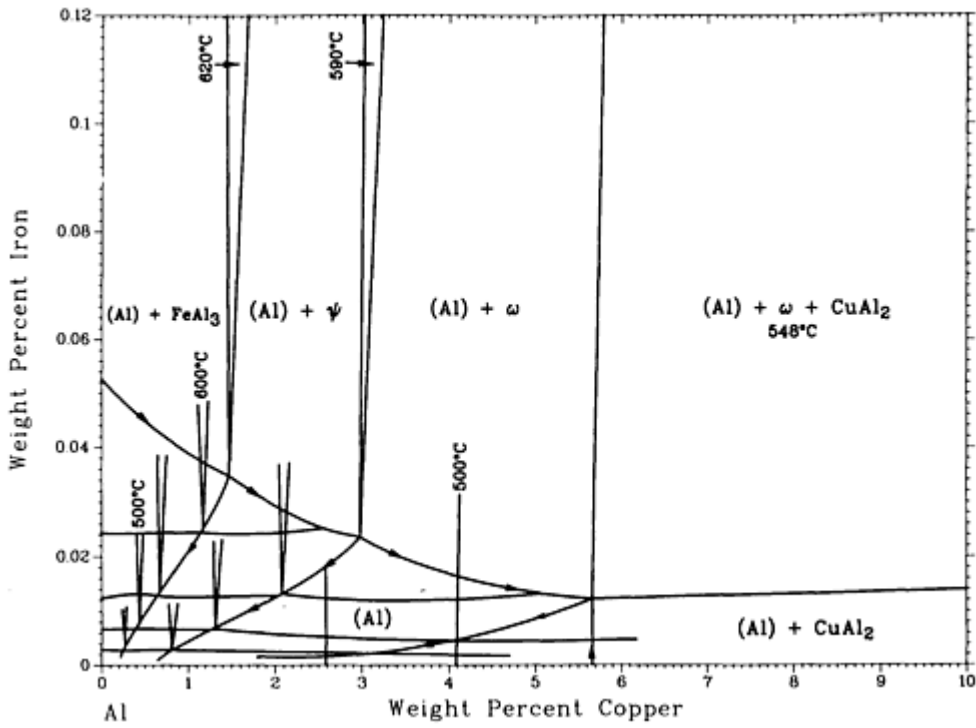

Al-Cu-Fe solvus projection [73Wil 34].

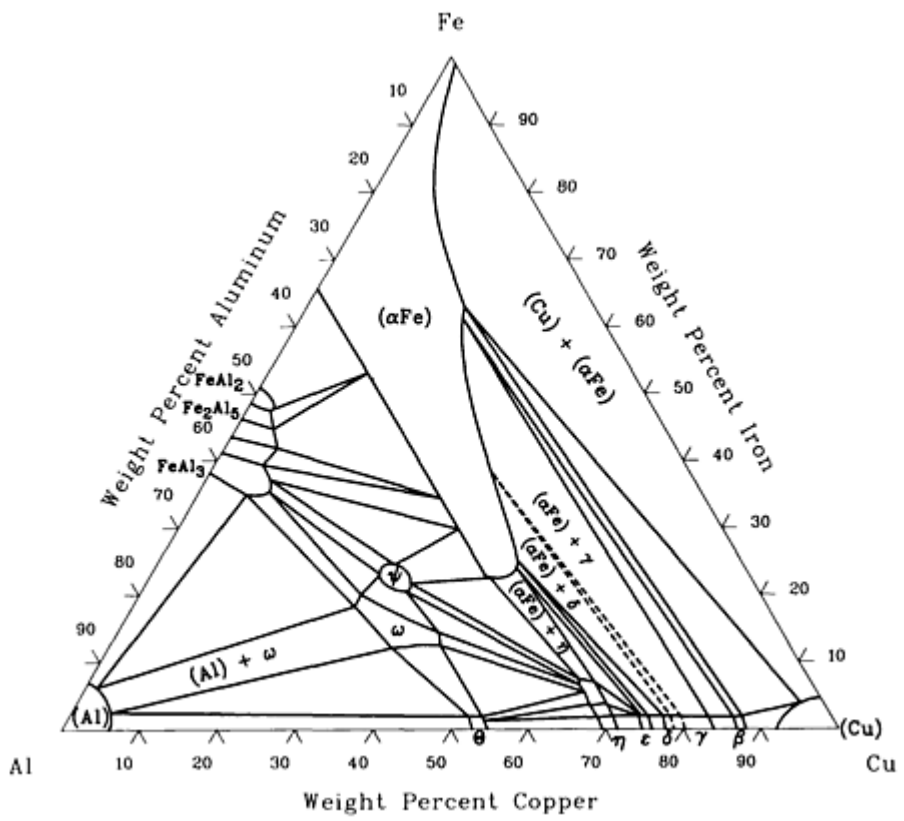

Al-Cu-Fe isothermal section at 600 °C [71Pre 25].

References cited in this section

71Pre: A.P. Prevarskiy, "Investigation of Fe-Cu-Al Alloys," *Russ. Metall.*; TR: *Izv. Akad. Nauk SSSR, Metall.*, (No. 4), 1971, p 154-156

Al-Cu-Mn (Aluminum - Copper - Manganese) Ternary Phase Diagrams

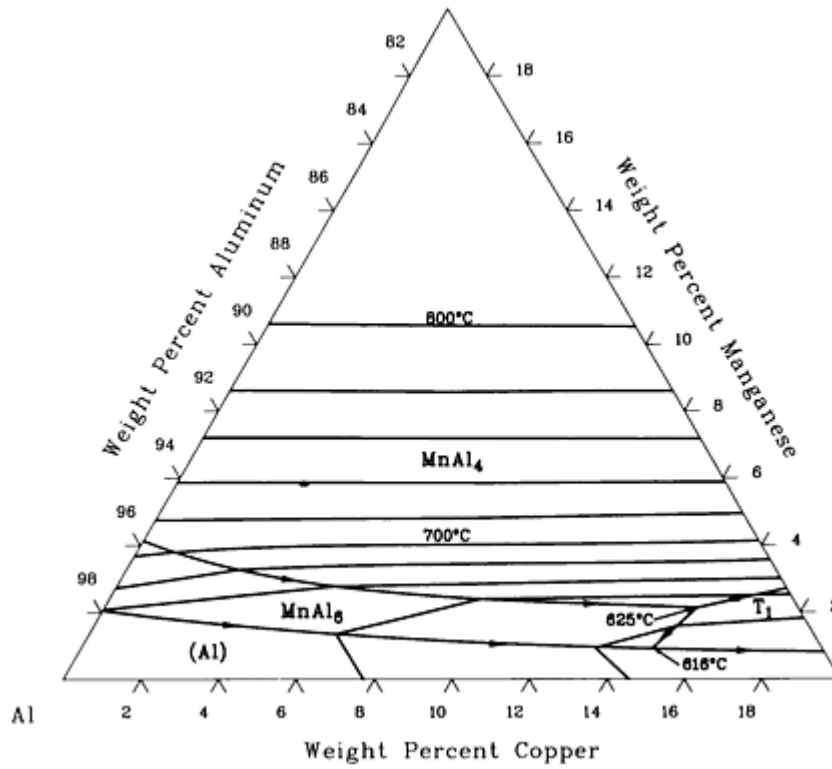

Al-Cu-Mn liquidus projection [73Wil 34].

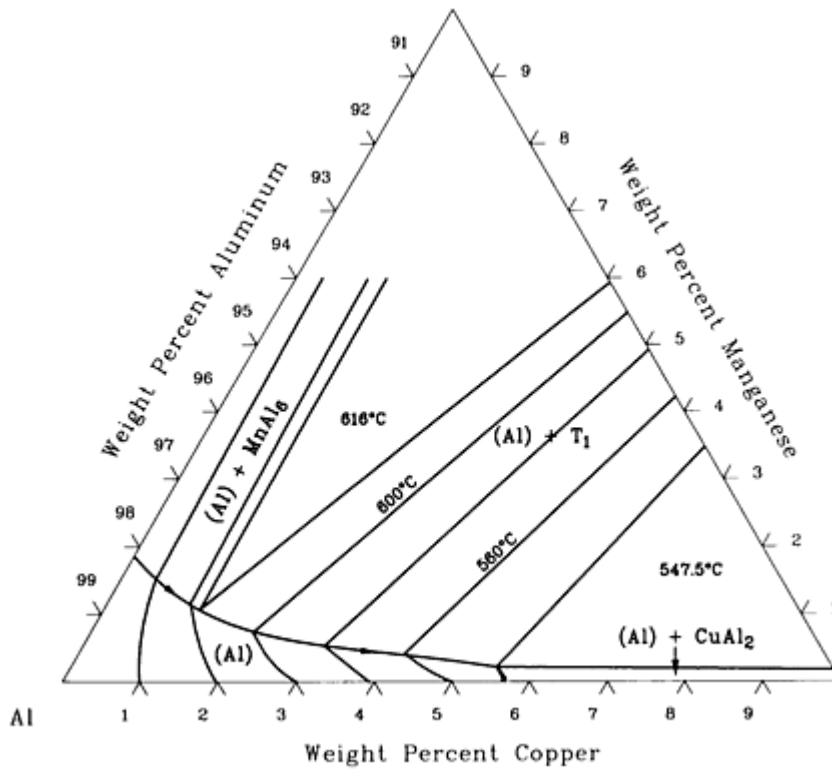

Al-Cu-Mn solidus projection [73Wil 34].

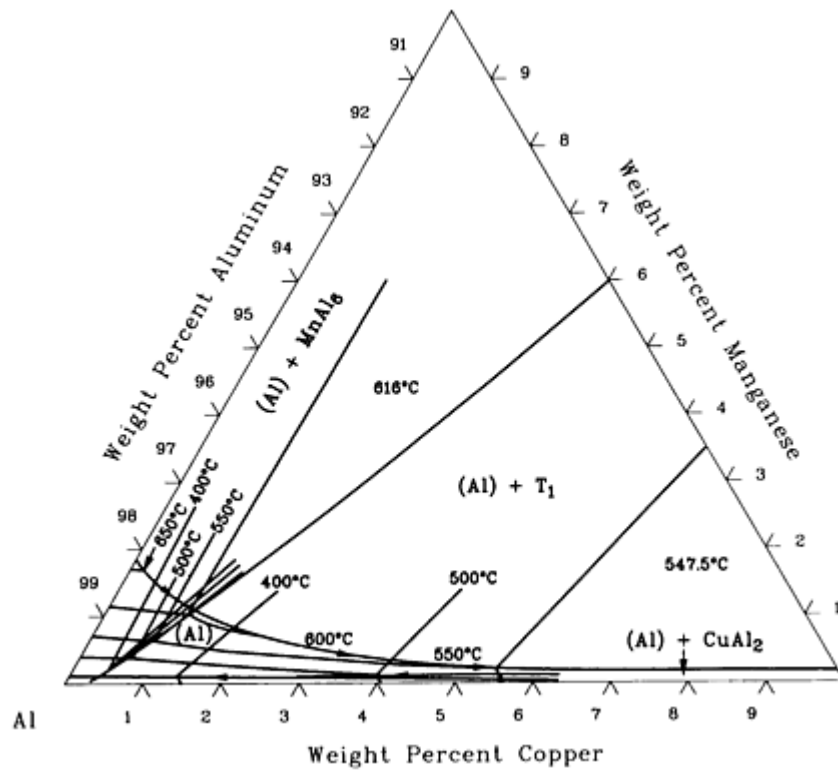

Al-Cu-Mn solvus projection [73Wil 34].

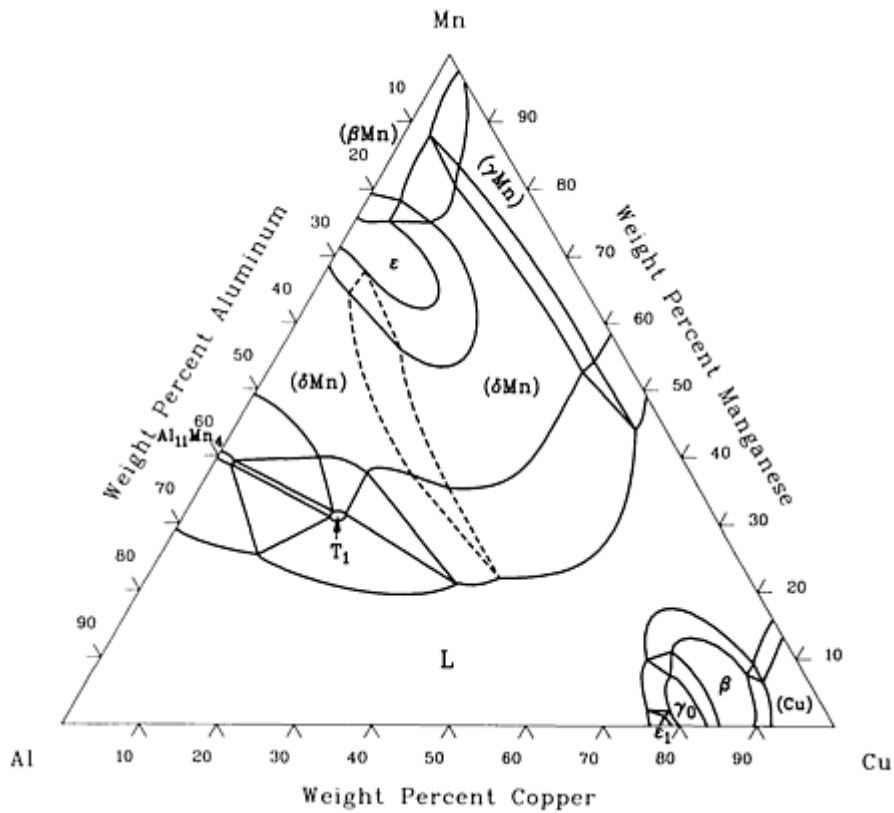

Al-Cu-Mn isothermal section at 950 °C [66Kos 21].

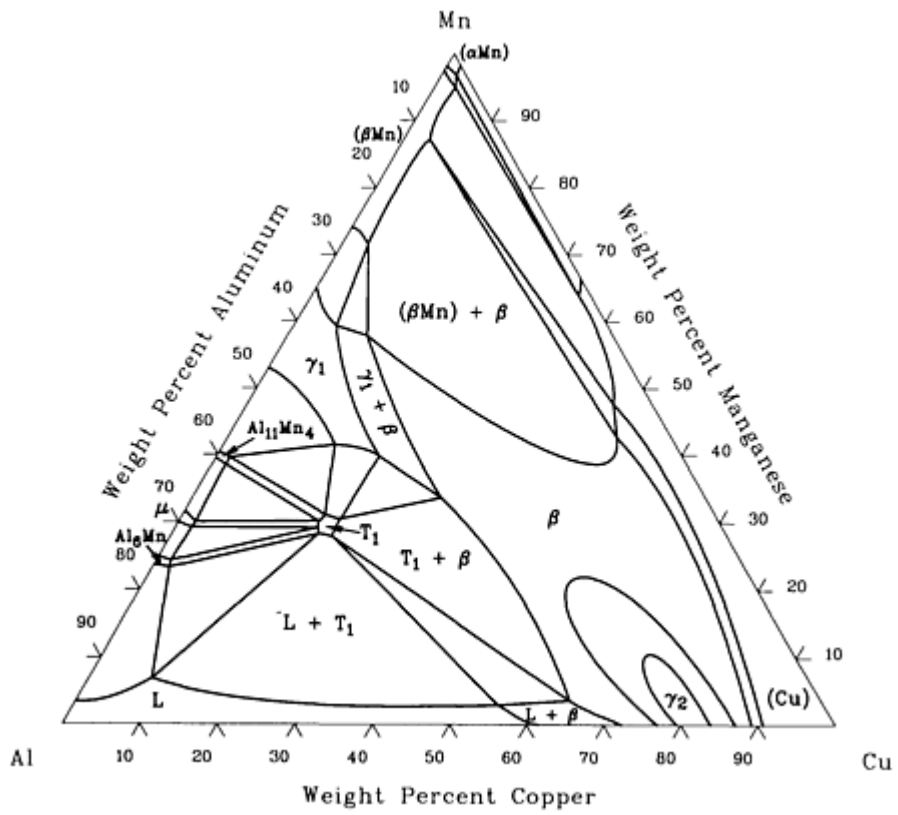

Al-Cu-Mn isothermal section at 700 °C [66Kos 21].

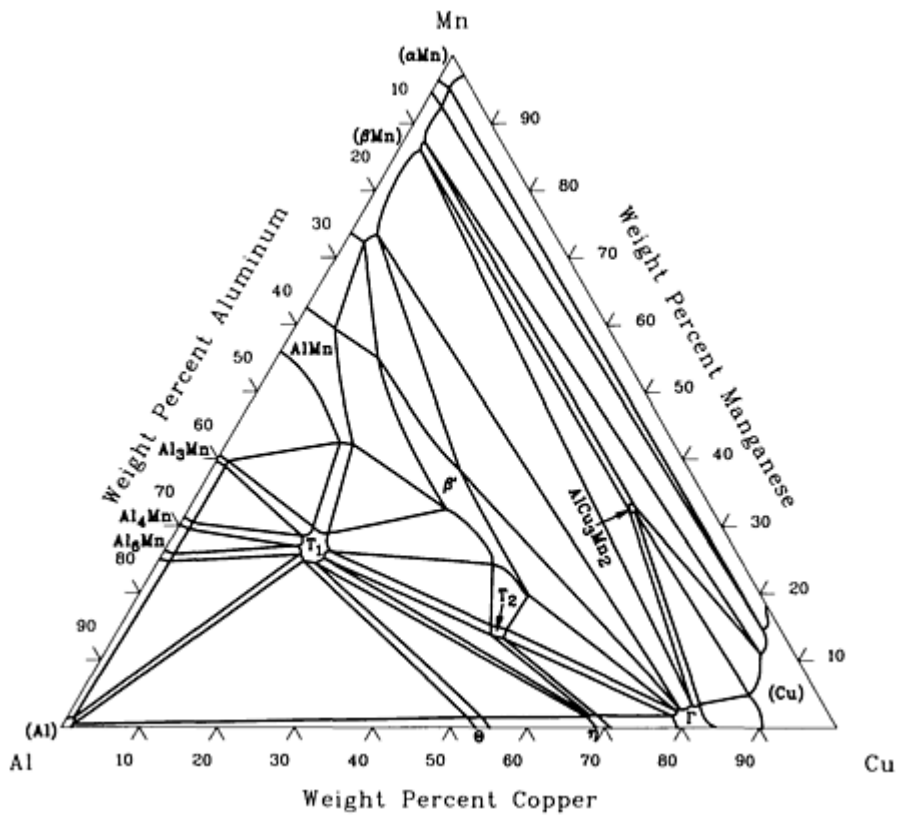

Al-Cu-Mn isothermal section at 25 °C [66Kos 21].

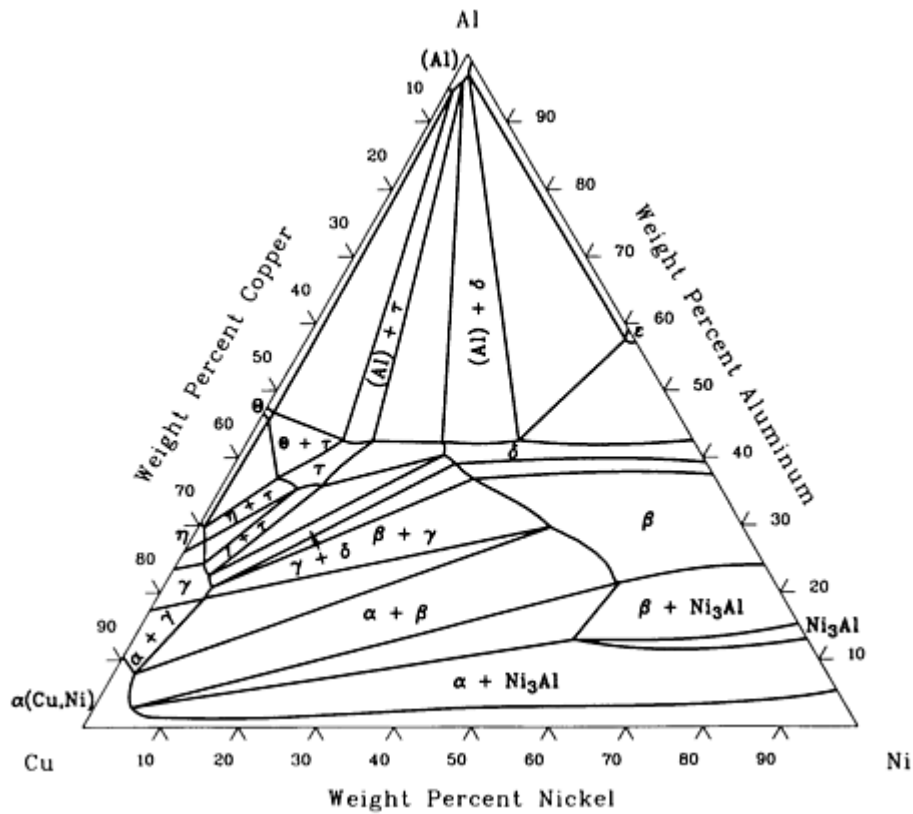

Al-Cu-Ni isothermal section at 500 °C [73Wil 34].

References cited in this section

- 48Kos:** W. Köster, U. Zwicker, and K. Moeller, "Mikroskopische und röntgenographische Untersuchungen zur Kenntnis des Systems Kupfer-Nickel-Aluminium," *Z. Metallkd.*, Vol 39, 1948, p 225-231
- 73Wil:** L.A. Willey, *Metallography, Structures and Phase Diagrams*, Vol 8, *Metals Handbook*, 8th ed., American Society for Metals, Metals Park, OH 1973

Al-Cu-Si (Aluminum - Copper - Silicon) Ternary Phase Diagrams

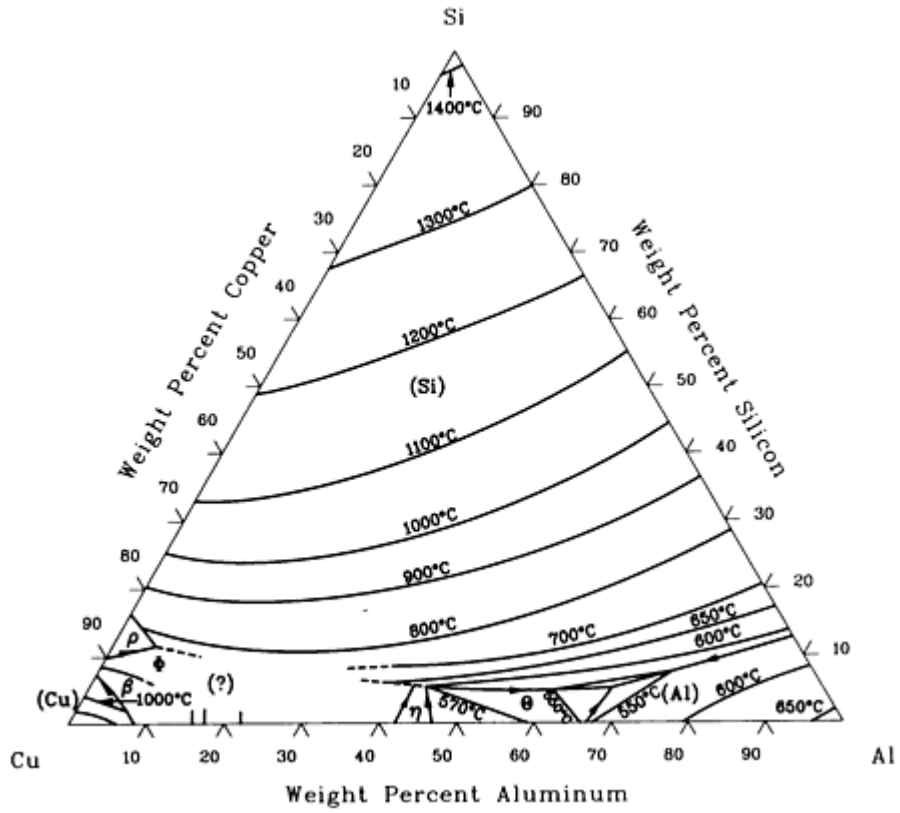

Al-Cu-Si liquidus projection [79Cha 38].

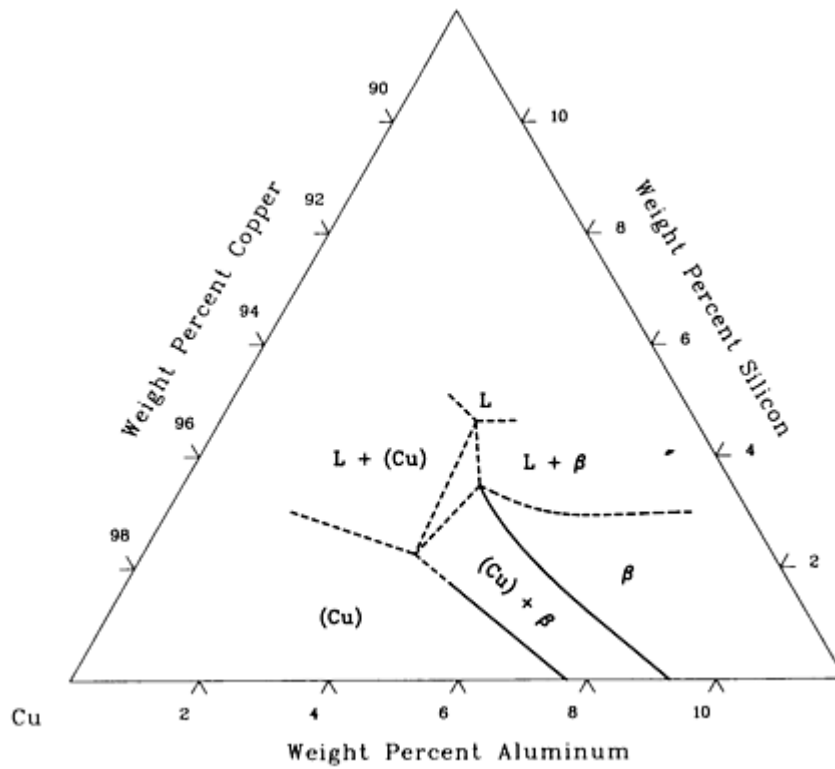

Al-Cu-Si isothermal section at 955 °C [48WII 5].

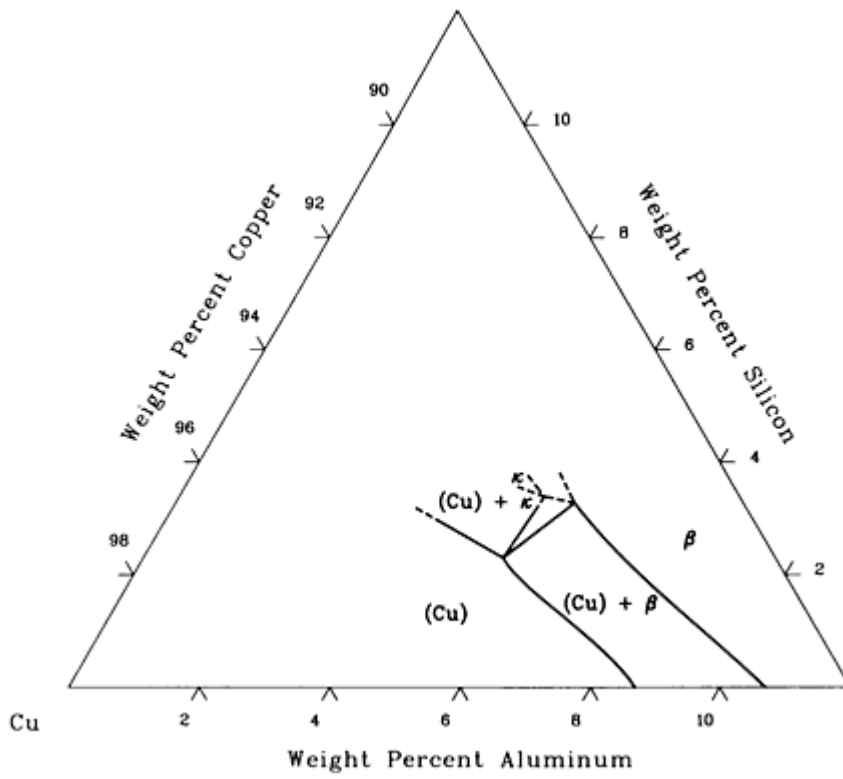

Al-Cu-Si isothermal section at 750 °C [48Wil 5].

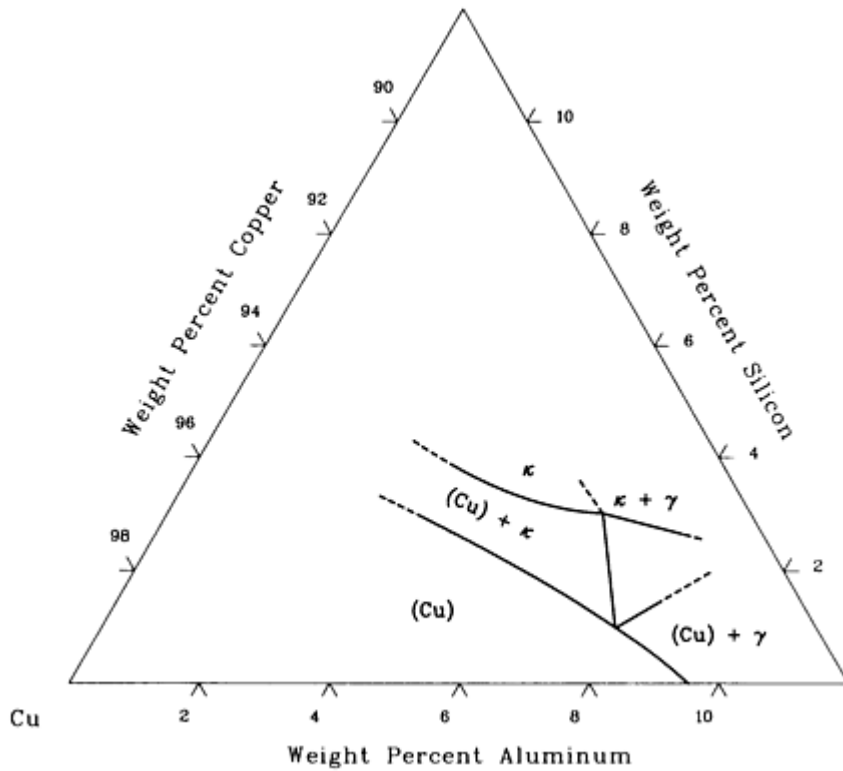

Al-Cu-Si isothermal section at 400 °C [48Wil 5].

References cited in this section

48Wil: F.H. Wilson, "The Copper-Rich Corner of the Copper-Aluminum-Silicon Diagram," *Trans. AIME*, Vol 175, 1948, p 262-273

79Cha: Y.A. Chang, J.P. Neumann, A. Mikula, and D. Goldberg, *Phase Diagrams and Thermodynamic Properties of Ternary Copper-Metal Systems*, INCRA Monograph VI, International Copper Research Association, 1979

Al-Cu-Zn (Aluminum - Copper - Zinc) Ternary Phase Diagrams

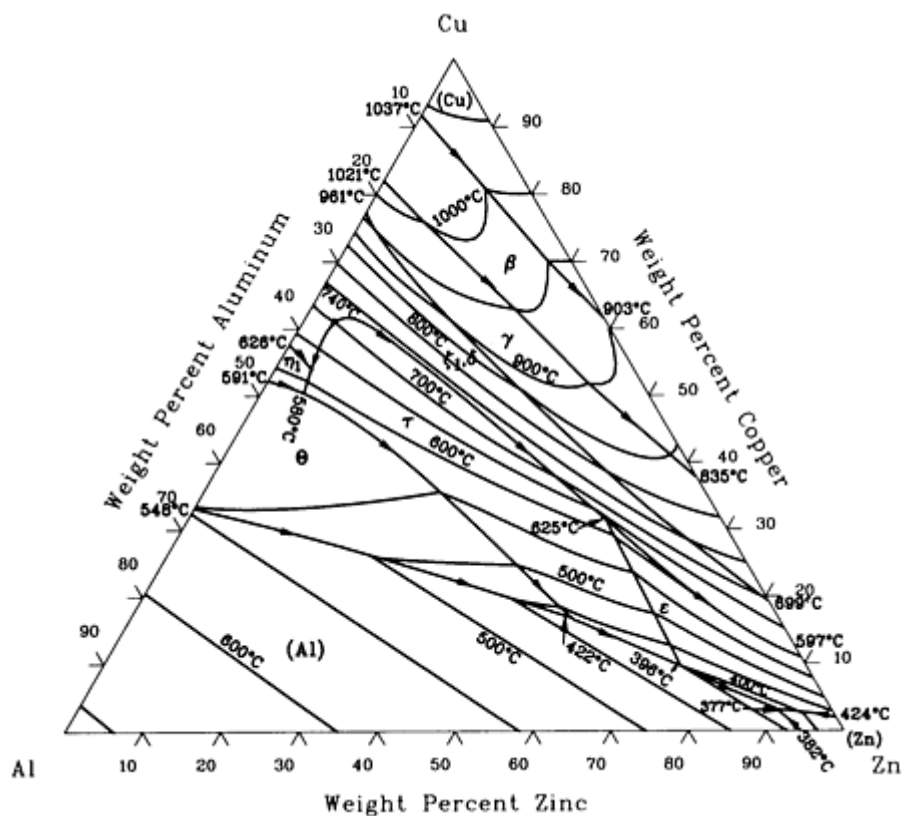

Al-Cu-Zn liquidus projection [73Wil 34].

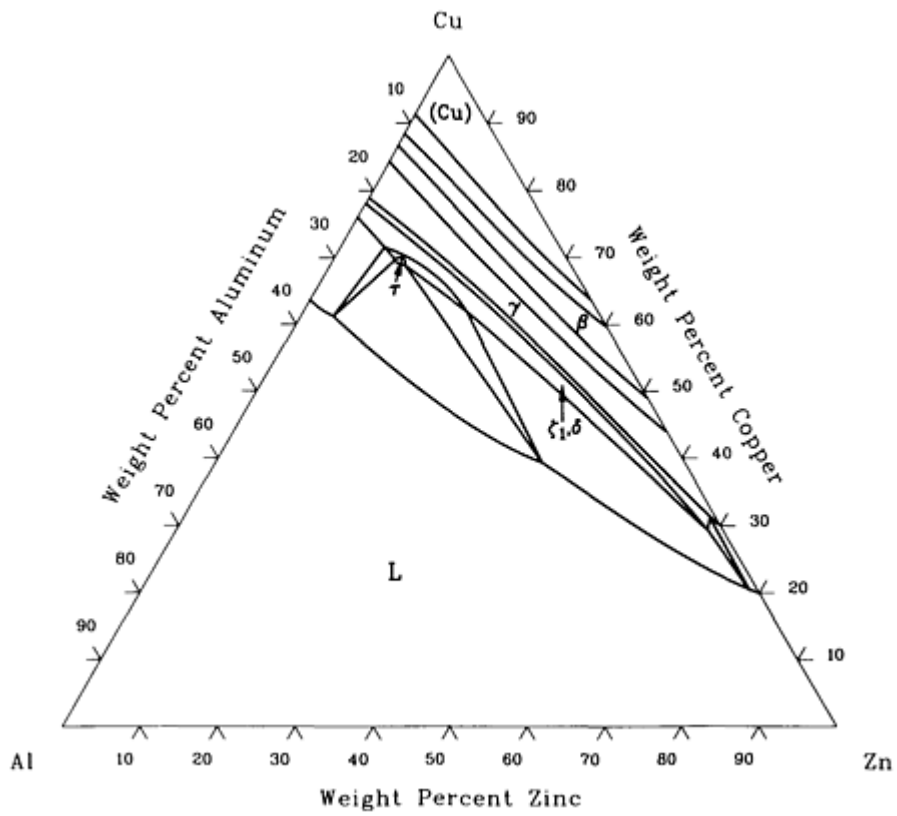

Al-Cu-Zn isothermal section at 700 °C [73Wil 34].

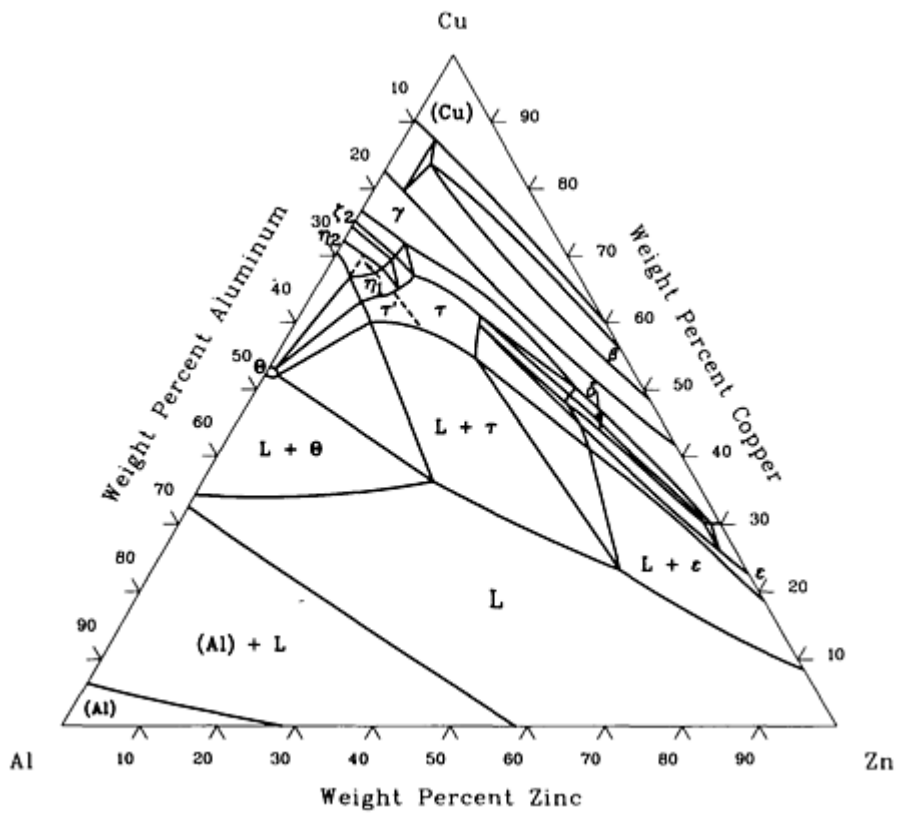

Al-Cu-Zn isothermal section at 550 °C [73Wil 34].

Al-Fe-Mn (Aluminum - Iron - Manganese) Ternary Phase Diagrams

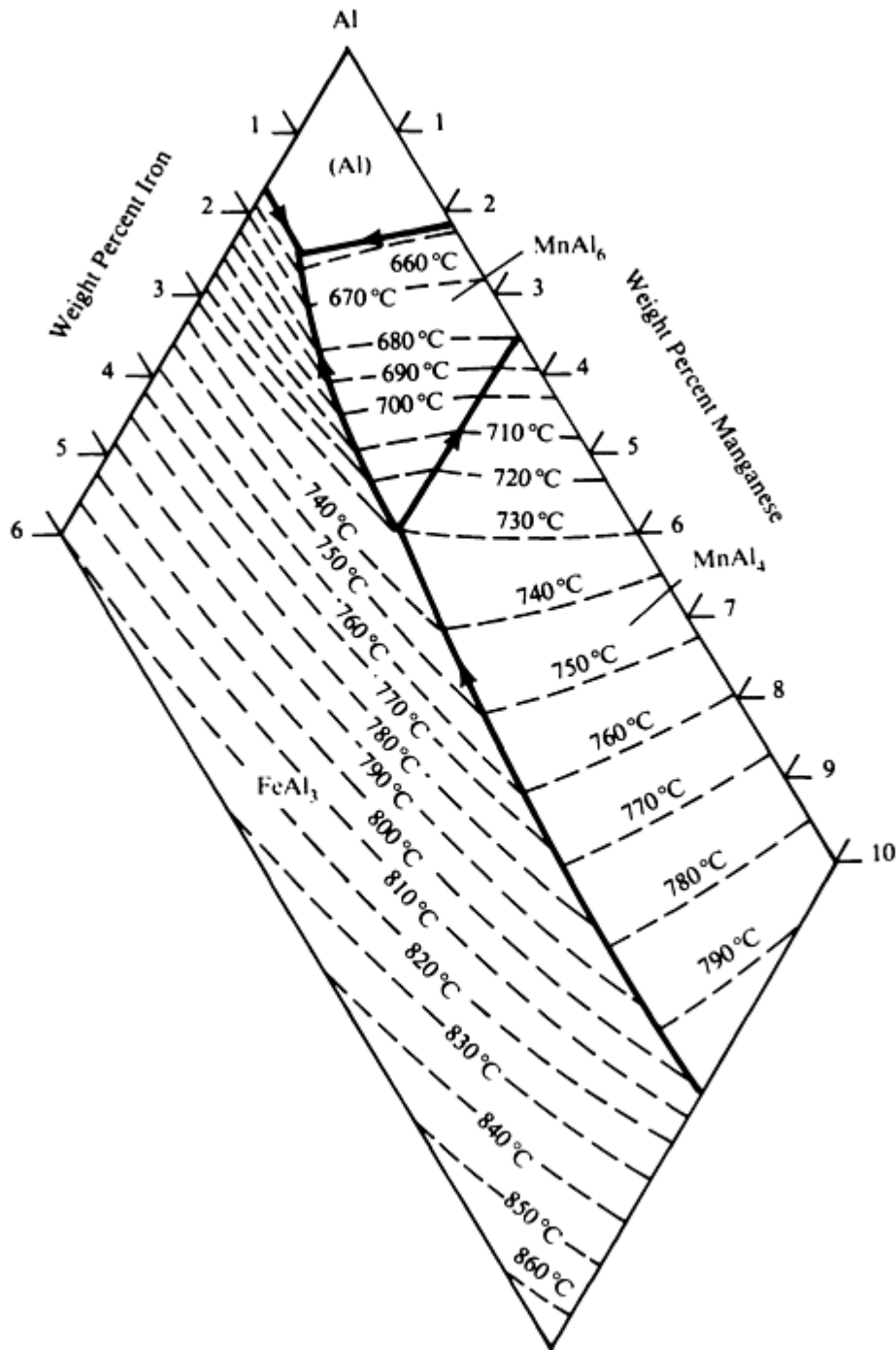

Al-Fe-Mn (Al) liquidus projection [88Ray 60].

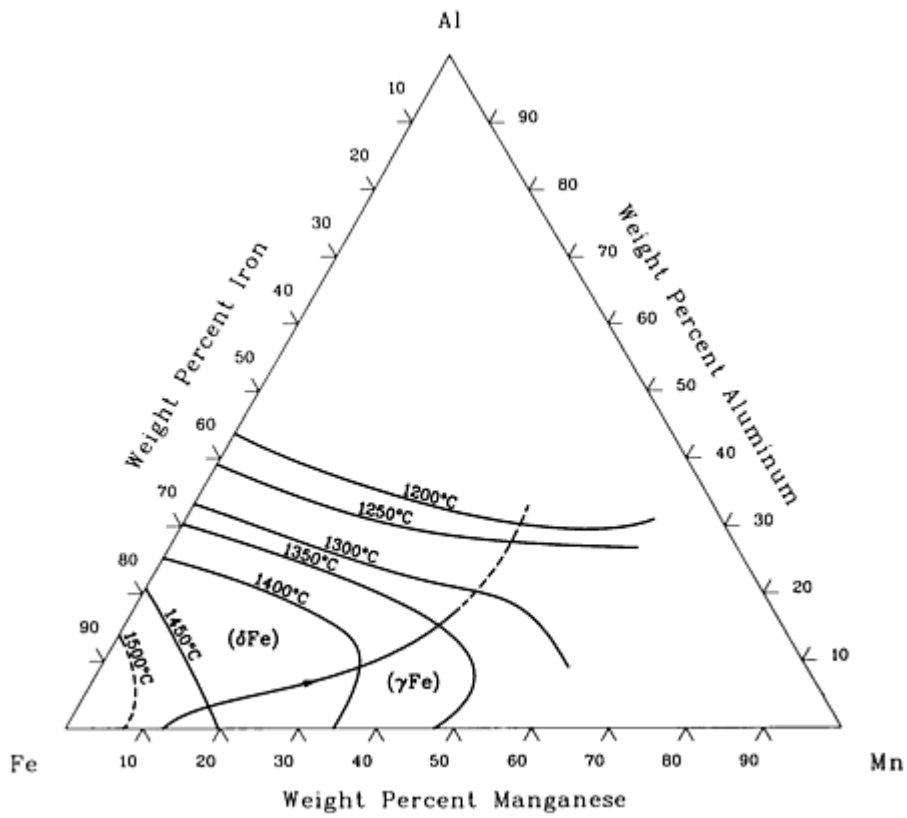

Al-Fe-Mn liquidus projection [88Ray 60].

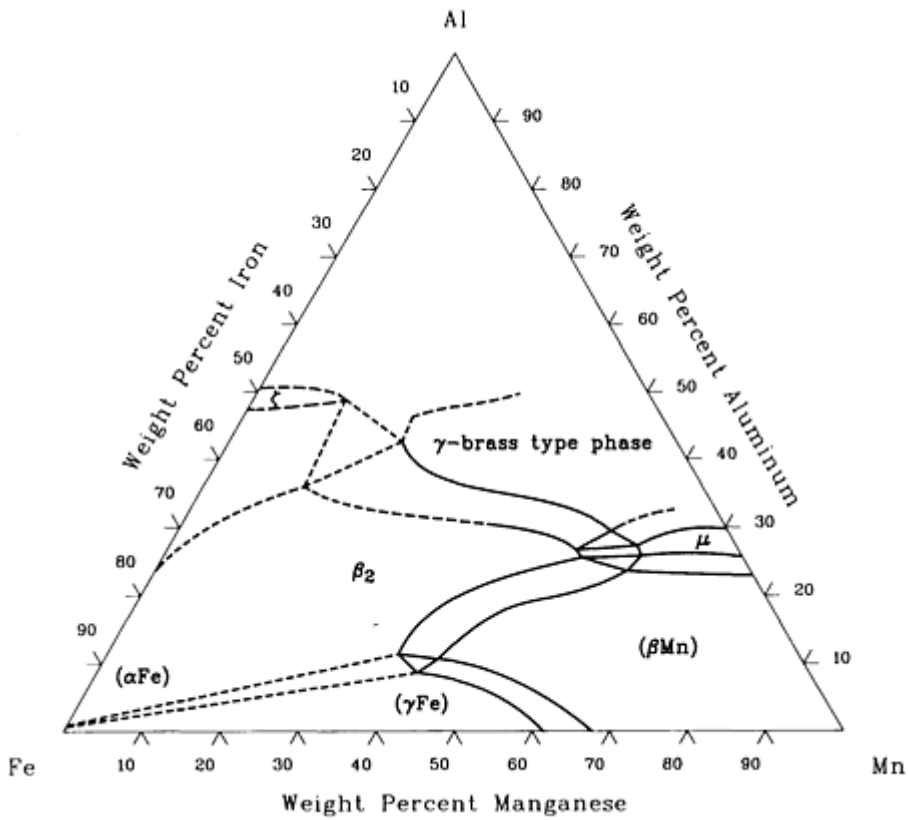

Al-Fe-Mn isothermal section at 1000 °C [88Ray 60].

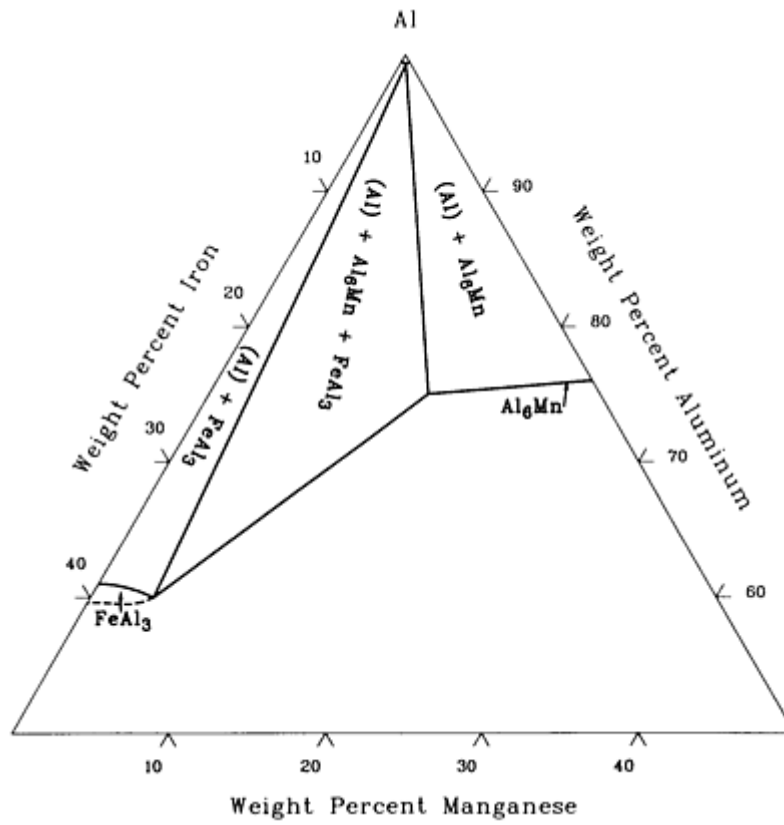

Al-Fe-Mn isothermal section at 600 °C [88Ray 60].

Reference cited in this section

88Ray: G.V. Raynor and V.G. Rivlin, *Phase Equilibria in Iron Ternary Alloys*, The Institute of Metals, London, (No. 4), 1988

Al-Fe-Ni (Aluminum - Iron - Nickel) Ternary Phase Diagrams

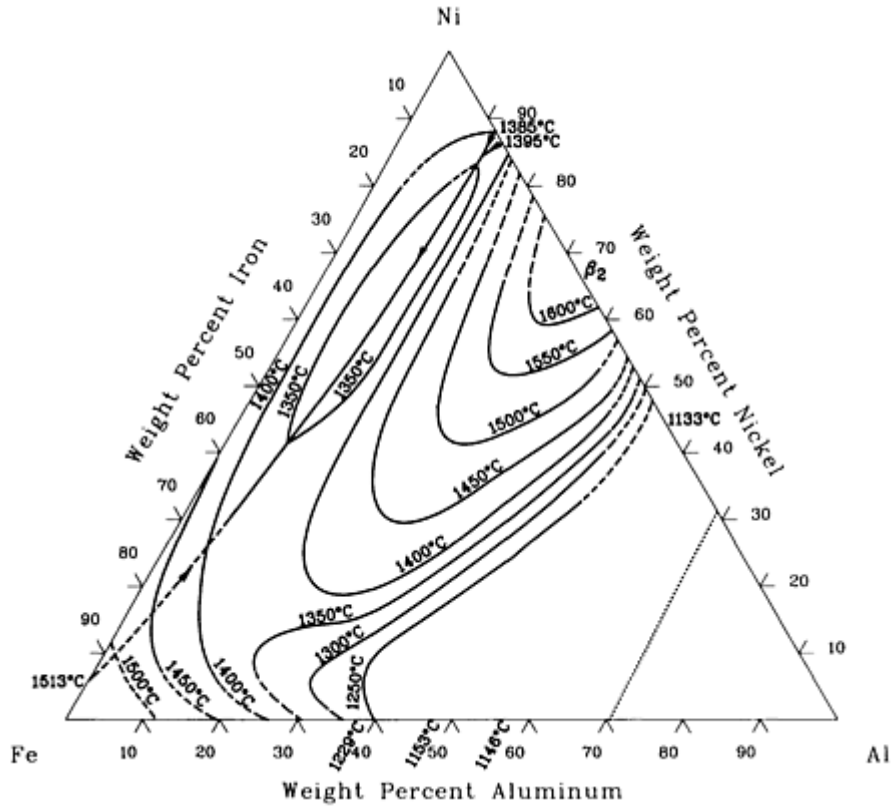

Al-Fe-Ni liquidus projection [88Ray 60].

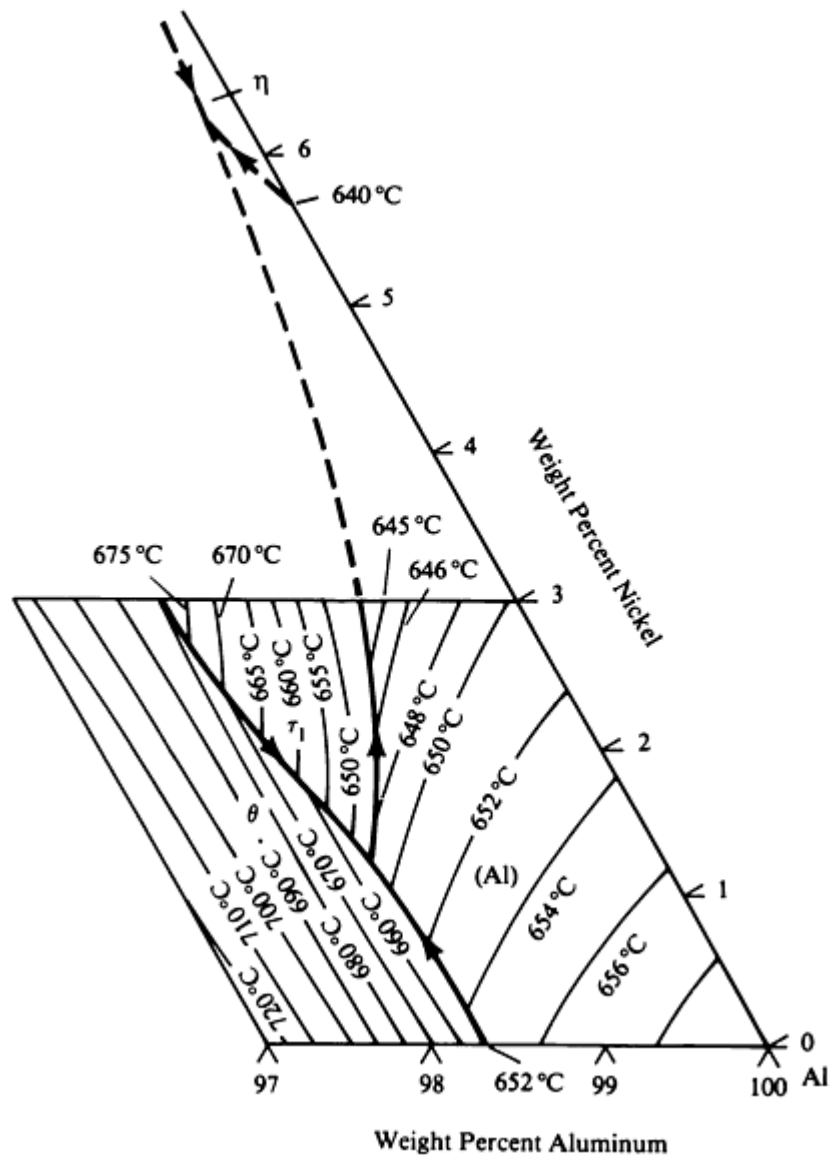

Al-Fe-Ni (Al) liquidus projection [88Ray 60].

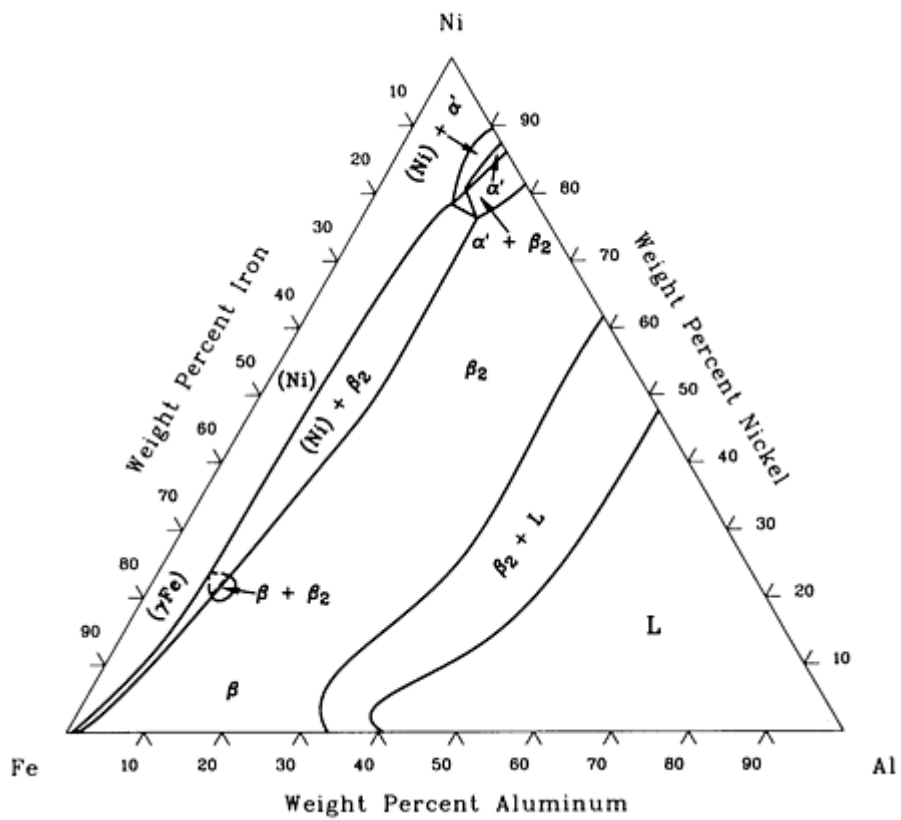

Al-Fe-Ni isothermal section at 1250 °C [88Ray 60].

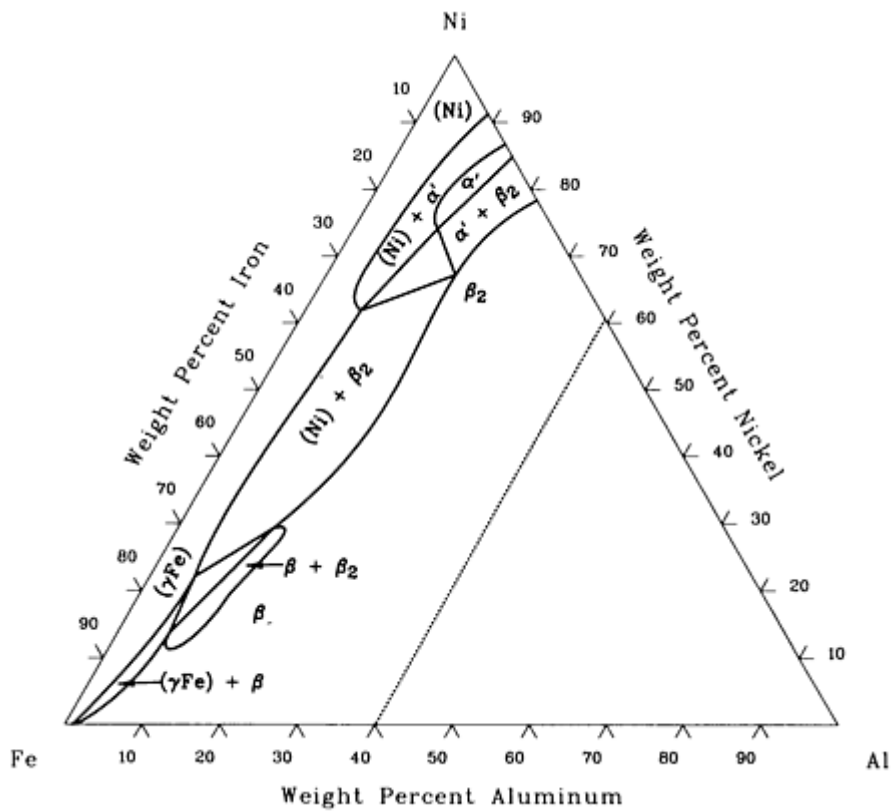

Al-Fe-Ni isothermal section at 950 °C [88Ray 60].

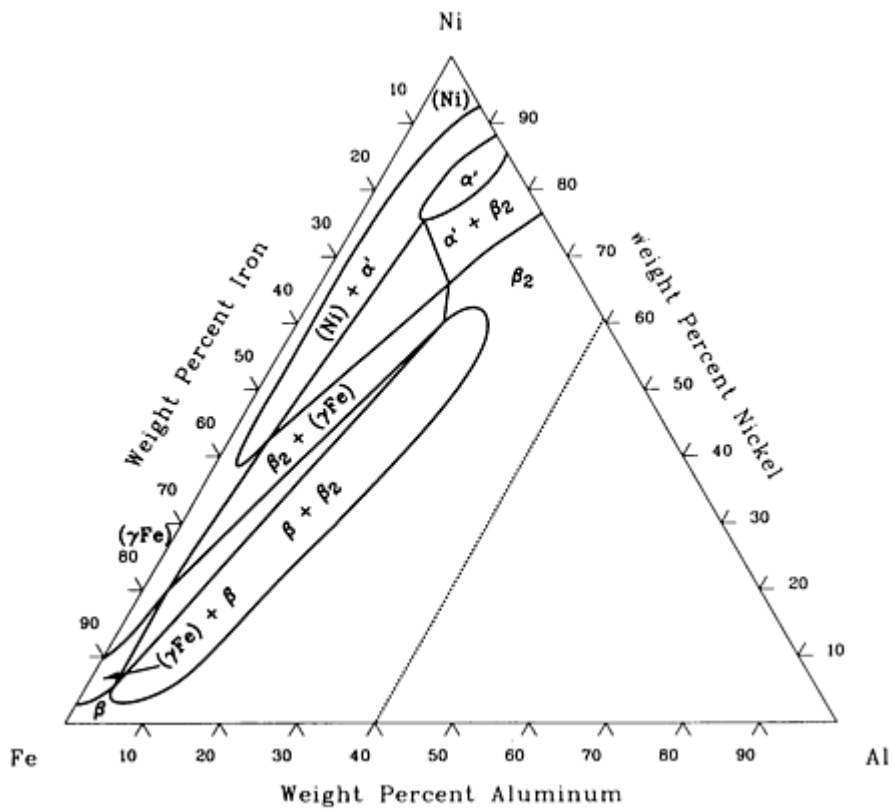

Al-Fe-Ni isothermal section at 750 °C [88Ray 60].

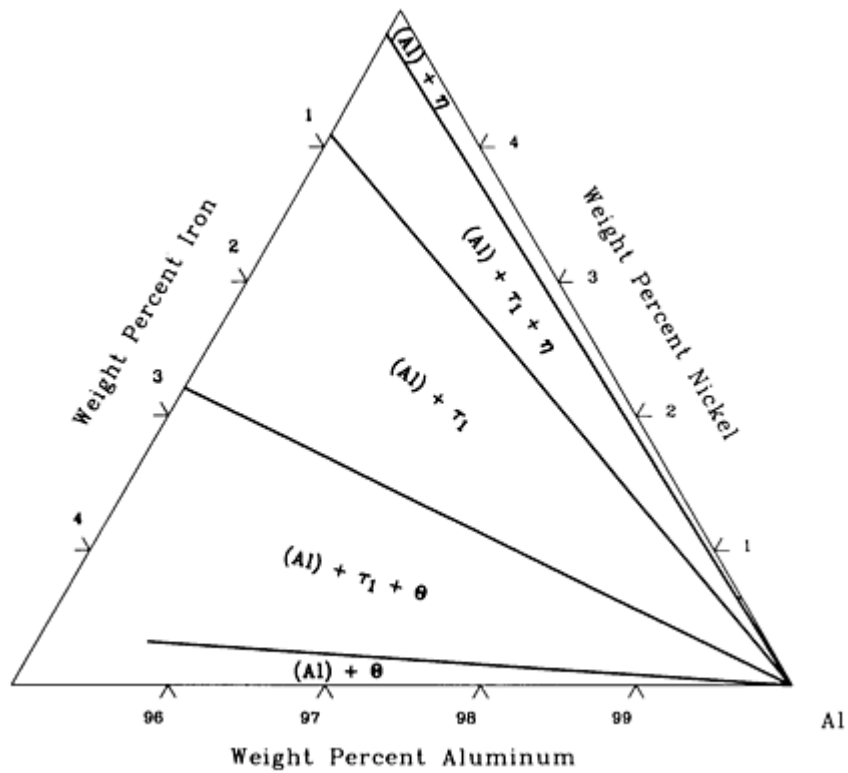

Al-Fe-Ni isothermal section at 600 °C [88Ray 60].

Reference cited in this section

88Ray: G.V. Raynor and V.G. Rivlin, *Phase Equilibria in Iron Ternary Alloys*, The Institute of Metals,

Al-Fe-Si (Aluminum - Iron - Silicon) Ternary Phase Diagrams

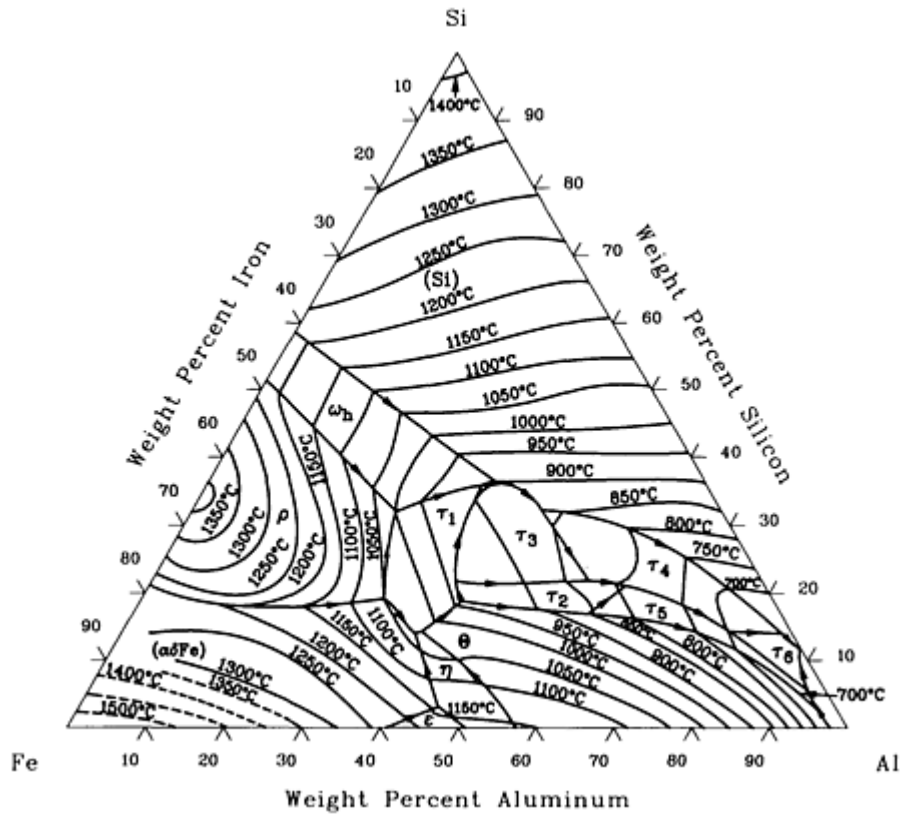

Al-Fe-Si liquidus projection [88Ray 60].

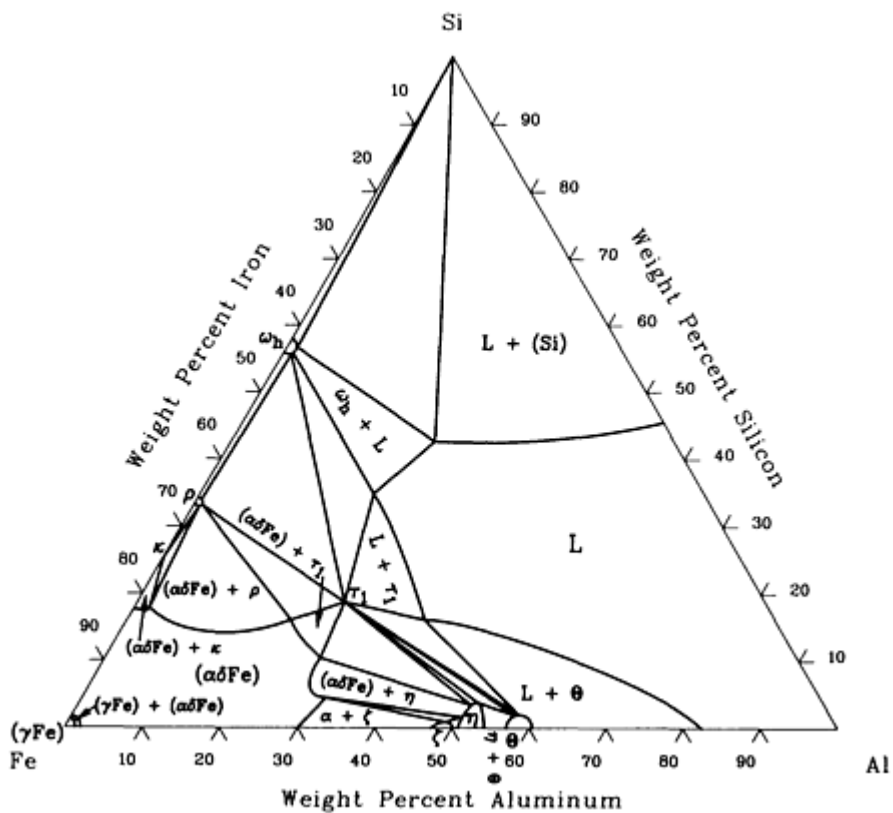

Al-Fe-Si isothermal section at 1000 °C [88Ray 60].

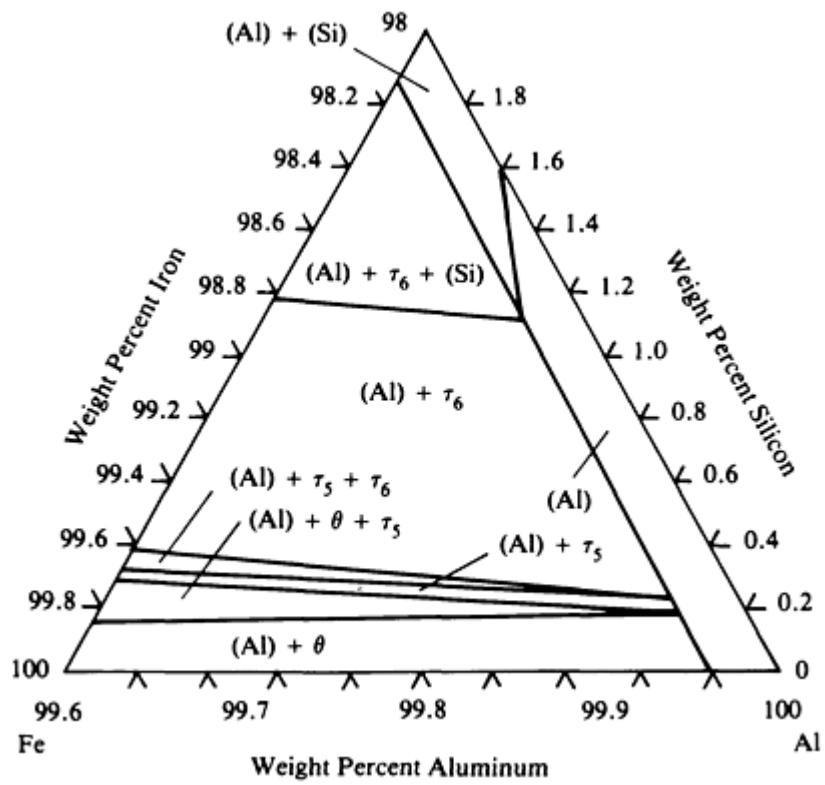

Al-Fe-Si isothermal section at 550 °C [88Ray 60].

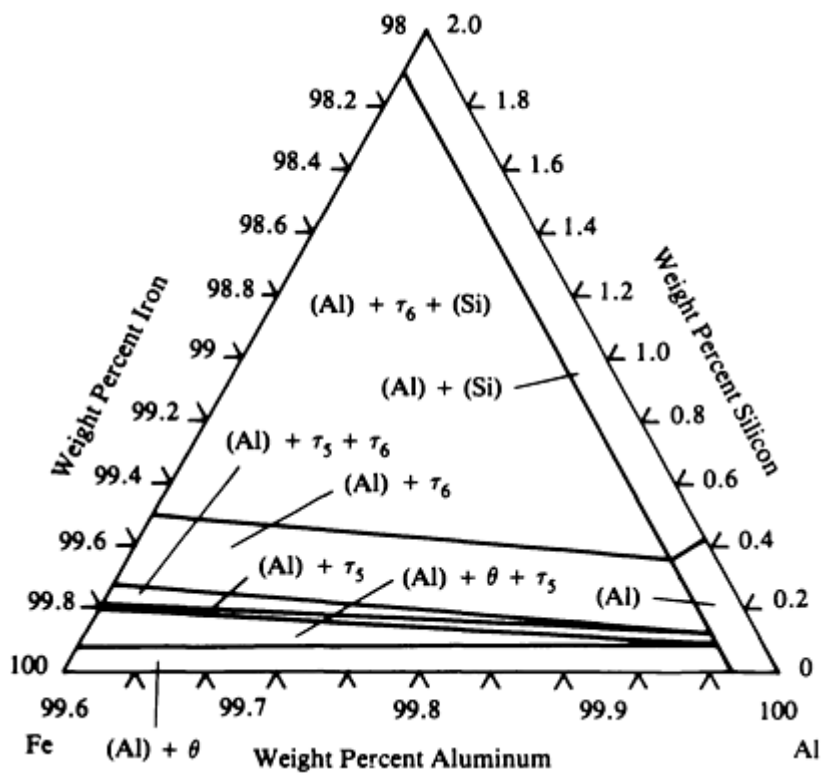

Al-Fe-Si isothermal section at 450 °C [88Ray 60].

Al-Fe-Zn (Aluminum - Iron - Zinc) Ternary Phase Diagrams

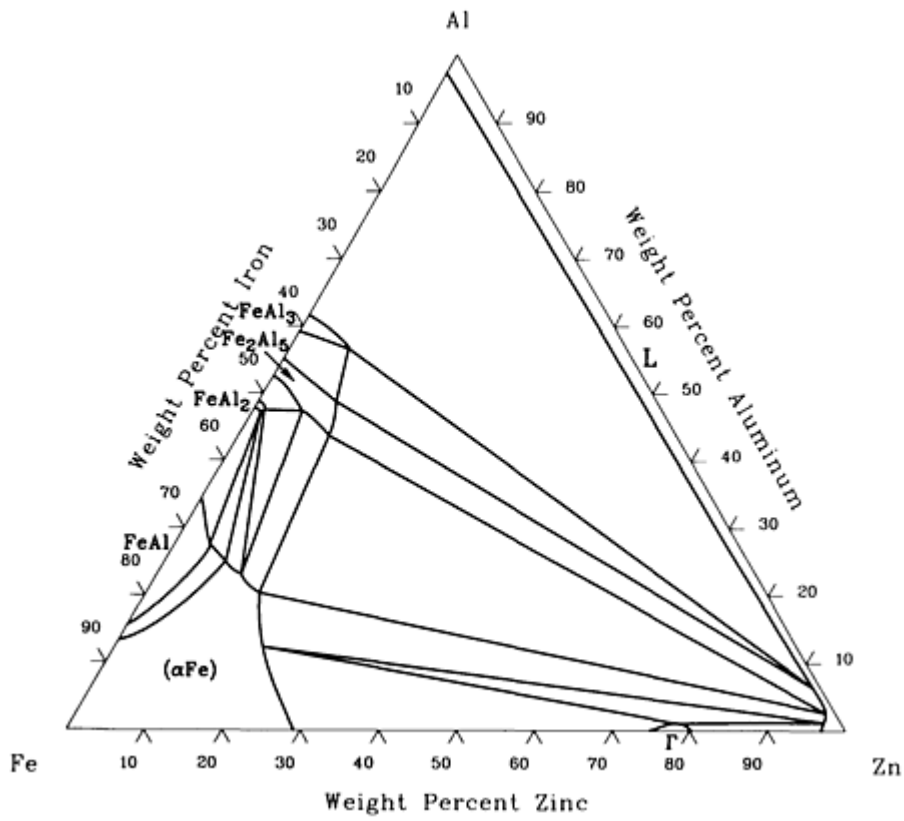

Al-Fe-Zn isothermal section at 700 °C [70Kos 24].

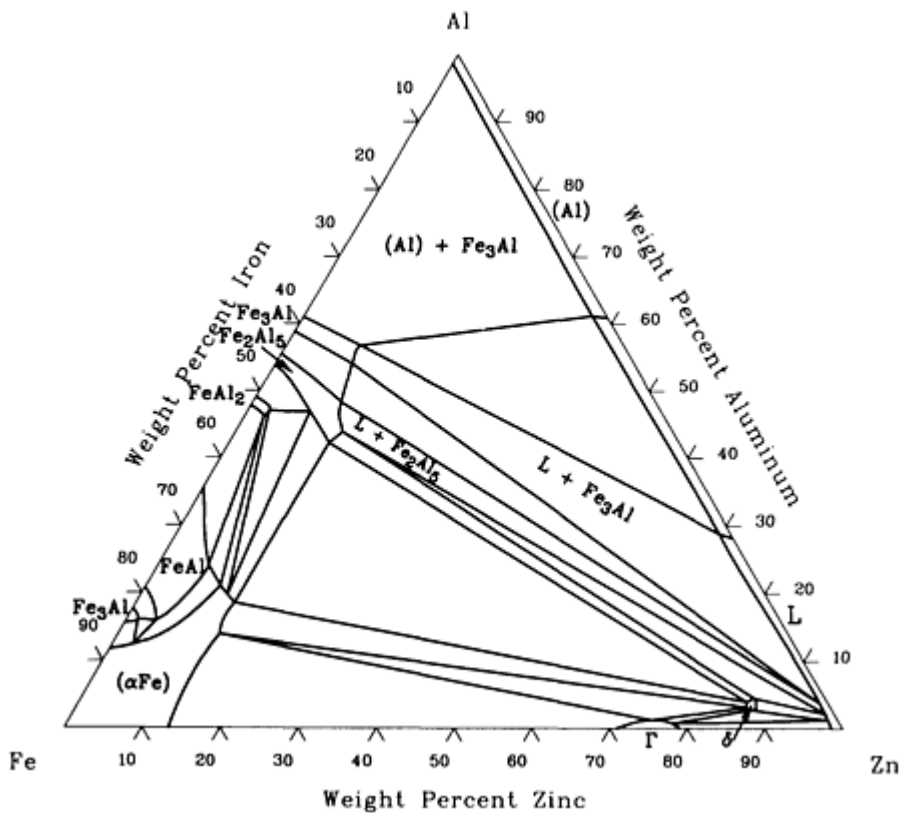

Al-Fe-Zn isothermal section at 500 °C [70Kos 24].

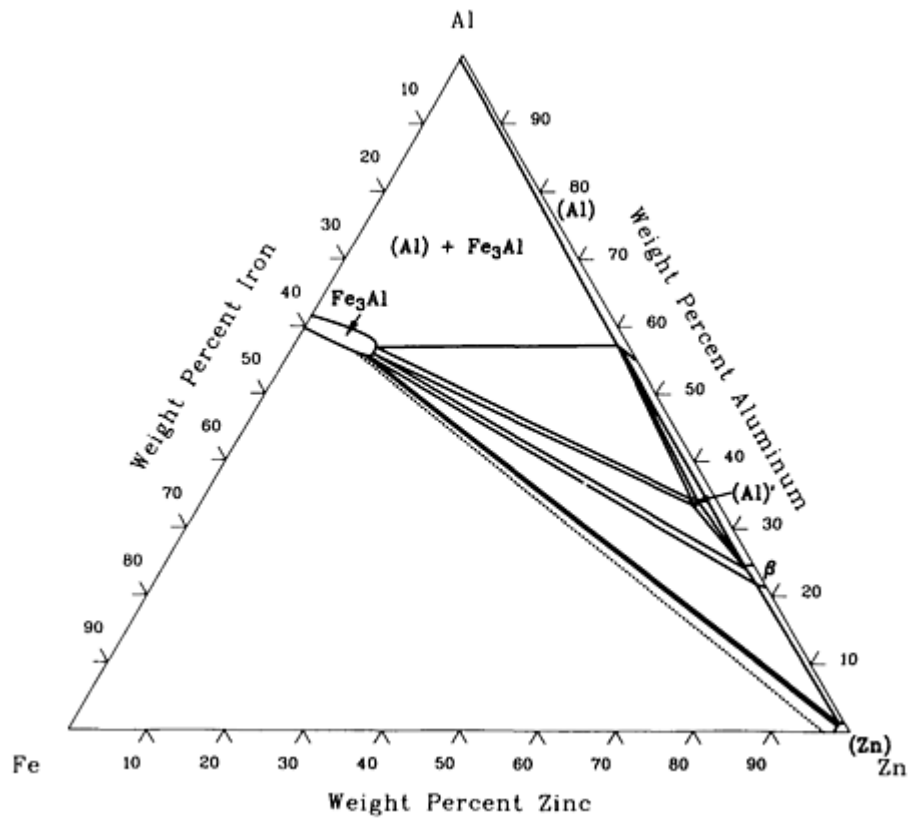

Al-Fe-Zn isothermal section at 330 °C [70Kos 24].

Reference cited in this section

70Kos: W. Köster and T. Gödecke, "Das Dreistoffsystem Eisen-Aluminum-Zink," *Z. Metallkd.*, Vol 61, 1970, p 649-658

Al-Mg-Mn (Aluminum - Magnesium - Manganese) Ternary Phase Diagrams

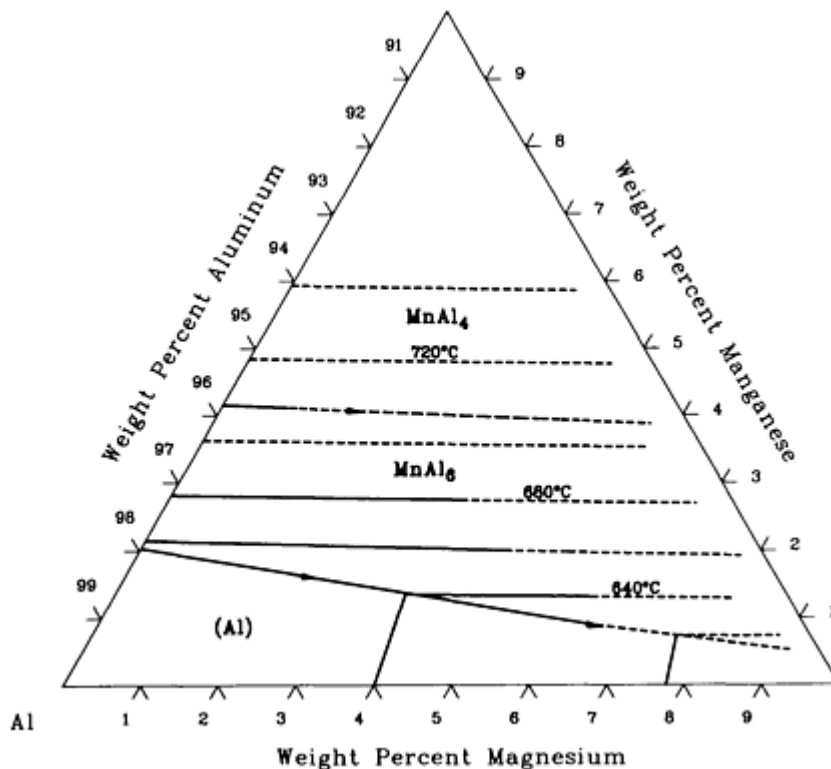

Al-Mg-Mn liquidus projection [73Wil 34].

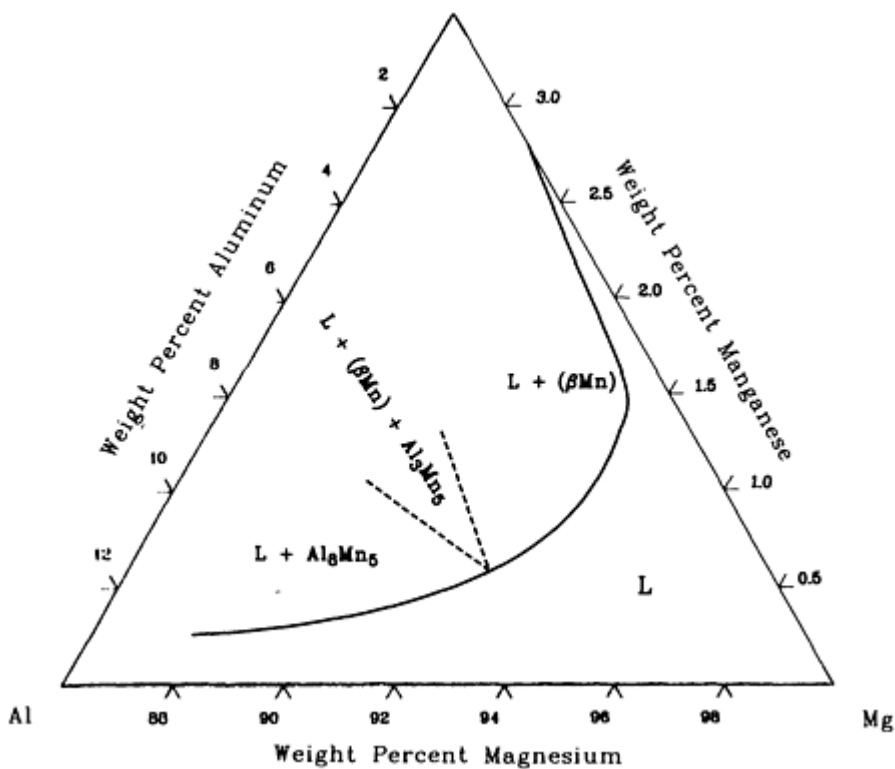

Al-Mg-Mn isothermal section at 750 °C [88Sim 62].

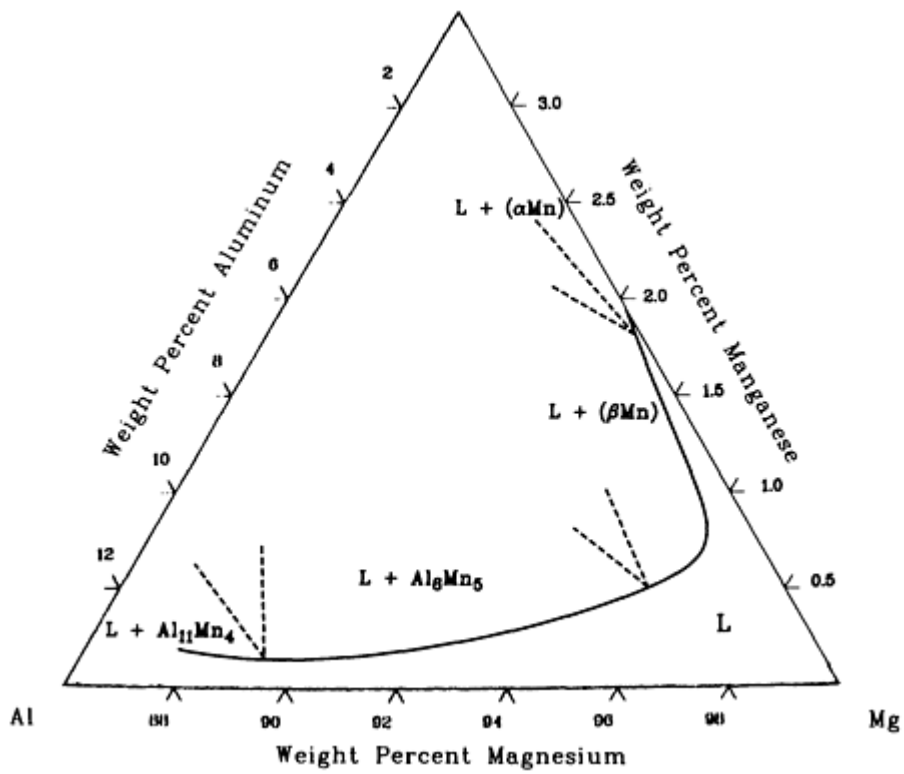

Al-Mg-Mn isothermal section at 670 °C [88Sim 62].

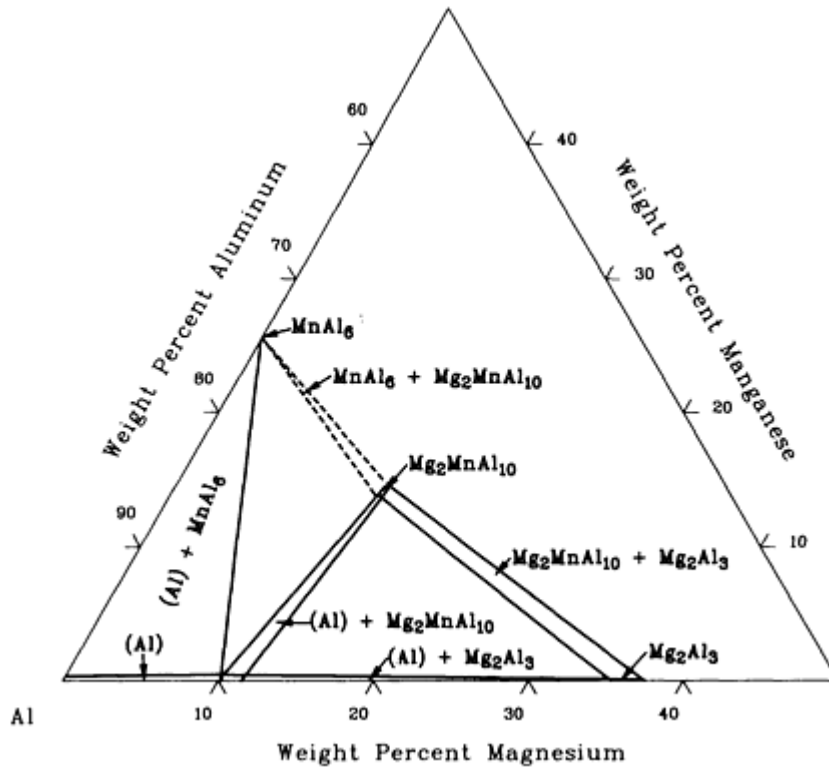

Al-Mg-Mn isothermal section at 400 °C [73Wil 34].

References cited in this section

73Wil: L.A. Willey, *Metallography, Structures and Phase Diagrams*, Vol 8, *Metals Handbook*, 8th ed., American Society for Metals, Metals Park, OH 1973

88Sim: C.J. Simensen, B.C. Oberländer, J. Svalestuen, and A. Thornvaldsen, "The Phase Diagram for Magnesium-Aluminum-Manganese Above 650 °C," *Z. Metallkd.*, Vol 79 (No. 11), 1988, p 696-699

Al-Mg-Si (Aluminum - Magnesium - Silicon) Ternary Phase Diagrams

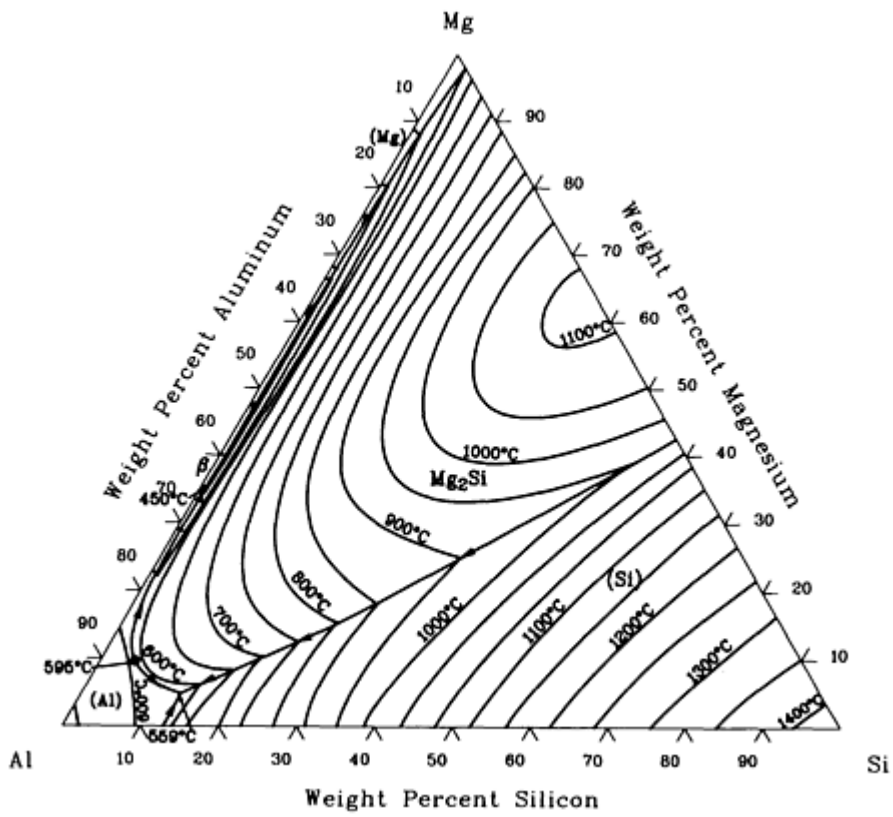

Al-Mg-Si liquidus projection [73Wil 34].

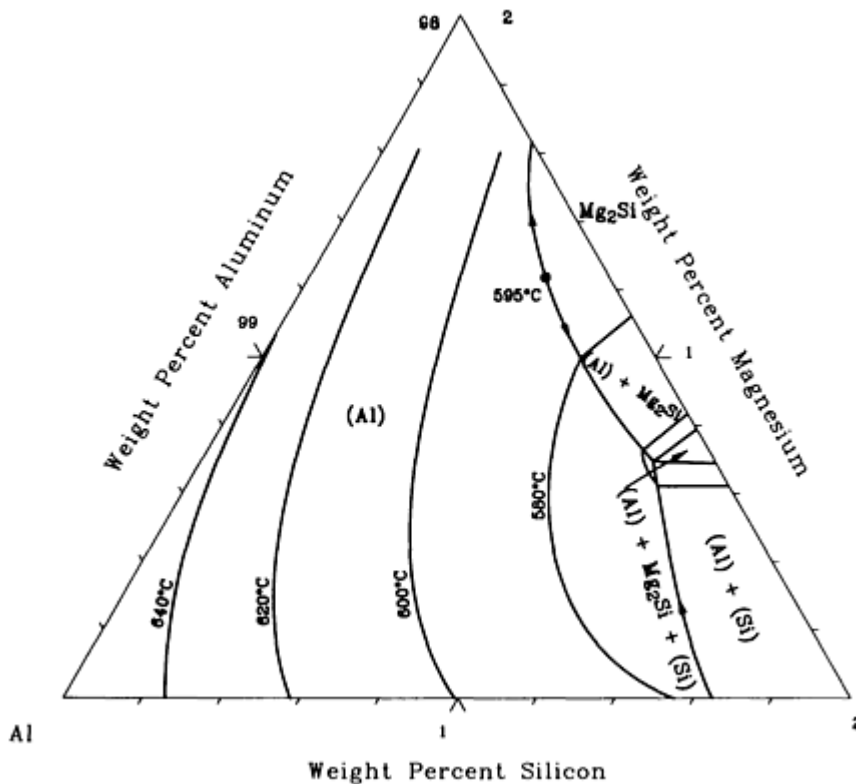

Al-Mg-Si solidus projection [73Wil 34].

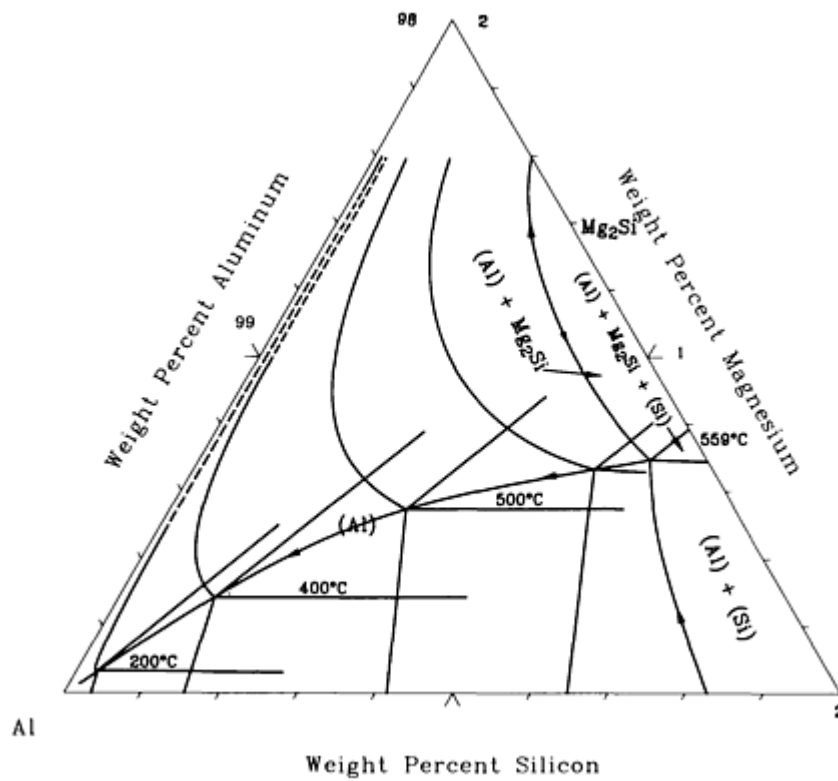

Al-Mg-Si solvus projection [73Wil 34].

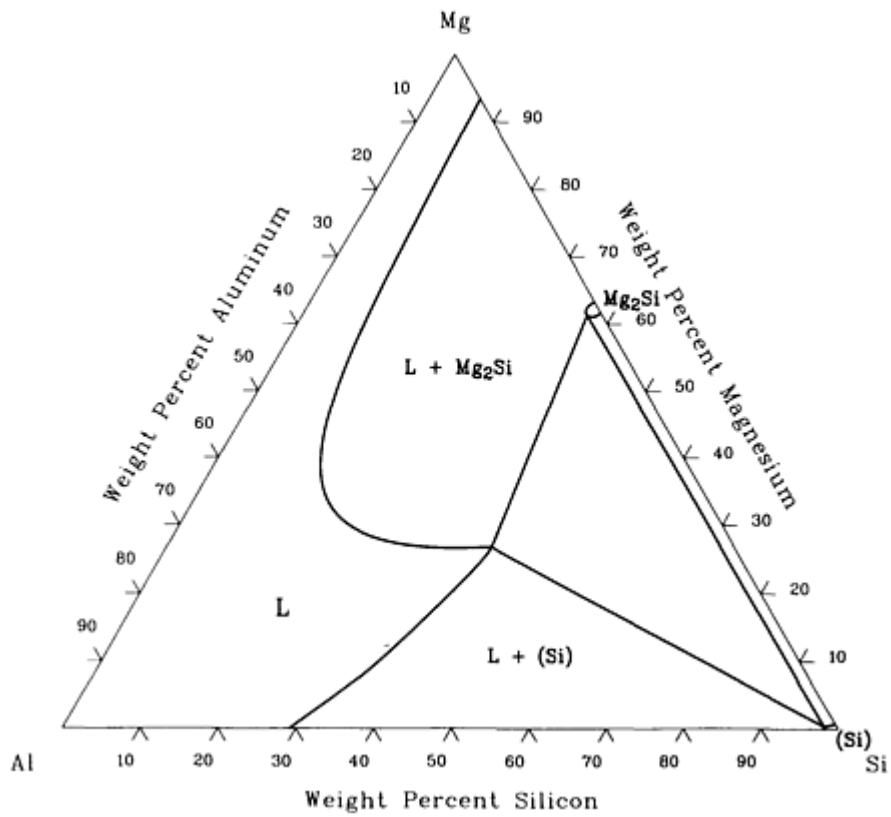

Al-Mg-Si isothermal section at 800 °C [88Rok 61].

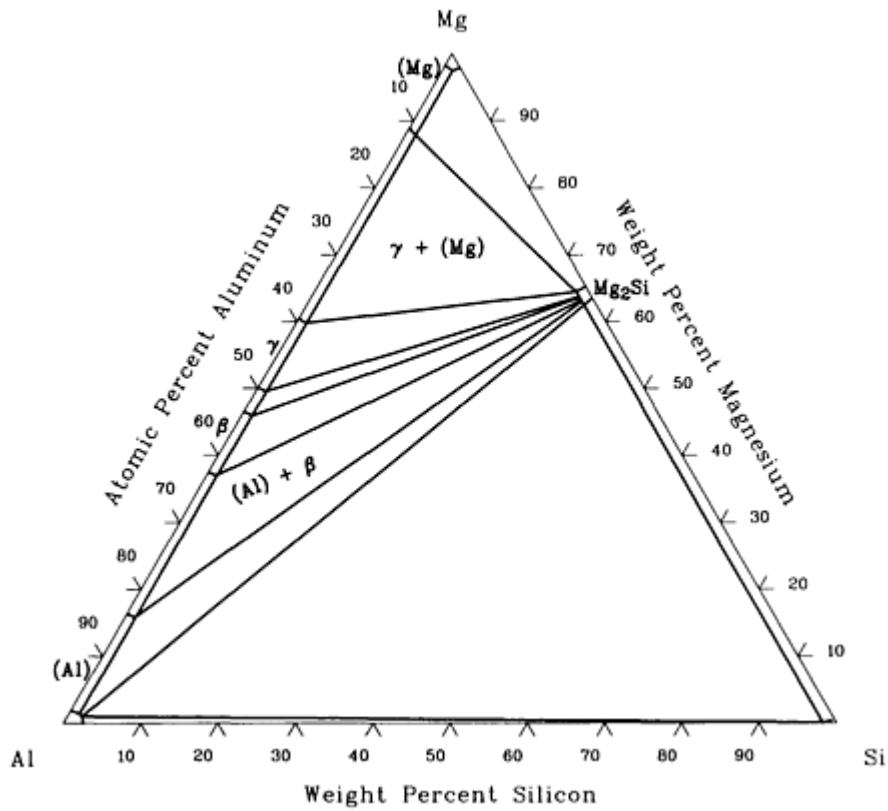

Al-Mg-Si isothermal section at 430 °C [88Rok 61].

References cited in this section

73Wil: L.A. Willey, *Metallography, Structures and Phase Diagrams*, Vol 8, *Metals Handbook*, 8th ed., American Society for Metals, Metals Park, OH 1973

88Rok: L.L. Rokhlin and A.G. Pepelyan, "Phase Equilibria in the Mg-Rich Region of the Mg-Al-Si System," *Russ. Metall.*, Tr: *Izv. Akad. Nauk SSSR, Met.*, (No. 6), 1988, p 172-174

Al-Mg-Zn (Aluminum - Magnesium - Zinc) Ternary Phase Diagrams

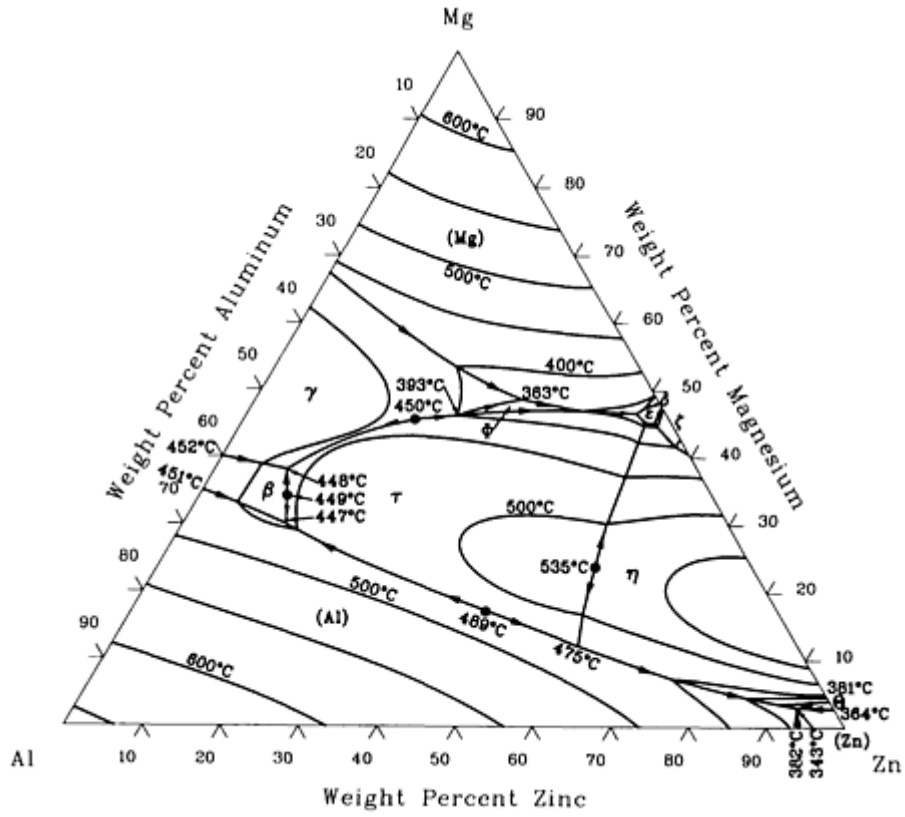

Al-Mg-Zn liquidus projection [73Wil 34].

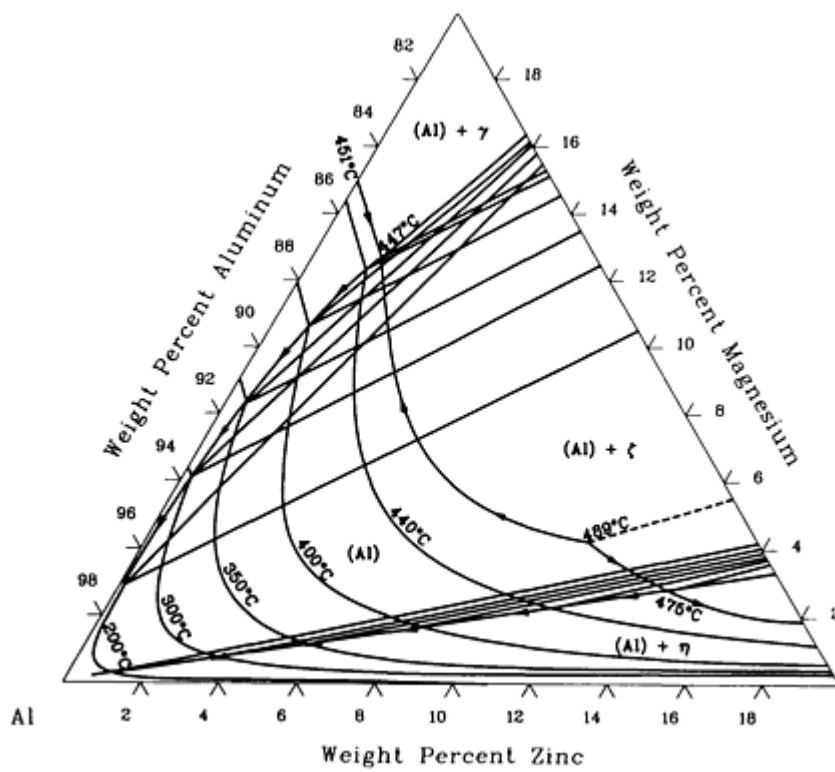

Al-Mg-Zn solvus projection [73Wil 34].

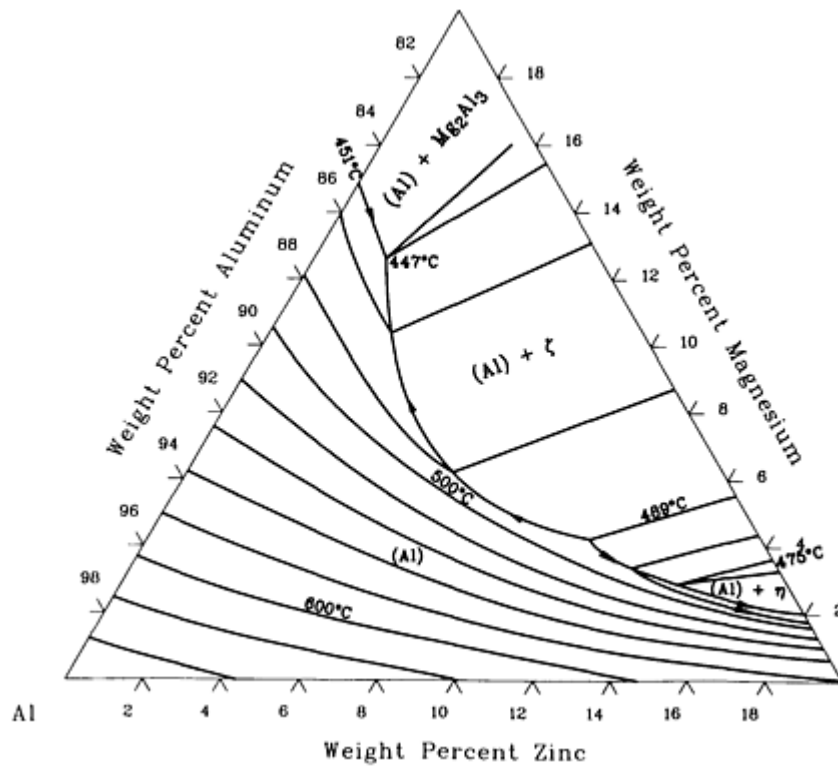

Al-Mg-Zn solidus projection [73Wil 34].

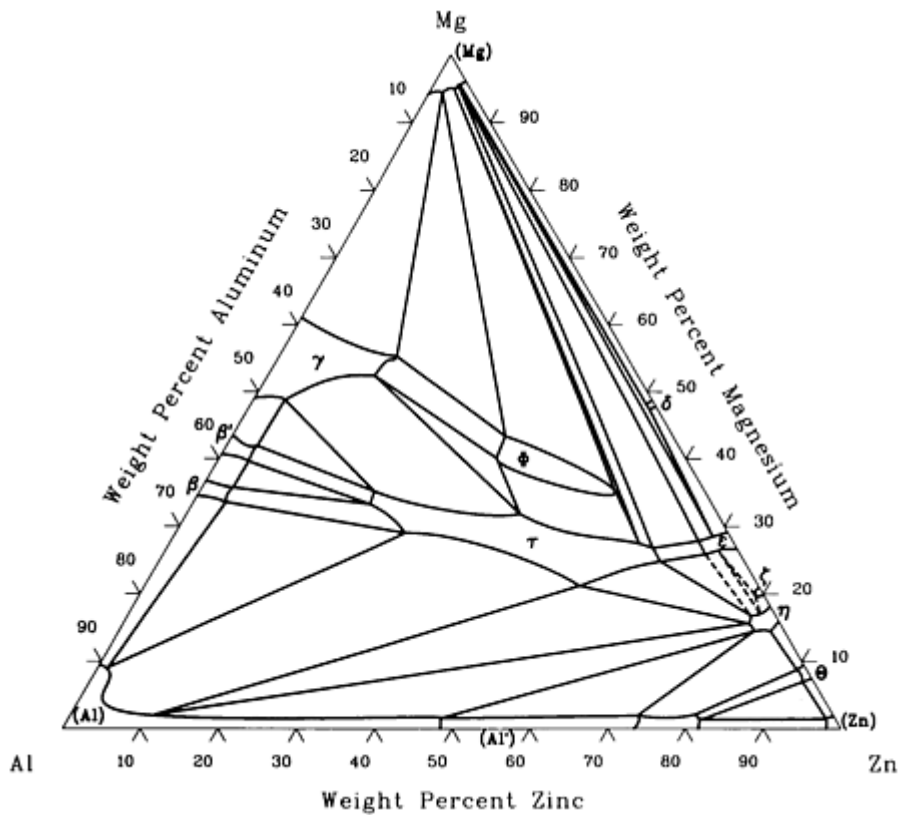

Al-Mg-Zn isothermal section at 335 °C [73Wil 34].

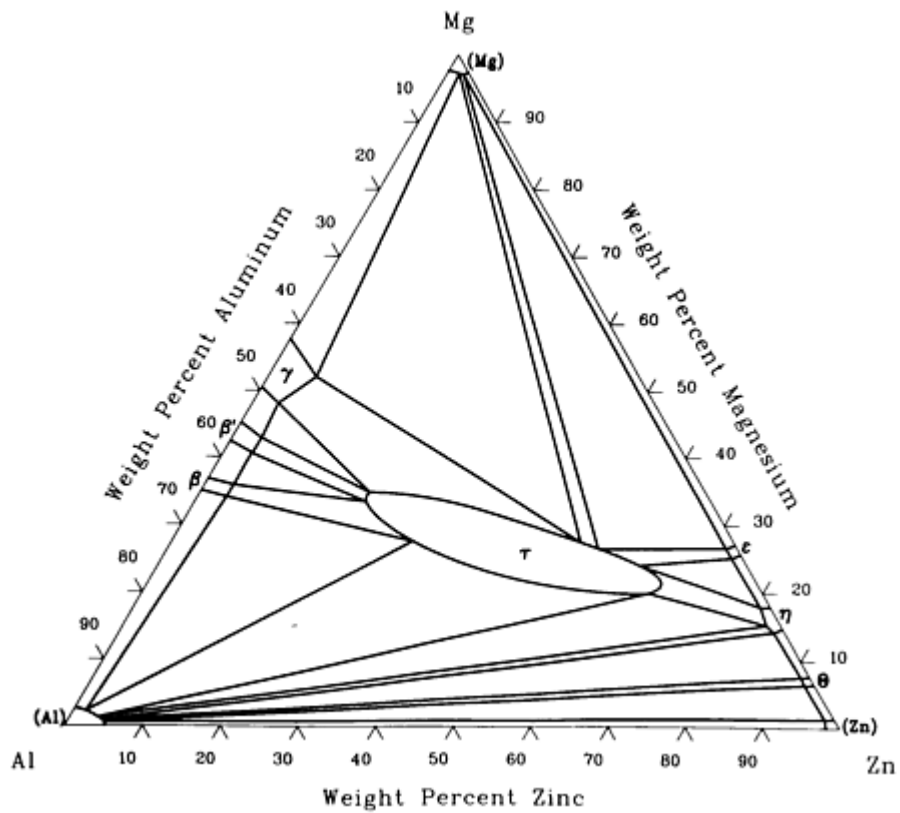

Al-Mg-Zn isothermal section at 20 °C [36Kos 3].

References cited in this section

36Kos: W. Köster and W. Dullenkopf, "Das Dreistoffsystem Aluminium-Magnesium-Zink. III. Der Teilbereich $\text{Mg}-\text{Al}_3\text{Mg}_4-\text{Al}_2\text{Mg}_3\text{Zn}_3-\text{MgZn}_2-\text{Mg}$," *Z. Metallkd.*, Vol 28, 1936, p 363-367

73Wil: L.A. Willey, *Metallography, Structures and Phase Diagrams*, Vol 8, *Metals Handbook*, 8th ed., American Society for Metals, Metals Park, OH 1973

Al-Mn-Si (Aluminum - Manganese - Silicon) Ternary Phase Diagrams

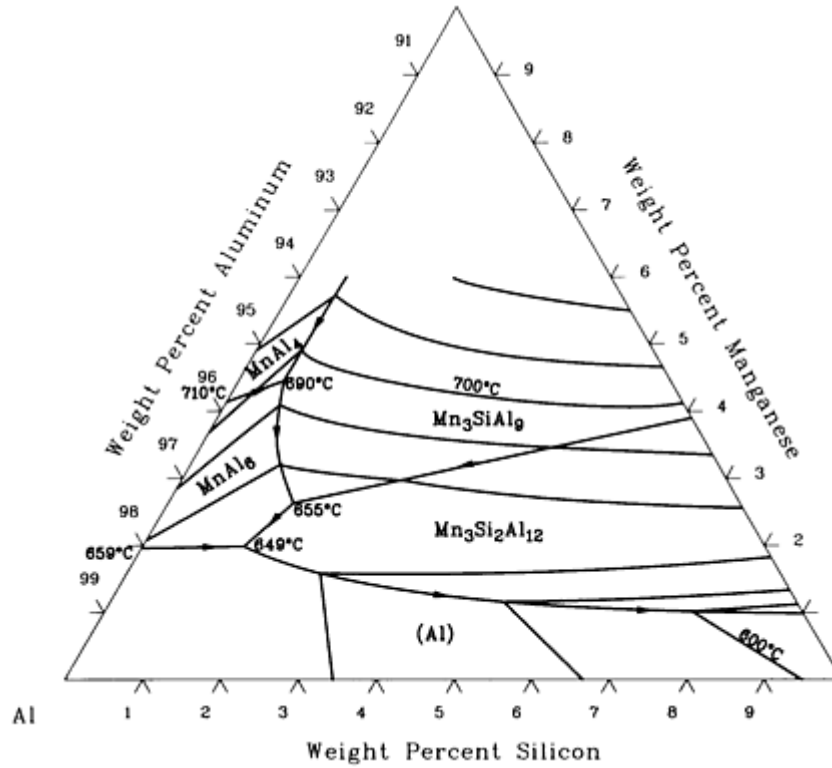

Al-Mn-Si liquidus projection [73Wil 34].

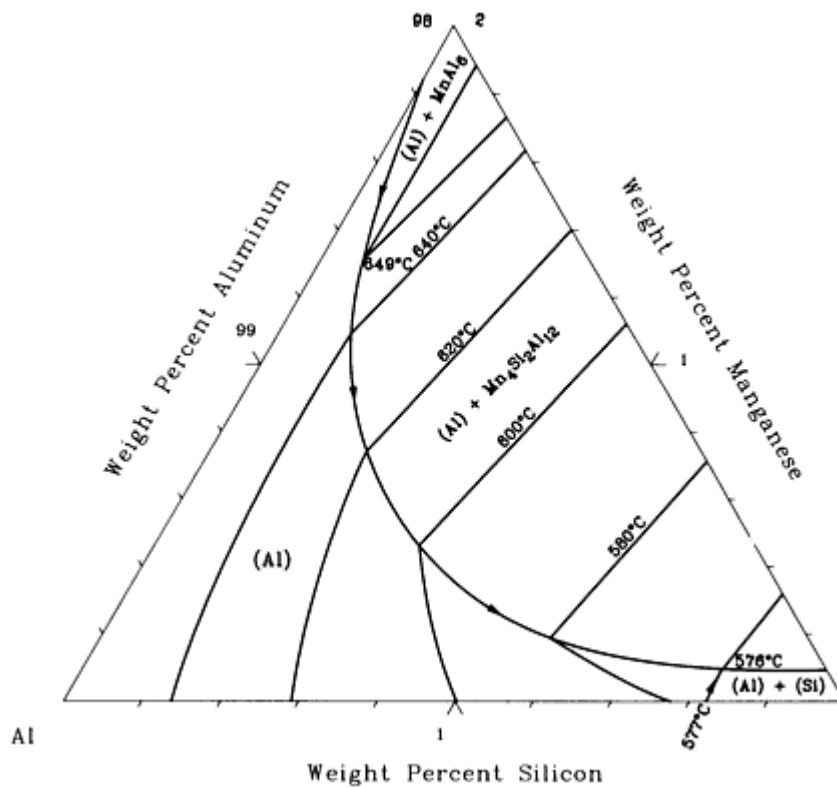

Al-Mn-Si solidus projection [73Wil 34].

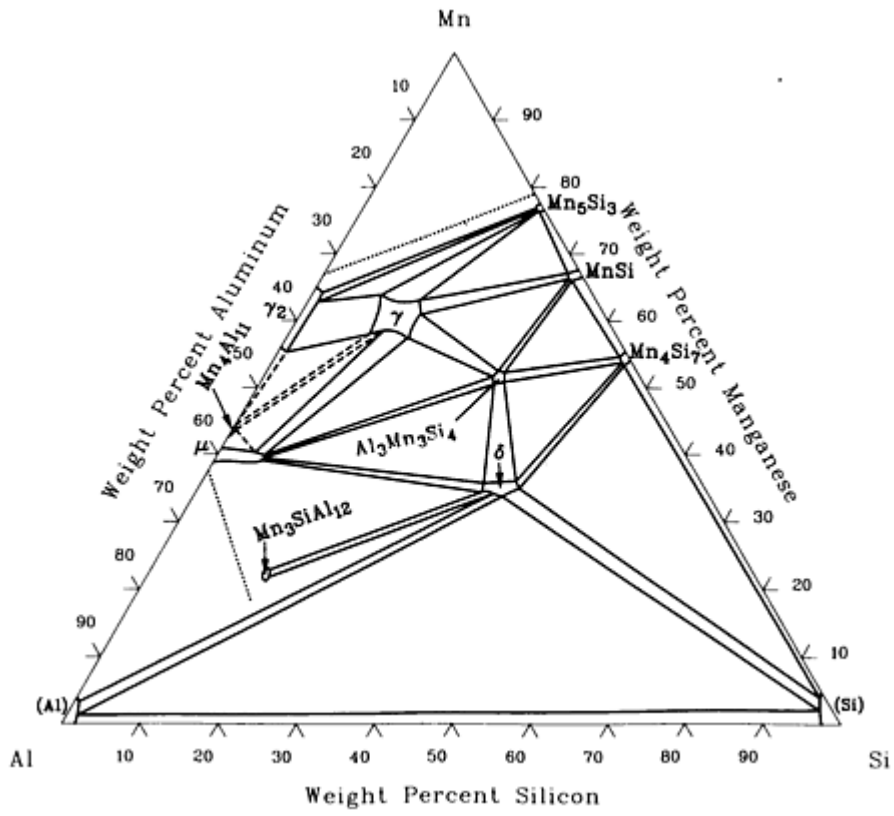

Al-Mn-Si isothermal section at 800 °C [64Kus 17].

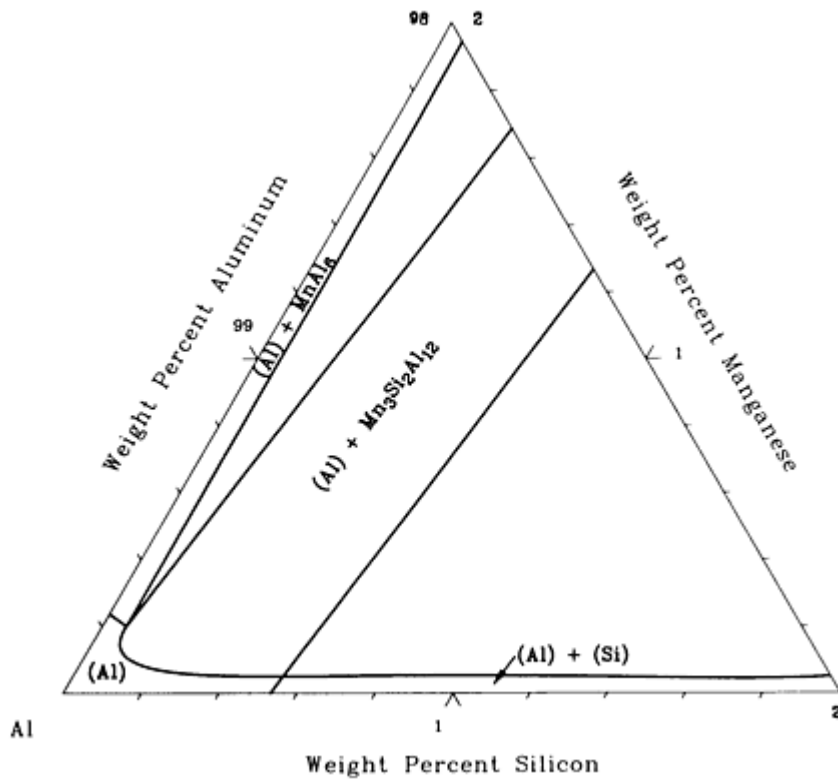

Al-Mn-Si isothermal section at 460 °C [73Wil 34].

References cited in this section

64Kus: J.B. Kusma and H. Nowotny, "Untersuchungen im Dreistoff: Mn-Al-Si," *Monatsh. Chem.*, Vol 95, 1964, p 1266-1271

73Wil: L.A. Willey, *Metallography, Structures and Phase Diagrams*, Vol 8, *Metals Handbook*, 8th ed., American Society for Metals, Metals Park, OH 1973

Al-Mo-Ni (Aluminum - Molybdenum - Nickel) Ternary Phase Diagrams

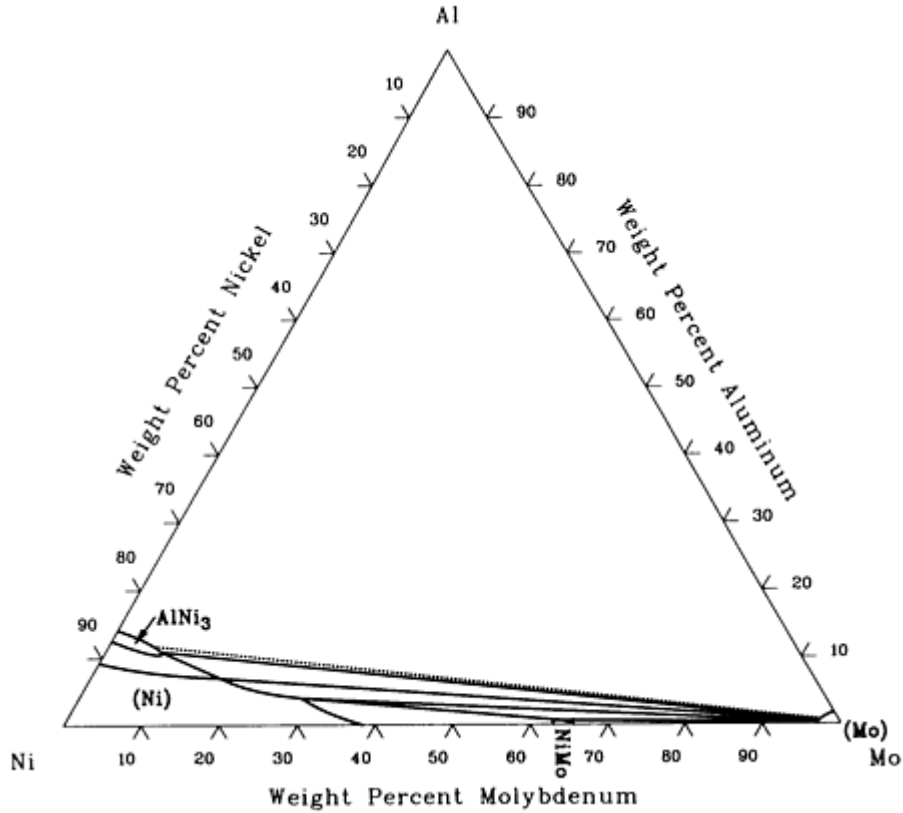

Al-Mo-Ni isothermal section at 1260 °C [84Mir 46].

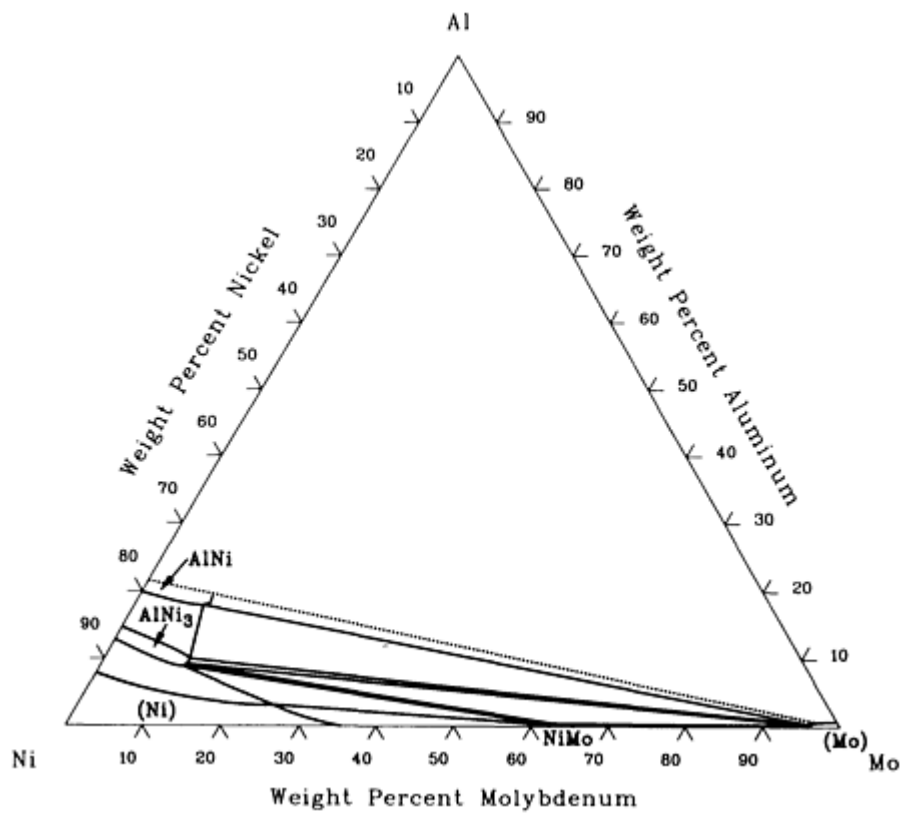

Al-Mo-Ni isothermal section at 1093 °C [84Mir 46].

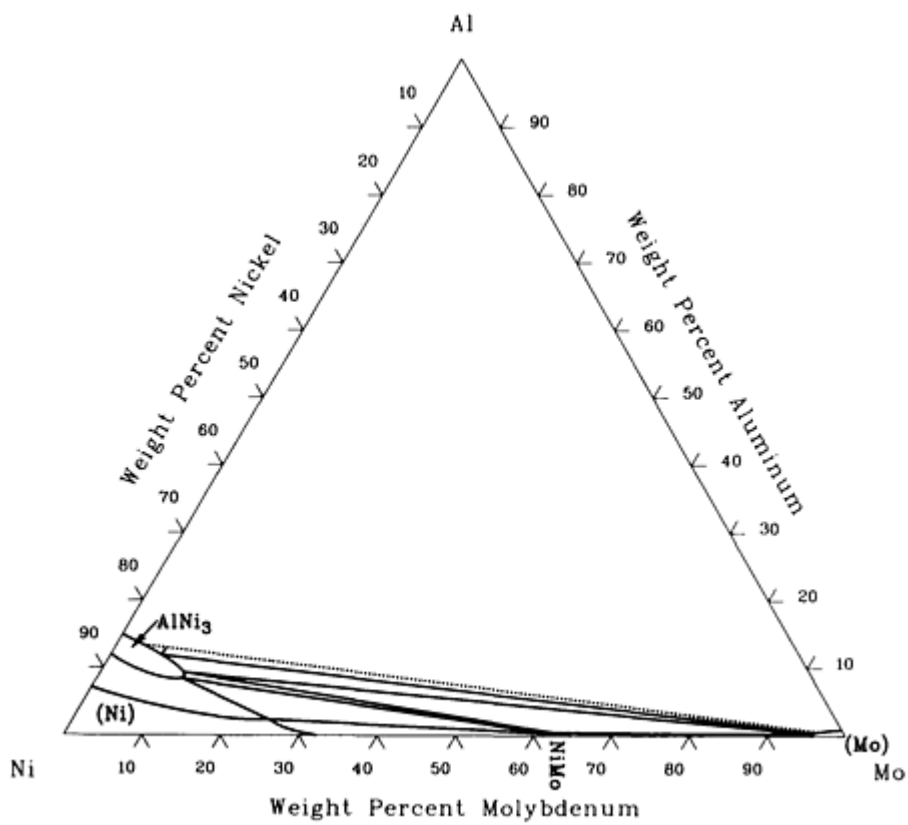

Al-Mo-Ni isothermal section at 927 °C [84Mir 46].

Reference cited in this section

46. **84Mir:** D.B. Miracle, K.A. Lark, V. Srinivasan, and H.A. Lipsitt, "Nickel-Aluminium-Molybdenum Phase Equilibria," *Metall. Trans. A*, Vol 15, 1984, p 481-486

Al-Mo-Ti (Aluminum - Molybdenum - Titanium) Ternary Phase Diagrams

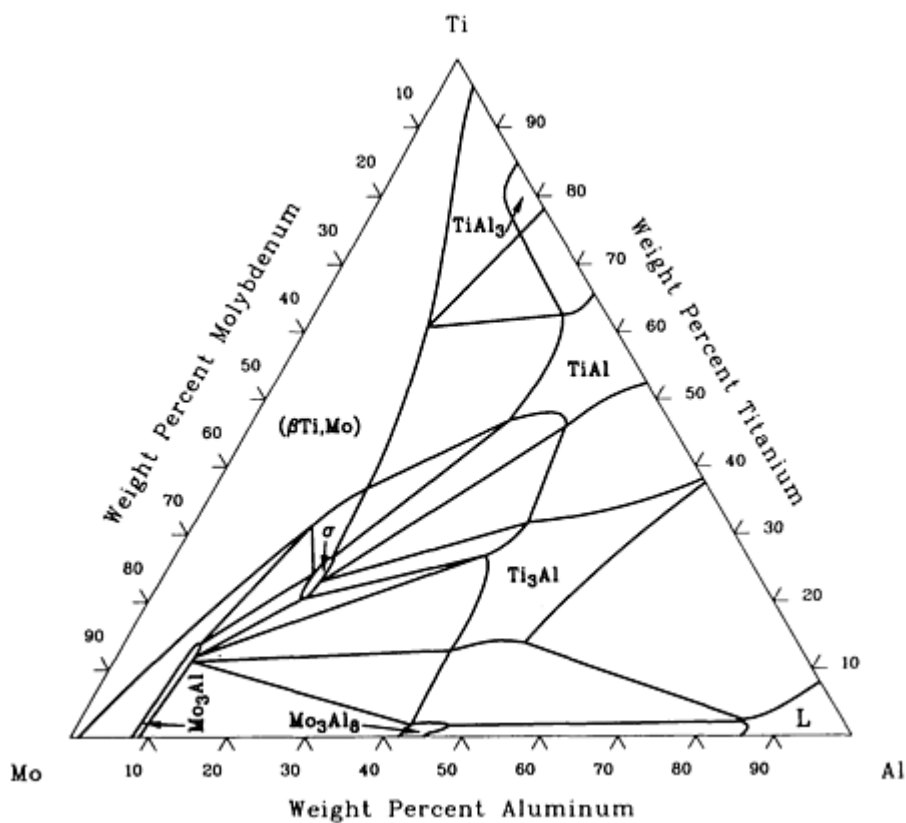

Al-Mo-Ti isothermal section at 925 °C [70Han 23].

Reference cited in this section

70Han: R.C. Hansen and A. Raman, "Alloy Chemistry of sigma (beta-U)-Related Phases. III. sigma-Phases with Non-Transition Elements," *Z. Metallkd.*, Vol 61, 1970, p 115-120

Al-Ni-Ti (Aluminum - Nickel - Titanium) Ternary Phase Diagrams

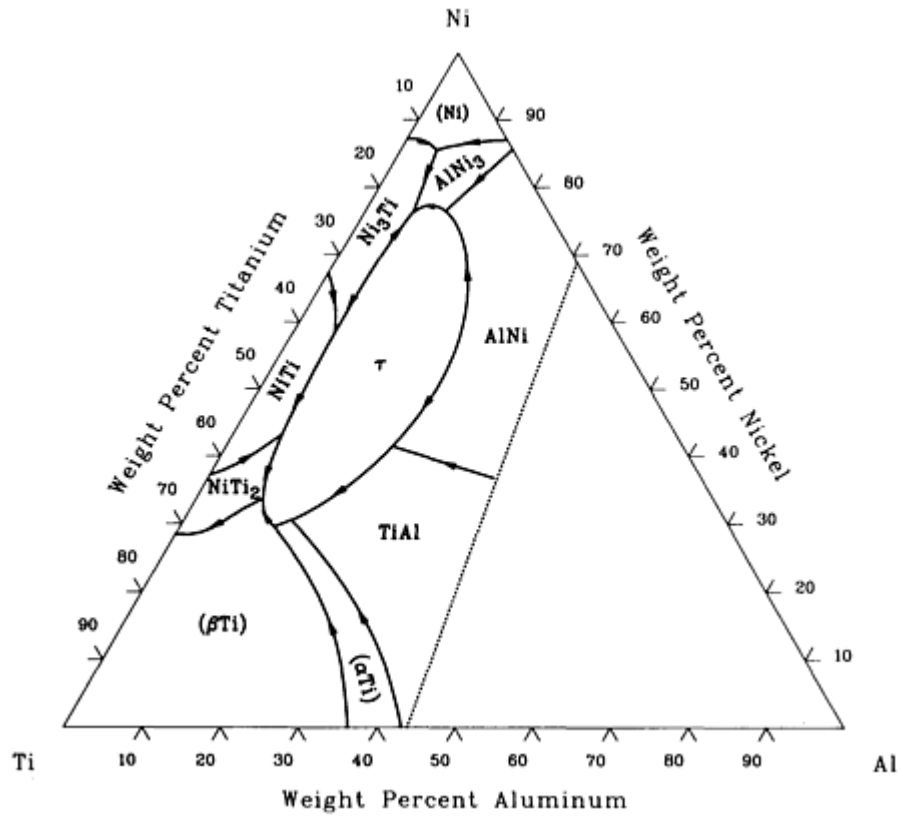

Al-Ni-Ti liquidus projection [85Nas 48].

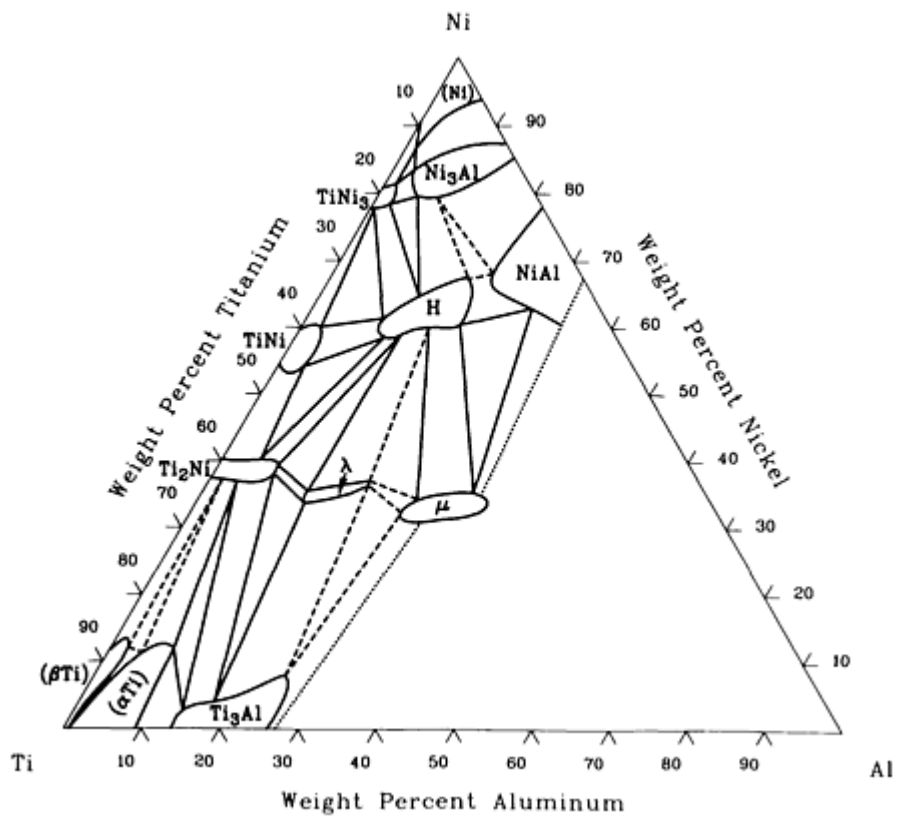

Al-Ni-Ti isothermal section at 900 °C [85Nas 48].

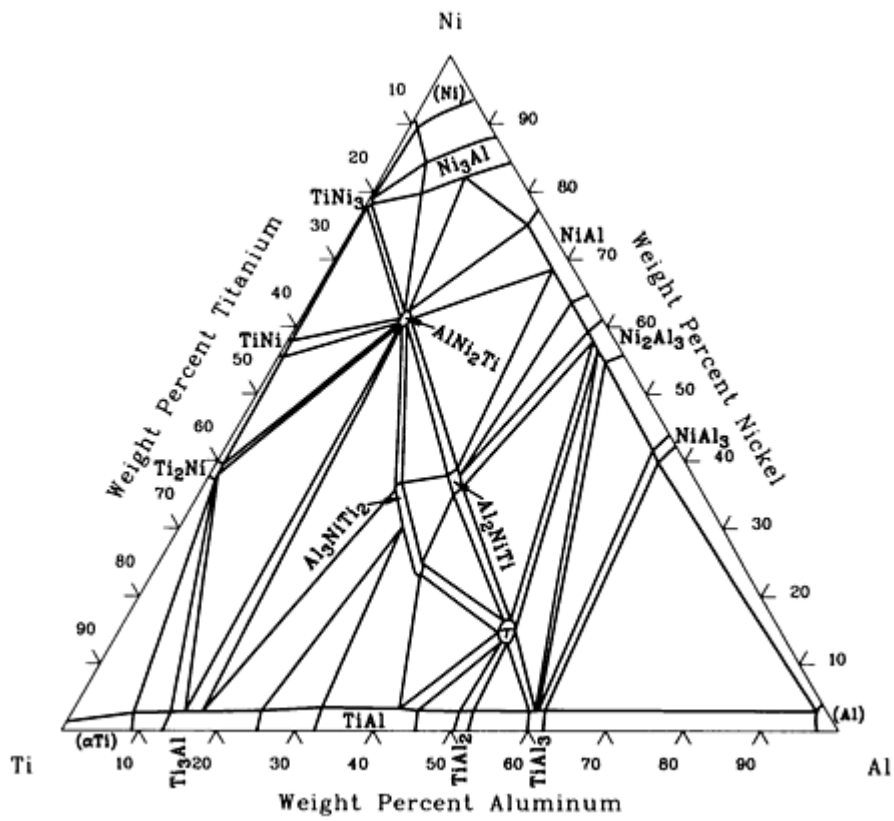

Al-Ni-Ti isothermal section at 800 °C [73Mar 31].

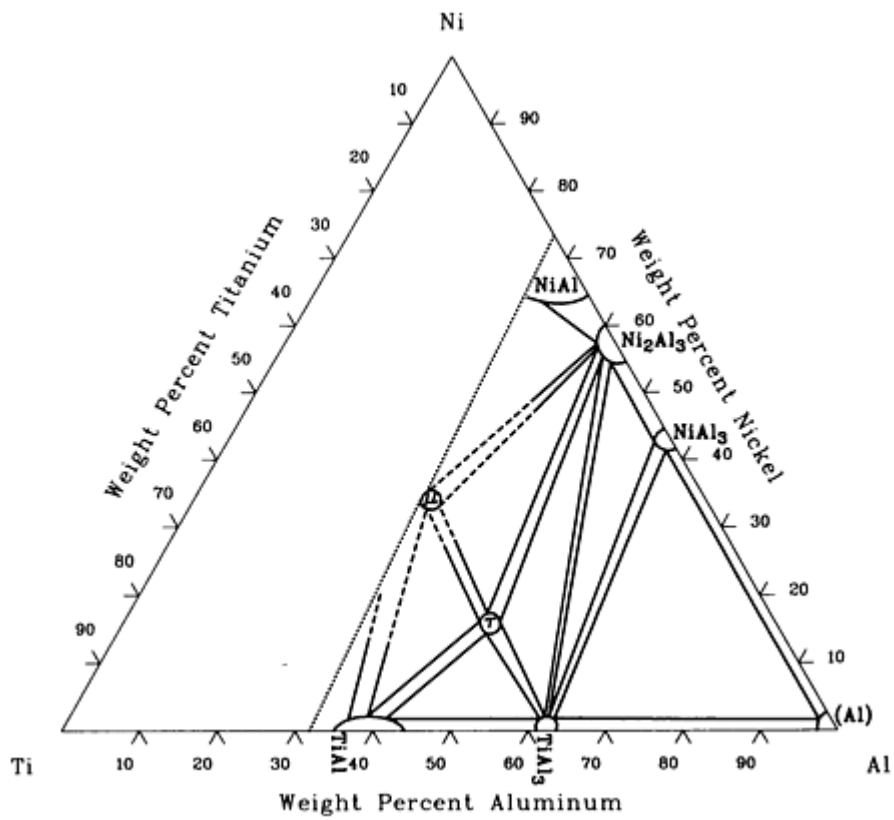

Al-Ni-Ti isothermal section at 600 °C [85Oma 49].

73Mar: V.Ya. Markiv, V.V. Burnashova, and V.R. Ryabov, "The Systems Titanium-Iron-Aluminium, Titanium-Nickel-Aluminium, and Titanium-Copper-Aluminium," *Met. Allofizika, Kiev (Akad. Nauk Ukr. SSSR, Metallofiz., Vol 46, 1973, p 103-109*

85Nas: P. Nash and W.W. Liang, Phase Equilibria in the Ni-Al-Ti System at 1173 K," *Metall. Trans. A, Vol 16, 1985, p 319-322*

85Oma: A.K. Omarov, S.V. Sejtzhanov, and A.I. Idirisov, "Isothermal Sections of the Ternary System Al-Ni-Ti for the Temperature Range 1150-600 °C," *Izv. Akad. Nauk Kazakh. SSSR, Khim, (No. 1), 1985, p 36-42*

Al-Si-Zn (Aluminum - Silicon - Zinc) Ternary Phase Diagrams

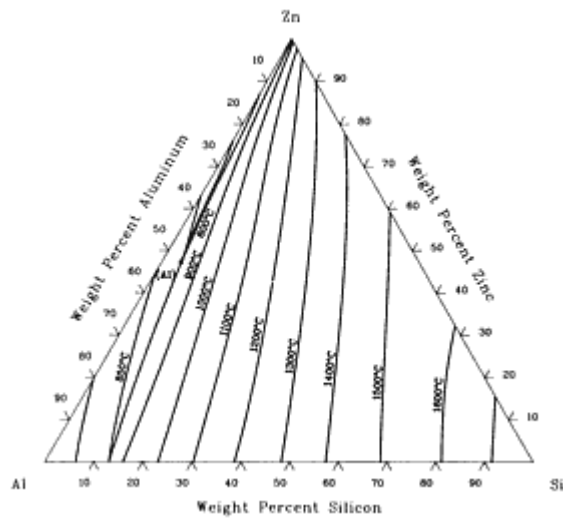

Al-Si-Zn liquidus projection [86Mey 52].

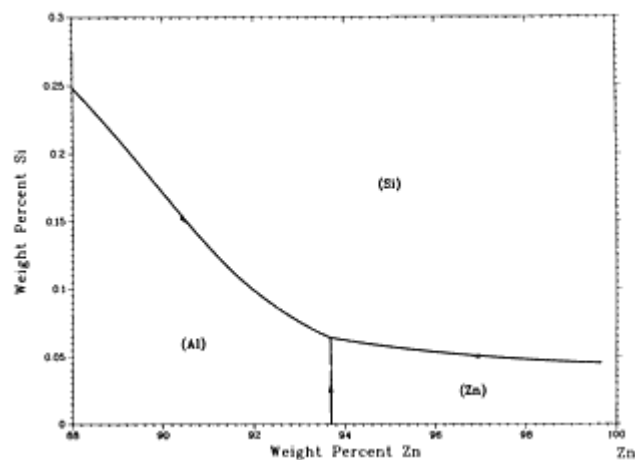

Al-Si-Zn schematic liquidus projection.

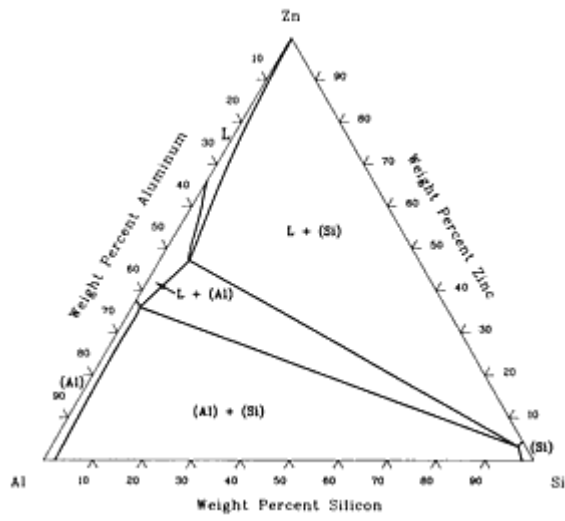

Al-Si-Zn isothermal section at 527 °C [86Mey 52].

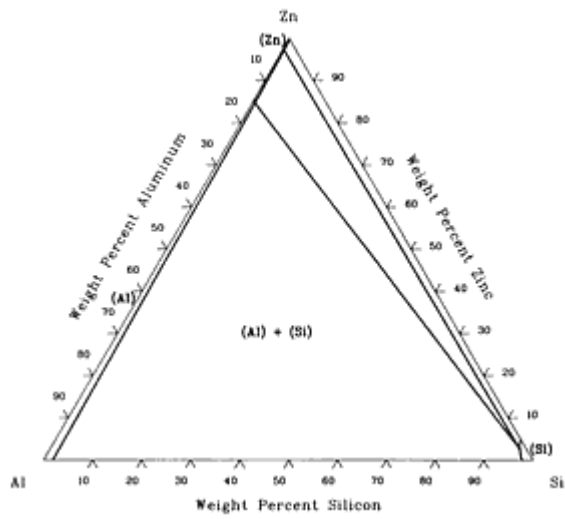

Al-Si-Zn isothermal section at 357 °C [86Mey 52].

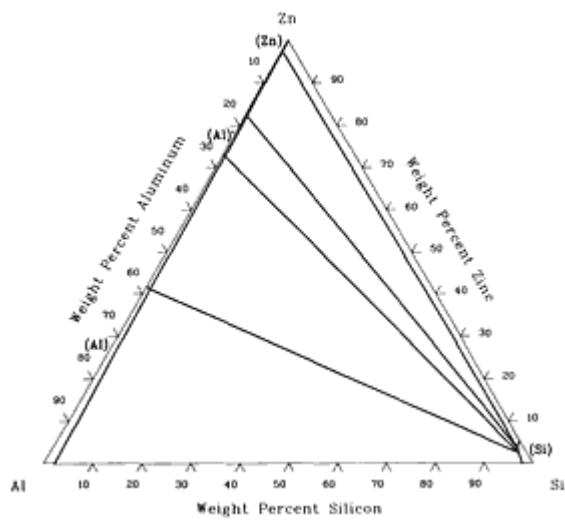

Al-Si-Zn isothermal section at 307 °C [86Mey 52].

Reference cited in this section

86Mey: S.a. Mey and K. Hack, "A Thermochemical Evaluation of the Silicon-Zinc, Aluminum-Silicon, and Aluminum-Silicon-Zinc Systems," *Z. Metallkd.*, Vol 77 (No. 7), 1986, p 454-459

Al-Ti-V (Aluminum - Titanium - Vanadium) Ternary Phase Diagrams

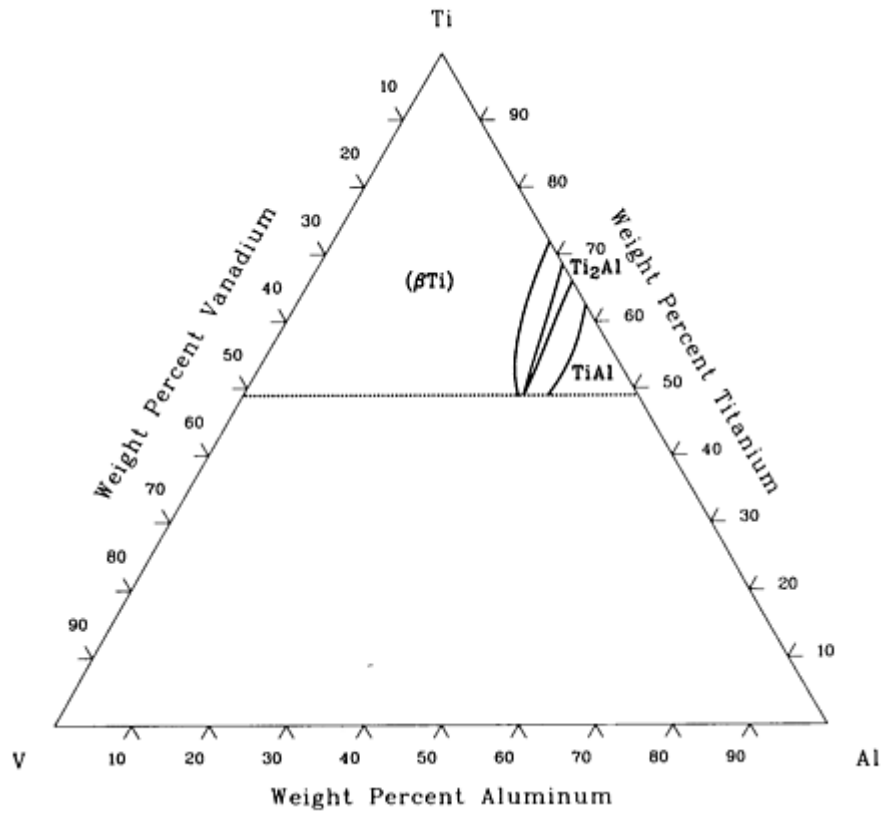

Al-Ti-V isothermal section at 1400 °C [61Far 14].

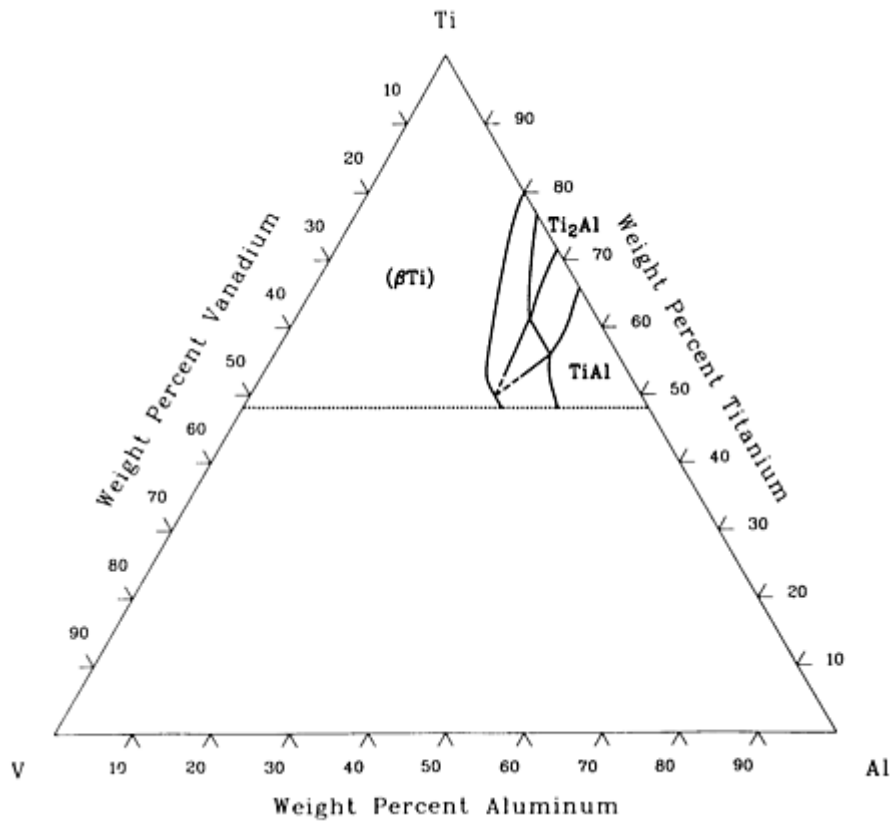

Al-Ti-V isothermal section at 1200 °C [61Far 14].

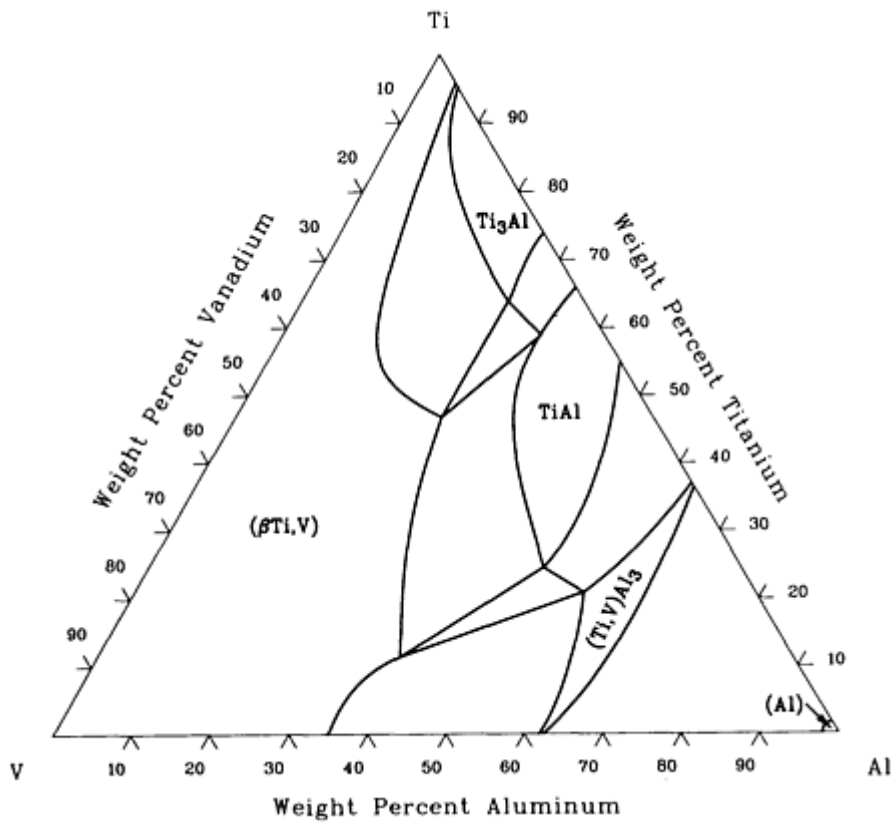

Al-Ti-V isothermal section at 980 °C [56Zwi 8].

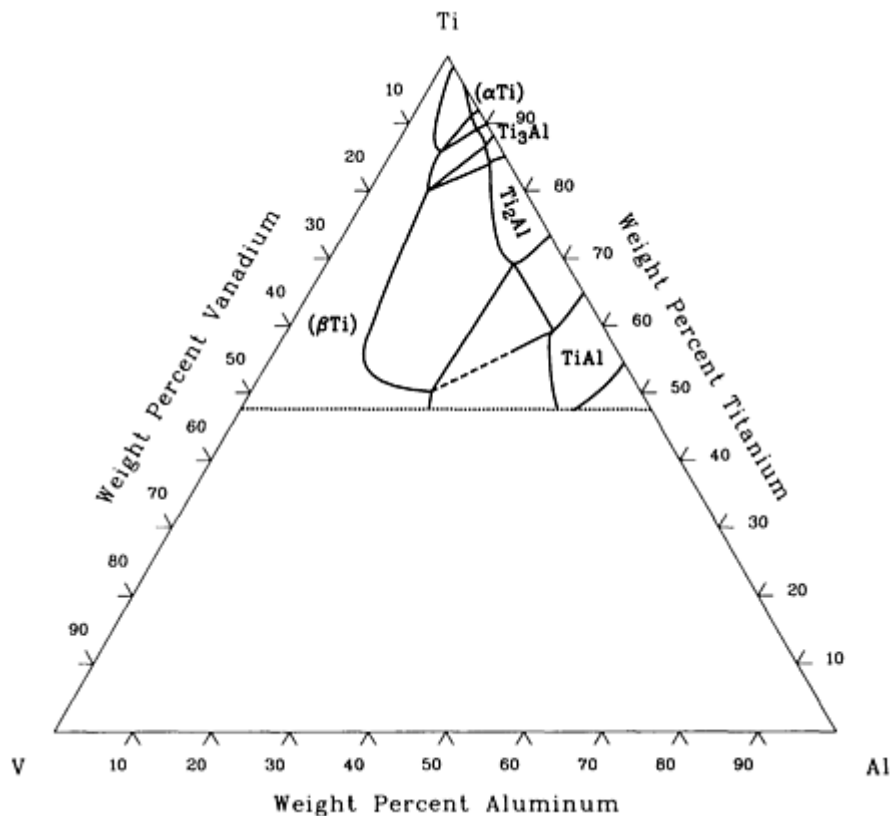

Al-Ti-V isothermal section at 900 °C [61Far 14].

References cited in this section

- 56Zwi:** U. Zwicker, "Die Systeme Titan-Aluminium-Chrom und Titan-Aluminium-Vanadin und die technischen Titanlegierungen mit 5% Cr und 3% Al sowie mit 6% Al und 4% V," *Z. Metallkd.*, Vol 47, 1956, p 535-548
- 61Far:** P. Farrar and H. Margolin, "The Titanium Rich Region of the Titanium-Aluminium-Vanadium System," *Trans. AIME*, Vol 221, 1961, p 1214-1221

Al (Aluminum) Ternary Alloy Phase Diagrams

References

- 36Kos:** W. Köster and W. Dullenkopf, "Das Dreistoffsystem Aluminium-Magnesium-Zink. III. Der Teilbereich $Mg-Al_3Mg_4-Al_2Mg_3Zn_3-MgZn_2-Mg$," *Z. Metallkd.*, Vol 28, 1936, p 363-367
- 48Kos:** W. Köster, U. Zwicker, and K. Moeller, "Mikroskopische und röntgenographische Untersuchungen zur Kenntnis des Systems Kupfer-Nickel-Aluminium," *Z. Metallkd.*, Vol 39, 1948, p 225-231
- 48Wil:** F.H. Wilson, "The Copper-Rich Corner of the Copper-Aluminum-Silicon Diagram," *Trans. AIME*, Vol 175, 1948, p 262-273
- 56Zwi:** U. Zwicker, "Die Systeme Titan-Aluminium-Chrom und Titan-Aluminium-Vanadin und die technischen Titanlegierungen mit 5% Cr und 3% Al sowie mit 6% Al und 4% V," *Z. Metallkd.*, Vol 47, 1956, p 535-548
- 61Far:** P. Farrar and H. Margolin, "The Titanium Rich Region of the Titanium-Aluminium-Vanadium System," *Trans. AIME*, Vol 221, 1961, p 1214-1221

6. **64Kus:** J.B. Kusma and H. Nowotny, "Untersuchungen im Dreistoff: Mn-Al-Si," *Monatsh. Chem.*, Vol 95, 1964, p 1266-1271
7. **66Kos:** W. Köster and T. Gödecke, "Das Dreistoffsystem Kupfer-Mangan-Aluminium," *Z. Metallkd.*, Vol 57, 1966, p 889-901
8. **70Han:** R.C. Hansen and A. Raman, "Alloy Chemistry of sigma (beta-U)-Related Phases. III. sigma-Phases with Non-Transition Elements," *Z. Metallkd.*, Vol 61, 1970, p 115-120
9. **70Kos:** W. Köster and T. Gödecke, "Das Dreistoffsystem Eisen-Aluminium-Zink," *Z. Metallkd.*, Vol 61, 1970, p 649-658
10. **71Pre:** A.P. Prevarskiy, "Investigation of Fe-Cu-Al Alloys," *Russ. Metall.*; TR: *Izv. Akad. Nauk SSSR, Metall.*, (No. 4), 1971, p 154-156
11. **73Mar:** V.Ya. Markiv, V.V. Burnashova, and V.R. Ryabov, "The Systems Titanium-Iron-Aluminium, Titanium-Nickel-Aluminium, and Titanium-Copper-Aluminium," *Met. Allofizika, Kiev (Akad. Nauk Ukr. SSSR, Metallofiz.*, Vol 46, 1973, p 103-109
12. **73Wil:** L.A. Willey, *Metallography, Structures and Phase Diagrams*, Vol 8, *Metals Handbook*, 8th ed., American Society for Metals, Metals Park, OH 1973
13. **79Cha:** Y.A. Chang, J.P. Neumann, A. Mikula, and D. Goldberg, *Phase Diagrams and Thermodynamic Properties of Ternary Copper-Metal Systems*, INCRA Monograph VI, International Copper Research Association, 1979
14. **84Mir:** D.B. Miracle, K.A. Lark, V. Srinivasan, and H.A. Lipsitt, "Nickel-Aluminium-Molybdenum Phase Equilibria," *Metall. Trans. A*, Vol 15, 1984, p 481-486
15. **85Nas:** P. Nash and W.W. Liang, "Phase Equilibria in the Ni-Al-Ti System at 1173 K," *Metall. Trans. A*, Vol 16, 1985, p 319-322
16. **85Oma:** A.K. Omarov, S.V. Sejtzhanov, and A.I. Idirisov, "Isothermal Sections of the Ternary System Al-Ni-Ti for the Temperature Range 1150-600 °C," *Izv. Akad. Nauk Kazakh. SSSR, Khim*, (No. 1), 1985, p 36-42
17. **86Mey:** S.a. Mey and K. Hack, "A Thermochemical Evaluation of the Silicon-Zinc, Aluminum-Silicon, and Aluminum-Silicon-Zinc Systems," *Z. Metallkd.*, Vol 77 (No. 7), 1986, p 454-459
18. **87Ofo:** N.C. Oforika and C.W. Haworth, "Phase Equilibria of Aluminum-Chromium-Nickel System at 1423 K," *Scand. J. Metall.*, Vol 16, 1987, p 184-188
19. **88Ray:** G.V. Raynor and V.G. Rivlin, *Phase Equilibria in Iron Ternary Alloys*, The Institute of Metals, London, (No. 4), 1988
20. **88Rok:** L.L. Rokhlin and A.G. Pepelyan, "Phase Equilibria in the Mg-Rich Region of the Mg-Al-Si System," *Russ. Metall.*, Tr: *Izv. Akad. Nauk SSSR, Met.*, (No. 6), 1988, p 172-174
21. **88Sim:** C.J. Simensen, B.C. Oberländer, J. Svalestuen, and A. Thornvaldsen, "The Phase Diagram for Magnesium-Aluminum-Manganese Above 650 °C," *Z. Metallkd.*, Vol 79 (No. 11), 1988, p 696-699

Introduction

THIS ARTICLE includes systems where gold is the first-named element in the ternary system. Additional ternary systems that include gold are provided in the following location in this Volume:

- “Ag-Au-Cu (Silver - Gold - Copper)” in the article “Ag (Silver) Ternary Phase Diagrams.”

Au-Cu-Ni (Gold - Copper - Nickel) Ternary Phase Diagrams

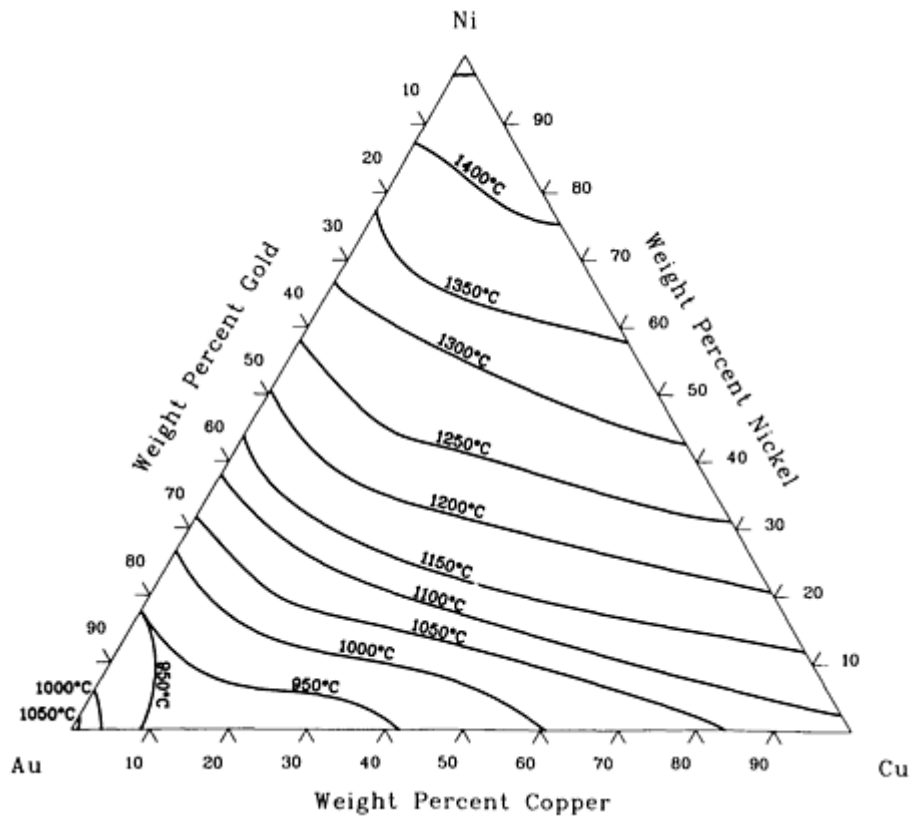

Au-Cu-Ni liquidus projection [90Pri 65].

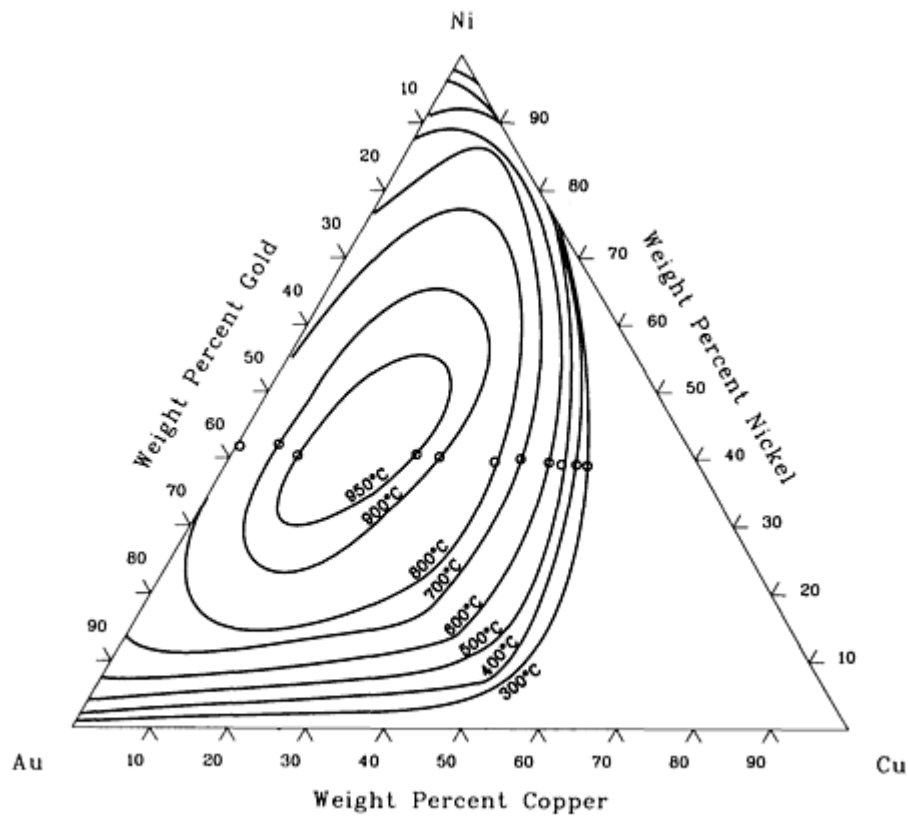

The open circles represent the compositions at which the gap closes.

Au-Cu-Ni boundaries of solid-state miscibility gap [90Pri 65].

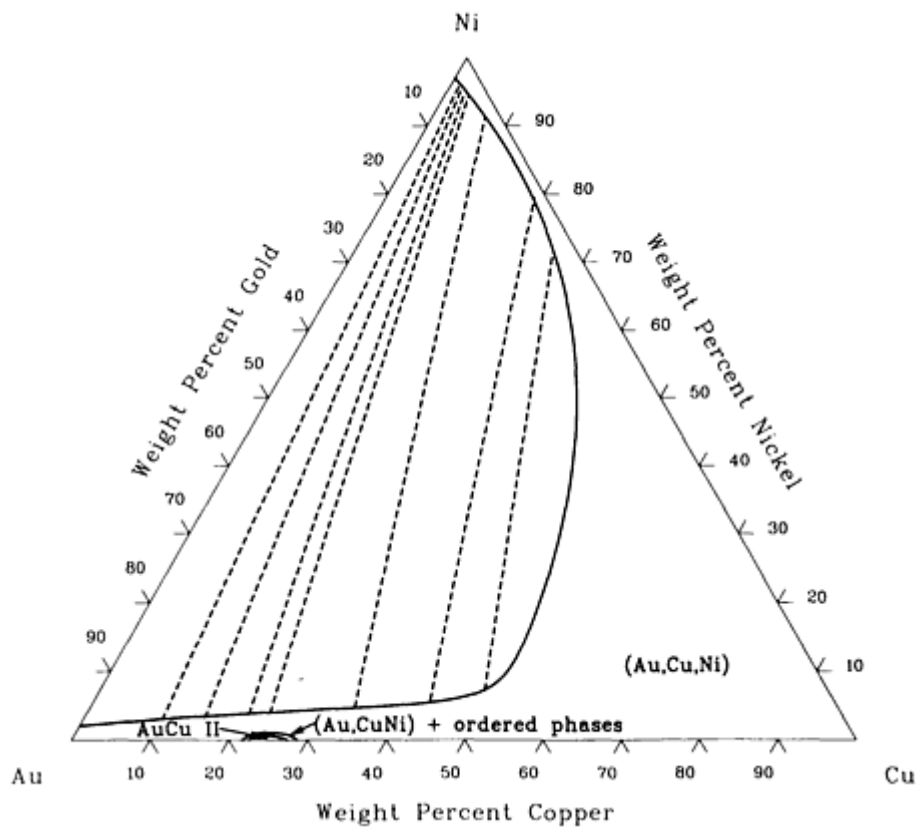

Au-Cu-Ni boundary of miscibility gap at 400 °C, with tie lines [90Pri 65].

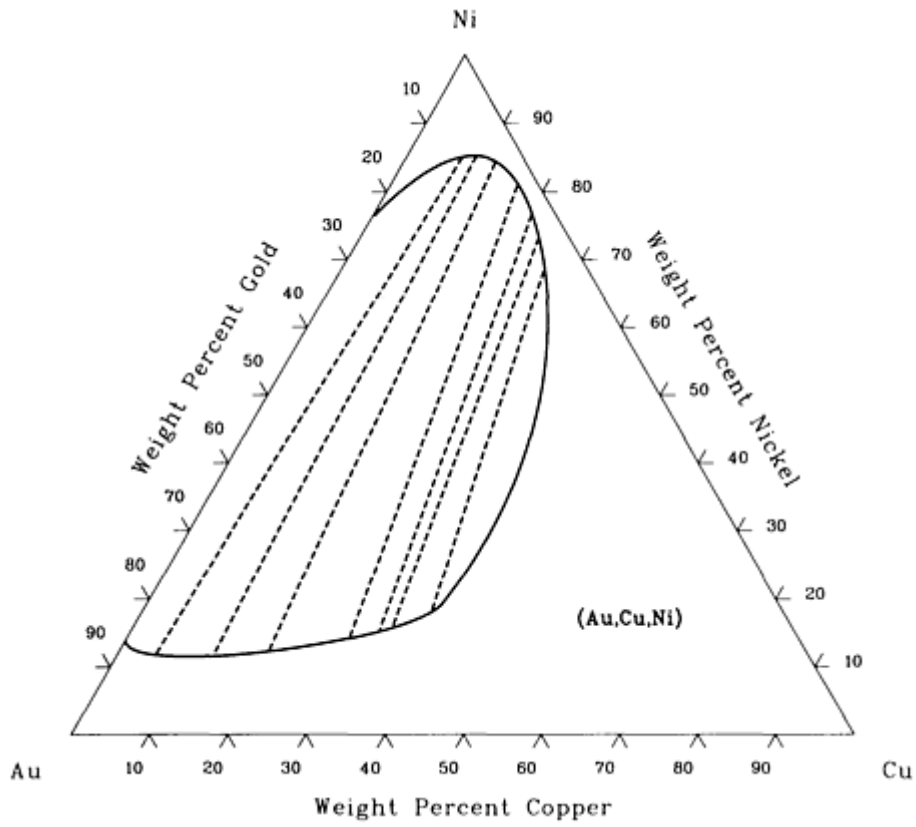

Au-Cu-Ni boundary of miscibility gap at 700 °C, with tie lines [90Pri 65].

Reference cited in this section

90Pri: A. Prince, G.V. Raynor, and D.S. Evans, *Phase Diagrams of Ternary Gold Alloys*, The Institute of Metals, London, 1990

Introduction

THIS ARTICLE includes systems where boron is the first-named element in the ternary system.

B-C-Fe (Boron - Carbon - Iron) Ternary Phase Diagrams

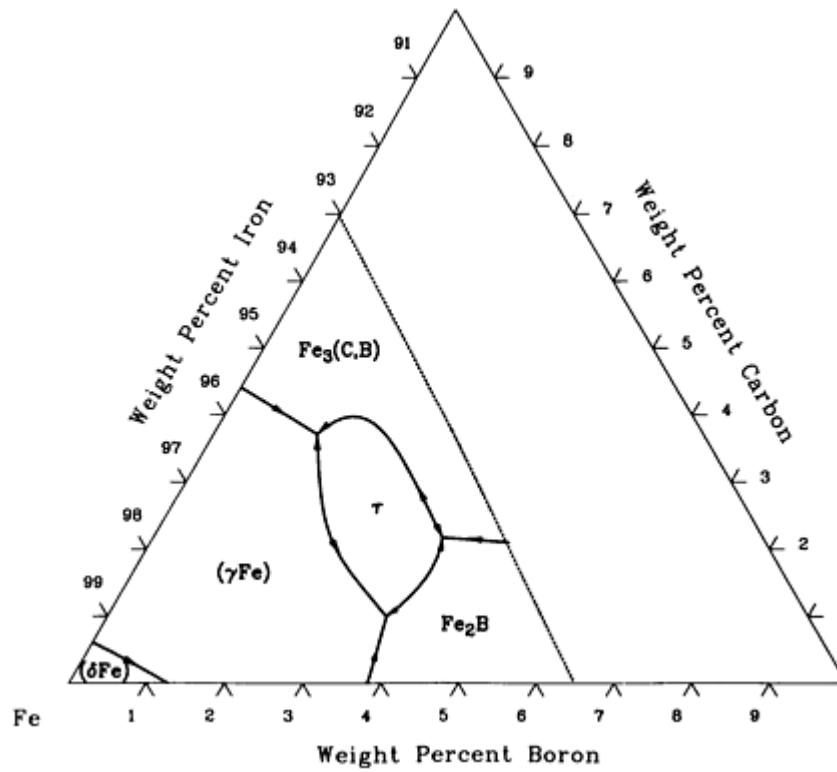

B-C-Fe liquidus projection [63Sta 16].

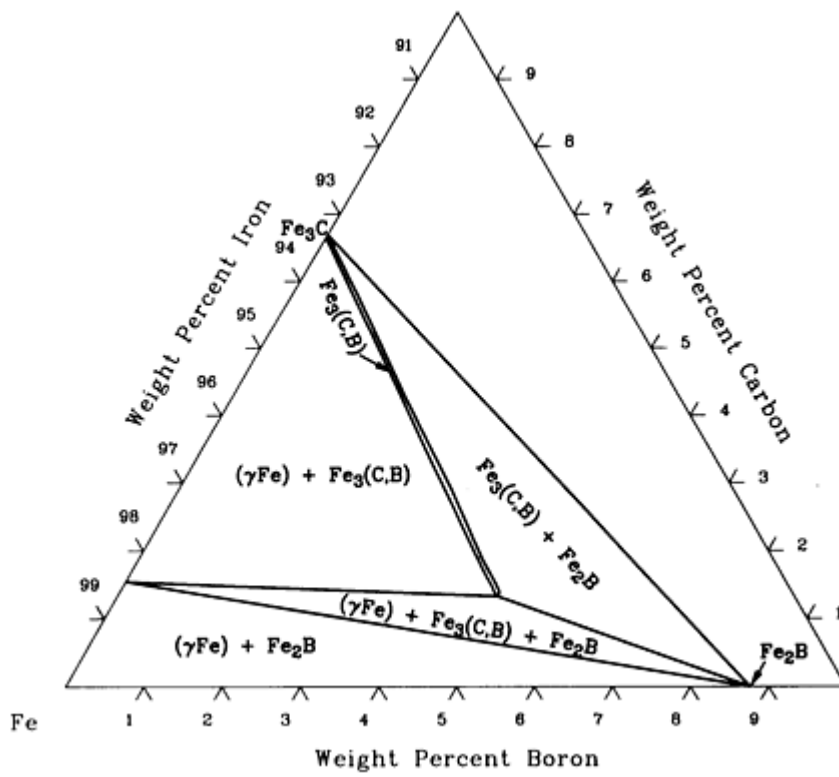

B-C-Fe isothermal section at 1000 °C [73Bre 28].

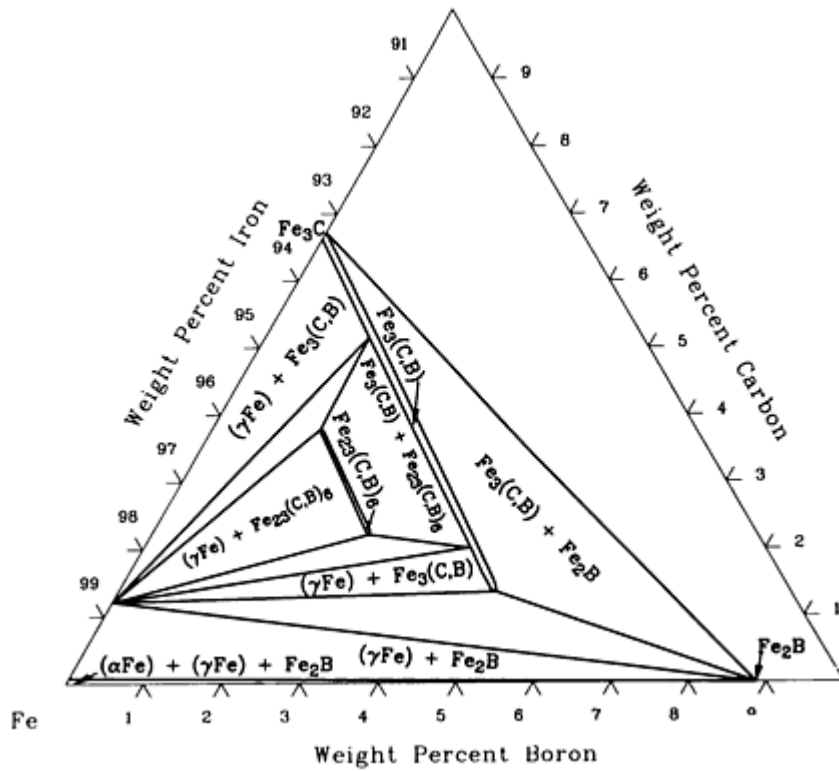

B-C-Fe isothermal section at 900 °C [73Bre 28].

C (Carbon) Ternary Alloy Phase Diagrams

Introduction

THIS ARTICLE includes systems where carbon is the first-named element in the ternary system. Additional ternary systems that include carbon are provided in the following location in this Volume:

- “B-C-Fe (Boron - Carbon - Iron)” in the article “B (Boron) Ternary Phase Diagrams.”

C-Cr-Fe (Carbon - Chromium - Iron) Ternary Phase Diagrams

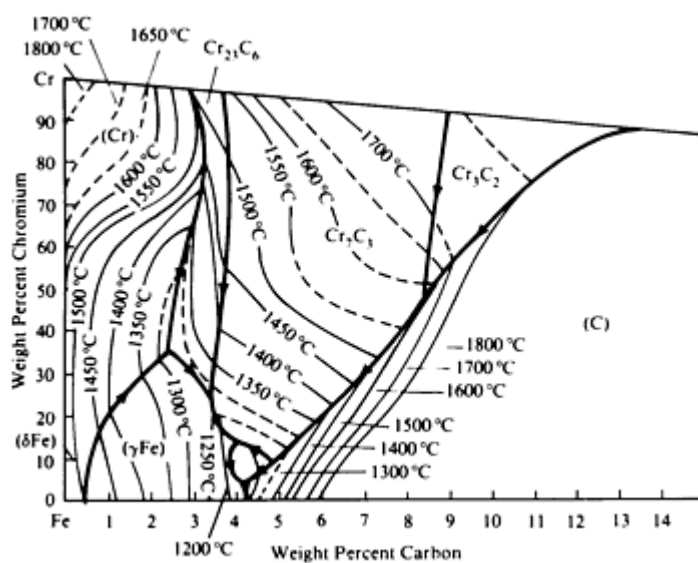

C-Cr-Fe liquidus projection [88Ray 60].

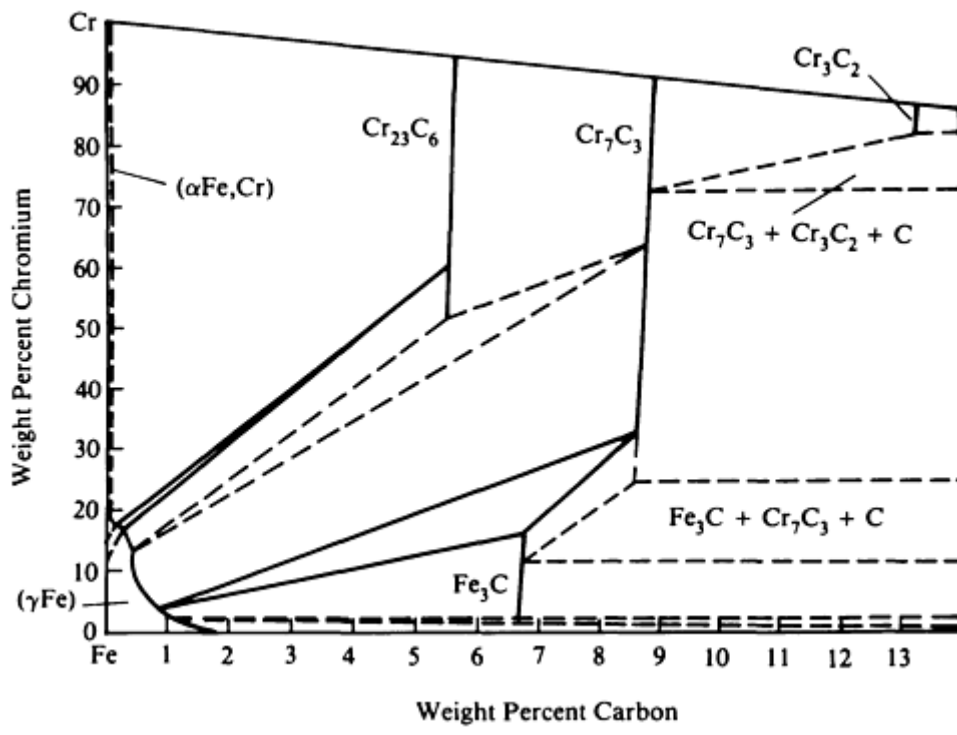

C-Cr-Fe isothermal section at 1000 °C [88Ray 60].

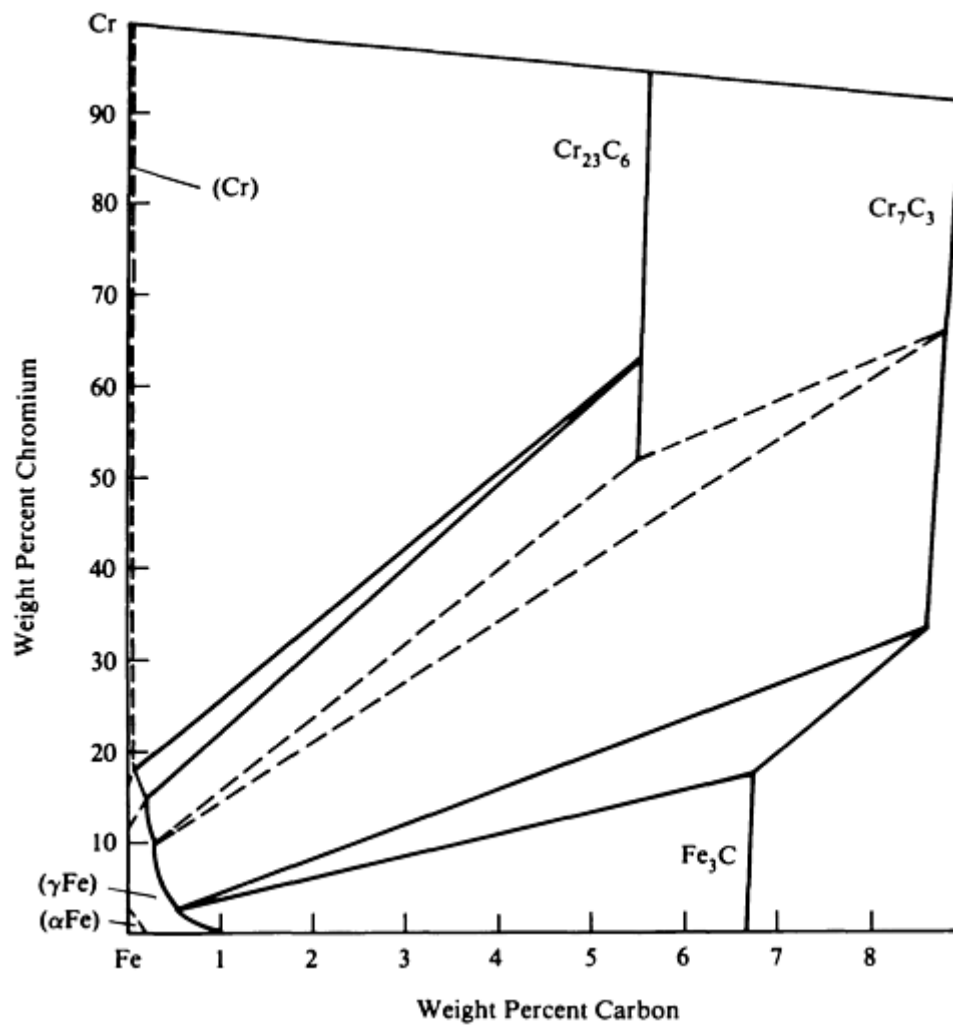

C-Cr-Fe isothermal section at 870 °C [88Ray 60].

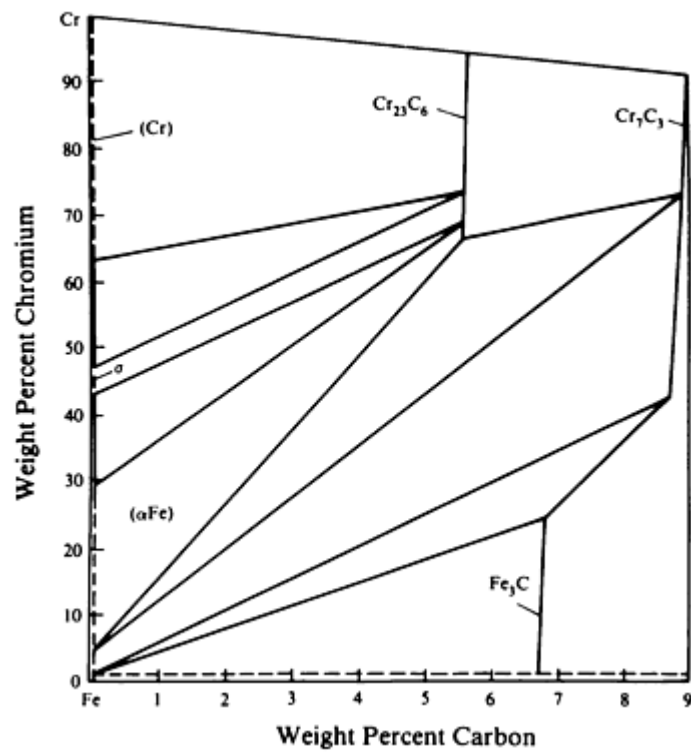

C-Cr-Fe isothermal section at 700 °C [88Ray 60].

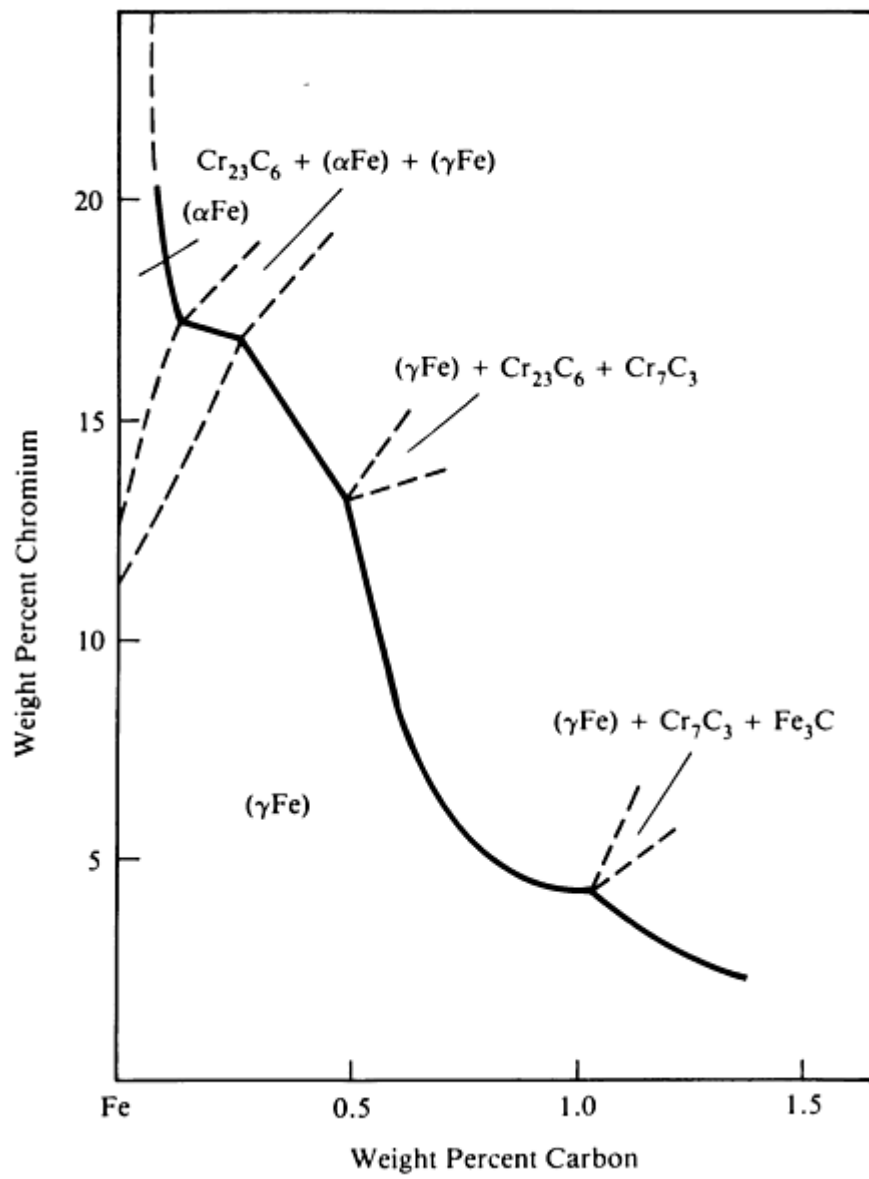

C-Cr-Fe (Fe) isothermal section at 1100 °C [88Ray 60].

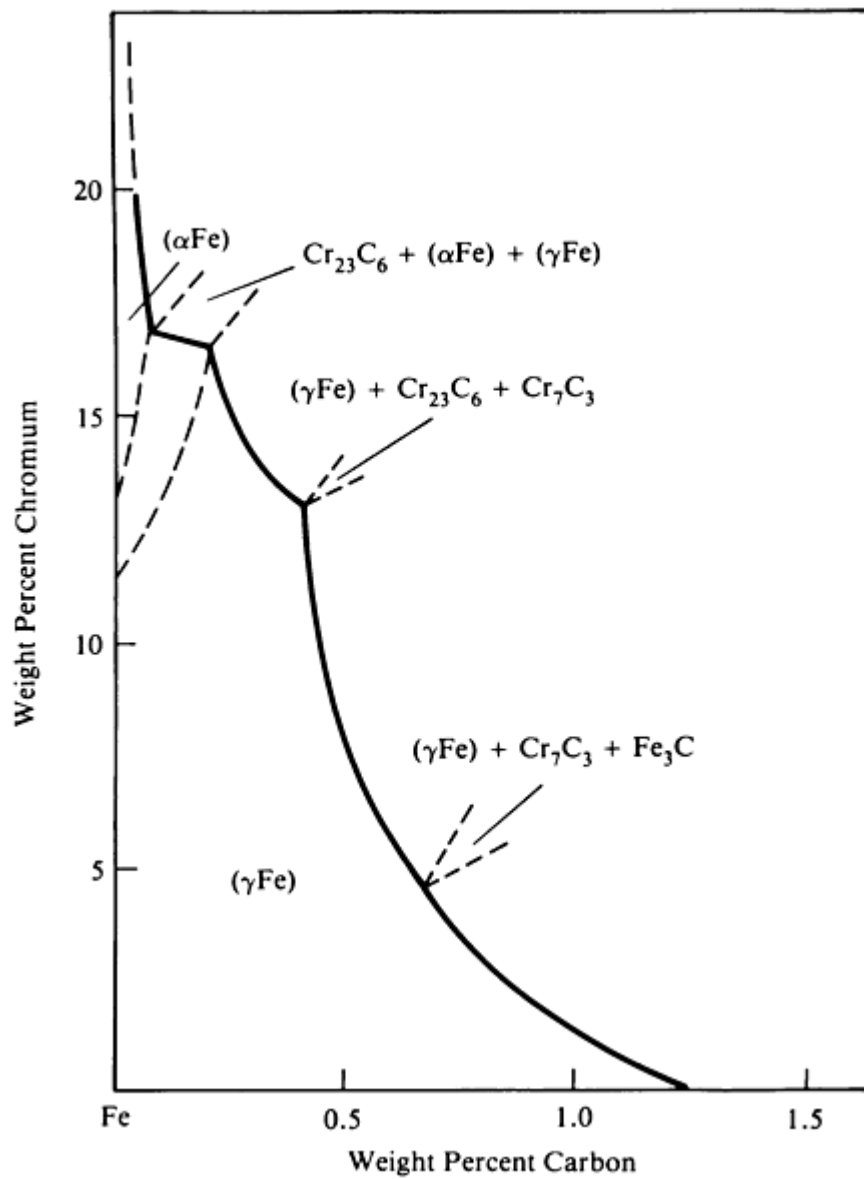

C-Cr-Fe isothermal section at 900 °C [88Ray 60].

Reference cited in this section

88Ray: G.V. Raynor and V.G. Rivlin, *Phase Equilibria in Iron Ternary Alloys*, The Institute of Metals, London, (No. 4), 1988

C-Cr-Mo (Carbon - Chromium - Molybdenum) Ternary Phase Diagrams

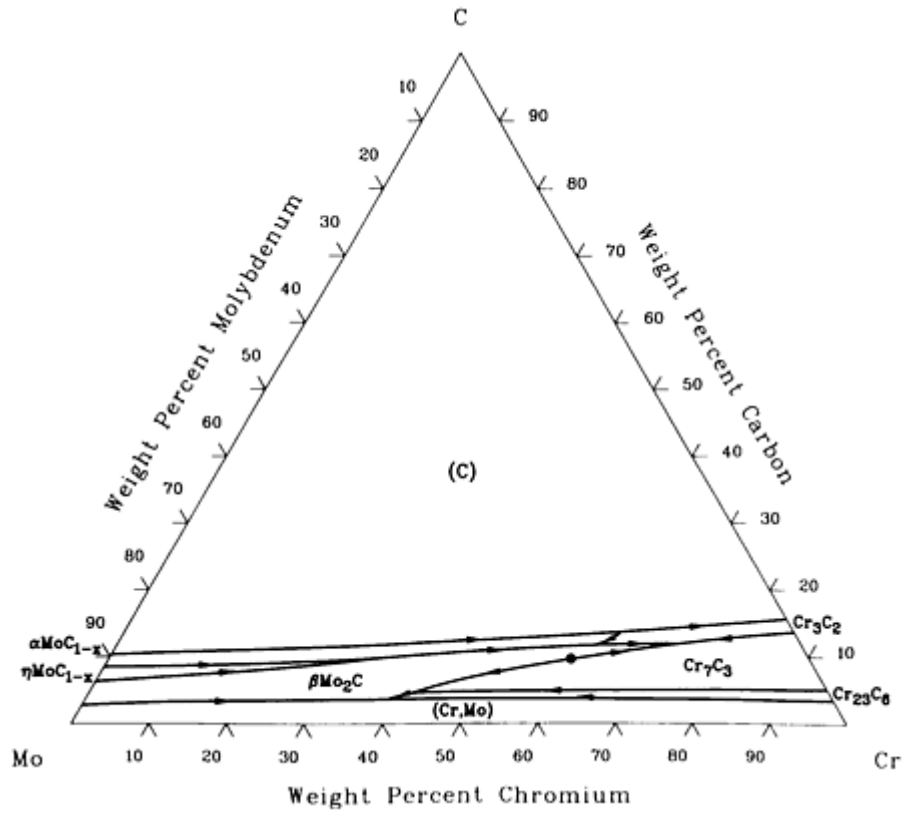

C-Cr-Mo liquidus projection [87Ere 55].

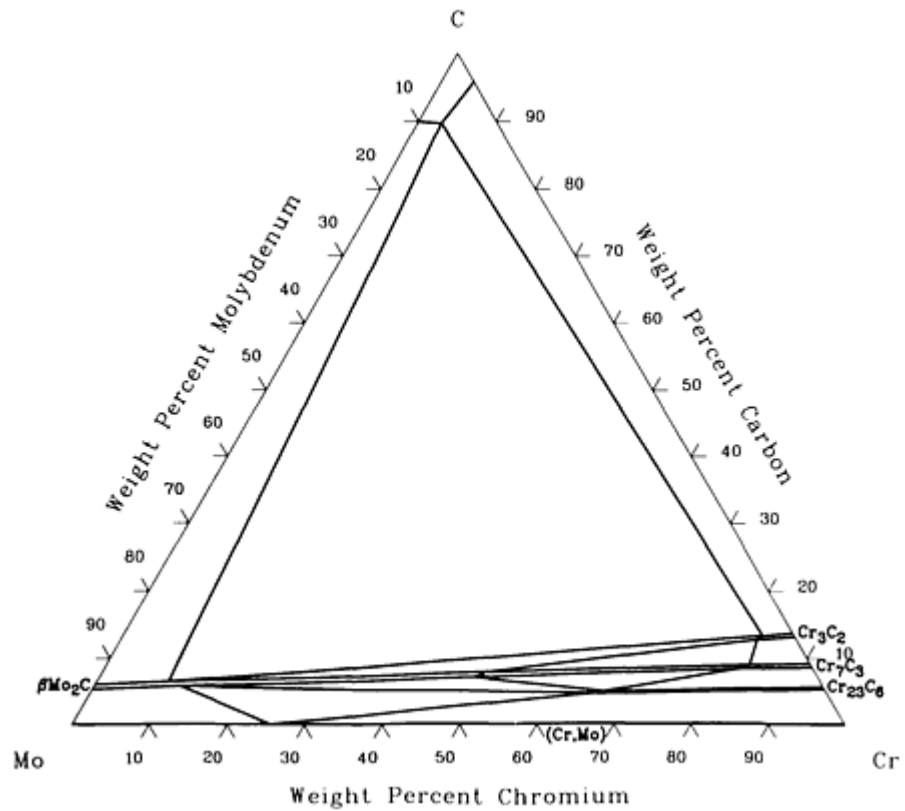

C-Cr-Mo isothermal section at 1350 °C [65Kuz 19].

References cited in this section

65Kuz: Yu.B. Kuz'ma and T.F. Fedorov, "Phase Equilibria in the System Molybdenum-Chromium-Carbon," *Sov. Powder Metall. Met. Ceram.*; TR: *Poroshk. Metall. Kiev*, Vol 4, 1965, p 920-922

87Ere: V.N. Eremenko, T.Ya. Velikanova, and A.A. Bondar, "The Phase Diagram of the Cr-Mo-C System, II. Phase Equilibria in the Partial System $\text{Mo}_2\text{C-Cr}_7\text{C}_3\text{-C}$," *Sov. Powder Metall. Met. Ceram.*, TR: *Poroshk. Metall. Kiev*, Vol 26 (No. 6), 1987, p 506-511

C-Cr-N (Carbon - Chromium - Nitrogen) Ternary Phase Diagrams

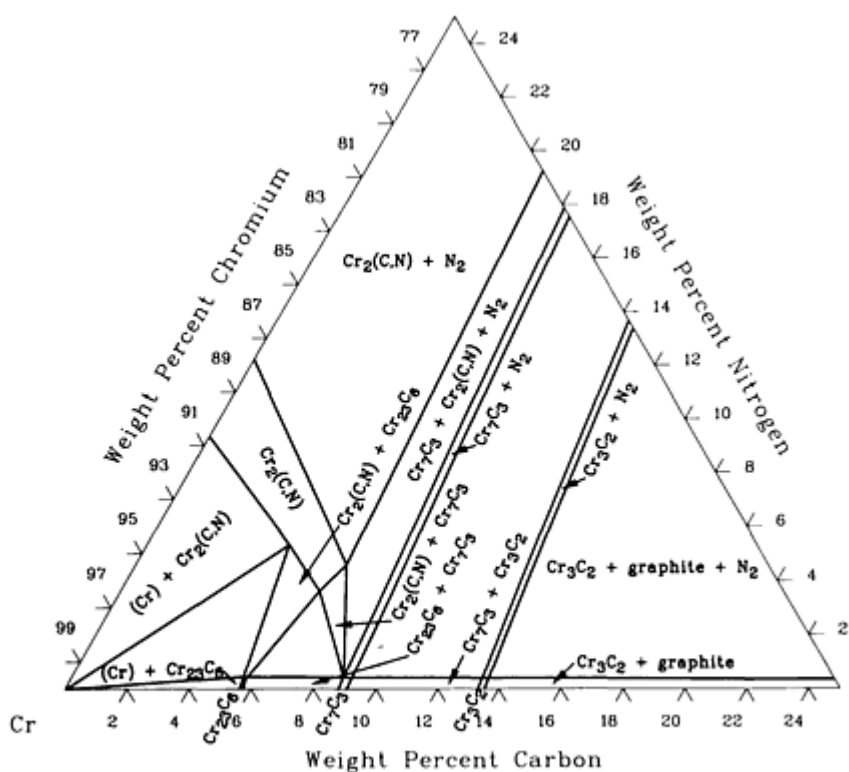

Nitrogen pressure: ≤ 0.1 MPa.

C-Cr-N isothermal section at 1400 °C [73Bre 28].

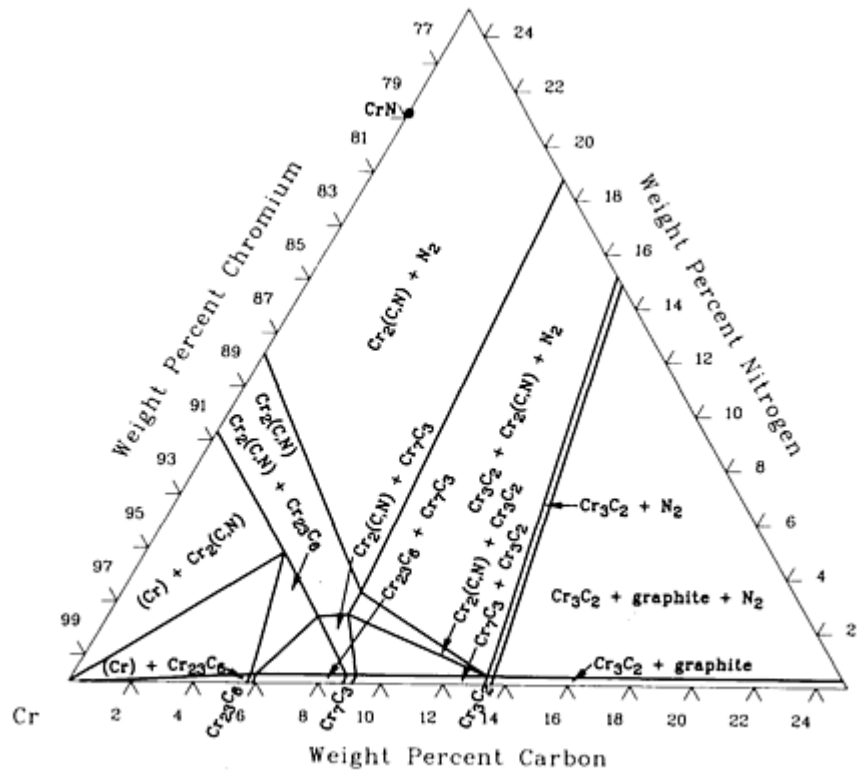

Nitrogen pressure: ≤ 0.1 MPa.

C-Cr-N isothermal section at 1100 °C [73Bre 28].

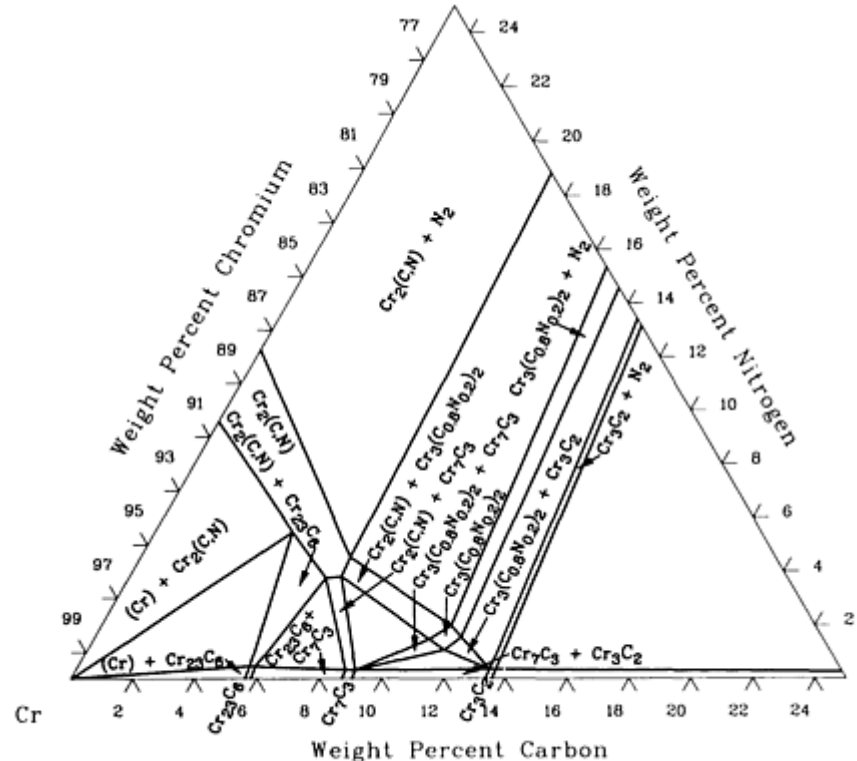

Nitrogen pressure: ~ 3 MPa.

C-Cr-N isothermal section at 1400 °C [73Bre 28].

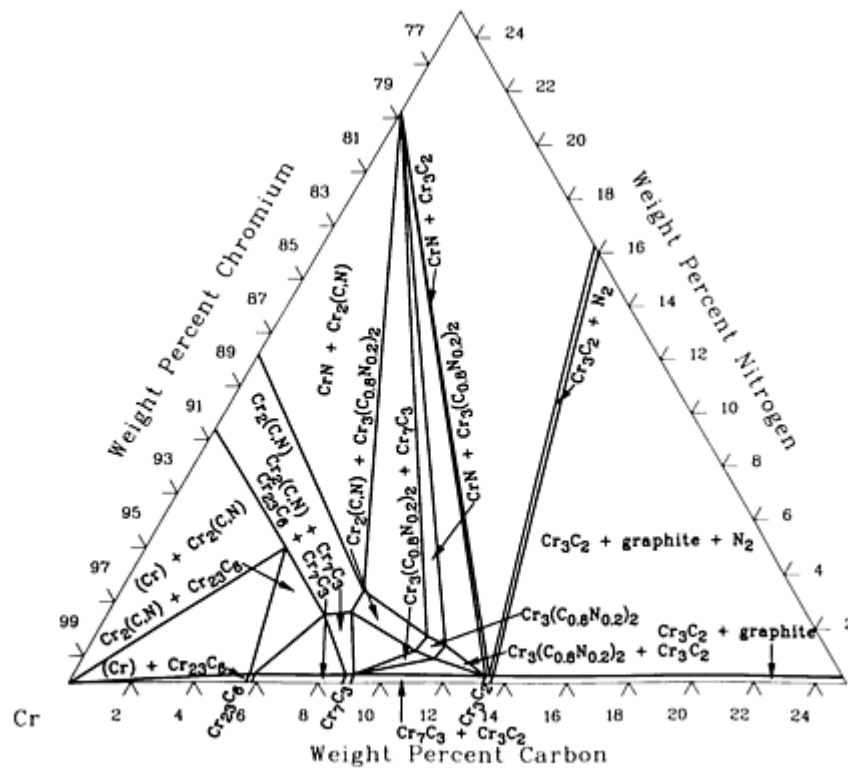

Nitrogen pressure: 0.2 to 3 MPa.

C-Cr-N isothermal section at 1100 °C [73Bre 28].

Reference cited in this section

73Bre: L. Brewer and S.-G. Chang, *Metallography, Structures and Phase Diagrams*, Vol 8, *Metals Handbook*, 8th ed., American Society for Metals, Metals Park, OH, 1973

C-Cr-V (Carbon - Chromium - Vanadium) Ternary Phase Diagrams

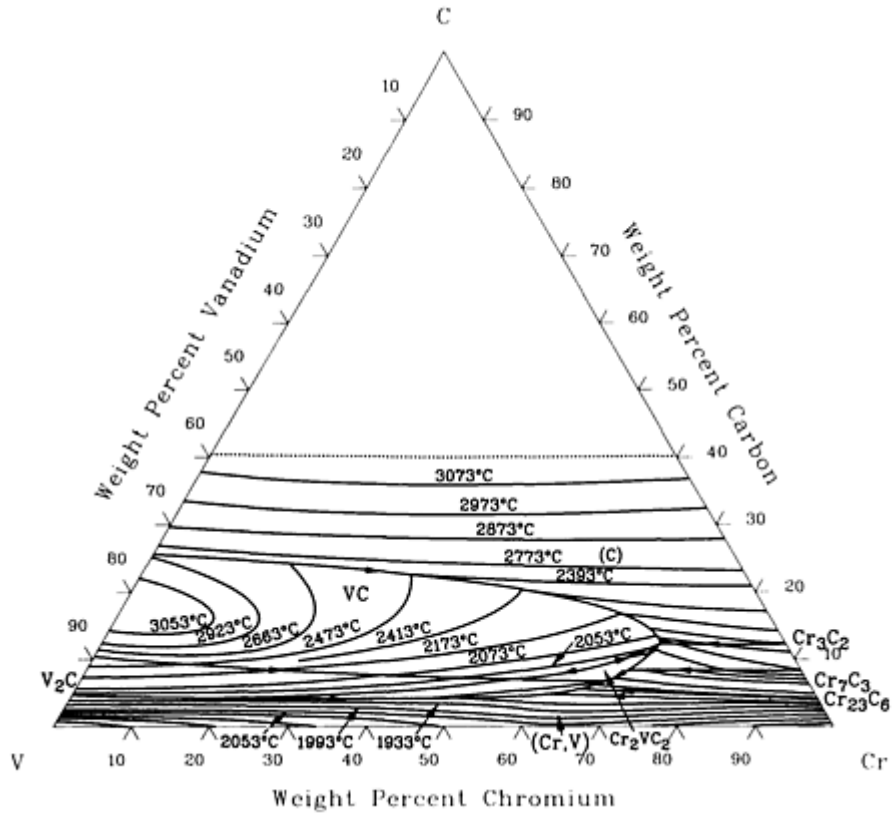

C-Cr-V liquidus projection [66Kie 20].

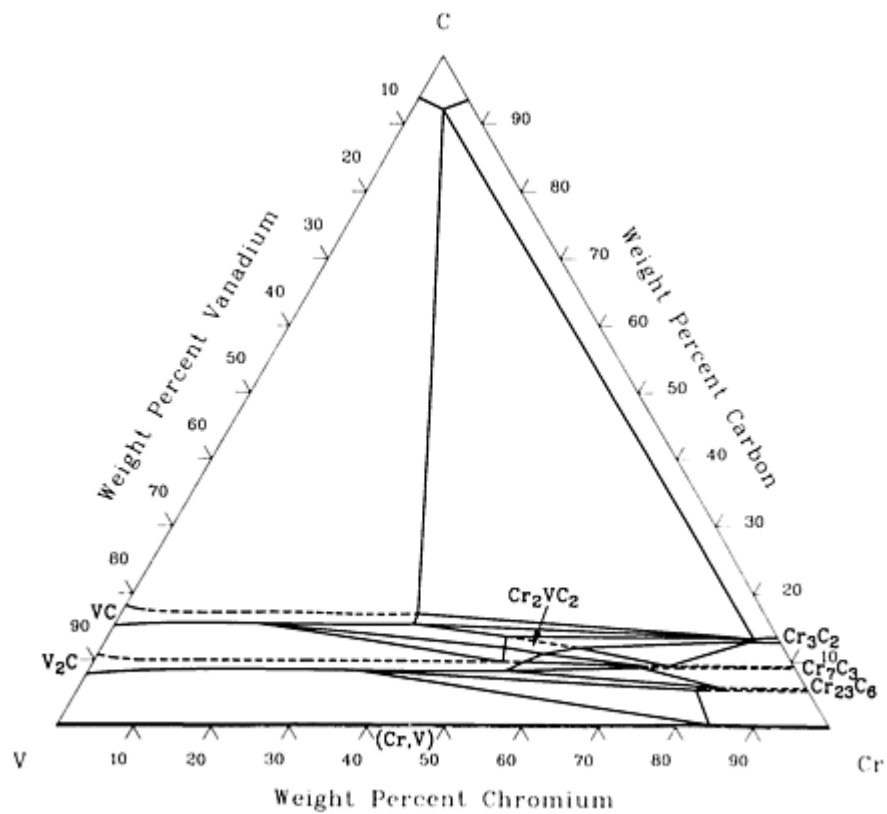

C-Cr-V isothermal section at 1350 °C [66Kie 20].

Reference cited in this section

66Kie: R. Kieffer and H. Rassaerts, "Über das System Vanadium-Chrom-Kohlenstoff und über den Einsatz von Vanadin- und Chromcarbiden in Hartmetallen, Teil I," *Metall, Berlin*, Vol 20, 1966, p 691-695

C-Cr-W (Carbon - Chromium - Tungsten) Ternary Phase Diagrams

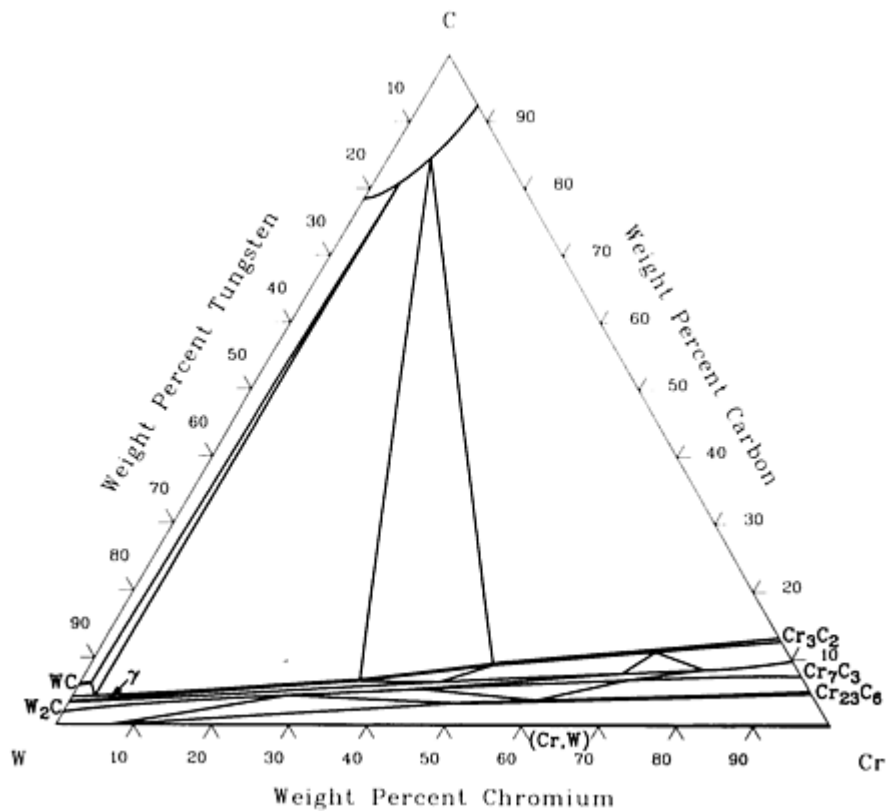

C-Cr-W isothermal section at 1600 °C [86Ere 51].

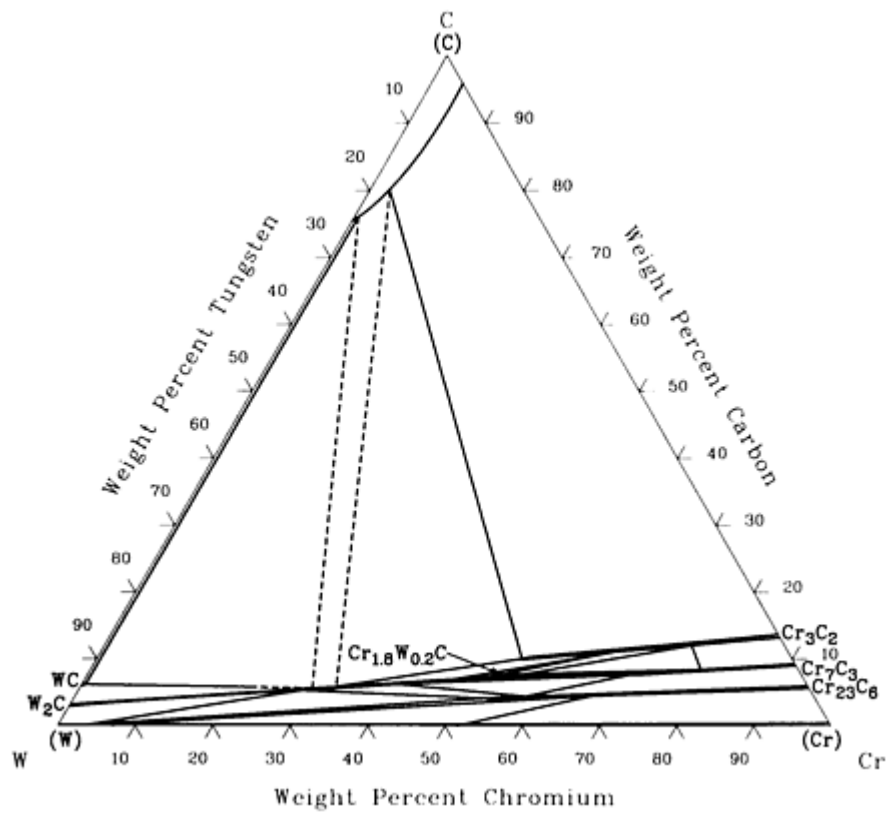

C-Cr-W isothermal section at 1350 °C [64Ste 18].

References cited in this section

64Ste: P Stecher, F. Benesovsky, and H. Nowotny, "Untersuchungen im System Chrom-Wolfram-Kohlenstoff," Vol. 12, 1964, p 89-95

86Ere: V.N. Eremenko, T.Ja. Velikanova, and A.A. Bondar, "The Ternary Phase Diagram Cr-W-C System," *Dop. Akad. Nauk Ukr. RSR, A, Fiz.- Mat. Tekh.*, Vol 48 (No. 11), 1986, p 74-78

C-Cu-Fe (Carbon - Copper - Iron) Ternary Phase Diagrams

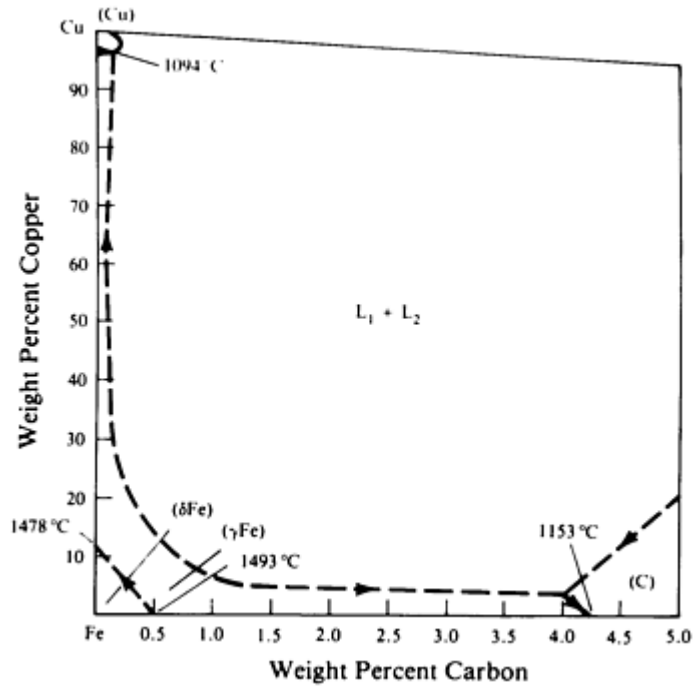

C-Cu-Fe liquidus projection [88Ray 60].

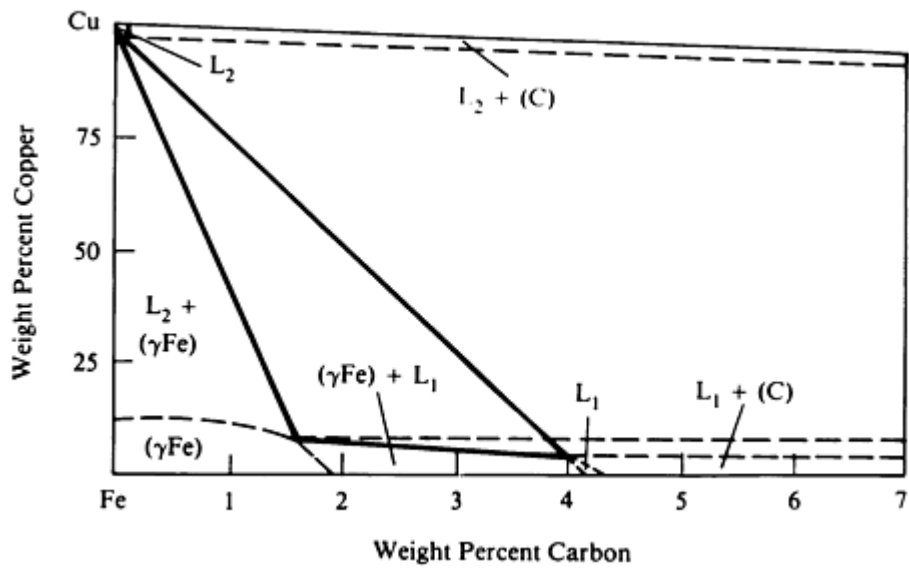

C-Cu-Fe isothermal section at 1172 °C [88Ray 60].

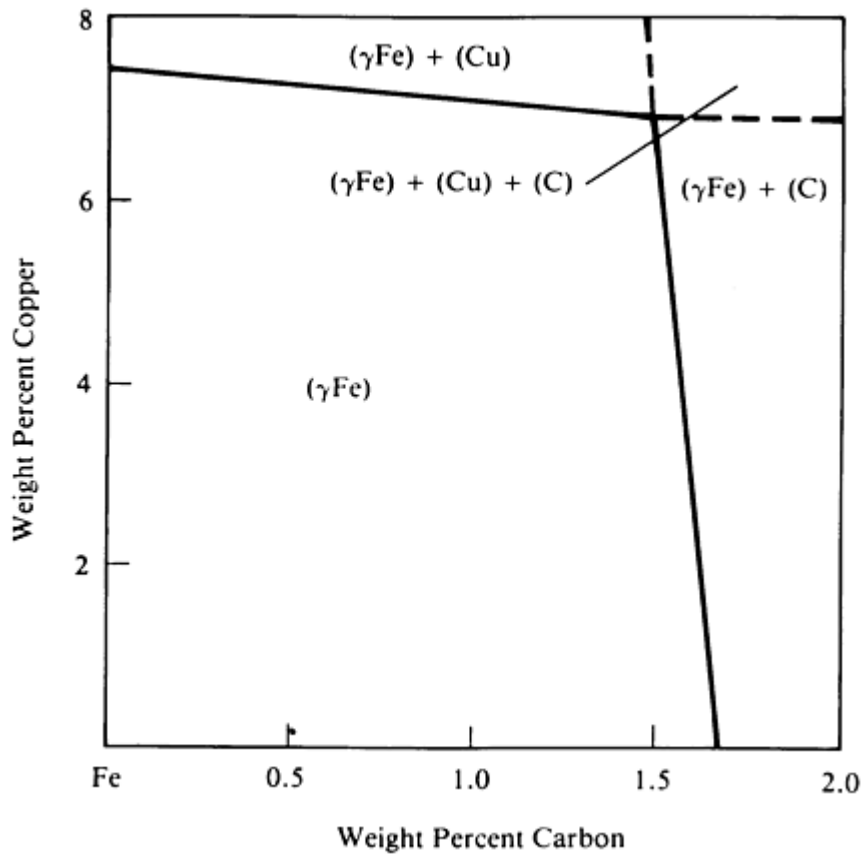

C-Cu-Fe isothermal section at 1050 °C [88Ray 60].

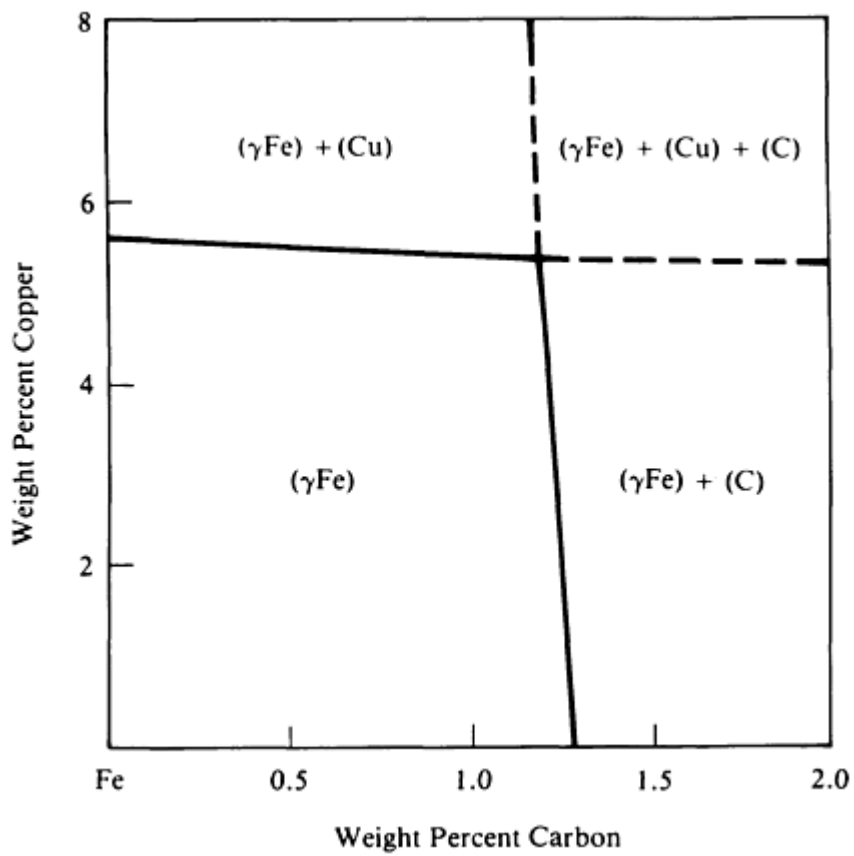

C-Cu-Fe isothermal section at 925 °C [88Ray 60].

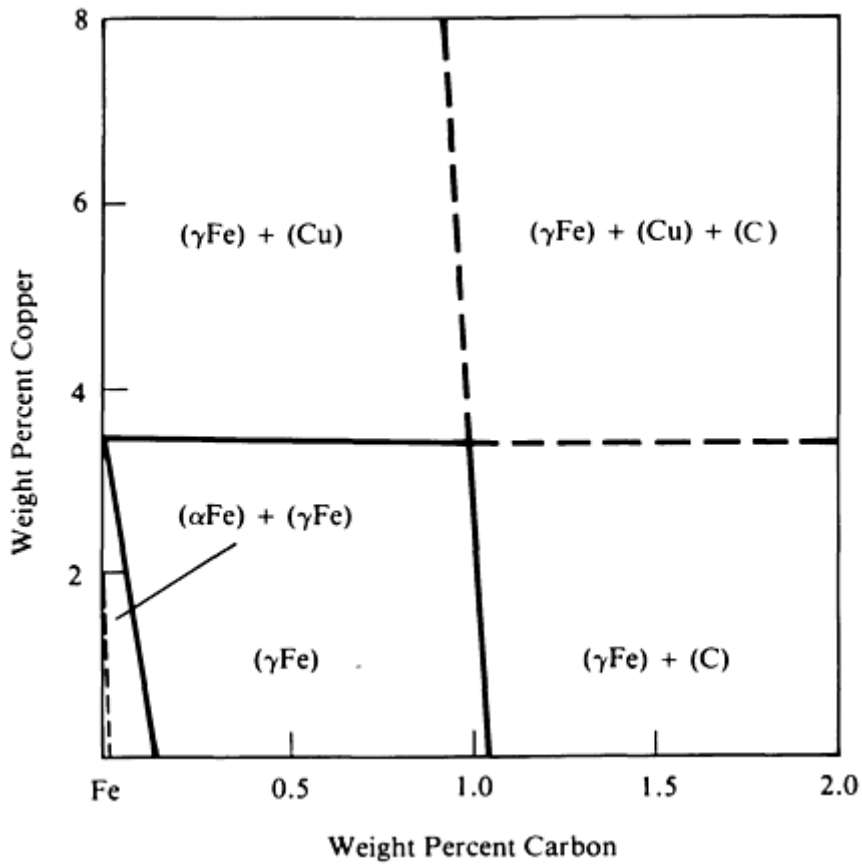

C-Cu-Fe isothermal section at 850 °C [88Ray 60].

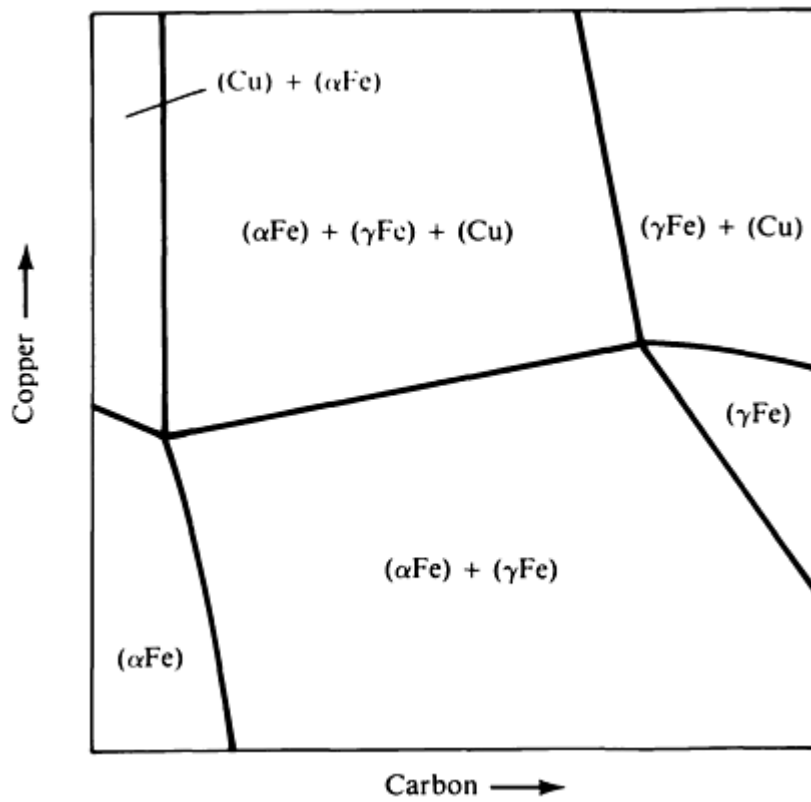

C-Cu-Fe schematic isothermal section at 850 °C [88Ray 60].

C-Fe-Mn (Carbon - Iron - Manganese) Ternary Phase Diagrams

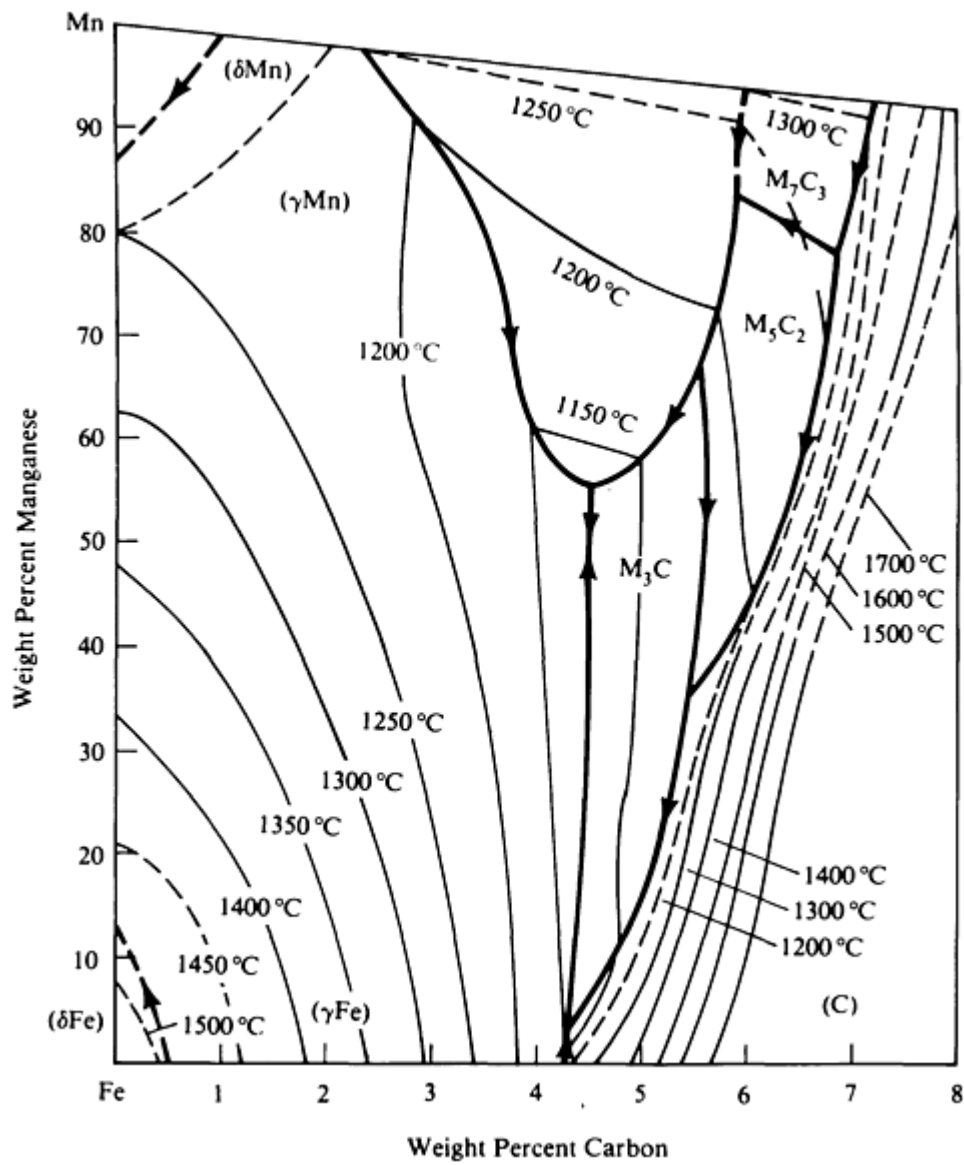

C-Fe-Mn liquidus projection [88Ray 60].

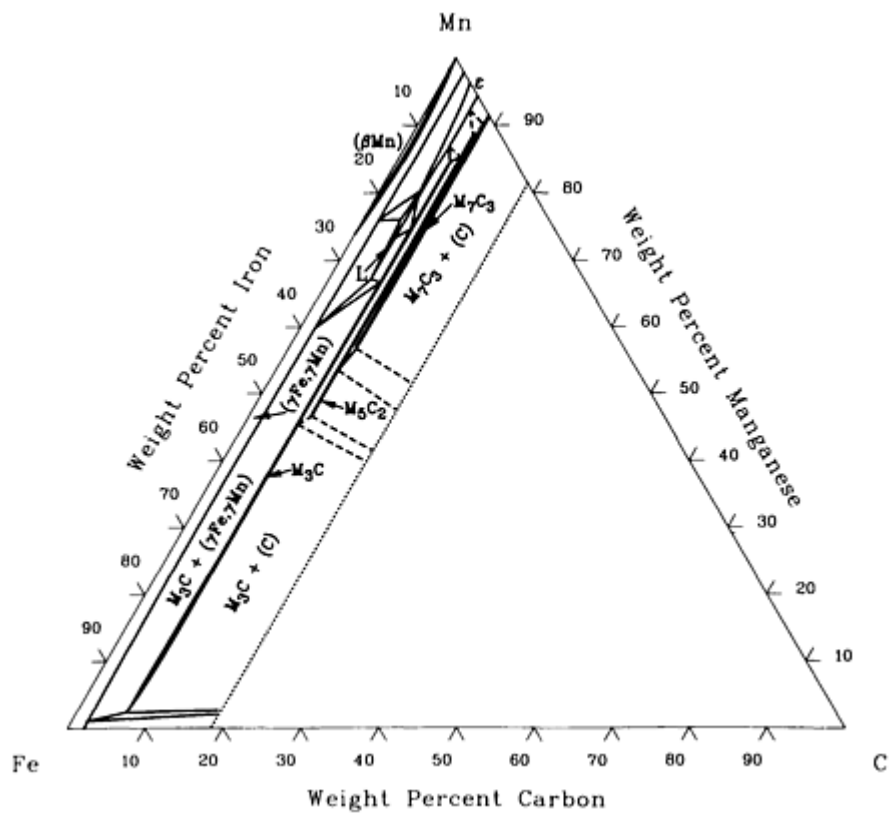

C-Fe-Mn isothermal section at 1100 °C [73Ben 26].

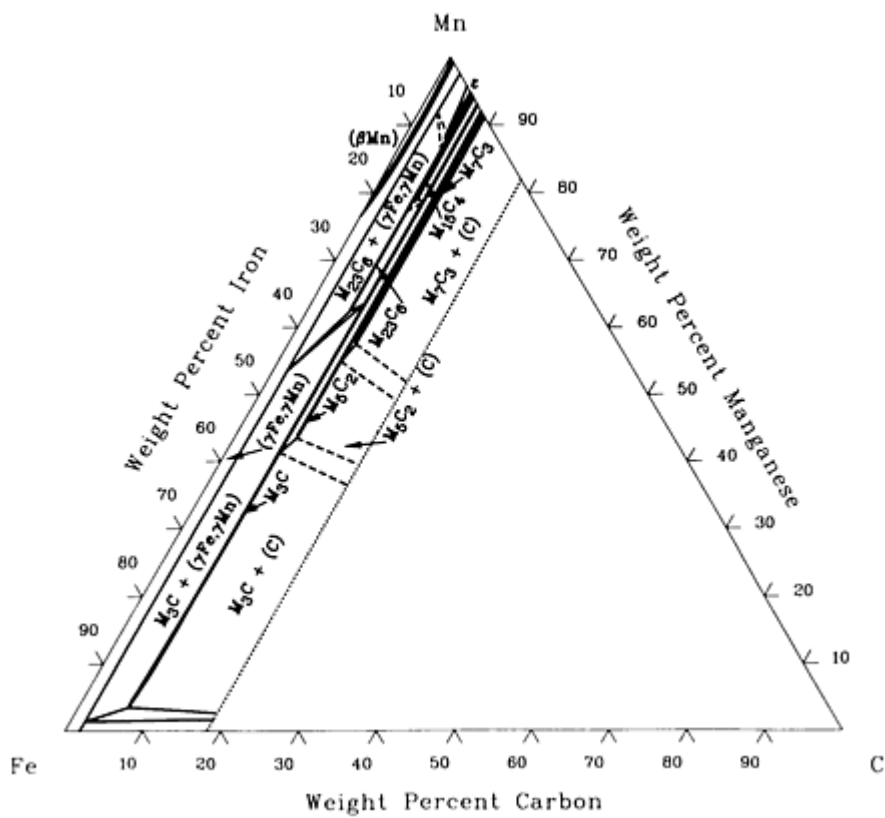

C-Fe-Mn isothermal section at 1000 °C [73Ben 26].

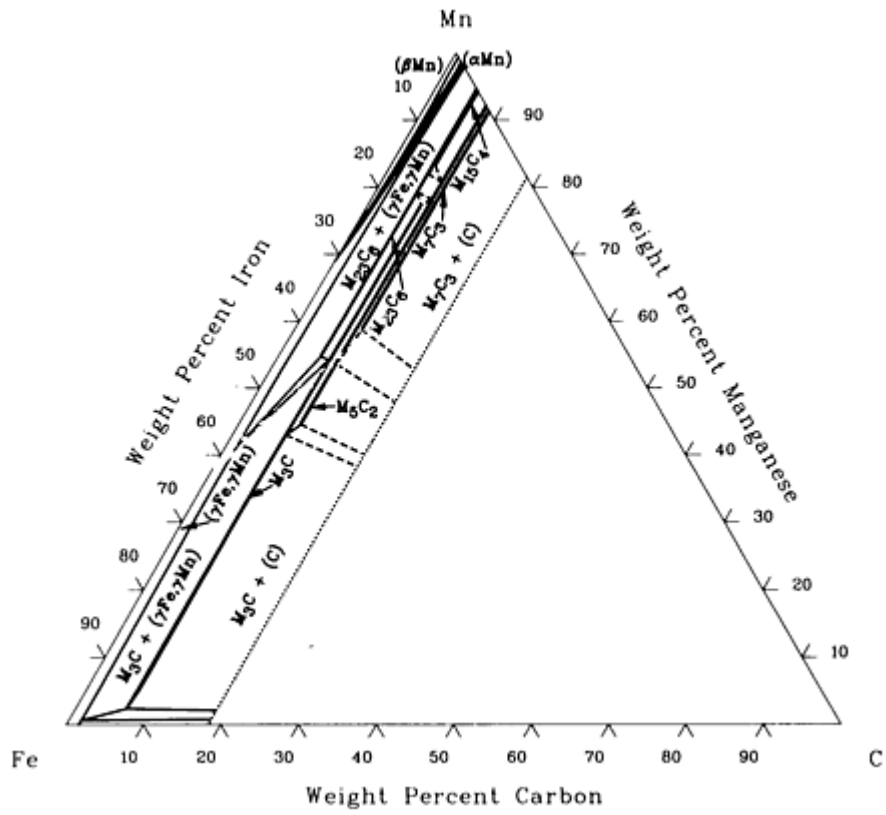

C-Fe-Mn isothermal section at 900 °C [73Ben 26].

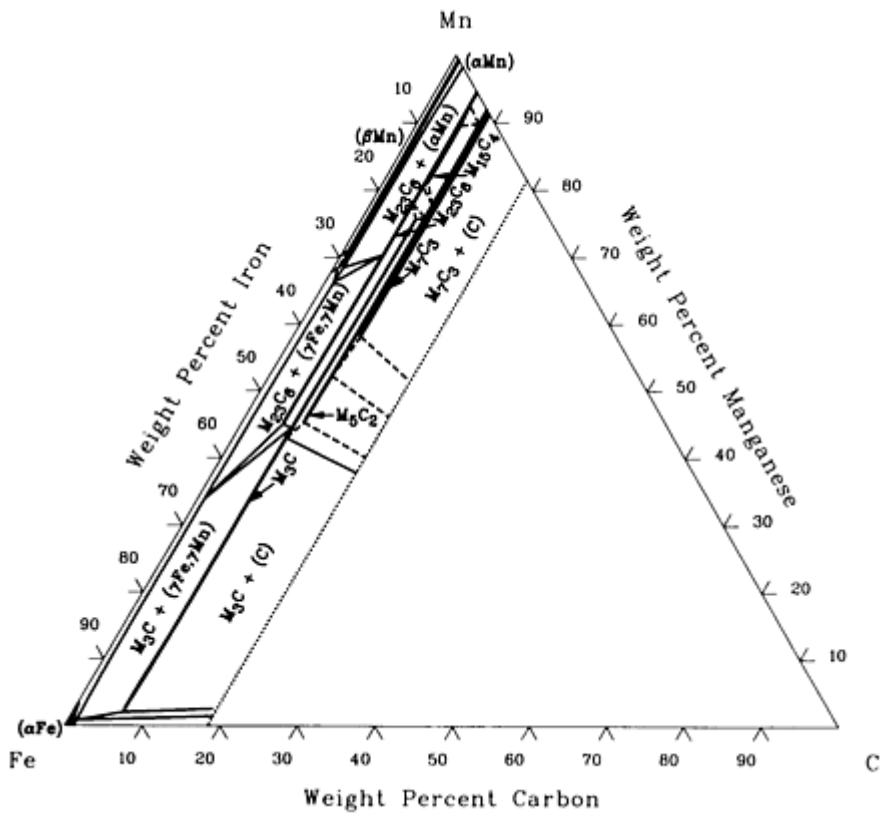

C-Fe-Mn isothermal section at 800 °C [73Ben 26].

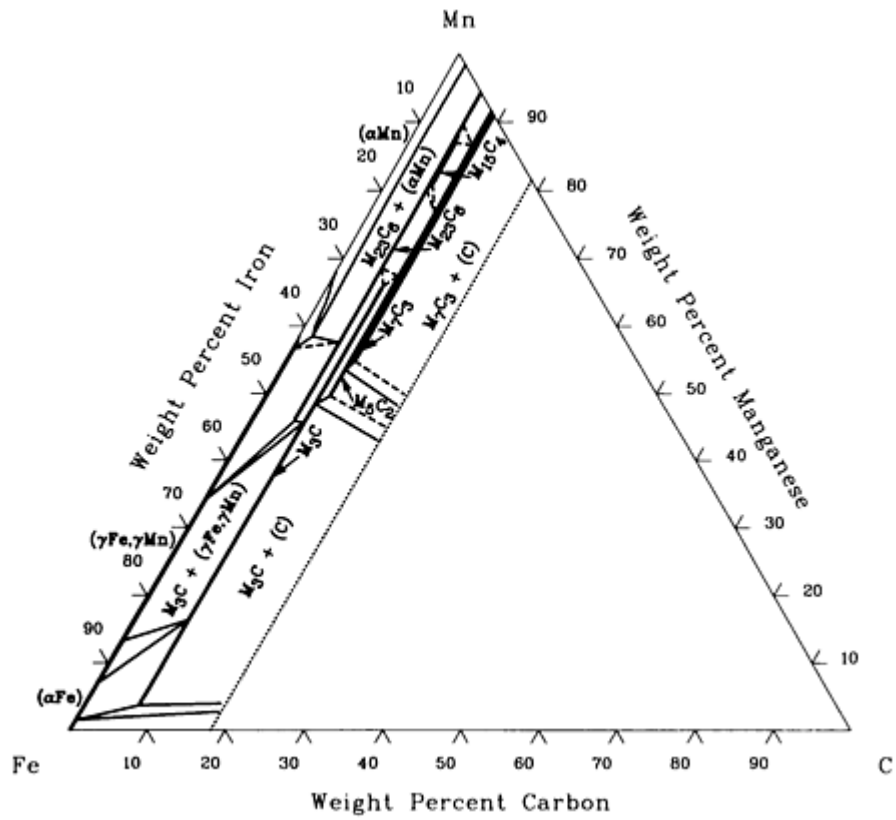

C-Fe-Mn isothermal section at 600 °C [73Ben 26].

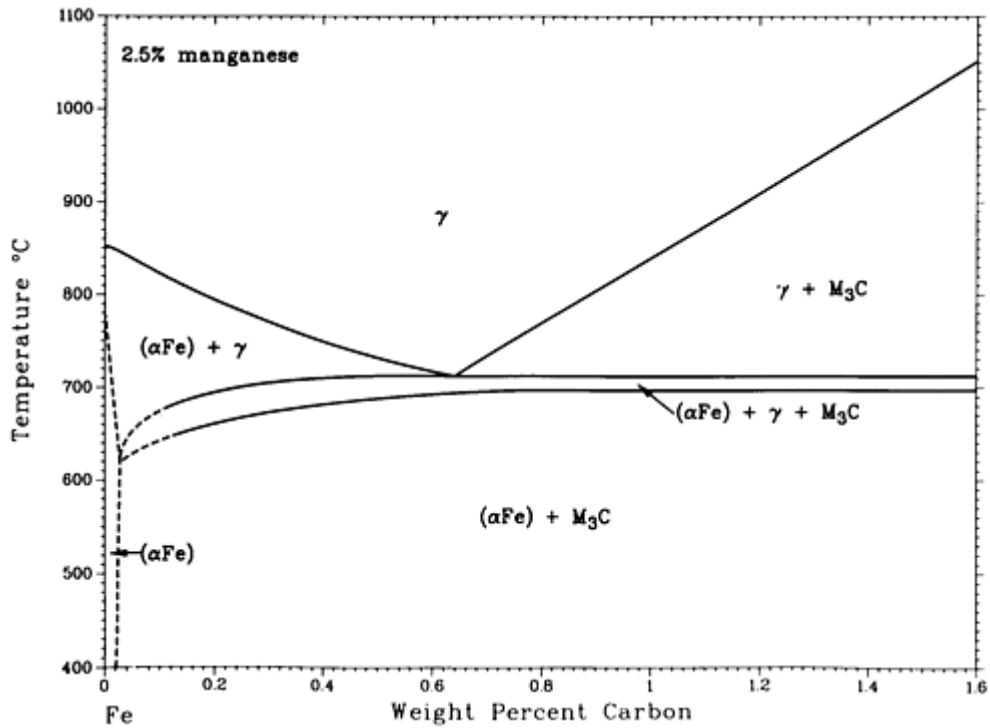

C-Fe-Mn [73Bre 28].

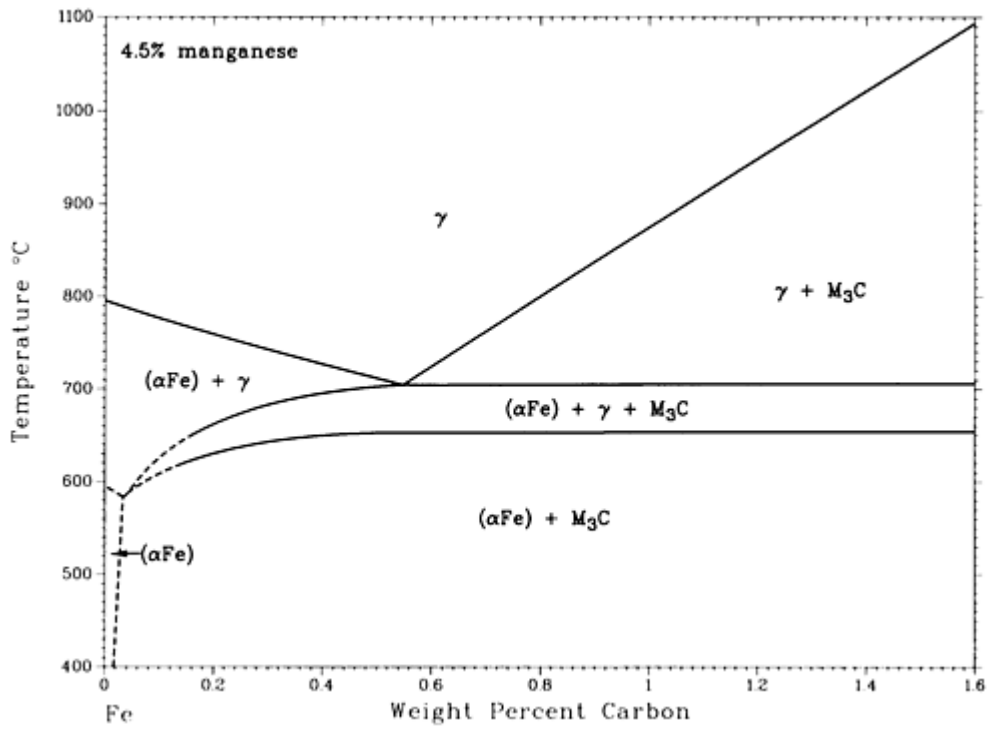

C-Fe-Mn [73Bre 28].

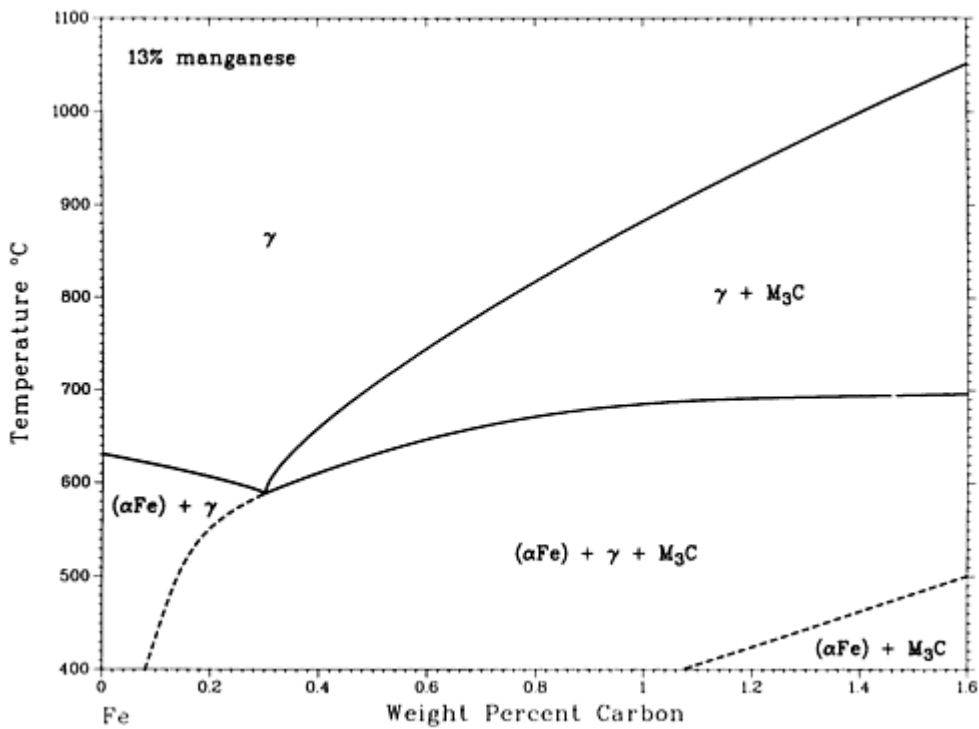

C-Fe-Mn [73Bre 28].

References cited in this section

73Ben: R. Benz, J.F. Elliott, and J. Chipman, "Thermodynamics of the Solid Phases in the System Fe-Mn-C," *Metall. Trans.*, Vol 4, 1973, p 1975-1986

73Bre: L. Brewer and S.-G. Chang, *Metallography, Structures and Phase Diagrams*, Vol 8, *Metals Handbook*, 8th ed., American Society for Metals, Metals Park, OH, 1973

C-Fe-Mo (Carbon - Iron - Molybdenum) Ternary Phase Diagrams

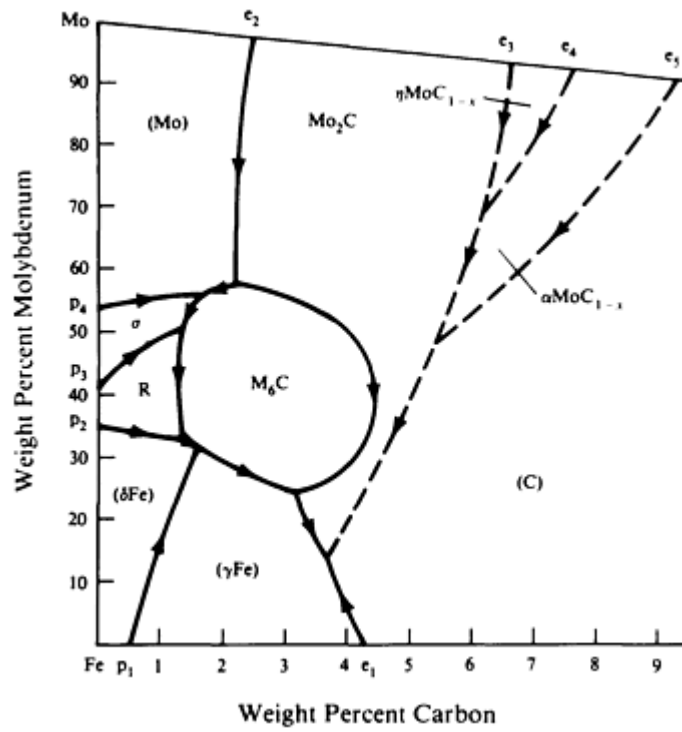

C-Fe-Mo liquidus projection [88Ray 60].

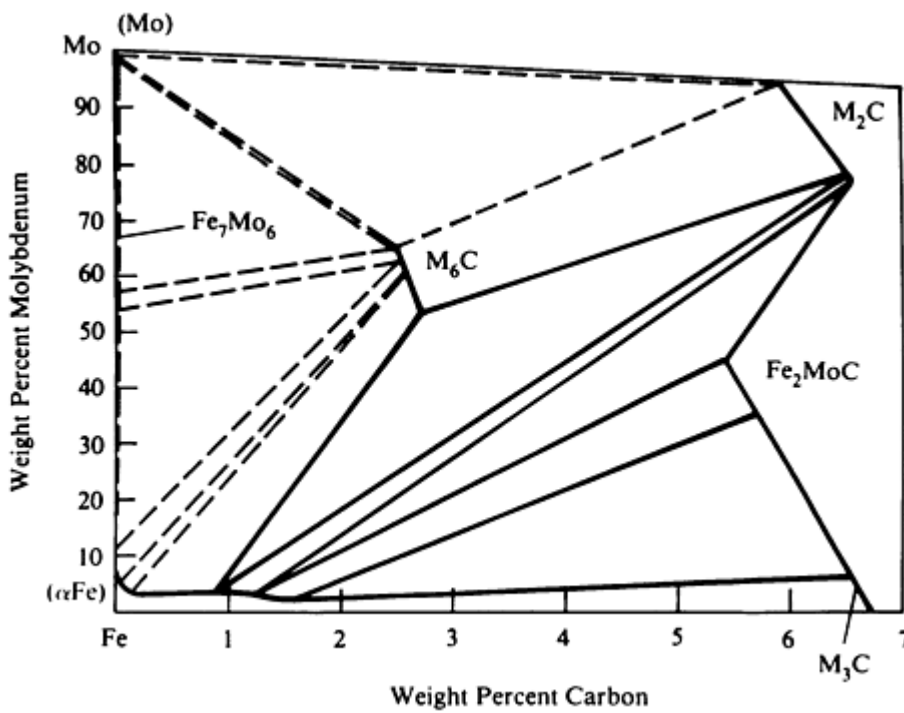

C-Fe-Mo isothermal section at 1000 °C [88Ray 60].

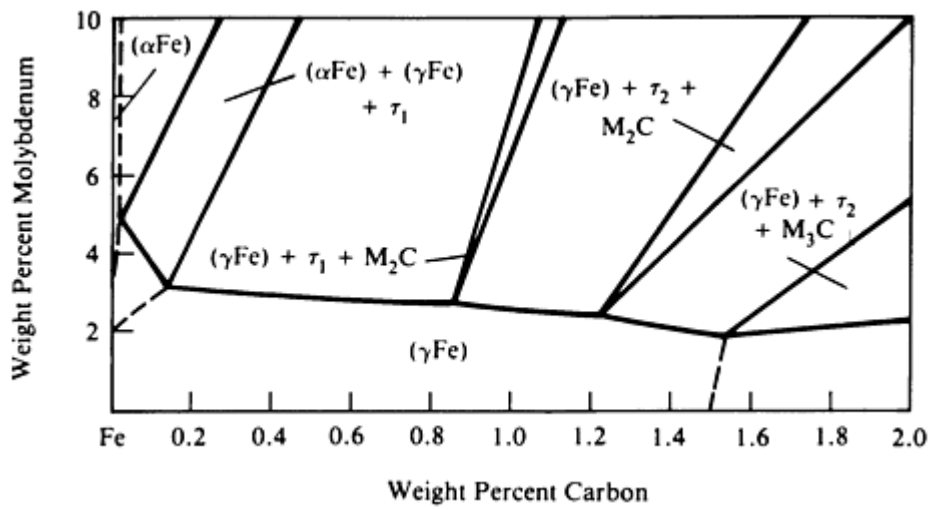

C-Fe-Mo (Fe) isothermal section at 1000 °C [88Ray 60].

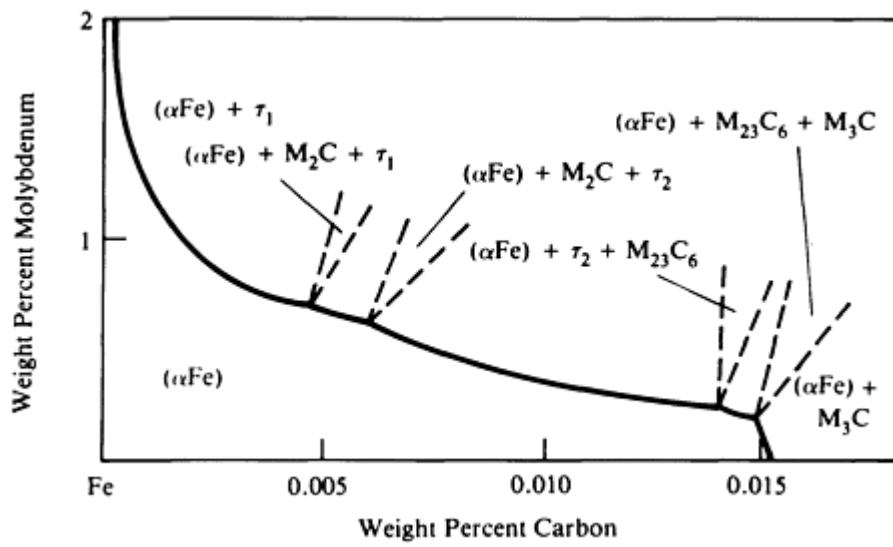

C-Fe-Mo isothermal section at 700 °C (calculated) [88Ray 60].

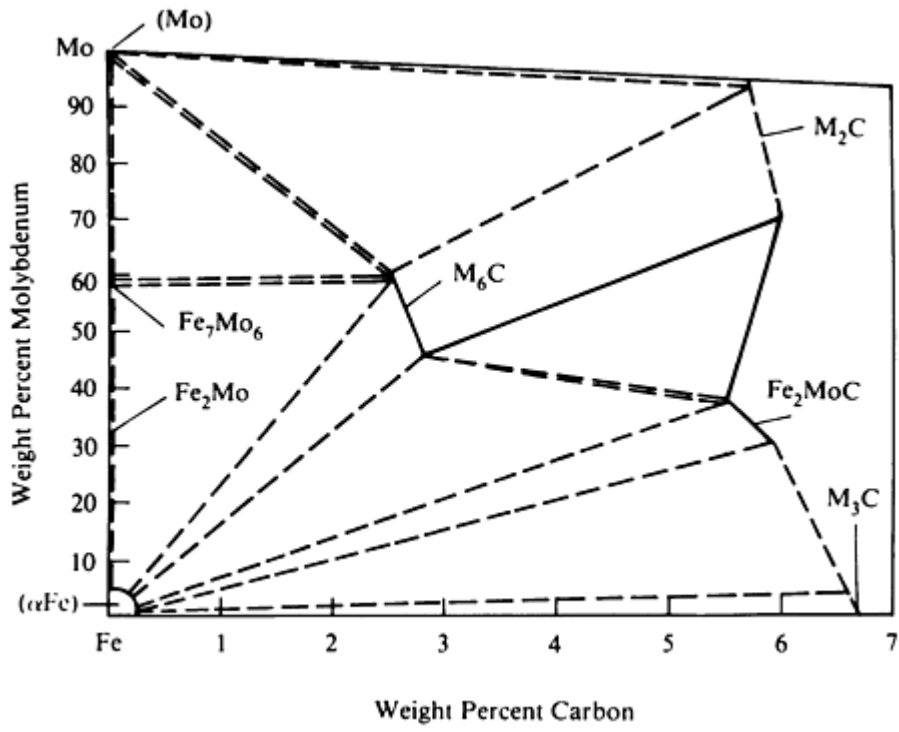

C-Fe-Mo (Fe) isothermal section at 700 °C [88Ray 60].

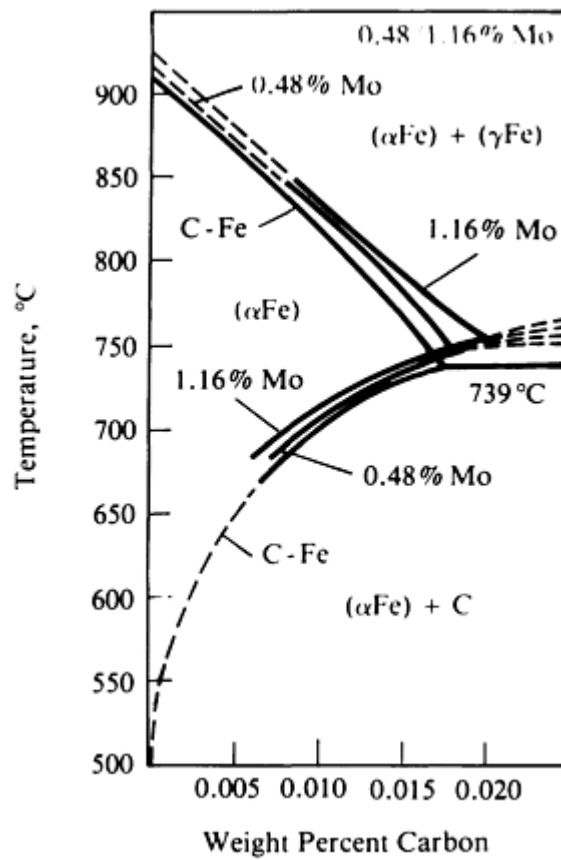

C-Fe-Mo [88Ray 60].

Reference cited in this section

88Ray: G.V. Raynor and V.G. Rivlin, *Phase Equilibria in Iron Ternary Alloys*, The Institute of Metals,

C-Fe-N (Carbon - Iron - Nitrogen) Ternary Phase Diagrams

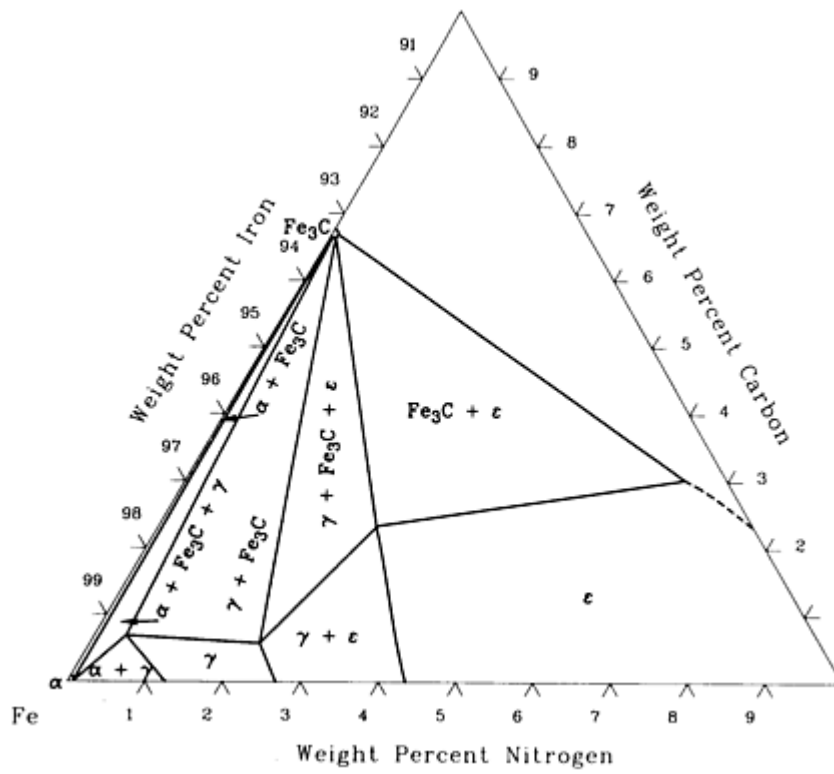

C-Fe-N isothermal section at 700 °C [87Rag 57].

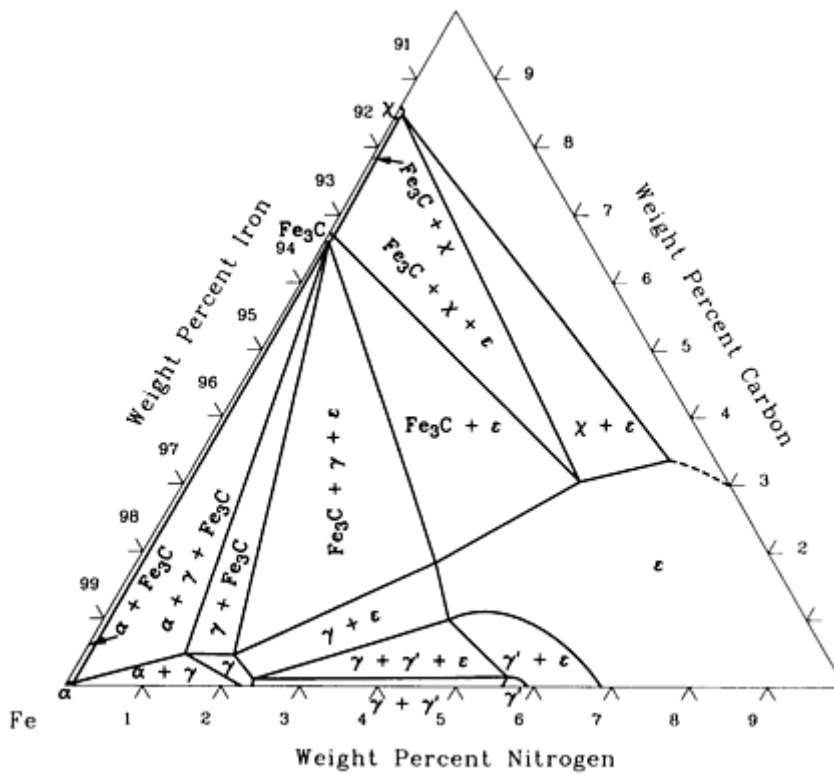

C-Fe-N isothermal section at 600 °C [87Rag 57].

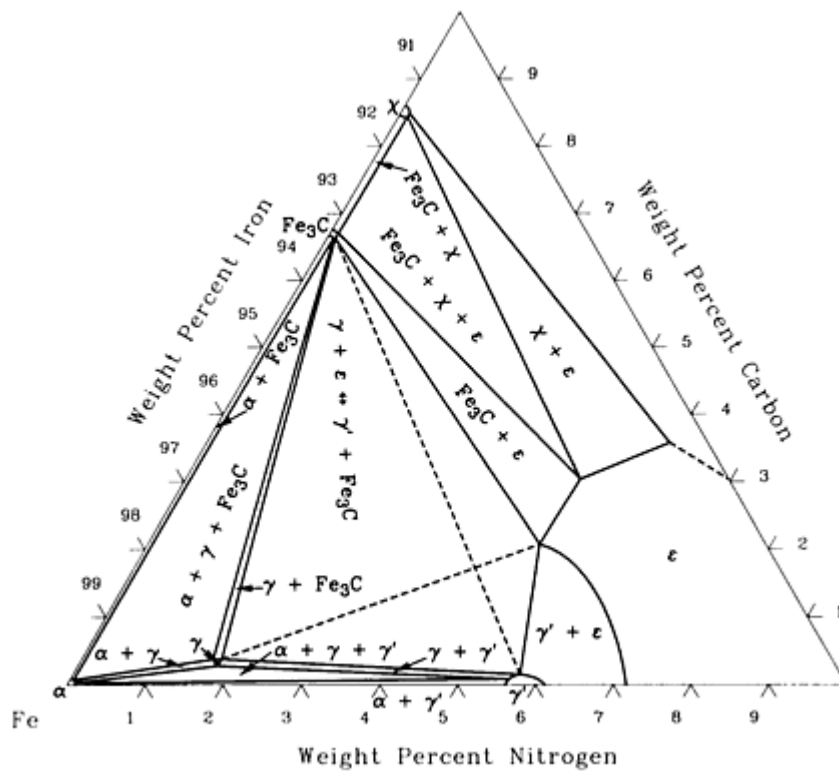

C-Fe-N isothermal section at 575 °C [87Rag 57].

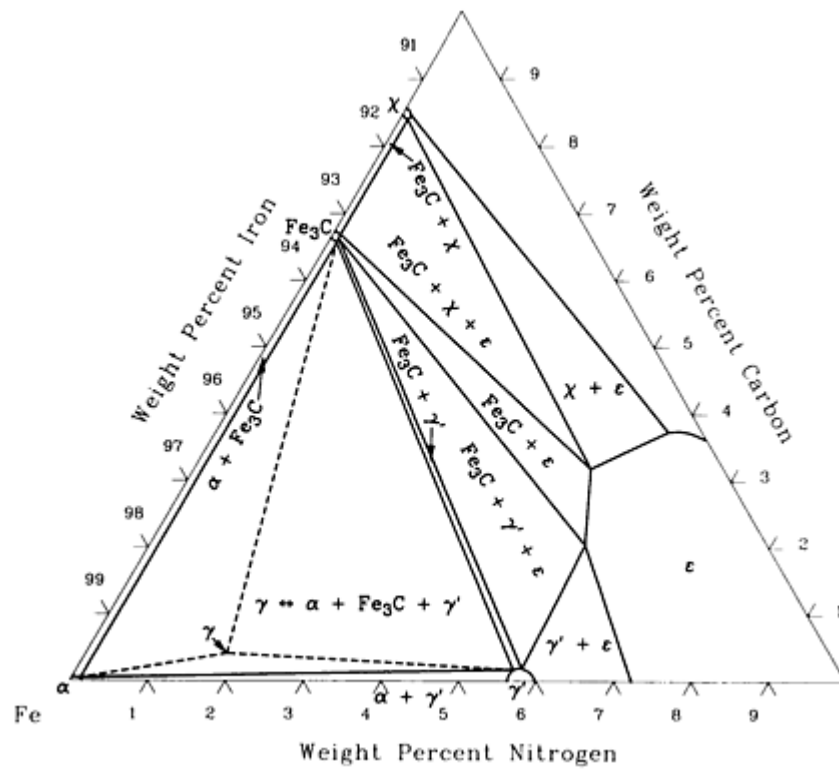

C-Fe-N isothermal section at 565 °C [87Rag 57].

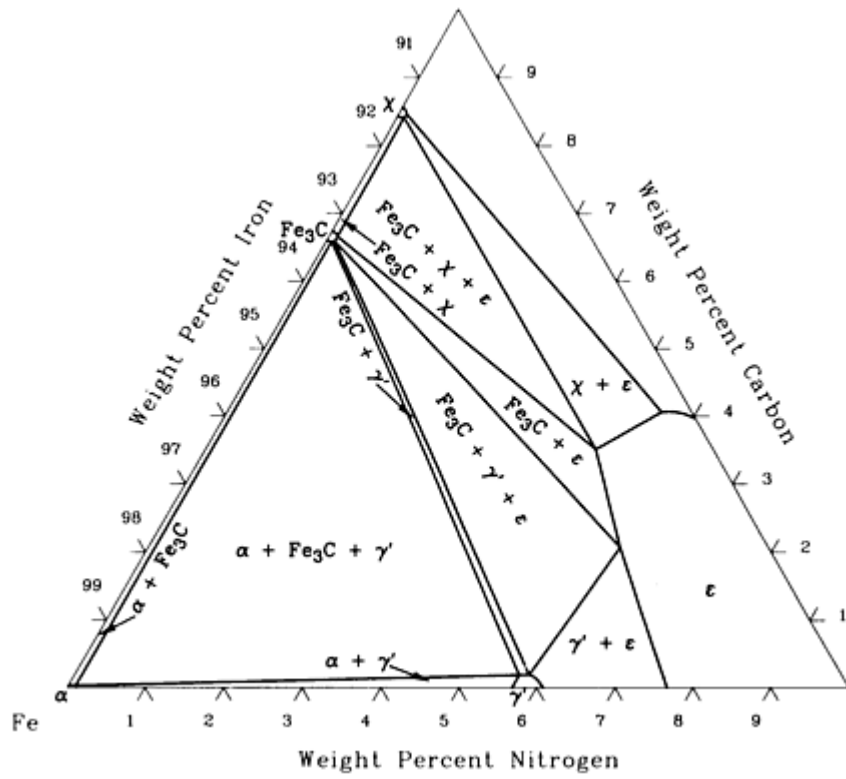

C-Fe-N isothermal section at 500 °C [87Rag 57].

Reference cited in this section

87Rag: V. Raghavan, *Phase Diagrams of Ternary Iron Alloys*, The Indian Institute of Metals, Calcutta, India, (No. 1), 1987

C-Fe-Ni (Carbon - Iron - Nickel) Ternary Phase Diagrams

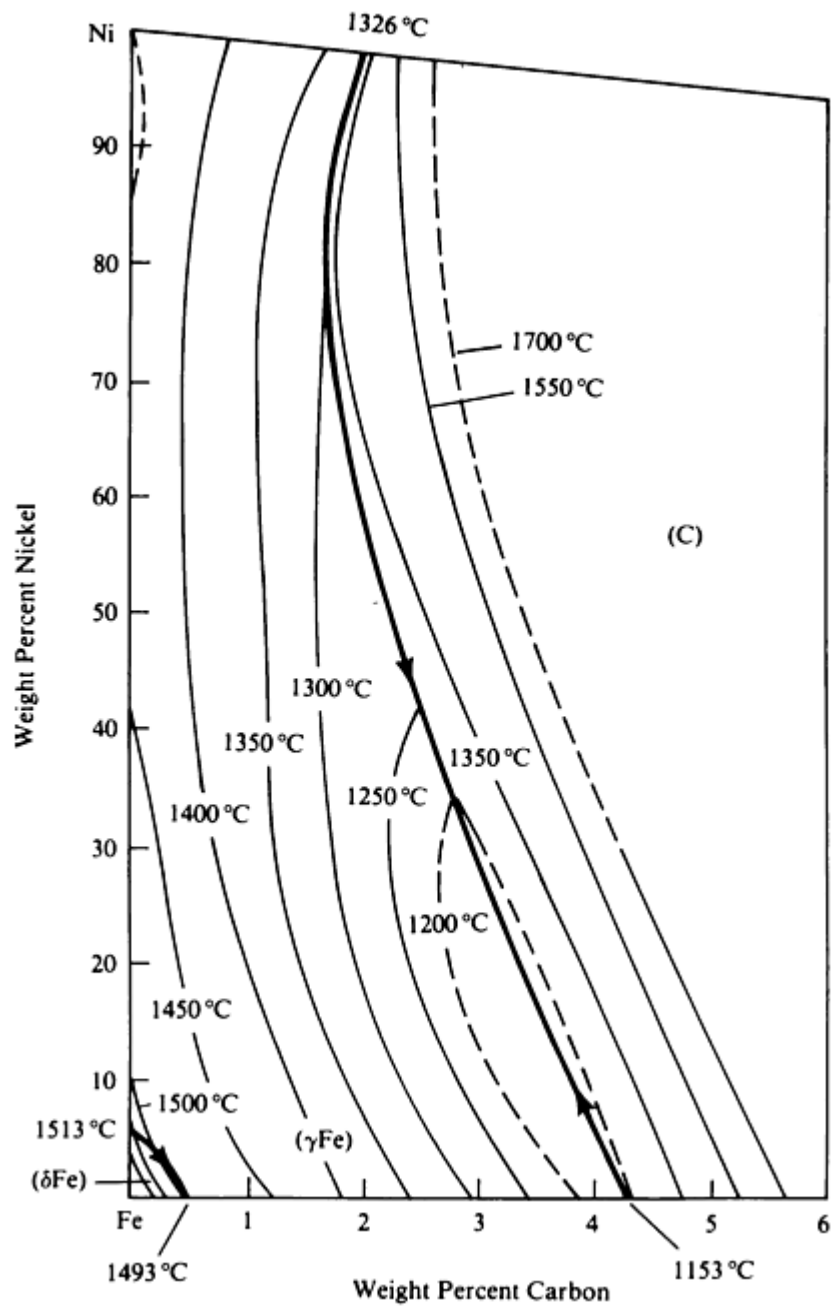

C-Fe-Ni liquidus projection [88Ray 60].

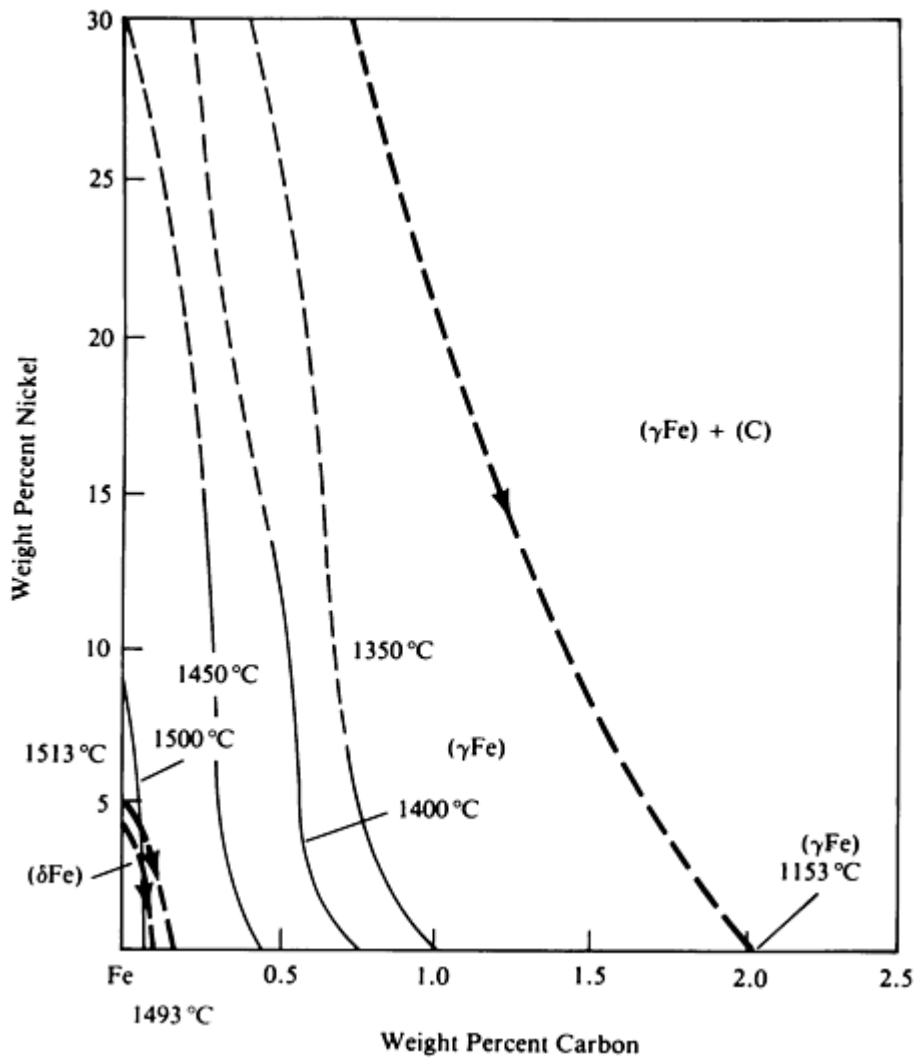

C-Fe-Ni solidus projection [88Ray 60].

C-Fe-Ni γ Fe/ (γ Fe + C) boundary at 800 and 1000 °C [88Ray]

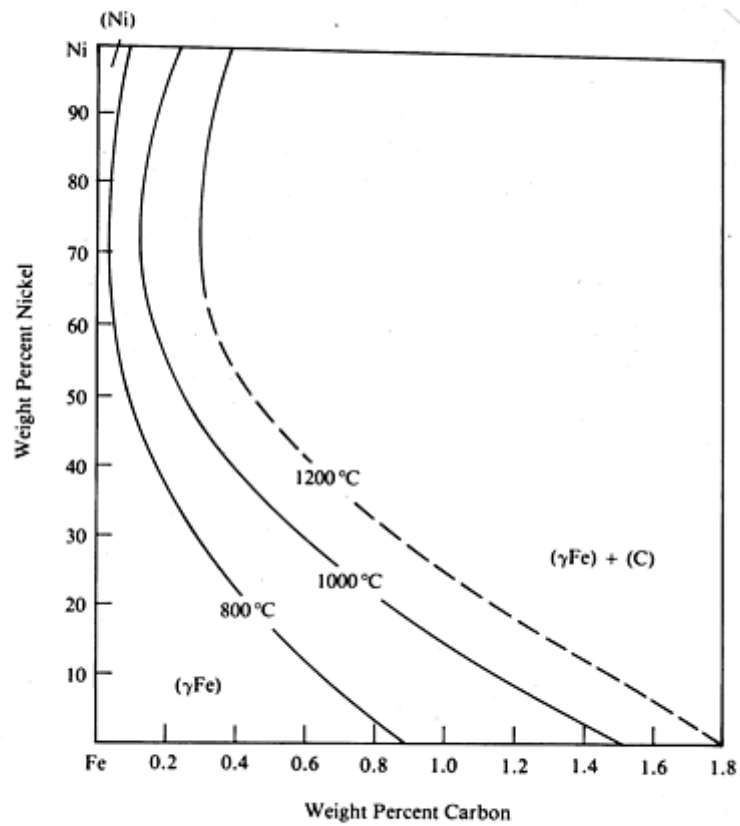

Note that at 800 °C the (α Fe) phase will also appear at low Ni contents.

C-Fe-Ni γ Fe/ (γ Fe + C) boundary at 800 and 1000 °C [88Ray 60].

Reference cited in this section

88Ray: G.V. Raynor and V.G. Rivlin, *Phase Equilibria in Iron Ternary Alloys*, The Institute of Metals, London, (No. 4), 1988

C-Fe-Ni (Carbon - Iron - Nickel) Ternary Phase Diagrams

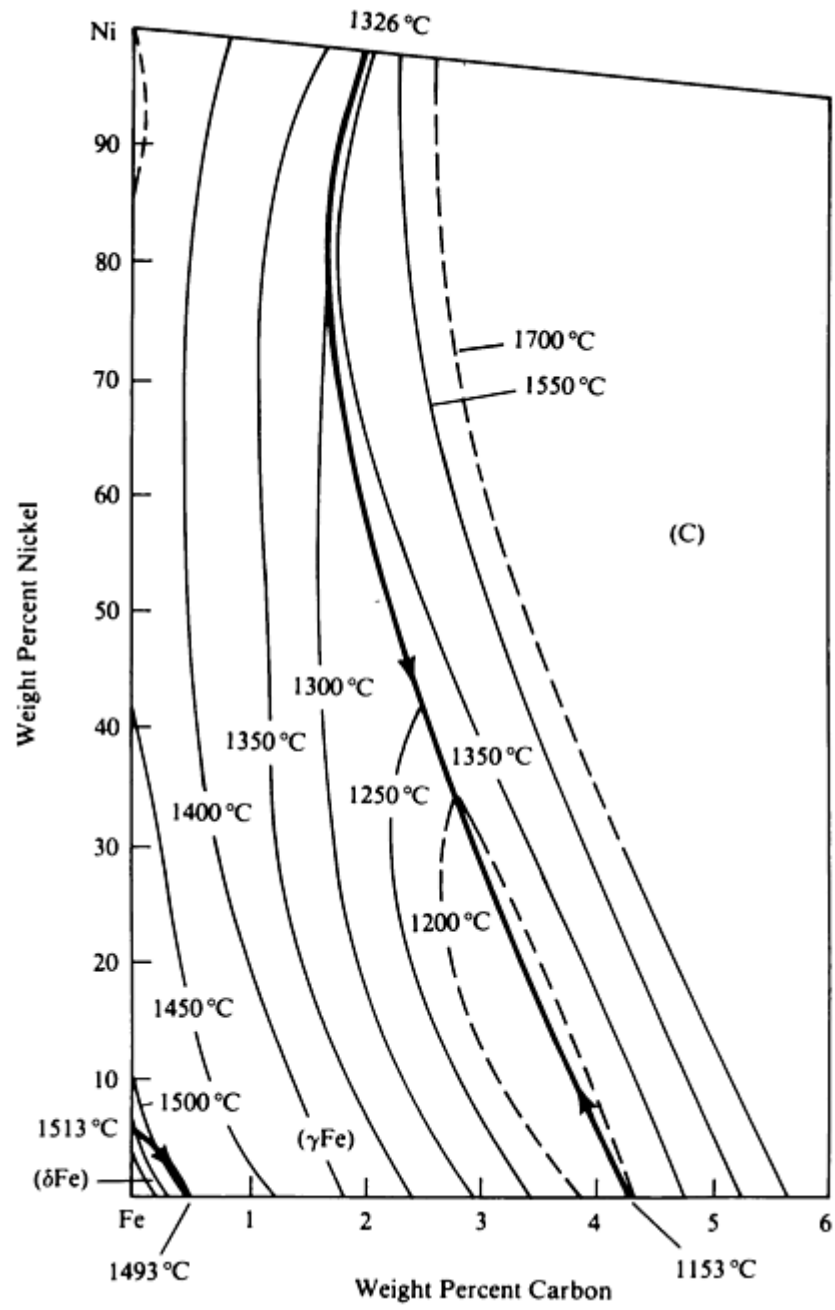

C-Fe-Ni liquidus projection [88Ray 60].

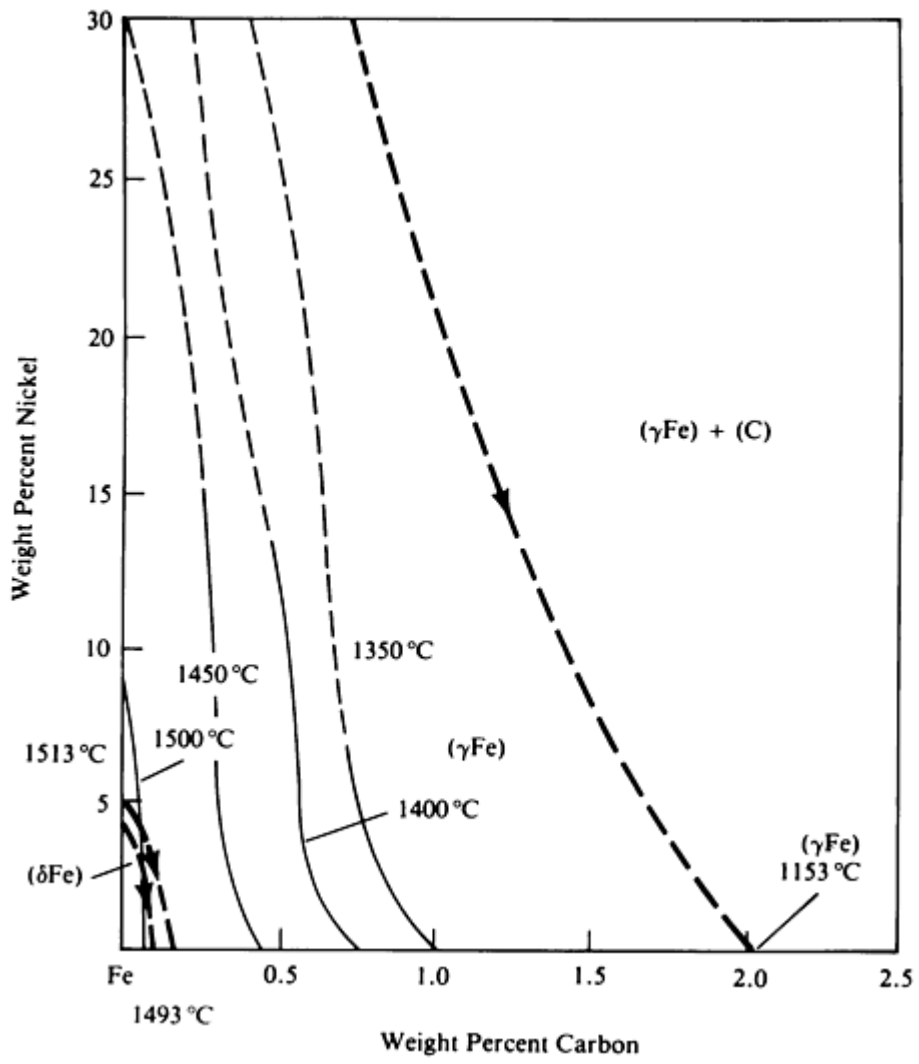

C-Fe-Ni solidus projection [88Ray 60].

C-Fe-Ni γ Fe/ (γ Fe + C) boundary at 800 and 1000 °C [88Ray]

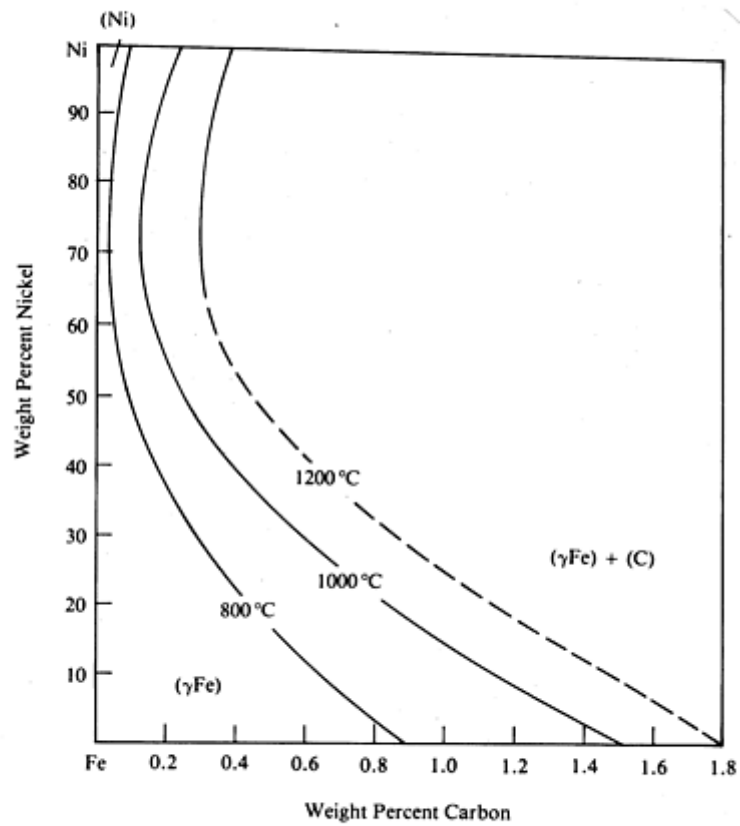

Note that at 800 °C the (α Fe) phase will also appear at low Ni contents.

C-Fe-Ni γ Fe/ (γ Fe + C) boundary at 800 and 1000 °C [88Ray 60].

Reference cited in this section

88Ray: G.V. Raynor and V.G. Rivlin, *Phase Equilibria in Iron Ternary Alloys*, The Institute of Metals, London, (No. 4), 1988

C-Fe-V (Carbon - Iron - Vanadium) Ternary Phase Diagrams

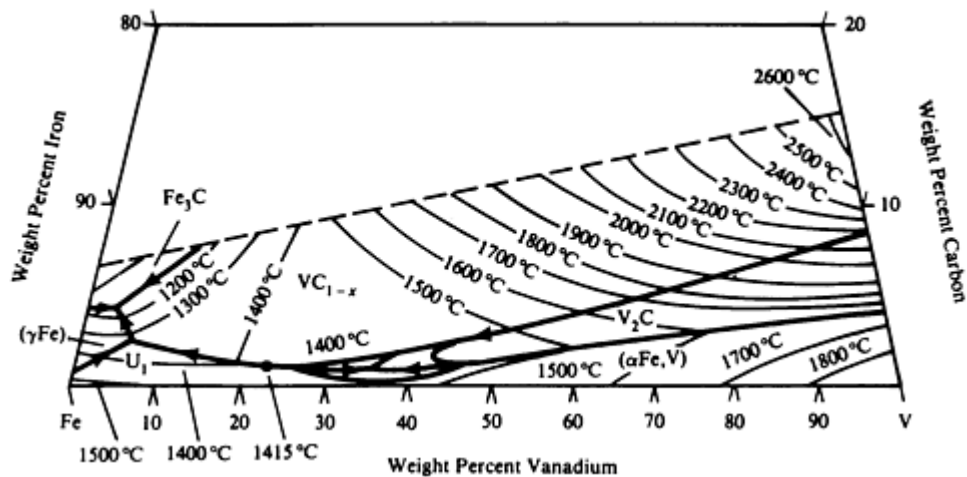

C-Fe-V liquidus projection [87Rag 57].

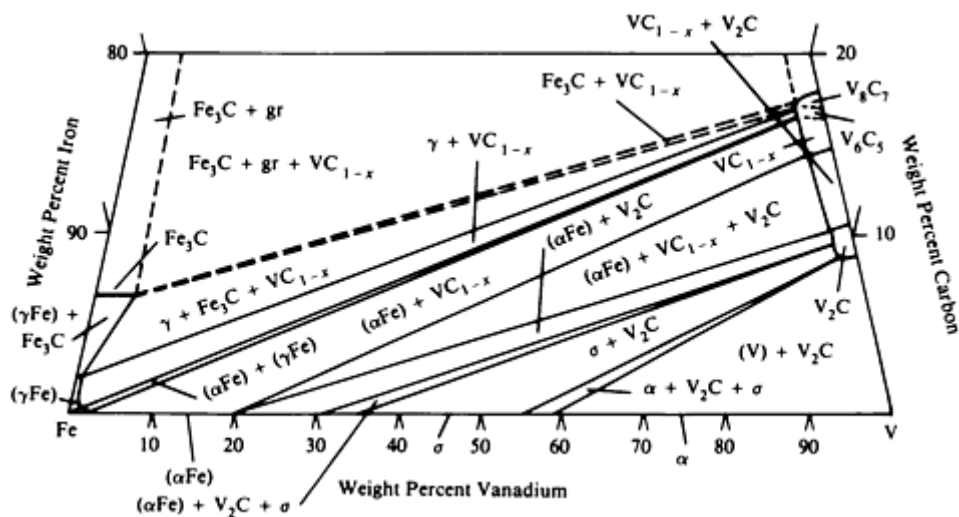

C-Fe-V isothermal section at 1100 °C [87Rag 57].

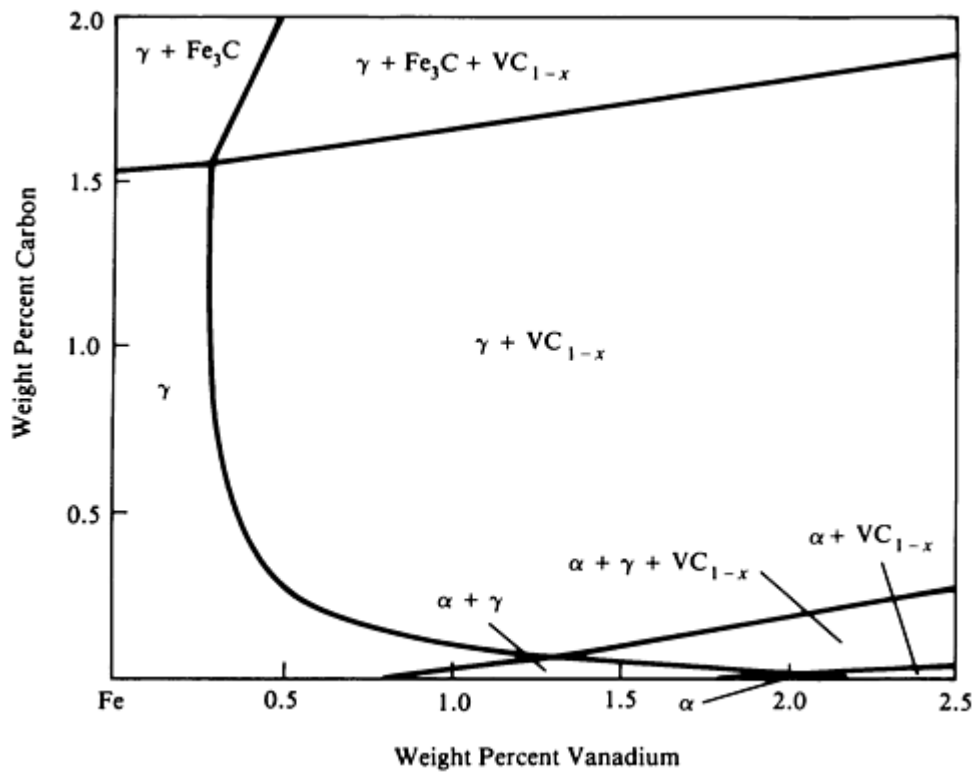

C-Fe-V isothermal section at 1000 °C [87Rag 57].

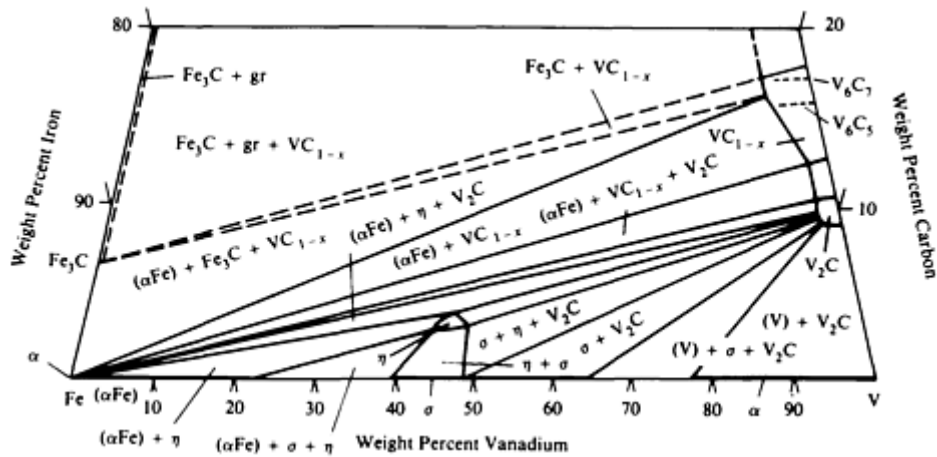

C-Fe-V isothermal section at 500 °C [87Rag 57].

Reference cited in this section

87Rag: V. Raghavan, *Phase Diagrams of Ternary Iron Alloys*, The Indian Institute of Metals, Calcutta, India, (No. 1), 1987

Introduction

THIS ARTICLE includes systems where cadium is the first-named element in the ternary system. Additional ternary systems that include cadium are provided in the following locations in this Volume:

- “Ag-Cd-Cu (Silver - Cadmium - Copper)” and “Ag-Cd-Zn (Silver - Cadmium - Zinc)” in the article “Ag (Silver) Ternary Phase Diagrams.”

Cd-Sb-Sn (Cadmium - Antimony - Tin) Ternary Phase Diagrams

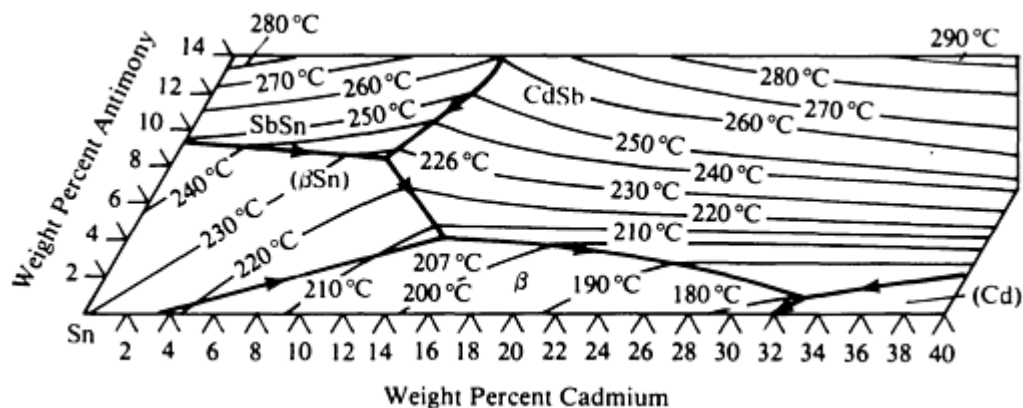

Cd-Sb-Sn liquidus projection [73Pel 32].

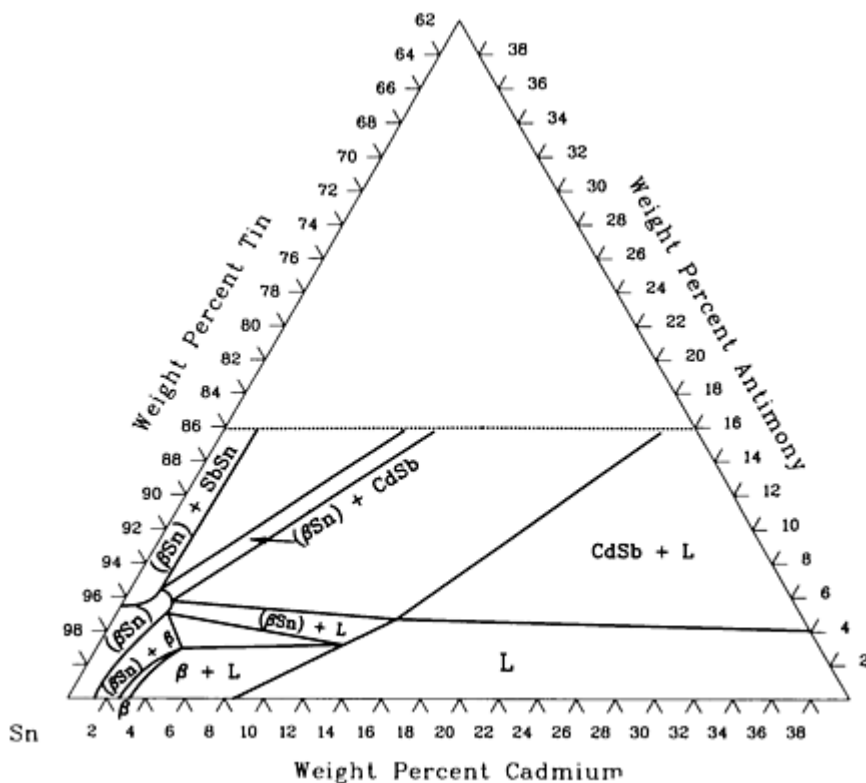

Cd-Sb-Sn isothermal section at 212 °C [73Pel 32].

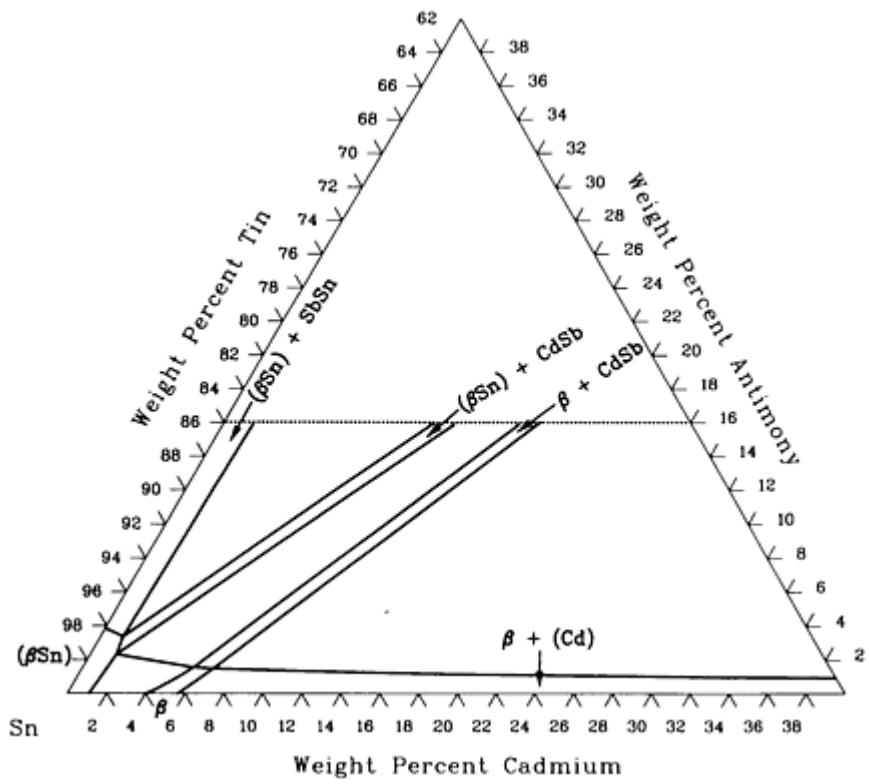

Cd-Sb-Sn isothermal section at 175 °C [73Pel 32].

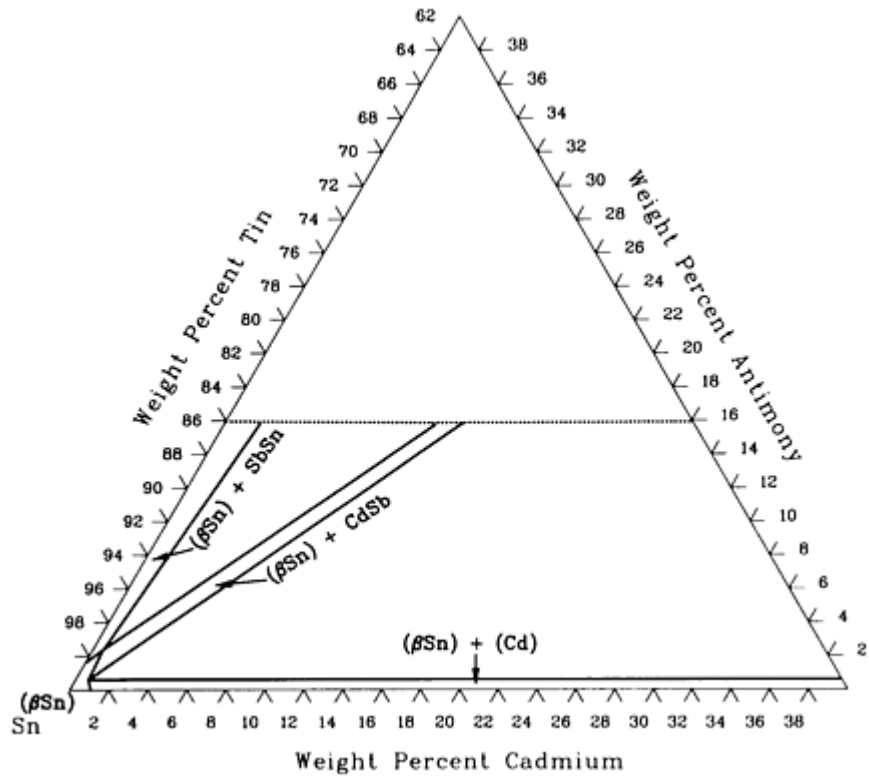

Cd-Sb-Sn isothermal section at 20 °C [73Pel 32].

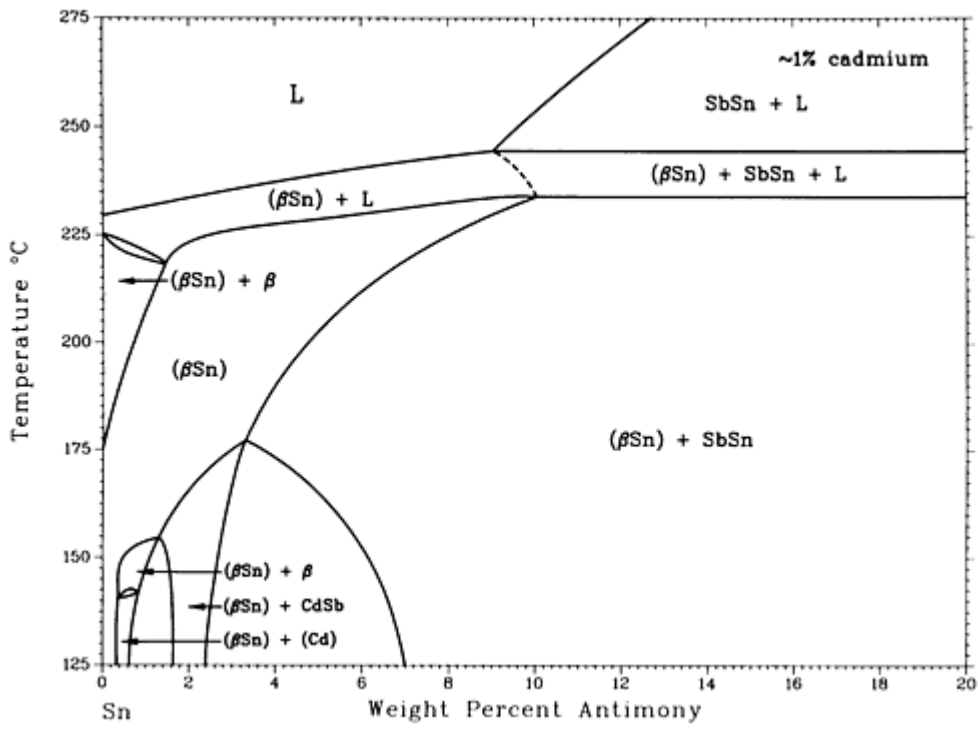

Cd-Sb-Sn [73Pel 32].

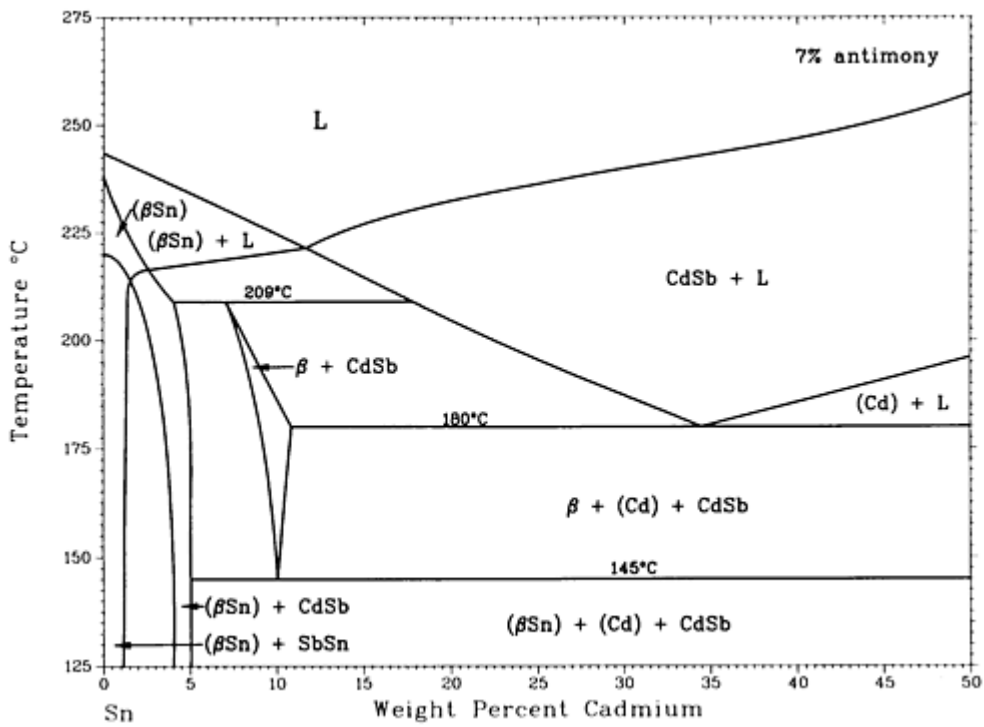

Cd-Sb-Sn [73Pel 32].

Reference cited in this section

73Pel: W.T. Pell-Walpole and C.T. Thwaites, *Metallography, Structures and Phase Diagrams*, Vol 8, *Metals Handbook*, 8th ed., American Society for Metals, Metals Park, OH 1973

Introduction

THIS ARTICLE includes systems where cobalt is the first-named element in the ternary system.

Co-Cr-Fe (Cobalt - Chromium - Iron) Ternary Phase Diagrams

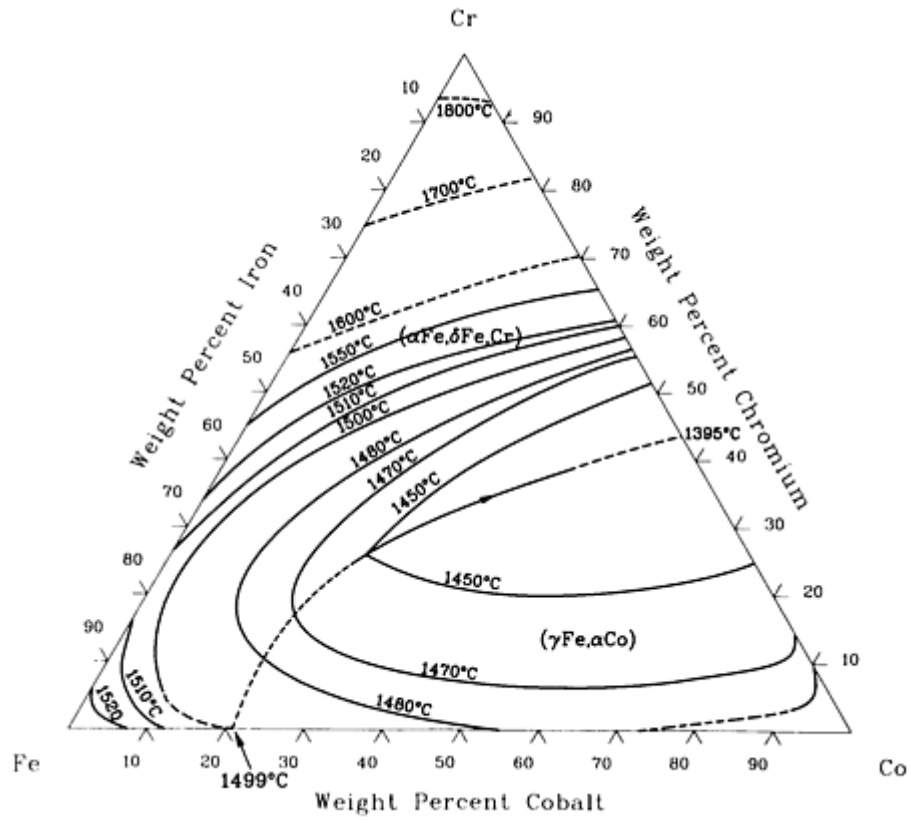

Co-Cr-Fe liquidus projection [88Ray 60].

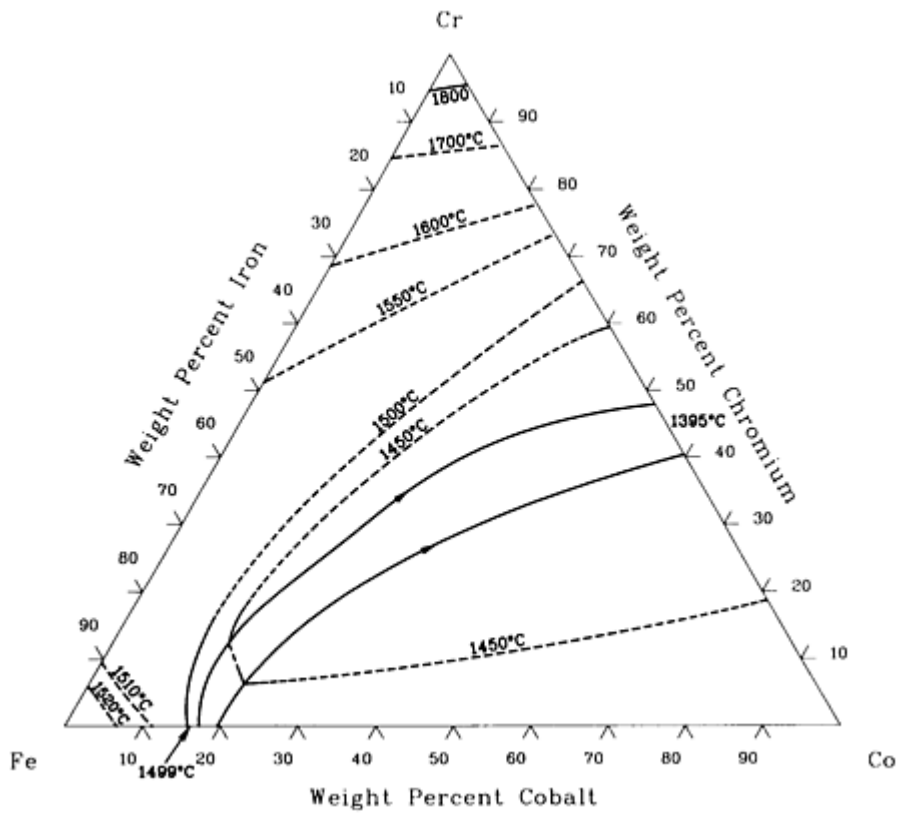

Co-Cr-Fe solidus projection [88Ray 60].

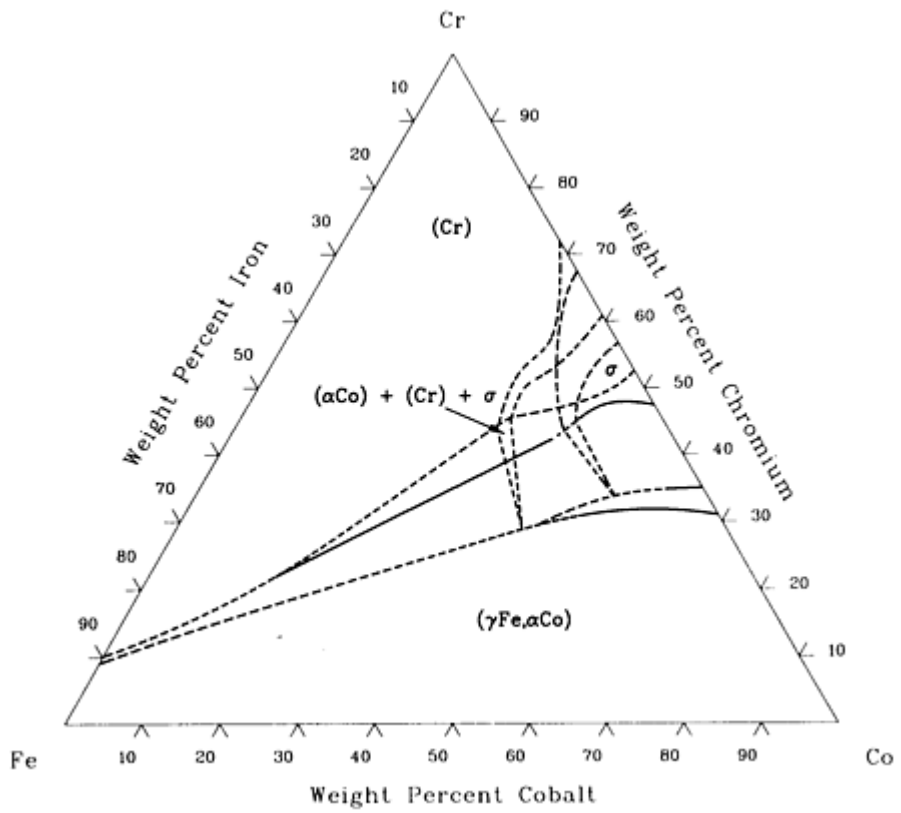

Co-Cr-Fe isothermal section at 1200 °C [88Ray 60].

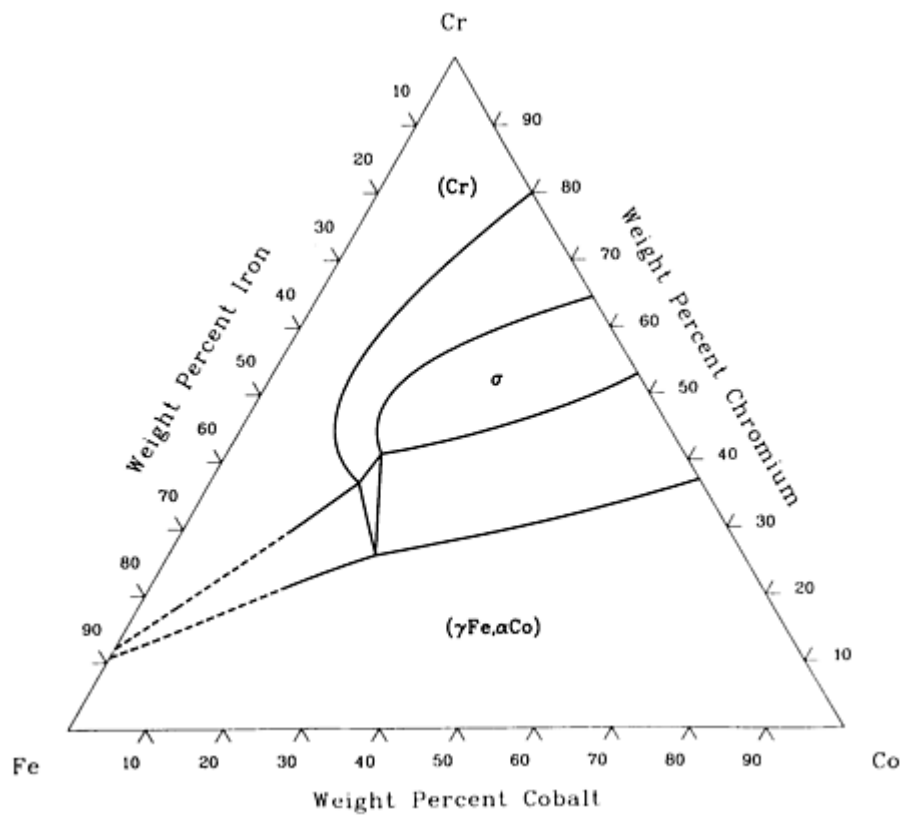

Co-Cr-Fe isothermal section at 1000 °C [88Ray 60].

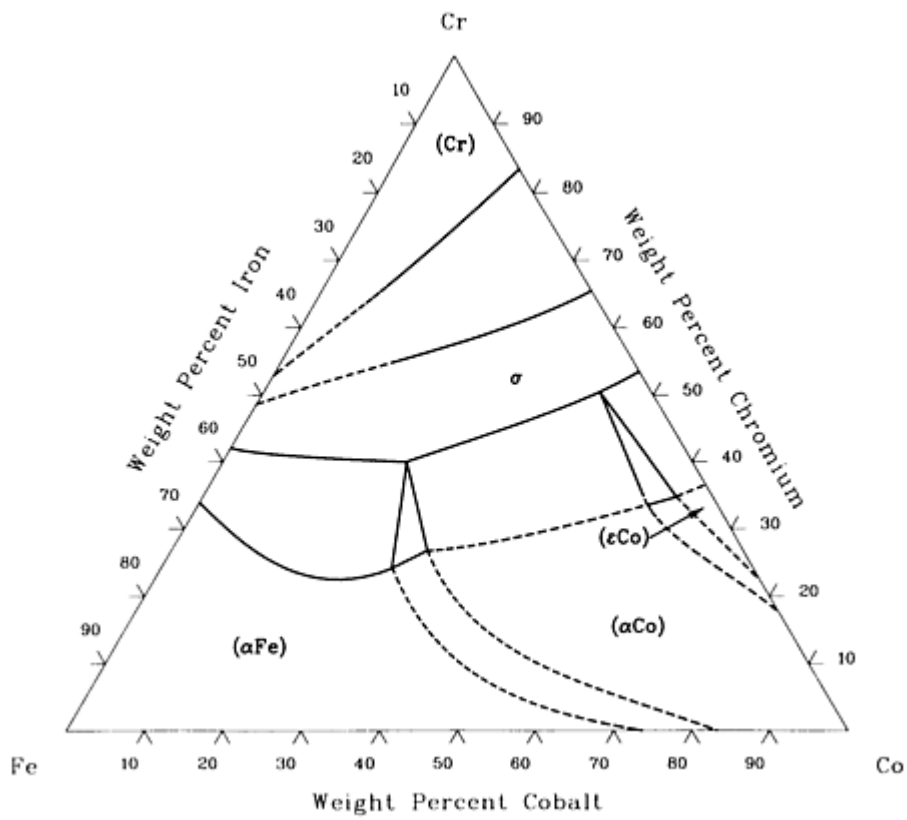

Co-Cr-Fe isothermal section at 800 °C [88Ray 60].

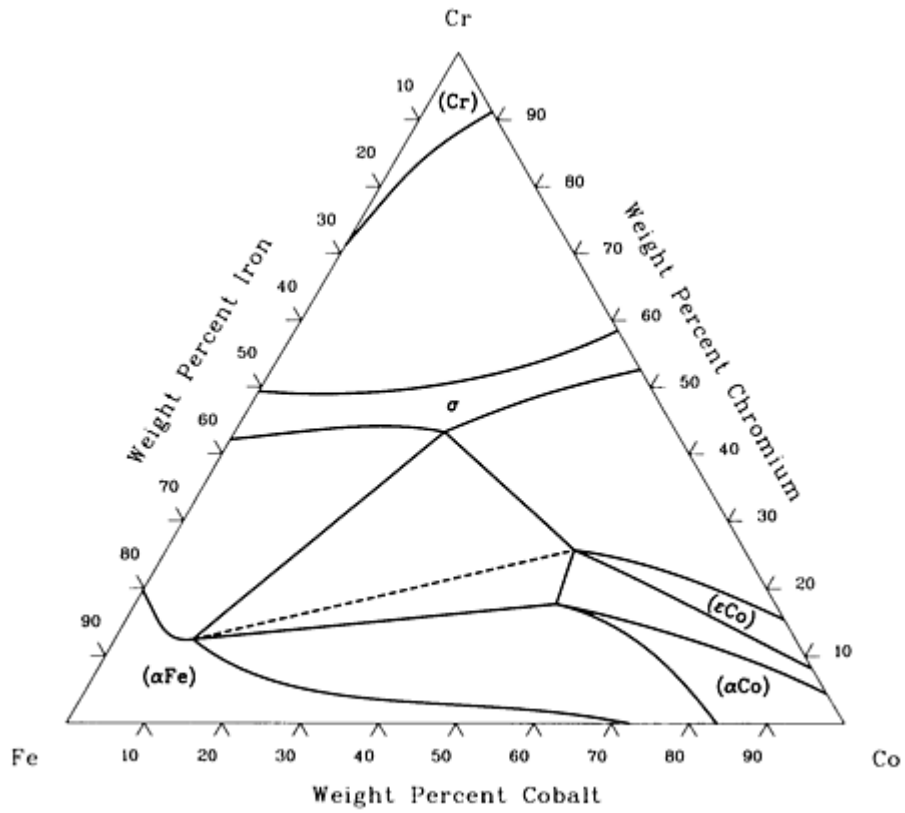

Co-Cr-Fe isothermal section at 600 °C [88Ray 60].

Reference cited in this section

88Ray: G.V. Raynor and V.G. Rivlin, *Phase Equilibria in Iron Ternary Alloys*, The Institute of Metals, London, (No. 4), 1988

Co-Cr-Ni (Cobalt - Chromium - Nickel) Ternary Phase Diagrams

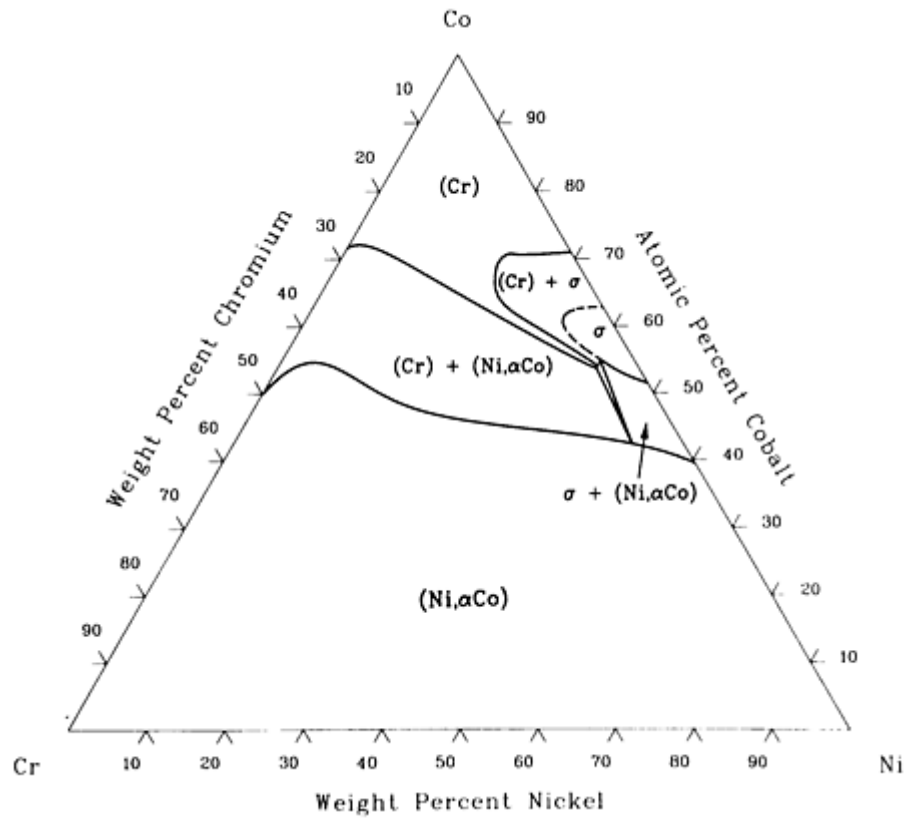

Co-Cr-Ni isothermal section at 1200 °C [81Zha 42].

Reference cited in this section

81Zha: Jin Zhanpeng, "A Study of the Range of Stability of sigma Phase in Some Ternary Systems," *Scand. J. Metall.*, Vol 10, 1981, p 279-287

Co-Cr-Ti (Cobalt - Chromium - Titanium) Ternary Phase Diagrams

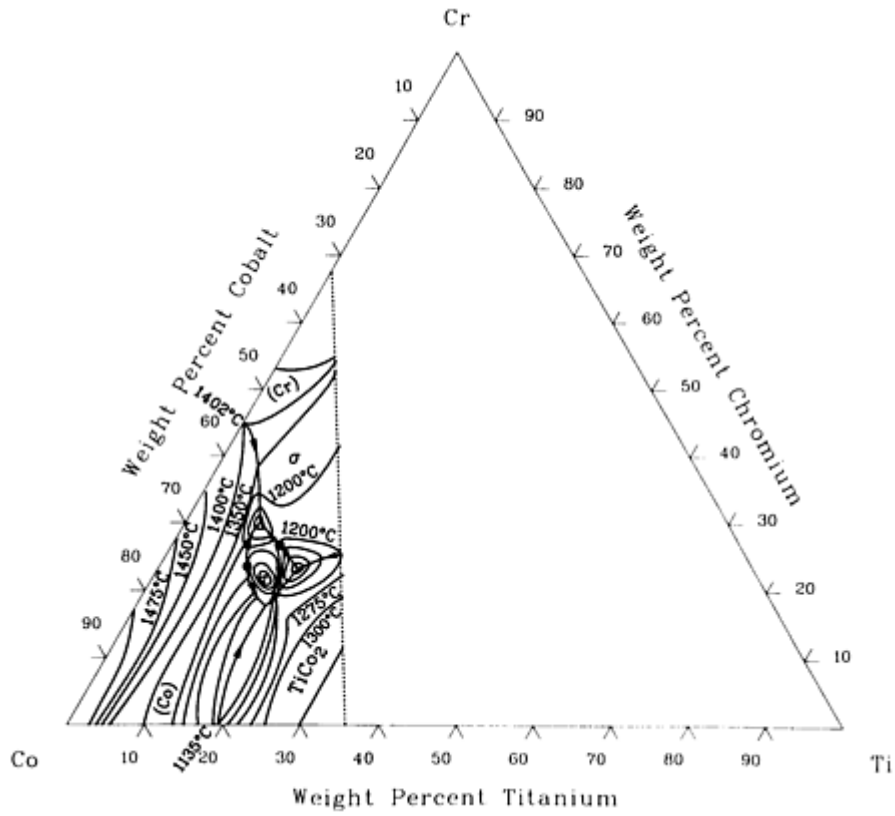

Co-Cr-Ti liquidus projection [62Zak 15].

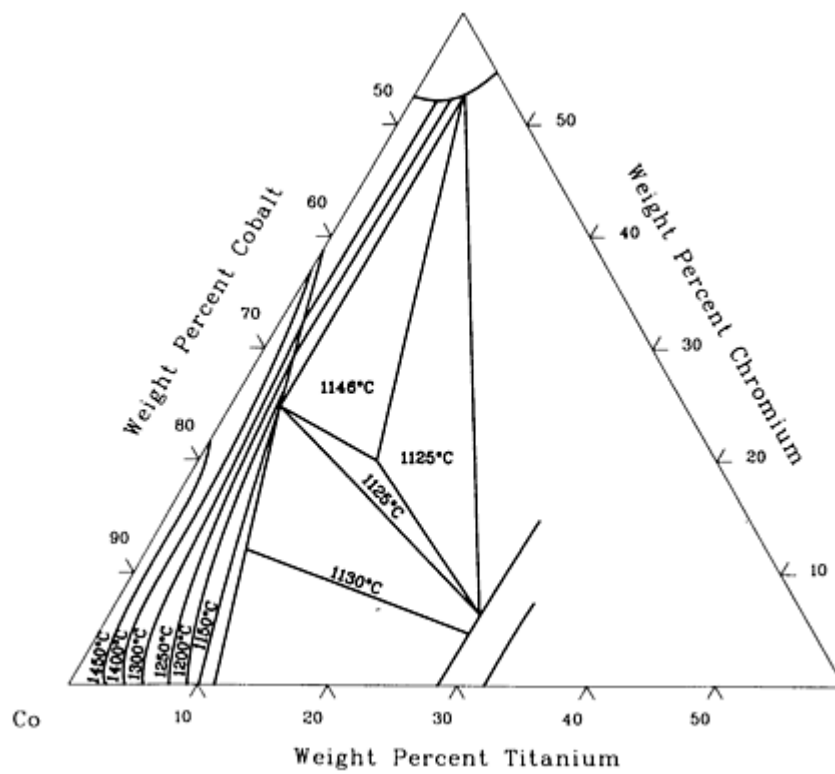

Co-Cr-Ti solidus projection [62Zak 15].

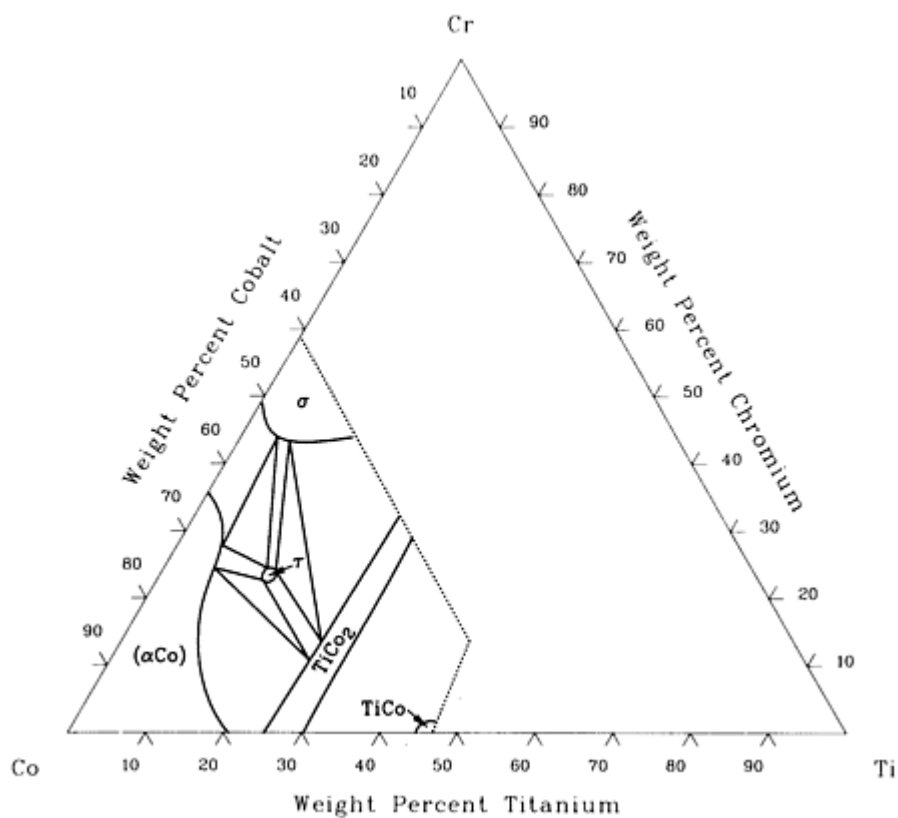

Co-Cr-Ti isothermal section at 1050 °C [58Liv 11].

References cited in this section

58Liv: B.G. Livshits and Ya.D. Khorin, "Study of Equilibrium Phase Diagram of the System Co-Cr-Ti," *Russ. J. Inorganic Chem.*; TR: *Zh. Neorg. Khim.*, Vol 3 (No. 3), 1958, p 193-205

62Zak: E.K. Zakharov and B.G. Livshits, "Phase Composition Diagram of the Cobalt-Chromium-Titanium Ternary System," *Russ. Metall. Fuels*, (No. 5), 1962, p 88-97

Co-Cr-W (Cobalt - Chromium - Tungsten) Ternary Phase Diagrams

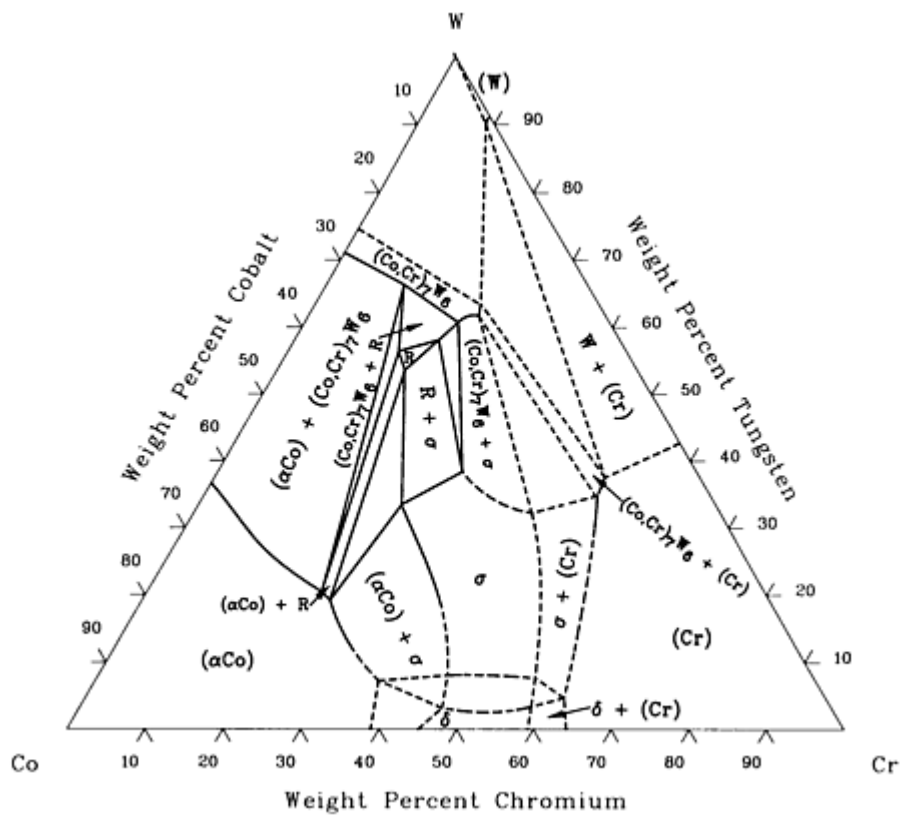

Co-Cr-W isothermal section at 1350 °C [73Dra 29].

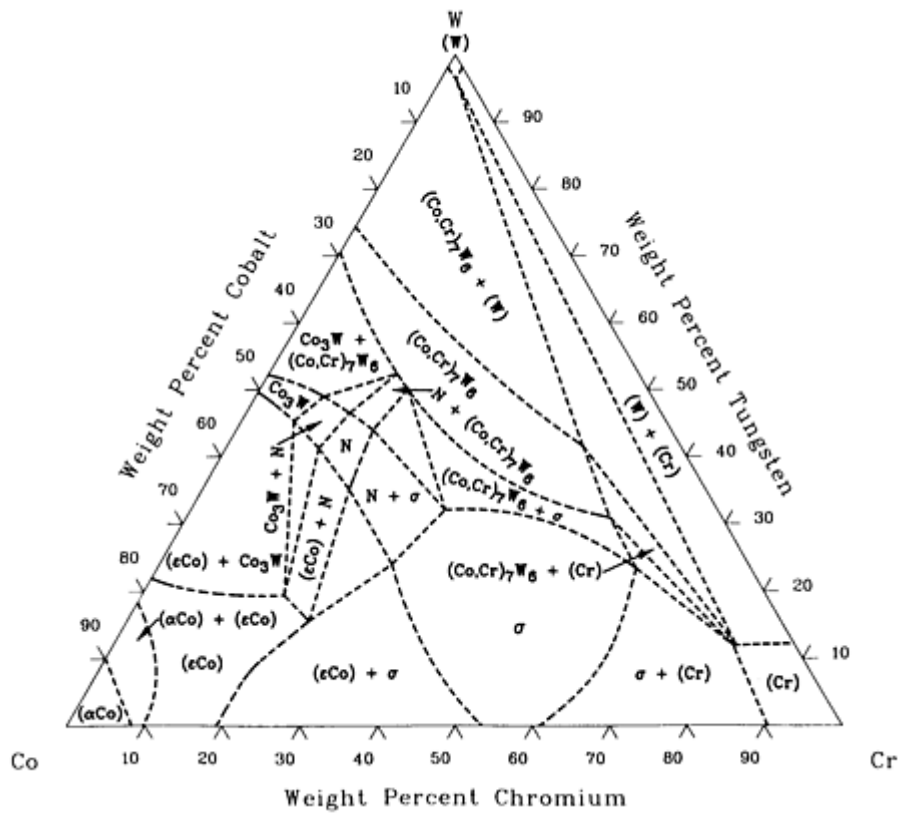

Co-Cr-W isothermal section at 700 °C [73Dra 29].

Reference cited in this section

Co-Fe-Mo (Cobalt - Iron - Molybdenum) Ternary Phase Diagrams

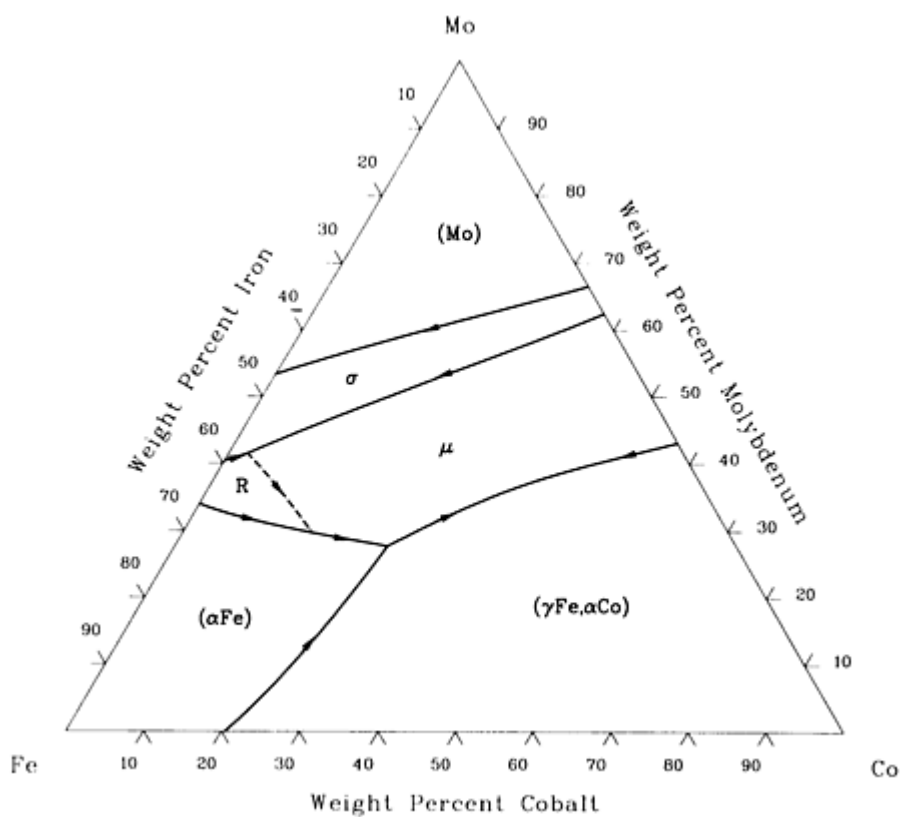

Co-Fe-Mo liquidus projection [88Ray 60].

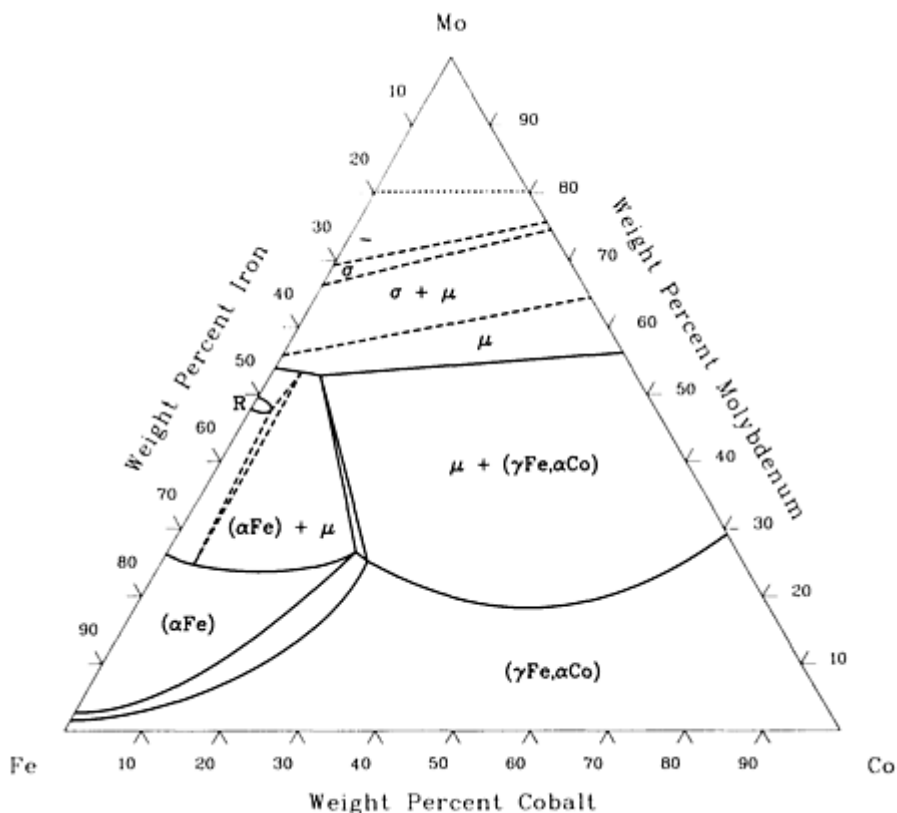

Co-Fe-Mo isothermal section at 1300 °C [88Ray 60].

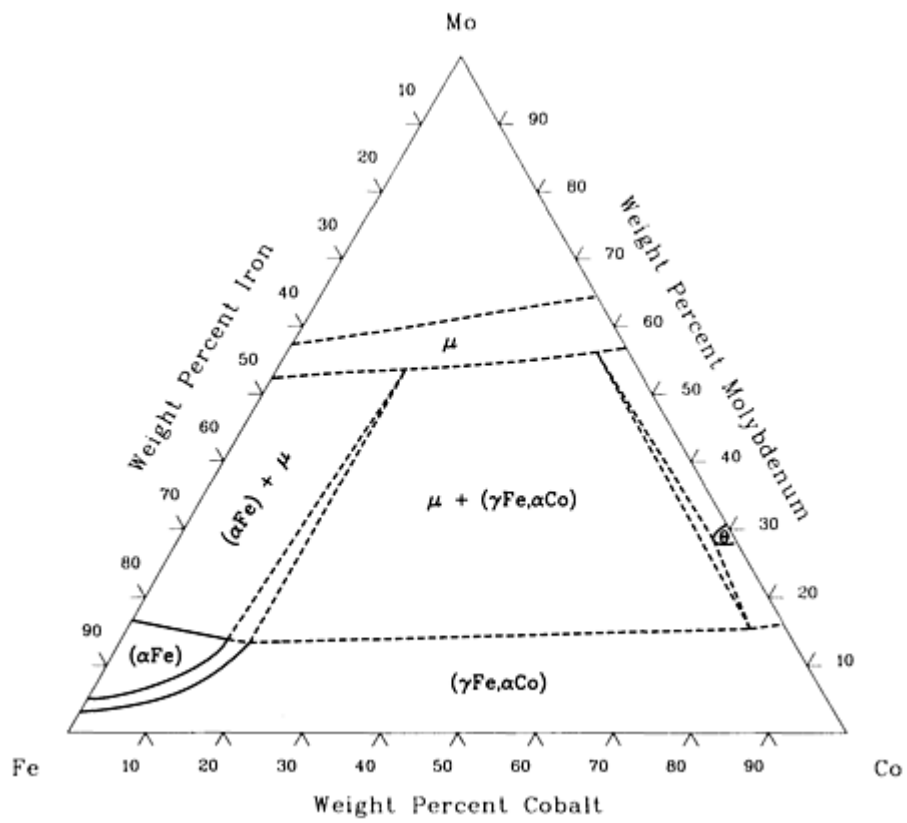

Co-Fe-Mo isothermal section at 1093 °C [88Ray 60].

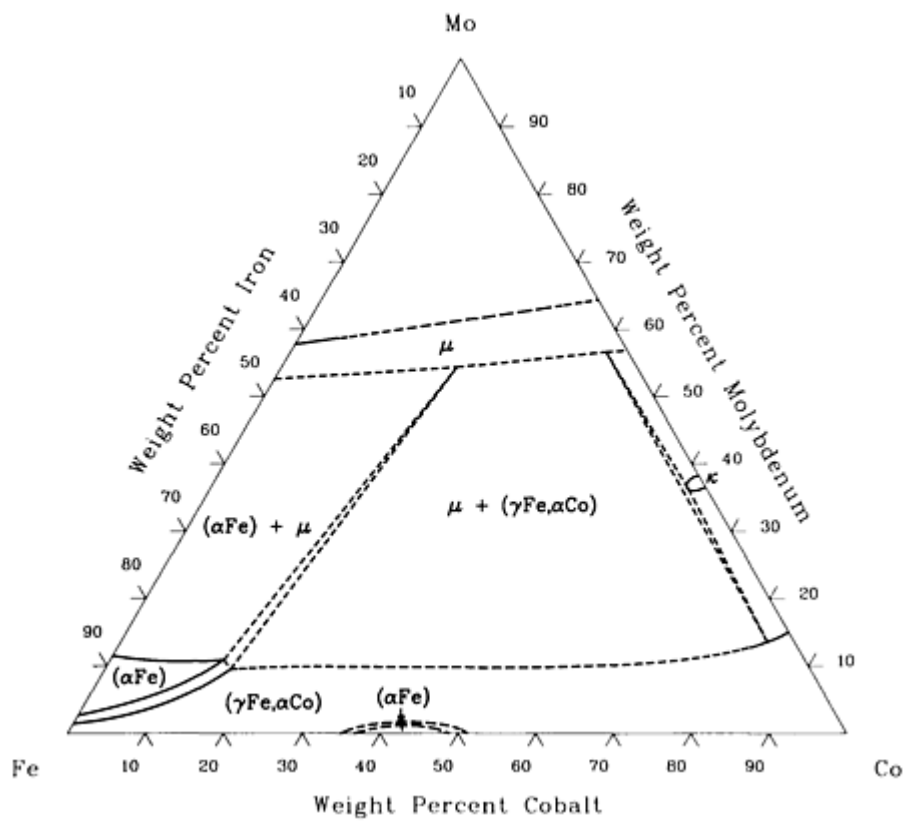

Co-Fe-Mo isothermal section at 982 °C [88Ray 60].

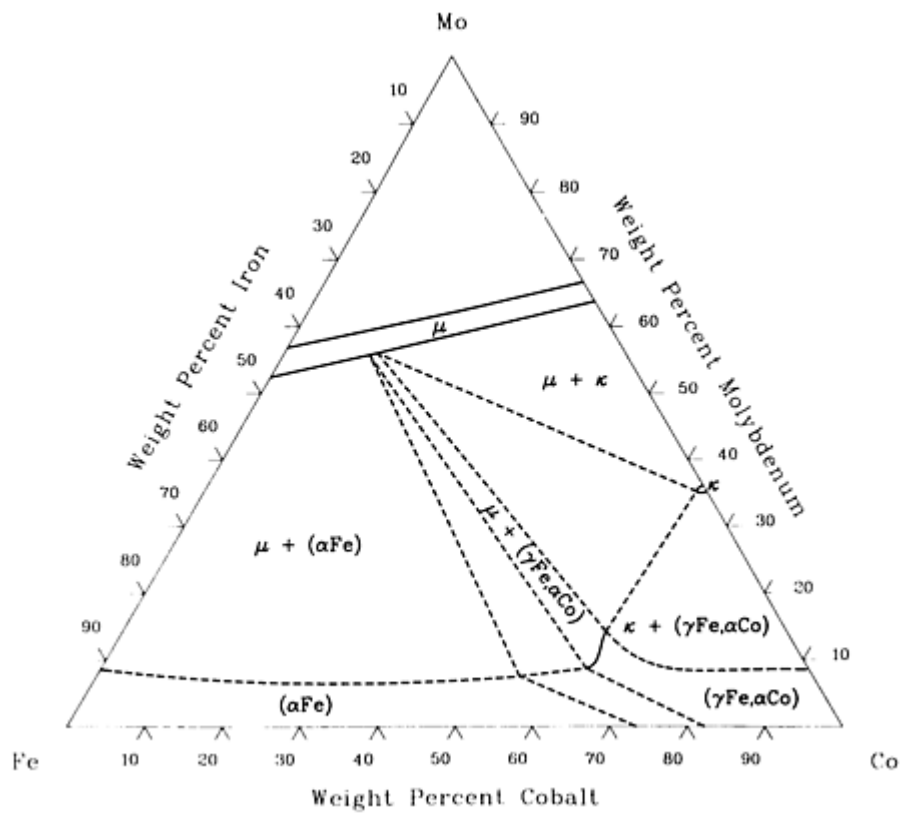

Co-Fe-Mo isothermal section at 800 °C [88Ray 60].

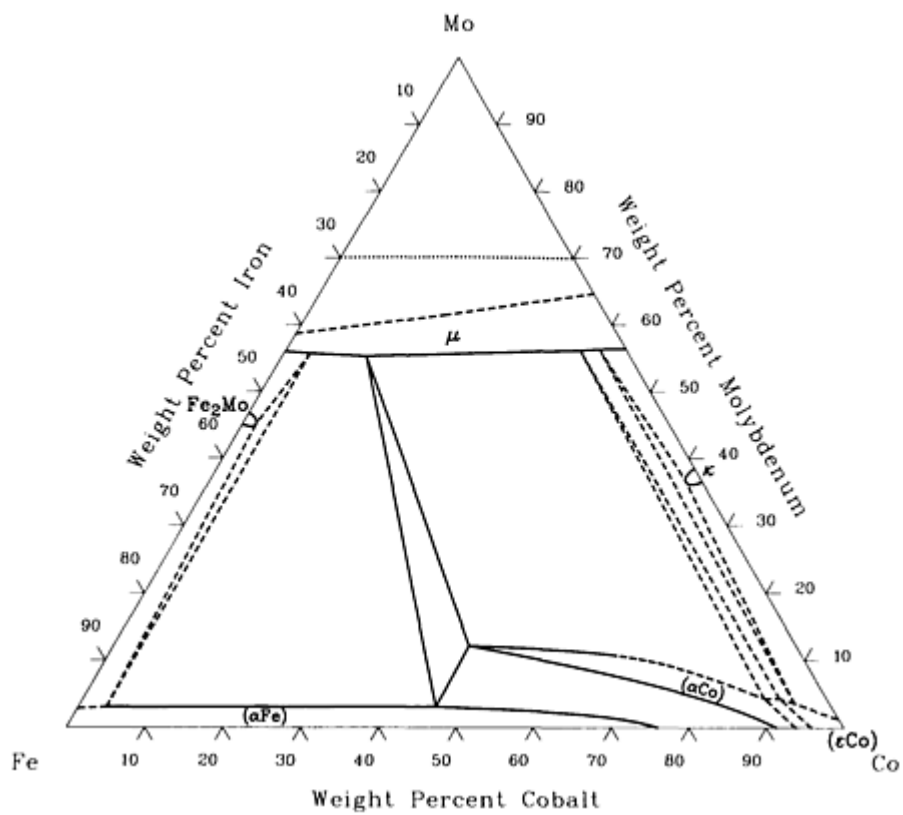

Co-Fe-Mo isothermal section at 20 °C [88Ray 60].

Reference cited in this section

Co-Fe-Ni (Cobalt - Iron - Nickel) Ternary Phase Diagrams

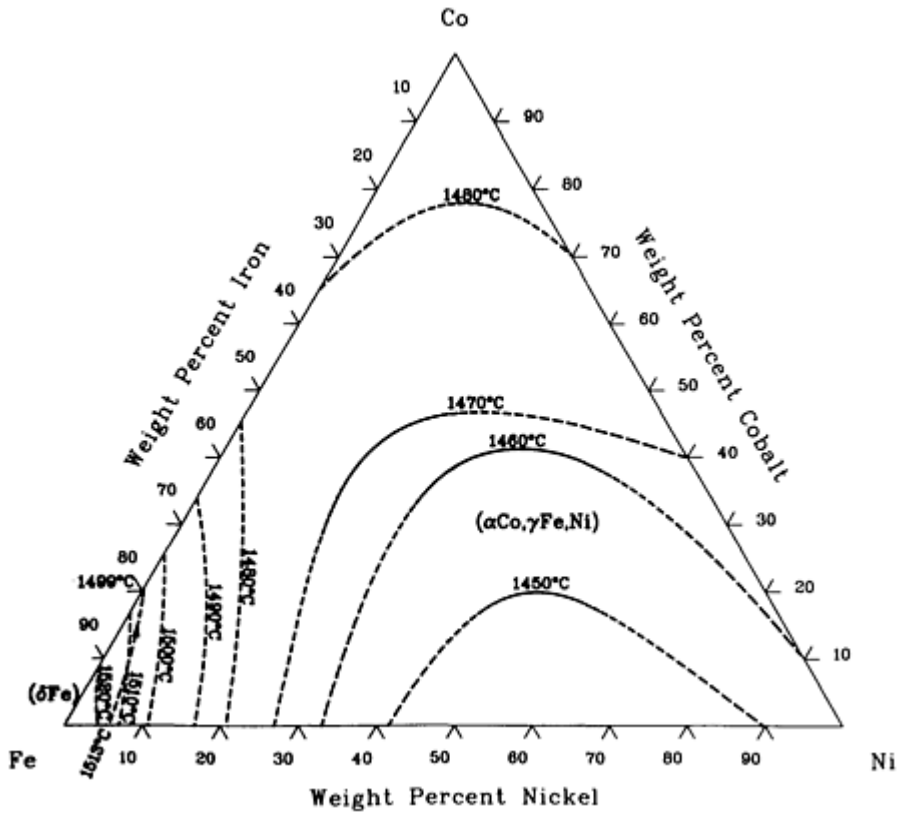

Co-Fe-Ni liquidus projection [88Ray 60].

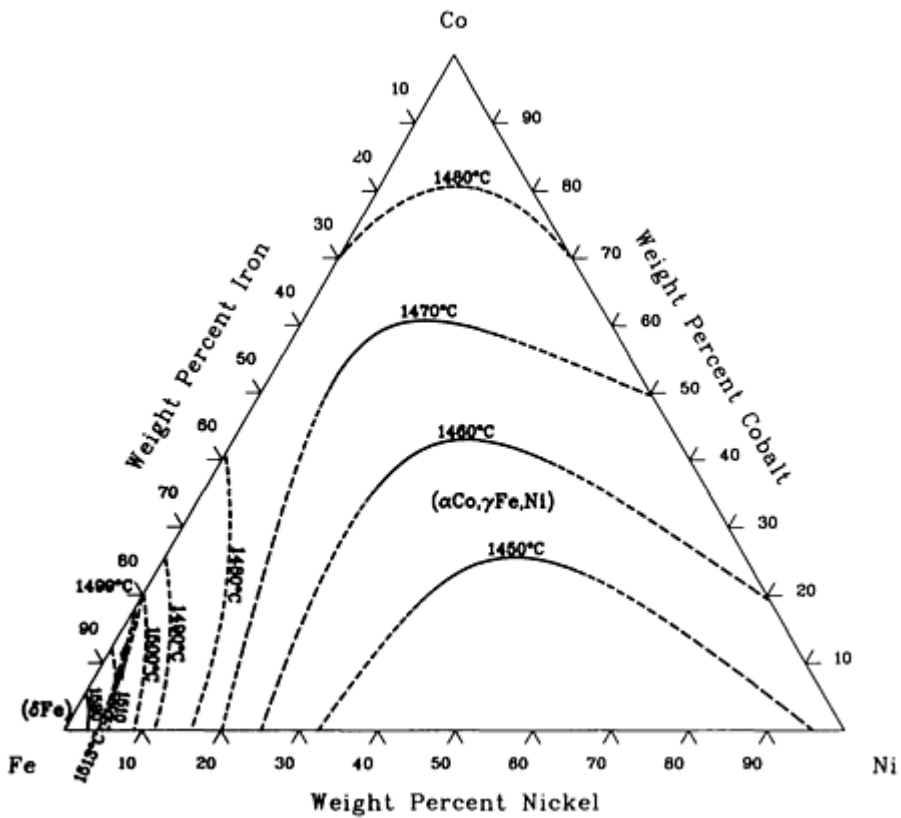

Co-Fe-Ni solidus projection [88Ray 60].

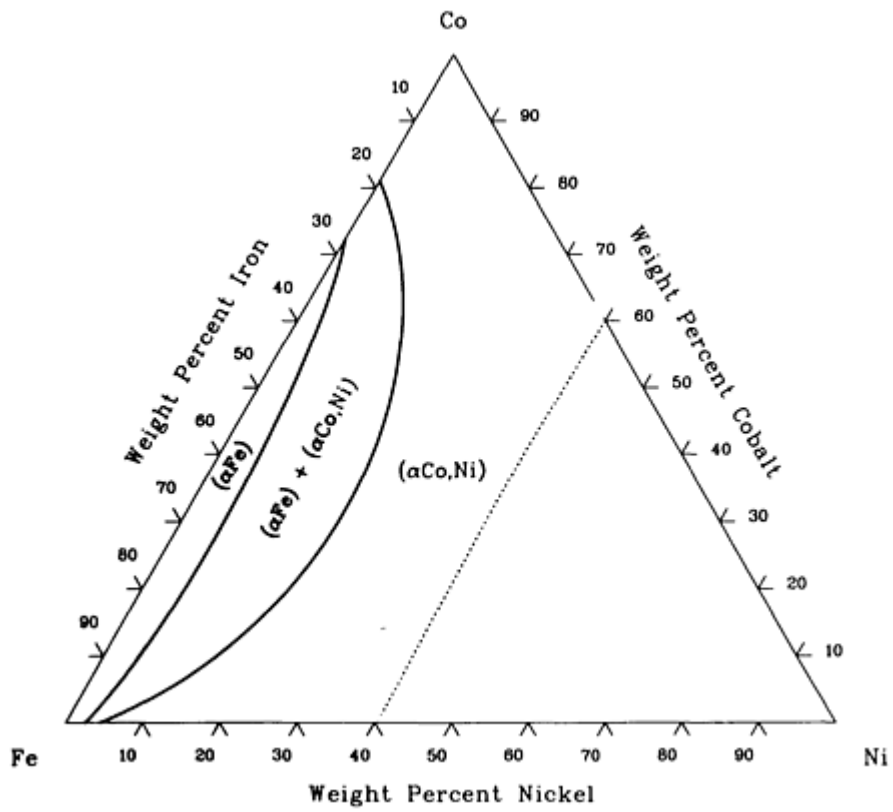

Co-Fe-Ni isothermal section at 800 °C [88Ray 60].

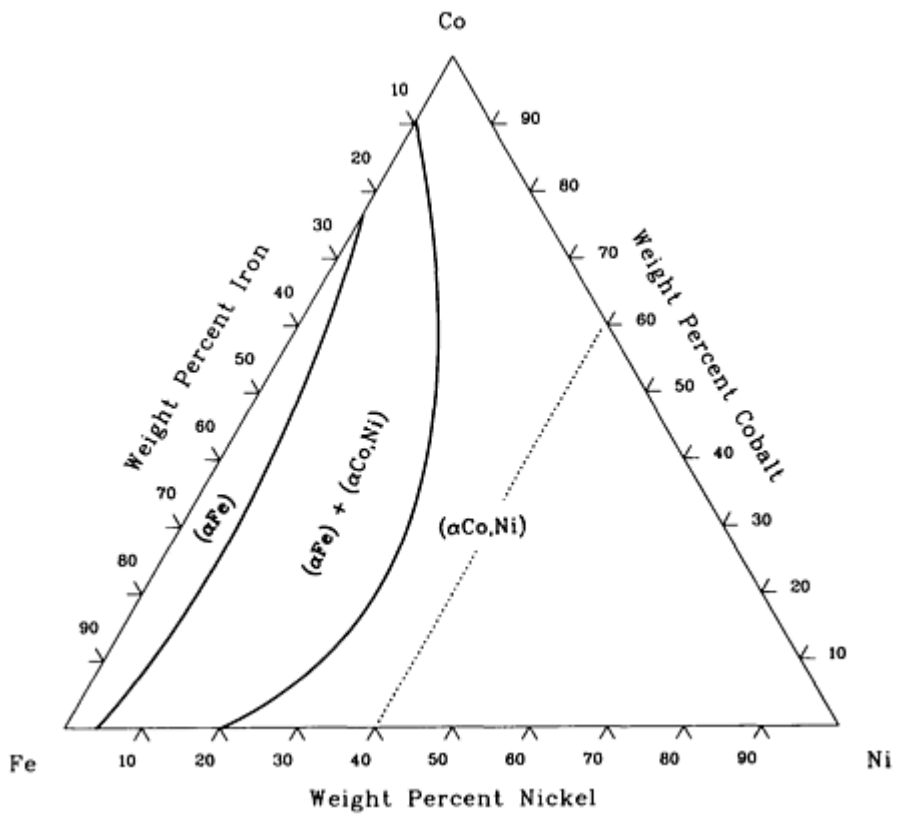

Co-Fe-Ni isothermal section at 600 °C [88Ray 60].

Reference cited in this section

88Ray: G.V. Raynor and V.G. Rivlin, *Phase Equilibria in Iron Ternary Alloys*, The Institute of Metals, London, (No. 4), 1988

Co-Fe-W (Cobalt - Iron - Tungsten) Ternary Phase Diagrams

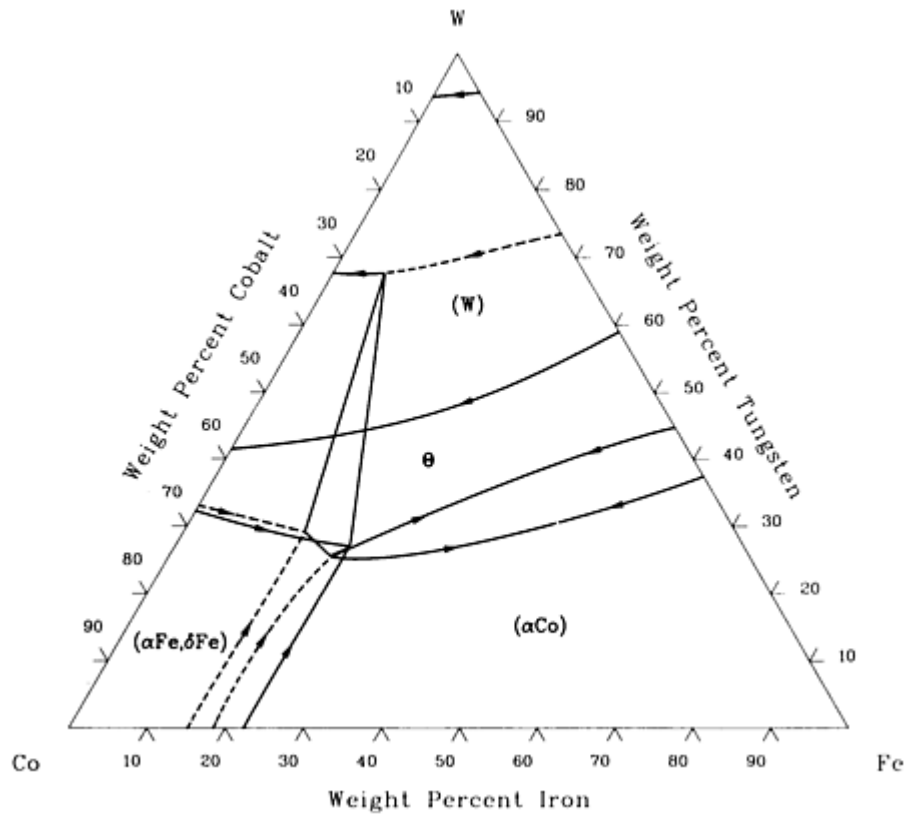

Co-Fe-W liquidus and solidus projections [88Ray 60].

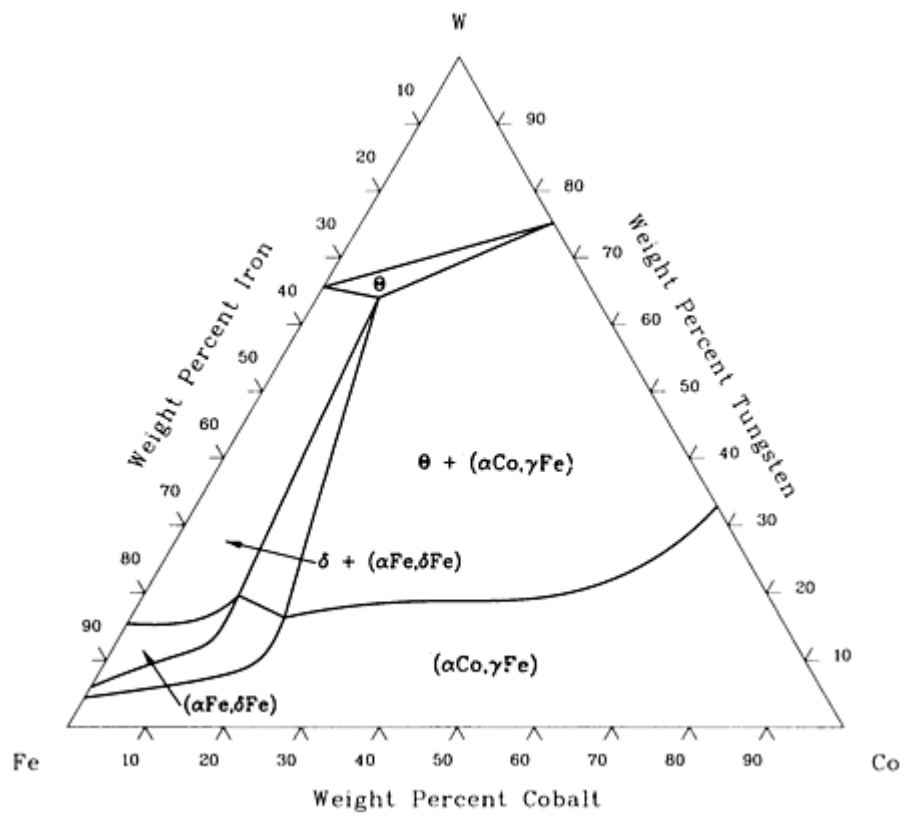

Co-Fe-W isothermal section at 1200 °C [88Ray 60].

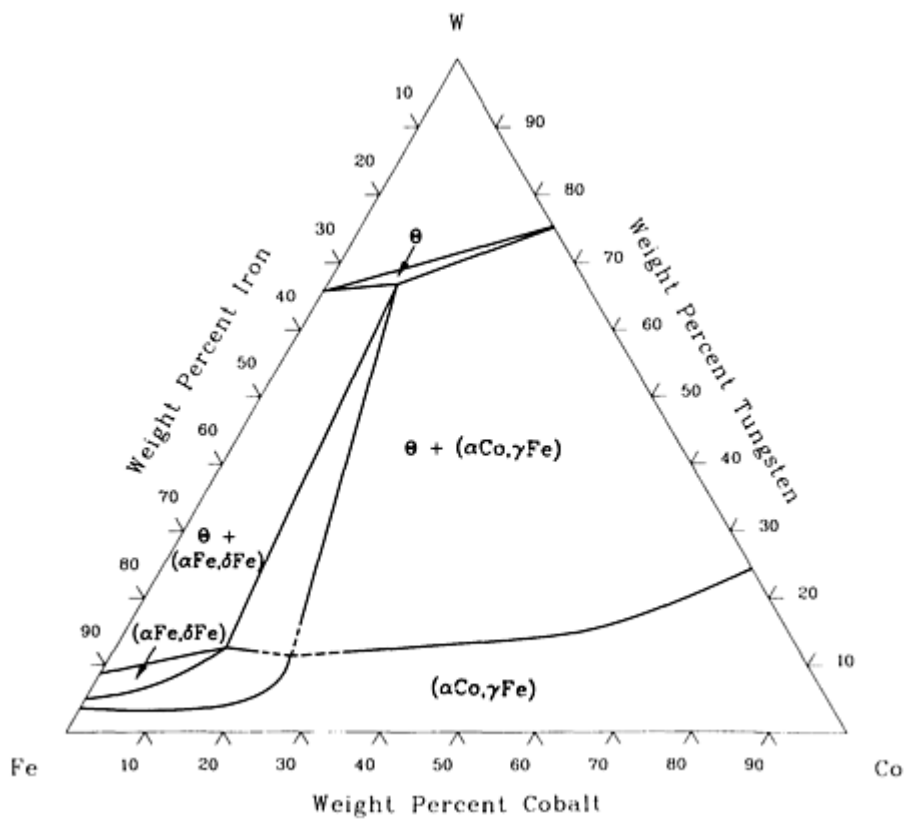

Co-Fe-W isothermal section at 1000 °C [88Ray 60].

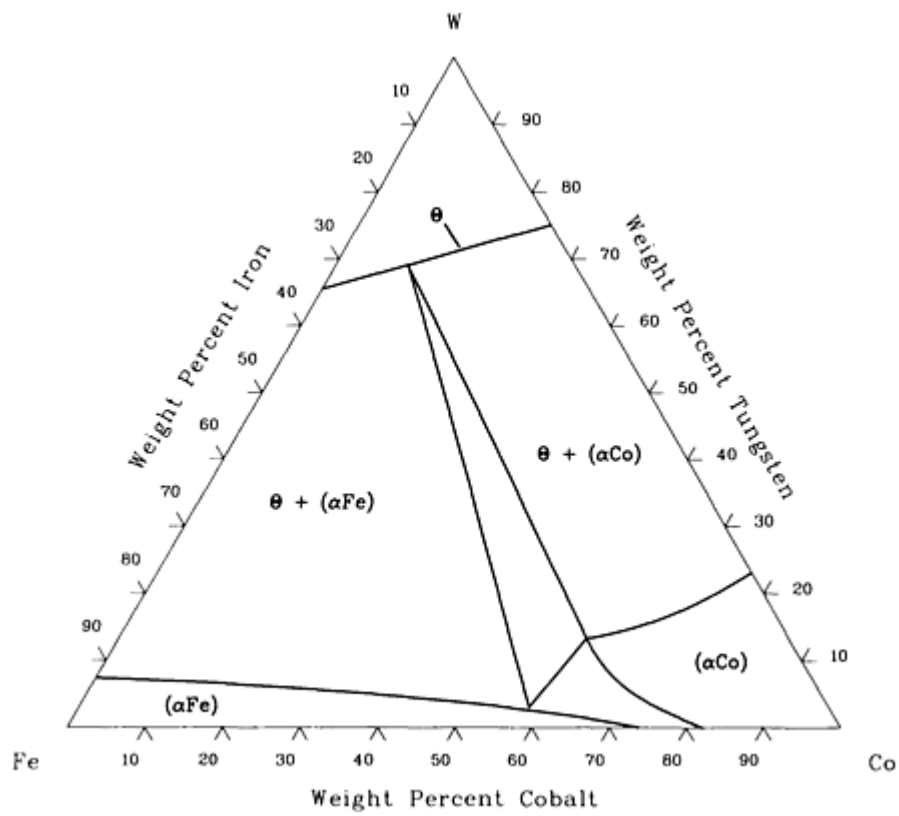

Co-Fe-W isothermal section at 800 °C [88Ray 60].

Reference cited in this section

88Ray: G.V. Raynor and V.G. Rivlin, *Phase Equilibria in Iron Ternary Alloys*, The Institute of Metals, London, (No. 4), 1988

Co-Mo-Ni (Cobalt - Molybdenum - Nickel) Ternary Phase Diagrams

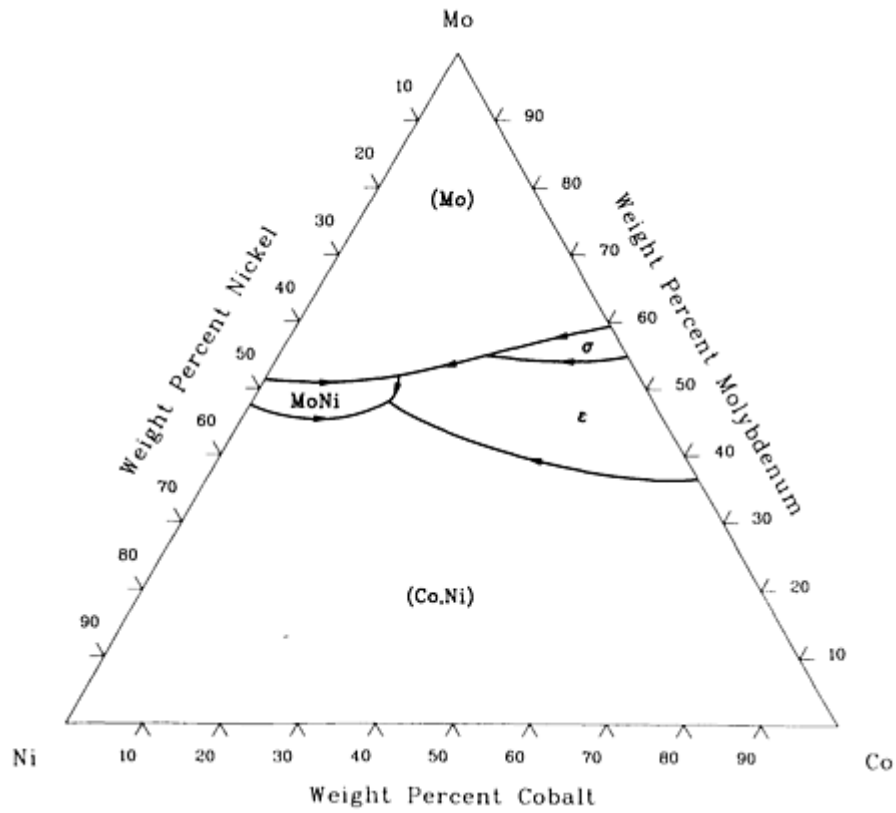

Co-Mo-Ni liquidus projection [84Gup 45].

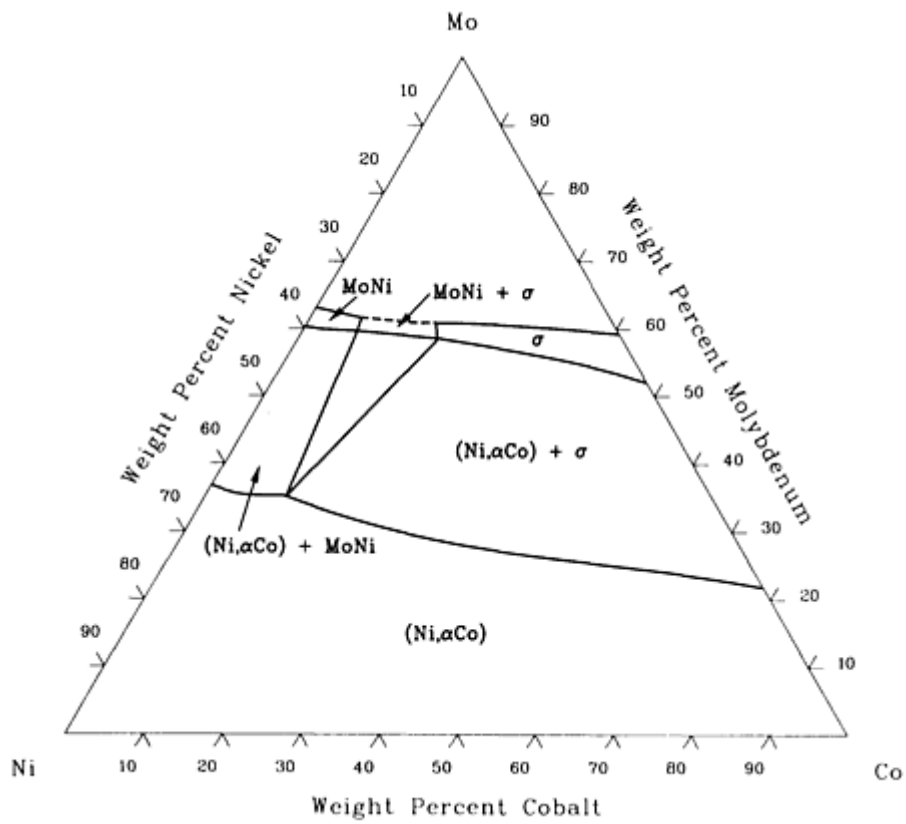

Co-Mo-Ni isothermal section at 1200 °C [52Das 7].

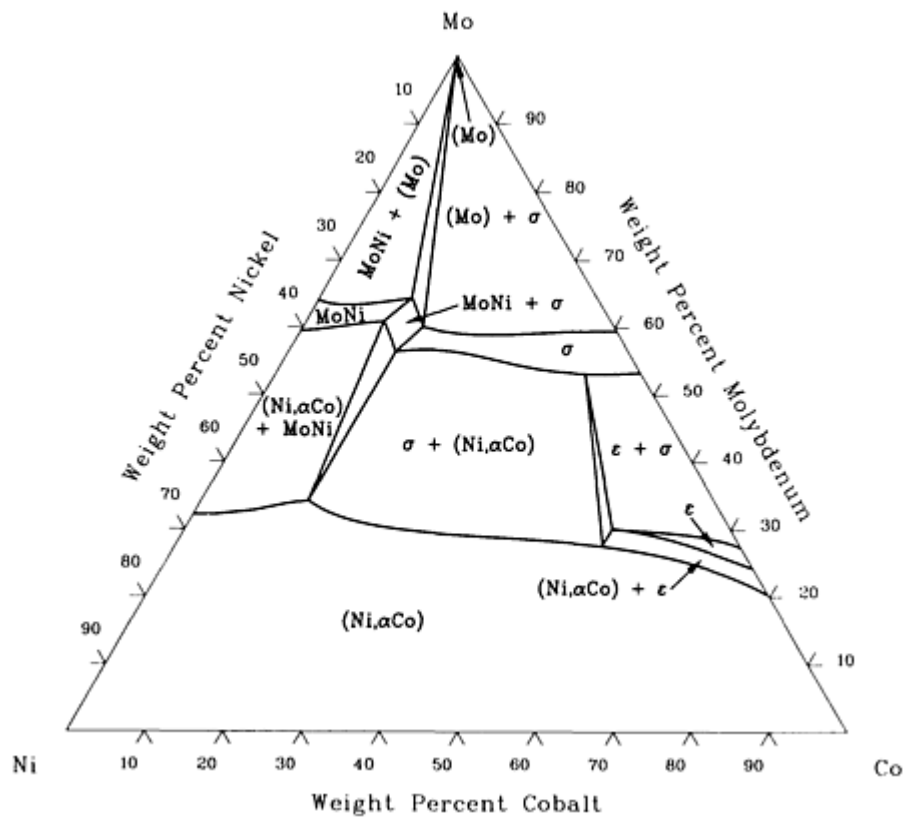

Co-Mo-Ni isothermal section at 1100 °C [80Loo 40].

References cited in this section

- 52Das:** D.K. Das, S.P. Rideout, and P.A. Beck, "Intermediate Phases in the Mo-Fe-Co, Mo-Fe-Ni, and Mo-Ni-Co Ternary Systems," *Trans. AIME*, Vol 194, 1952, p 1071-1075
- 80Loo:** F.J.J. van Loo, G.F. Bastin, J.W.G.A. Vrolijk, and J.J.M. Hendriks, "Phase Relations in the Systems Fe-Ni-Mo, Fe-Co-Mo and Ni-Co-Mo at 1100 °C," *J. Less-Common Met.*, Vol 72, 1980, p 225-230
- 84Gup:** K.P. Gupta, S.B. Rajendraprasad, A.K. Jena, and R.C. Sharma, "The Co-Mo-Ni System," *Trans. Indian Inst. Met.*, Vol 37 (No. 6), 1984, p 691-697

Co-Ni-Ti (Cobalt - Nickel - Titanium) Ternary Phase Diagrams

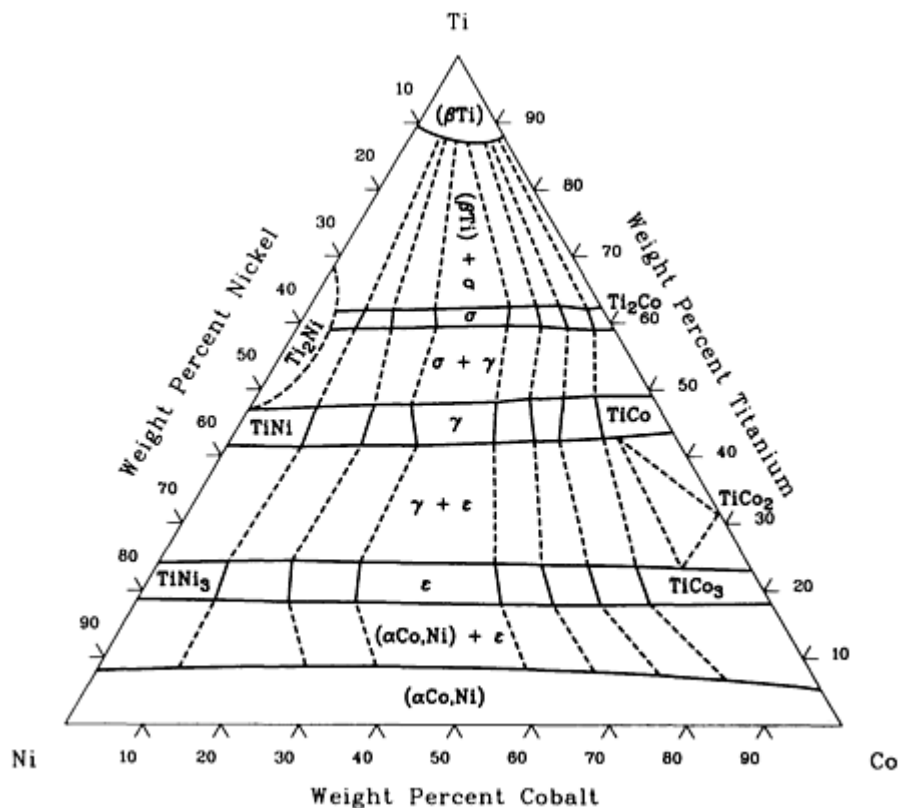

Co-Ni-Ti isothermal section at 1000 °C [83Gry 43].

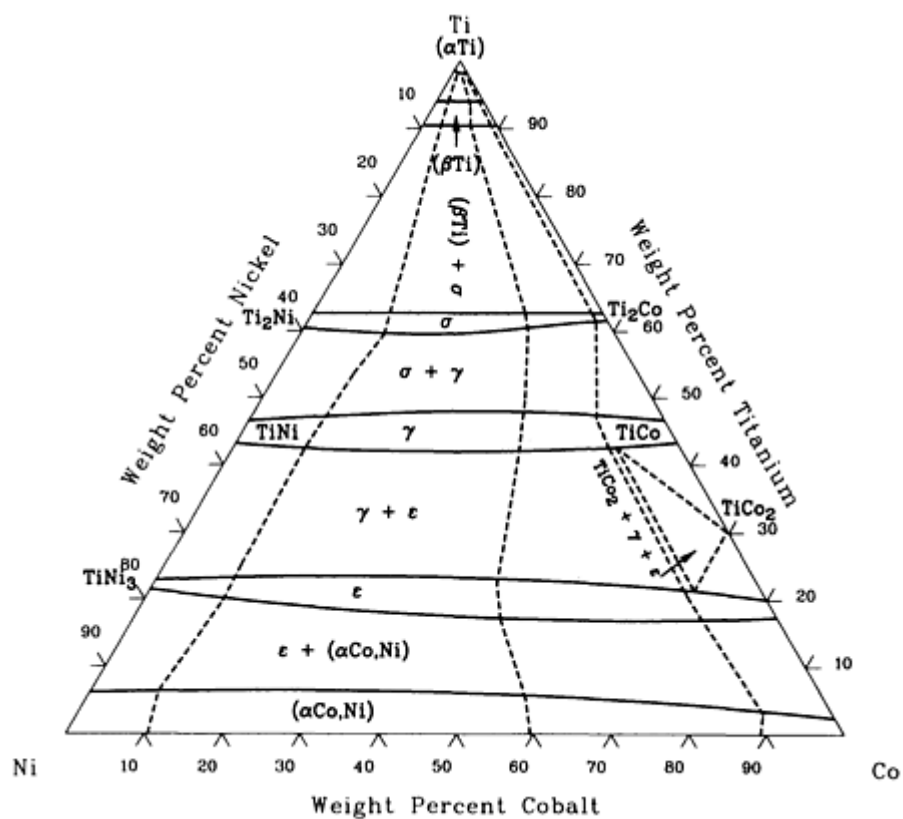

Co-Ni-Ti isothermal section at 800 °C [80Gry 39].

References cited in this section

80Gry: V.I. Gryzunov and A.S. Sagyndykov, "Mutual Diffusion in the System Ti-Ni-Co," *Phys. Met. Metallogr.*, Tr: *Fiz. Met. Metalloved.*, Vol 49 (No. 5), 1980, p 178-182

83Gry: V.I. Gryzunov, G.V. Shcherbedinskiy, Ye.M. Sokolovskaya, B.K. Aytbayev, and A.S. Sagyndykov, "Kinetics of Phase Growth During Mutual Diffusion in Ternary Multiphase Metallic Systems," *Phys. Met. Metallogr.*; TR: *Fiz. Met. Metalloved.*, Vol 56 (No. 1), 1983, p 183-186

Cr (Chromium) Ternary Alloy Phase Diagrams

Introduction

THIS ARTICLE includes systems where chromium is the first-named element in the ternary system. Additional ternary systems that include chromium are provided in the following locations in this Volume:

- "Al-Cr-Fe (Aluminum - Chromium - Iron)", "Al-Cr-Mn (Aluminum - Chromium - Manganese)" and "Al-Cr-Ni (Aluminum - Chromium - Nickel)" in the article "Al (Aluminum) Ternary Phase Diagrams."
- "C-Cr-Fe (Carbon - Chromium - Iron)", "C-Cr-Mo (Carbon - Chromium - Molybdenum)", "C-Cr-N (Carbon - Chromium - Nitrogen)", "C-Cr-V (Carbon - Chromium - Vanadium)", and "C-Cr-W (Carbon - Chromium - Tungsten)" in the article "C (Carbon) Ternary Phase Diagrams."
- "Co-Cr-Fe (Cobalt - Chromium - Iron)", "Co-Cr-Ni (Cobalt - Chromium - Nickel)", "Co-Cr-Ti (Cobalt - Chromium - Titanium)" and "Co-Cr-W (Cobalt - Chromium - Tungsten)" in the article "Co (Cobalt) Ternary Phase Diagrams."

Cr-Fe-Mo (Chromium - Iron - Molybdenum) Ternary Phase Diagrams

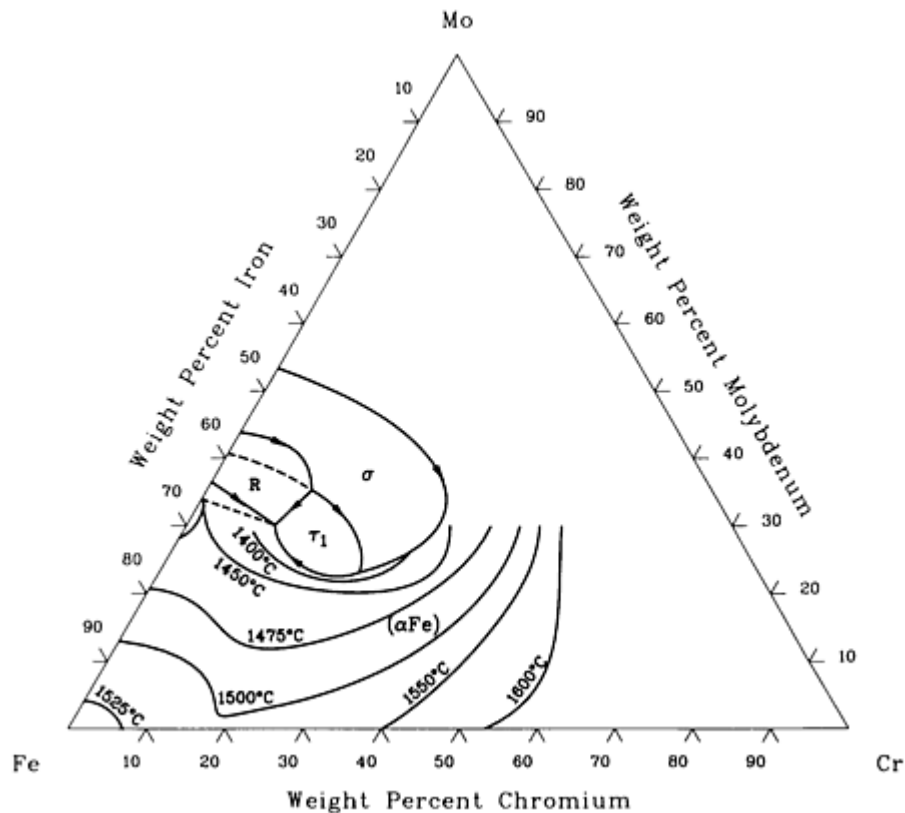

Cr-Fe-Mo liquidus projection [88Ray 60].

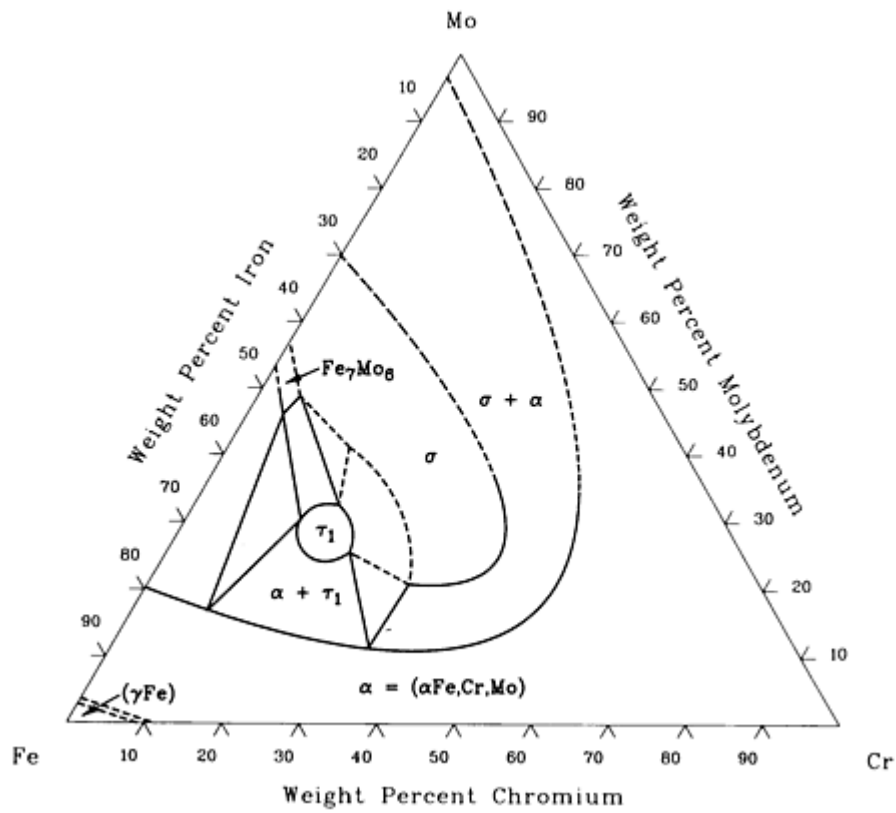

Cr-Fe-Mo isothermal section at 1250 °C [88Ray 60].

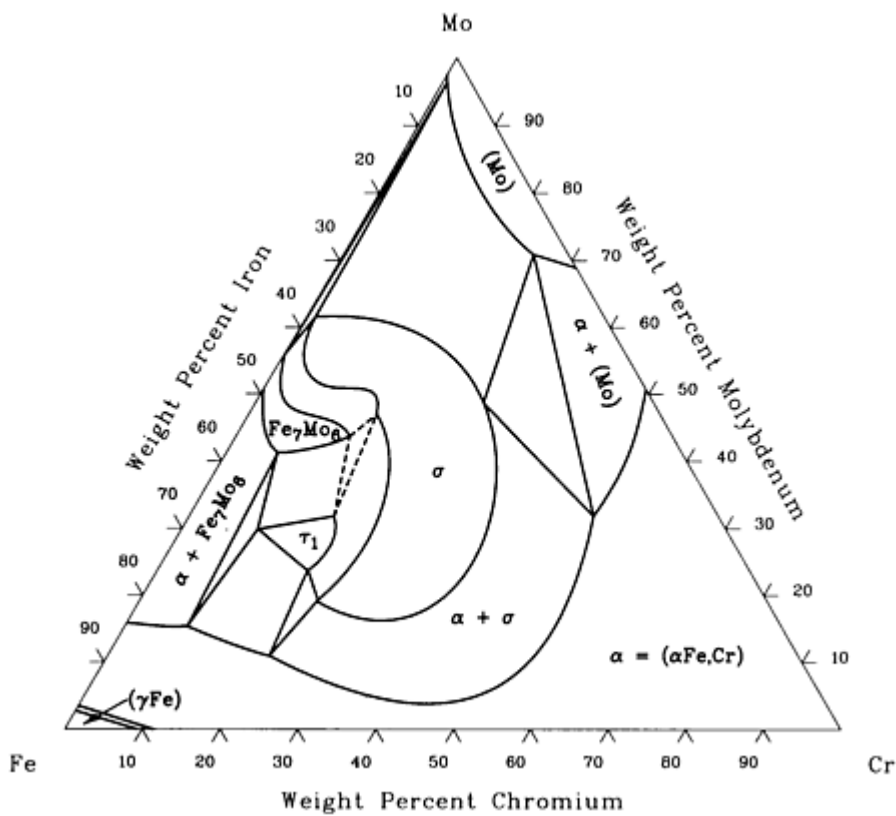

Cr-Fe-Mo isothermal section at 1100 °C [88Ray 60].

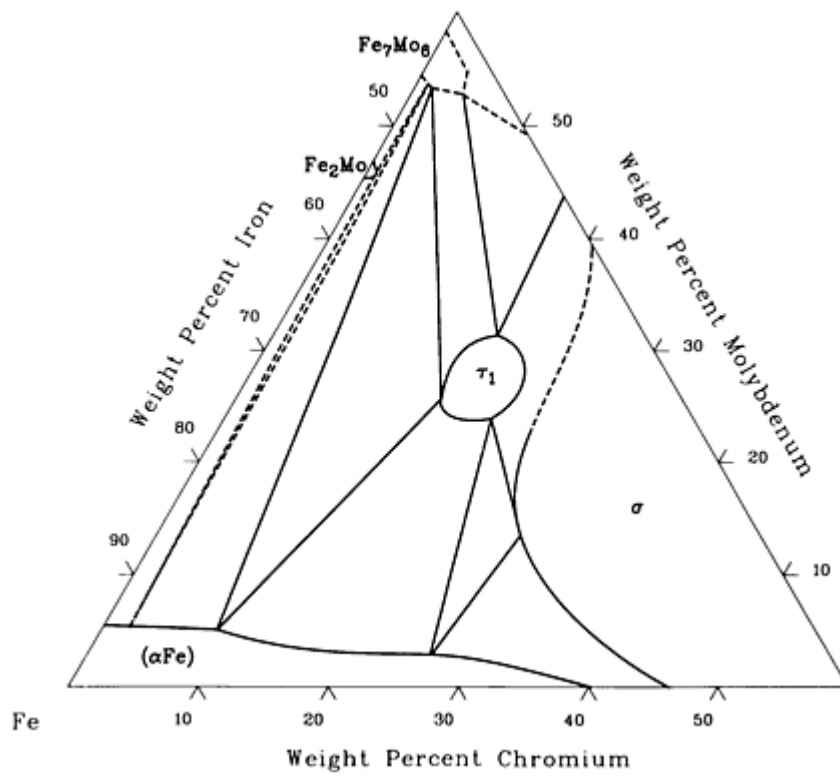

Cr-Fe-Mo isothermal section at 815 °C [88Ray 60].

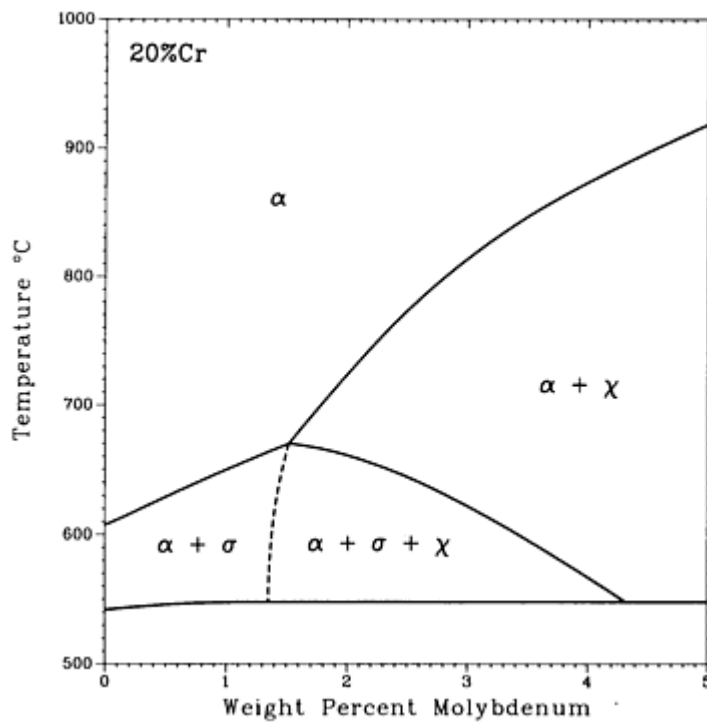

Cr-Fe-Mo [88Ray 60].

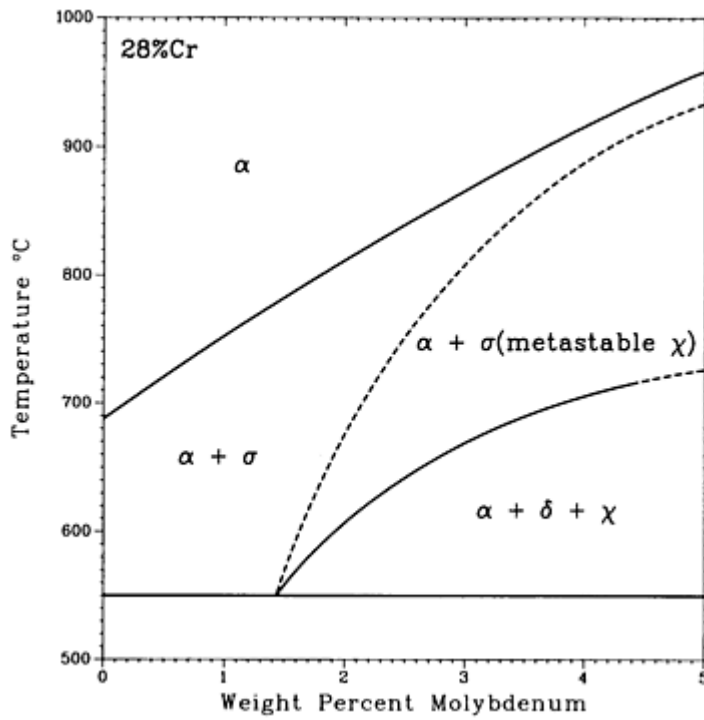

Cr-Fe-Mo [88Ray 60].

Reference cited in this section

88Ray: G.V. Raynor and V.G. Rivlin, *Phase Equilibria in Iron Ternary Alloys*, The Institute of Metals, London, (No. 4), 1988

Cr-Fe-N (Chromium - Iron - Nitrogen) Ternary Phase Diagrams

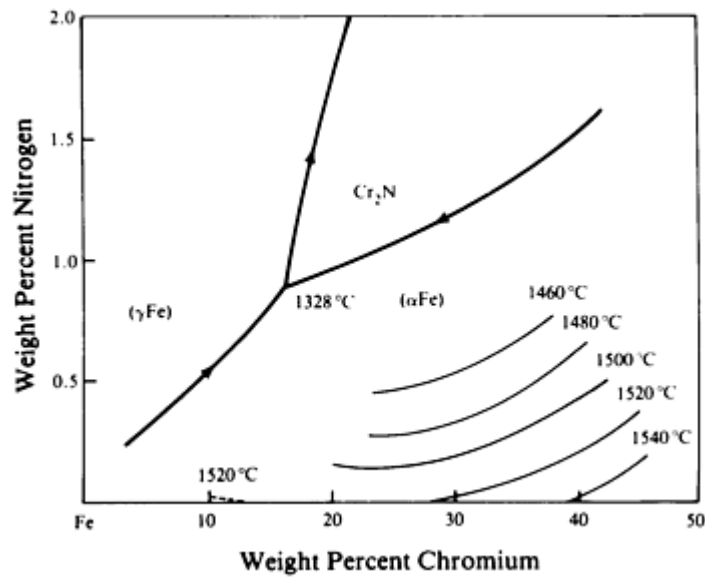

Cr-Fe-N liquidus projection [87Rag 57].

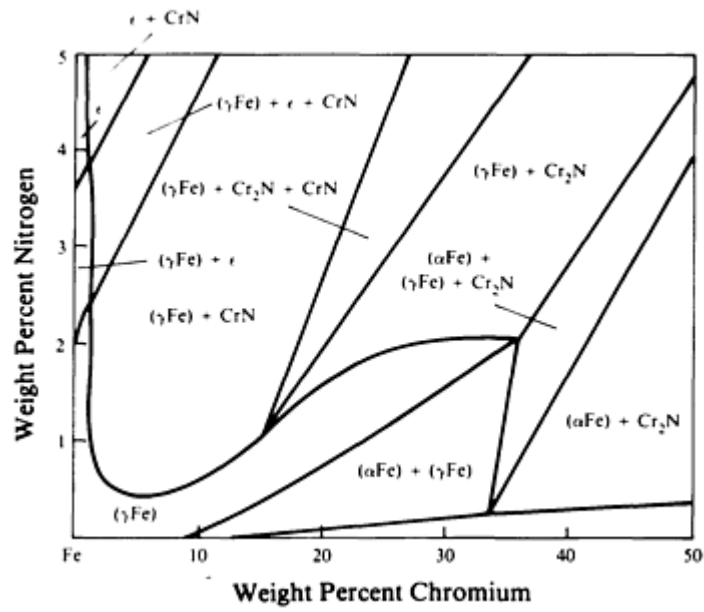

Cr-Fe-N isothermal section at 1200 °C [87Rag 57].

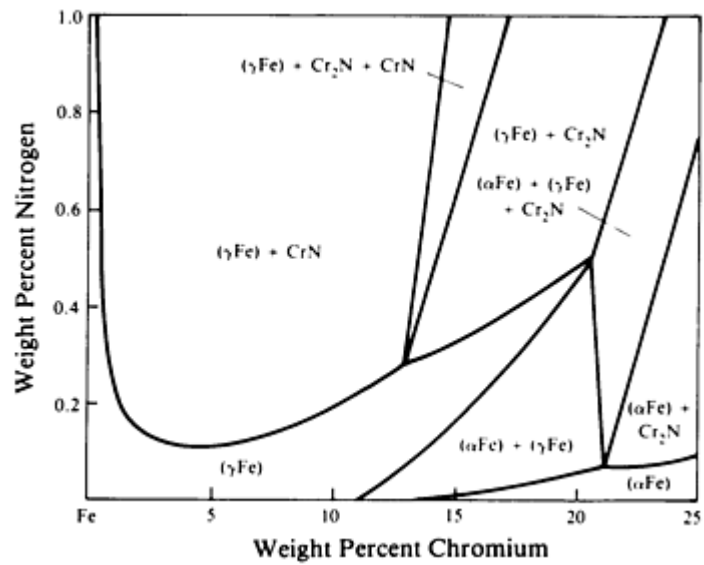

Cr-Fe-N isothermal section at 1000 °C [87Rag 57].

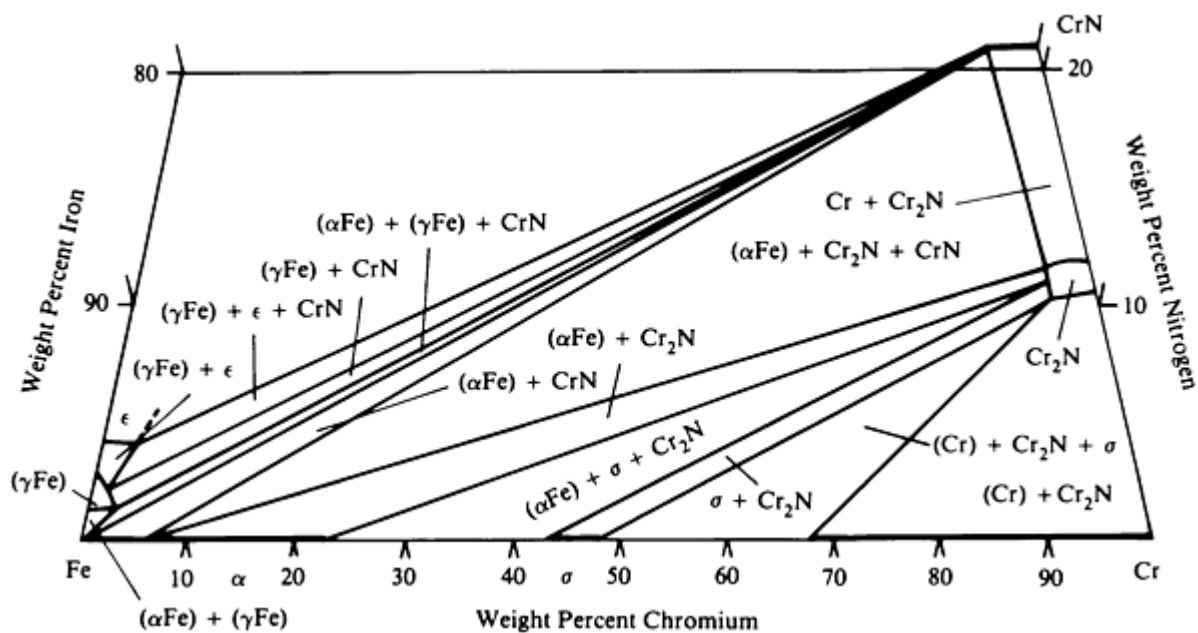

Cr-Fe-N isothermal section at 700 °C [87Rag 57].

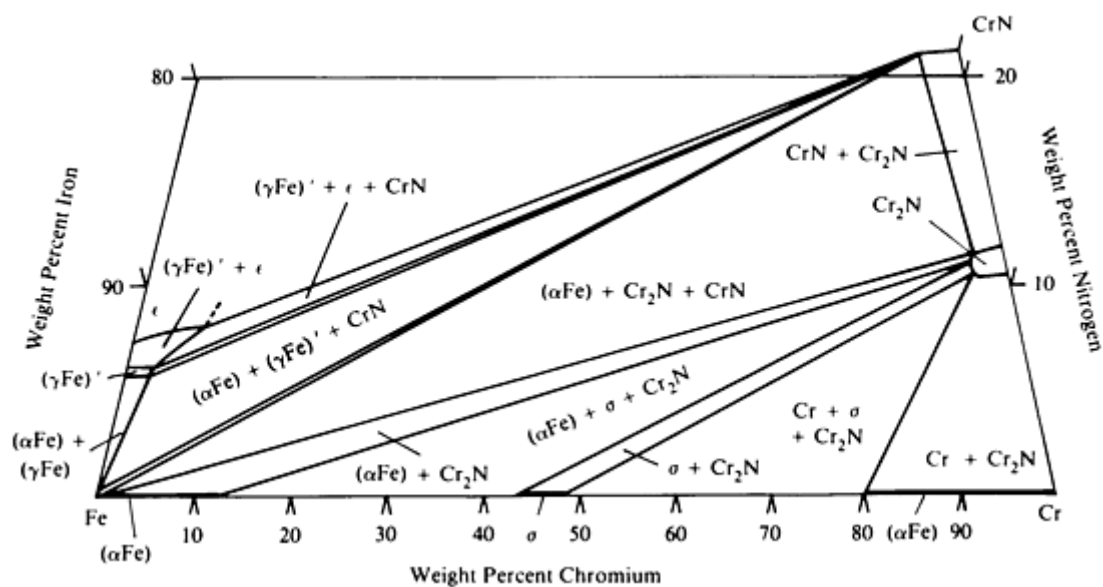

Cr-Fe-N isothermal section at 567 °C [87Rag 57].

Reference cited in this section

87Rag: V. Raghavan, *Phase Diagrams of Ternary Iron Alloys*, The Indian Institute of Metals, Calcutta, India, (No. 1), 1987

Cr-Fe-Ni (Chromium - Iron - Nickel) Ternary Phase Diagrams

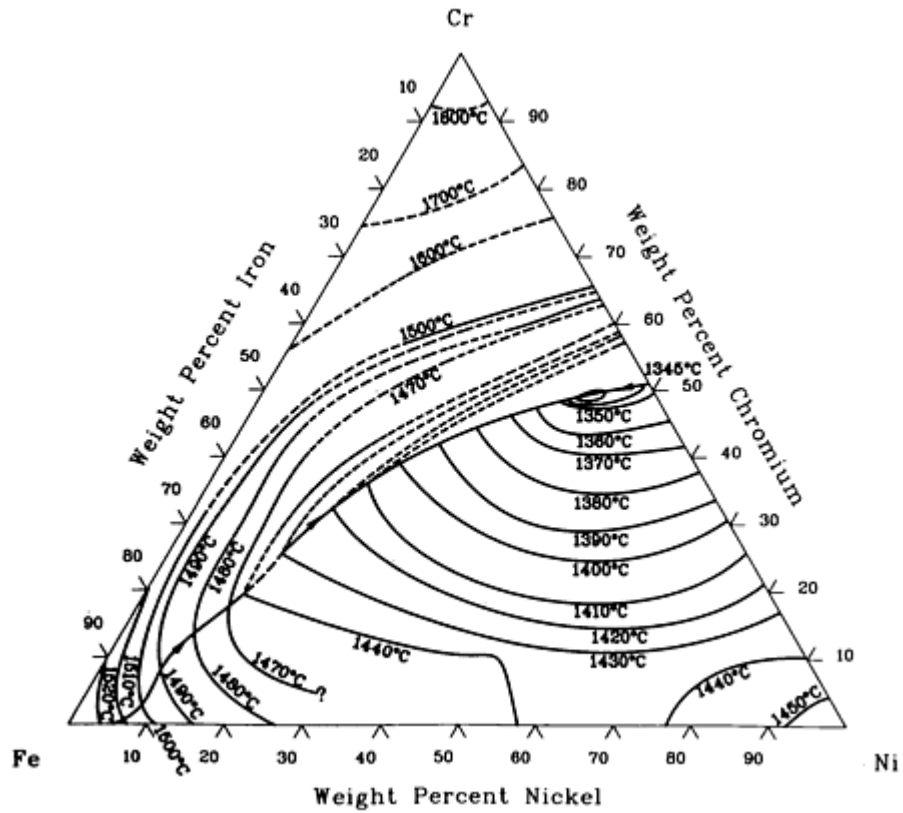

Cr-Fe-Ni liquidus projection [88Ray 60].

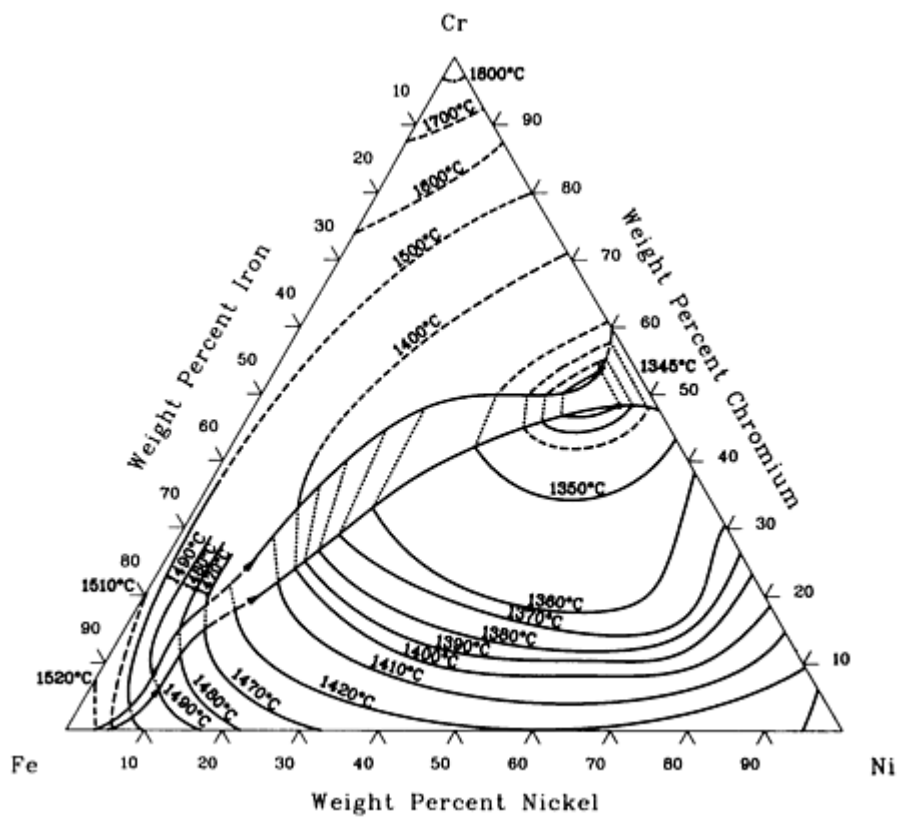

Cr-Fe-Ni solidus projection [88Ray 60].

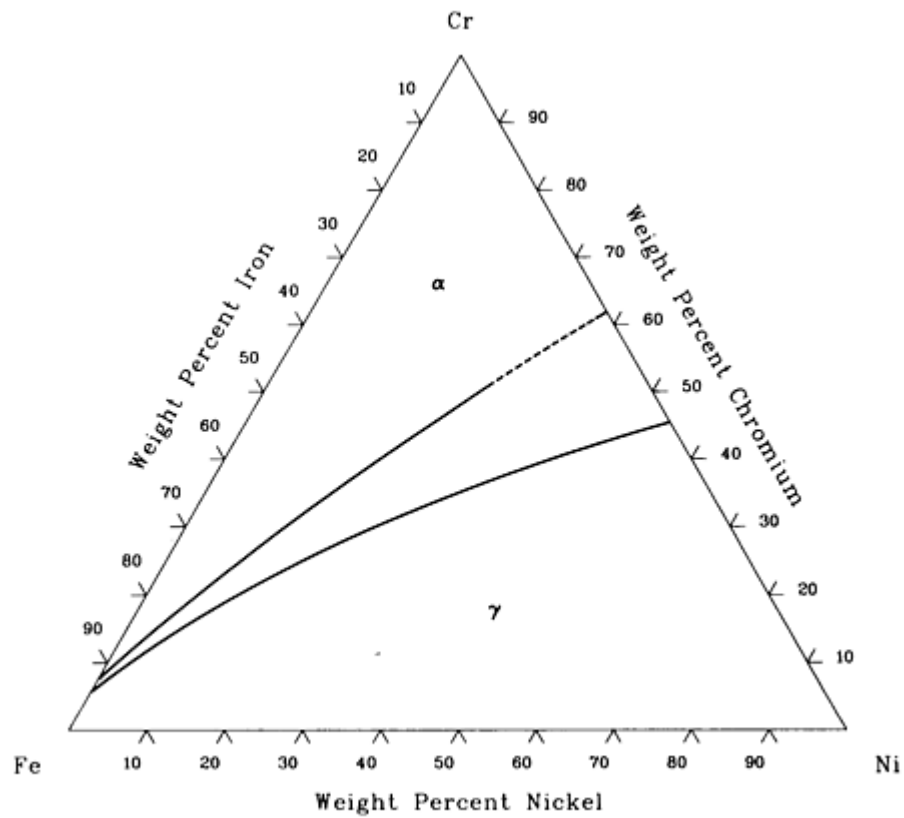

Note: $\alpha = (\alpha_{Fe,Cr})$; $\gamma = (\gamma_{Fe,Ni})$

Cr-Fe-Ni isothermal section at 1300 °C [88Ray 60].

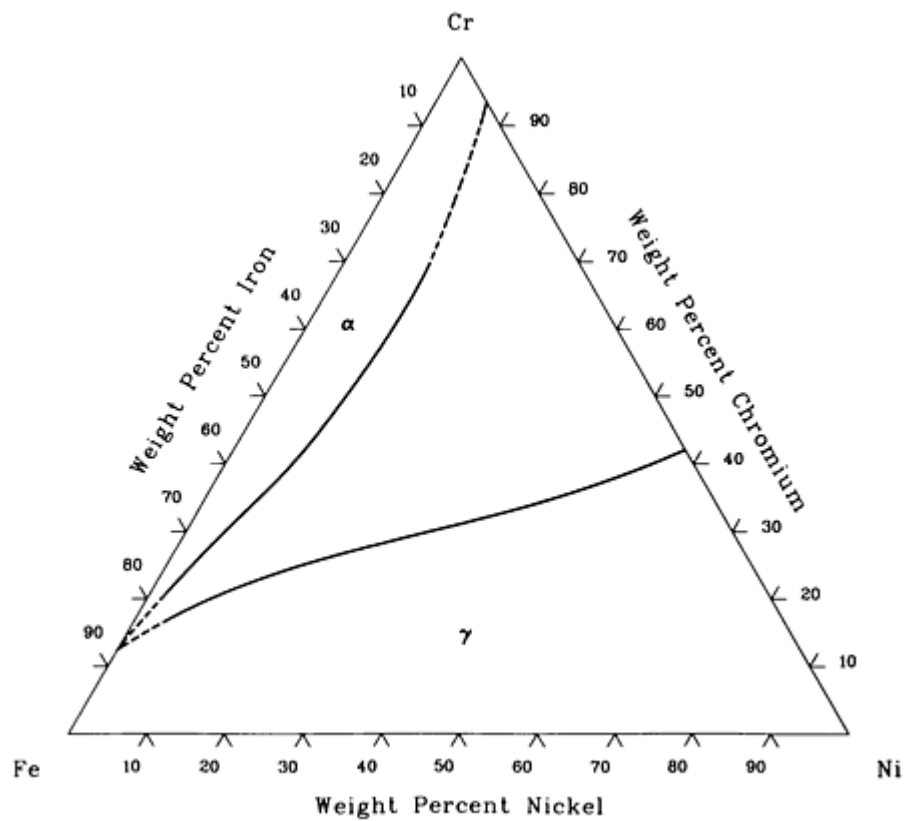

Note: $\alpha = (\alpha_{Fe,Cr})$; $\gamma = (\gamma_{Fe,Ni})$

Cr-Fe-Ni isothermal section at 1000 °C [88Ray 60].

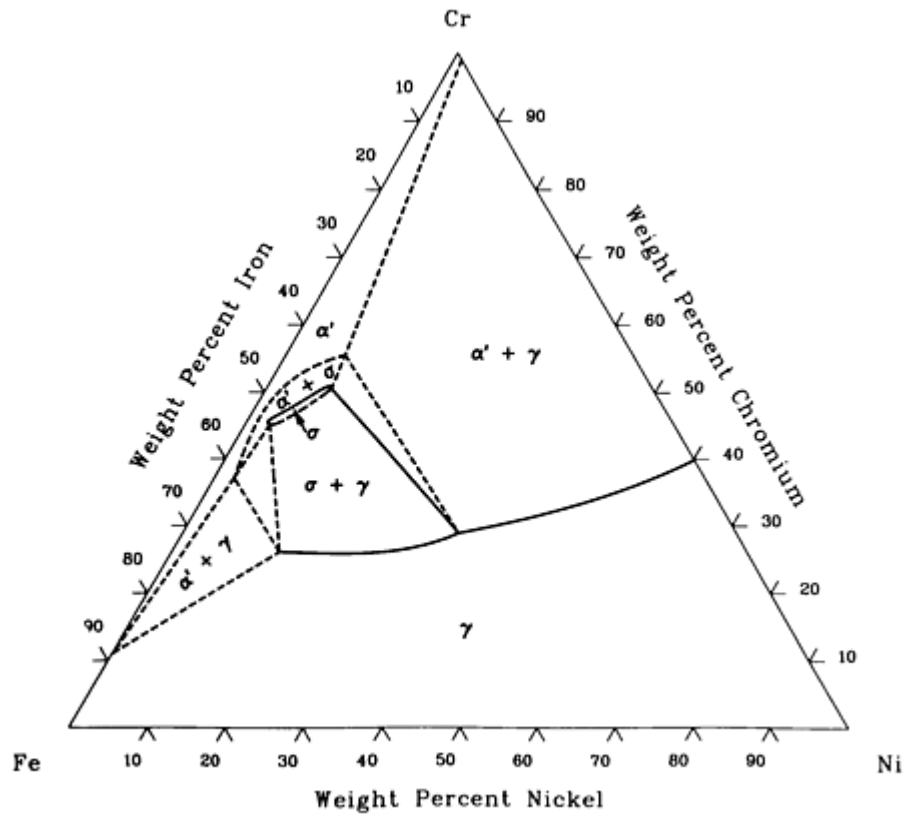

Note: $\alpha = (\alpha_{Fe,Cr})$; $\gamma = (\gamma_{Fe,Ni})$

Cr-Fe-Ni isothermal section at 900 °C [88Ray 60].

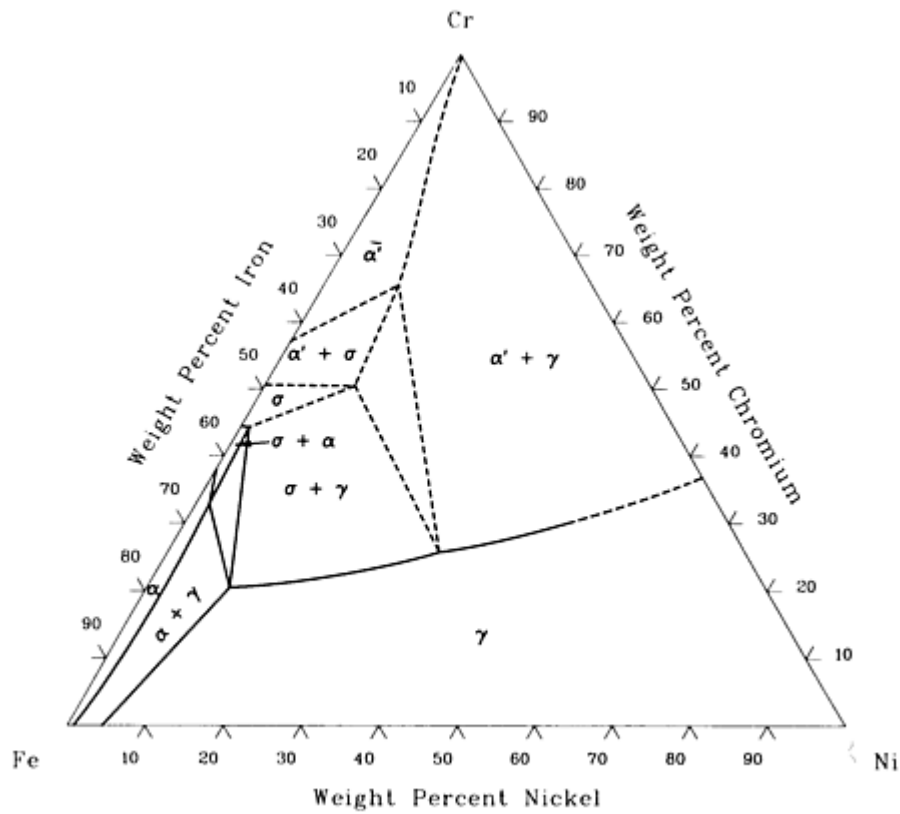

Note: $\alpha = (\alpha_{Fe,Cr})$; $\gamma = (\gamma_{Fe,Ni})$

Cr-Fe-Ni isothermal section at 800 °C [88Ray 60].

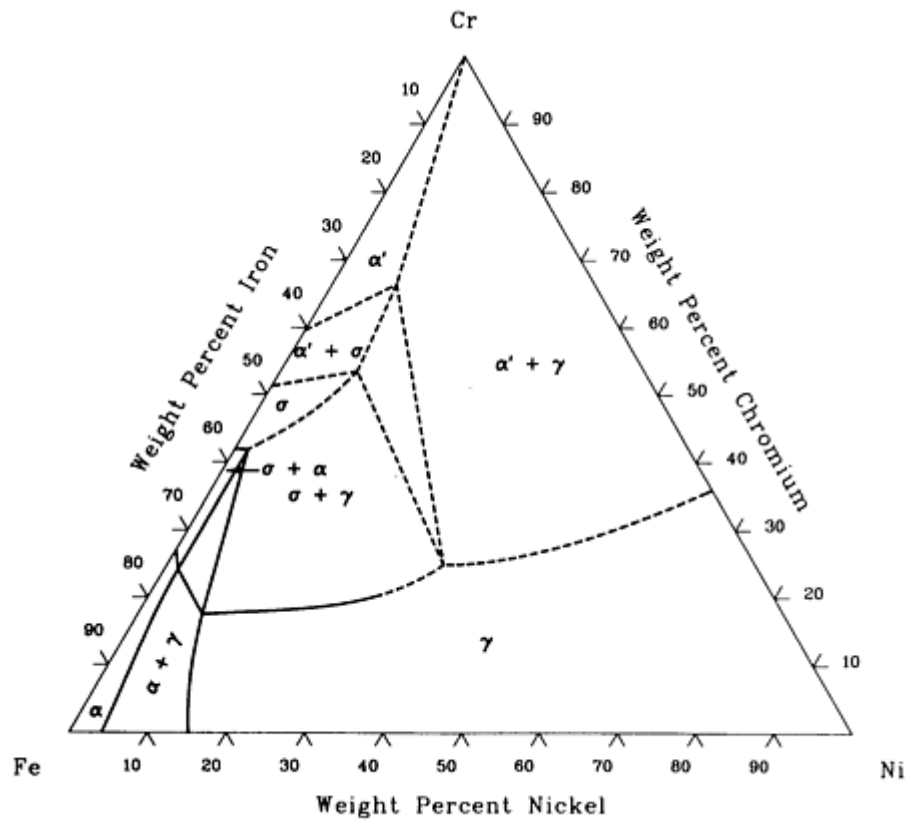

Note: $\alpha = (\alpha_{Fe,Cr})$; $\gamma = (\gamma_{Fe,Ni})$

Cr-Fe-Ni isothermal section at 650 °C [88Ray 60].

Reference cited in this section

88Ray: G.V. Raynor and V.G. Rivlin, *Phase Equilibria in Iron Ternary Alloys*, The Institute of Metals, London, (No. 4), 1988

Cr-Fe-W (Chromium - Iron - Tungsten) Ternary Phase Diagrams

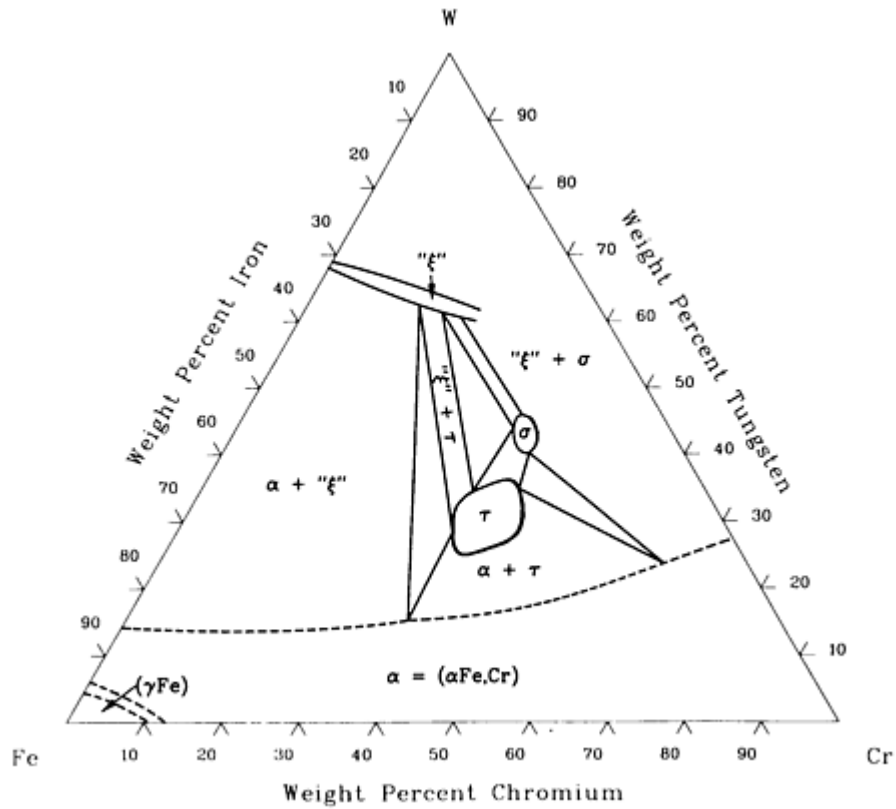

Cr-Fe-W isothermal section at 1200 °C [88Ray 60].

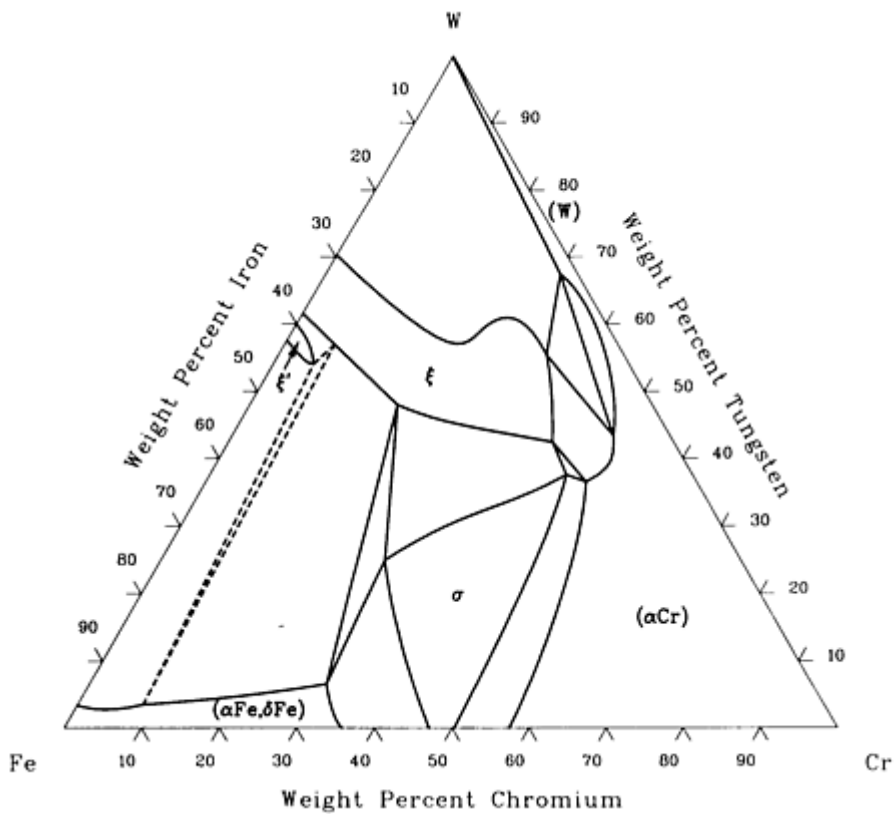

Cr-Fe-W isothermal section at 600 °C [88Ray 60].

Reference cited in this section

60. **88Ray:** G.V. Raynor and V.G. Rivlin, *Phase Equilibria in Iron Ternary Alloys*, The Institute of Metals, London, (No. 4), 1988

Cr-Mo-Ni (Chromium - Molybdenum - Nickel) Ternary Phase Diagrams

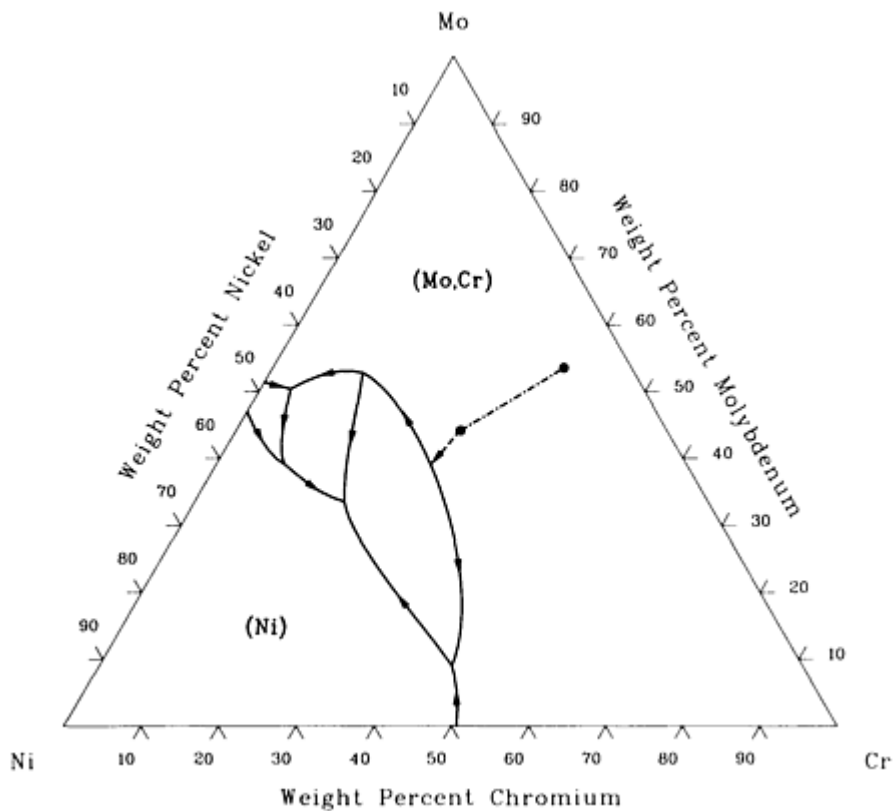

Cr-Mo-Ni liquidus projection [90Gup 64].

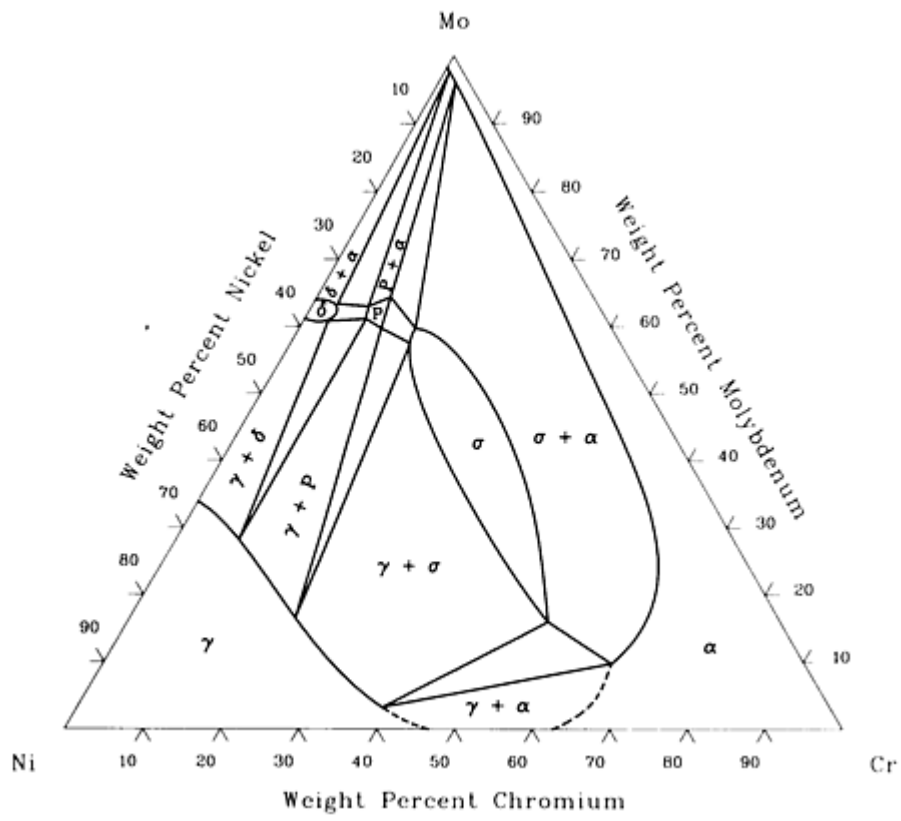

Cr-Mo-Ni isothermal section at 1250 °C [90Gup 64].

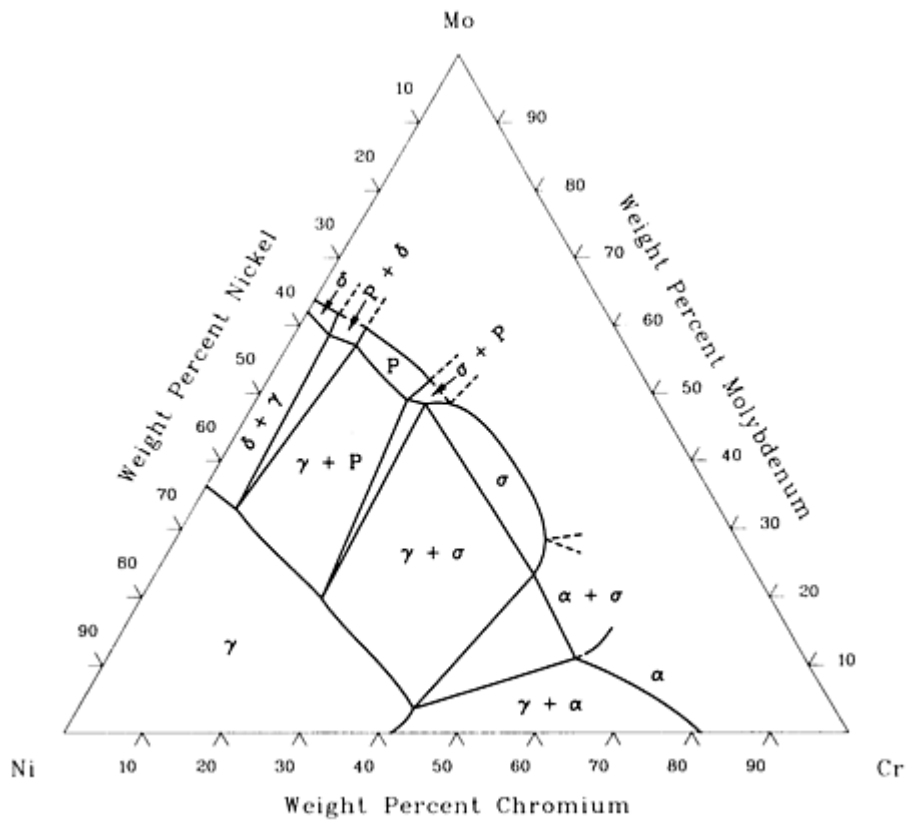

Cr-Mo-Ni isothermal section at 1200 °C [90Gup 64].

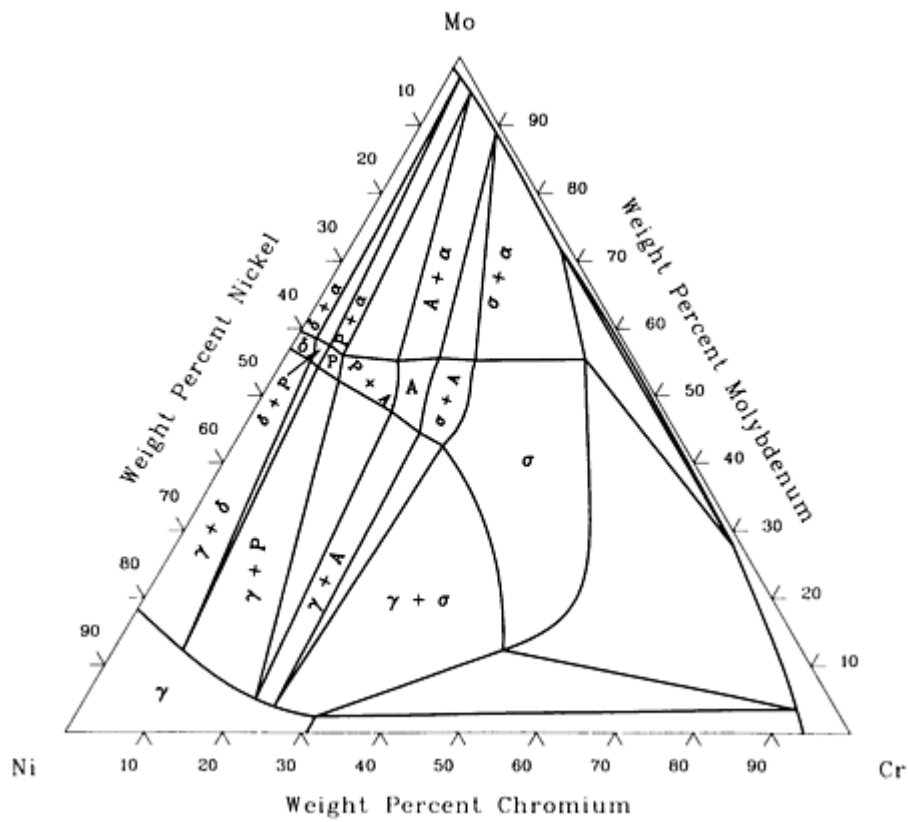

Cr-Mo-Ni isothermal section at 600 °C [90Gup 64].

Reference cited in this section

90Gup: K.P. Gupta, *Phase Diagrams of Ternary Nickel Alloys*, Indian Institute of Metals, Calcutta, (No. 1), 1990

Cr-Mo-W (Chromium - Molybdenum - Tungsten) Ternary Phase Diagrams

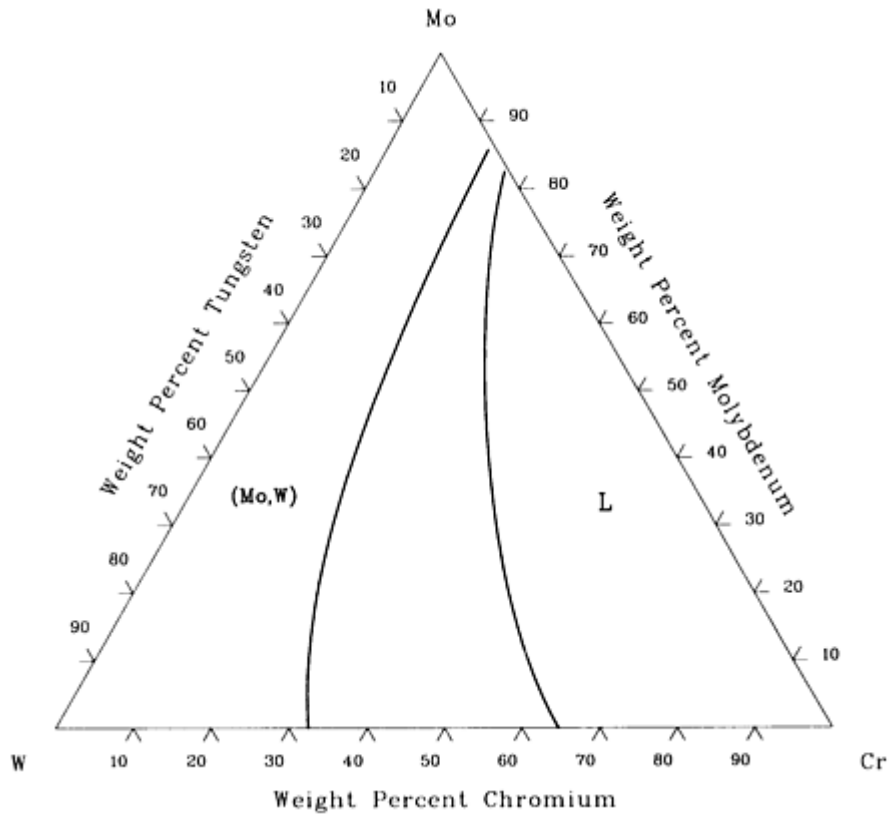

Cr-Mo-W isothermal section at 2227 °C [75Kau 36].

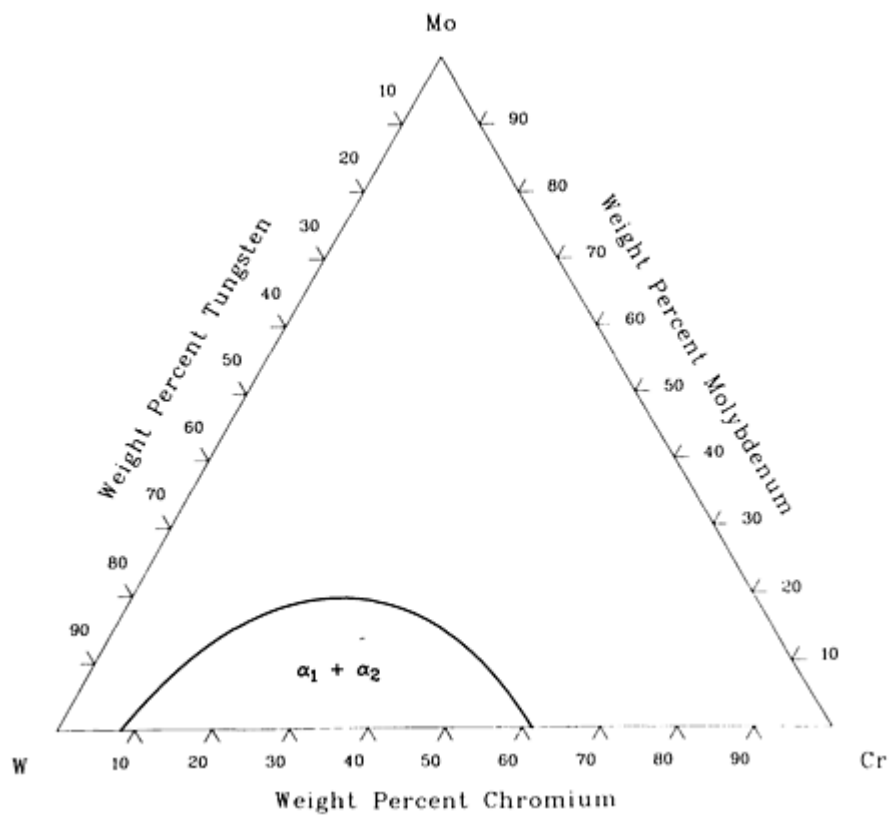

Cr-Mo-W isothermal section at 1300 °C [75Kau 36].

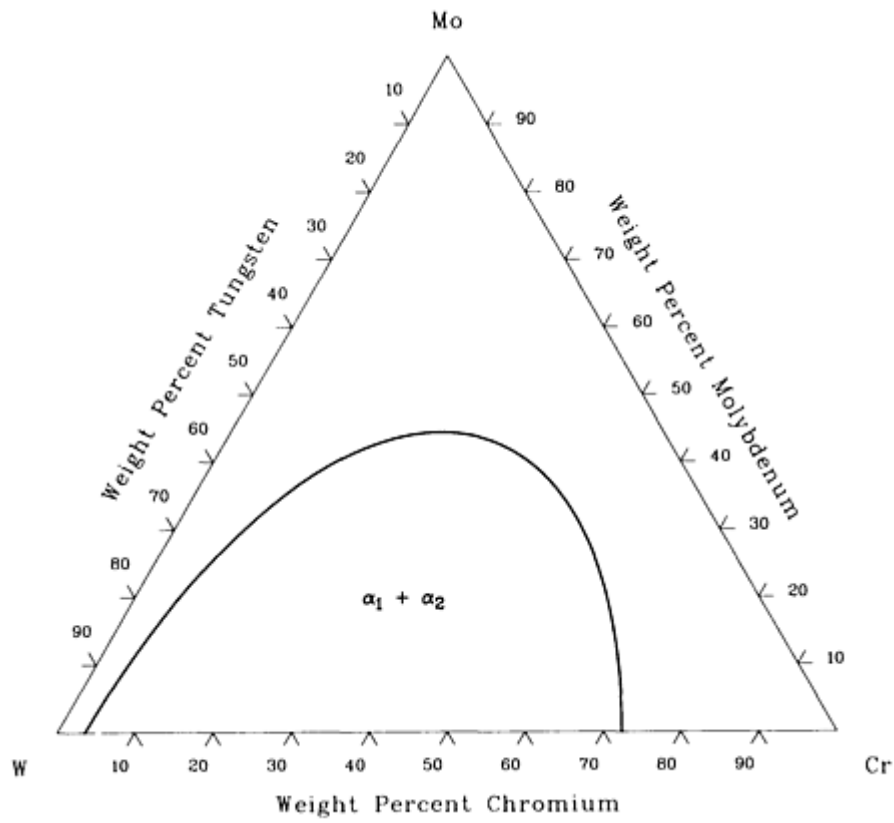

Cr-Mo-W isothermal section at 1000 °C [75Kau 36].

Reference cited in this section

75Kau: L. Kaufman and H. Nesor, "Calculation of Superalloy Phase Diagrams: Part IV," *Metall. Trans. A*, Vol 6, 1975, p 2123-2131

Cr-Nb-Ni (Chromium - Niobium - Nickel) Ternary Phase Diagrams

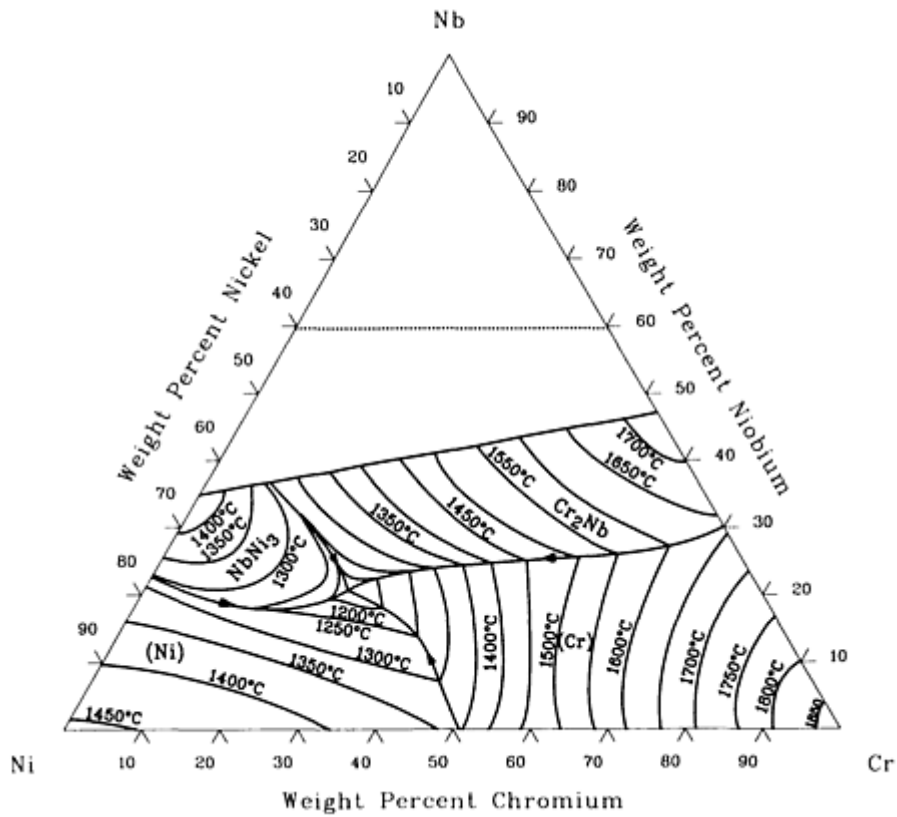

Cr-Nb-Ni liquidus projection [90Gup 64].

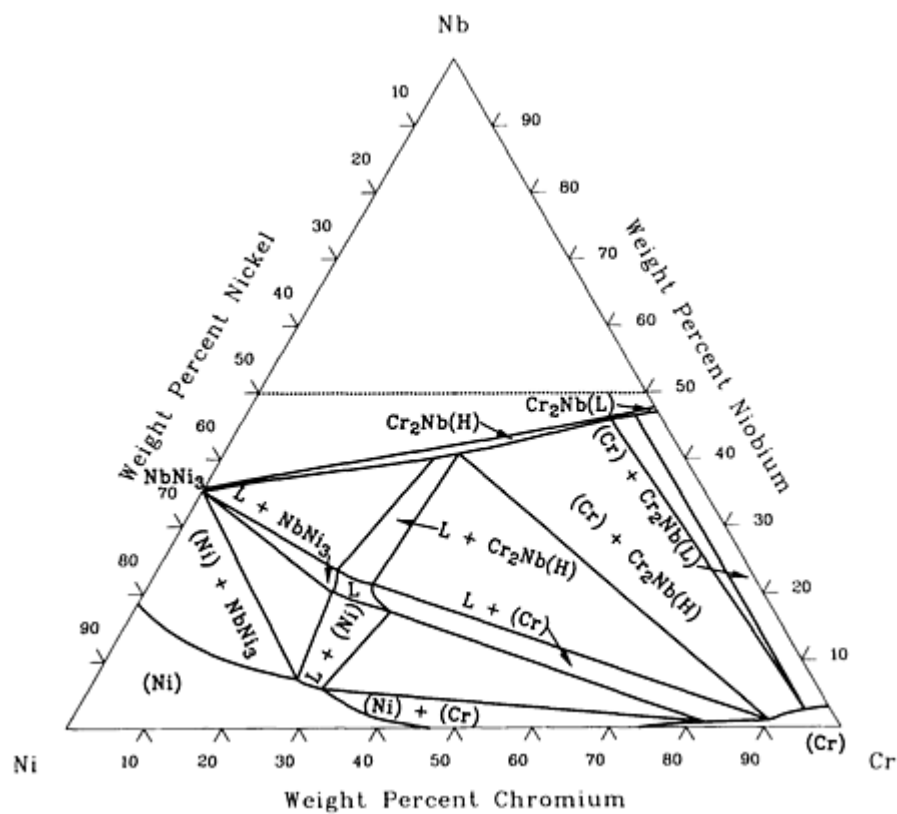

Cr-Nb-Ni isothermal section at 1200 °C [90Gup 64].

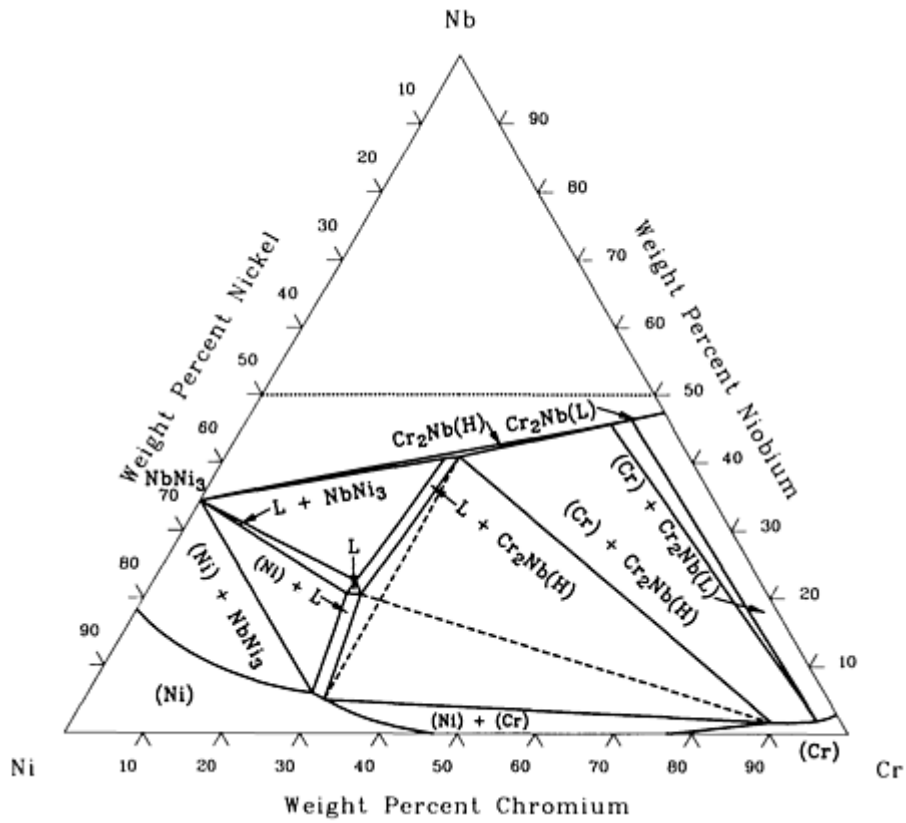

Cr-Nb-Ni isothermal section at 1175 °C [90Gup 64].

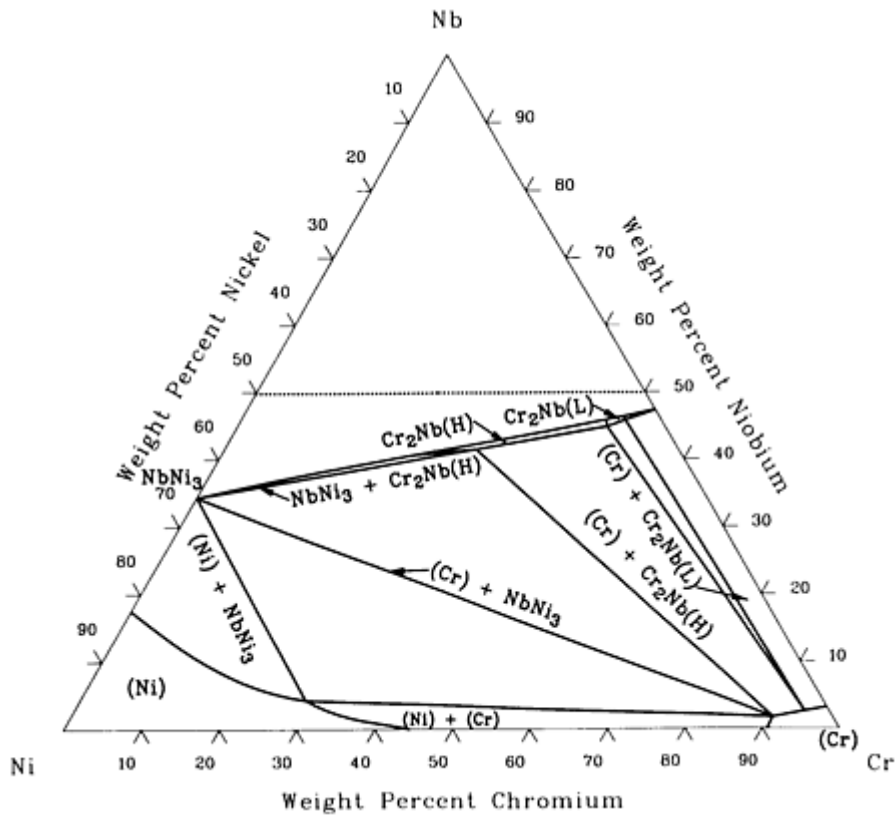

Cr-Nb-Ni isothermal section at 1100 °C [90Gup 64].

Cr-Nb-W (Chromium - Niobium - Tungsten) Ternary Phase Diagrams

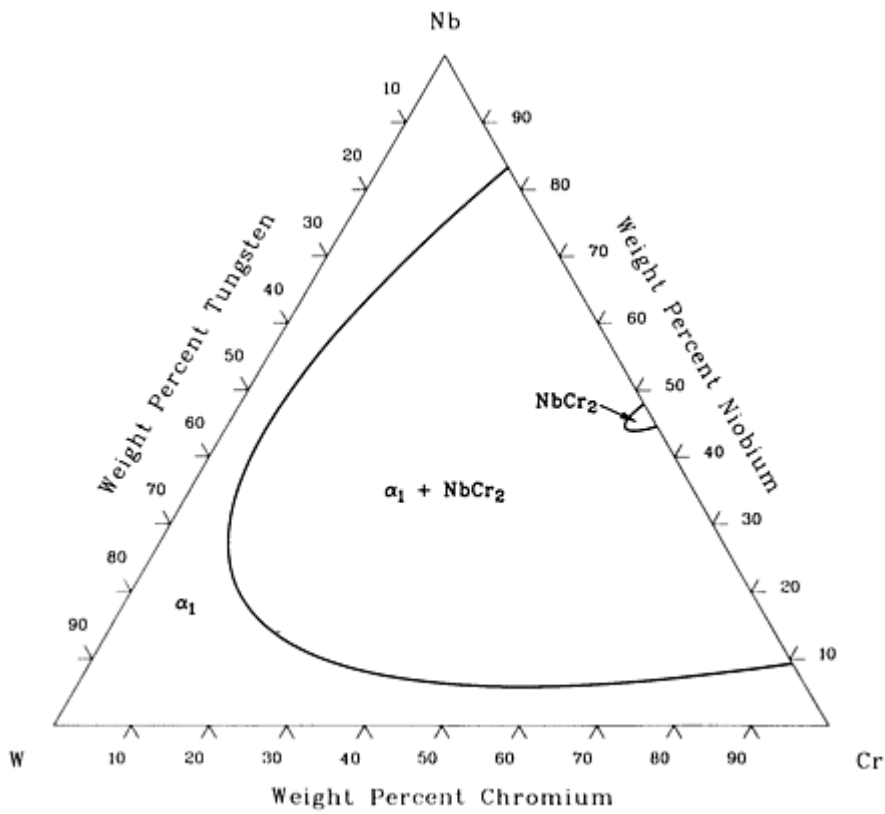

Cr-Nb-W isothermal section at 1500 °C [61Eng 13].

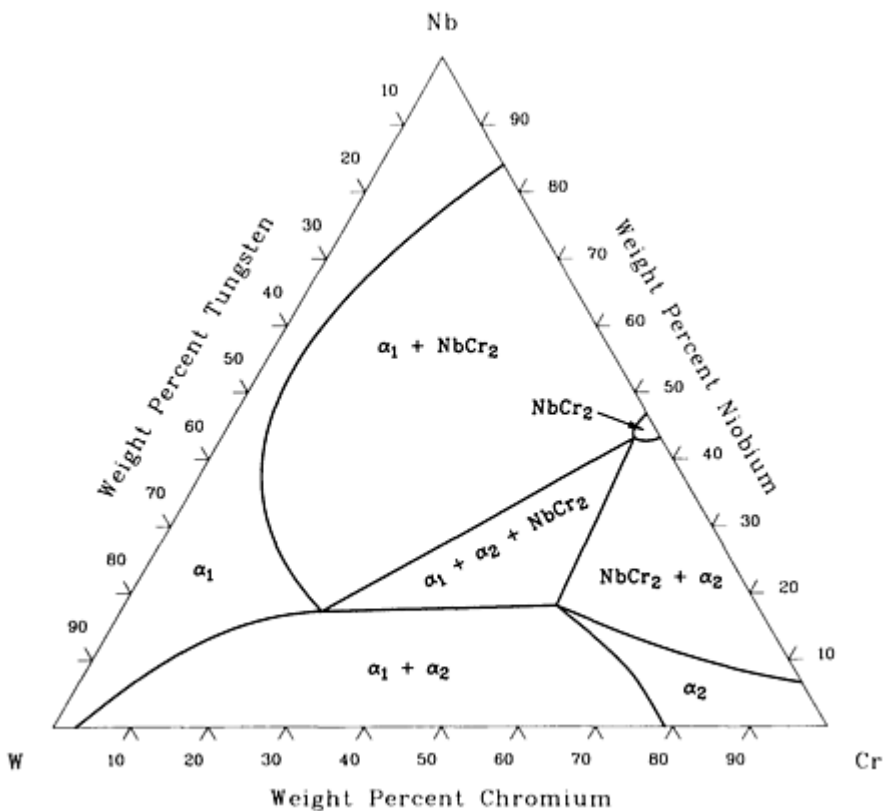

Reference cited in this section

61Eng: J.J. English, "Binary and Ternary Phase Diagrams of Niobium, Molybdenum and Tungsten (1961)," Available as NTIS Document AD 257,739

Cr-Ni-Ti (Chromium - Nickel - Titanium) Ternary Phase Diagrams

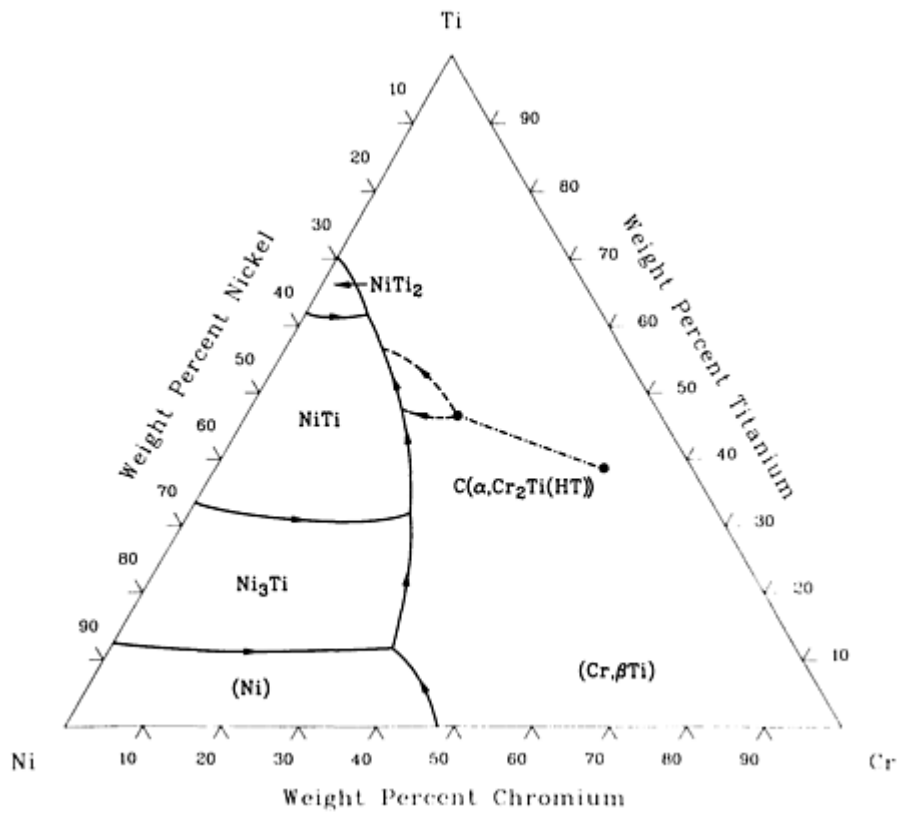

Cr-Ni-Ti liquidus projection [90Gup 64].

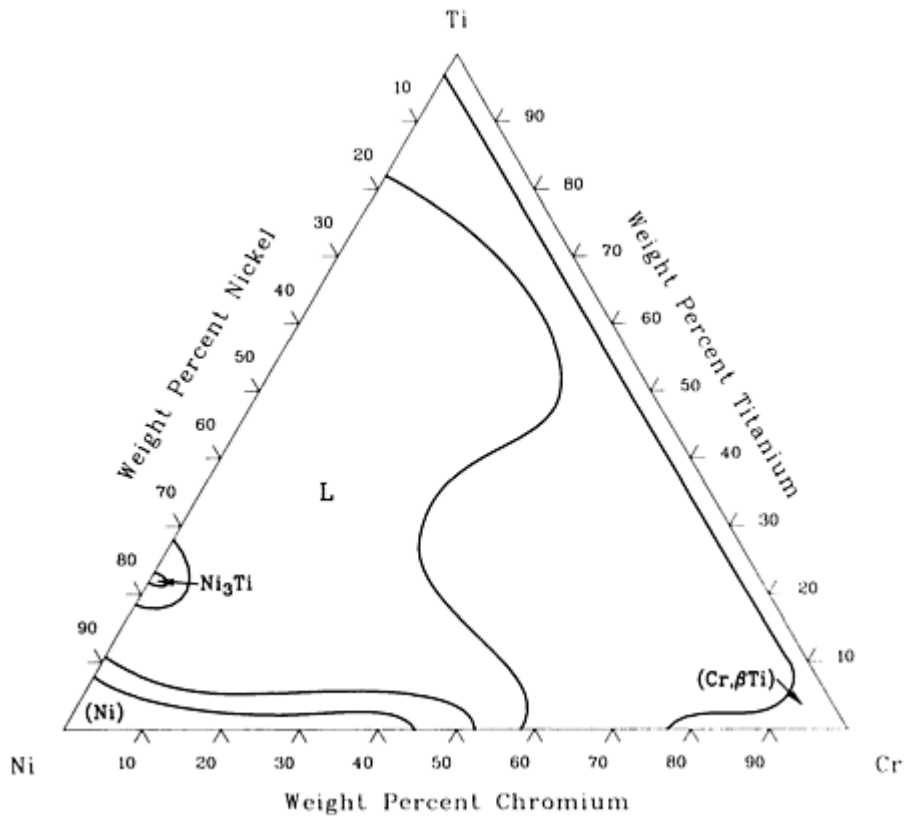

Cr-Ni-Ti isothermal section at 1352 °C [74Kau 35].

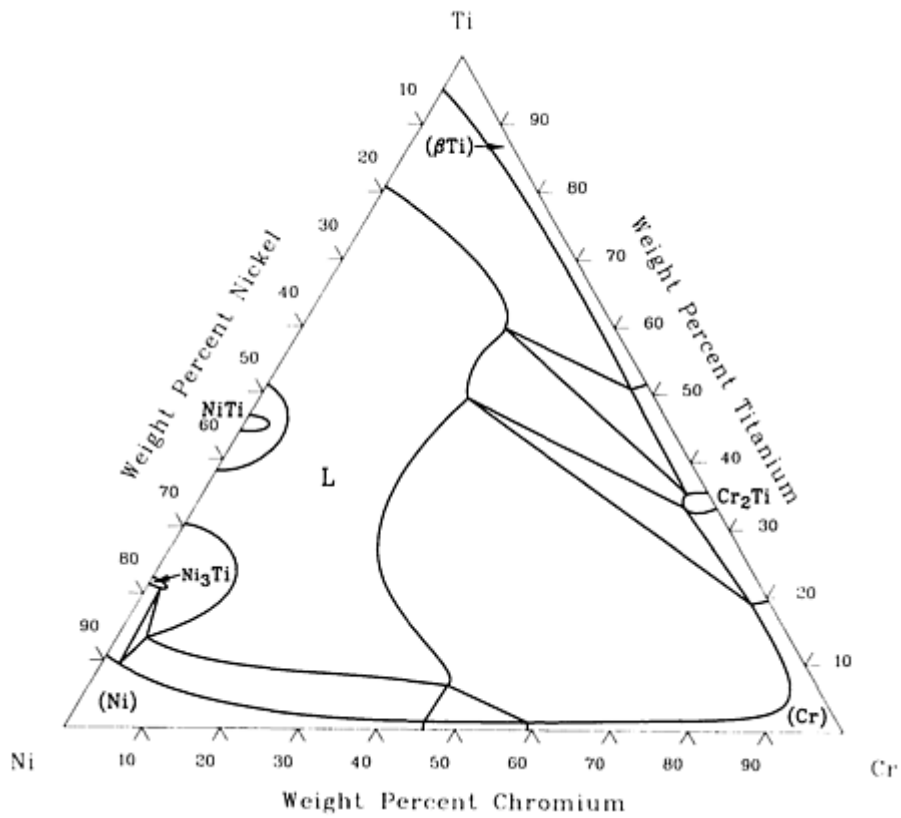

Cr-Ni-Ti isothermal section at 1277 °C [74Kau 35].

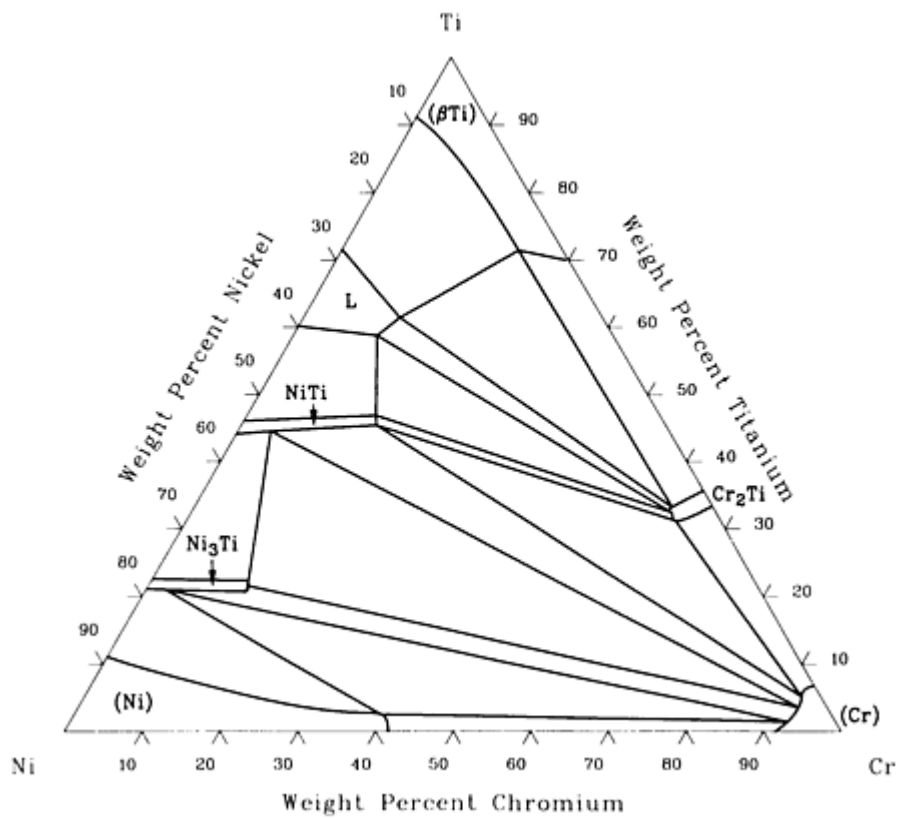

Cr-Ni-Ti isothermal section at 1027 °C [74Kau 35].

References cited in this section

74Kau: L. Kaufman and H. Nesor, "Calculation of Superalloy Phase Diagrams: Part I," *Metall. Trans.*, Vol 5, 1974, p 1617-1621

90Gup: K.P. Gupta, *Phase Diagrams of Ternary Nickel Alloys*, Indian Institute of Metals, Calcutta, (No. 1), 1990

Cr-Ni-W (Chromium - Nickel - Tungsten) Ternary Phase Diagrams

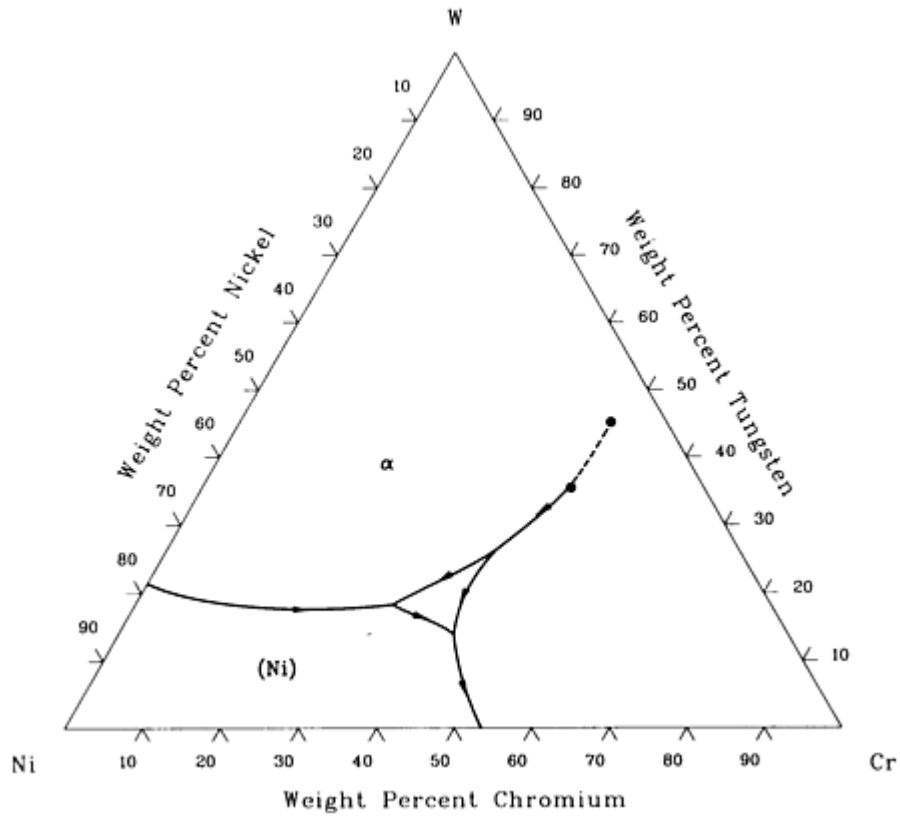

Cr-Ni-W liquidus projection [90Gup 64].

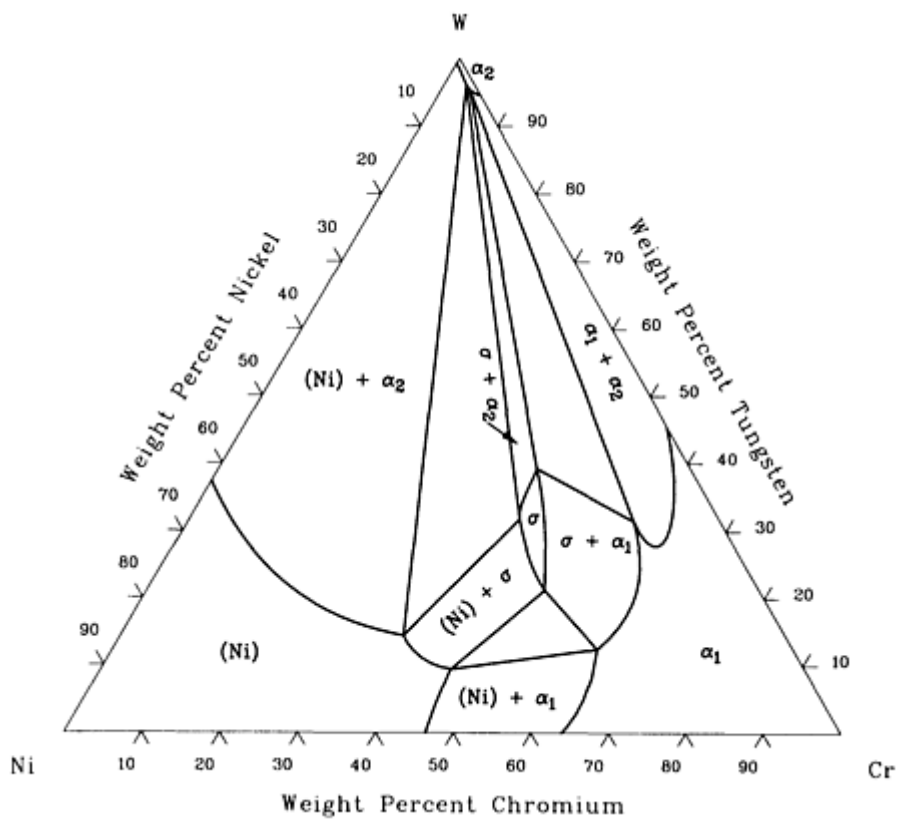

Cr-Ni-W isothermal section at 1250 °C [90Gup 64].

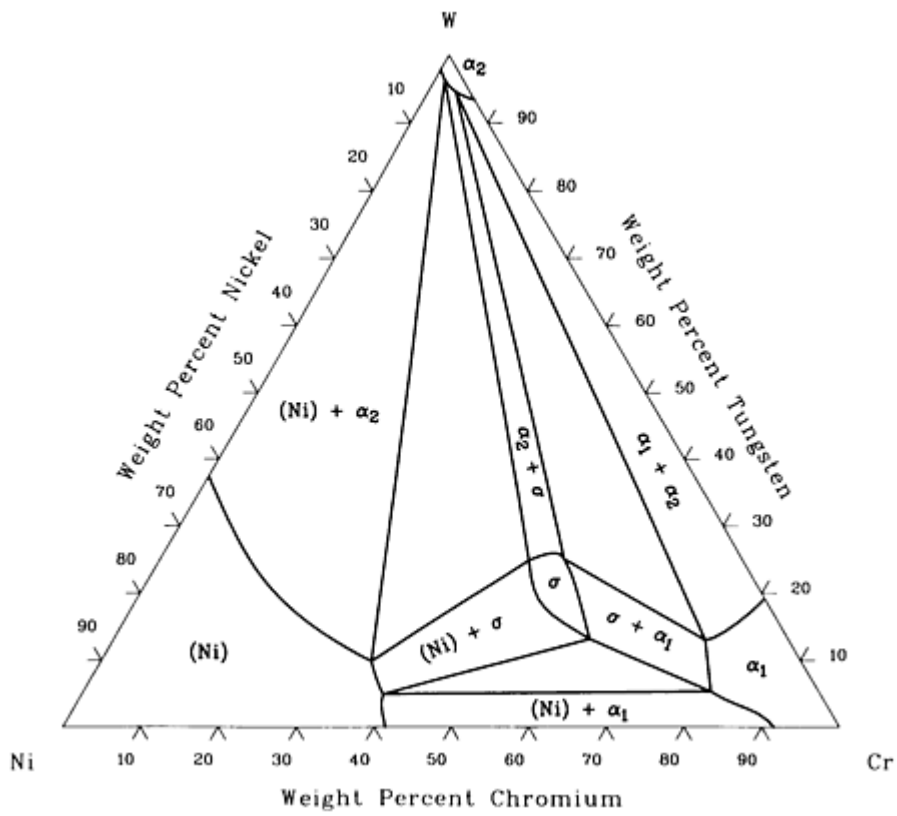

Cr-Ni-W isothermal section at 1000 °C [90Gup 64].

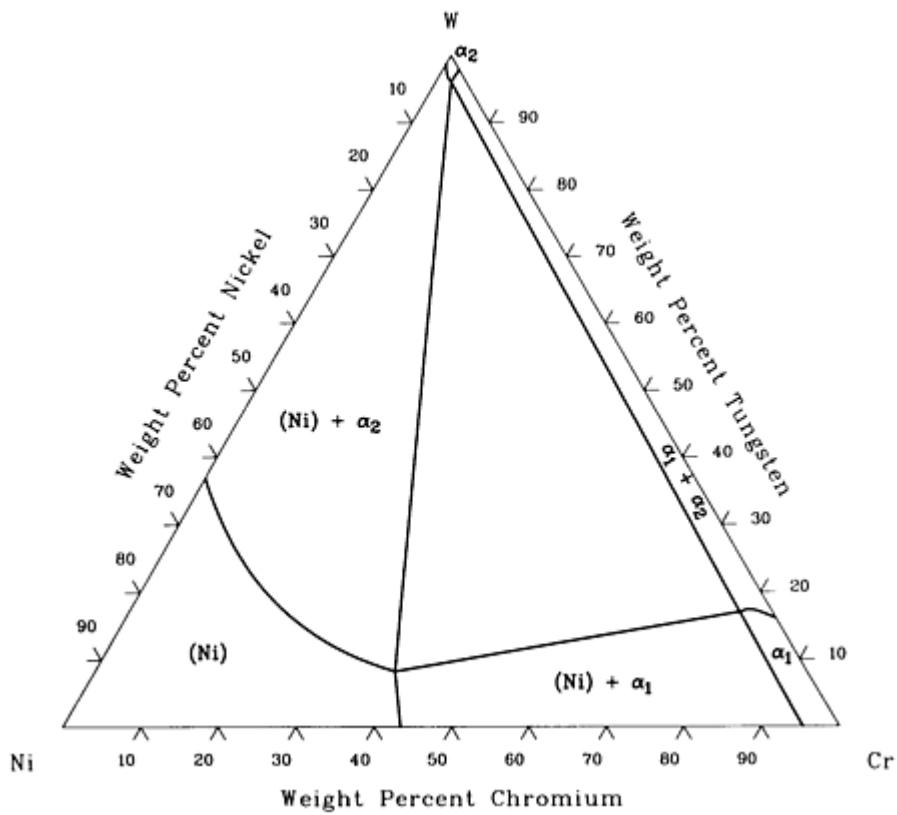

Cr-Ni-W isothermal section at 900 °C [90Gup 64].

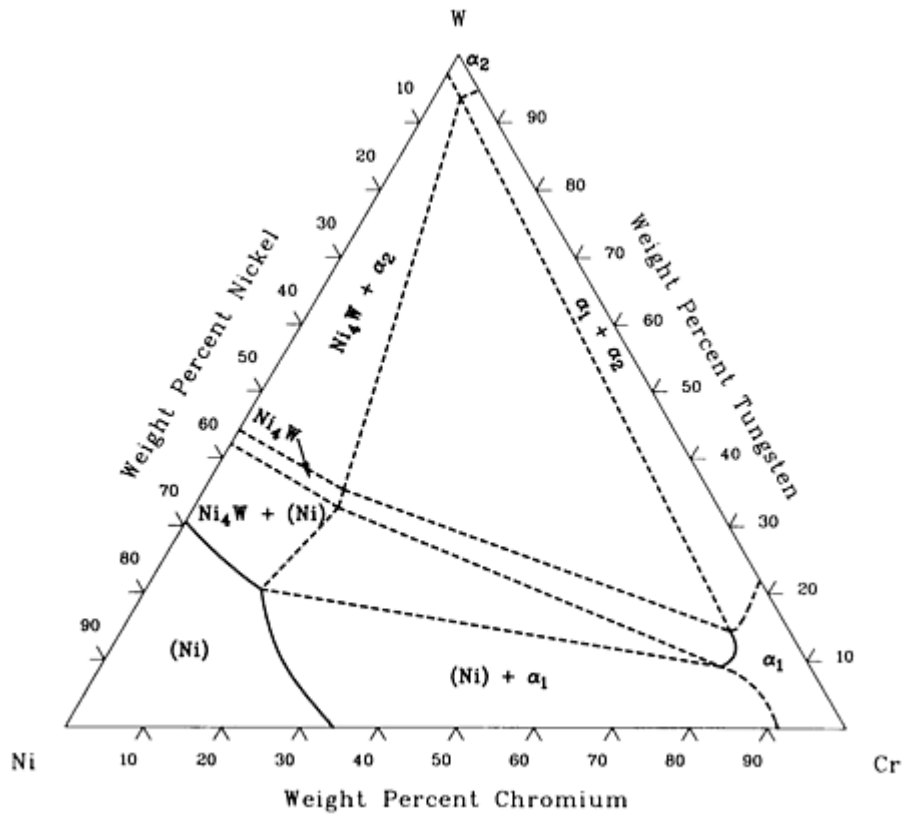

Cr-Ni-W isothermal section at 800 °C [90Gup 64].

Reference cited in this section

90Gup: K.P. Gupta, *Phase Diagrams of Ternary Nickel Alloys*, Indian Institute of Metals, Calcutta, (No. 1), 1990

Cr-Ti-W (Chromium - Titanium - Tungsten) Ternary Phase Diagrams

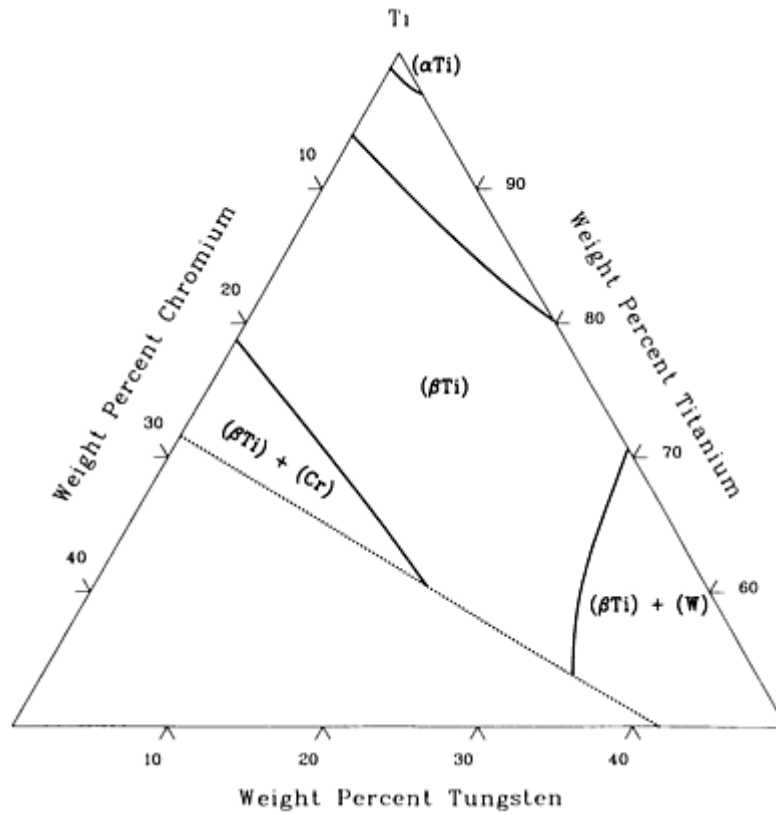

Cr-Ti-W isothermal section at 800 °C [58Bag 9].

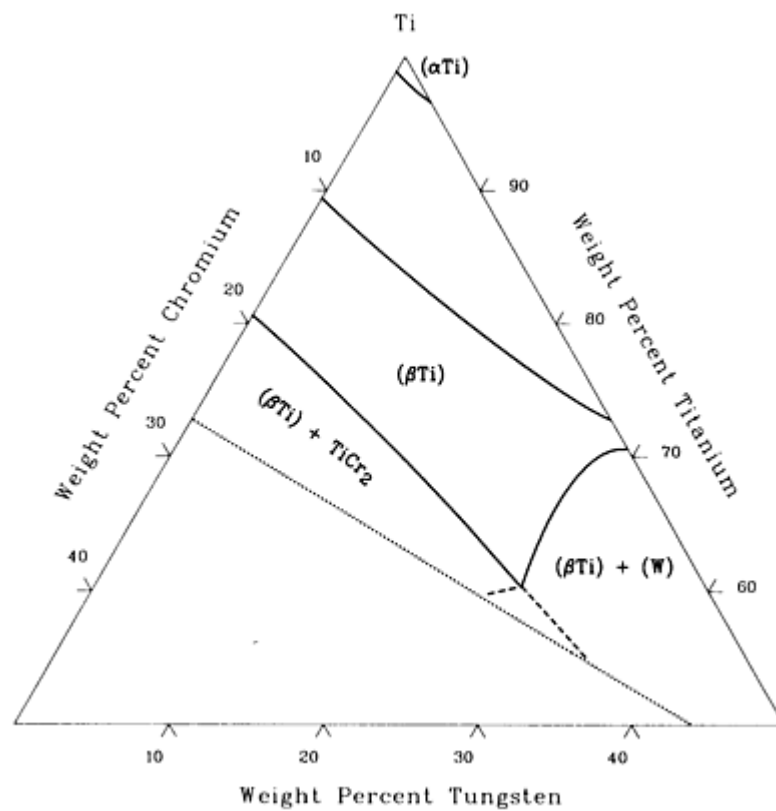

Cr-Ti-W isothermal section at 750 °C [58Bag 9].

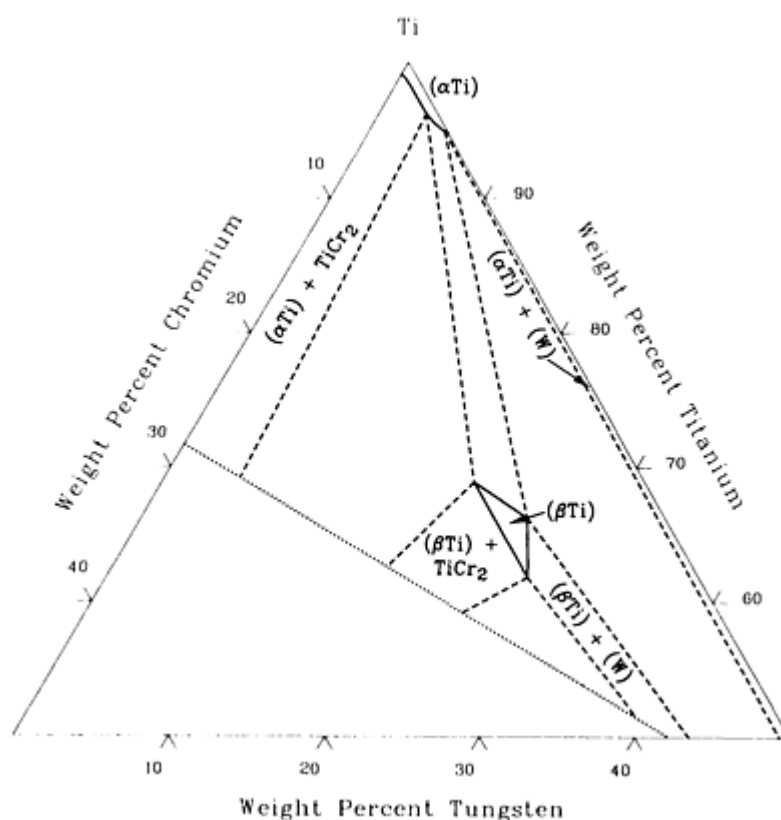

Cr-Ti-W isothermal section at 600 °C [58Bag 9].

Reference cited in this section

58Bag: Yu.A. Bagaryatskiy, G.I. Nosova, and T.V. Tagunova, "Study of the Phase Diagrams of the Alloys Titanium-Chromium, Titanium-Tungsten, and Titanium-Chromium-Tungsten, Prepared by the Method of Powder Metallurgy, *Russ. J. Inorganic Chem.*; TR: *Zh. Neorg. Khim.*, Vol 3 (No. 3), 1958, p 330-341

Cu (Copper) Ternary Alloy Phase Diagrams

Introduction

THIS ARTICLE includes systems where copper is the first-named element in the ternary system. Additional ternary systems that include copper are provided in the following locations in this Volume:

- "Ag-Au-Cu (Silver - Gold - Copper)", "Ag-Cd-Cu (Silver - Cadmium - Copper)" and "Ag-Cu-Zn (Silver - Copper - Zinc)" in the article "Ag (Silver) Ternary Phase Diagrams."
- "Al-Cu-Fe (Aluminum - Copper - Iron)", "Al-Cu-Mn (Aluminum - Copper - Manganese)", "Al-Cu-Ni (Aluminum - Copper - Nickel)", "Al-Cu-Si (Aluminum - Copper - Silicon)" and "Al-Cu-Zn (Aluminum - Copper - Zinc)" in the article "Al (Aluminum) Ternary Phase Diagrams."
- "Au-Cu-Ni (Gold - Copper - Nickel)" in the article "Au (Gold) Ternary Phase Diagrams."
- "C-Cu-Fe (Carbon - Copper - Iron)" in the article "C (Carbon) Ternary Phase Diagrams."

Cu-Fe-Ni (Copper - Iron - Nickel) Ternary Phase Diagrams

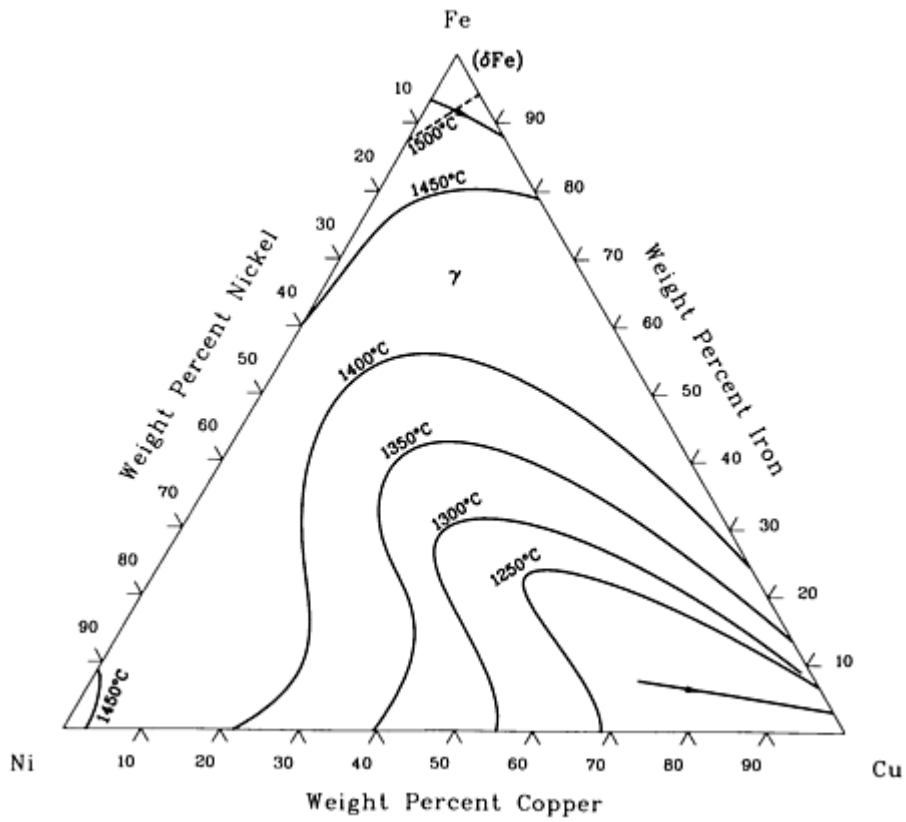

Cu-Fe-Ni liquidus projection [90Gup 64].

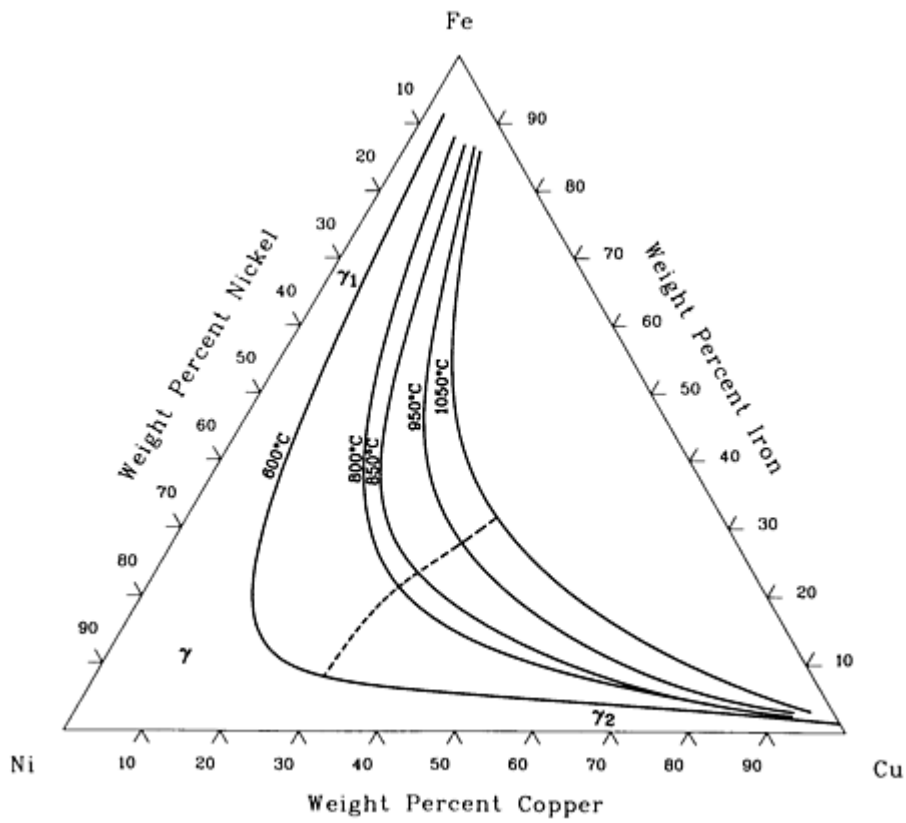

Cu-Fe-Ni miscibility gap [90Gup 64].

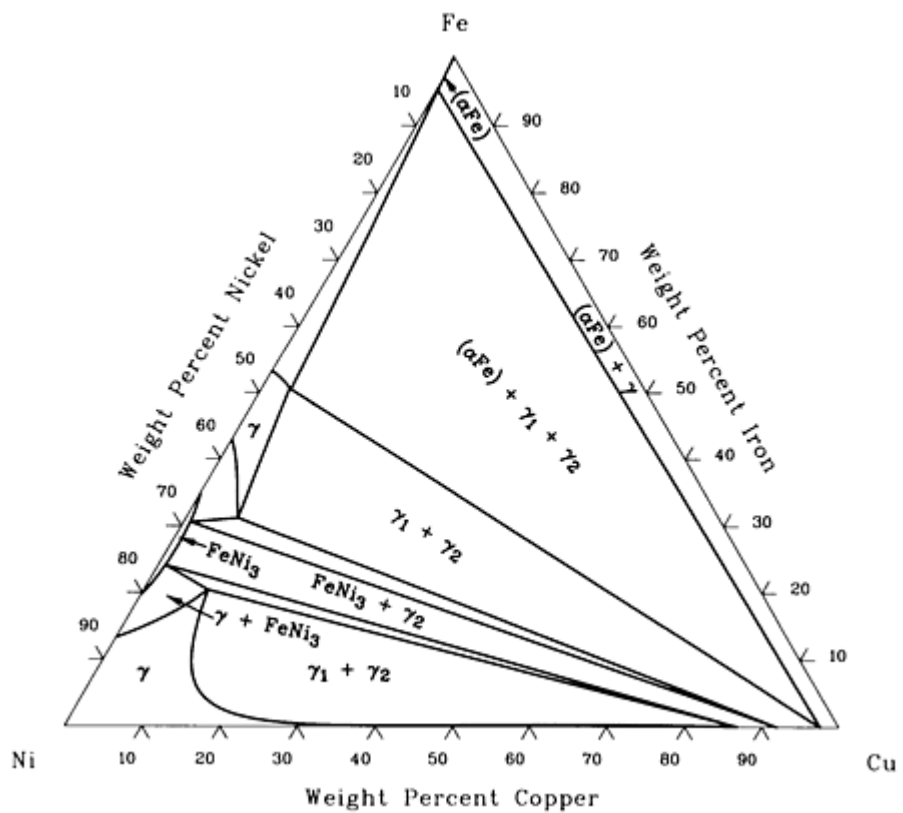

Cu-Fe-Ni isothermal section at 400 °C [90Gup 64].

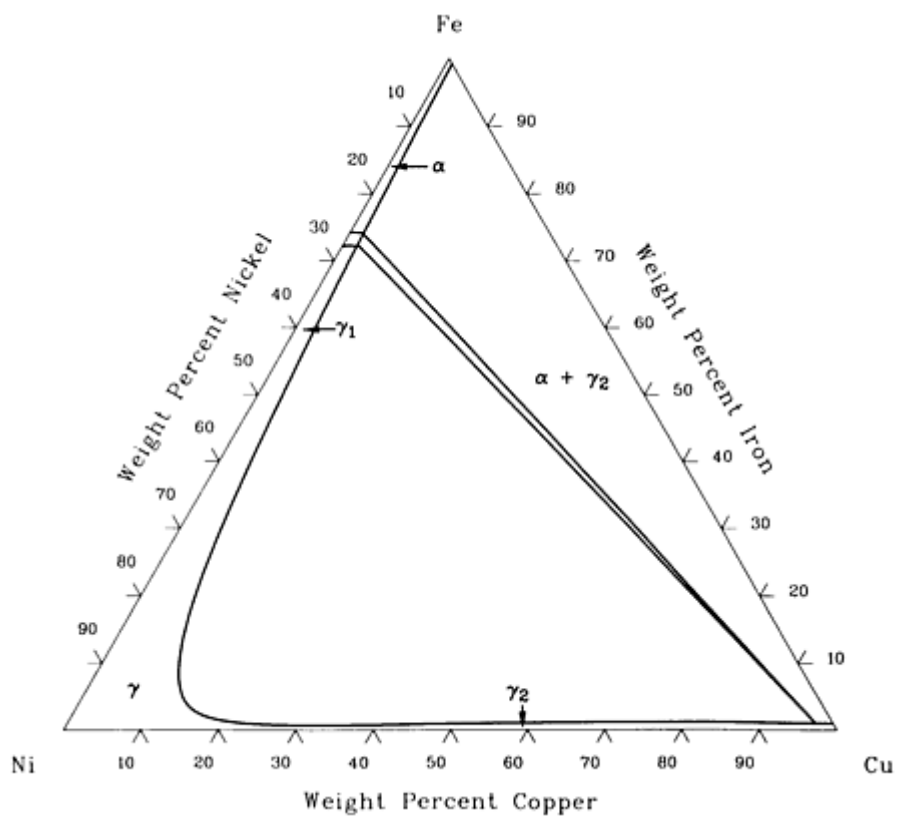

Cu-Fe-Ni isothermal section at 20 °C [90Gup 64].

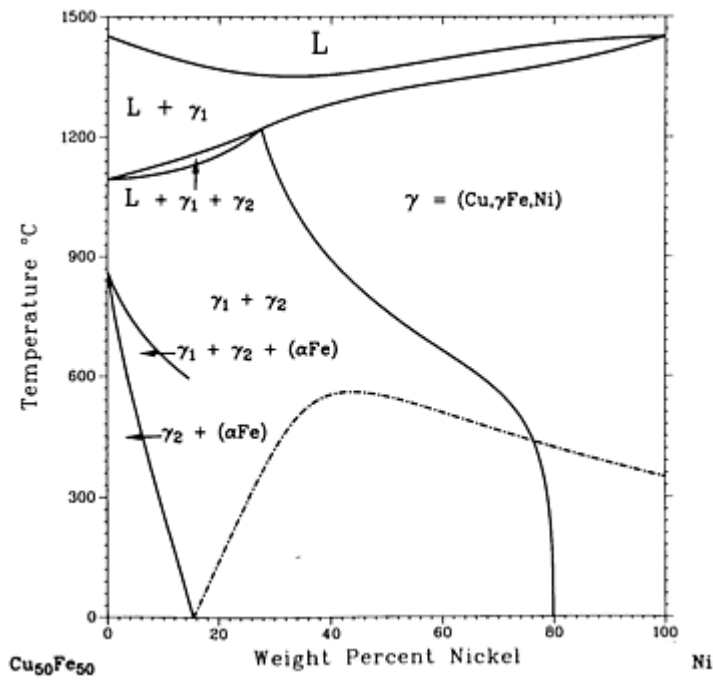

Cu-Fe-Ni [90Gup 64].

Reference cited in this section

90Gup: K.P. Gupta, *Phase Diagrams of Ternary Nickel Alloys*, Indian Institute of Metals, Calcutta, (No. 1), 1990

Cu-Ni-Sn (Copper - Nickel - Tin) Ternary Phase Diagrams

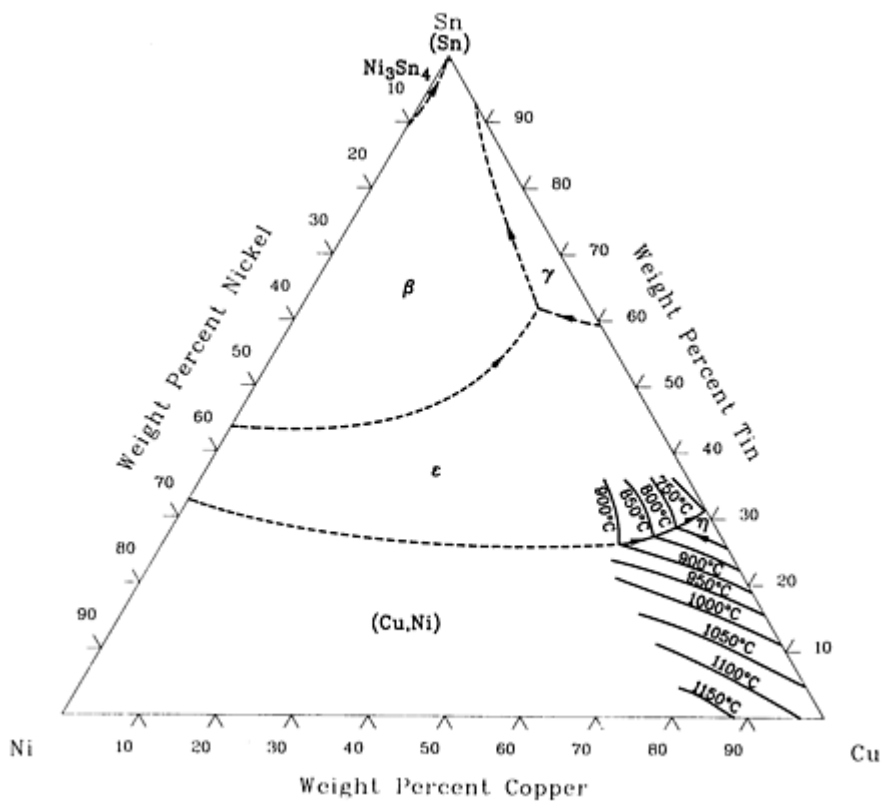

Cu-Ni-Sn liquidus projection [90Gup 64].

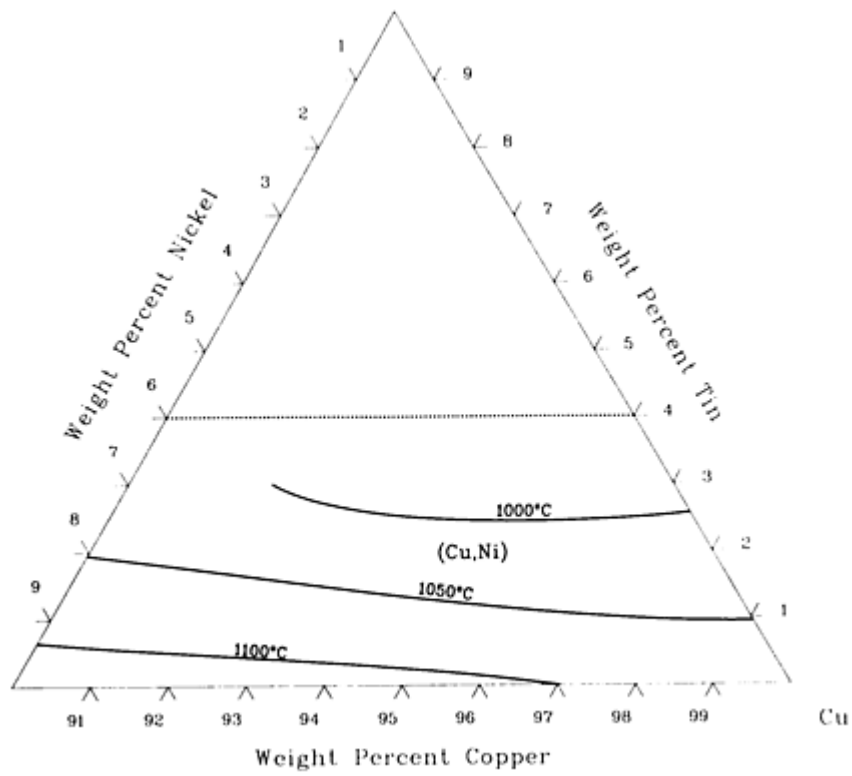

Cu-Ni-Sn solidus projection [90Gup 64].

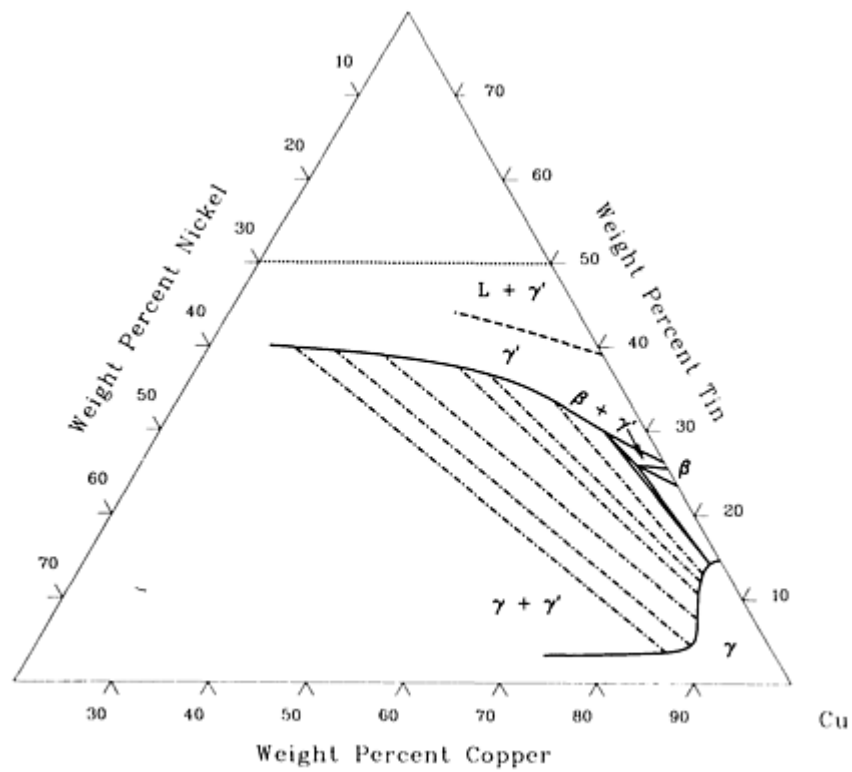

Cu-Ni-Sn isothermal section at 700 °C [90Gup 64].

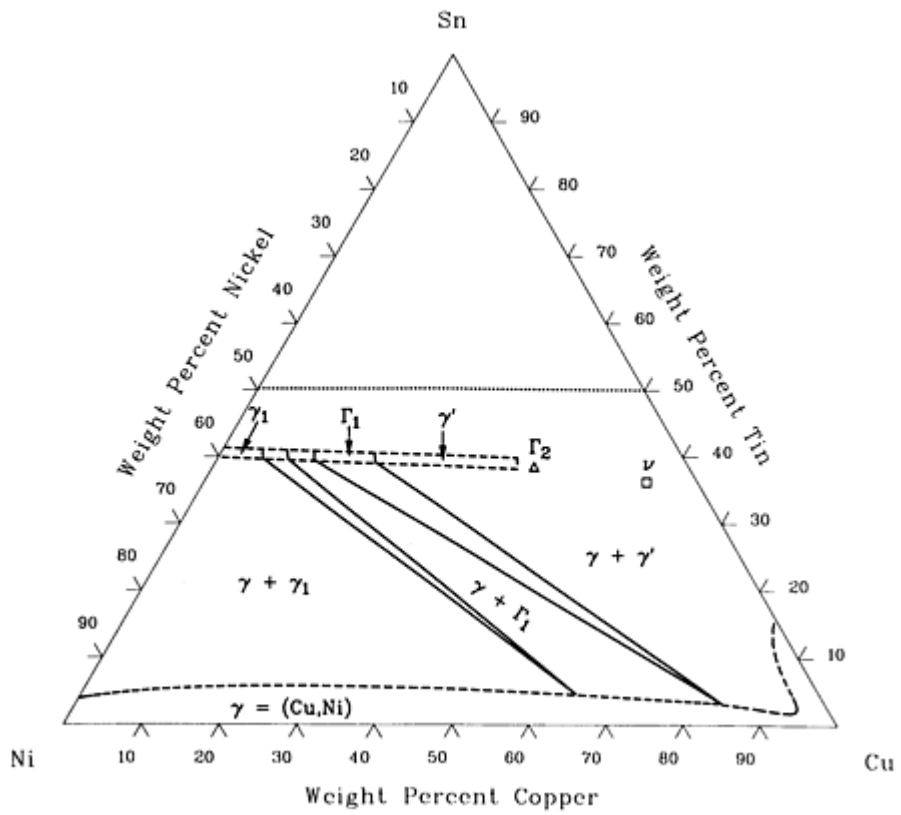

Cu-Ni-Sn isothermal section at 550 °C [90Gup 64].

Reference cited in this section

90Gup: K.P. Gupta, *Phase Diagrams of Ternary Nickel Alloys*, Indian Institute of Metals, Calcutta, (No. 1), 1990

Cu-Ni-Zn (Copper - Nickel - Zinc) Ternary Phase Diagrams

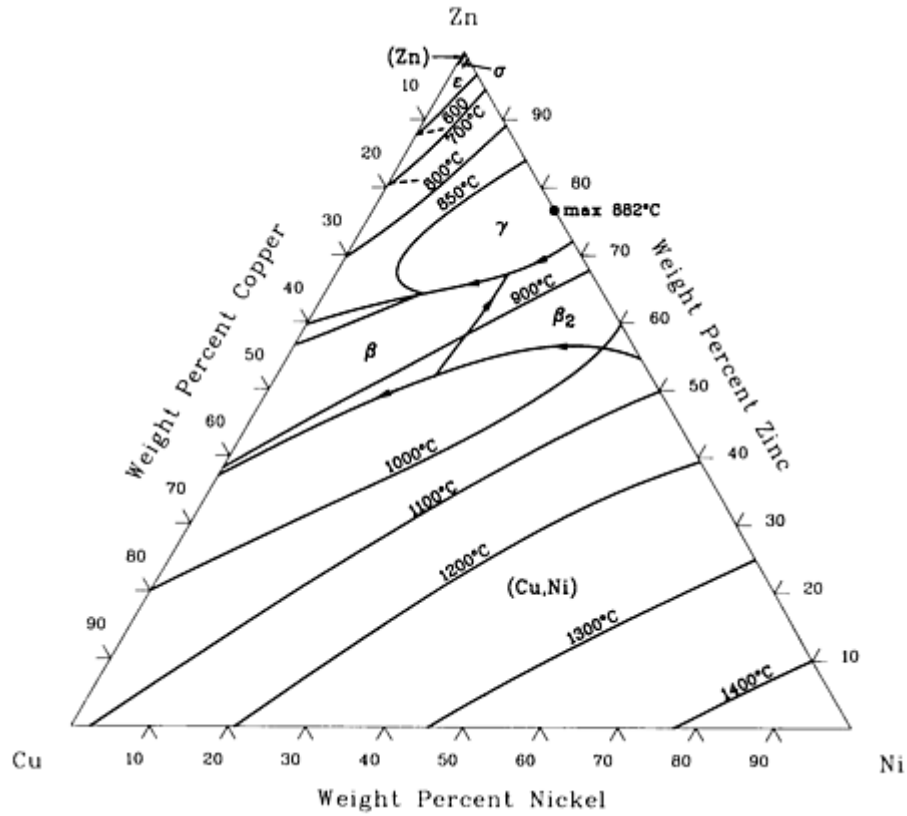

Cu-Ni-Zn liquidus projection [79Cha 38].

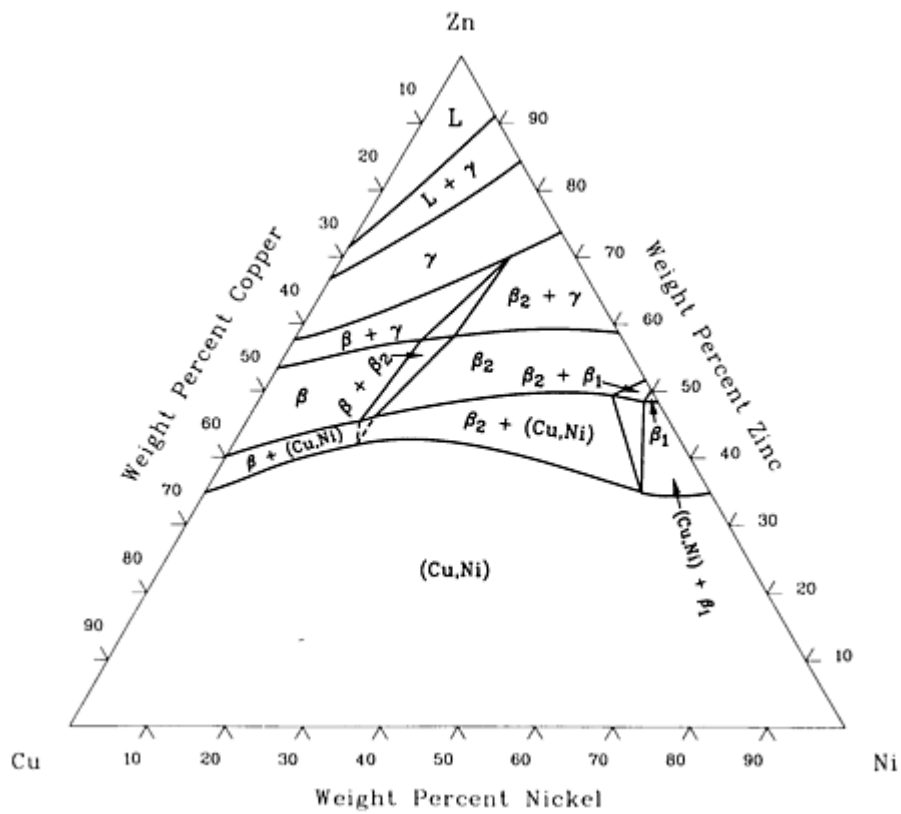

Cu-Ni-Zn isothermal section at 775 °C [79Cha 38].

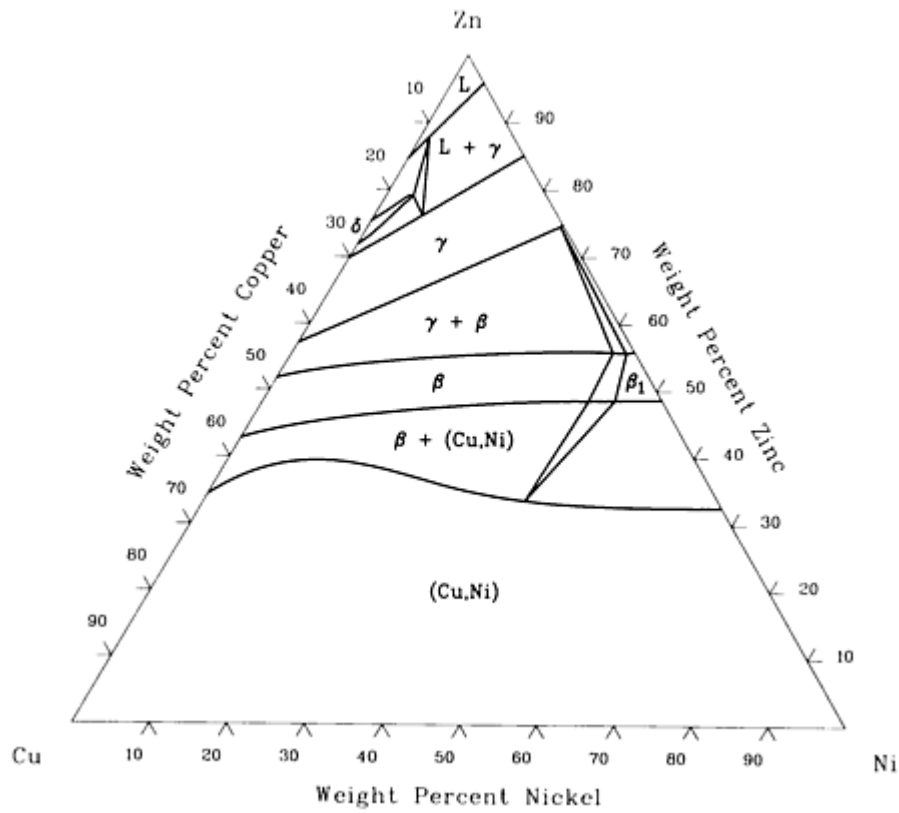

Cu-Ni-Zn isothermal section at 650 °C [73Lev 30].

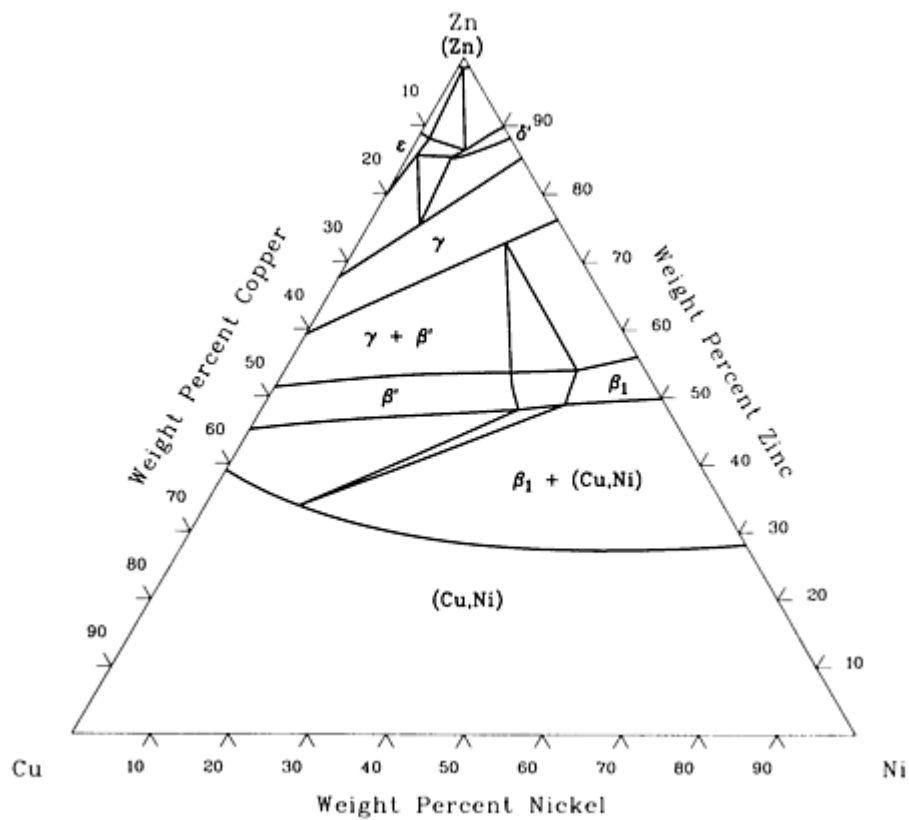

Cu-Ni-Zn isothermal section at 20 °C [73Lev 30].

73Lev: E.D. Levine, *Metallography, Structures and Phase Diagrams*, Vol 8, *Metals Handbook*, 8th ed., American Society for Metals, Metals Park, OH 1973

79Cha: Y.A. Chang, J.P. Neumann, A. Mikula, and D. Goldberg, *Phase Diagrams and Thermodynamic Properties of Ternary Copper-Metal Systems*, INCRA Monograph VI, International Copper Research Association, 1979

Cu-Pb-Zn (Copper - Lead - Zinc) Ternary Phase Diagrams

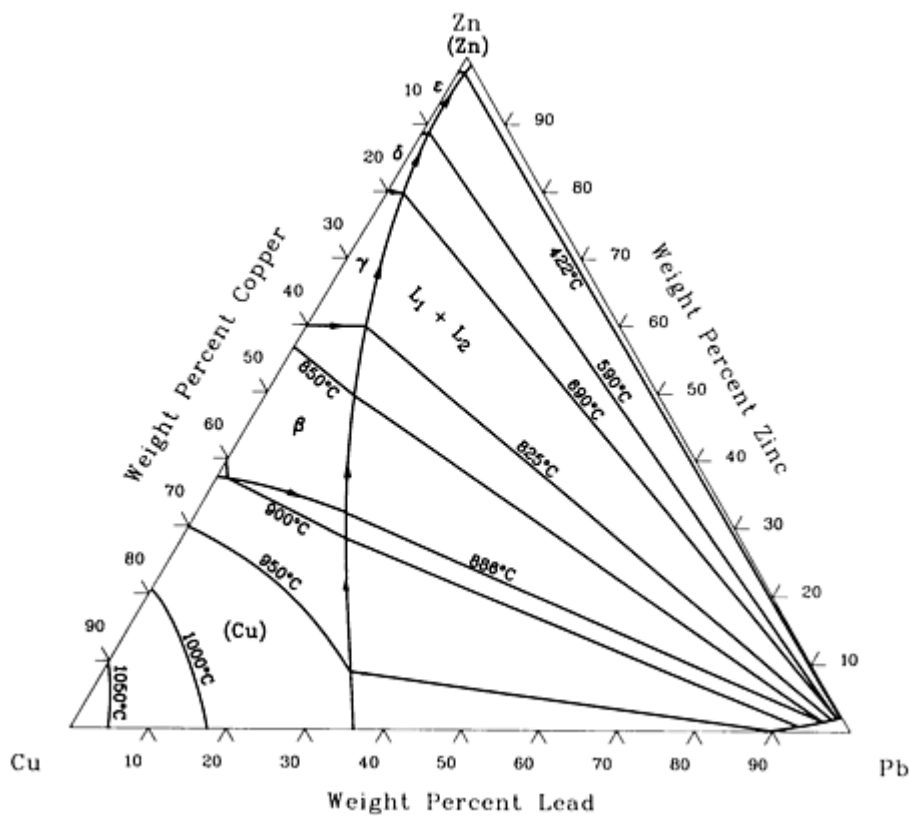

Cu-Pb-Zn liquidus projection [79Cha 38].

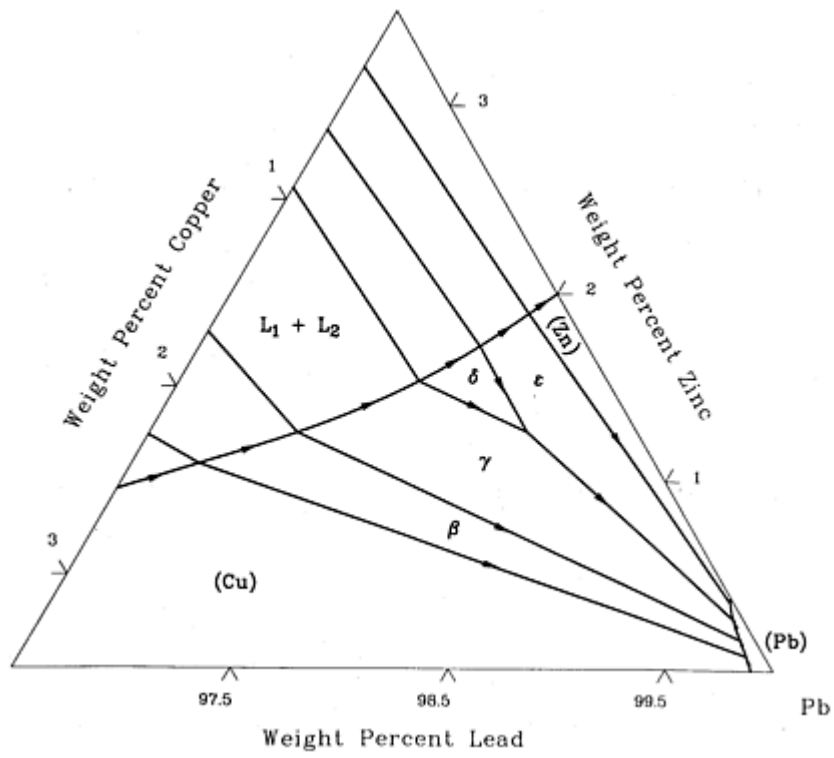

Cu-Pb-Zn (Pb) liquidus projection [79Cha 38].

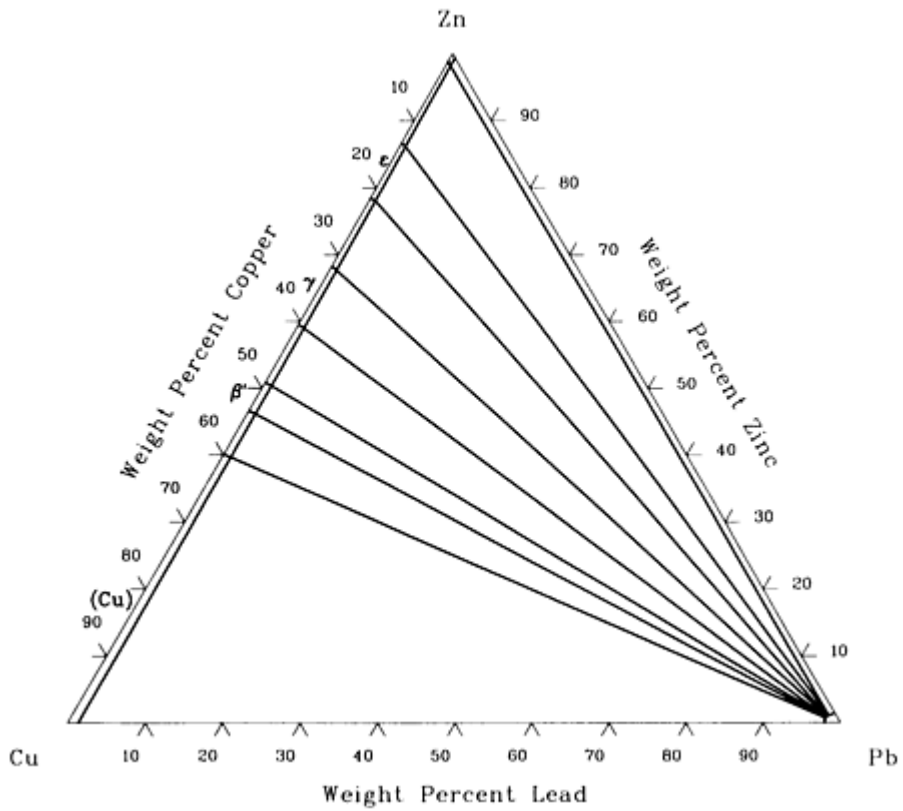

Cu-Pb-Zn isothermal section at 25 °C [29Bau 2].

References cited in this section

29Bau: O. Bauer and M. Hansen, "Der Einfluss von dritten Metallen auf die Konstitution der Messingleg

ierungen. I. Der Einfluss von Blei," *Z. Metallkd.*, Vol 21, 1929, p 190-196

79Cha: Y.A. Chang, J.P. Neumann, A. Mikula, and D. Goldberg, *Phase Diagrams and Thermodynamic Properties of Ternary Copper-Metal Systems*, INCRA Monograph VI, International Copper Research Association, 1979

Cu-Sb-Sn (Copper - Antimony - Tin) Ternary Phase Diagrams

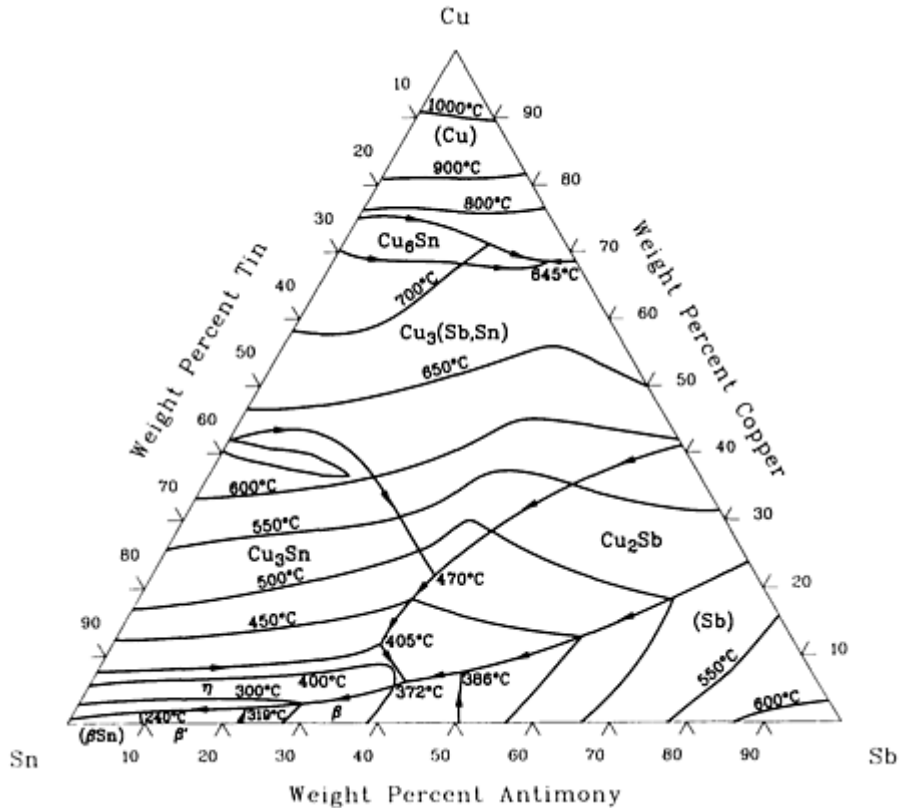

Cu-Sb-Sn liquidus projection [73Bla 27].

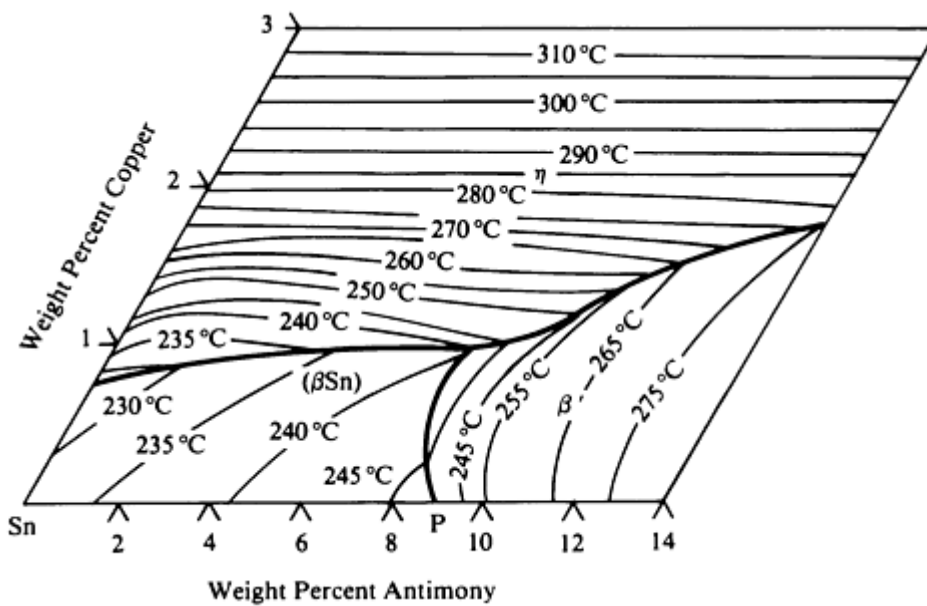

Cu-Sb-Sn (Sn) liquidus projection [73Bla 27].

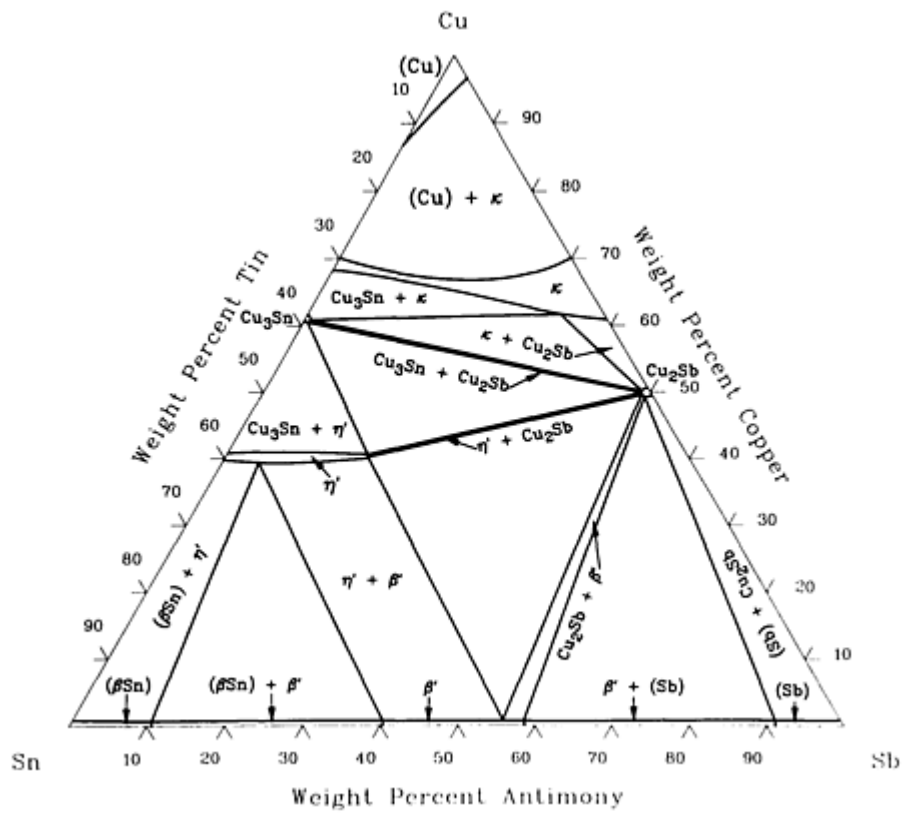

Cu-Sb-Sn phases present at temperatures below the reactions in the solid state [73Bl a 27].

Reference cited in this section

73Bl a: J.M. Blalock, Jr., J.V. Harding, and W.T. Pell-Walpole, *Metallography, Structures and Phase Diagrams*, Vol 8, *Metals Handbook*, 8th ed., American Society for Metals, Metals, Park, OH, 1973

Cu-Sn-Zn (Copper - Tin - Zinc) Ternary Phase Diagrams

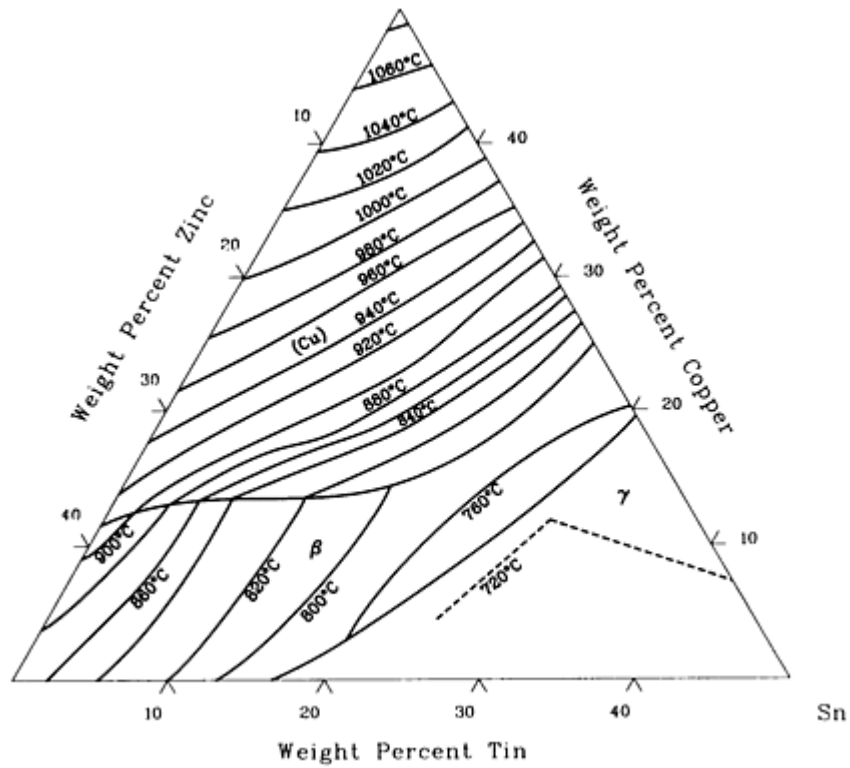

Cu-Sn-Zn liquidus projection [73Smi 33].

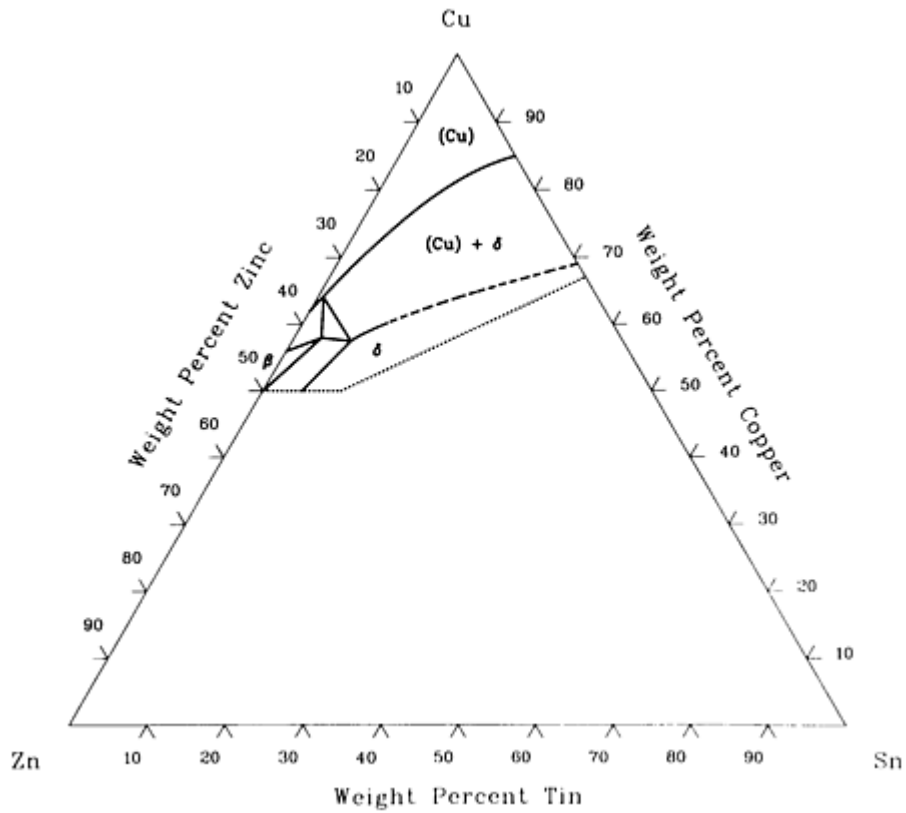

Cu-Sn-Zn isothermal section at 500 °C [73Smi 33].

Fe (Iron) Ternary Alloy Phase Diagrams

Introduction

THIS ARTICLE includes systems where iron is the first-named element in the ternary system. Additional ternary systems that include iron are provided in the following locations in this Volume:

- “Al-Cr-Fe (Aluminum - Chromium - Iron)”, “Al-Cu-Fe (Aluminum - Copper - Iron)”, “Al-Fe-Mn (Aluminum - Iron - Manganese)”, “Al-Fe-Ni (Aluminum - Iron - Nickel)”, “Al-Fe-Si (Aluminum - Iron - Silicon)”, and “Al-Fe-Zn (Aluminum - Iron - Zinc)” in the article “Al (Aluminum) Ternary Phase Diagrams.”
- “B-C-Fe (Boron - Carbon - Iron)” in the article “B (Boron) Ternary Phase Diagrams.”
- “C-Cr-Fe (Carbon - Chromium - Iron)”, “C-Cu-Fe (Carbon - Copper - Iron)”, “C-Fe-Mn (Carbon - Iron - Manganese)”, “C-Fe-Mo (Carbon - Iron - Molybdenum)”, “C-Fe-N (Carbon - Iron - Nitrogen)”, “C-Fe-Ni (Carbon - Iron - Nickel)”, “C-Fe-Si (Carbon - Iron - Silicon)”, “C-Fe-V (Carbon - Iron - Vanadium)” and “C-Fe-W (Carbon - Iron - Tungsten)” in the article “C (Carbon) Ternary Phase Diagrams.”
- “Co-Cr-Fe (Cobalt - Chromium - Iron)”, “Co-Fe-Mo (Cobalt - Iron - Molybdenum)”, “Co-Fe-Ni (Cobalt - Iron - Nickel)” and “Co-Fe-W (Cobalt - Iron - Tungsten)” in the article “Co (Cobalt) Ternary Phase Diagrams.”
- “Cr-Fe-Mo (Chromium - Iron - Molybdenum)”, “Cr-Fe-N (Chromium - Iron - Nitrogen)”, “Cr-Fe-Ni (Chromium - Iron - Nickel)”, “Cr-Fe-W (Chromium - Iron - Tungsten)” and “Cu-Fe-Ni (Copper - Iron - Nickel)” in the article “Cu (Copper) Ternary Phase Diagrams.”

Fe-Mn-Ni (Iron - Manganese - Nickel) Ternary Phase Diagrams

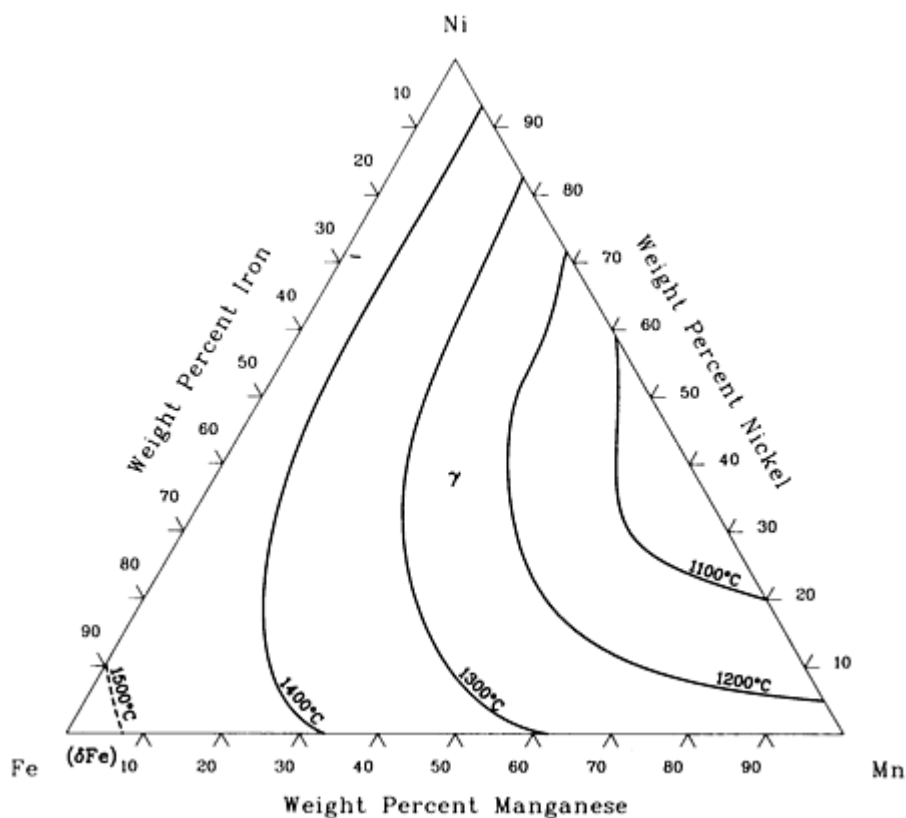

Fe-Mn-Ni liquidus projection [88Ray 60].

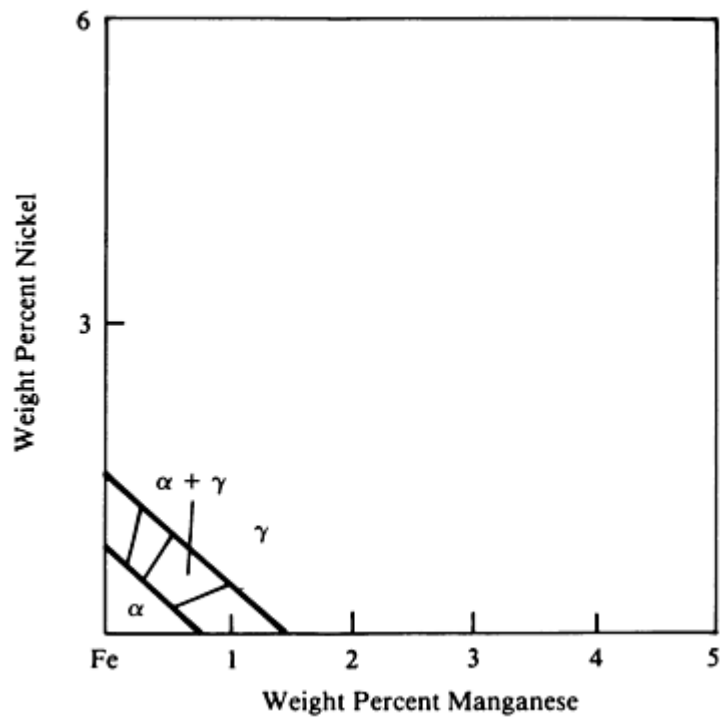

Fe-Mn-Ni isothermal section at 850 °C [89Har 63].

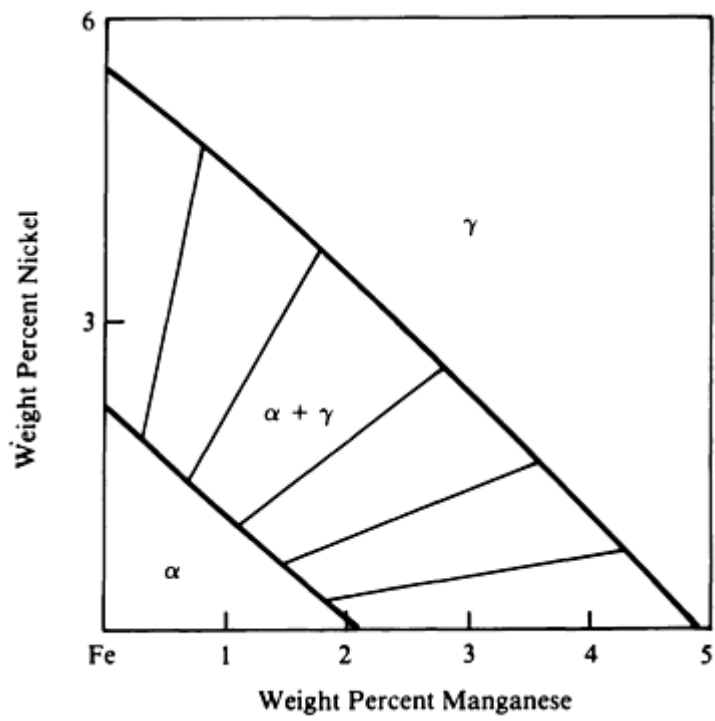

Fe-Mn-Ni isothermal section at 750 °C [89Har 63].

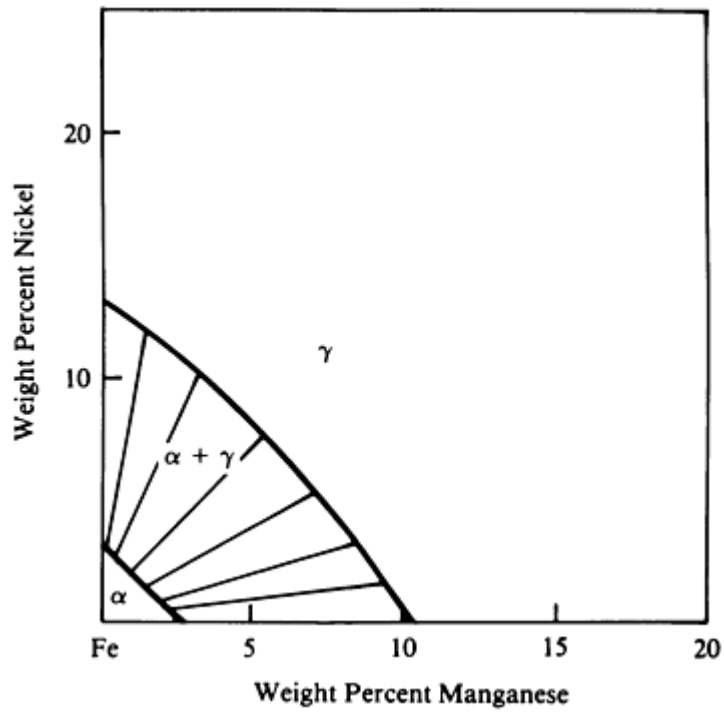

Fe-Mn-Ni isothermal section at 650 °C [89Har 63].

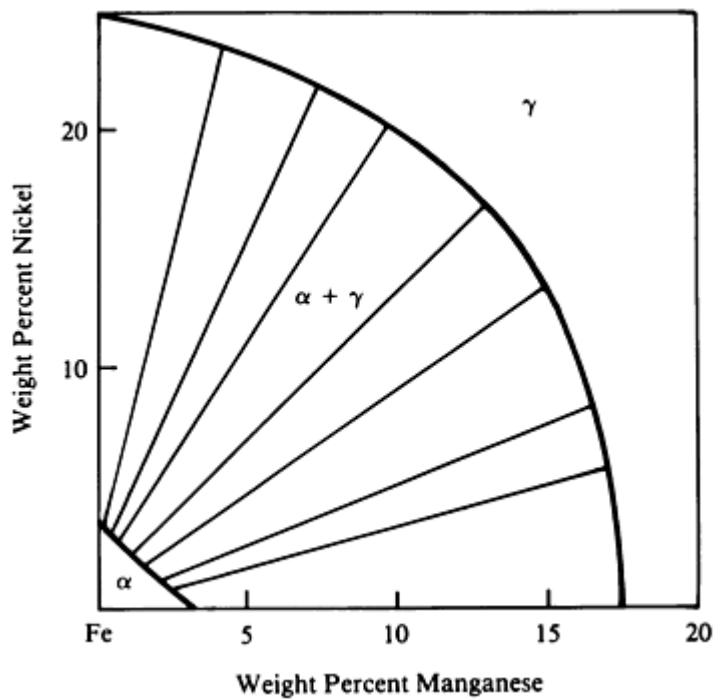

Fe-Mn-Ni isothermal section at 550 °C [89Har 63].

References cited in this section

- 88Ray:** G.V. Raynor and V.G. Rivlin, *Phase Equilibria in Iron Ternary Alloys*, The Institute of Metals, London, (No. 4), 1988
- 89Har:** K.C. Harikumar and V. Raghavan, "BCC-FCC Equilibrium in Ternary Iron Alloys II," *J. Alloy Phase Diagrams*, India, Vol 5 (No. 2), 1989, p 77-96

Fe-Mo-Nb (Iron - Molybdenum - Niobium) Ternary Phase Diagrams

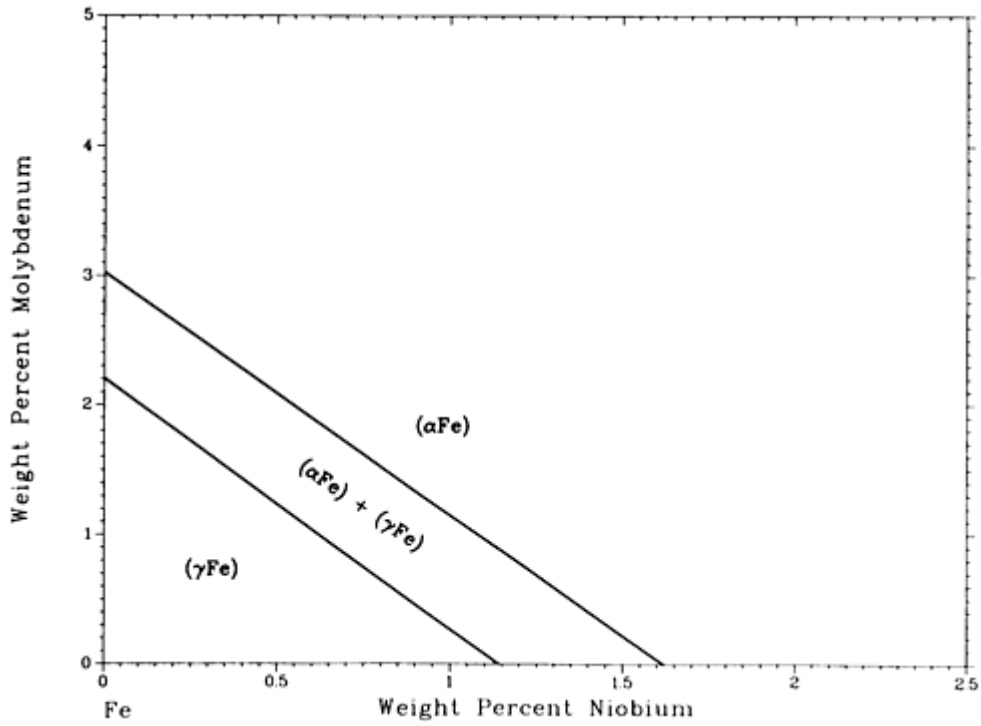

Fe-Mo-Nb isothermal section at 1250 °C [89Har 63].

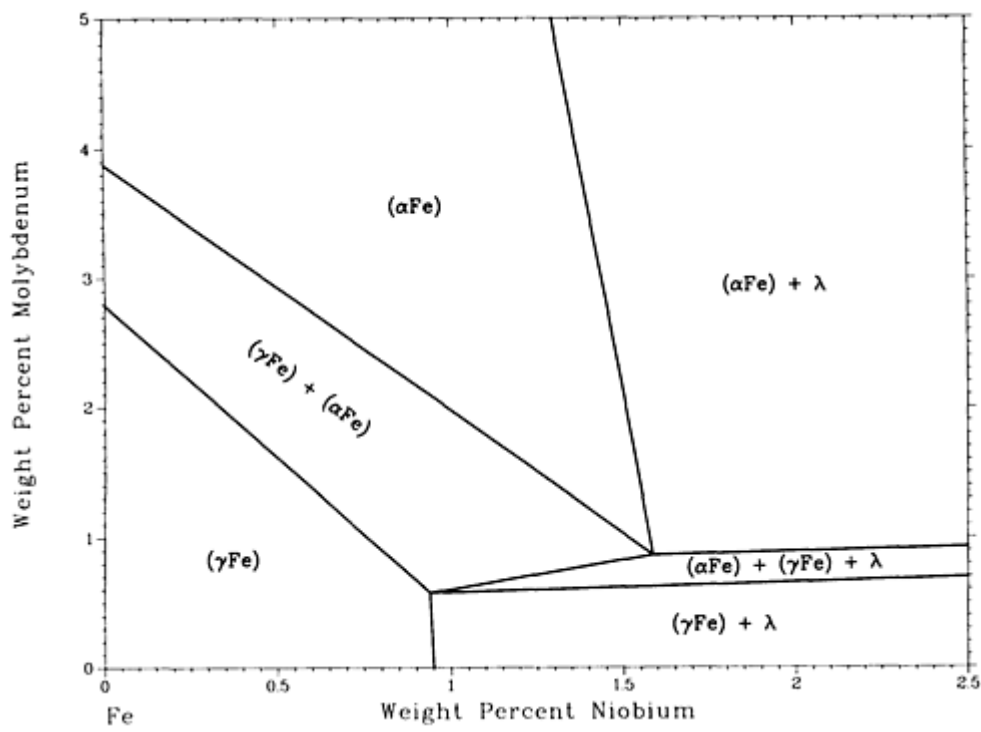

Fe-Mo-Nb isothermal section at 1150 °C [89Har 63].

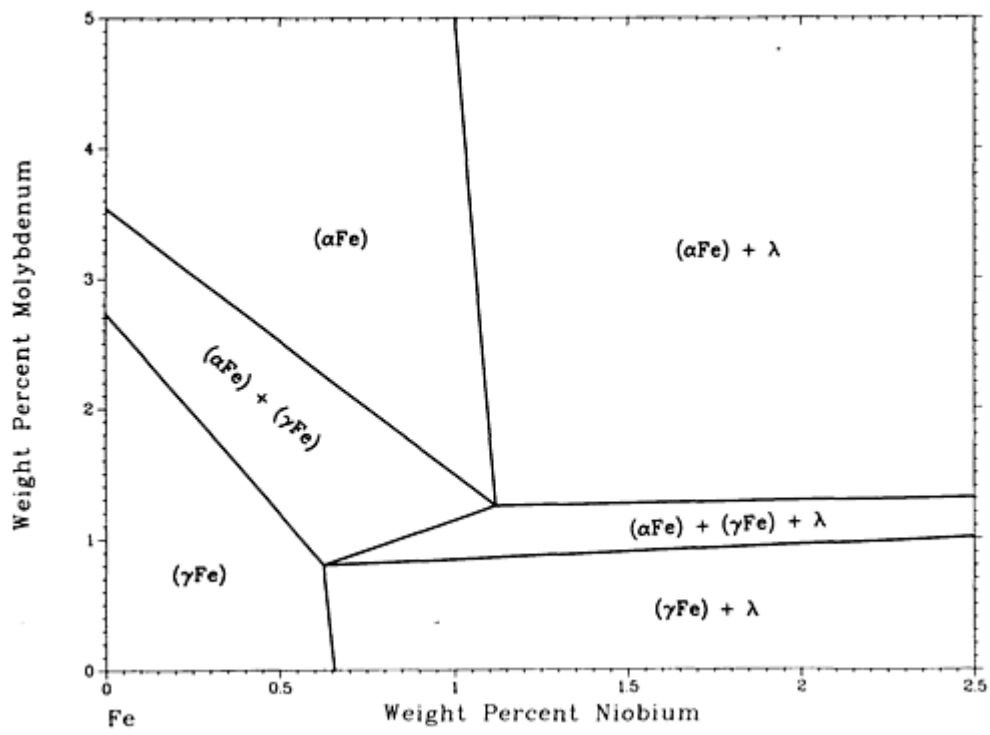

Fe-Mo-Nb isothermal section at 1050 °C [89Har 63].

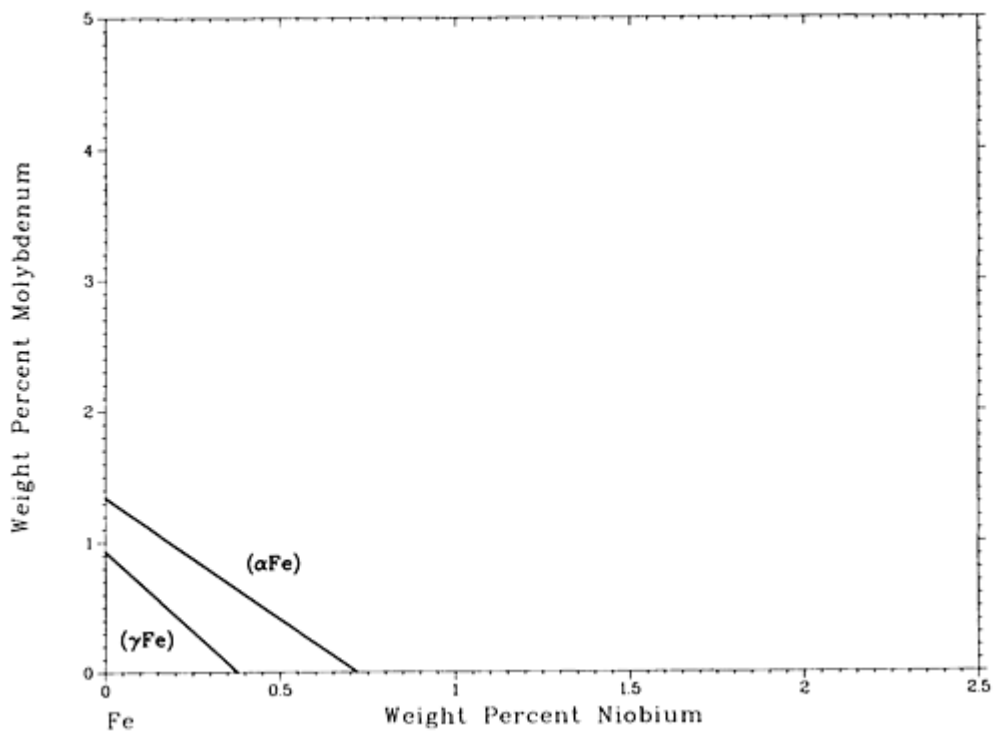

Fe-Mo-Nb isothermal section at 950 °C [89Har 63].

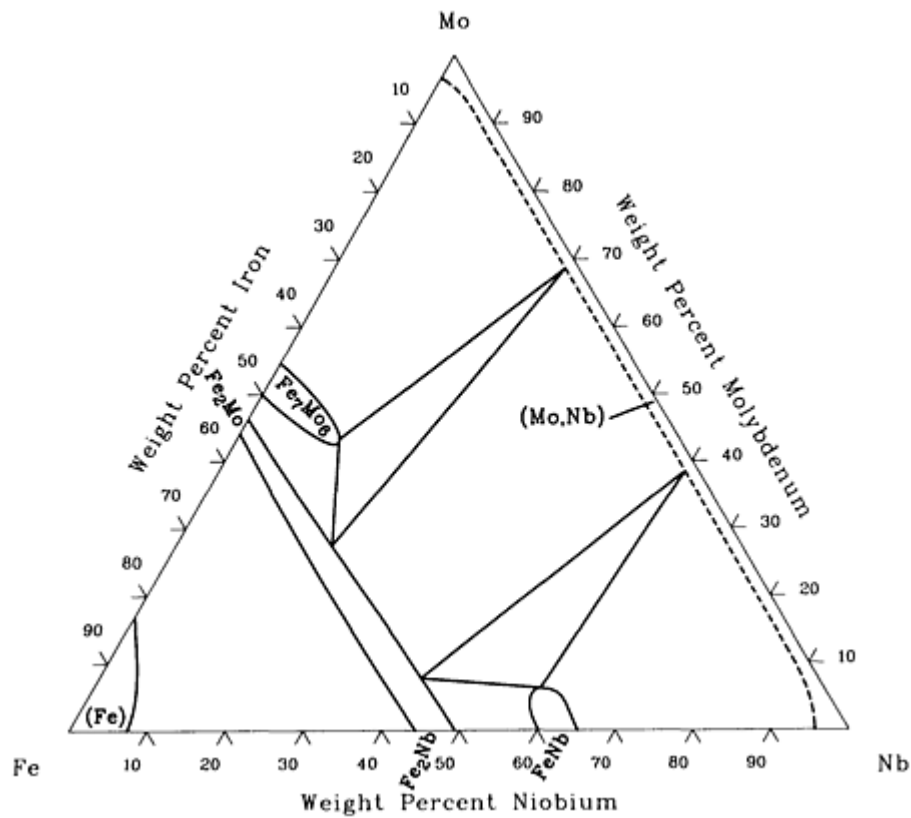

Fe-Mo-Nb isothermal section at 900 °C [87Smi 58].

References cited in this section

87Smi: S.V. Smirnova, L.L. Meshkov, and O.N. Kosolapova, "Physicochemical Interaction and Magnetic Properties on the Phases in the Iron-Molybdenum-Niobium System," *Moscow Univ. Chem. Bull.*, Tr: *Vest. Mosk. Univ. Khim.*, Vol 42 (No. 1), 1987, p 84-87

89Har: K.C. Harikumar and V. Raghavan, "BCC-FCC Equilibrium in Ternary Iron Alloys II," *J. Alloy Phase Diagrams*, India, Vol 5 (No. 2), 1989, p 77-96

Fe-Mo-Ni (Iron - Molybdenum - Nickel) Ternary Phase Diagrams

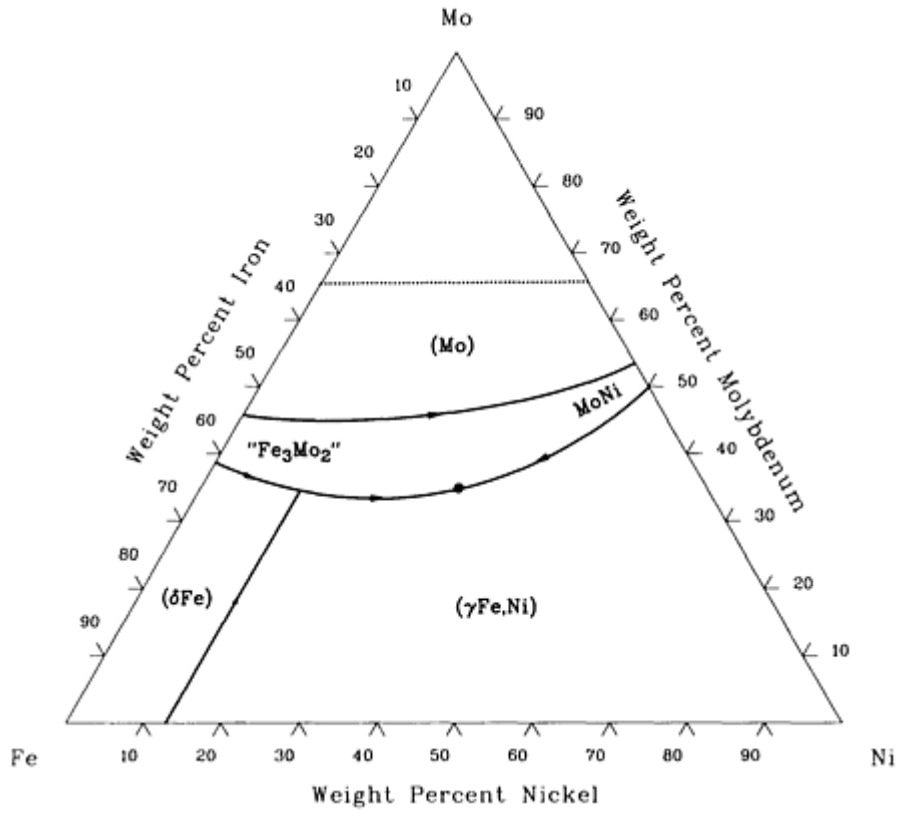

Fe-Mo-Ni liquidus projection [36Kos 3].

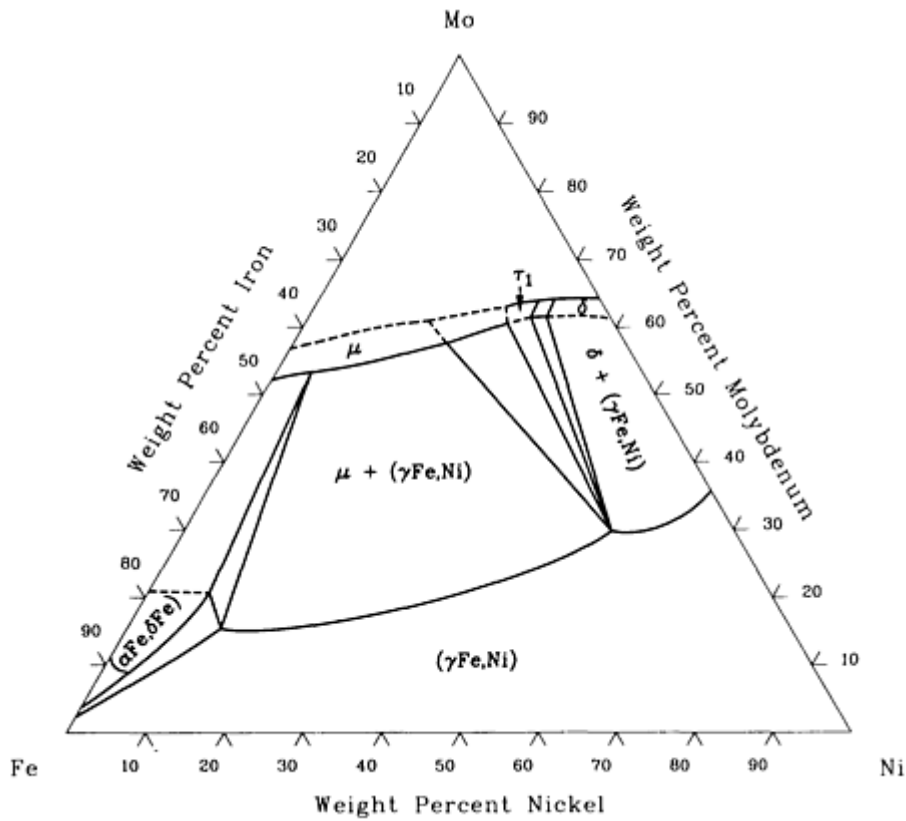

Fe-Mo-Ni isothermal section at 1200 °C [52Das 7].

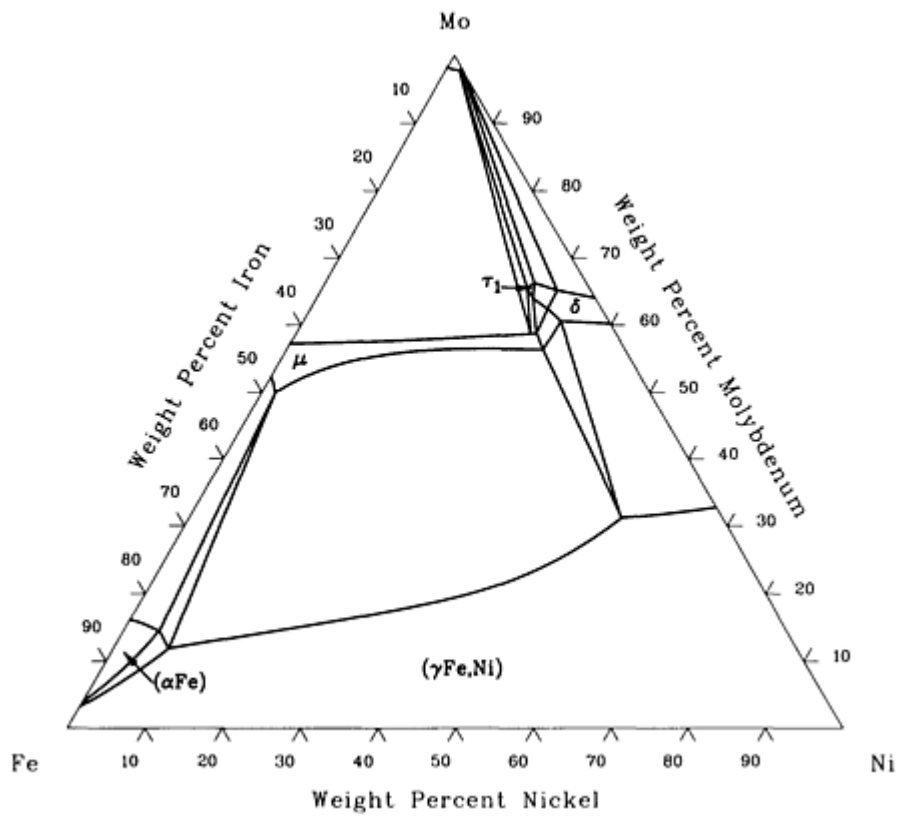

Fe-Mo-Ni isothermal section at 1100 °C [88Ray 60].

References cited in this section

- 36Kos:** W. Köster and W. Dullenkopf, "Das Dreistoffsystem Aluminium-Magnesium-Zink. III. Der Teilbereich $Mg-Al_3Mg_4-Al_2Mg_3Zn_3-MgZn_2-Mg$," *Z. Metallkd.*, Vol 28, 1936, p 363-367
- 52Das:** D.K. Das, S.P. Rideout, and P.A. Beck, "Intermediate Phases in the Mo-Fe-Co, Mo-Fe-Ni, and Mo-Ni-Co Ternary Systems," *Trans. AIME*, Vol 194, 1952, p 1071-1075
- 88Ray:** G.V. Raynor and V.G. Rivlin, *Phase Equilibria in Iron Ternary Alloys*, The Institute of Metals, London, (No. 4), 1988

Fe-Ni-W (Iron - Nickel - Tungsten) Ternary Phase Diagrams

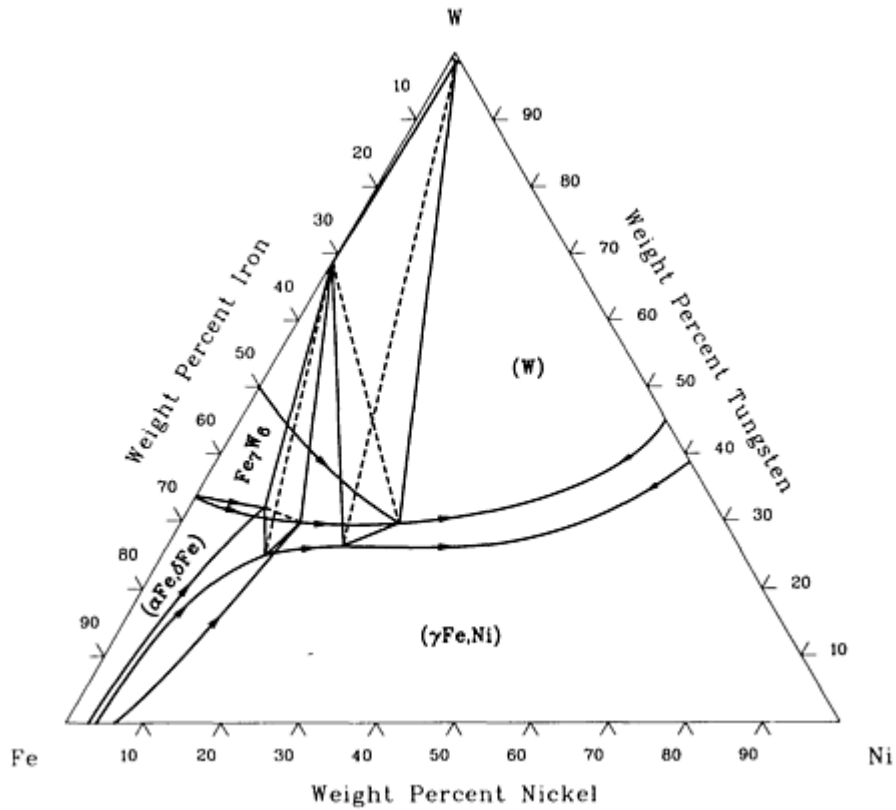

Fe-Ni-W liquidus and solidus projections [88Ray 60].

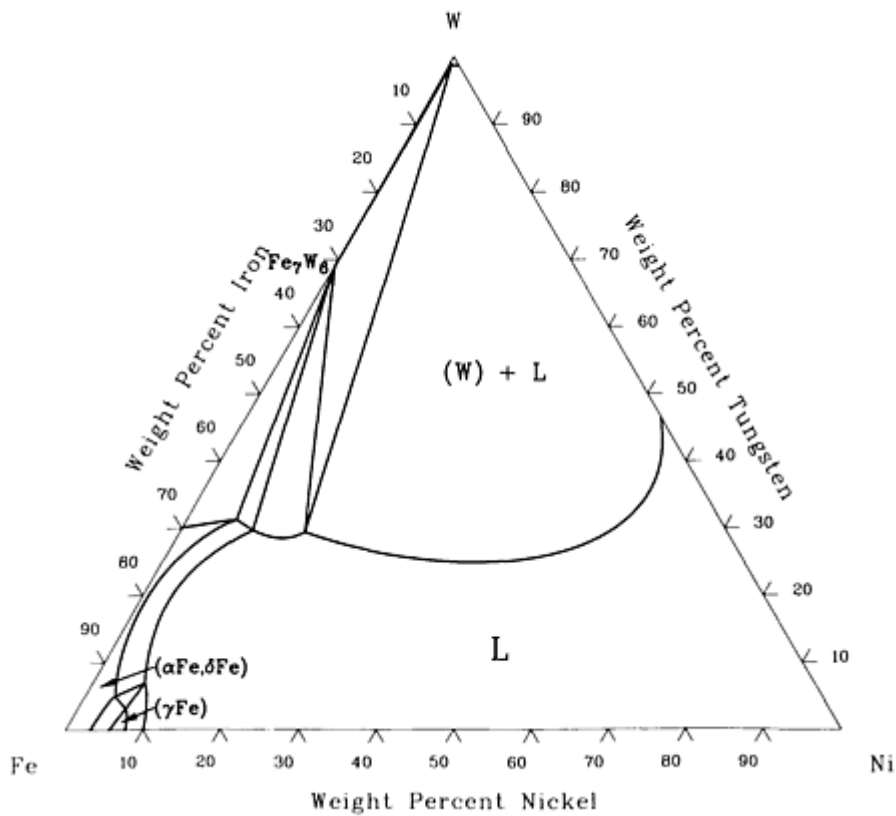

Fe-Ni-W isothermal section at 1500 °C [88Ray 60].

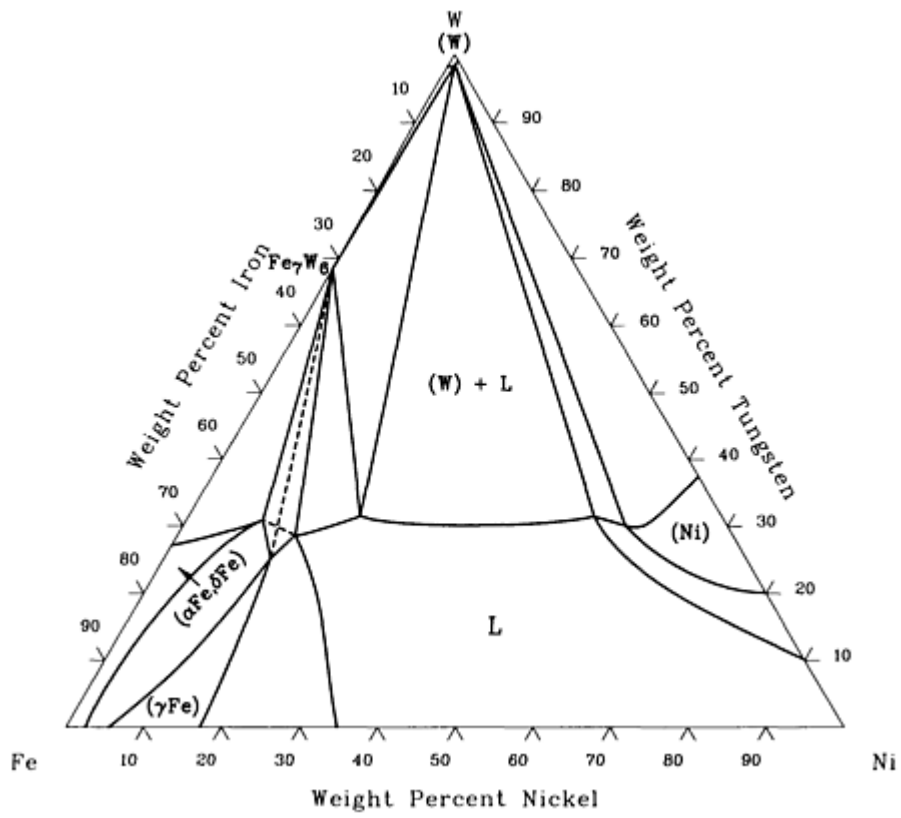

Fe-Ni-W isothermal section at 1465 °C [88Ray 60].

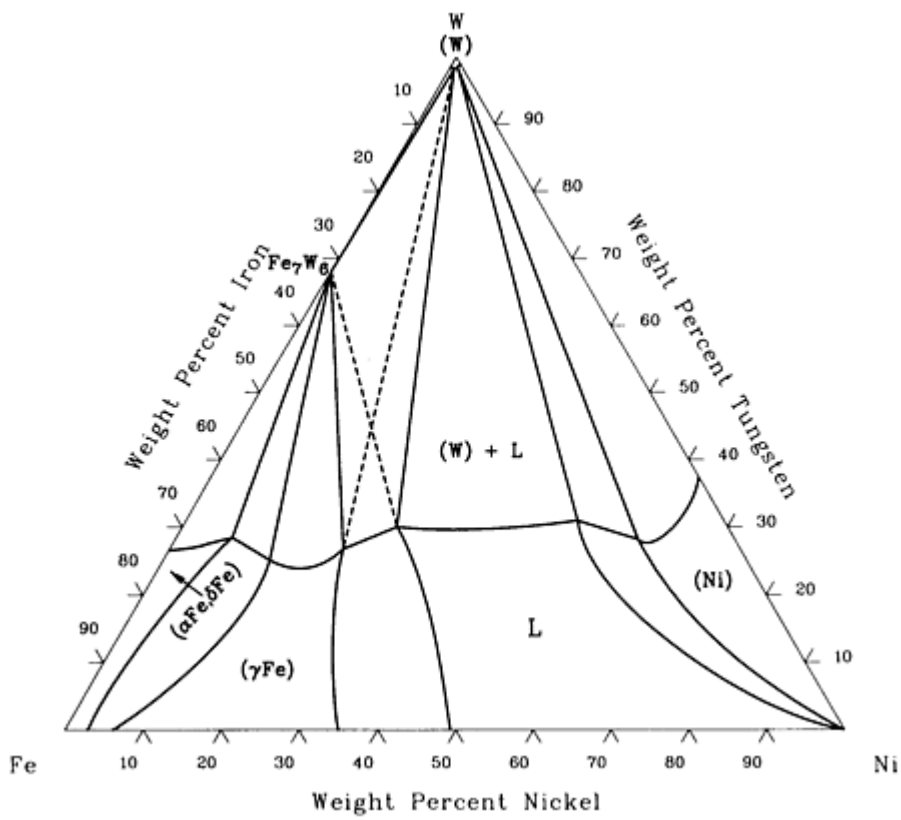

Fe-Ni-W isothermal section at 1455 °C [88Ray 60].

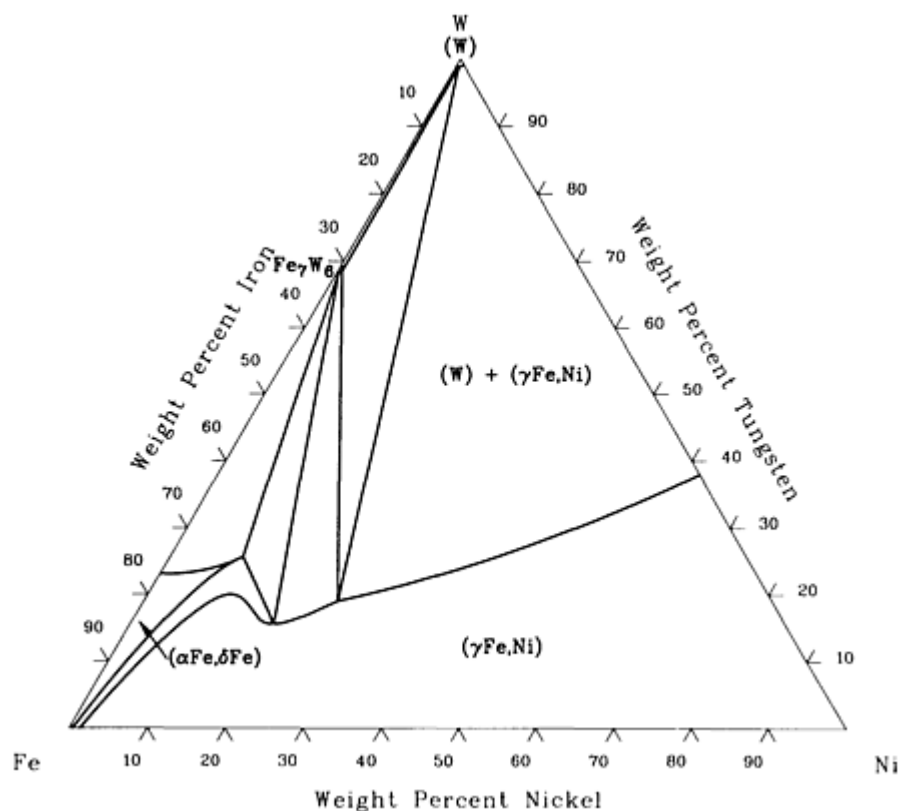

Fe-Ni-W isothermal section at 1400 °C [88Ray 60].

Reference cited in this section

88Ray: G.V. Raynor and V.G. Rivlin, *Phase Equilibria in Iron Ternary Alloys*, The Institute of Metals, London, (No. 4), 1988

Mg (Magnesium) Ternary Alloy Phase Diagrams

Introduction

Ternary systems that include magnesium are provided in the following locations in this Volume:

- “Al-Mg-Mn (Aluminum - Magnesium - Manganese)”, “Al-Mg-Si (Aluminum - Magnesium - Silicon)” and “Al-Mg-Zn (Aluminum - Magnesium - Zinc)” in the article “Al (Aluminum) Ternary Phase Diagrams.”

Mn (Manganese) Ternary Alloy Phase Diagrams

Introduction

Ternary systems that include manganese are provided in the following locations in this Volume:

- “Al-Cr-Mn (Aluminum - Chromium - Manganese)”, “Al-Cu-Mn (Aluminum - Copper - Manganese)”, “Al-Fe-Mn (Aluminum - Iron - Manganese)”, “Al-Mg-Mn (Aluminum - Magnesium - Manganese)”, and “Al-Mn-Si (Aluminum - Manganese - Silicon)” in the article “Al (Aluminum) Ternary Phase Diagrams.”
- “C-Fe-Mn (Carbon - Iron - Manganese)” in the article “C (Carbon) Ternary Phase Diagrams.”
- “Fe-Mn-Ni (Iron - Manganese - Nickel)” in the article “Fe (Iron) Ternary Phase Diagrams.”

Introduction

THIS ARTICLE includes systems where molybdenum is the first-named element in the ternary system. Additional ternary systems that include molybdenum are provided in the following locations in this Volume:

- “Al-Mo-Ni (Aluminum - Molybdenum - Nickel)” and “Al-Mo-Ti (Aluminum - Molybdenum - Titanium)” in the article “Al (Aluminum) Ternary Phase Diagrams.”
- “C-Cr-Mo (Carbon - Chromium - Molybdenum)” and “C-Fe-Mo (Carbon - Iron - Molybdenum)” in the article “C (Carbon) Ternary Phase Diagrams.”
- “Co-Fe-Mo (Cobalt - Iron - Molybdenum)” and “Co-Mo-Ni (Cobalt - Molybdenum - Nickel)” in the article “Co (Cobalt) Ternary Phase Diagrams.”
- “Cr-Fe-Mo (Chromium - Iron - Molybdenum)”, “Cr-Mo-Ni (Chromium - Molybdenum - Nickel)”, “Cr-Mo-W (Chromium - Molybdenum - Tungsten)”, “Fe-Mo-Nb (Iron - Molybdenum - Niobium)” “Fe-Mo-Ni (Iron - Molybdenum - Nickel)” in the article “Fe (Iron) Ternary Phase Diagrams.”

Introduction

THIS ARTICLE includes systems where molybdenum is the first-named element in the ternary system. Additional ternary systems that include molybdenum are provided in the following locations in this Volume:

- “Al-Mo-Ni (Aluminum - Molybdenum - Nickel)” and “Al-Mo-Ti (Aluminum - Molybdenum - Titanium)” in the article “Al (Aluminum) Ternary Phase Diagrams.”
- “C-Cr-Mo (Carbon - Chromium - Molybdenum)” and “C-Fe-Mo (Carbon - Iron - Molybdenum)” in the article “C (Carbon) Ternary Phase Diagrams.”
- “Co-Fe-Mo (Cobalt - Iron - Molybdenum)” and “Co-Mo-Ni (Cobalt - Molybdenum - Nickel)” in the article “Co (Cobalt) Ternary Phase Diagrams.”
- “Cr-Fe-Mo (Chromium - Iron - Molybdenum)”, “Cr-Mo-Ni (Chromium - Molybdenum - Nickel)”, “Cr-Mo-W (Chromium - Molybdenum - Tungsten)”, “Fe-Mo-Nb (Iron - Molybdenum - Niobium)” “Fe-Mo-Ni (Iron - Molybdenum - Nickel)” in the article “Fe (Iron) Ternary Phase Diagrams.”

Mo-Nb-Ti (Molybdenum - Niobium - Titanium) Ternary Phase Diagrams

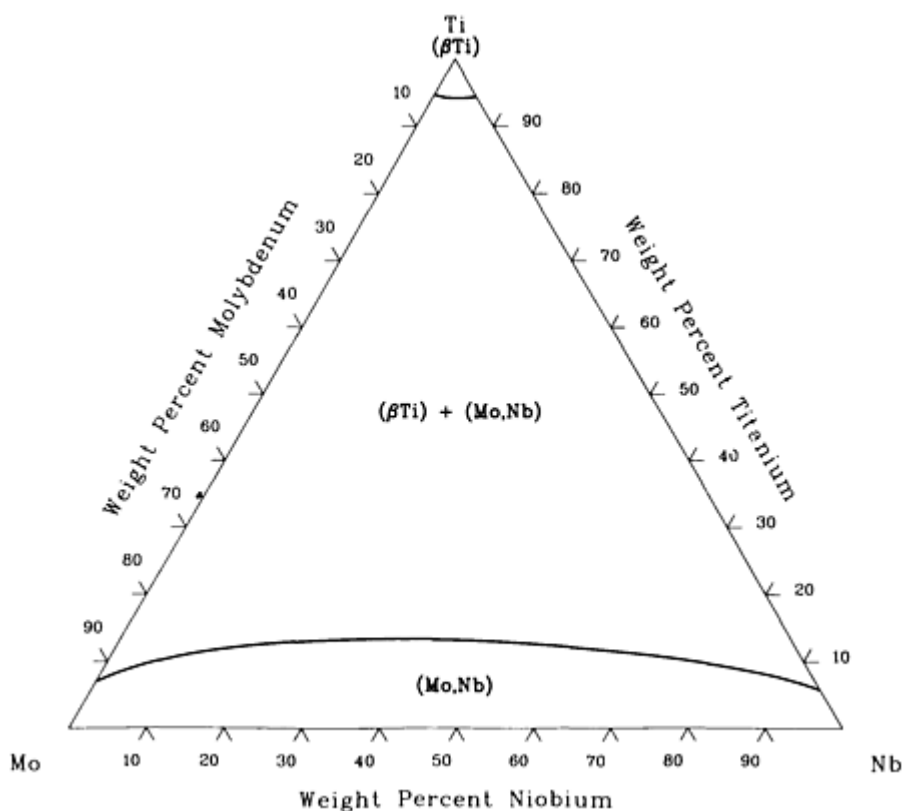

Mo-Nb-Ti isothermal section at 1100 °C [58Kor 10].

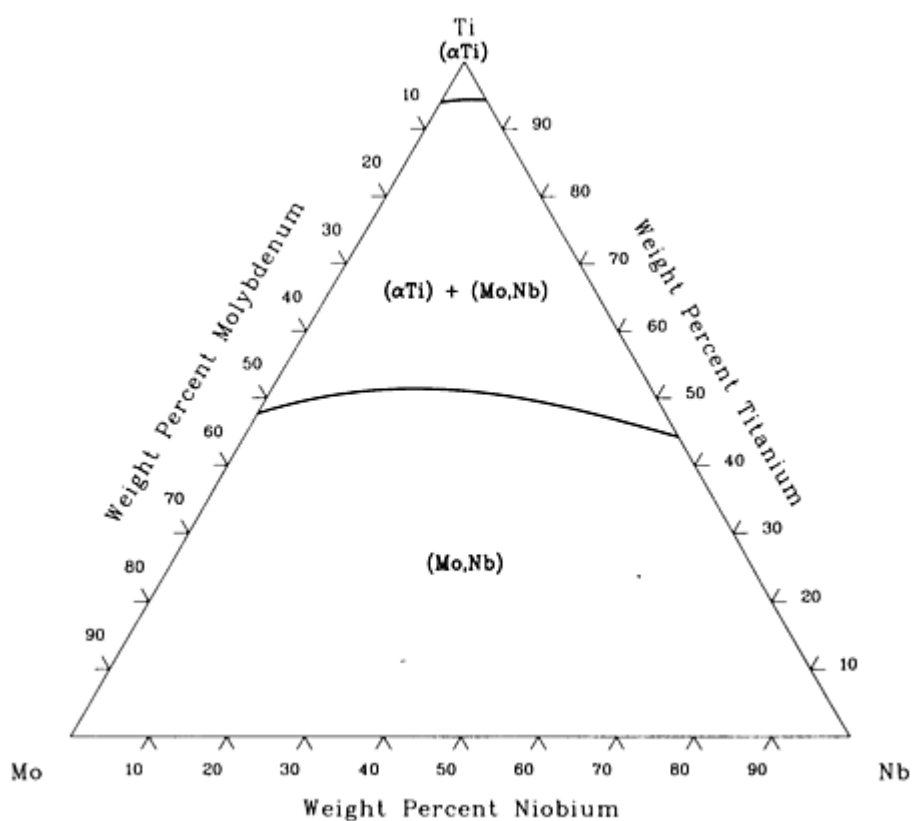

Mo-Nb-Ti isothermal section at 600 °C [58Kor 10].

Reference cited in this section

58Kor: I.I. Kornilov and R.S. Polyakov, Phase Diagram of the Ternary System Titanium-Niobium-Molybdenum, *Russ. J. Inorganic Chem., Tr. Zh. Neorg. Khim.*, Vol 3 (No. 4), 1958, p 62-74

Mo-Ni-Ti (Molybdenum - Nickel - Titanium) Ternary Phase Diagrams

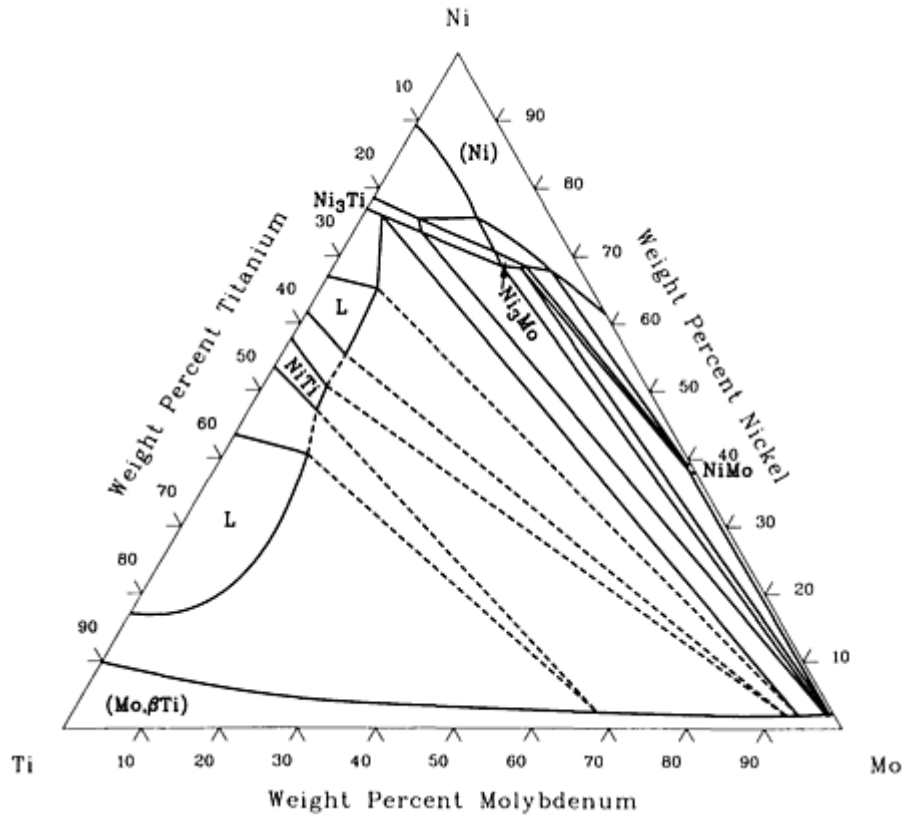

Mo-Ni-Ti isothermal section at 1200 °C [86Pri 53].

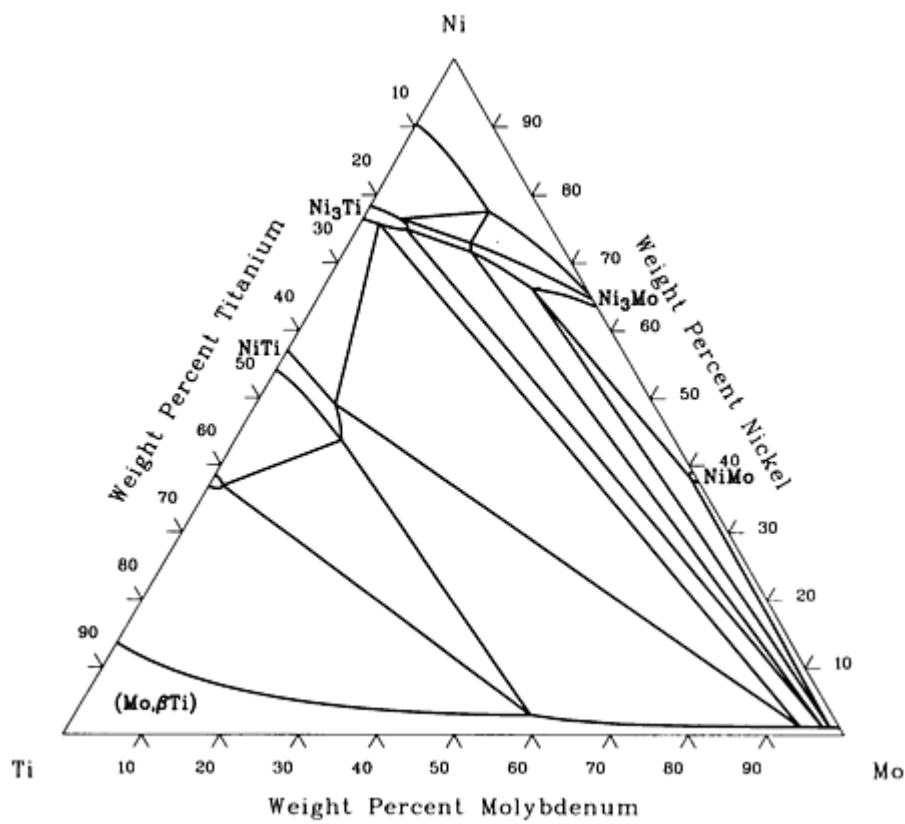

Mo-Ni-Ti isothermal section at 900 °C [84Ere 44].

References cited in this section

84Ere: V.N. Eremenko, L.A. Tret'yachenko, S.B. Prima, and E.L. Semenova, "Constitution Diagrams of Titanium-Nickel-Groups IV-VIII Transition Metal Systems," *Sov. Powder Metall. Met. Ceram.*; TR: *Poroshk. Metall. Kiev*, Vol 23 (No. 8), 1984, p 613-621

86Pri: S.B. Prima, L.A. Tret'yachenko, and V.N. Eremenko, "Investigation of Phase Equilibria in the Ti-Ni-Mo System at 1200 °C," *Russ. Metall.*; TR: *Izv. Akad. Nauk SSSR, Met.*, (No. 2), 1986, p 205-210

Mo-Ni-W (Molybdenum - Nickel - Tungsten) Ternary Phase Diagrams

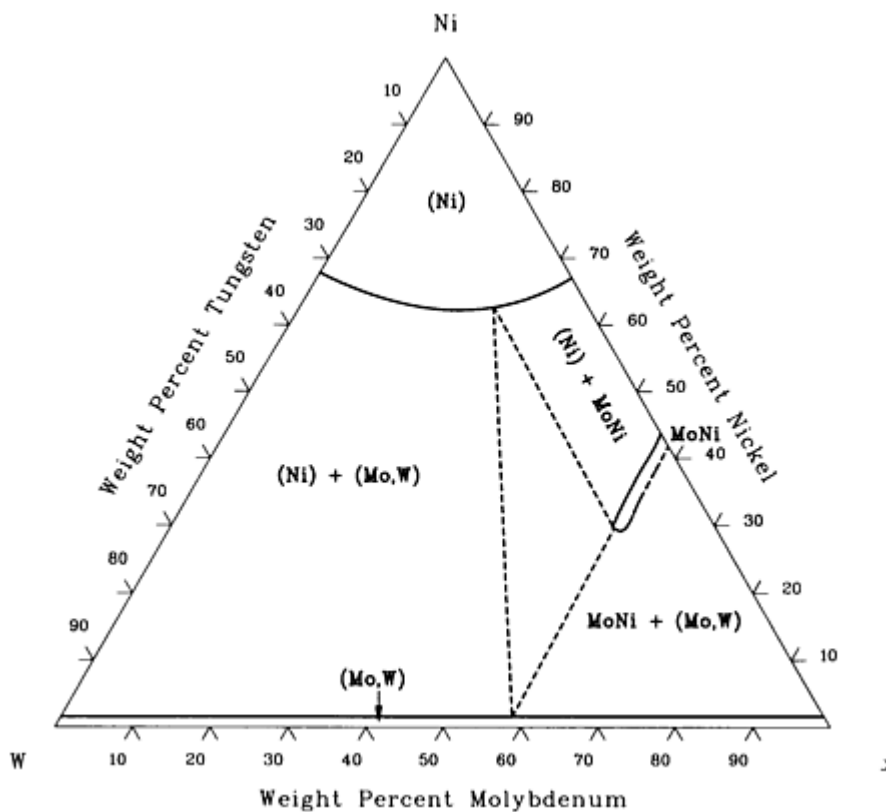

Mo-Ni-W isothermal section at 1000 °C [80Mas 41].

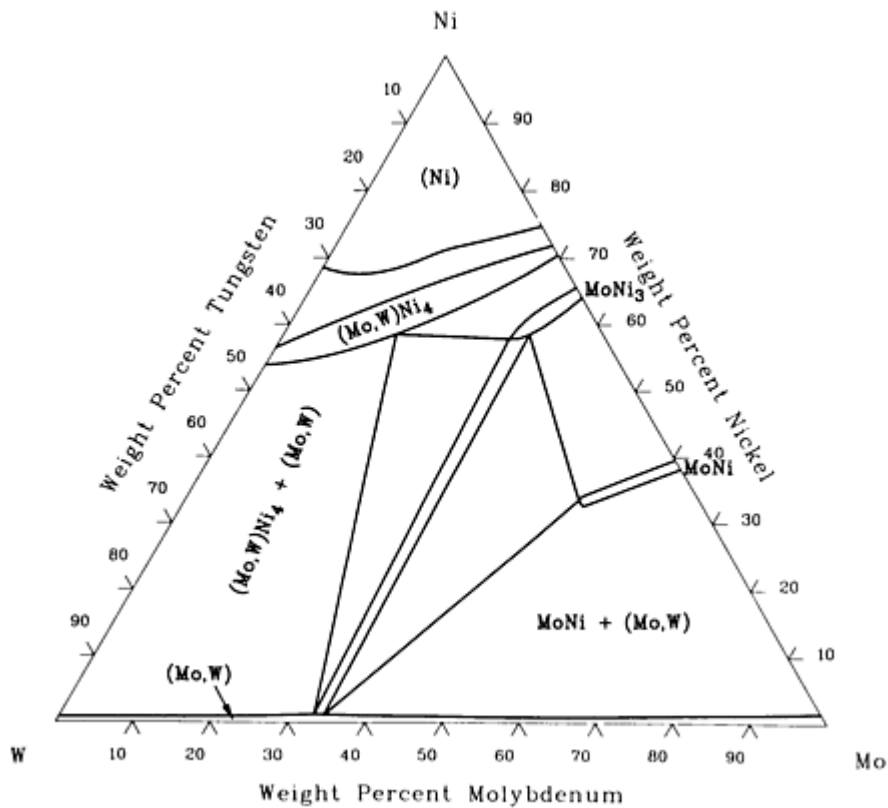

Mo-Ni-W isothermal section at 700 °C [85Mes 47].

References cited in this section

- 80Mas:** S.B. Maslenkov and E.A. Nikandrova, "Examination of the Ni-Mo-W Phase Diagram," *Russ. Metall.*, Tr: *Izv. Akad. Nauk SSSR, Met.*, (No. 2), 1980, p 184-187
- 85Mes:** L.L. Meshkov, S.N. Nesterenko, and T.V. Ishchenko, "Structural Features of Phase Diagrams Formed by Molybdenum and Tungsten with Iron-Group Metals," *Russ. Metall.*; TR: *Izv. Akad Nauk SSSR, Met.*, (No. 2), 1985, p 204-207

Mo-Ti-W (Molybdenum - Titanium - Tungsten) Ternary Phase Diagrams

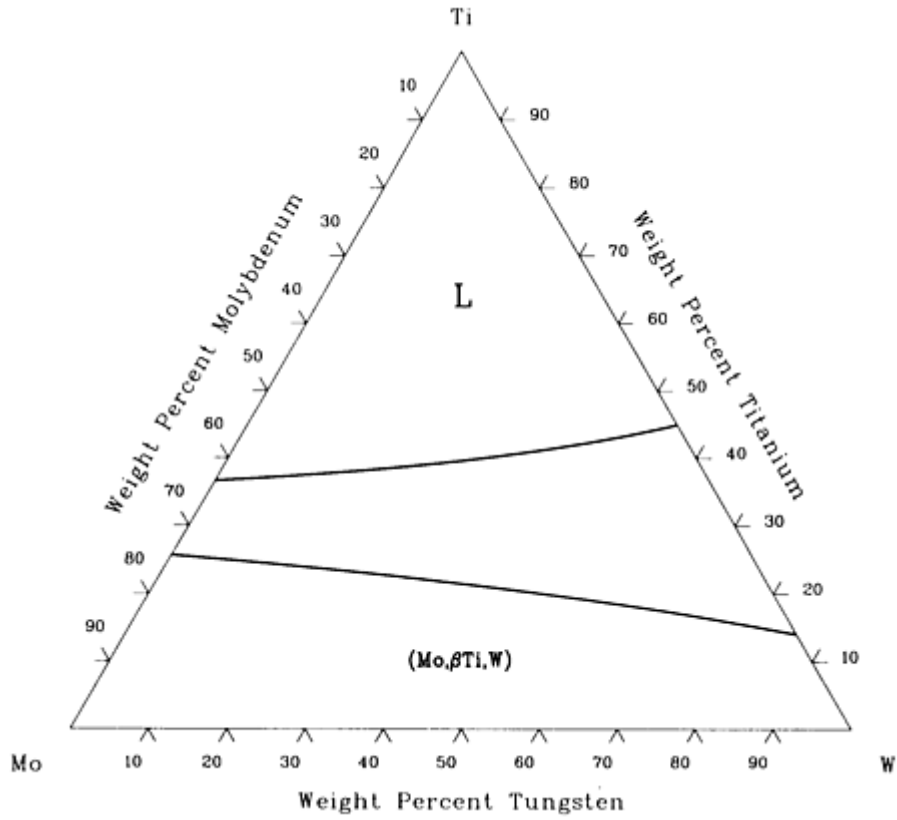

Mo-Ti-W isothermal section at 2227 °C [75Kau 36].

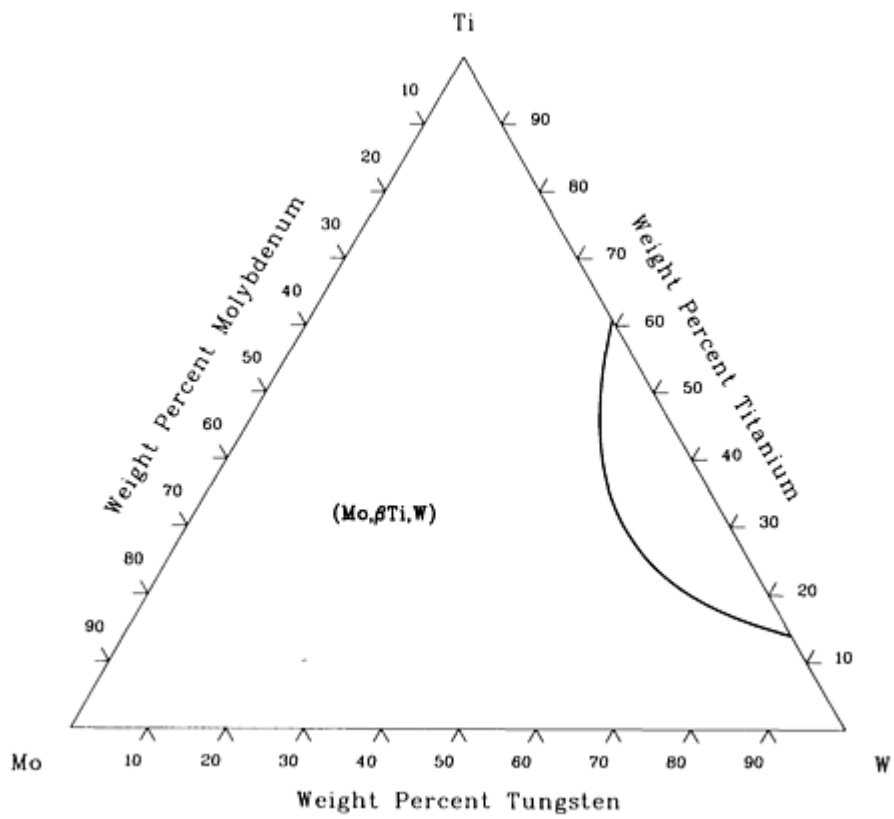

Mo-Ti-W isothermal section at 1000 °C [75Kau 36].

Reference cited in this section

75Kau: L. Kaufman and H. Nesor, "Calculation of Superalloy Phase Diagrams: Part IV," *Metall. Trans. A*, Vol 6, 1975, p 2123-2131

N (Nitrogen) Ternary Alloy Phase Diagrams

Introduction

Ternary systems that include nitrogen are provided in the following locations in this Volume:

- "C-Cr-N (Carbon - Chromium - Nitrogen)" and "C-Fe-N (Carbon - Iron - Nitrogen)" in the article "C (Carbon) Ternary Phase Diagrams."
- "Cr-Fe-N (Chromium - Iron - Nitrogen)" in the article "Cr (Chromium) Ternary Phase Diagrams."

Nb (Niobium) Ternary Alloy Phase Diagrams

Introduction

THIS ARTICLE includes systems where niobium is the first-named element in the ternary system. Additional ternary systems that include niobium are provided in the following locations in this Volume:

- "Cr-Nb-Ni (Chromium - Niobium - Nickel)" and "Cr-Nb-W (Chromium - Niobium - Tungsten)" in the article "Cr (Chromium) Ternary Phase Diagrams."
- "Fe-Mo-Nb (Iron - Molybdenum - Niobium)" and "Mo-Nb-Ti (Molybdenum - Niobium - Titanium)" in the article "Mo (Molybdenum) Ternary Phase Diagrams."

Nb-Ti-W (Niobium - Titanium - Tungsten) Ternary Phase Diagrams

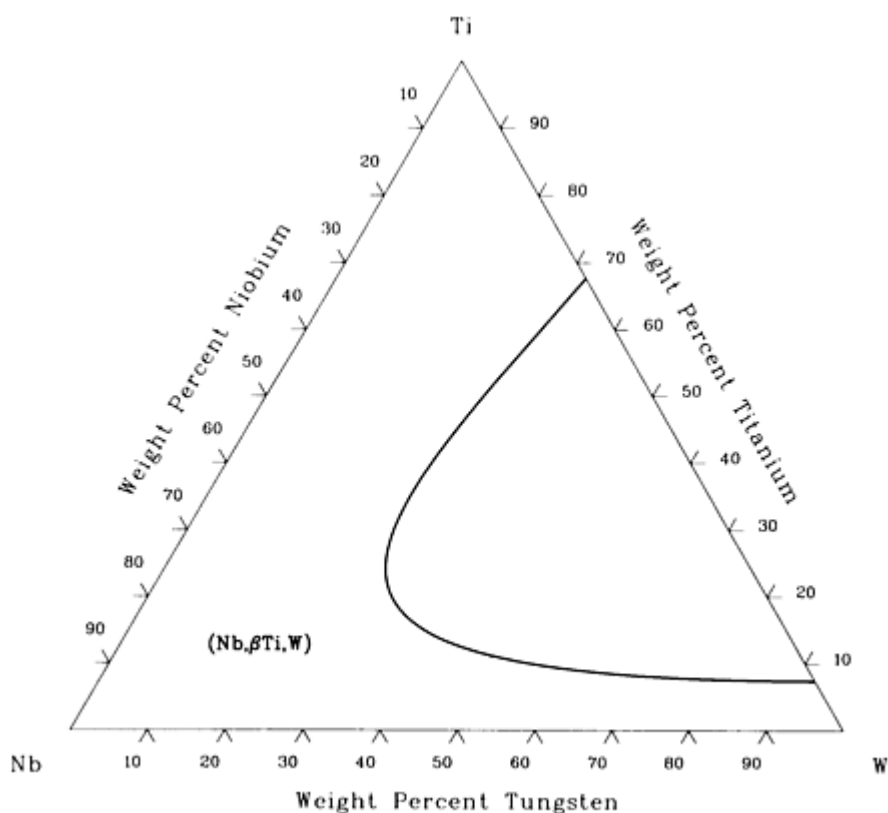

Nb-Ti-W isothermal section at 1000 °C [75Kau 36].

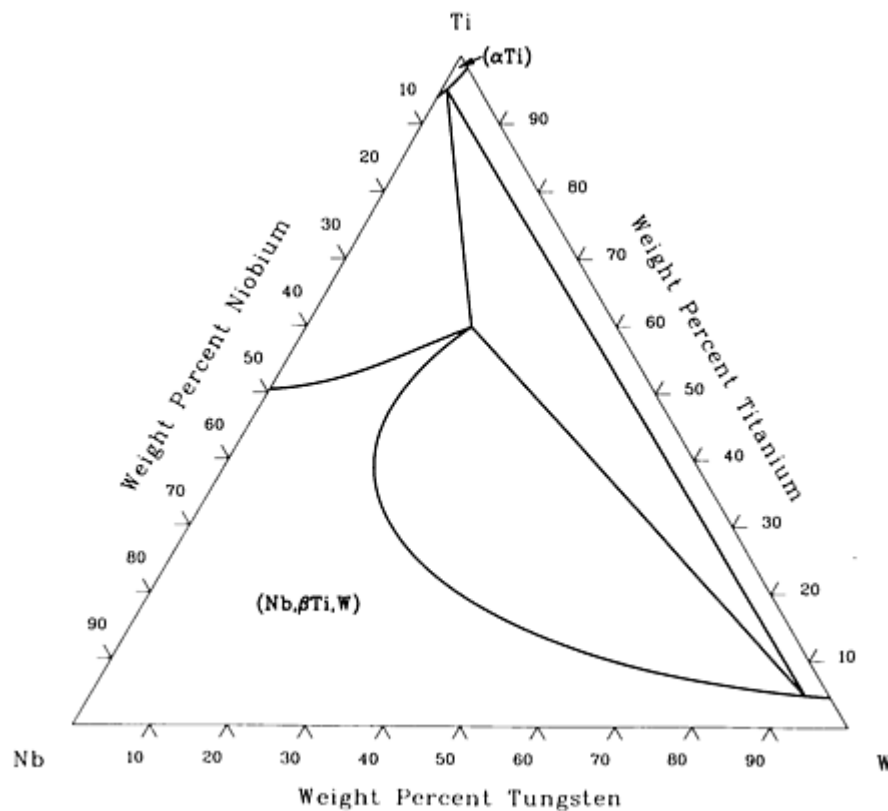

Nb-Ti-W isothermal section at 600 °C [77Lev 37].

References cited in this section

75Kau: L. Kaufman and H. Nesor, "Calculation of Superalloy Phase Diagrams: Part IV," *Metall. Trans. A*, Vol 6, 1975, p 2123-2131

77Lev: V.I. Levanov, V.S. Mikheyev, and A.I. Chernitysn, "Investigation of the Ti-Nb-W System (Nb + W up to 50 wt.%)," *Russ. Metall.*; TR: *Izv. Akad. Nauk SSSR, Met.*, (No. 1), 1977, p 186-191

Ni (Nickel) Ternary Alloy Phase Diagrams

Introduction

Ternary systems that include nickel are provided in the following locations in this Volume:

- "Al-Cr-Ni (Aluminum - Chromium - Nickel)", "Al-Cu-Ni (Aluminum - Copper - Nickel)", "Al-Fe-Ni (Aluminum - Iron - Nickel)", "Al-Mo-Ni (Aluminum - Molybdenum - Nickel)", "Al-Ni-Ti (Aluminum - Nickel - Titanium)" and "Au-Cu-Ni (Gold - Copper - Nickel)" in the article "Al (Aluminum) Ternary Phase Diagrams."
- "Au-Cu-Ni (Gold - Copper - Nickel)" in the article "Au (Gold) Ternary Phase Diagrams."
- "C-Fe-Ni (Carbon - Iron - Nickel)" in the article "C (Carbon) Ternary Phase Diagrams."
- "Co-Cr-Ni (Cobalt - Chromium - Nickel)", "Co-Fe-Ni (Cobalt - Iron - Nickel)", "Co-Mo-Ni (Cobalt - Molybdenum - Nickel)" and "Co-Ni-Ti (Cobalt - Nickel - Titanium)" in the article "Co (Cobalt) Ternary Phase Diagrams."
- "Cr-Fe-Ni (Chromium - Iron - Nickel)", "Cr-Mo-Ni (Chromium - Molybdenum - Nickel)", "Cr-Nb-Ni (Chromium - Niobium - Nickel)", "Cr-Ni-Ti (Chromium - Nickel - Titanium)", "Cr-Ni-W (Chromium - Nickel - Tungsten)" in the article "Cr (Chromium) Ternary Phase Diagrams."

- “Cu-Fe-Ni (Copper - Iron - Nickel)”, “Cu-Ni-Sn (Copper - Nickel - Tin)” and “Cu-Ni-Zn (Copper - Nickel - Zinc)” in the article “Cu (Copper) Ternary Phase Diagrams.”
- “Fe-Mn-Ni (Iron - Manganese - Nickel)”, “Fe-Mo-Ni (Iron - Molybdenum - Nickel)” and “Fe-Ni-W (Iron - Nickel - Tungsten)” in the article “Fe (Iron) Ternary Phase Diagrams.”
- “Mo-Ni-Ti (Molybdenum - Nickel - Titanium)” and “Mo-Ni-W (Molybdenum - Nickel - Tungsten)” in the article “Mo (Molybdenum) Ternary Phase Diagrams.”

Pb (Lead) Ternary Alloy Phase Diagrams

Introduction

THIS ARTICLE includes systems where lead is the first-named element in the ternary system. Additional ternary systems that include lead are provided in the following locations in this Volume:

- “Ag-Pb-Sn (Silver - Lead - Tin)” in the article “Ag (Silver) Ternary Phase Diagrams.”
- “Cu-Pb-Zn (Copper - Lead - Zinc)” in the article “Cu (Copper) Ternary Phase Diagrams.”

Pb-Sb-Sn (Lead - Antimony - Tin) Ternary Phase Diagrams

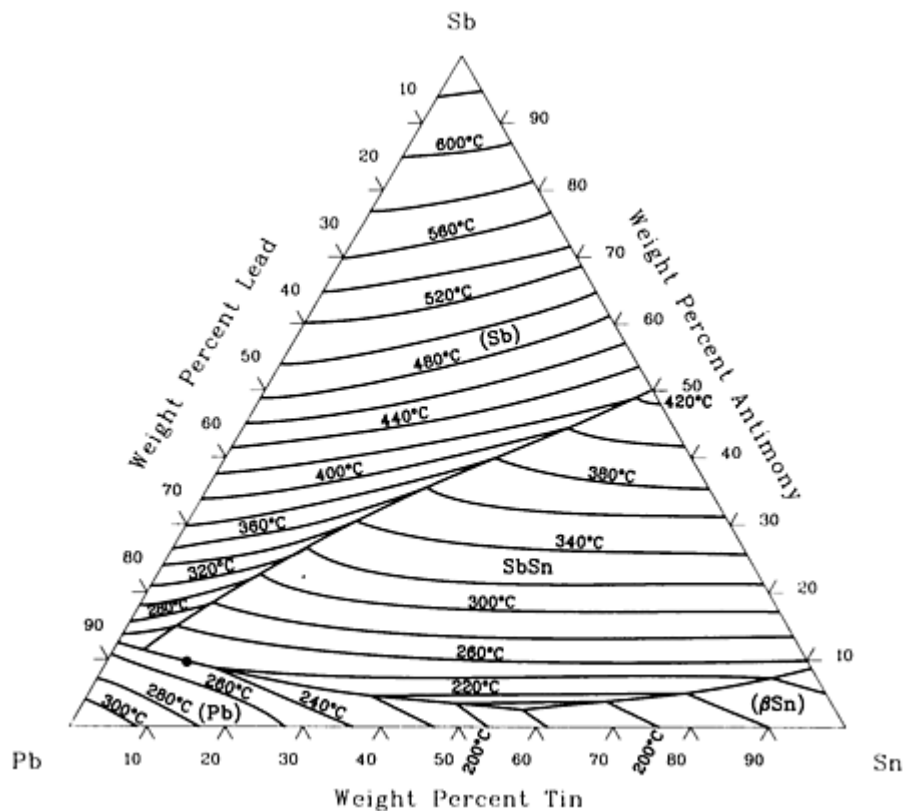

Pb-Sb-Sn liquidus projection [73Bre 28].

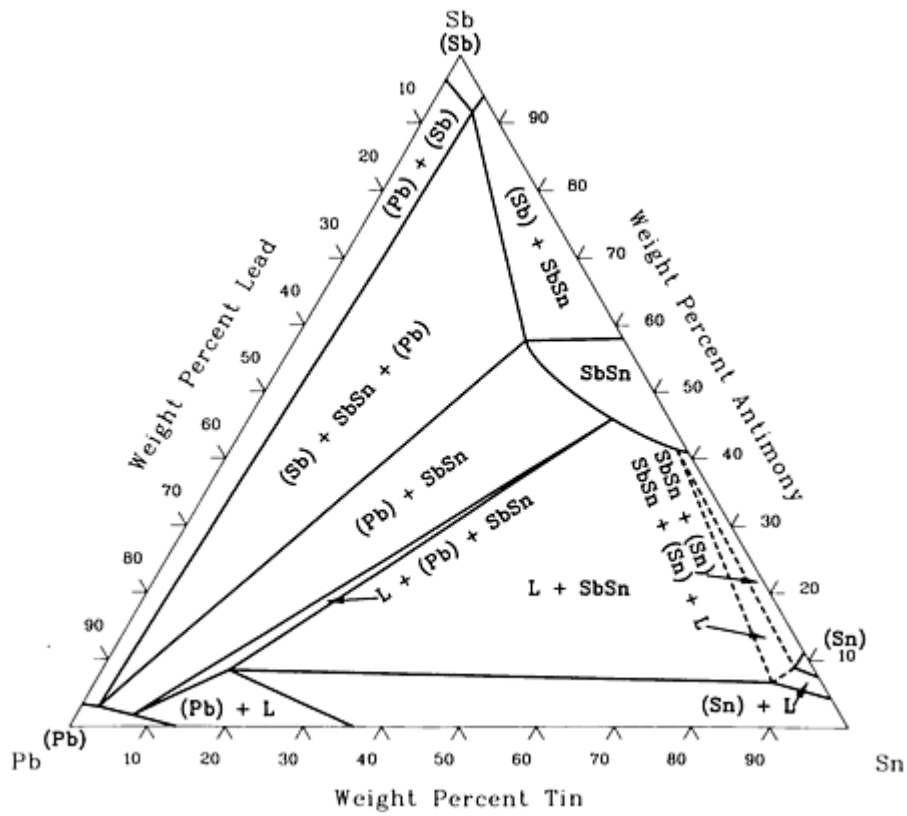

Pb-Sb-Sn isothermal section at 240 °C [85Osa 50].

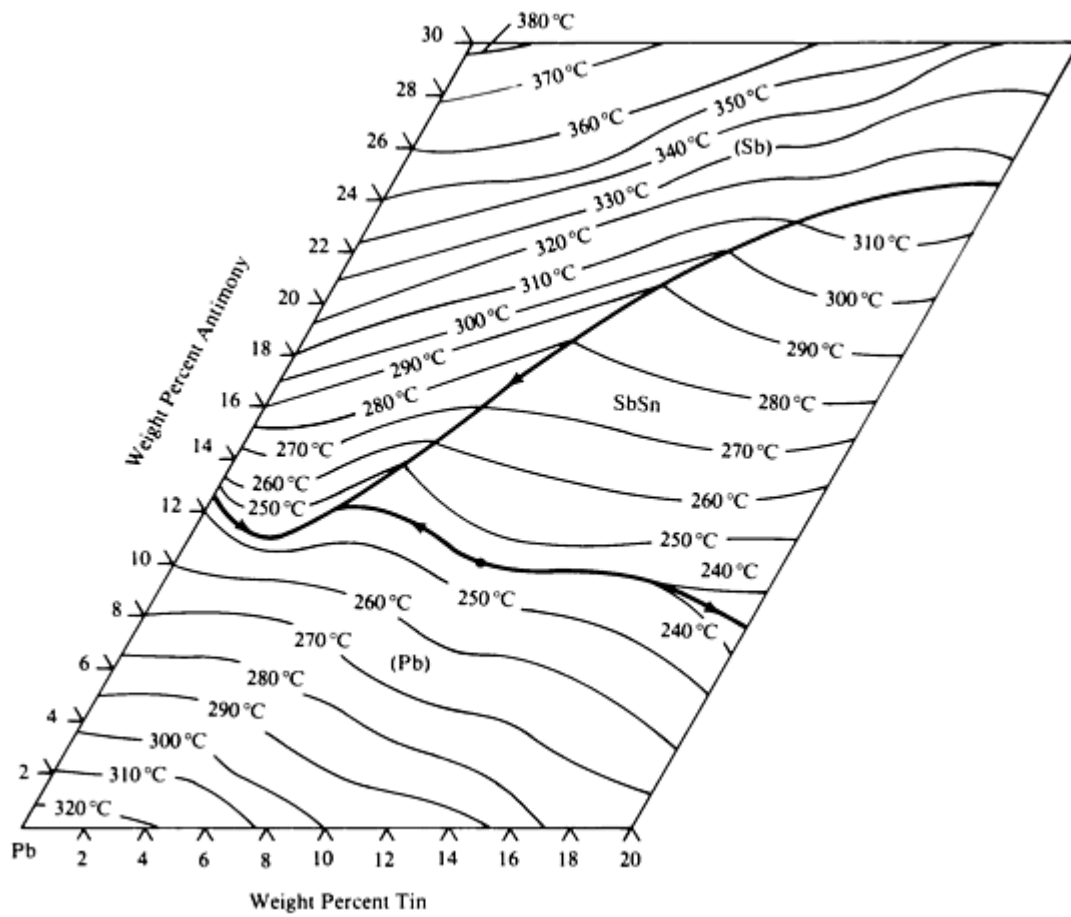

Pb-Sb-Sn (Pb) liquidus projection [73Bre 28].

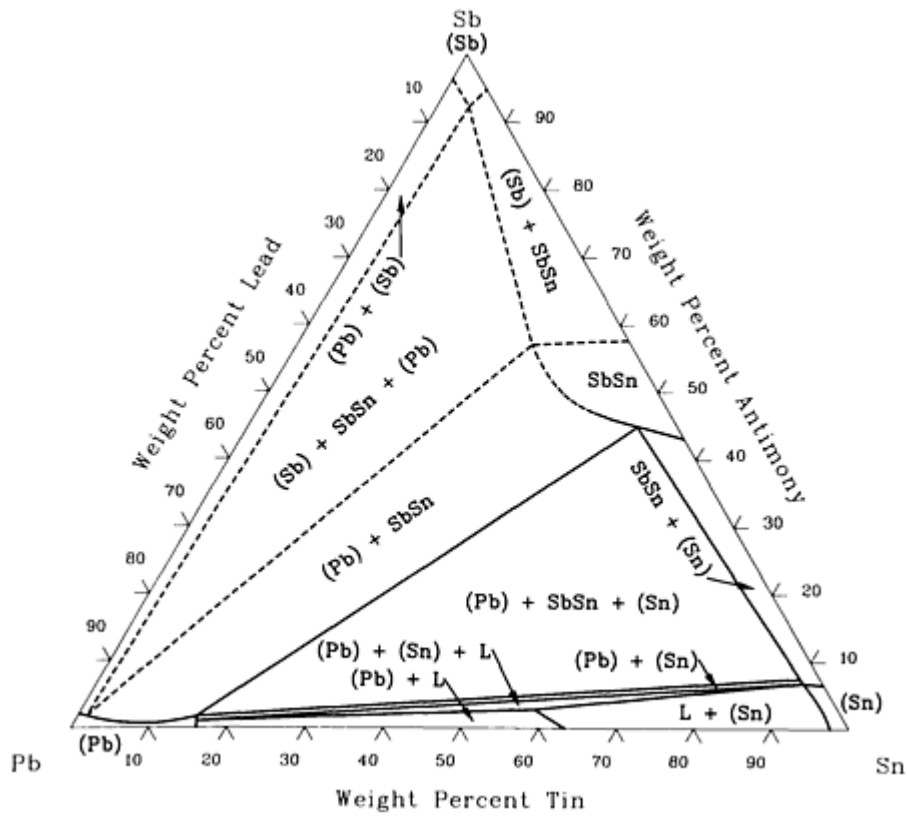

Pb-Sb-Sn isothermal section at 189 °C [85Osa 50].

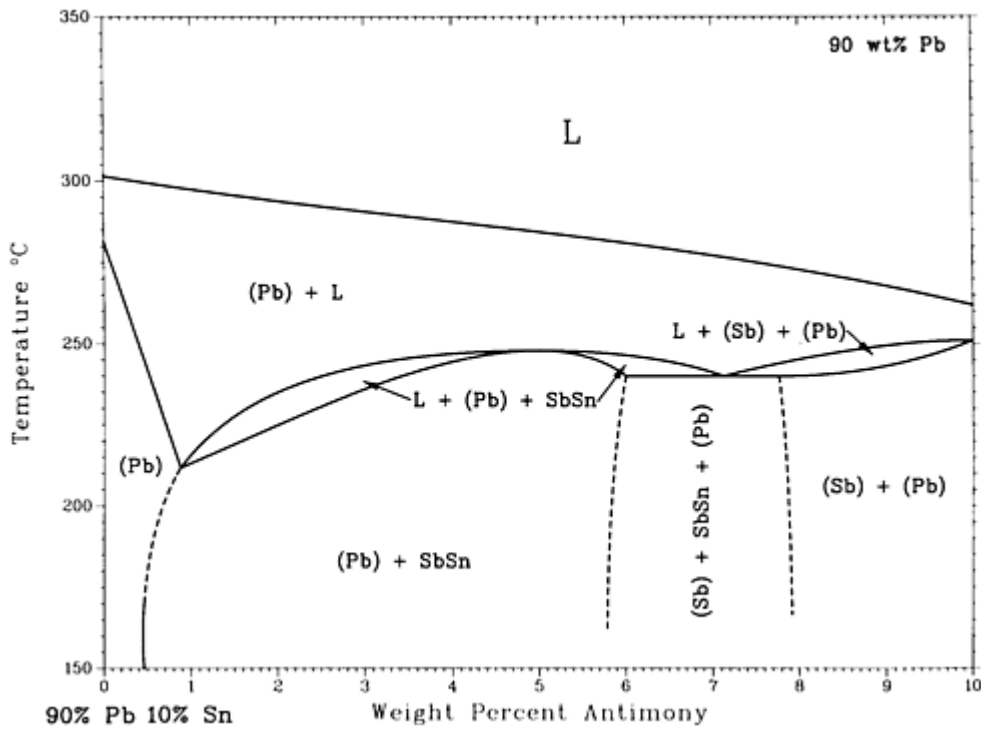

Pb-Sb-Sn [85Osa 50].

References cited in this section

73Bre: L. Brewer and S.-G. Chang, *Metallography, Structures and Phase Diagrams*, Vol 8, *Metals Handbook*, 8th ed., American Society for Metals, Metals Park, OH, 1973

85Osa: K. Osamura, "The Pb-Sb-Sn (Lead-Antimony-Tin) System," *Bull. Alloy Phase Diagrams*, Vol 6 (No. 4), 1985, p 372-379

Pb-Sn-Zn (Lead - Tin - Zinc) Ternary Phase Diagrams

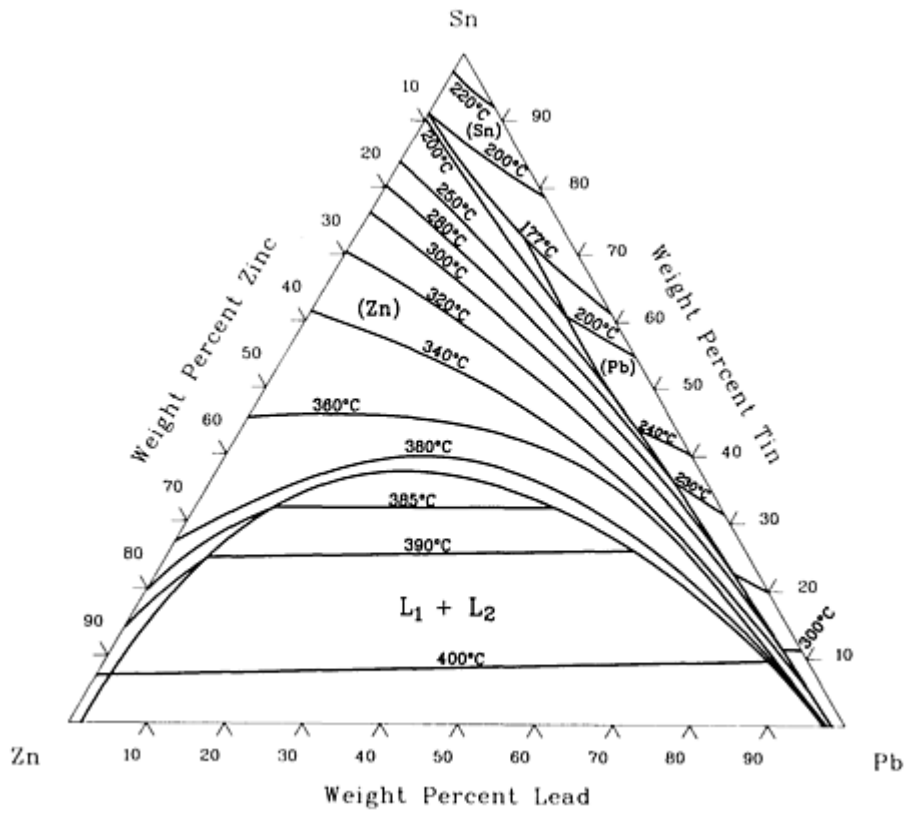

Pb-Sn-Zn liquidus projection [51Lin 6].

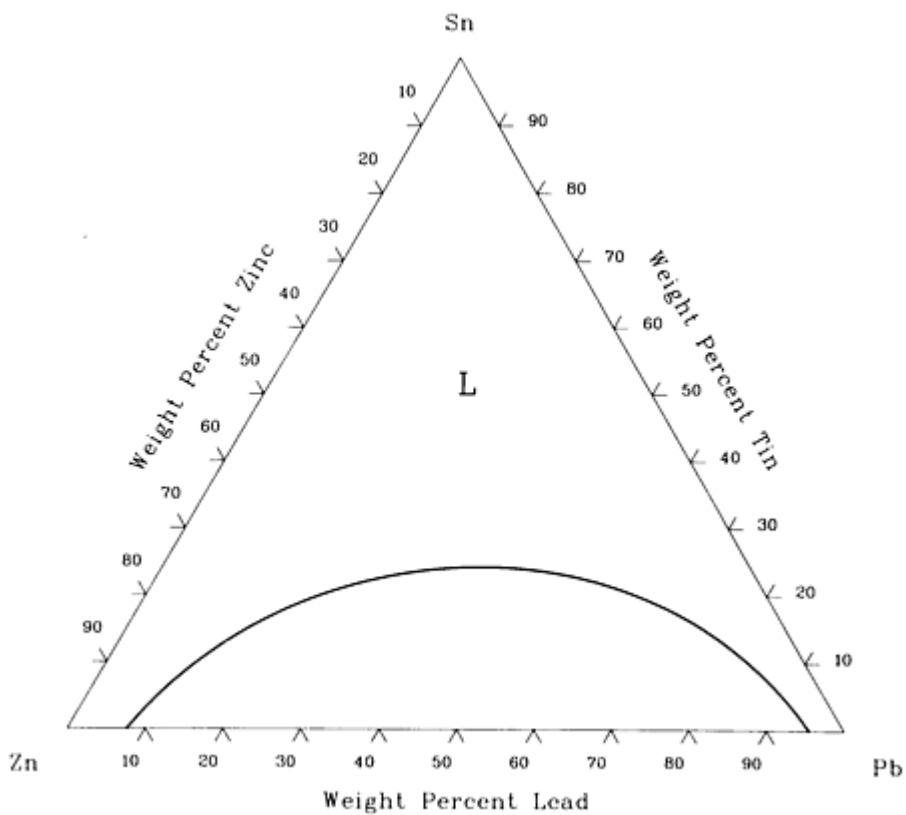

References cited in this section

51Lin: E. Linder, "Eine Methode zur Erforschung von Vierstoffsystemen Dargestellt am System Blei-Zink-Kadmium-Zinn," *Z. Metallkd.*, Vol 43, 1951, p 377-387

67Pta: W. Ptak and Z. Moser, "The Range of Occurrence of Two Liquid Phases in Zn-Sn-Cd-Pb Alloys," *Bull. Acad. Pol. Sci. Ser. Sci. Tech.*, Vol 15 (No. 9), 1967, p 809-815

Sb (Antimony) Ternary Alloy Phase Diagrams

Introduction

Ternary systems that include antimony are provided in the following locations in this Volume:

- "Cd-Sb-Sn (Cadmium - Antimony - Tin)" in the article "Cd (Cadmium) Ternary Phase Diagrams."
- "Cu-Sb-Sn (Copper - Antimony - Tin)" in the article "Cu (Copper) Ternary Phase Diagrams."
- "Pb-Sb-Sn (Lead - Antimony - Tin)" in the article "Pb (Lead) Ternary Phase Diagrams."

Si (Silicon) Ternary Alloy Phase Diagrams

Introduction

Ternary systems that include silicon are provided in the following locations in this Volume:

- "Al-Cu-Si (Aluminum - Copper - Silicon)", "Al-Fe-Si (Aluminum - Iron - Silicon)", "Al-Mg-Si (Aluminum - Magnesium - Silicon)" and "Al-Mn-Si (Aluminum - Manganese - Silicon)" in the article "Al (Aluminum) Ternary Phase Diagrams."
- "C-Fe-Si (Carbon - Iron - Silicon)" in the article "C (Carbon) Ternary Phase Diagrams."

Sn (Tin) Ternary Alloy Phase Diagrams

Introduction

Ternary systems that include tin are provided in the following locations in this Volume:

- "Ag-Pb-Sn (Silver - Lead - Tin)" in the article "Ag (Silver) Ternary Phase Diagrams."
- "Cd-Sb-Sn (Cadmium - Antimony - Tin)" in the article "Cd (Cadmium) Ternary Phase Diagrams."
- "Cu-Ni-Sn (Copper - Nickel - Tin)", "Cu-Sb-Sn (Copper - Antimony - Tin)" and "Cu-Sn-Zn (Copper - Tin - Zinc)" in the article "Cu (Copper) Ternary Phase Diagrams."
- "Pb-Sb-Sn (Lead - Antimony - Tin)" and "Pb-Sn-Zn (Lead - Tin - Zinc)" in the article "Pb (Lead) Ternary Phase Diagrams."

Ti (Titanium) Ternary Alloy Phase Diagrams

Introduction

Ternary systems that include titanium are provided in the following locations in this Volume:

- "Al-Mo-Ti (Aluminum - Molybdenum - Titanium)", "Al-Ni-Ti (Aluminum - Nickel - Titanium)" and "Al-Ti-V (Aluminum - Titanium - Vanadium)" in the article "Al (Aluminum) Ternary Phase Diagrams."

- “Co-Cr-Ti (Cobalt - Chromium - Titanium)” and “Co-Ni-Ti (Cobalt - Nickel - Titanium)” in the article “Co (Cobalt) Ternary Phase Diagrams.”
- “Cr-Ni-Ti (Chromium - Nickel - Titanium)” and “Cr-Ti-W (Chromium - Titanium - Tungsten)” in the article “Cr (Chromium) Ternary Phase Diagrams.”
- “Mo-Nb-Ti (Molybdenum - Niobium - Titanium)”, “Mo-Ni-Ti (Molybdenum - Nickel - Titanium)” and “Mo-Ti-W (Molybdenum - Titanium - Tungsten)” in the article “Mo (Molybdenum) Ternary Phase Diagrams.”
- “Nb-Ti-W (Niobium - Titanium - Tungsten)” in the article “Nb (Niobium) Ternary Phase Diagrams.”

V (Vanadium) Ternary Alloy Phase Diagrams

Introduction

Ternary systems that include vanadium are provided in the following locations in this Volume:

- “Al-Ti-V (Aluminum - Titanium - Vanadium)” in the article “Al (Aluminum) Ternary Phase Diagrams.”
- “C-Cr-V (Carbon - Chromium - Vanadium)” and “C-Fe-V (Carbon - Iron - Vanadium)” in the article “C (Carbon) Ternary Phase Diagrams.”

W (Tungsten) Ternary Alloy Phase Diagrams

Introduction

Ternary systems that include tungsten are provided in the following locations in this Volume:

- “C-Cr-W (Carbon - Chromium - Tungsten)” and “C-Fe-W (Carbon - Iron - Tungsten)” in the article “C (Carbon) Ternary Phase Diagrams.”
- “Co-Cr-W (Cobalt - Chromium - Tungsten)”, “Co-Fe-W (Cobalt - Iron - Tungsten)” and “Cr-Fe-W (Chromium - Iron - Tungsten)” in the article “Cr (Chromium) Ternary Phase Diagrams.”
- “Cr-Mo-W (Chromium - Molybdenum - Tungsten)”, “Cr-Nb-W (Chromium - Niobium - Tungsten)”, “Cr-Ni-W (Chromium - Nickel - Tungsten)” and “Cr-Ti-W (Chromium - Titanium - Tungsten)” in the article “Cr (Chromium) Ternary Phase Diagrams.”
- “Fe-Ni-W (Iron - Nickel - Tungsten)” in the article “Fe (Iron) Ternary Phase Diagrams.”
- “Mo-Ni-W (Molybdenum - Nickel - Tungsten)” and “Mo-Ti-W (Molybdenum - Titanium - Tungsten)” in the article “Mo (Molybdenum) Ternary Phase Diagrams.”
- “Nb-Ti-W (Niobium - Titanium - Tungsten)” in the article “Nb (Niobium) Ternary Phase Diagrams.”

Zn (Zinc) Ternary Alloy Phase Diagrams

Introduction

Ternary systems that include zinc are provided in the following locations in this Volume:

- “Ag-Cd-Zn (Silver - Cadmium - Zinc)” and “Ag-Cu-Zn (Silver - Copper - Zinc)” in the article “Ag (Silver) Ternary Phase Diagrams.”
- “Al-Cu-Zn (Aluminum - Copper - Zinc)”, “Al-Fe-Zn (Aluminum - Iron - Zinc)” and “Al-Mg-Zn (Aluminum - Magnesium - Zinc)” in the article “Al (Aluminum) Ternary Phase Diagrams.”
- “Cu-Ni-Zn (Copper - Nickel - Zinc)”, “Cu-Pb-Zn (Copper - Lead - Zinc)” and “Cu-Sn-Zn (Copper - Tin - Zinc)” in the article “Cu (Copper) Ternary Phase Diagrams.”
- “Pb-Sn-Zn (Lead - Tin - Zinc)” in the article “Pb (Lead) Ternary Phase Diagrams.”

Appendix

Symbols for the Chemical Elements

Symbols for the Chemical Elements

Actinium	Ac
Aluminum	Al
Americium	Am
Antimony	Sb
Argon	Ar
Arsenic	As
Astatine	At
Barium	Ba
Berkelium	Bk
Beryllium	Be
Bismuth	Bi
Boron	B
Bromine	Br
Cadmium	Cd
Calcium	Ca
Californium	Cf
Carbon	C
Cerium	Ce

Cesium	Cs
Chlorine	Cl
Chromium	Cr
Cobalt	Co
Columbium (Niobium)	Nb
Copper	Cu
Curium	Cm
Dysprosium	Dy
Einsteinium	Es
Erbium	Er
Europium	Eu
Fermium	Fm
Fluorine	F
Francium	Fr
Gadolinium	Gd
Gallium	Ga
Germanium	Ge
Gold	Au
Hafnium	Hf
Helium	He
Holmium	Ho

Hydrogen	H
Indium	In
Iodine	I
Iridium	Ir
Iron	Fe
Krypton	Kr
Lanthanum	La
Lawrencium	Lr
Lead	Pb
Lithium	Li
Lutetium	Lu
Magnesium	Mg
Manganese	Mn
Mendelevium	Md
Mercury	Hg
Molybdenum	Mo
Neodymium	Nd
Neon	Ne
Neptunium	Np
Nickel	Ni
Niobium	Nb

Nitrogen	N
Nobelium	No
Osmium	Os
Oxygen	O
Palladium	Pd
Phosphorus	P
Platinum	Pt
Plutonium	Pu
Polonium	Po
Potassium	K
Praseodymium	Pr
Promethium	Pm
Protactinium	Pa
Radium	Ra
Radon	Rn
Rhenium	Re
Rhodium	Rh
Rubidium	Rb
Ruthenium	Ru
Samarium	Sm
Scandium	Sc

Selenium	Se
Silicon	Si
Silver	Ag
Sodium	Na
Strontium	Sr
Sulfur	S
Tantalum	Ta
Technetium	Tc
Tellurium	Te
Terbium	Tb
Thallium	Tl
Thorium	Th
Thulium	Tm
Tin	Sn
Titanium	Ti
Tungsten	W
Uranium	U
Vanadium	V
Xenon	Xe
Ytterbium	Yb
Yttrium	Y

Zinc	Zn
Zirconium	Zr

Standard Atomic Weights of the Elements

I A												Pnictide Elements			Chalcogens		Halogens		Inert Gases
1	H 1 1.00794											B 5	C 6	N 7	O 8	F 9	Ne 10		
2	Li 3 6.941	II A										Be 4 9.01218	Al 13	Si 14	P 15	S 16	Cl 17	Ar 18	
3	Na 11 22.98977	Transition Metals										Mg 12 24.305	26.98154	28.0855	30.97376	32.066	35.453	39.948	
4	K 19 39.0983	Ca 20 40.078	Sc 21 44.95591	Ti 22 47.88	V 23 50.9415	Cr 24 51.9961	Mn 25 54.9380	Fe 26 55.847	Co 27 58.9332	Ni 28 58.69	Cu 29 63.546	Zn 30 65.39	Ga 31 69.723	Ge 32 72.59	As 33 74.9216	Se 34 78.96	Br 35 79.904	Kr 36 83.80	
5	Rb 37 85.4678	Sr 38 87.62	Y 39 88.9059	Zr 40 91.224	Nb 41 92.9064	Mo 42 95.94	Tc 43 (98)	Ru 44 101.07	Rh 45 102.9055	Pd 46 106.42	Ag 47 107.8682	Cd 48 112.41	In 49 114.82	Sn 50 118.710	Sb 51 121.75	Te 52 127.60	I 53 126.9045	Xe 54 131.29	
6	Cs 55 132.9054	Ba 56 137.33	La-Lu 178.49	Hf 72 178.49	Ta 73 180.9479	W 74 183.85	Re 75 186.207	Os 76 190.2	Ir 77 192.22	Pt 78 195.08	Au 79 196.9665	Hg 80 200.59	Tl 81 204.383	Pb 82 207.2	Bi 83 208.9804	Po 84 (209)	At 85 (210)	Rn 86 (222)	
7	Fr 87 (223)	Ra 88 226.0254	Ac-Lr	Lanthanide Metals															
				La 57 138.9055	Ce 58 140.12	Pr 59 140.9077	Nd 60 144.24	Pm 61 (145)	Sm 62 150.36	Eu 63 151.96	Gd 64 157.25	Tb 65 158.9254	Dy 66 162.50	Ho 67 164.9304	Er 68 167.26	Tm 69 168.9342	Yb 70 173.04	Lu 71 174.967	
				Actinide Metals															
				Ac 89 227.0278	Th 90 232.0381	Pa 91 231.0359	U 92 238.0289	Np 93 237.0482	Pu 94 (244)	Am 95 (243)	Cm 96 (247)	Bk 97 (247)	Cf 98 (251)	Es 99 (252)	Fm 100 (257)	Md 101 (258)	No 102 (259)	Lr 103 (260)	

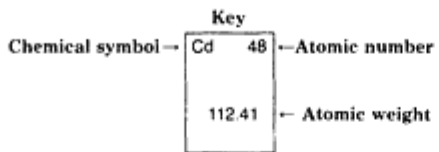

Standard Atomic Weights of the Elements.

Melting and Boiling Points of the Elements at Atmospheric Pressure

Melting and Boiling Points of the Elements at Atmospheric Pressure

Symbol	Melting point			Boiling point	
	°C	K	Error limits	°C	K
Ac	1051	1324	±50	3200	3473 ^(a)
Ag	961.93	1235.08	...	2163	2436
Al	660.452	933.602	...	2520	2793
Am	1176	1449
Ar	-189.352(T.P.)	83.798(T.P.)	...	-185.9	87.3
As	614(S.P.)	887(S.P.)
At	(302)	(575)
Au	1064.43	1337.58	...	2857	3130
B	2092	2365	...	4002	4275
Ba	727	1000	±2	1898	2171
Be	1289	1562	±5	2472	2745
Bi	271.442	544.592	...	1564	1837
Bk	1050	1323
Br	-7.25(T.P.)	265.90(T.P.)	...	59.10	332.25
C	3827(S.P.)	4100(S.P.)	±50
Ca	842	1115	±2	1484	1757
Cd	321.108	594.258	...	767	1040

Ce	798	1071	±3	3426	3699
Cf	900	1173
Cl	-100.97(T.P.)	172.18(T.P.)	...	-34.05	239.10
Cm	1345	1618
Co	1495	1768	...	2928	3201
Cr	1863	2136	±20	2672	2945
Cs	28.39	301.54	±0.05	671	944
Cu	1084.87	1358.02	±0.04	2563	2836
Dy	1412	1685	...	2562	2835
Er	1529	1802	...	2863	3136
Es	860	1133
Eu	822	1095	...	1597	1870
F	-219.67(T.P.)	53.48(T.P.)	...	-188.20	84.95
Fe	1538	1811	...	2862	3135
Fm	(1527)	(1800)
Fr	(27)	(300)
Ga	29.7741(T.P.)	302.9241(T.P.)	±0.001	2205	2478
Gd	1313	1586	...	3266	3539
Ge	938.3	1211.5	...	2834	3107
H	-259.34(T.P.)	13.81(T.P.)	...	-252.882	20.268
He	-271.69(T.P.)	1.46(T.P.)	^(b)	-268.935	4.215

Hf	2231	2504	±20	4603	4876
Hg	-38.836	234.210	...	356.623	629.773
Ho	1474	1747	...	2695	2968
I	113.6	386.8	...	185.25	458.40
In	156.634	429.784	...	2073	2346
Ir	2447	2720	...	4428	4701
K	63.71	336.86	±0.5	759	1032
Kr	-157.385	115.765	±0.001	-153.35	119.80
La	918	1191	...	3457	3730
Li	180.6	453.8	±0.5	1342	1615
Lr	(1627)	(1900)
Lu	1663	1936	...	3395	3668
Md	(827)	(1100)
Mg	650	923	±0.5	1090	1363
Mn	1246	1519	±5	2062	2335
Mo	2623	2896	...	4639	4912
N	-210.0042(T.P.)	63.1458(T.P.)	±0.0002	-195.80	77.35
Na	97.8	371.0	±0.1	883	1156
Nb	2469	2742	...	4744	5017
Nd	1021	1294	...	3068	3341
Ne	-248.587(T.P.)	24.563(T.P.)	±0.002	-246.054	27.096

Ni	1455	1728	...	2914	3187
No	(827)	(1100)
Np	639	912	±2
O	-218.789(T.P.)	54.361(T.P.)	...	-182.97	90.18
Os	3033	3306	±20	5012	5285
P(white)	44.14	317.29	±0.1	277	550
P(red)	589.6(T.P.)	862.8(T.P.)	(c)	431	704
Pa	1572	1845
Pb	327.502	600.652	...	1750	2023
Pd	1555	1828	±0.4	2964	3237
Pm	1042	1315
Po	254	527
Pr	931	1204	...	3512	3785
Pt	1769.0	2042.2	...	3827	4100
Pu	640	913	±1	3230	3503
Ra	700	973
Rb	39.48	312.63	±0.5	688	961
Re	3186	3459	±20	5596	5869
Rh	1963	2236	...	3697	3970
Rn	-71	202	...	-62	211
Ru	2334	2607	±10	4150	4423

S	115.22	388.37	...	444.60	717.75
Sb	630.755	903.905	...	1587	1860
Sc	1541	1814	...	2831	3104
Se	221	494	...	685	958
Si	1414	1687	±2	3267	3540
Sm	1074	1347	...	1791	2064
Sn	231.9681	505.1181	...	2603	2876
Sr	769	1042	...	1382	1655
Ta	3020	3293	...	5458	5731
Tb	1356	1629	...	3223	3496
Tc	2155	2428	±50	4265	4538
Te	449.57	722.72	±0.3	988	1261
Th	1755	2028	±10	4788	5061
Ti	1670	1943	±6	3289	3562
Tl	304	577	±2	1473	1746
Tm	1545	1818	...	1947	2220
U	1135	1408	...	4134	4407
V	1910	2183	±6	3409	3682
W	3422	3695	...	5555	5828
Xe	-111.7582(T.P.)	161.3918(T.P.)	±0.0002	-108.12	165.03
Y	1522	1795	...	3338	3611

Yb	819	1092	...	1194	1467
Zn	419.58	692.73	...	907	1180
Zr	1855	2128	±5	4409	4682

Note: T.P. = triple point; S.P. = sublimation point at atmospheric pressure. Measurements in parentheses are approximate.

(a) ±300.

(b) There are various triple points.

(c) Red P sublimates without melting at atmospheric pressure.

Allotropic Transformations of the Elements at Atmospheric Pressure

Allotropic transformation of the chemical elements is discussed in the Introduction to Alloy Phase Diagrams in this Handbook.

Allotropic Transformations of the Elements at Atmospheric Pressure

Element	Atomic number	Transformation	Temperature, °C
Ag	47	L ↔ S	0961.93
Al	13	L ↔ S	660.452
Am	95	L ↔ γ	1176
		γ ↔ β	1077
β ↔ α	769		
Ar	18	L ↔ S	83.798 K
Au	79	L ↔ S	1064.43
B	5	L ↔ β	2092
Ba	56	L ↔ S	727

Be	4	$L \leftrightarrow \beta$	1289
		$\beta \leftrightarrow \alpha$	1270
Bi	83	$L \leftrightarrow S$	271.442
Bk	97	$L \leftrightarrow S$	1050
Br	35	$L \leftrightarrow S$	265.9 K
Ca	20	$L \leftrightarrow \beta$	842
		$\beta \leftrightarrow \alpha$	443
Cd	48	$L \leftrightarrow S$	321.108
Ce	58	$L \leftrightarrow \delta$	798
		$\delta \leftrightarrow \gamma$	726
		$\gamma \leftrightarrow \beta$	61
		$\beta \leftrightarrow \alpha$...
Cf	98	$L \leftrightarrow \beta$	900
		$\beta \leftrightarrow \alpha$	590
Cl	17	$L \leftrightarrow S$	172.16 K
Cm	96	$L \leftrightarrow \beta$	1345
		$\beta \leftrightarrow \gamma$	1277
Co	27	$L \leftrightarrow \alpha$	1495
		$\alpha \leftrightarrow \epsilon$	422

Cr	24	$L \leftrightarrow S$	1863
Cs	55	$L \leftrightarrow S$	28.39
Cu	29	$L \leftrightarrow S$	1084.87
Dy	66	$L \leftrightarrow \beta$	1412
		$\beta \leftrightarrow \alpha$	1381
		$\alpha \leftrightarrow \alpha'$	-187
Er	68	$L \leftrightarrow S$	1529
Es	99	$L \leftrightarrow S$	860
Eu	63	$L \leftrightarrow S$	822
F	9	$L \leftrightarrow \beta$	53.48 K
		$\beta \leftrightarrow \alpha$	45.55 K
Fe	26	$L \leftrightarrow \delta$	1538
		$\delta \leftrightarrow \gamma$	1394
		$\gamma \leftrightarrow \alpha$	912
Ga	31	$L \leftrightarrow S$	29.7741
Gd	64	$L \leftrightarrow \beta$	1313
		$\beta \leftrightarrow \alpha$	1235
Ge	32	$L \leftrightarrow S$	938.3
H	1	$L \leftrightarrow S$	13.81 K

Hf	72	$L \leftrightarrow \beta$	2231
		$\beta \leftrightarrow \alpha$	1743
Hg	80	$L \leftrightarrow \alpha$	-38.290
Ho	67	$L \leftrightarrow S$	1474
I	53	$L \leftrightarrow S$	113.6
In	49	$L \leftrightarrow S$	156.634
Ir	77	$L \leftrightarrow S$	2447
K	19	$L \leftrightarrow S$	63.71
Kr	36	$L \leftrightarrow S$	115.65 K
La	57	$L \leftrightarrow \gamma$	918
		$\gamma \leftrightarrow \beta$	865
		$\beta \leftrightarrow \alpha$	310
Li	3	$L \leftrightarrow \beta$	180.6
		$\beta \leftrightarrow \alpha$	-193
Lu	71	$L \leftrightarrow S$	1663
Mg	12	$L \leftrightarrow S$	650
Mb	25	$L \leftrightarrow \delta$	1246
		$\delta \leftrightarrow \gamma$	1138
		$\gamma \leftrightarrow \beta$	1100

		$\beta \leftrightarrow \alpha$	727
Mo	42	$L \leftrightarrow S$	2623
N	7	$L \leftrightarrow \beta$	63.146 K
		$\beta \leftrightarrow \alpha$	35.61 K
Na	11	$L \leftrightarrow \beta$	97.8
		$\beta \leftrightarrow \alpha$	-233
Nb	41	$L \leftrightarrow S$	2469
Nd	60	$L \leftrightarrow \beta$	1021
		$\beta \leftrightarrow \alpha$	863
Ne	10	$L \leftrightarrow S$	24.563 K (T.P.)
Ni	28	$L \leftrightarrow S$	1455
Np	93	$L \leftrightarrow \gamma$	639
		$\gamma \leftrightarrow \beta$	576
		$\beta \leftrightarrow \alpha$	280
O	8	$L \leftrightarrow \gamma$	54.361 K
		$\gamma \leftrightarrow \beta$	43.801 K
		$\beta \leftrightarrow \alpha$	23.867 K
Os	76	$L \leftrightarrow S$	3033
P (white α)	15	$L \leftrightarrow \alpha$	44.14

Pa	91	$L \leftrightarrow \beta$	1572
		$\beta \leftrightarrow \alpha$	1170
Pb	82	$L \leftrightarrow S$	327.502
Pd	46	$L \leftrightarrow S$	1555
Pm	61	$L \leftrightarrow \beta$	1042
		$\beta \leftrightarrow \alpha$	890
Po	84	$L \leftrightarrow \beta$	254
		$\beta \leftrightarrow \alpha$	54
Pr	59	$L \leftrightarrow \beta$	931
		$\beta \leftrightarrow \alpha$	795
Pt	78	$L \leftrightarrow S$	1769.0
Pu	94	$L \leftrightarrow \epsilon$	640
		$\epsilon \leftrightarrow \delta'$	483
		$\delta' \leftrightarrow \delta$	463
		$\delta \leftrightarrow \gamma$	320
		$\gamma \leftrightarrow \beta$	215
		$\beta \leftrightarrow \alpha$	125
Rb	37	$L \leftrightarrow S$	39.48
Re	75	$L \leftrightarrow S$	3186

Rh	45	$L \leftrightarrow S$	1963
Rn	86	$L \leftrightarrow S$	-71
Ru	44	$L \leftrightarrow S$	2334
S	16	$L \leftrightarrow \beta$	115.22
		$\beta \leftrightarrow \alpha$	95.5
Sb	51	$L \leftrightarrow S$	630.755
Sc	21	$L \leftrightarrow \beta$	1541
		$\beta \leftrightarrow \alpha$	1337
Se	34	$L \leftrightarrow S$	221
Si	14	$L \leftrightarrow S$	1414
Sm	62	$L \leftrightarrow \gamma$	1074
		$\gamma \leftrightarrow \beta$	922
		$\beta \leftrightarrow \alpha$	734
Sn	50	$L \leftrightarrow \beta$	231.9681
		$\beta \leftrightarrow \alpha$	13
Sr	38	$L \leftrightarrow \beta$	769
		$\beta \leftrightarrow \alpha$	547
Ta	73	$L \leftrightarrow S$	3020
Tb	65	$L \leftrightarrow \beta$	1356

		$\beta \leftrightarrow \alpha$	1289
		$\alpha \leftrightarrow \alpha'$	-53
Te	52	$L \leftrightarrow S$	449.57
Th	90	$L \leftrightarrow \beta$	1755
		$\beta \leftrightarrow \alpha$	1360
Ti	22	$L \leftrightarrow \beta$	1670
		$\beta \leftrightarrow \alpha$	882
Tl	81	$L \leftrightarrow \beta$	304
		$\beta \leftrightarrow \alpha$	230
T	69	$L \leftrightarrow S$	1545
U	92	$L \leftrightarrow \gamma$	1135
		$\gamma \leftrightarrow \beta$	776
		$\beta \leftrightarrow \alpha$	668
V	23	$L \leftrightarrow S$	1910
W	74	$L \leftrightarrow S$	3422
Xe	54	$L \leftrightarrow S$	161.918 (T.P.)
Y	39	$L \leftrightarrow \beta$	1522
		$\beta \leftrightarrow \alpha$	1478
Yb	70	$L \leftrightarrow \gamma$	819

		$\gamma \leftrightarrow \beta$	795
		$\beta \leftrightarrow \alpha$	-3
Zn	30	L \leftrightarrow S	419.58
Zr	40	L \leftrightarrow β	1855
		$\beta \leftrightarrow \alpha$	863

Note: T.P. = triple point.

Magnetic Phase Transition Temperatures of the Elements

Magnetic phase transition, and other higher-order transitions of the chemical elements, is discussed in the Introduction to Alloy Phase Diagrams in this Handbook.

Magnetic Phase Transition Temperatures of the Elements

Chemical symbol	Atomic number	Allotrope	Phase transition temperature (T_c), K	Type of magnetic ordering ^(a)	Phase transition temperature (T_{c2}), K	Type of magnetic ordering ^(a)	Phase transition temperature (T_{c3}), K	Type of magnetic ordering ^(a)	Saturation magnetic moment, μ_B
Ce ^(b)	58	β -dcpH	13.7	AC?	12.5	AC?	2.61
		γ -fcc	14.4	AC?	
Cm	96	α -dcpH	52	AC
Co	27	fcc	1388(1115 °C)	FM	1.715
Cr	24	bcc	312.7(39.5 °C)	AI	0.45
Dy	66	α -cph	179.0	AI	89.0	FM	10.33
Er	68	cph	85.0	AI	53	AC	20.0	CF	9.1
Eu	63	bcc	90.4	AC	5.9
Fe ^(c)	26	α -bcc	1044(771 °C)	FM	2.216

		γ -fcc	67	AC	0.75
Gd	64	α -cph	293.4(20.2 °C)	FM	0.75
Ho	67	cph	132.0	AI	20.0	CF	10.34
Mn	25	α -bcc	100	AC	(d)
Nd	60	α -dcph	19.9	AI	7.5	AC	1.84
Ni	28	fcc	627.4(354.2 °C)	FM	0.616
Pm	61	α -dcph	98	FM?	0.24
Pr	59	α -dcph	0.06	AC	0.36
Sm	62	α -rhomb	106	h, A ^(e)	13.8	c, A ^(e)	0.1
Tb	65	α -cph	230.0	AI	219.5	FM	9.34
Tm	69	cph	58.0	AI	40 to 32	FI	7.14

Source: J.J. Rhyne, *Bull. Alloy Phase Diagrams*, 3(3), 402 (1982).

(a) Type of magnetic ordering indicated by the following symbols: FM = transition from paramagnetic to ferromagnetic state, AC = transition to periodic (antiferromagnetic) state that is commensurate with the lattice periodicity (*e.g.*, spins on three atom layers directed up followed by three layers down, *etc.*), AI = transition to periodic (antiferromagnetic) state that is generally not commensurate with the lattice periodicity (*e.g.*, helical spin ordering), CF = transition to conical ferromagnetic state (combination of planar helical antiferromagnetic plus ferromagnetic component), and FI = transition to ferromagnetic periodic structure (unequal number of up and down spin layers).

(b) Ce exists in five crystal structures, two of which are magnetic (γ -fcc; and β -dcph). γ Ce is estimated to be antiferromagnetic below 14.4K by extrapolation from fcc Ce-La alloys. (α Ce does not exist in pure form below ~ 100 K.) β Ce is thought to exhibit antiferromagnetism on the hexagonal lattice sites below 13.7 K and on the cubic sites below 12.5 K.

(c) Magnetic measurements quoted in table for γ Fe are for fcc Fe precipitated in copper.

(d) The magnetic moment assignments of Mn are complex.

(e) h, A; c, A = indicate that sites of hexagonal and cubic point symmetry order antiferromagnetically, but at different temperatures.

Crystal Structures and Lattice Parameters of Allotropes of the Metallic Elements

The crystal structure of the allotropic forms of the metallic elements are presented here in terms of the Pearson symbol, space group, and prototype of the structure. The temperatures of the phase transformations are listed in degrees Celsius and the pressures are in GPa. A consistent nomenclature is used, whereby all allotropes are labeled by Greek letters. The lattice parameters of the unit cells are given in nanometers (nm) and are considered to be accurate ± 2 in the last reported digit. Both crystal structure and lattice parameters are discussed in the Introduction to Alloy Phase Diagrams in this Handbook.

This compilation is restricted to changes in crystal structure that occur as a result of a change in temperature or pressure. Low-temperature structures are included for the diatomic and rare gases, which show many similarities with respect to the metallic elements.

Note that there may be differences between values quoted below and similar values given in another table in this Handbook that has been reproduced from another source. For example, the allotropic transformation temperatures of Mn may differ by as much as 23 °C, etc.

Crystal Structures and Lattice Parameters of Allotropes of the Metallic Elements

Element	Temperature, °C	Pressure, GPa	Pearson symbol	Space group	Prototype	Lattice parameters, nm			Comment, c/a , or α or β
						a	b	c	
Ac	25	atm	$cF4$	$Fm\bar{3}m$	Cu	0.5311
Ag	25	atm	$cF4$	$Fm\bar{3}m$	Cu	0.40857
α Al	25	atm	$cF4$	$Fm\bar{3}m$	Cu	0.40496
β Al	25	>20.5	$hP2$	$P6_3/mmc$	Mg	0.2693	...	0.4398	1.6331
α Am	25	atm	$hP4$	$P6_3/mmc$	α La	0.34681	...	1.1241	2×1.621
β Am	>769	atm	$cF4$	$Fm\bar{3}m$	Cu	0.4894
γ Am	>1077	atm	$cI2$	$Im\bar{3}m$	W	?
δ Am	25	>15	$oC4$	$Cmcm$	α U	0.3063	0.5968	0.5169	...
α Ar	<-189.2	atm	$cF4$	$Fm\bar{3}m$	Cu	0.53109
As	25	atm	$hR2$	$R\bar{3}m$	α As	0.41319	$\alpha = 54.12^\circ$

Au	25	atm	<i>cF4</i>	$Fm\bar{3}m$	Cu	0.40782
β_B	25	atm	<i>hR105</i>	$R\bar{3}m$	β_B	1.017	$\alpha = 65.12^\circ$
α_{Ba}	25	atm	<i>cI2</i>	$Im\bar{3}m$	W	0.50227
β_{Ba}	25	>5.33	<i>hP2</i>	$P6_3/mmc$	Mg	0.3901	...	0.6154	1.5775
γ_{Ba}	25	>23	?	?
α_{Be}	25	atm	<i>hP2</i>	$P6_3/mmc$	Mg	0.22859	...	0.35845	1.5681
β_{Be}	>1270	atm	<i>cI2</i>	$Im\bar{3}m$	W	0.25515
BeII	25	>28.3	<i>hP*</i>	0.4328	...	0.3416	0.7893
α_{Bi}	25	atm	<i>hR2</i>	$R\bar{3}m$	α_{As}	0.47460	$\alpha = 57.23^\circ$
β_{Bi}	25	>2.6	<i>mC4</i>	$C2/m$	β_{Bi}	0.6674	0.6117	0.3304	$\beta = 110.33^\circ$
γ_{Bi}	25	>3.0	<i>mP4</i>	$P2_1/m$...	0.665	0.420	0.465	$\beta = 85.33^\circ$
δ_{Bi}	25	>4.3	?	?
ζ_{Bi}	25	>9.0	<i>cI2</i>	$Im\bar{3}m$	W	0.3800
α_{Bk}	25	atm	<i>hP4</i>	$P6_3/mmc$	α_{La}	0.3416	...	1.1069	2×1.620
β_{Bk}	>977	atm	<i>cF4</i>	$Fm\bar{3}m$	Cu	0.4997
Br	<-7.25	atm	<i>oC8</i>	$Cmca$	I_2	0.668	0.449	0.874	...
C(graphite)	25	atm	<i>hP4</i>	$P6_3/mmc$	C(graphite)	0.24612	...	0.6709	2.7258
C(diamond)	25	>60	<i>cF8</i>	$Fd\bar{3}m$	C(diamond)	0.35669
α_{Ca}	25	atm	<i>cF4</i>	$Fm\bar{3}m$	Cu	0.55884

β_{Ca}	>443	atm	<i>cI2</i>	$Im\bar{3}m$	W	0.4480
γ_{Ca}	25	>1.5	?
Cd	25	atm	<i>hP2</i>	$P6_3/mmc$	Mg	0.29793	...	0.56196	1.8862
α_{Ce}	<-177	atm	<i>cF4</i>	$Fm\bar{3}m$	Cu	0.485
β_{Ce}	25	atm	<i>hP4</i>	$P6_3/mmc$	α_{La}	0.36810	...	1.1857	2×1.611
γ_{Ce}	>61	atm	<i>cF4</i>	$Fm\bar{3}m$	Cu	0.51610
δ_{Ce}	>726	atm	<i>cI2</i>	$Im\bar{3}m$	W	0.412
α'_{Ce}	25	>5.4	<i>oC4</i>	$Cmcm$	α_U	0.3049	0.5998	0.5215	...
α_{Cf}	25	atm	<i>hP4</i>	$P6_3/mmc$	α_{La}	0.339	...	1.1015	2×1.625
β_{Cf}	>590	atm	<i>cF4</i>	$Fm\bar{3}m$	Cu	?
Cl	<-100.97	atm	<i>oC8</i>	$Cmca$	I_2	0.624	0.448	0.826	...
α_{Cm}	25	atm	<i>hP4</i>	$P6_3/mmc$	α_{La}	0.3496	...	1.1331	2×1.621
β_{Cm}	>1277	atm	<i>cF4</i>	$Fm\bar{3}m$	Cu	0.4382
ϵ_{Co}	25	atm	<i>hP2</i>	$P6_3/mmc$	Mg	0.25071	...	0.40686	1.6228
α_{Co}	>422	atm	<i>cF4</i>	$Fm\bar{3}m$	Cu	0.35447
α_{Cr}	25	atm	<i>cI2</i>	$Im\bar{3}m$	W	0.28848
α'_{Cr}	25	HP	<i>tI2</i>	$I4/mmm$	α'_{Cr}	0.2882	...	0.2887	1.002
α_{Cs}	25	atm	<i>cI2</i>	$Im\bar{3}m$	W	0.6141
β_{Cs}	25	>2.37	<i>cF4</i>	$Fm\bar{3}m$	Cu	0.6465

β_{Cs}	25	>4.22	<i>cF4</i>	$Fm\bar{3}m$	Cu	0.5800
γ_{Cs}	25	>4.27	?
Cu	25	atm	<i>cF4</i>	$Fm\bar{3}m$	Cu	0.36146
α_{Dy}	<-187	atm	<i>oC4</i>	<i>Cmcm</i>	α_{Dy}	0.3595	0.6184	0.5678	...
α_{Dy}	25	atm	<i>hP2</i>	$P6_3/mmc$	Mg	0.35915	...	0.56501	1.5732
β_{Dy}	>1381	atm	<i>cI2</i>	$Im\bar{3}m$	W	(0.398)
γ_{Dy}	25	>7.5	<i>hR3</i>	$R\bar{3}m$	CdCl_2	0.3436	...	2.483	4.5×1.606
Er	25	atm	<i>hP2</i>	$P6_3/mmc$	Mg	0.35592	...	0.55850	1.5692
α_{Es}	25	atm	<i>hP4</i>	$P6_3/mmc$	α_{La}	?
β_{Es}	?	atm	<i>cF4</i>	$Fm\bar{3}m$	Cu	?
Eu	25	atm	<i>cI2</i>	$Im\bar{3}m$	W	0.45827
α_{F}	<-227.60	atm	<i>mC8</i>	<i>C2/c</i>	α_{F}	0.550	0.338	0.728	$\beta = 102.17^\circ$
β_{F}	<-219.67	atm	<i>cP16</i>	$Pm\bar{3}n$	γ_{O}	0.667
α_{Fe}	25	atm	<i>cI2</i>	$Im\bar{3}m$	W	0.28665
γ_{Fe}	>912	atm	<i>cF4</i>	$Fm\bar{3}m$	Cu	0.36467
δ_{Fe}	>1394	atm	<i>cI2</i>	$Im\bar{3}m$	W	0.29315
ϵ_{Fe}	25	>13	<i>hP2</i>	$P6_3/mmc$	Mg	0.2468	...	0.396	1.603
α_{Ga}	25	atm	<i>oC8</i>	<i>Cmca</i>	α_{Ga}	0.45186	0.76570	0.45258	...
β_{Ga}	25	>1.2	<i>tI2</i>	$I4/mmm$	In	0.2808	...	0.4458	1.588

γ_{Ga}	-53	>3.0	<i>oC40</i>	<i>Cmcm</i>	γ_{Ga}	1.0593	1.3523	0.5203	...
α_{Gd}	25	atm	<i>hP2</i>	<i>P6₃/mmc</i>	Mg	0.36336	...	0.57810	1.5910
β_{Gd}	>1235	atm	<i>cI2</i>	<i>Im$\bar{3}m$</i>	W	0.406
γ_{Gd}	25	>3.0	<i>hR3</i>	<i>R$\bar{3}m$</i>	α_{Sm}	0.361	...	2.603	4.5 × 1.60
α_{Ge}	25	atm	<i>cF8</i>	<i>Fd$\bar{3}m$</i>	C(diamond)	0.56574
β_{Ge}	25	>12	<i>tI4</i>	<i>I4₁/amd</i>	β_{Sn}	0.4884	...	0.2692	0.551
γ_{Ge}	25	>12 → atm	<i>tP12</i>	<i>P4₁2₁2</i>	γ_{Ge}	0.593	...	0.698	1.18
δ_{Ge}	LT	>12	<i>cI16</i>	<i>Im$\bar{3}m$</i>	γ_{Si}	0.692
α_{H}	<-271.9	atm	<i>cF4</i>	<i>Fm$\bar{3}m$</i>	Cu	0.5338
β_{H_3}	<-259.34	atm	<i>hP2</i>	<i>P6₃/mmc</i>	Mg	0.3776	...	0.6162	1.632
He ₄	-269.67	0.163	<i>hP2</i>	<i>P6₃/mmc</i>	Mg	0.3501	...	0.5721	1.634
He	-269.2	0.129	<i>hP2</i>	<i>P6₃/mmc</i>	Mg	0.3470	...	0.5540	1.597
α_{Hf}	25	atm	<i>hP2</i>	<i>P6₃/mmc</i>	Mg	0.31946	...	0.50510	1.5811
β_{Hf}	>1743	atm	<i>cI2</i>	<i>Im$\bar{3}m$</i>	W	0.3610
α_{Hg}	<-38.836	atm	<i>hR1</i>	<i>R$\bar{3}m$</i>	α_{Hg}	0.3005	$\alpha = 70.53^\circ$
β_{Hg}	<-194	HP	<i>tI2</i>	<i>I4/mmm</i>	β_{Hg}	0.3995	...	0.2825	0.707
α_{Ho}	25	atm	<i>hP2</i>	<i>P6₃/mmc</i>	Mg	0.35778	...	0.56178	1.5702
β_{Ho}	25	>7.5	<i>hR3</i>	<i>R$\bar{3}m$</i>	α_{Sm}	0.334	...	2.45	4.5 × 1.63
I	25	atm	<i>oC8</i>	<i>Cmca</i>	I ₂	0.72697	0.47903	0.97942	...

In	25	atm	$tI2$	$I4/mmm$	In	0.3253	...	0.49470	1.5210
Ir	25	atm	$cF4$	$Fm\bar{3}m$	Cu	0.38392
K	25	atm	$cI2$	$Im\bar{3}m$	W	0.5321
Kr	<-157.385	atm	$cF4$	$Fm\bar{3}m$	Cu	0.5810
α La	25	atm	$hP4$	$P6_3/mmc$	α La	0.37740	...	1.2171	2×1.6125
β La	>310	atm	$cF4$	$Fm\bar{3}m$	Cu	0.5303
γ La	>865	atm	$cI2$	$Im\bar{3}m$	W	0.426
β' La	25	>2.0	$cF4$	$Fm\bar{3}m$	Cu	0.517
α Li	<-193	atm	$hP2$	$P6_3/mmc$	Mg	0.3111	...	0.5093	1.637
β Li	25	atm	$cI2$	$Im\bar{3}m$	W	0.35093
Lu	25	atm	$hP2$	$P6_3/mmc$	Mg	0.35052	...	0.55494	1.5832
Mg	25	atm	$hP2$	$P6_3/mmc$	Mg	0.32094	...	0.52107	1.6236
α Mn	25	atm	$cI58$	$I\bar{4}3m$	α Mn	0.89126
β Mn	>727	atm	$cP20$	$P4_132$	β Mn	0.63152
γ Mn	>1100	atm	$cF4$	$Fm\bar{3}m$	Cu	0.3860
δ Mn	>1138	atm	$cI2$	$Im\bar{3}m$	W	0.3080
Mo	25	atm	$cI2$	$Im\bar{3}m$	W	0.31470
α N	<-237.54	atm	$cP8$	$Pa3$	α N	0.5661
β N	<-210.004	atm	$hP4$	$P6_3/mmc$	β N	0.4050	...	0.6604	1.631

γ_N	<-253	>3.3	<i>tP4</i>	<i>P4₂/mmm</i>	γ_N	0.3957	...	0.5109	1.291
α_{Na}	<-233	atm	<i>hP2</i>	<i>P6₃/mmc</i>	Mg	0.3767	...	0.6154	1.634
β_{Na}	25	atm	<i>cI2</i>	<i>Im$\bar{3}m$</i>	W	0.42906
Nb	25	atm	<i>cI2</i>	<i>Im$\bar{3}m$</i>	W	0.33004
α_{Nd}	25	atm	<i>hP4</i>	<i>P6₃/mmc</i>	α_{La}	0.36582	...	1.17966	2 × 1.6124
β_{Nd}	>863	atm	<i>cI2</i>	<i>Im$\bar{3}m$</i>	W	0.413
γ_{Nd}	25	>5.0	<i>cF4</i>	<i>Fm$\bar{3}m$</i>	Cu	0.480
Ne	<-248.587	atm	<i>cF4</i>	<i>Fm$\bar{3}m$</i>	Cu	0.4462
Ni	25	atm	<i>cF4</i>	<i>Fm$\bar{3}m$</i>	Cu	0.35240
α_{Np}	25	atm	<i>oP8</i>	<i>Pnma</i>	α_{Np}	0.6663	0.4723	0.4887	...
β_{Np}	>280	atm	<i>tP4</i>	<i>P4₂,2</i>	β_{Np}	0.4883	...	0.3389	0.694
γ_{Np}	>576	atm	<i>cI2</i>	<i>Im$\bar{3}m$</i>	W	0.352
α_O	<-249.283	atm	<i>mC4</i>	<i>C2m</i>	α_O	0.5403	0.3429	0.5086	$\beta = 132.53^\circ$
β_O	<-229.349	atm	<i>hR2</i>	<i>R$\bar{3}m$</i>	β_O	0.4210	$\alpha = 46.27^\circ$
γ_O	<-218.789	atm	<i>cP16</i>	<i>Pm$\bar{3}n$</i>	γ_O	0.683
Os	25	atm	<i>hP2</i>	<i>P6₃/mmc</i>	Mg	0.27341	...	0.43198	1.5800
$\alpha_{P(\text{white})}$	25	atm	<i>c**</i>	...	P(white)	0.718
P(black)	25	atm	<i>oC8</i>	<i>Cmca</i>	P(black)	0.33136	1.0478	0.43763	...
α_{Pa}	25	atm	<i>tI2</i>	<i>I4/mmm</i>	α_{Pa}	0.3921	...	0.3235	0.825

β_{Pa}	>1170	atm	<i>cI2</i>	$Im\bar{3}m$	W	0.381
α_{Pb}	25	atm	<i>cF4</i>	$Fm\bar{3}m$	Cu	0.49502
β_{Pb}	25	>10.3	<i>hP2</i>	$P6_3/mmc$	Mg	0.3265	...	0.5387	1.650
Pd	25	atm	<i>cF4</i>	$Fm\bar{3}m$	Cu	0.38903
α_{Pm}	25	atm	<i>hP4</i>	$P6_3/mmc$	α_{La}	0.365	...	1.165	2×1.60
β_{Pm}	>890	atm	<i>cI2</i>	$Im\bar{3}m$	W	?
α_{Po}	25	atm	<i>cP1</i>	$Pm\bar{3}m$	α_{Po}	0.3366
β_{Po}	>54	atm	<i>hR1</i>	$R\bar{3}m$	β_{Po}	0.3373	$\alpha = 98.08^\circ$
α_{Pr}	25	atm	<i>hP4</i>	$P6_3/mmc$	α_{La}	0.36721	...	1.18326	2×1.6111
β_{Pr}	>795	atm	<i>cI2</i>	$Im\bar{3}m$	W	0.413
γ_{Pr}	25	>4.0	<i>cF4</i>	$Fm\bar{3}m$	Cu	0.488
Pt	25	atm	<i>cF4</i>	$Fm\bar{3}m$	Cu	0.39236
α_{Pu}	25	atm	<i>mP16</i>	$P2_1/m$	α_{Pu}	0.6183	0.4822	1.0963	$\beta = 101.97^\circ$
β_{Pu}	>125	atm	<i>mC34</i>	$C2/m$	β_{Pu}	0.9284	1.0463	0.7859	$\beta = 92.13^\circ$
γ_{Pu}	>215	atm	<i>oF8</i>	$Fddd$	γ_{Pu}	0.31587	0.57682	1.0162	...
δ_{Pu}	>320	atm	<i>cF4</i>	$Fm\bar{3}m$	Cu	0.46371
δ'_{Pu}	>463	atm	<i>tI2</i>	$I4/mmm$	In	0.33261	...	0.44630	1.3418
ϵ_{Pu}	>483	atm	<i>cI2</i>	$Im\bar{3}m$	W	0.36343
Ra	25	atm	<i>cI2</i>	$Im\bar{3}m$	W	0.5148

α Rb	25	atm	<i>cI2</i>	$Im\bar{3}m$	W	0.5705
β Rb	25	>1.08	?
γ Rb	25	>2.05	?
Re	25	atm	<i>hP2</i>	$P6_3/mmc$	Mg	0.27609	...	0.4458	1.6145
Rh	25	atm	<i>cF4</i>	$Fm\bar{3}m$	Cu	0.38032
Ru	25	atm	<i>hP2</i>	$P6_3/mmc$	Mg	0.27058	...	0.42816	1.5824
α S	25	atm	<i>oF128</i>	<i>Fddd</i>	α S	1.0464	1.28660	2.44860	...
β S	>95.5	atm	<i>mP64</i>	$P2_1/c$	β S	1.102	1.096	1.090	$\beta = 96.7^\circ$
α Sb	25	atm	<i>hR2</i>	$R\bar{3}m$	α As	0.45067	$\alpha = 57.11^\circ$
β Sb	25	>5.0	<i>cP1</i>	$Pm\bar{3}m$	α Po	0.2992
γ Sb	25	>7.5	<i>hP2</i>	$P6_3/mmc$	Mg	0.3376	...	0.5341	1.582
δ Sb	25	>14.0	<i>mP3</i>	?	...	0.556	0.404	0.422	$\beta = 86.0^\circ$
α Sc	25	atm	<i>hP2</i>	$P6_3/mmc$	Mg	0.33088	...	0.52680	1.5921
β Sc	>1337	atm	<i>cI2</i>	$Im\bar{3}m$	W	0.373
γ Se	25	atm	<i>hP3</i>	$P3_121$	γ Se	0.43659	...	0.49537	1.1346
α Si	25	atm	<i>cF8</i>	$Fd\bar{3}m$	C(diamond)	0.54306
β Si	25	>9.5	<i>tI4</i>	$I4_1/amd$	β Sn	0.4686	...	0.2585	0.552
γ Si	25	>16.0	<i>cI16</i>	$Im\bar{3}m$	γ Si	0.6636
δ Si	25	>16 \rightarrow atm	<i>hP4</i>	$P6_3/mmc$	α La	0.380	...	0.628	1.653

α Sm	25	atm	<i>hR3</i>	$R\bar{3}m$	α Sm	0.36290	...	2.6207	4.5×1.6048
β Sm	>734	atm	<i>hP2</i>	$P6_3/mmc$	Mg	0.36630	...	0.58448	1.5956
γ Sm	>922	atm	<i>cI2</i>	$Im\bar{3}m$	W	?
δ Sm	25	>4.0	<i>hP4</i>	$P6_3/mmc$	α La	0.3618	...	1.166	2×1.611
α Sn	<13	atm	<i>cF8</i>	$Fd\bar{3}m$	C(diamond)	0.64892
β Sn	25	atm	<i>tI4</i>	$I4_1/amd$	β Sn	0.58318	...	0.31818	0.5456
γ Sn	25	>9.0	<i>tI2</i>	?	γ Sn	0.370	...	0.337	0.91
α Sr	25	atm	<i>cF4</i>	$Fm\bar{3}m$	Cu	0.6084
β Sr	>547	atm	<i>cI2</i>	$Im\bar{3}m$	W	0.487
β' Sr	25	>3.5	<i>cI2</i>	$Im\bar{3}m$	W	0.4437
Ta	25	atm	<i>cI2</i>	$Im\bar{3}m$	W	0.33030
α Tb	<-53	atm	<i>oC4</i>	<i>Cmcm</i>	α' Dy	0.3605	0.6244	0.5706	...
α' Tb	25	atm	<i>hP2</i>	$P6_3/mmc$	Mg	0.36055	...	0.56966	1.5800
β Tb	>1289	atm	<i>cI2</i>	$Im\bar{3}m$	W	(0.402)
γ Tb	25	>6.0	<i>hR3</i>	$R\bar{3}m$	α Sm	0.341	...	2.45	4.5×1.60
Tc	25	atm	<i>hP2</i>	$P6_3/mmc$	Mg	0.2738	...	0.4393	1.604
α Te	25	atm	<i>hP3</i>	$P3_121$	γ Se	0.44566	...	0.59264	1.3298
β Te	25	>2.0	<i>hR2</i>	$R\bar{3}m$	α As	0.469	$\alpha = 53.30^\circ$
γ Te	25	>7.0	<i>hR1</i>	$R\bar{3}m$	β Po	0.3002	$\alpha = 103.3^\circ$

α Th	25	atm	<i>cF4</i>	$Fm\bar{3}m$	Cu	0.50842
β Th	>1360	atm	<i>cI2</i>	$Im\bar{3}m$	W	0.411
α Ti	25	atm	<i>hP2</i>	$P6_3/mmc$	Mg	0.29506	...	0.46835	1.5873
β Ti	>882	atm	<i>cI2</i>	$Im\bar{3}m$	W	0.33065
ω Ti	25	HP \rightarrow atm	<i>hP3</i>	$P6/mmm$	ω Ti	0.4625	...	0.2813	0.6082
α Tl	25	atm	<i>hP2</i>	$P6_3/mmc$	Mg	0.34566	...	0.55248	1.5983
β Tl	>230	atm	<i>cI2</i>	$Im\bar{3}m$	W	0.3879
γ Tl	25	HP	<i>cF4</i>	$Fm\bar{3}m$	Cu	?
Tm	25	atm	<i>hP2</i>	$P6_3/mmc$	Mg	0.35375	...	0.55540	1.5700
α U	25	atm	<i>oC4</i>	$Cmcm$	α U	0.28537	0.58695	0.49548	...
β U	>668	atm	<i>tP30</i>	$P4_2/mmm$	β U	1.0759	...	0.5656	0.526
γ U	>776	atm	<i>cI2</i>	$Im\bar{3}m$	W	0.3524
V	25	atm	<i>cI2</i>	$Im\bar{3}m$	W	0.30240
W	25	atm	<i>cI2</i>	$Im\bar{3}m$	W	0.31652
Xe	<-111.758	atm	<i>cF4</i>	$Fm\bar{3}m$	Cu	0.6350
α Y	25	atm	<i>hP2</i>	$P6_3/mmc$	Mg	0.36482	...	0.57318	1.5711
β Y	>1478	atm	<i>cI2</i>	$Im\bar{3}m$	W	(0.407)
α Yb	<-3	atm	<i>hP2</i>	$P6_3/mmc$	Mg	0.38799	...	0.63859	1.6459
β Yb	25	atm	<i>cF4</i>	$Fm\bar{3}m$	Cu	0.54848

γ_{Yb}	>795	atm	<i>cI2</i>	$Im\bar{3}m$	W	0.444
Zn	25	atm	<i>hP2</i>	$P6_3/mmc$	Mg	0.26650	...	0.49470	1.8563
α_{Zr}	25	atm	<i>hP2</i>	$P6_3/mmc$	Mg	0.32316	...	0.51475	1.5929
β_{Zr}	>863	atm	<i>cI2</i>	$Im\bar{3}m$	W	0.36090
ω_{Zr}	25	HP \rightarrow atm	<i>hP2</i>	$P6/mmm$	ω_{Ti}	0.5036	...	0.3109	0.617

Note: Values in parentheses are estimated.

Appendix

Crystal Structure Nomenclature

The various designation systems for describing crystal structure are discussed in the Introduction to Alloy Phase Diagrams in this Handbook.

Crystal Structure Nomenclature: Arranged Alphabetically by Pearson-Symbol Designation

Pearson symbol	Prototype	Strukturbericht designation	Space group
<i>cF4</i>	Cu	A1	$Fm\bar{3}m$
<i>cF8</i>	C(diamond)	A4	Fd_3m
	NaCl	B1	$Fm\bar{3}m$
	ZnS(sphalerite)	B3	$F\bar{4}3m$
<i>cF12</i>	CaF ₂	C1	$Fm\bar{3}m$
	MgAgAs	C1 _b	$F\bar{4}3m$
<i>cF16</i>	AlCu ₂ Mn	L2 ₁	$Fm\bar{3}m$
	BiF ₃	D0 ₃	$Fm\bar{3}m$

	NaTl	$B32$	$Fd\bar{3}m$
$cF24$	AuBe ₅	$C15_b$	$F\bar{4}3m$
	SiO ₂ (β cristobalite)	$C9$	$Fd\bar{3}m$
	Cu ₂ Mg	$C15$	$Fd\bar{3}m$
$cF32$	CuPt ₃	$L1_a$	$Fm\bar{3}c$
$cF52$	UB ₁₂	$D2_f$	$Fm\bar{3}m$
$cF56$	Al ₂ MgO ₄	$H1_1$	$Fd\bar{3}m$
	Co ₃ S ₄	$D7_2$	$Fd\bar{3}m$
$cF68$	Co ₉ S ₈	$D8_9$	$Fm\bar{3}m$
$cF80$	Sb ₂ O ₃ (senarmonite)	$D54$	$Fd\bar{3}m$
$cF112$	Fe ₃ W ₃ C	$E9_3$	$Fd\bar{3}m$
	NaZn ₁₃	$D2_3$	$Fm\bar{3}c$
$cF116$	Cr ₂₃ C ₆	$D8_4$	$Fm\bar{3}m$
	Mn ₂₃ Th ₆	$D8_a$	$Fm\bar{3}m$
$cI2$	W	$A2$	$Im\bar{3}m$
$cI16$	CoU	B_a	$I2_13$
$cI28$	Th ₃ P ₄	$D7_3$	$I\bar{4}3d$
$cI32$	CoAs ₃	$D0_2$	$Im\bar{3}$
$cI40$	Ge ₇ Ir ₃	$D8_f$	$Im\bar{3}m$

	Pu_2C_3	$D5_c$	$I\bar{4}3d$
<i>cI52</i>	Cu_5Zn_8	$D8_2$	$I\bar{4}3m$
	$\text{Fe}_3\text{Zn}_{10}$	$D8_1$	$Im\bar{3}m$
<i>cI54</i>	Sb_2Tl_7	$L2_2$	$Im\bar{3}m$
<i>cI58</i>	αMn	$A12$	$I\bar{4}3m$
<i>cI76</i>	$\text{Cu}_{15}\text{Si}_4$	$D8_6$	$I\bar{4}3d$
<i>cI80</i>	Mn_2O_3	$D5_3$	$Ia\bar{3}$
<i>cI96</i>	AlLi_3N_2	$E9_d$	$Ia\bar{3}$
<i>cI162</i>	$\text{Mg}_{32}(\text{Al,Zn})_{49}$	$D8_e$	$Im\bar{3}$
<i>cP1</i>	αPo	A_h	$Pm\bar{3}m$
<i>cP2</i>	CsCl	$B2$	$Pm\bar{3}m$
<i>cP4</i>	AuCu_3	$L1_2$	$Pm\bar{3}m$
	ReO_3	$D0_9$	$Pm\bar{3}m$
<i>cP5</i>	AlFe_3C	$L'1_2$	$Pm\bar{3}m$
	CaTiO_3	$E2_1$	$Pm\bar{3}m$
	Fe_4N	$L'1$	$P\bar{4}3m$
<i>cP6</i>	Ag_2O	$C3$	$Pn\bar{3}m$
<i>cP7</i>	CaB_6	$D2_1$	$Pm\bar{3}m$

<i>cP8</i>	Cr ₃ Si	A15	<i>Pm</i> $\bar{3}n$
	FeSi	B20	<i>P2</i> ₁₃
	Cu ₃ VS ₄	H2 ₄	<i>P</i> $\bar{4}3m$
<i>cP12</i>	FeS ₂ (pyrite)	C2	<i>Pa</i> 3
	NiSbS	F0 ₁	<i>P2</i> ₁₃
<i>cP20</i>	β _{Mn}	A13	<i>P4</i> ₁₃₂
<i>cP36</i>	BaHg ₁₁	D2 _e	<i>Pm</i> $\bar{3}m$
<i>cP39</i>	Mg ₂ Zn ₁₁	D8 _c	<i>Pm</i> $\bar{3}$
<i>cP52</i>	Cu ₉ Al ₄	D8 ₃	<i>P</i> $\bar{4}3m$
<i>hP1</i>	HgSn ₆₋₁₀	A _f	<i>P6/mmm</i>
<i>hP2</i>	Mg	A3	<i>P6</i> _{3/mmc}
	WC	B _h	<i>P</i> $\bar{6}m2$
<i>hP3</i>	AlB ₂	C32	<i>P6/mmm</i>
	CdI ₂	C6	<i>P</i> $\bar{3}m1$
	Fe ₂ N	L'3	<i>P6</i> _{3/mmc}
	LiZn ₂	C _k	<i>P6</i> _{3/mmc}
	γ _{Se}	A8	<i>P3</i> ₁₂₁
<i>hP4</i>	α _{La}	A3'	<i>P6</i> _{3/mmc}
	BN	B _k	<i>P6</i> _{3/mmc}
	C(graphite)	A9	<i>P6</i> _{3/mmc}

	NiAs	$B8_1$	$P6_3/mmc$
	ZnS(wurtzite)	$B4$	$P6_3mc$
$hP5$	La_2O_3	$D5_2$	$P\bar{3}m1$
	Ni_2Al_3	$D5_{13}$	$P\bar{3}m1$
$hP6$	$CaCu_5$	$D2_d$	$P6/mmm$
	CoSn	$B35$	$P6/mmm$
	Cu_2Te	C_h	$P6/mmm$
	HgS	$B9$	$P3_121$
	MoS_2	$C7$	$P6_3/mmc$
	Ni_2In	$B8_2$	$P6_3/mmc$
$hP8$	Na_3As	$D0_{18}$	$P6_3/mmc$
	Ni_3Sn	$D0_{19}$	$P6_3/mmc$
	TiAs	B_i	$P6_3/mmc$
$hP9$	$CrSi_2$	$C40$	$P6_22$
	Fe_2P	$C22$	$P\bar{6}2m$
	ζ_{AgZn}	B_b	$P\bar{3}$
	SiO_2 (high quartz)	$C8$	$P6_22$
$hP10$	Pt_2Sn_3	$D5_b$	$P6_3/mmc$
$hP12$	CuS	$B18$	$P6_3/mmc$
	$MgZn_2$	$C14$	$P6_3/mmc$

	$\text{SiO}_2(\beta \text{ tridymite})$	C_{10}	$P6_3/mmc$
$hP14$	W_2B_5	$D8_h$	$P6_3/mmc$
$hP16$	Mn_5Si_3	$D8_8$	$P6_3/mcm$
	Ni_3Ti	$D0_{24}$	$P6_3/mmc$
$hP18$	$\text{Al}_4\text{C}_4\text{Si}$	$E9_4$	$P6_3mc$
	$\text{Al}_8\text{FeMg}_3\text{Si}_6$	$E9_b$	$P\bar{6}2m$
	Mg_2Ni	C_a	$P6_22$
$hP20$	Fe_3Th_7	$D10_2$	$P6_3mc$
	Th_7S_{12}	$D8_k$	$P6_3/m$
$hP24$	Cu_3P	$D0_{21}$	$P6_3cm$
	MgNi_2	$C36$	$P6_3/mmc$
$hP28$	Co_2Al_5	$D8_{11}$	$P6_3/mmc$
$hR1$	αHg	A_{10}	$R\bar{3}m$
	βPo	A_i	$R\bar{3}m$
$hR2$	αAs	A_7	$R\bar{3}m$
$hR3$	αSm	C_{19}	$R\bar{3}m$
$hR4$	NaCrS_2	$F5_1$	$R\bar{3}m$
$hR5$	Bi_2Te_3	C_{33}	$R\bar{3}m$
	Ni_3S_2	$D5_e$	$R32$
$hR6$	CaSi_2	C_{12}	$R\bar{3}m$

	NiS	B13	$R\bar{3}m$
<i>hR7</i>	Al ₄ C ₃	<i>D7</i> ₁	$R\bar{3}m$
	Mo ₂ B ₅	<i>D8</i> _{<i>i</i>}	$R\bar{3}m$
<i>hR10</i>	α -Al ₂ O ₃	<i>D5</i> ₁	$R\bar{3}c$
<i>hR13</i>	Fe ₇ W ₆	<i>D8</i> ₅	$R\bar{3}m$
<i>hR15</i>	B ₄ C	<i>D1</i> _{<i>g</i>}	$R\bar{3}m$
<i>hR26</i>	Cr ₅ Al ₈	<i>D8</i> ₁₀	$R\bar{3}m$
<i>hR32</i>	CuPt	<i>L1</i> ₁	$R\bar{3}m$
<i>mC6</i>	AuTe ₂ (calaverite)	<i>C34</i>	<i>C2/m</i>
<i>mC8</i>	CuO	<i>B26</i>	<i>C2/c</i>
<i>mC12</i>	ThC ₂	<i>C</i> _{<i>g</i>}	<i>C2/c</i>
<i>mC14</i>	δ -Ni ₃ Sn ₄	<i>D7</i> _{<i>a</i>}	<i>C2/m</i>
<i>mC16</i>	FeKS ₂	<i>F5</i> _{<i>a</i>}	<i>C2/c</i>
<i>mP12</i>	AgAuTe ₄	<i>E1</i> _{<i>b</i>}	<i>P2/c</i>
	ZrO ₂	<i>C43</i>	<i>P2</i> _{1/c}
<i>mP20</i>	As ₂ S ₃	<i>D5</i> _{<i>f</i>}	<i>P2</i> _{1/c}
<i>mP22</i>	Co ₂ Al ₉	<i>D8</i> _{<i>d</i>}	<i>P2</i> _{1/c}
<i>mP24</i>	FeAsS	<i>E0</i> ₇	<i>P2</i> _{1/c}
<i>mP32</i>	AsS	<i>B</i> ₁	<i>P2</i> _{1/c}

	β Se	A_l	$P2_1/c$
<i>mP64</i>	α Se	A_k	$P2_1/c$
<i>oC4</i>	α U	A20	<i>Cmcm</i>
<i>oC8</i>	CaSi	B_c	<i>Cmmc</i>
	α Ga	A11	<i>Cmca</i>
	CrB	B_f	<i>Cmcm</i>
	I ₂	A14	<i>Cmca</i>
	P(black)	A17	<i>Cmca</i>
<i>oC12</i>	ZrSi ₂	C49	<i>Cmcm</i>
<i>oC16</i>	BRe ₃	$E1_a$	<i>Cmcm</i>
<i>oC20</i>	PdSn ₄	$D1_c$	<i>Aba2</i>
<i>oC24</i>	PdSn ₂	C_e	<i>Aba2</i>
<i>oC28</i>	Al ₆ Mn	$D2_h$	<i>Cmcm</i>
<i>oF24</i>	TiSi ₂	C54	<i>Fddd</i>
<i>oF40</i>	Mn ₄ B	$D1_f$	<i>Fddd</i>
<i>oF48</i>	CuMg ₂	C_b	<i>Fddd</i>
<i>oF72</i>	GeS ₂	C44	<i>Fdd2</i>
<i>oF128</i>	α S	A16	<i>Fddd</i>
<i>oI12</i>	SiS ₂	C42	<i>Ibam</i>
<i>oI14</i>	Ta ₃ B ₄	$D7_b$	<i>Immm</i>

<i>oI20</i>	Al ₄ U	<i>D1_b</i>	<i>Imma</i>
<i>oI28</i>	Ga ₂ Mg ₅	<i>D8_g</i>	<i>Ibam</i>
<i>oP4</i>	AuCd	<i>B19</i>	<i>Pmma</i>
<i>oP6</i>	FeS ₂ (marcasite)	<i>C18</i>	<i>Pnmm</i>
	CaCl ₂	<i>C35</i>	<i>Pnmm</i>
<i>oP8</i>	α Np	<i>A_c</i>	<i>Pnma</i>
	η NiSi	<i>B_d</i>	<i>Pbnm</i>
	β Cu ₃ Ti	<i>D0_a</i>	<i>Pmmn</i>
	FeB	<i>B27</i>	<i>Pnma</i>
	GeS	<i>B16</i>	<i>Pnma</i>
	SnS	<i>B29</i>	<i>Pmcn</i>
	MnP	<i>B31</i>	<i>Pnma</i>
	TiB	<i>B_m</i>	<i>Pnma</i>
<i>oP12</i>	Co ₂ Si	<i>C23</i>	<i>Pnma</i>
	Co ₂ Si	<i>C37</i>	<i>Pbnm</i>
	HgCl ₂	<i>C28</i>	<i>Pmnb</i>
<i>oP16</i>	Al ₃ Ni	<i>D0₂₀</i>	<i>Pnma</i>
	AsMn ₃	<i>D0_d</i>	<i>Pmmn</i>
	BaS ₃	<i>D0₁₇</i>	<i>P42_{1m}</i>
	CdSb	<i>B_e</i>	<i>Pbca</i>

	CuS ₂ Sb	<i>F</i> 5 ₆	<i>Pnma</i>
	Fe ₃ C	<i>D</i> 0 ₁₁	<i>Pnma</i>
<i>oP</i> 20	Cr ₃ C ₂	<i>D</i> 5 ₁₀	<i>Pnma</i>
	Sb ₂ S ₃	<i>D</i> 5 ₈	<i>Pnma</i>
<i>oP</i> 24	AuTe ₂ (krennerite)	<i>C</i> 46	<i>Pma</i> 2
	CuFe ₂ S ₃	<i>E</i> 9 _{<i>e</i>}	<i>Pnma</i>
	TiO ₂ (brookite)	<i>C</i> 21	<i>Pbca</i>
<i>oP</i> 20	Sb ₂ O ₃ (valentinite)	<i>D</i> 5 ₁₁	<i>Pccn</i>
<i>oP</i> 40	Cr ₇ C ₃	<i>D</i> 10 ₁	<i>Pnma</i>
<i>iI</i> 2	αPa	<i>A</i> _{<i>a</i>}	<i>I</i> 4/ <i>mmm</i>
	In	<i>A</i> 6	<i>I</i> 4/ <i>mmm</i>
<i>iI</i> 4	βSn	<i>A</i> 5	<i>I</i> 4 ₁ / <i>amd</i>
<i>iI</i> 6	CaC ₂	<i>C</i> 11 _{<i>a</i>}	<i>I</i> 4/ <i>mmm</i>
	FeCu ₂ SnS ₄	<i>H</i> 26	<i>I</i> 4 ₂ <i>m</i>
	MoSi ₂	<i>C</i> 11 _{<i>b</i>}	<i>I</i> 4/ <i>mmm</i>
	ThH ₂	<i>L</i> '2 _{<i>b</i>}	<i>I</i> 4/ <i>mmm</i>
<i>iI</i> 8	Al ₃ Ti	<i>D</i> 0 ₂₂	<i>I</i> 4/ <i>mmm</i>
<i>iI</i> 10	Al ₄ Ba	<i>D</i> 1 ₃	<i>I</i> 4/ <i>mmm</i>
	MoNi ₄	<i>D</i> 1 _{<i>a</i>}	<i>I</i> 4/ <i>m</i>
<i>iI</i> 12	Al ₂ CU	<i>C</i> 16	<i>I</i> 4/ <i>mcm</i>

	ThSi ₂	C_c	$I4_1/amd$
<i>tI14</i>	Al ₂ CdS ₄	$E3$	$I\bar{4}$
<i>tI16</i>	Al ₃ Zr	$D0_{23}$	$I4/mmm$
	CuFeS ₂	$E1_1$	$I\bar{4}2d$
	Ir ₃ Si	$D0'_c$	$I4/mcm$
	MoB	B_g	$I4_1/amd$
	SiU ₃	$D0_c$	$I4/mcm$
	TlSe	$B37$	$I4/mcm$
<i>tI18</i>	FegN	$D2_g$	$I4/mmm$
<i>tI26</i>	Mn ₁₂ Th	$D2_b$	$I4/mmm$
<i>tI28</i>	MnU ₆	$D2_c$	$I4/mcm$
<i>tI32</i>	Cr ₅ B ₃	$D8_l$	$I4/mcm$
	Ni ₃ P	$D0_e$	$I\bar{4}$
	W ₅ Si ₃	$D8_m$	$I4/mcm$
<i>tP2</i>	AuCu	$L1_o$	$P4/mmm$
	δ CuTi	$L2_a$	$P4/mmm$
<i>tP4</i>	β _{Np}	A_d	$P42_12$
	CuTi ₃	$L6_o$	$P4/mmm$
	γ CuTi	$B11$	$P4/nmm$
	PbO	$B10$	$P4/nmm$

	PtS	B17	$P4_2/mmc$
<i>tP6</i>	Cu ₂ Sb	C38	$P4/nmm$
	PbFCl	$E0_1$	$P4/nmm$
	TiO ₂ (rutile)	C4	$P4_2/mnm$
<i>tP10</i>	Pb ₄ Pt	$D1_d$	$P4/nbm$
	Si ₂ U ₃	$D5_a$	$P4/mbm$
<i>tP16</i>	PdS	B34	$P4_2/m$
<i>tP20</i>	B ₄ Th	$D1_e$	$P4/mbm$
<i>tP30</i>	β_U	A_b	$P4_2/mnm$
	σ_{CrFe}	$D8_b$	$P4_2/mnm$
<i>tP40</i>	Al ₇ Cu ₂ Fe	$E9_a$	$P4/mnc$
	Zn ₃ P ₂	$D5_9$	$P4_2/nmc$
<i>tP50</i>	γ_B	A_g	$P4_2/nmm$

Crystal Structure Nomenclature: Arranged Alphabetically by Strukturbericht Designation

Strukturbericht designation	Prototype	Pearson symbol	Space group
A_a	α_{Pa}	<i>tI2</i>	$I4/mmm$
A_b	β_U	<i>tP30</i>	$P4_2/mnm$
A_c	α_{Np}	<i>oP8</i>	$Pnma$
A_d	β_{Np}	<i>tP4</i>	$P4_2_12$
A_f	HgSn ₆₋₁₀	<i>hP1</i>	$P6/mmm$

A _g	γ_{B}	<i>tP50</i>	<i>P4₂/nnm</i>
A _h	α_{Po}	<i>cP1</i>	<i>Pm$\bar{3}m$</i>
A _i	β_{Po}	<i>hR1</i>	<i>R$\bar{3}m$</i>
A _k	α_{Se}	<i>mP64</i>	<i>P2₁/c</i>
A _l	β_{Se}	<i>mP32</i>	<i>P2₁/c</i>
A ₁	CU	<i>cF4</i>	<i>Fm$\bar{3}m$</i>
A ₂	W	<i>cI2</i>	<i>Im$\bar{3}m$</i>
A ₃	Mg	<i>hP2</i>	<i>P6₃/mmc</i>
A _{3'}	α_{La}	<i>hP4</i>	<i>P6₃/mmc</i>
A ₄	C(diamond)	<i>cF8</i>	<i>Fd$\bar{3}m$</i>
A ₅	β_{Sn}	<i>tI4</i>	<i>I4₁/amd</i>
A ₆	In	<i>tI2</i>	<i>I4/mmm</i>
A ₇	α_{As}	<i>hR2</i>	<i>R$\bar{3}m$</i>
A ₈	γ_{Se}	<i>hP3</i>	<i>P3₁21</i>
A ₉	C(graphite)	<i>hP4</i>	<i>P6₃/mmc</i>
A ₁₀	α_{Hg}	<i>hR1</i>	<i>R$\bar{3}m$</i>
A ₁₁	α_{Ga}	<i>oC8</i>	<i>Cmca</i>
A ₁₂	α_{Mn}	<i>cI58</i>	<i>I$\bar{4}3m$</i>
A ₁₃	β_{Mn}	<i>cP20</i>	<i>P4₁32</i>

A14	I ₂	oC8	<i>Cmca</i>
A15	Cr ₃ Si	cP8	<i>Pm</i> $\bar{3}n$
A16	α S	oF128	<i>Fddd</i>
A17	P(black)	oC8	<i>Cmca</i>
A20	α U	oC4	<i>Cmcm</i>
B _a	CoU	cI16	<i>I2₁₃</i>
B _b	ζ AgZn	hP9	<i>P3</i>
B _c	CaSi	oC8	<i>Cmmc</i>
B _d	η NiSi	oP8	<i>Pbnm</i>
B _e	CdSb	oP16	<i>Pbca</i>
B _f	CrB	oC8	<i>Cmcm</i>
B _g	MoB	tI16	<i>I4_{1/amd}</i>
B _h	WC	hP2	<i>P</i> $\bar{6}m2$
B _i	TiAs	hP8	<i>P6_{3/mmc}</i>
B _k	BN	hP4	<i>P6_{3/mmc}</i>
B _l	AsS	mP32	<i>P2_{1/c}</i>
B _m	TiB	oP8	<i>Pnma</i>
B1	NaCl	cF8	<i>Fm</i> $\bar{3}m$
B2	CsCl	cP2	<i>Pm</i> $\bar{3}m$
B3	ZnS(sphalerite)	cF8	<i>F</i> $\bar{4}3m$

B4	ZnS(wurtzite)	<i>hP4</i>	<i>P6₃mc</i>
B8 ₁	NiAs	<i>hP4</i>	<i>P6₃/mmc</i>
B8 ₂	Ni ₂ In	<i>hP6</i>	<i>P6₃/mmc</i>
B9	HgS	<i>hP6</i>	<i>P3₁21</i>
B10	PbO	<i>tP4</i>	<i>P4/nmm</i>
B11	γ CuTi	<i>tP4</i>	<i>P4/nmm</i>
B13	NiS	<i>hR6</i>	<i>R$\bar{3}$m</i>
B16	GeS	<i>oP8</i>	<i>Pnma</i>
B17	PtS	<i>tP4</i>	<i>P4₂/mmc</i>
B18	CuS	<i>hP12</i>	<i>P6₃/mmc</i>
B19	AuCd	<i>oP4</i>	<i>Pmma</i>
B20	FeSi	<i>cP8</i>	<i>P2₁3</i>
B26	CuO	<i>mC8</i>	<i>C2/c</i>
B27	FeB	<i>oP8</i>	<i>Pnma</i>
B29	SnS	<i>oP8</i>	<i>Pmcn</i>
B31	MnP	<i>oP8</i>	<i>Pnma</i>
B32	NaTl	<i>cF16</i>	<i>Fd$\bar{3}$m</i>
B34	PdS	<i>tP16</i>	<i>P4₂/m</i>
B35	CoSn	<i>hP6</i>	<i>P6/mmm</i>
B37	TlSe	<i>tI16</i>	<i>I4/mcm</i>

C_a	Mg_2Ni	$hP18$	$P6_222$
C_b	$CuMg_2$	$oF48$	$Fddd$
C_c	$ThSi_2$	$tI12$	$I4_1/amd$
C_e	$PdSn_2$	$oC24$	Aba_2
C_g	ThC_2	$mC12$	$C2/c$
C_h	Cu_2Te	$hP6$	$P6/mmm$
C_k	$LiZn_2$	$hP3$	$P6_3/mmc$
C_l	CaF_2	$cF12$	$Fm\bar{3}m$
C_{1b}	$MgAgAs$	$cF12$	$F\bar{4}3m$
C_2	$FeS_2(\text{pyrite})$	$cP12$	Pa_3
C_3	Ag_2O	$cP6$	$Pn\bar{3}m$
C_4	$TiO_2(\text{rutile})$	$tP6$	$P4_2/mmm$
C_6	CdI_2	$hP3$	$P\bar{3}m_1$
C_7	MoS_2	$hP6$	$P6_3/mmc$
C_8	$SiO_2(\text{high quartz})$	$hP9$	$P6_222$
C_9	$SiO_2(\beta \text{ cristobalite})$	$cF24$	$Fd\bar{3}m$
C_{10}	$SiO_2(\beta \text{ tridymite})$	$hP12$	$P6_3/mmc$
C_{11a}	CaC_2	$tI6$	$I4/mmm$
C_{11b}	$MoSi_2$	$tI6$	$I4/mmm$
C_{12}	$CaSi_2$	$hR6$	$R\bar{3}m$

C14	MgZn ₂	<i>hP12</i>	<i>P6₃/mmc</i>
C15	Cu ₂ Mg	<i>cF24</i>	<i>Fd$\bar{3}m$</i>
C15 _b	AuBe ₅	<i>cF24</i>	<i>F$\bar{4}3m$</i>
C16	Al ₂ Cu	<i>tI12</i>	<i>I4/mcm</i>
C18	FeS ₂ (marcasite)	<i>oP6</i>	<i>Pnnm</i>
C19	α Sm	<i>hR3</i>	<i>R$\bar{3}m$</i>
C21	TiO ₂ (brookite)	<i>oP24</i>	<i>Pbca</i>
C22	Fe ₂ P	<i>hP9</i>	<i>P$\bar{6}2m$</i>
C23	Co ₂ Si	<i>oP12</i>	<i>Pnma</i>
C28	HgCl ₂	<i>oP12</i>	<i>Pmnb</i>
C32	AlB ₂	<i>hP3</i>	<i>P6/mmm</i>
C33	Bi ₂ Te ₃	<i>hR5</i>	<i>R$\bar{3}m$</i>
C34	AuTe ₂ (calaverite)	<i>mC6</i>	<i>C2/m</i>
C35	CaCl ₂	<i>oP6</i>	<i>Pnnm</i>
C36	MgNi ₂	<i>hP24</i>	<i>P6₃/mmc</i>
C37	Co ₂ Si	<i>oP12</i>	<i>Pbnm</i>
C38	Cu ₂ Sb	<i>tP6</i>	<i>P4/nmm</i>
C40	CrSi ₂	<i>hP9</i>	<i>P6₂22</i>
C42	SiS ₂	<i>oI12</i>	<i>Ibam</i>
C43	ZrO ₂	<i>mP12</i>	<i>P2₁/c</i>

C44	GeS ₂	<i>oF72</i>	<i>Fdd2</i>
C46	AuTe ₂ (krennerite)	<i>oP24</i>	<i>Pma2</i>
C49	ZrSi ₂	<i>oC12</i>	<i>Cmcm</i>
C54	TiSi ₂	<i>oF24</i>	<i>Fddd</i>
D0 _a	β Cu ₃ Ti	<i>oP8</i>	<i>Pmmn</i>
D0 _c	SiU ₃	<i>tI16</i>	<i>I4/mcm</i>
D0' _c	Ir ₃ Si	<i>tI16</i>	<i>I4/mcm</i>
D0 _d	AsMn ₃	<i>oP16</i>	<i>Pmmn</i>
D0 _e	Ni ₃ P	<i>tI32</i>	$I\bar{4}$
D0 ₂	CoAs ₃	<i>cI32</i>	$Im\bar{3}$
D0 ₃	BiF ₃	<i>cF16</i>	$Fm\bar{3}m$
D0 ₉	ReO ₃	<i>cP4</i>	$Pm\bar{3}m$
D0 ₁₁	Fe ₃ C	<i>oP16</i>	<i>Pnma</i>
D0 ₁₇	BaS ₃	<i>oP16</i>	<i>P4₂1m</i>
D0 ₁₈	Na ₃ As	<i>hP8</i>	<i>P6₃/mmc</i>
D0 ₁₉	Ni ₃ Sn	<i>hP8</i>	<i>P6₃/mmc</i>
D0 ₂₀	Al ₃ Ni	<i>oP16</i>	<i>Pnma</i>
D0 ₂₁	Cu ₃ P	<i>hP24</i>	<i>P6₃cm</i>
D0 ₂₂	Al ₃ Ti	<i>tI8</i>	<i>I4/mmm</i>
D0 ₂₃	Al ₃ Zr	<i>tI16</i>	<i>I4/mmm</i>

$D0_{24}$	Ni_3Ti	$hP16$	$P6_3/mmc$
$D1_a$	$MoNi_4$	$tI10$	$I4/m$
$D1_b$	Al_4U	$oI20$	$Imma$
$D1_c$	$PdSn_4$	$oC20$	$Aba2$
$D1_d$	Pb_4Pt	$tP10$	$P4/nbm$
$D1_e$	B_4Th	$tP20$	$P4/mbm$
$D1_f$	Mn_4B	$oF40$	$Fddd$
$D1_g$	B_4C	$hR15$	$R\bar{3}m$
$D1_3$	Al_4Ba	$tI10$	$I4/mmm$
$D2_b$	$Mn_{12}Th$	$tI26$	$I4/mmm$
$D2_c$	MnU_6	$tI28$	$I4/mcm$
$D2_d$	$CaCU_5$	$hP6$	$P6/mmm$
$D2_e$	$BaHg_{11}$	$cP36$	$Pm\bar{3}m$
$D2_f$	UB_{12}	$cF52$	$Fm\bar{3}m$
$D2_g$	Fe_8N	$tI18$	$I4/mmm$
$D2_h$	Al_6Mn	$oC28$	$Cmcm$
$D2_1$	CaB_6	$cP7$	$Pm\bar{3}m$
$D2_3$	$NaZn_{13}$	$cF112$	$Fm\bar{3}c$
$D5_a$	Si_2U_3	$tP10$	$P4/mbm$
$D5_b$	Pt_2Sn_3	$hP10$	$P6_3/mmc$

$D5_c$	Pu_2C_3	$cI40$	$I\bar{4}3d$
$D5_e$	Ni_3S_2	$hR5$	$R32$
$D5_f$	As_2S_3	$mP20$	$P2_1/c$
$D5_1$	$\alpha\text{Al}_2\text{O}_3$	$hR10$	$R\bar{3}c$
$D5_2$	La_2O_3	$hP5$	$P\bar{3}m1$
$D5_3$	Mn_2O_3	$cI80$	$Ia\bar{3}$
$D5_4$	$\text{Sb}_2\text{O}_3(\text{senarmonite})$	$cF80$	$Fd\bar{3}m$
$D5_8$	Sb_2S_3	$oP20$	$Pnma$
$D5_9$	Zn_3P_2	$tP40$	$P4_2/nmc$
$D5_{10}$	Cr_3C_2	$oP20$	$Pnma$
$D5_{11}$	$\text{Sb}_2\text{O}_3(\text{valentinite})$	$oP20$	$Pccn$
$D5_{11}$	Ni_2Al_3	$hP5$	$P\bar{3}m1$
$D7_a$	$\delta\text{Ni}_3\text{Sn}_4$	$mC14$	$C2/m$
$D7_b$	Ta_3B_4	$oI14$	$Immm$
$D7_1$	Al_4C_3	$hR7$	$R\bar{3}m$
$D7_2$	Co_3S_4	$cF56$	$Fd\bar{3}m$
$D7_3$	Th_3P_4	$cI28$	$I4\bar{3}d$
$D8_a$	Mn_2Th_6	$cF116$	$Fm\bar{3}m$
$D8_b$	σCrFe	$tP30$	$P4_2/mnm$

$D8_c$	Mg_2Zn_{11}	$cP39$	$Pm\bar{3}$
$D8_d$	Co_2Al_9	$mP22$	$P2_1/c$
$D8_e$	$Mg_{32}(Al,Zn)_{49}$	$cI162$	$Im\bar{3}$
$D8_f$	Ge_7Ir_3	$cI40$	$Im\bar{3}m$
$D8_g$	Ga_2Mg_5	$oI28$	$Ibam$
$D8_h$	W_2B_5	$hP14$	$P6_3/mmc$
$D8_i$	Mo_2B_5	$hR7$	$R\bar{3}m$
$D8_k$	Th_7S_{12}	$hP20$	$P6_3/m$
$D8_l$	Cr_3B_3	$tI32$	$I4/mcm$
$D8_m$	W_5Si_3	$tI32$	$I4/mcm$
$D8_n$	Fe_3Zn_{10}	$cI52$	$Im\bar{3}m$
$D8_2$	Cu_5Zn_8	$cI52$	$I\bar{4}3m$
$D8_3$	Cu_9Al_4	$cP52$	$P\bar{4}3m$
$D8_4$	$Cr_{23}C_6$	$cF116$	$Fm\bar{3}m$
$D8_5$	Fe_7W_6	$hR13$	$R\bar{3}m$
$D8_6$	$Cu_{15}Si_4$	$cI76$	$I\bar{4}3d$
$D8_8$	Mn_5Si_3	$hP16$	$P6_3/mcm$
$D8_9$	Co_9S_8	$cF68$	$Fm\bar{3}m$
$D8_{10}$	Cr_5Al_8	$hR26$	$R\bar{3}m$

$D8_{11}$	Co_2Al_5	$hP28$	$P6_3/mmc$
$D10_1$	Cr_7C_3	$oP40$	$Pnma$
$D10_2$	Fe_3Th_7	$hP20$	$P6_3mc$
$D8_{11}$	Co_2Al_5	$hP28$	$P6_3/mmc$
$E0_1$	PbFCl	$tP6$	$P4/nmm$
$E0_7$	FeAsS	$mP24$	$P2_1/c$
$E1_a$	MgCuAl_2	$oC16$	$Cmcm$
$E1_b$	AgAuTe_4	$mP12$	$P2/c$
$E1_1$	CuFeS_2	$tI16$	$I\bar{4}_2d$
$E2_1$	CaTiO_3	$cP5$	$Pm\bar{3}m$
$E3$	Al_2CdS_4	$tI14$	$I\bar{4}$
$E9_a$	$\text{Al}_7\text{Cu}_2\text{Fe}$	$tP40$	$P4/mnc$
$E9_b$	$\text{Al}_8\text{FeMg}_3\text{Si}_6$	$hP18$	$P\bar{6}_2m$
$E9_d$	AlLi_3N_2	$cI96$	$Ia\bar{3}$
$E9_e$	CuFe_2S_3	$oP24$	$Pnma$
$E9_c$	$\text{Mn}_3\text{Al}_9\text{Si}$	$hP26$	$P6_3/mmc$
$E9_3$	$\text{Fe}_3\text{W}_3\text{C}$	$cF112$	$Fd\bar{3}m$
$E9_4$	$\text{Al}_4\text{C}_4\text{Si}$	$hP18$	$P6_3mc$
$F5_a$	FeKS_2	$mC16$	$C2/c$
$F0_1$	NiSbS	$cP12$	$P2_13$

$F5_1$	NaCrS_2	$hR4$	$R\bar{3}m$
$F5_6$	CuS_2Sb	$oP16$	$Pnma$
$H1_1$	Al_2MgO_4	$cF56$	$Fd\bar{3}m$
$H2_4$	Cu_3VS_4	$cP8$	$P\bar{4}3m$
$H2_6$	$\text{FeCu}_2\text{SnS}_4$	$tI16$	$I\bar{4}2m$
$L1$	Fe_4N	$cF5$	$Fm\bar{3}m$
$L1_2$	AlFe_3C	$cP5$	$Pm\bar{3}m$
$L2$	ThH_2	$tI6$	$I4/mmm$
$L3$	Fe_2N	$hP3$	$P6_3/mmc$
$L1_a$	CuPt_3	$cF32$	$Fm\bar{3}c$
$L1_0$	AuCu	$tP2$	$P4/mmm$
$L1_1$	CuPt	$hR32$	$R\bar{3}m$
$L1_2$	AuCu_3	$cP4$	$Pm\bar{3}m$
$L2_a$	δCuTi	$tP2$	$P4/mmm$
$L2_1$	AlCu_2Mn	$cF16$	$Fm\bar{3}m$
$L2_2$	Sb_2Tl_7	$cI54$	$Im\bar{3}m$
$L6_0$	CuTi_3	$tP4$	$P4/mmm$

Abbreviations

Abbreviations

antiphase structure	APS
---------------------	-----

atomic percent	at.%
body-centered cubic	bcc
body-centered tetragonal	bct
boiling point	B.P.
Celsius	°C
close-packed hexagonal	cph
components	<i>c</i>
composition	<i>X</i>
Curie temperature	T_C
degree (Angular)	°
degrees of freedom	<i>f</i>
differential	d
edge length	<i>a, b, c</i>
enthalpy	<i>H</i>
entropy	<i>S</i>
face-centered cubic	fcc
Fahrenheit	°F
gas	G
Gibbs energy	<i>G</i>
gigapascal	GPa
greater than	>

heat capacity	C
heat energy	Q
high temperature	HT
increment (finite)	δ
increment (infinitesimally small)	Δ
interaxial angle	A, B, Γ
internal energy	E
Kelvin	K
kilobar	kbar
kilopascal	kPa
less than	<
liquid	L
low temperature	LT
megapascal	MPa
melting point	M.P.
metallic element	M
nanometer	nm
percent	%
pressure	P
room temperature	RT
solid	S

stable phases	p
sublimation point	S.P.
temperature	T
transformation temperature	A
triple point	T.P.
unknown	...
volume	V
weight percent	wt. %
work energy	W

Greek Alphabet

Greek Alphabet

Greek letter	Name	English equivalent
A, α	Alpha	A, a
B, β	Beta	B, b
Γ , γ	Gamma	G, g
Δ , δ	Delta	D, d
E, ϵ	Epsilon	E, e
Z, ζ	Zeta	Z, z
H, η	Eta	E, e
Θ , θ	Theta	Th

I, ι	Iota	I, i
K, κ	Kappa	K, k
Λ, λ	Lambda	L, l
M, μ	Mu	M, m
N, ν	Nu	N, n
Ξ, ξ	Xi	X, x
O, \omicron	Omicron	O, o
Π, π	Pi	P, p
P, ρ	Rho	R, r
Σ, σ	Sigma	S, s
T, τ	Tau	T, t
Υ, υ	Upsilon	U, u
Φ, ϕ	Phi	Ph
X, χ	Chi	Ch
Ψ, ψ	Psi	Ps
Ω, ω	Omega	O, o